



POWER QUALITY. SOLVED.

A STEEL PARTNERS COMPANY

dV E-Series

208V – 600V

TECHNICAL REFERENCE MANUAL

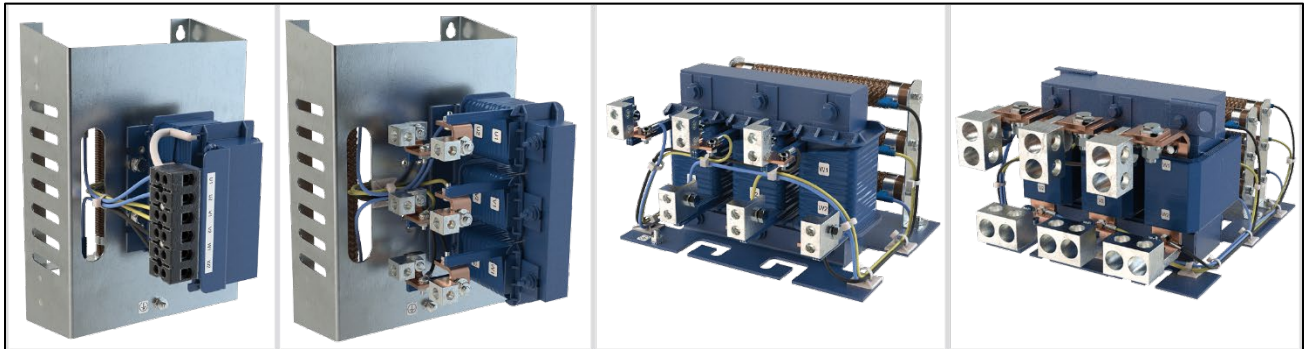

High Voltage! Only a qualified electrician can carry out the electrical installation of this filter.

Quick Reference

1	Performance Data	Pages 9 – 12
2	Selection Guide	Pages 13 – 18
3	Installation Guide	Pages 19 – 24
4	Start-up/Troubleshooting	Pages 25 – 27

This page intentionally left blank

TABLE OF CONTENTS

1. SAFETY	5
WARNINGS AND CAUTIONS	5
PRODUCT SAFETY LABELING	5
GENERAL SAFETY INSTRUCTIONS	6
2. GENERAL INFORMATION	7
RECEIPT & REPAIR STATEMENT.....	7
ENCLOSURES	8
AGENCY APPROVALS	8
WARRANTY	8
3. DV E-SERIES PERFORMANCE DATA	9
PERFORMANCE SPECIFICATIONS	9
FILTER EFFICIENCY + WATT LOSS.....	10
PERFORMANCE CHART	11
ALTITUDE DERATING	12
MOTOR FREQUENCY DERATING.....	12
4. HOW TO SELECT	13
SELECTION GUIDE	13
UNDERSTANDING THE DV E-SERIES PART NUMBER:	14
PART NUMBER SELECTION TABLES.....	15
PART NUMBER SELECTION TABLES.....	16
5. HOW TO INSTALL	19
INSTALLATION CHECKLIST	19
GROUNDING	20
POWER WIRING CONNECTION	20
BASIC SCHEMATIC DIAGRAM	21
INTERCONNECTION DIAGRAM – KIT	22
INTERCONNECTION DIAGRAM – OPEN PANEL AND ENCLOSED.....	23
TORQUE RATINGS.....	24
6. START-UP	25
SAFETY PRECAUTIONS	25
7. TROUBLESHOOTING	26

List of Figures

Figure 3-1: Typical Performance Chart	11
Figure 3-2: Altitude Derating Curve	12
Figure 3-3: Current Derating for Drive Output Frequency	12
Figure 5-1: Basic Schematic Diagram	21
Figure 5-2: Kit Diagram	22
Figure 5-3: Open Panel and Enclosed Diagram	23



List of Tables

Table 3-1: Performance Specifications	9
Table 3-2: Filter Efficiency & Watt Loss	10
Table 4-1: Kit Selection Table	15
Table 4-2: Open Panel Selection Table	16
Table 4-3: Enclosed NEMA 1/2 Selection Table	17
Table 4-4: Enclosed NEMA 3R Selection Table	18
Table 5-1: Torque Ratings	24
Table 7-1: Troubleshooting Guide	27

1. SAFETY



Warnings and Cautions

The following symbols are used in this manual:



 WARNING	<p>High Voltage Warning: warns of situations that dangerously high voltage is involved. Failure to use proper precautions may lead to serious injury or death.</p>
 WARNING	<p>General Warning: warns of situations that can result in serious injury or death if proper precautions are not used.</p>
 Caution	<p>General Caution: identifies situations that could lead to malfunction or possible equipment damage.</p>

Product Safety Labeling

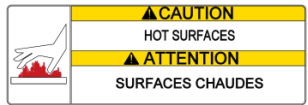
The following labels are placed on the dV E-Series product:

	<p>Label notes to install to refer to instruction manual first before installing.</p>
	<p>High Voltage: surfaces on product can have high voltage which can cause injury.</p>
	<p>Hot Surfaces: surfaces of product can be hot at times and cause burns.</p>

General Safety Instructions

 WARNING	<p>High Voltage! Only a qualified electrician can carry out the electrical installation of this filter.</p>
	<p>High voltage is used in the operation of this filter. Use Extreme caution to avoid contact with high voltage when operating, installing or repairing this filter. Injury or death may result if safety precautions are not observed.</p>
 WARNING	<p>The opening of the branch circuit protective device may be an indication that a fault current has been interrupted. To reduce the risk of fire or electrical shock, current-carrying parts and other components of the filter should be examined and replaced if damaged.</p>
	<p>An upstream disconnect/protection device must be used as required by the National Electrical Code (NEC) or governing authority.</p>
	<p>Even if the upstream disconnect/protection device is open, the drive down stream of the filter may feedback high voltage to the filter. The drive safety instructions must be followed. Injury or death may result if safety precautions are not observed.</p>
	<p>The filter must be grounded with a grounding conductor connected to all grounding terminals. Modular filters must have reactor grounded through a 2"x2" area cleaned of paint and varnish on lower mounting bracket.</p>
	<p>Only spare parts obtained from MTE Corporation, or an authorized MTE distributor can be used.</p>
 Caution	<p>Loose or improperly secured connections may damage or degrade filter performance. Visually inspect and secure all electrical connections before power is applied to the filter.</p>
	<p>Wiring should not be routed underneath panel in resistor housing. Doing so could result in fire or damage to the product.</p>
	<p>Product should not be mounted on wood or any other combustible surface. Doing so could lead to fire or damage to the product.</p>

2. GENERAL INFORMATION

The purpose of the manual is to properly specify size, install, interconnect, and operate the dV E-Series motor protection filter.

For most current information, please refer to website

<https://www.mtecorp.com/products/dv-e-series/>

This manual is intended for use by personnel experienced in the operation and maintenance of inverters. Because of the high voltages required by the filter, inverter, and the potential dangers presented by rotating machinery, it is essential that all personnel involved in the operation and maintenance of this filter know and practice the necessary safety precautions for this type of equipment. Personnel should read and understand the instructions contained in this manual before installing, operating, or servicing the filter and inverter to which it is connected.

Receipt & Repair Statement

Upon Receipt of this Filter:

The dV E-Series motor protection filter has been subjected to demanding factory tests before shipment. Carefully inspect the shipping container for damage that may have occurred in transit. Then unpack the filter and carefully inspect for any signs of damage. Save the shipping container for future transport of the filter.

In the event of damage, please contact and file a claim with the freight carrier involved immediately.

If the equipment is not going to be put into service upon receipt, cover and store the filter in a clean, dry location. After storage, ensure that the equipment is dry and that no condensation or dirt has accumulated on the internal components of the filter before applying power.

Repair/Exchange Procedure:

MTE Corporation requires a Return Material Authorization Number and form before we can accept any filters that qualify for return or repair. If problems or questions arise during installation, setup, or operation of the filter, please contact MTE for assistance at:

Toll Free: 1-800-455-4MTE (1-800-455-4683)

International Tel: (+1) 262-253-8200

Fax: 262-253-8222

Enclosures

MTE enclosures are designed to provide a degree of protection for electrical components and prevent incidental personnel contact with the enclosed equipment. Depending on the enclosure selected, these enclosures meet the requirements of NEMA 1/2 or 3R.

An approximate cross reference guide between NEMA, UL, CSA and IEC enclosure follows:

Type 1 NEMA / IEC IP20 Enclosure:

Are designed for indoor use and will provide protection against contact with the enclosed equipment.

Type 2 NEMA / IEC IP20 Enclosure:

Are designed for indoor use and will provide protection against contact with the enclosed equipment and provide a degree of protection against limited amounts of falling water and dirt.

Type 3R NEMA / IEC IP23 Enclosure:

Are designed for outdoor use primarily to provide protection against contact with the enclosed equipment and provide a degree of protection against falling rain sleet and external ice formation.

Agency Approvals

UL and cUL listed to UL508 Type MX and CSA-C22.2 No 14-95
File E180243

CE Marked

Warranty

Three years from the date of shipment. See <http://www.mtecorp.com/industry-leading-warranty/> for details.

3. dV E-SERIES PERFORMANCE DATA

Performance Specifications

Table 3-1: Performance Specifications

Service Load Condition	Inverter Duty Three Phase Motors
Voltage	208 – 600 VAC +/- 10%, 60Hz
Input Voltage Wave Form	Pulse Width Modulation (PWM)
Inverter Switching Frequency	2kHz – 4kHz (3A – 750A)
Inverter Operating Frequency	0 – 60 Hz without derating
Maximum Ambient Temperature	-40C to +60C Modular Filter
	-40C to +50C Enclosed Filter
	-40C to +90C Storage
Insulation System	Class N (200° C)
Insertion Loss (Voltage)	1.7% at 60 Hz
Efficiency	>99%
Current range	3A – 750A
Available form factors	Kit, Open Panel, NEMA 1/2, NEMA 3R
Altitude without derating	6,600 feet above sea level
Maximum Motor Lead Length	1,000 feet (VFD rated cable recommended)
Relative Humidity	0% to 99% non-condensing
Current Rating	100% RMS Continuous
	150% for 1 minute
	200% for 10 sec
	*Operating in overload will result in increased proportional voltage drop
Audible Noise	<65db at 1 meter
Rise Time	Greater than 0.1 uS
Peak Voltage @ Motor	150% of DC bus voltage up to 1,000 feet

Filter Efficiency + Watt loss

Table 3-2: Filter Efficiency & Watt Loss

Maximum Output Amps RMS/Filter Current Rating Amps RMS	Efficiency (%)	Typical Power Dissipation (Watts*)
3	99.0%	51
4	99.0%	54
7	99.0%	64
9	99.0%	70
12	99.0%	86
17	99.0%	111
22	99.0%	97
27	99.0%	95
35	99.0%	91
45	99.0%	76
55	99.0%	102
65	99.0%	152
80	99.0%	122
110	99.0%	92
130	99.0%	113
160	99.0%	148
200	99.0%	175
250	99.0%	207
305	99.0%	205
365	99.0%	239
415	99.0%	330
515	99.0%	381
600	99.0%	350
750	99.0%	411

*Based on a typical 480V, 60Hz output frequency, 1,000 feet of drive cable, 2kHz carrier frequency at full load application.

Performance Chart

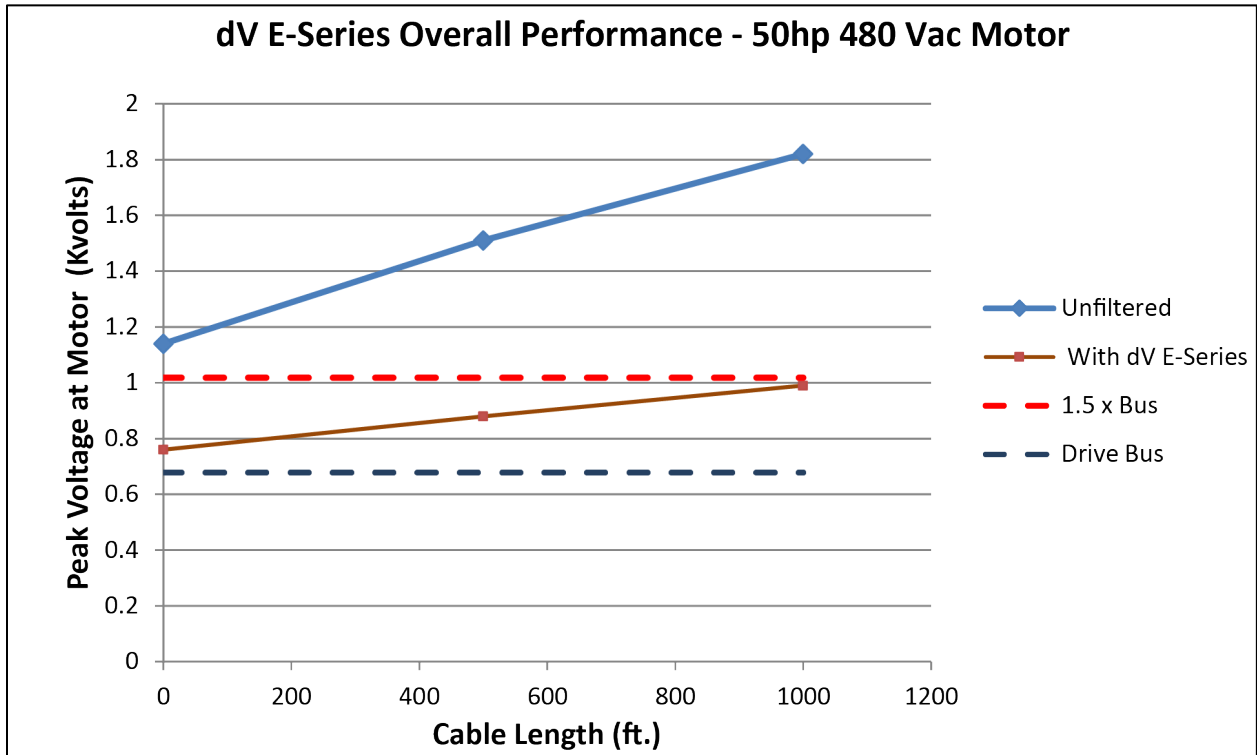

Figure 3-1: Typical Performance Chart

Altitude Derating

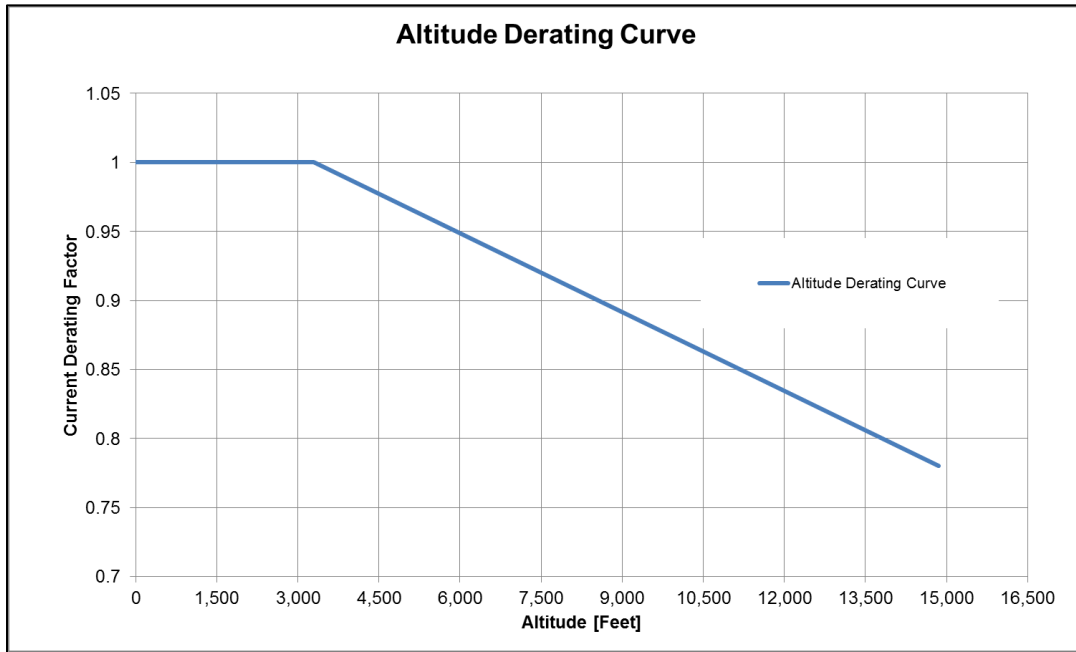

Figure 3-2: Altitude Derating Curve

Motor Frequency Derating

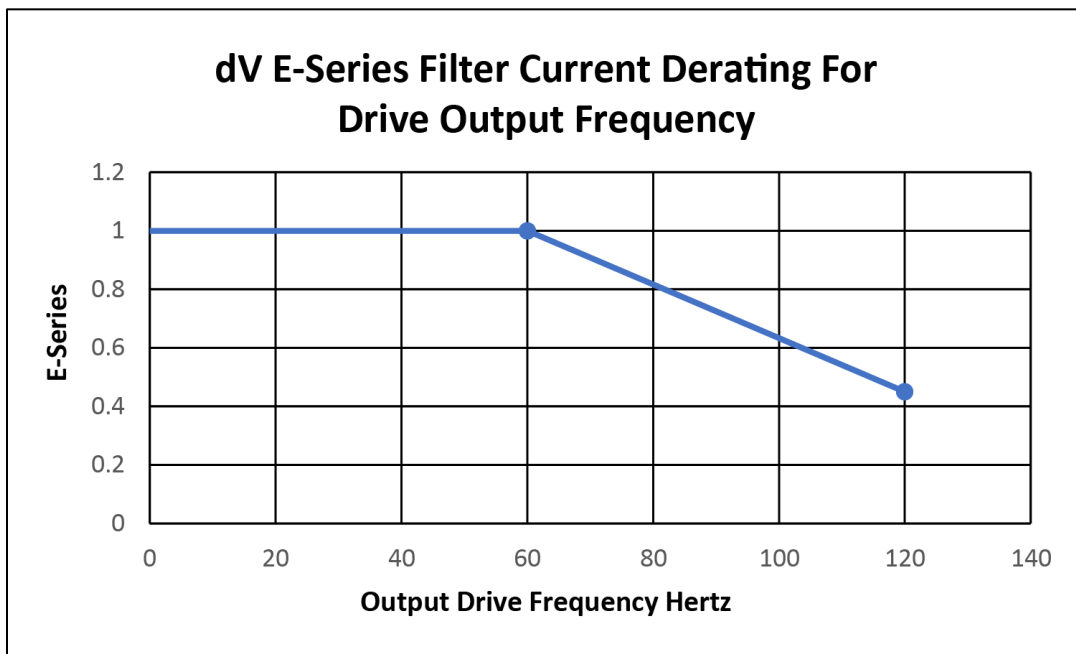

Figure 3-3: Current Derating for Drive Output Frequency

4. HOW TO SELECT

Selection Guide

The dV E-Series motor protection filter is intended for use on inverter duty motors. It will typically be used with lead lengths up to 1,000 feet. The dV E-Series motor protection filter eliminates reflective wave, provides peak voltage protection, and rise time reduction.

The suitability of this filter for a specific application must therefore be determined by the customer. In no event, will MTE Corporation assume responsibility or liability for any direct or consequential damages resulting from the use or application of this filter. Nor will MTE Corporation assume patent liability with respect to the use of information, circuits or equipment described in this instruction manual.

NOTE: For non-inverter duty motors, please refer to MTE's [SineWave Guardian](#) filter.

The dV E-Series motor protection filters are available in Kit, Open Panel, NEMA 1/2, and 3R mechanical configurations.

Please verify information below for proper selection:

- Lead Length:** This product is suitable for applications with motor leads up to 1,000 ft. Contact MTE Application Engineering for possible longer applications.
- Voltage:** Input voltage from 208V – 600V. See Table 3-1: Performance Specifications (p9) for specification.
- *Current Rating:** Support for 3 Amps – 750 Amps.
- Switching Frequency:** Support for carrier frequency of 2kHz – 4kHz. See Table 3-1: Performance Specifications (p9).
- Drive Output Frequency:** Support for 0Hz to 60Hz without derating. See
- Figure 3-3: Current Derating for Drive **Output Frequency** (p12) for derating curve.
- Temperature:** Maximum ambient temperature, 60C (open), 50C (enclosed). See Table 3-1: Performance Specifications (p9) for specification.
- Altitude:** 3,300 feet above sea level without derating. See Figure 3-2: Altitude Derating Curve (p12) for derating curve.
- Enclosure Type:** NEMA 1/2 & NEMA 3R – see Enclosures (p8) for enclosure descriptions.
- Motor Insulation Class:** Verify motor meets inverter duty standards per NEMA MG1 Section 31.

*** NOTE: dV E-Series filters can be paralleled for higher current ratings. Contact MTE Application Engineering for more information.**

Understanding the dV E-Series Part Number:

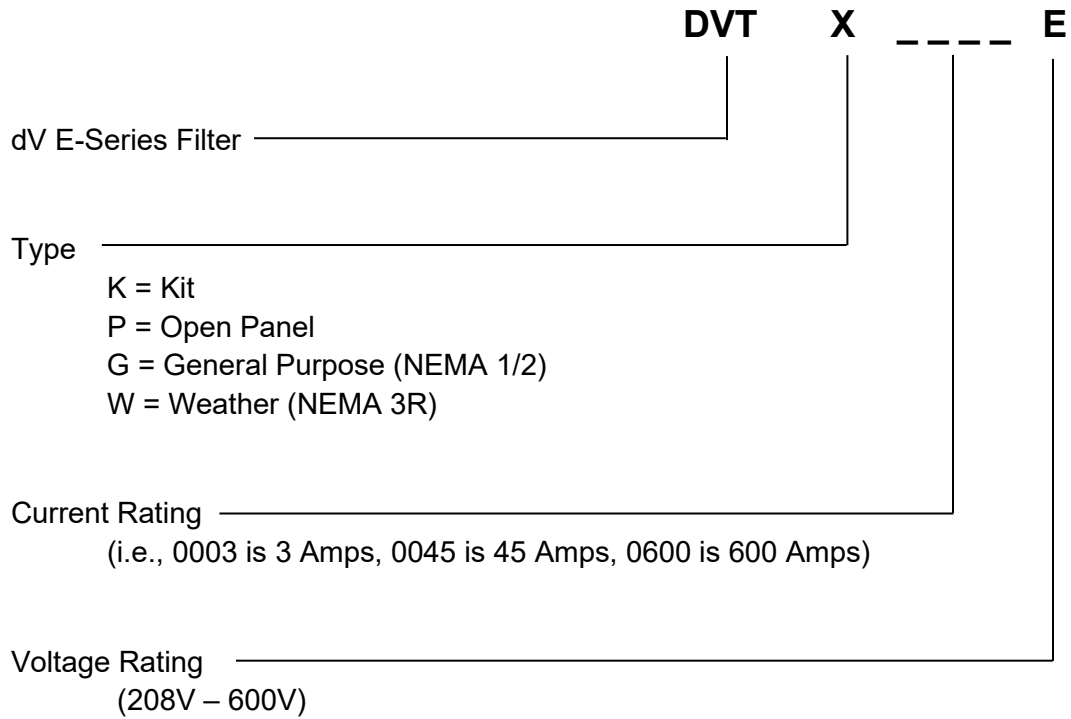

Part Number Selection Tables

Table 4-1: Kit Selection Table

208V Motor HP	240V Motor HP	380V Motor KW	480V Motor HP	550V-600V Motor HP	Filter Amp Rating	Part Number	App. Wt. (lbs.)	Reactor Dimensions (in.) (H x W x D)	Resistor Dimensions (in.) (H x W x D)
0.5	.75	0.5-1.1	0.5-1.5	0.5-2	3	DVTK0003E	3	3.7 x 4.5 x 1.5	5.0 x 8.1 x 0.75
0.75	1	1.5	2	3	4	DVTK0004E	3	3.7 x 4.5 x 1.5	5.0 x 8.1 x 0.75
1.5	2	2.2 - 3	3	5	7	DVTK0007E	3	3.7 x 4.5 x 1.5	5.0 x 8.1 x 0.75
2	3	4	5	7.5	9	DVTK0009E	3	3.7 x 4.5 x 1.5	5.0 x 8.1 x 0.75
3	4	5.5	7.5	10	12	DVTK0012E	3	3.7 x 4.5 x 1.5	5.0 x 8.1 x 0.75
5	5.5	7.5	10	15	17	DVTK0017E	4	4.0 x 4.2 x 4.0	5.0 x 8.1 x 0.75
5.5	7.5	11	15	20	22	DVTK0022E	4	4.0 x 4.2 x 4.0	5.0 x 8.1 x 0.75
7.5	10	-	20	25	27	DVTK0027E	4	4.0 x 4.2 x 4.0	5.0 x 8.1 x 0.75
10	12.5	15	25	30	35	DVTK0035E	4	4.0 x 4.2 x 4.0	5.0 x 8.1 x 0.75
12.5	15	18.5-22	30	40	45	DVTK0045E	6	4.4 x 4.2 x 4.0	5.0 x 8.1 x 0.75
15	20	-	40	50	55	DVTK0055E	8	5.0 x 5.9 x 4.3	5.0 x 8.1 x 0.75
20	25	30	50	60	65	DVTK0065E	10	5.0 x 5.9 x 4.7	5.0 x 8.1 x 0.75
25	30	37	60	75	80	DVTK0080E	11	5.0 x 5.9 x 4.9	5.0 x 8.1 x 0.75
30	40	45 - 55	75	100	110	DVTK0110E	15	5.5 x 7.1 x 5.1	6.3 x 10.3 x 1.25
40	50	-	100	125	130	DVTK0130E	13	5.5 x 7.1 x 5.1	6.3 x 10.3 x 1.25
50	60	75 - 90	125	150	160	DVTK0160E	22	5.5 x 7.1 x 5.8	6.3 x 10.3 x 1.25
60	75	110	150	200	200	DVTK0200E	29	6.9 x 8.9 x 6.1	6.3 x 10.3 x 1.25
75	100	132	200	250	250	DVTK0250E	29	6.9 x 8.9 x 6.1	6.3 x 10.3 x 1.25
100	125	160	250	300	305	DVTK0305E	30	7.0 x 8.9 x 6.6	6.3 x 10.3 x 1.25
125	150	185-200	300	350	365	DVTK0365E	41	7.3 x 8.9 x 7.2	6.3 x 10.3 x 1.25
150	175	-	350	450	415	DVTK0415E	49	7.4 x 9.6 x 8.1	6.3 x 10.3 x 1.25
175	225	250	400-450	500 - 550	515	DVTK0515E	62	8.3 x 10.8 x 7.9	(2) 6.3 x 10.3 x 1.25
200	250	315	500	600	600	DVTK0600E	71	8.4 x 10.8 x 8.6	(2) 6.3 x 10.3 x 1.25
250	300	375	600-605	700	750	DVTK0750E	113	11.1 x 14.3 x 9.5	(2) 6.3 x 10.3 x 1.25

* Kits are supplied with Reactor and Resistor Kit only. They are not preassembled or prewired.

Part Number Selection Tables

Table 4-2: Open Panel Selection Table

208V Motor HP	240V Motor HP	380V Motor KW	480V Motor HP	550V-600V Motor HP	Filter Amp Rating	Part Number	App. Wt. (lbs.)	Filter Dimensions (in.) (H x W x D)
0.5	.75	0.5-1.1	0.5-1.5	0.5-2	3	DVTP0003E	6	8.9 x 5.5 x 7.7
0.75	1	1.5	2	3	4	DVTP0004E	6	8.9 x 5.5 x 7.7
1.5	2	2.2-3	3	5	7	DVTP0007E	6	8.9 x 5.5 x 7.7
2	3	4	5	7.5	9	DVTP0009E	6	8.9 x 5.5 x 7.7
3	4	5.5	7.5	10	12	DVTP0012E	6	8.9 x 5.5 x 7.7
5	5.5	7.5	10	15	17	DVTP0017E	7	8.9 x 5.5 x 8.0
5.5	7.5	11	15	20	22	DVTP0022E	7	8.9 x 5.5 x 8.0
7.5	10	-	20	25	27	DVTP0027E	7	8.9 x 5.5 x 8.0
10	12.5	15	25	30	35	DVTP0035E	9	12.0 x 8.0 x 8.1
12.5	15	18.5-22	30	40	45	DVTP0045E	11	12.0 x 8.0 x 8.1
15	20	-	40	50	55	DVTP0055E	12	12.0 x 8.0 x 9.0
20	25	30	50	60	65	DVTP0065E	14	12.0 x 8.0 x 9.0
25	30	37	60	75	80	DVTP0080E	16	12.0 x 8.0 x 9.0
30	40	45-55	75	100	110	DVTP0110E	19	12.0 x 8.0 x 9.5
40	50	-	100	125	130	DVTP0130E	15	6.4 x 10.5 x 8.6
50	60	75-90	125	150	160	DVTP0160E	24	6.4 x 10.5 x 9.9
60	75	110	150	200	200	DVTP0200E	32	6.9 x 11.0 x 9.5
75	100	132	200	250	250	DVTP0250E	32	7.0 x 11.0 x 9.5
100	125	160	250	300	305	DVTP0305E	35	7.3 x 11.5 x 11.0
125	150	185-200	300	350	365	DVTP0365E	45	7.3 x 11.5 x 11.6
150	175	-	350	450	415	DVTP0415E	57	7.3 x 11.5 x 13.0
175	225	250	400-450	500-550	515	DVTP0515E	72	8.4 x 12.3 x 14.8
200	250	315	500	600	600	DVTP0600E	82	8.4 x 12.3 x 16.4
250	300	375	600-605	700	750	DVTP0750E	129	11.4 x 15.0 x 18.0

Part Number Selection Tables

Table 4-3: Enclosed NEMA 1/2 Selection Table

208V Motor HP	240V Motor HP	380V Motor KW	480V Motor HP	550V-600V Motor HP	Filter Amp Rating	Part Number	App. Wt. (lbs.)	NEMA 1/2 Enclosure (in.) (H x W x D)
0.5	.75	0.5 – 1.1	0.5 – 1.5	0.5 - 2	3	DVTG0003E	20	13.2 x 13.0 x 13.1
0.75	1	1.5	2	3	4	DVTG0004E	20	13.2 x 13.0 x 13.1
1.5	2	2.2 - 3	3	5	7	DVTG0007E	20	13.2 x 13.0 x 13.1
2	3	4	5	7.5	9	DVTG0009E	20	13.2 x 13.0 x 13.1
3	4	5.5	7.5	10	12	DVTG0012E	20	13.2 x 13.0 x 13.1
5	5.5	7.5	10	15	17	DVTG0017E	21	13.2 x 13.0 x 13.1
5.5	7.5	11	15	20	22	DVTG0022E	21	13.2 x 13.0 x 13.1
7.5	10	-	20	25	27	DVTG0027E	21	13.2 x 13.0 x 13.1
10	12.5	15	25	30	35	DVTG0035E	21	13.2 x 13.0 x 13.1
12.5	15	18.5 - 22	30	40	45	DVTG0045E	23	13.2 x 13.0 x 13.1
15	20	-	40	50	55	DVTG0055E	25	13.2 x 13.0 x 13.1
20	25	30	50	60	65	DVTG0065E	27	13.2 x 13.0 x 13.1
25	30	37	60	75	80	DVTG0080E	29	13.2 x 13.0 x 13.1
30	40	45 - 55	75	100	110	DVTG0110E	32	13.2 x 13.0 x 13.1
40	50	-	100	125	130	DVTG0130E	64	33.9 x 18.3 x 20.9
50	60	75 - 90	125	150	160	DVTG0160E	73	33.9 x 18.3 x 20.9
60	75	110	150	200	200	DVTG0200E	107	33.9 x 18.3 x 20.9
75	100	132	200	250	250	DVTG0250E	107	33.9 x 18.3 x 20.9
100	125	160	250	300	305	DVTG0305E	110	33.9 x 18.3 x 20.9
125	150	185 - 200	300	350	365	DVTG0365E	120	33.9 x 18.3 x 20.9
150	175	-	350	450	415	DVTG0415E	128	33.9 x 18.3 x 20.9
175	225	250	400 – 450	500 - 550	515	DVTG0515E	240	51.3 x 27.7 x 24.9
200	250	315	500	600	600	DVTG0600E	249	51.3 x 27.7 x 24.9
250	300	375	600-605	700	750	DVTG0750E	296	51.3 x 27.7 x 24.9



Part Number Selection Tables

Table 4-4: Enclosed NEMA 3R Selection Table

208V Motor HP	240V Motor HP	380V Motor KW	480V Motor HP	550V-600V Motor HP	Filter Amp Rating	Part Number	App. Wt. (lbs.)	NEMA 3R Enclosure (in.) (H x W x D)
.5	.75	0.5 – 1.1	0.5 – 1.5	0.5 - 2	3	DVTW0003E	30	15.5 x 11.0 x 12.0
.75	1	1.5	2	3	4	DVTW0004E	30	15.5 x 11.0 x 12.0
1.5	2	2.2 - 3	3	5	7	DVTW0007E	30	15.5 x 11.0 x 12.0
2	3	4	5	7.5	9	DVTW0009E	30	15.5 x 11.0 x 12.0
3	4	5.5	7.5	10	12	DVTW0012E	30	15.5 x 11.0 x 12.0
5	5.5	7.5	10	15	17	DVTW0017E	31	15.5 x 11.0 x 12.0
5.5	7.5	11	15	20	22	DVTW0022E	31	15.5 x 11.0 x 12.0
7.5	10	-	20	25	27	DVTW0027E	31	15.5 x 11.0 x 12.0
10	12.5	15	25	30	35	DVTW0035E	31	15.5 x 11.0 x 12.0
12.5	15	18.5 - 22	30	40	45	DVTW0045E	33	15.5 x 11.0 x 12.0
15	20	-	40	50	55	DVTW0055E	66	24.0 x 12.5 x 23.0
20	25	30	50	60	65	DVTW0065E	68	24.0 x 12.5 x 23.0
25	30	37	60	75	80	DVTW0080E	70	24.0 x 12.5 x 23.0
30	40	45 - 55	75	100	110	DVTW0110E	73	24.0 x 12.5 x 23.0
40	50	-	100	125	130	DVTW0130E	72	24.0 x 12.5 x 23.0
50	60	75 - 90	125	150	160	DVTW0160E	80	24.0 x 12.5 x 23.0
60	75	110	150	200	200	DVTW0200E	118	33.9 x 18.3 x 26.0
75	100	132	200	250	250	DVTW0250E	118	33.9 x 18.3 x 26.0
100	125	160	250	300	305	DVTW0305E	120	33.9 x 18.3 x 26.0
125	150	185 - 200	300	350	365	DVTW0365E	131	33.9 x 18.3 x 26.0
150	175	-	350	450	415	DVTW0415E	139	33.9 x 18.3 x 26.0
175	225	250	400 – 450	500 - 550	515	DVTW0515E	253	51.3 x 27.7 x 30.0
200	250	315	500	600	600	DVTW0600E	262	51.3 x 27.7 x 30.0
250	300	375	600-605	700	750	DVTW0750E	309	51.3 x 27.7 x 30.0

5. HOW TO INSTALL

Installation Checklist

 WARNING	<p>Prior to installation, please review the safety instructions on pages 1 & 2. Failure to practice this can result in body injury!</p>
	<p>Input and output wiring to the filter should be performed by authorized personnel in accordance with NEC and all local electrical codes and regulations.</p>
 WARNING	<p>The filter is designed for use with copper conductors with a minimum temperature rating of 75 degrees C.</p>

The dV E-Series filters are supplied in the following mechanical configurations:

- Kits (3A-750A): Reactor and resistor are provided separately and are not preassembled or pre-wired.
- Open Panel assemblies (3A-750A): Reactor and resistor are assembled on a panel and pre-wired together.
- Floor mounted general purpose NEMA 1/2 & 3R cabinets (3A - 750A): Reactor and resistor/resistor panel are supplied in a cabinet with all items pre-wired together.

Minimum Required Space:

When determining the internal temperature rise and cooling requirements of the enclosure, include the power dissipation of the filter along with all the other components located in the panel. A general guideline is to allow a side clearance of four (4) inches and a vertical clearance of six (6) inches for proper heat dissipation and access within the enclosure. Clearances may be less if proper ventilation exists. Filter components must operate within temperatures specified in this manual or filter operating life will be compromised. Also, be aware of minimum electrical clearances as defined by the appropriate system safety standard(s). The Kit and Open panel versions of the dV E-Series filters generate heat and should be positioned away from heat sensitive components. Avoid locations where the filter would be subjected to excessive vibrations. Locate the filter as close to the inverter as possible.

General purpose NEMA 1/2 and 3R enclosed filters are designed for floor mounting in an environment suitable for the enclosure type. Do not install in or near a corrosive environment. Avoid locations where the filter would be subjected to excessive vibrations. Allow a minimum side and back clearance of eight (8) inches and front clearance of thirty-six (36) inches for proper heat dissipation and access.

Grounding

 WARNING	The filter must always be grounded with a grounding conductor connected to ground terminals.
	For panel mounted units, ensure a 2" x 2" area is cleaned of paint and varnish on lower mounting bracket for ground connection.

NOTE: For cable shield grounding follow the drive manufacturer's recommendations.

Power Wiring Connection

 WARNING	Input and output power wiring to the filter should be performed by authorized personnel in accordance with the NEC and all local electrical codes and regulations. Cable lugs and mounting hardware are provided by the customer.
	Any extremely low or high resistance readings indicate miswiring and may result in damage to filter components if not corrected.
	On NEMA 3R enclosures, CAB-26AP and larger, no live parts shall be mounted below 8 inches from the bottom of the enclosure.

Verify that the power source to which the filter is to be connected is in agreement with the nameplate data on the filter. A fused disconnect switch or circuit breaker should be installed between the filter and its source of power in accordance with the requirements of the NEC and all local electrical codes and regulations. Refer to the drive user manual for selection of the correct fuse rating and class.

For part numbers starting with **DVTK**, interconnection between the reactor, resistor, drive, and motor is shown in Figure 5-2: Kit Diagram ([p22](#)).

For part numbers starting with **DVTP**, **DVTG**, or **DVTW**, interconnection between the filter, drive, and motor is shown in Figure 5-3: Open Panel and Enclosed Diagram ([p23](#)).

Wire gauge range and terminal torque requirements for the dV E-Series are shown in Table 5-1: Torque Ratings ([p24](#)).

Refer to the drive user manual for instructions on interconnecting the drive and motor and the correct start-up procedures for the drive.

The filter is designed for use with copper conductors with a minimum temperature rating of 75 degrees C.

Basic Schematic Diagram

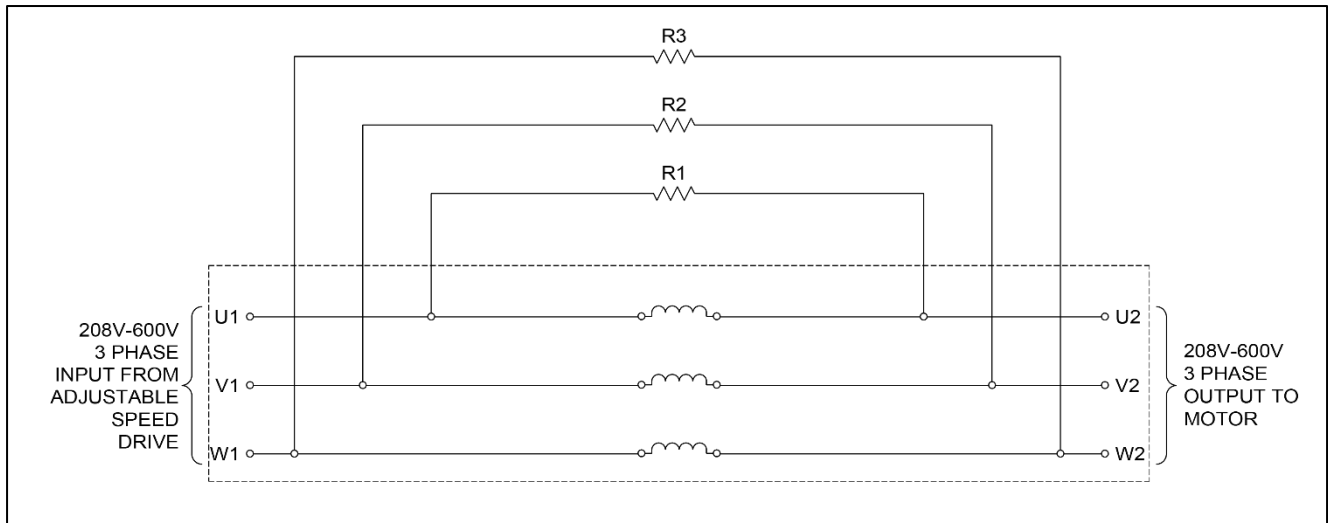

Figure 5-1: Basic Schematic Diagram

Interconnection Diagram – Kit

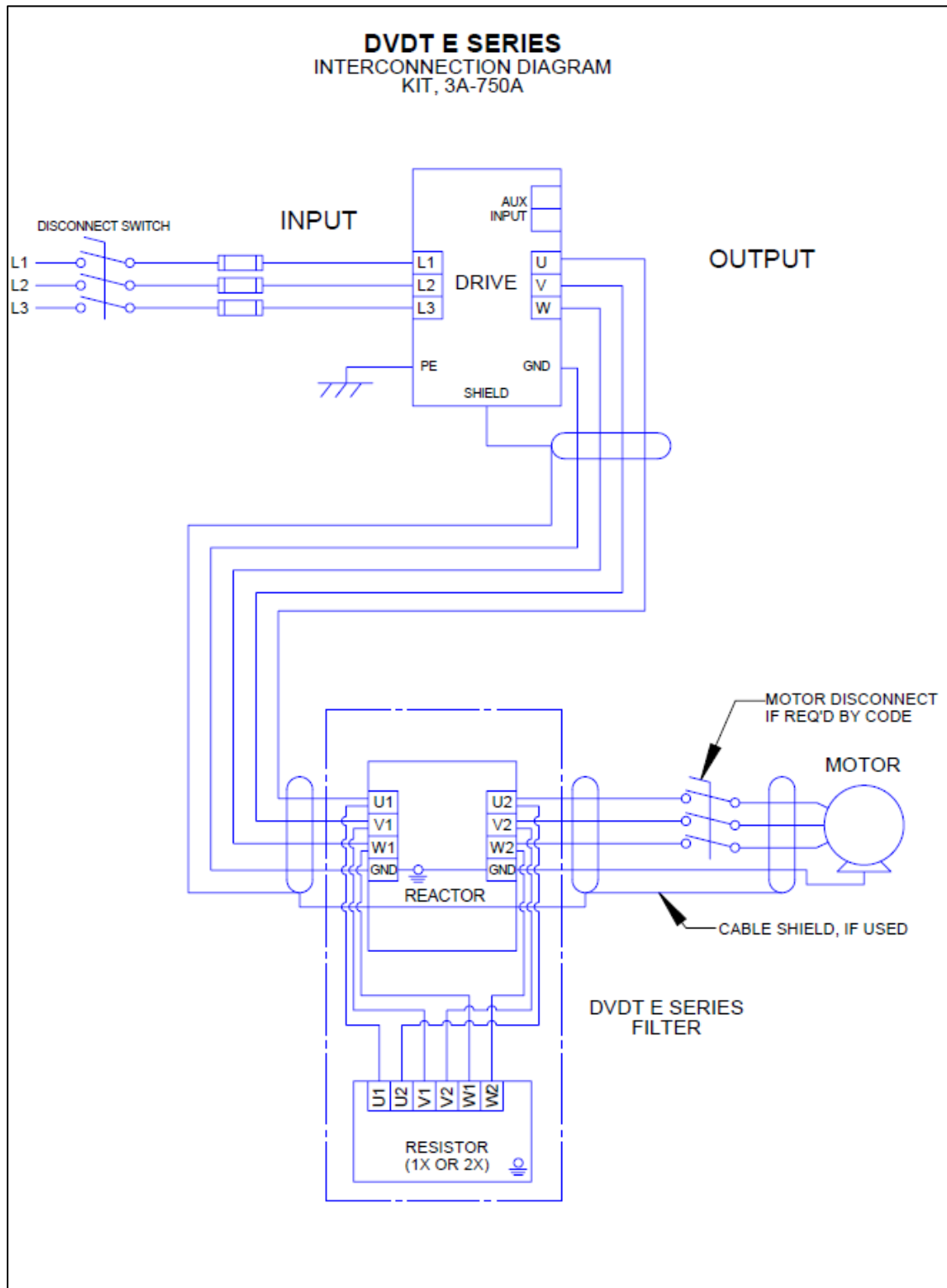

Figure 5-2: Kit Diagram

Interconnection Diagram – Open Panel and Enclosed

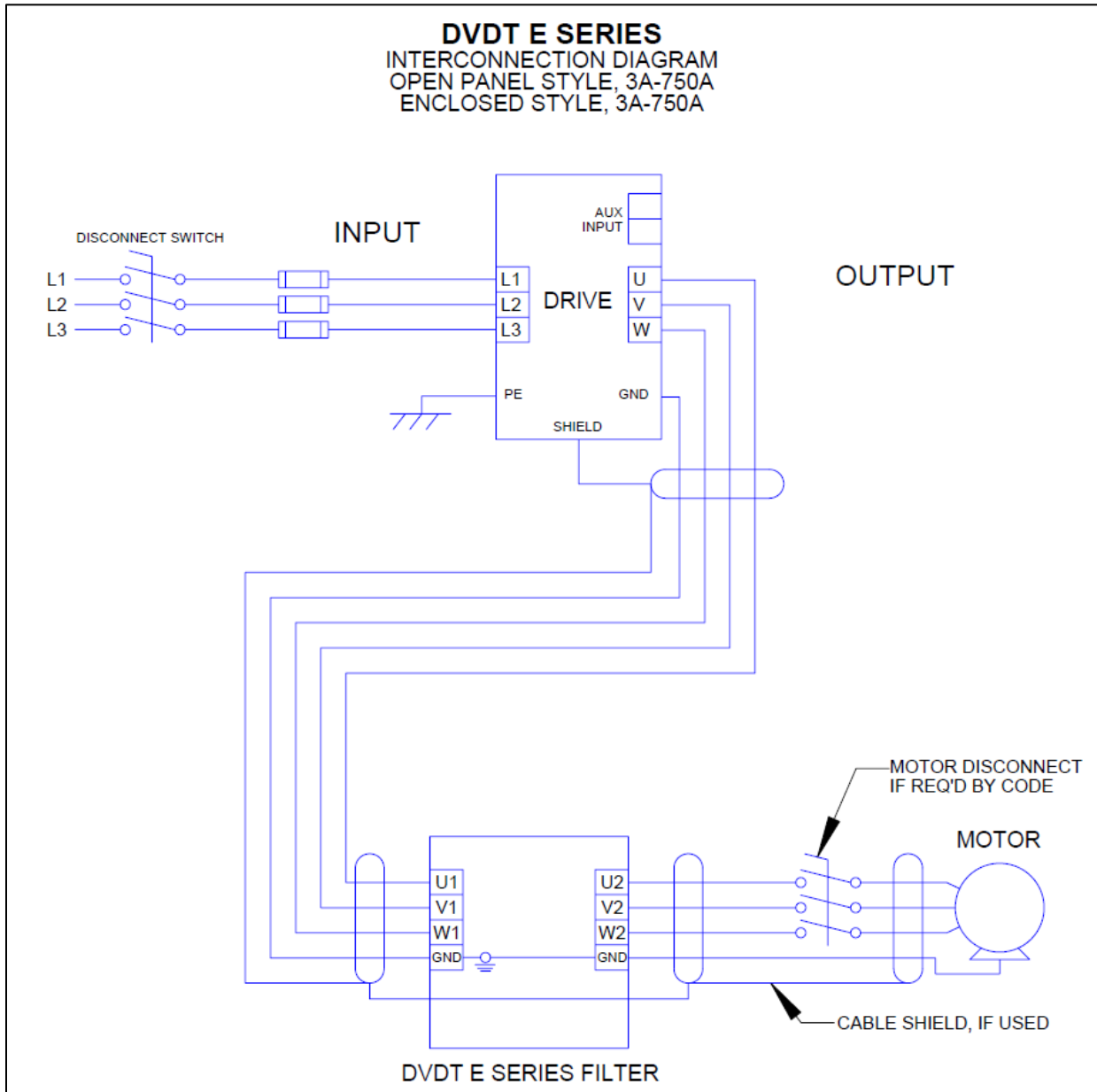

Figure 5-3: Open Panel and Enclosed Diagram

Torque Ratings

Table 5-1: Torque Ratings

Filter Rating (Amps)	dV E-Series Terminals			
	Input /Output Power U1-V1-W1 / U2-V2-W2		Resistor Terminals (Kits ONLY)*	
	Recommended Minimum Wire Size (AWG)	Terminal Torque (in-lbs.)	Recommended Wire Size (AWG)	Terminal Torque (in-lbs.)
3 - 12	14	16	16	N/A
17	12	16	14	N/A
22	10	16	14	N/A
27	10	16	14	N/A
35	8	16	14	N/A
45	8	16	14	N/A
55	6	16	14	N/A
65	6	N/A	14	N/A
80	4	N/A	14	N/A
110	2	N/A	14	N/A
130	1	N/A	14	16
160	4(2x) or 2/0	N/A	14	16
200	3(2x) or 3/0	N/A	14	16
250	1 (2x) or 250kcmil	N/A	14	16
305	2/0 (2x)	N/A	14	16
365	3/0 (2x)	N/A	14	16
415	4/0 (2x)	N/A	14	16
515	300kcmil (2x)	N/A	14	16
600	350kcmil(2x)	N/A	14	16
750		N/A	14	16

NOTE: Kit versions of the dV E-Series ship with a reactor and resistor only. Wiring between these components is the responsibility of the customer and should follow the recommended wire size listed above under “Resistor Terminals.” All other versions of the dV E-Series are pre-wired.



NOTE: To prevent flexing or bending of the coil windings attached to dV E-Series filter, use appropriate strain relief to prevent stress on terminals. For flat copper terminal tabs, use two wrenches to tighten customer provided cable mounting hardware.

NOTE: Wiring should be UL 1199, Class N (200° C)

6. START-UP

Safety Precautions

Before start-up, observe the following warnings and instructions:

 WARNING	<p>Internal components of the filter are at line potential when the filter is connected to the drive. This voltage is extremely dangerous and may cause death or severe injury if you come in contact with it.</p>
	<p>Use extreme caution to avoid contact with line voltage when checking for power. INJURY OR DEATH MAY RESULT IF SAFETY PRECAUTIONS ARE NOT OBSERVED.</p>
	<p>Damage to equipment or serious injury may occur if the inverter start-up procedures are not observed.</p>
 Caution	<p>Damage to the filter may occur if the appropriate output carrier frequency is not observed.</p>

Sequence of Operation

1. Read and follow safety precautions.
2. After installation, ensure that:
 - All filter ground terminals are connected to ground.
 - Power wiring to the utility, drive, filter, and motor is in accordance with the power wiring connection diagrams shown in installation instructions section.
3. Check that moisture has not condensed on the filter components. If moisture is present, do not proceed with start-up until the moisture has been removed.
4. Disconnect filter output terminals from the motor.
5. Set the drive switching frequency to the appropriate setting.
 - 2kHz – 4kHz (3A – 750A Filters)
6. Connect filter temperature safety overload switch into the control circuit so that the drive will shut down in an overload situation.
7. Confirm that drive voltage is present at the input terminals (U1, V1, W1) of the filter.
8. Confirm that drive voltage is present at the output terminals (U2, V2, W2) of the filter.
9. Connect the filter output to the motor.
10. Refer to the drive user manual for the drive start-up procedure. Observe all safety instructions in the drive user manual.

7. TROUBLESHOOTING

 WARNING	<p>When properly installed, this equipment has been designed to provide maximum safety for operating personnel.</p> <p>However, hazardous voltages and elevated temperatures exist within the confines of the enclosure. Servicing should therefore be performed by qualified personnel only and in accordance with OSHA Regulations.</p>
	<p>High voltage is used in the operation of this filter. Use Extreme caution to avoid contact with high voltage when operating, installing, or repairing this filter.</p> <p>INJURY OR DEATH MAY RESULT IF SAFETY PRECAUTIONS ARE NOT OBSERVED.</p>

To aid in troubleshooting, a basic schematic diagram, two interconnection diagrams, and a troubleshooting guide that lists potential problems and solutions are included:

Figure 5-1: Basic Schematic Diagram (p21)

Figure 5-2: Kit Diagram (p22)

Figure 5-3: Open Panel and Enclosed Diagram (p23)

Table 7-1: Troubleshooting Guide (p27)

Table 7-1: Troubleshooting Guide

PROBLEM: Voltage is not present at the filter input terminals.	
Possible cause:	Power to the filter is turned off or shut down.
Solution:	Turn power on; check drive errors.
Possible cause:	One or more external line fuses are blown.
Solution:	Verify the continuity of line fuses in all phases. Replace as necessary.
Possible cause:	Damage to drive – dV E-Series interconnect cables.
Solution:	Replace damaged cables.
Possible cause:	Drive setup parameters are incorrect.
Solution:	Verify motor current, voltage, and shutdown parameters are valid.
PROBLEM: dV E-Series filter runs Hot	
Possible cause:	Normal operation, reactor > 150° C and resistors > 300° C.
Solution:	Caution: Parts are very hot and may cause burns. Follow installation guidelines for clearance and check for adequate air flow.
Possible cause:	Motor coil damage: windings shorted.
Solution:	Replace motor; inspect wiring.
Possible cause:	Heat buildup within enclosure.
Solution:	Provide clearance and venting for filter components.
Possible cause:	Heat buildup within enclosure.
Solution:	Check carrier frequency and overload settings.
Possible cause:	Multiple motor applications create complex loading and resonances with dV E-Series filter.
Solution:	dV E-Series filters can be paralleled for higher current ratings. Contact MTE Application Engineering for more information.