

Models:

F105 | F305 | F505 | F505H
F755 | F755S | F1505 | F1505S

EasyMESUR® Software

User's Guide

↓ TABLE OF CONTENTS ↓

TABLE OF CONTENTS

1 OVERVIEW	4
1.1 Intended purpose	4
1.2 Models F105 / F305 / F505 / F505H	4
1.3 Models F755 / F755S / F1505 / F1505S	6
1.4 EasyMESUR Control Panel - Physical Features	8
2 SAFETY	9
2.1 Checks and procedures	9
2.2 Connecting power	10
2.3 Emergency Stop	10
3 SETUP	11
3.1 Intended Use	11
3.2 Moving the frame into position	11
3.3 Mounting and placement	11
3.4 Limit switches	11
3.5 Connections and outputs	12
3.6 Installing Series FS05 Force Sensors to Models F105 / F305 / F505 / F505H	13
3.7 Installing Series FS06 Force Sensors to Models F755 / F755S / F1505 / F1505S	14
3.8 Installing Series R07 Force Sensors to Models F105 / F305 / F505 / F505H	14
3.9 Installing Series FS05 Force Sensors to Models F755 / F755S / F1505 / F1505S	15
3.10 Installing a Third-Party Force Sensor	15
3.11 Installing the EasyMESUR Control Panel	16
4 EASYMESUR BASICS	18
4.1 Evaluation Mode	18
4.2 Home Screen	18
5 SETTINGS	20
5.1 Information	20
5.2 Preferences	21
5.3 Overload History	23
5.4 Calibration	23
5.5 Update Software and Update Firmware	23
5.6 Optional Functions	24
6 MANUAL CONTROL	26
6.1 Status Bar	26
6.2 Load and Distance Measurement	27
6.3 Motion Control Modes	27
6.4 Set Home	28
7 CREATING A BASIC TEST	29
7.1 Load Test	30
7.2 Distance Test / Limit Switch Test	35

7.3 Break Test (optional function).....	35
7.4 Load Hold Test (optional function).....	36
7.5 Cycle Test (optional function)	36
7.6 Averaging Test.....	37
8 OPENING AND RUNNING A TEST	39
8.1 Favorite Tests	39
8.2 Other Tests	40
8.3 Running a Test.....	41
8.4 Results (requires the optional Graphing & Reporting function)	44
9 PC CONTROL	49
9.1 Configuration.....	49
9.2 Command Set.....	50
10 CALIBRATION	52
10.1 Force Sensor Calibration	52
10.2 Speed and Distance Calibration	57
11 MAINTENANCE & SERVICE – MODELS F105 / F305 / F505 / F505H	58
11.1 Physical Maintenance.....	58
11.2 Removing the Motor Drive Unit (MDU).....	62
12 MAINTENANCE & SERVICE – MODELS F1505 / F1505S / F755 / F755S.....	63
12.1 Physical Maintenance	63
12.2 Removing the Motor Drive Unit (MDU).....	65
13 ACCESSORY INSTALLATION.....	66
13.1 Installing the External Emergency Switch Connector.....	66
13.2 Separating the Column From The Base / Column Extension Installation – F105 / F305 / F505 / F505H	68
13.3 Installing a double column extension – F105 / F305 / F505.....	71
14 UPDATING SOFTWARE AND FIRMWARE	72
14.1 Update EasyMESUR	72
14.2 Update Test Frame Firmware	73
15 SPECIFICATIONS & DIMENSIONS	74
15.1 Specifications.....	74
15.2 Dimensions IN [MM]	75

1 OVERVIEW

1.1 Intended purpose



Series F test frames with EasyMESUR control panels produce tension and compression loads. When combined with a force sensor, users can measure load and distance, set up a test, record, analyze, and output data. Test frames are offered in several models, corresponding to different heights and load ranges.

Series FS05, R06, and R07 force sensors are required for use with these test frames.

1.2 Models F105 / F305 / F505 / F505H

1.2.1 Included items

Qty.	Description
1	EasyMESUR control panel, mounting bracket, and hardware
1	Mounting bracket, column end (F505H only)
1	Accessories kit: <ul style="list-style-type: none"> - #10-32M medium hook - 5/16-18M large hook - #10-32F 2" diameter compression plate - #10-32 F/F coupler - Adapter, 5/16-18M to #10-32F - Set screw, #10-32 x 3/4" (1) - Hex nut, #10-32 (2) - Allen wrench set
1	Power cord
1	Allen wrench set

1.2.2 Physical features

Note the following physical features. The user's guide will reference this terminology. Model F305-EM is shown below:

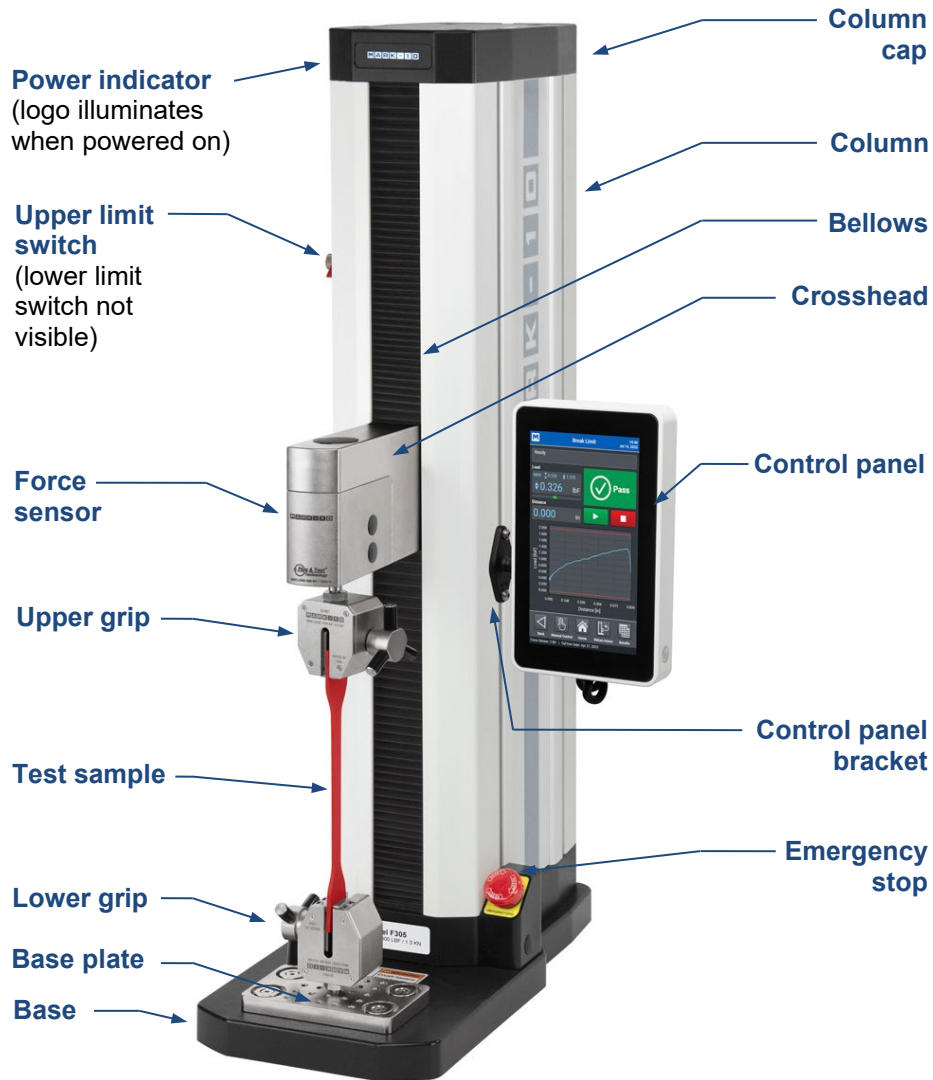

1.2.3 Installing the Column End Cap for F505H

The end cap is shipped in a separate box within the main box for the F505H test frame. Line it up with the right end of the column, then install with the four included screws, as shown below:



1.3 Models F755 / F755S / F1505 / F1505S

1.3.1 Included items

Qty.	Description
1	EasyMESUR control panel, mounting bracket, and hardware
1	Eye end kit for base
2	Lock ring for eye end
2	Spanner wrench
1	Power cord
1	Allen wrench set

1.3.2 Physical features

Note the following physical features. The user's guide will reference this terminology. Model F1505-EM is shown below:

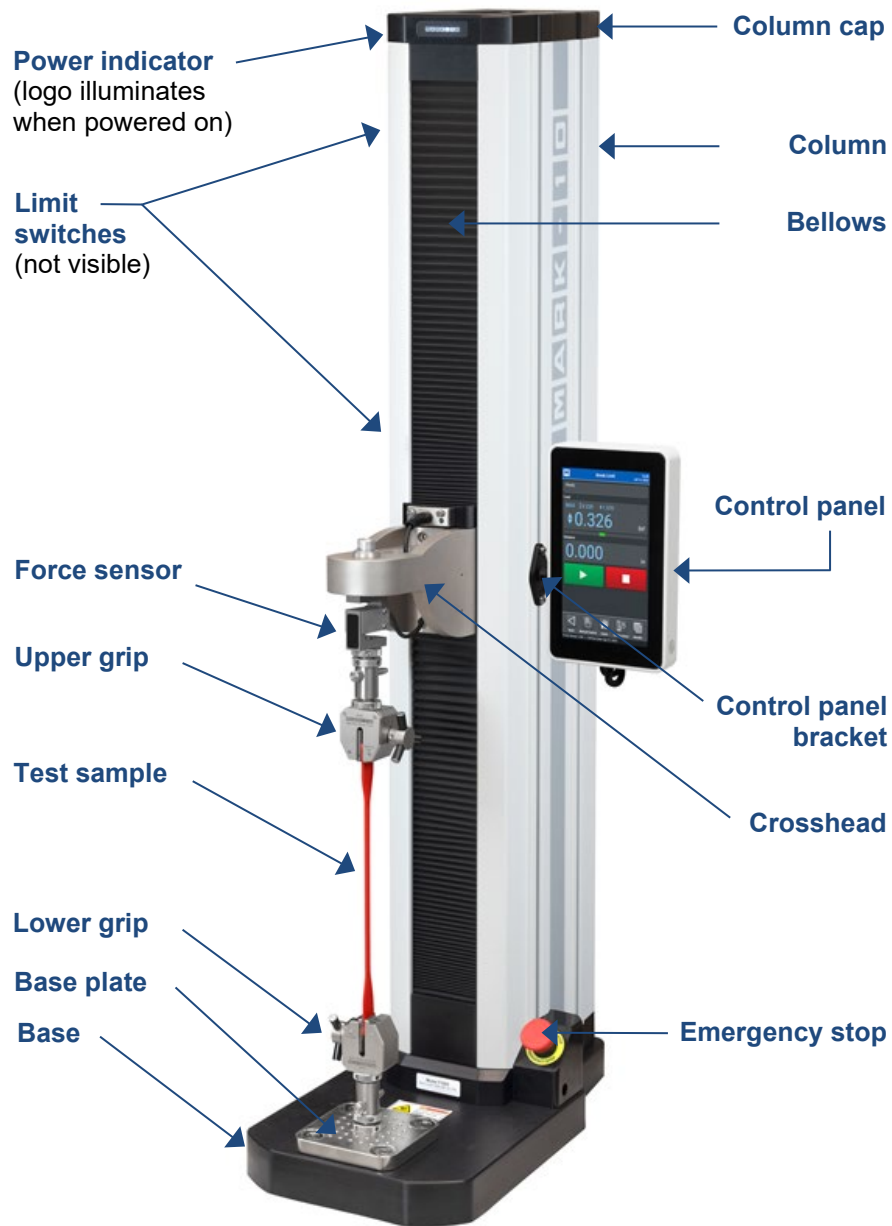

1.4 EasyMESUR Control Panel - Physical Features

Note the following physical features:



Name	Date modified	Type	Size
Peel Test - 1 in. Sample - Oct 24, 2022 - 9_47 AM.ezr	10/24/2022 9:48 AM	EZR File	2 KB
Peel Test - 1 in. Sample - Oct 24, 2022 - 9_39 AM.ezr	10/24/2022 9:41 AM	EZR File	2 KB
Peel Test - 1 in. Sample - Oct 24, 2022 - 9_38 AM.ezr	10/24/2022 9:39 AM	EZR File	2 KB
Peel Test - 1 in. Sample - Oct 23, 2022 - 11_14 PM.ezr	10/23/2022 11:14 PM	EZR File	2 KB
Peel Test - 1 in. Sample - Oct 23, 2022 - 11_12 PM.ezr	10/23/2022 11:13 PM	EZR File	2 KB
Peel Test - 1 in. Sample - Sep 20, 2022 - 2_07 PM.ezr	9/20/2022 2:08 PM	EZR File	2 KB
Peel Test - 1 in. Sample - Sep 20, 2022 - 10_49 AM.ezr	9/20/2022 10:51 AM	EZR File	2 KB
Peel Test - 1 in. Sample - Sep 20, 2022 - 10_24 AM.ezr	9/20/2022 10:25 AM	EZR File	2 KB
Peel Test - 1 in. Sample - Sep 20, 2022 - 10_19 AM.ezr	9/20/2022 10:19 AM	EZR File	2 KB
Peel Test - 1 in. Sample - Sep 20, 2022 - 10_09 AM.ezr	9/20/2022 10:13 AM	EZR File	2 KB
Component Compression Test - Sep 20, 2022 - 10_05 AM.ezr	9/20/2022 10:05 AM	EZR File	2 KB
Component Compression Test - Sep 20, 2022 - 10_04 AM.ezr	9/20/2022 10:05 AM	EZR File	2 KB
Break Test - Mar 09, 2022 - 11_24 AM.ezr	3/9/2022 11:24 AM	EZR File	2 KB
Break Test - Mar 04, 2022 - 10_45 AM.ezr	3/4/2022 10:45 AM	EZR File	1 KB

2 SAFETY

Safety features provided by Series F test frames may be impaired if equipment is used in a manner not specified by Mark-10.

2.1 Checks and procedures

The following safety checks and procedures should be performed before and during operation:

1. Always consider the characteristics of the sample being tested before initiating a test. A risk assessment should be carried out beforehand to ensure that all safety measures have been addressed and implemented.
2. Wear eye and face protection when testing, especially when testing brittle samples that have the potential to shatter under load. Be aware of the dangers posed by potential energy that can accumulate in the sample during testing. Extra bodily protection should be worn if a destructive failure of a test sample is possible.
3. Keep away from moving parts of the test frame. Loose articles of clothing should not be worn. Long hair should be covered to avoid a hazardous situation. A Crush Hazard warning label is located on the base of the test frame. It appears as follows:



Definition: Keep any body parts and clothing clear of the area between the base of the test frame and the moving crosshead.

4. Ensure that grips and fixtures are positioned to ensure axial load with respect to the load axis of the force sensor. Ensure that they secure the sample in such a way that it is prevented from slipping out during a test, which is a safety risk to the operator and others in the vicinity. If using a grip or fixture from a supplier other than Mark-10, ensure that it is constructed of suitably rugged materials and components.
5. In those applications where samples can shatter, or other applications that could lead to a hazardous situation, use of a shield is strongly recommended.
6. When the test frame is not in use, ensure that the power is turned off to prevent accidental engagement of any of the controls.

2.2 Connecting power

Plug one end of the power cord into its receptacle at the rear of the stand and the other end into a wall outlet with local earth ground (3-prong connector).

Before turning on power, the following safety checks and procedures should be performed:

1. Never operate the test frame if there is any visible damage to the power cord or the test frame itself. The test frame is powered by 110V/220V. Any contact with this high voltage can cause serious injury or even death.
2. Ensure that the test frame is kept away from water or any electrically conductive liquids at all times.
3. Make sure the electrical outlet powering the test frame has local earth ground (3-prong connector).
4. The test frame should be serviced by a trained technician only. Power must be disconnected before the column covers are removed.
5. Never use a detachable mains supply cord with inadequate ratings.

After the above safety checks and procedures have been performed, the test frame may be powered on and is ready for operation.

2.3 Emergency Stop

The emergency stop switch is located where the lower right end of the column is attached to the base, as shown below:

Models F105 / F305 / F505 / F505H



Models F755 / F755S / F1505 / F1505S



Press down to stop crosshead motion. Rotate clockwise to release the switch.

3 SETUP

3.1 Intended Use

Series F test frames with EasyMESUR control panel are designed for tension and compression measurement applications. The test frame applies load, while a force sensor measures the applied loads. EasyMESUR displays load and position information, and includes analytical tools to help quality control, engineering, and manufacturing professionals determine the mechanical properties and quality of materials and assemblies.

3.2 Moving the frame into position

Place the frame on a sturdy, clean, and level work area free from vibration.

In Models F755, F755S, F1505, and F1505S, a recessed lifting hook is located at the top of the column, for ease of lifting, as shown below:

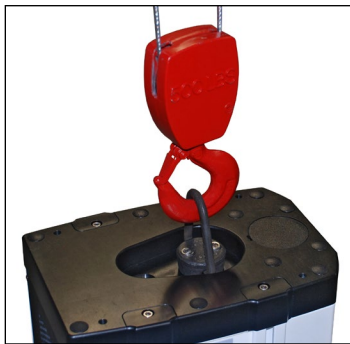

For Models F105, F305, F505, and F505H frames, orient the rear of the test frame towards the edge of a table, tilt backwards, then lift underneath the base and underneath the rear of the column.

3.3 Mounting and placement

Place the test frame on a clean, flat and level work area free from vibration. Ensure that the rear of the column is easily accessible, so that the power cord can be disconnected in an emergency.

It is suggested to mount the test frame to a work bench via screws fastened into the underside of the base. Failure to properly mount the test frame may make it more vulnerable to tipping, especially if a column extension is used, causing a hazardous situation.

3.4 Limit switches

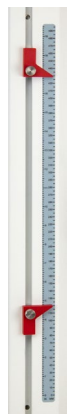

Upper and lower limit switches are supplied to stop travel in both directions. They may be moved up and down by loosening and tightening the thumb screws, as shown at left.

A dual-graduated inch/mm ruler adjacent to the limit switches can be helpful for positioning.

3.5 Connections and outputs

The following connections and outputs are supplied in the rear of the test frame, as shown in the illustration below:

	<p>Auxiliary Limits For interfacing an external limit switch, such as an interlock for a shield door. A pin diagram is shown in the next sub-section.</p> <p>USB port For interfacing with a Windows device for PC control applications. May also be used to run IntelliMESUR software instead of EasyMESUR (EasyMESUR cable must be disconnected).</p> <p>Control Panel For connecting the EasyMESUR control panel.</p> <p>External Emergency Switch May be used to connect an optional external emergency stop switch. May be installed at the factory at time of order, or installed in the field as a retrofit. Required for use with optional shields. Refer to the Accessory Installation section for instructions.</p> <p>Power switch Refer to the Connecting Power sub-section for important safety information.</p> <p>Power plug receptacle Plug the power cord in here. Refer to the Connecting Power sub-section for important safety information.</p>
--	--

3.5.1 Auxiliary Limits pin diagram

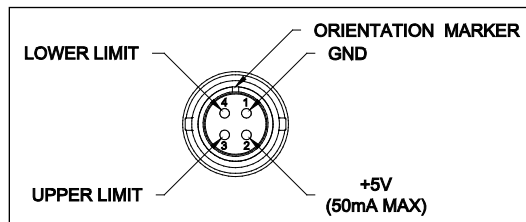

Note that when pins 3 and 4 are not connected, the auxiliary limits are inactive. When the +5V from pin 2 is connected to either pin 3 or pin 4, the respective limit becomes active and the crosshead is prevented from movement in that direction.

3.6 Installing Series FS05 Force Sensors to Models F105 / F305 / F505 / F505H



To avoid overload and damage, select a force sensor with sufficient capacity to accommodate the application.

Series FS05 force sensors mount directly to the crosshead. Once the test frame is in a stable and secure position, install the force sensor by matching the gold-plated pads on the top surface with the pins in the underside of the crosshead, as shown below:



While holding the force sensor in place with one hand, use an Allen wrench with the other hand to tighten the screw that joins the force sensor to the crosshead, as shown below:



Optionally cover the screw head with the included black plastic cap.

Grips and fixtures may be threaded onto the threaded shaft protruding from the bottom of the force sensor, for example:



To avoid damage to the internal load cell or shaft, do not use tools to tighten grips or attachments onto the shaft. Hand-tighten only.

3.7 Installing Series FS06 Force Sensors to Models F755 / F755S / F1505 / F1505S

Insert the included screw through the crosshead, through the mounting block, and into the force sensor, as shown below:



3.8 Installing Series R07 Force Sensors to Models F105 / F305 / F505 / F505H

Install the sensor to the underside of the crosshead using the supplied socket head screw and hardware. Plug the connector into the receptacle in the top front surface of the crosshead, then fasten the thumb screws into the crosshead, as shown below:



Grips and fixtures may be threaded onto the underside of the sensor.

3.9 Installing Series FS05 Force Sensors to Models F755 / F755S / F1505 / F1505S

Series FS05 force sensors may be installed via the optional AC1083 adapter, as shown below:

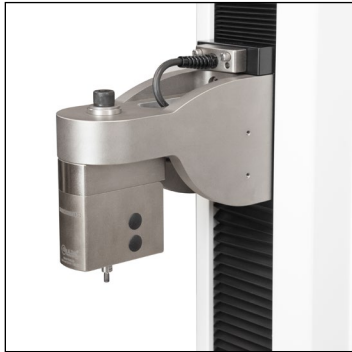

3.10 Installing a Third-Party Force Sensor



Before installing the sensor, refer to the Model PTA / PTAF user's guide for complete instructions.

3.10.1 Models F105 / F305 / F505 / F505H

Using the optional Model PTAF adapter, a third-party force sensor may be mounted to the test frame. Insert a screw of sufficient length and appropriate thread size through the crosshead, through the PTAF, and into the force sensor, as shown in the following example:



3.10.2 Models F755 / F755S / F1505 / F1505S

Using the optional Model PTAF adapter and AC1083 adapter, a third-party force sensor cell may be mounted to the test frame. Insert a screw of sufficient length and appropriate thread size through the crosshead, through the AC1083 adapter, through the PTAF, and into the force sensor, as shown in the following example:



3.11 Installing the EasyMESUR Control Panel

The mounting arm is pre-installed into the front right slot in the test frame column via two screws, as shown below:



Loosen the knob sufficiently to slide the ball, mounted to the rear of the control panel, into the arm. Adjust the viewing angle as desired, then tighten the knob.



Do not attempt to adjust the viewing angle before loosening the knob.

Connect the coiled cable to the **Control Panel** connector in the rear of the test frame, as shown below:



The control panel will boot up automatically when the test frame is powered on. Power is indicated when the Mark-10 logo at the top of the column is illuminated.

While booting up, the LED in the upper right corner of the EasyMESUR control panel will flash until the welcome screen appears.

4 EASYMESUR BASICS

4.1 Evaluation Mode

EasyMESUR control panels have a number of standard and optional functions. All systems are shipped in *Evaluation Mode*, a 160-hour period in which all available functions are temporarily enabled. At boot-up, a counter displays the number of hours remaining.

To view installed and uninstalled functions, activate uninstalled functions, and pause *Evaluation Mode*, refer to the **Optional Functions** for instructions.

4.2 Home Screen

After bootup is complete, the **Home** screen appears, as follows:

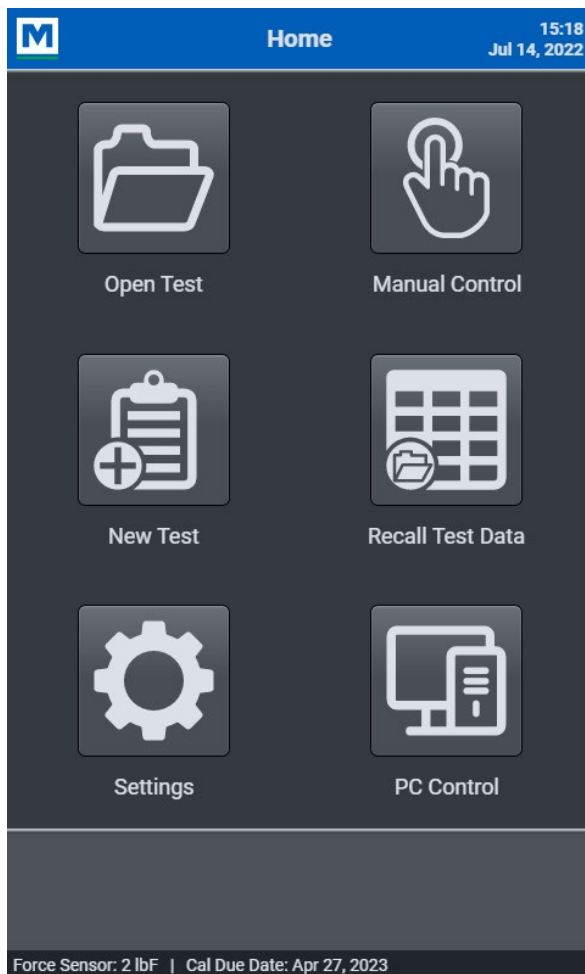

EasyMESUR launches into the Home Screen, with the following selections:

**Open Test**

Recall a previously saved test.

**Manual Control**

Manually control the up and down motion of the test frame, and see live load, peak load, and live distance.

**New Test**

Create a new test.

**Recall Test Data**

Recall data from previously saved test runs.

**Settings**

Includes preferences, calibration, overload log, and other functions.

**PC Control** (optional function)

Run the test frame and collect data via a third-party software application.

Bottom Footer

Along the bottom edge of all EasyMESUR screens, the following information is always displayed, from left to right:

- Force sensor capacity or "Test Frame Not Connected" message
- Calibration status of the force sensor
- Evaluation Mode remaining hours
- External device connected

One of the following icons appear in the lower right corner:



PC connected



USB flash drive installed

5 SETTINGS

5.1 Information

Contains serial numbers, software and firmware versions, and other information about the equipment. The screen appears as follows:



The screenshot shows the 'Information' screen with a blue header bar containing the 'M' logo, the title 'Information', and the time '13:46' and date 'Oct 31, 2022'. The main content area is dark grey and lists the following information:

- EasyMESUR Version: 1.0.0
- Control Panel Serial Number: 123456789
- Evaluation Time Remaining: Expired
- Test Frame:
 - Model Number: F305
 - Serial Number: 4088221
 - Capacity: 300 lbF / 4800 ozF / 150 kgF / 1500 N /
 - Firmware Version: 1.00.10
- Force Sensor:
 - Model Number: FS05-100
 - Serial Number: 4083608
 - Capacity: 100 lbF / 1600 ozF / 50 kgF / 50000 gF
 - Calibration Date: Sep 2, 2021
 - Calibration Due Date: Not Set
- Designed and produced by:
 - Mark-10 Corporation
 - 11 Dixon Avenue
 - Copiapue, NY 11726 USA
 - 888-MARK-TEN
 - (888-627-5836)
 - +1-631-842-9200
 - info@mark-10.com
 - www.mark-10.com
 - © 2022 Mark-10 Corporation

At the bottom, there are three navigation icons: a left-pointing triangle labeled 'Back', a house icon labeled 'Home', and an open book icon labeled 'User's Guide'. Below these icons, a status bar reads 'Force Sensor: 100 lbF | Cal Due Date: Dec 30, 2022'.

5.2 Preferences

Default units of measure, date and time format, and other settings may be accessed from the **Preferences** screen. The screen appears as follows:

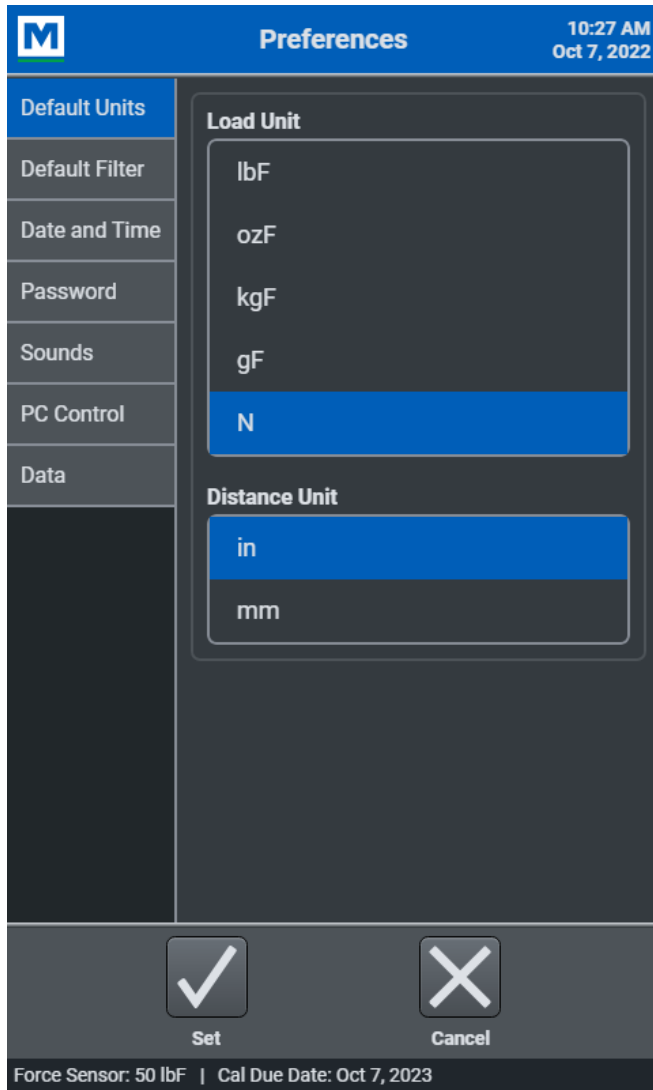

5.2.1 Default Units

Load and Distance Units

Select the desired units of measure. Note that not all units are supported by all force sensors. Refer to the force sensor's specifications for list of supported units.

5.2.2 Default Filter

The digital filter smooths out load readings in situations where there is mechanical interference in the work area or test sample. The filter utilizes a moving average technique in which consecutive readings are pushed through a buffer and the displayed reading is the average of the buffer contents. By varying the length of the buffer, a variable smoothing effect can be achieved. The selection of 1 will disable the filter since the average of a single value is the value itself.

Available settings: 4 through 16,384.

It is recommended to keep the filter as low as possible for best performance.

5.2.3 Date and Time Format

Select the preferred date and time formats, and set the current date and time.

5.2.4 Password

A password may be set to restrict access to certain areas of EasyMESUR, including creating a test, calibration, settings, and other areas.

5.2.5 Sounds

The EasyMESUR control panel can produce sounds for user-specified events, including force sensor overloads, button presses, and test completions.

5.2.6 PC Control

Configure the baud rate for **PC Control** (optional function).

5.2.7 Data

The following functions are available in this section:

- **Reset to Default Preferences**
Restores all default settings and preferences.
- **Delete User Files**
Delete all user-created files, such as tests and results.
- **Export All Log Files**
Export all system log files to a USB flash drive. Only necessary if requested by Mark-10's technical support or engineering personnel.
- **Backup User Data and Settings**
Create a complete system backup file, including all settings, test files, and results files.
- **Restore User Data and Settings**
Restore user data from a backup file.

5.3 Overload History

EasyMESUR constantly monitors the force sensor, and stops the crosshead when the load reaches 120% of capacity. However, it is still possible to overload a force sensor when it is stationary by manually applying excessive force to it.

Overload History provides a record of the 50 most recent overloads, containing a time stamp, motion direction, and load direction for each occurrence. An example screen appears as follows:



Reading Number	Date	Time	Motion Direction	Load Direction
1	Oct 24, 2022	15:13:43	Stop	▲
2	Oct 10, 2022	16:48:39	Stop	▲
3	Oct 10, 2022	16:43:28	Stop	▲
4	Aug 26, 2022	17:41:59	Stop	▲
5	Aug 26, 2022	17:36:59	Stop	▲
6	Aug 26, 2022	17:31:59	Stop	▲
7	Aug 18, 2022	15:00:50	Stop	▲
8	Aug 8, 2022	16:31:53	Stop	▲
9	Jun 21, 2022	14:46:55	Stop	▲
10	Jun 15, 2022	13:04:50	Stop	▲
11	Jun 13, 2022	17:29:18	Up	▲
12	May 16, 2022	10:45:37	Stop	▲
13	May 16, 2022	10:40:37	Stop	▲
14	May 16, 2022	10:35:37	Up	▲
15	May 16, 2022	10:30:37	Stop	▲
16	May 16, 2022	10:25:37	Stop	▲
17	May 16, 2022	10:20:37	Stop	▲

Force Sensor: 50 lbF | Cal Due Date: Oct 7, 2023

Note: Overloads which may occur while the force sensor is disconnected from a Series F test frame, or while the test frame is powered off, are not recorded in **Overload History**.

5.4 Calibration

Refer to the Calibration section for instructions on calibrating a force sensor.

5.5 Update Software and Update Firmware

Refer to the **Maintenance and Service** section for further information.

5.6 Optional Functions

5.6.1 List of Available Functions and Packages

Individual Functions

Model No.*	Function	Description
EMF001-1 / -2	Distance Measurement	Measure distance, with the ability to zero the reading.
EMF002-1 / -2	Distance Limits	Stop at user-defined upper and lower distance limits.
EMF003-1 / -2	Preload	Zero the travel position automatically at a user-defined preload value.
EMF004-1 / -2	High Speed Extension	Extend the high end of the speed range, dependent upon test frame model.
EMF005-1 / -2	Low Speed Extension	Extend the low end of the speed range, dependent upon test frame model.
EMF006-1 / -2	Cycling	Set up to 100,000 cycles, with user-defined upper and lower dwell times. Cycle between any combination of limit switches, travel limits, breaks, and load limits.
EMF007-1 / -2	Break Detection	Stop when a user-defined drop in load occurs.
EMF008-1 / -2	Load Holding	Stop at, and maintain, a user-defined load for a specified period of time.
EMF009-1 / -2	FollowMe®	Push and pull on the sensor's loading shaft to jog the crosshead up and down, ideal for manual positioning prior to a test. Speed increases with applied load.
EMF010-1 / -2	Graphing & Reporting	Graph load vs. time or distance, view statistics, and generate a report, including graph, results, run data, and other information.
EMF011-1 / -2	PC Control	Control the test frame with your own application using via your own application with a library of motion control and data collection serial commands. While PC control is active, the control panel becomes a pendant, limited to basic, manual controls.

Function Packages

Model No.*	Function Package	Includes
EMP001-1 / -2	Distance Measurement Package	EMF001-1 / -2 - Distance Measurement EMF002-1 / -2 - Distance Limits EMF003-1 / -2 - Preload
EMP002-1 / -2	Speed Extension Package	EMF004-1 / -2 - High Speed Extension EMF005-1 / -2 - Low Speed Extension
EMP003-1 / -2	Advanced Functionality Package	EMF006-1 / -2 - Cycling EMF007-1 / -2 - Break Detection EMF008-1 / -2 - Load Holding EMF009-1 / -2 - FollowMe®
EMP-COMP-1 / -2	Complete Options Package	All functions

* -1 refers to the following test frame models: F105, F305, F505, F505H

-2 refers to the following test frame models: F755, F755S, F1505, F1505S

5.6.2 Evaluation Mode

EasyMESUR control panels have a number of standard and optional functions. All systems are shipped in *Evaluation Mode*, a 160-hour period in which all available functions are temporarily enabled. At boot-up, a counter displays the number of hours remaining. The number of hours is also shown in the **Optional Functions** screens.

5.6.3 View and Activate Functions and Packages

Installed functions are denoted with a green checkmark. Uninstalled functions are denoted with a “padlock” icon.

To activate a function or multiple functions, check the appropriate boxes. Contact Mark-10 with the list of requested functions, along with the **serial number**, and an *Activation Code* will be assigned. Type this code into the space provided, then press **Enter**. The selected functions are now permanently activated.

Follow the same procedure with function packages. Note that only one package may be activated per activation code.

The screens appear as follows:

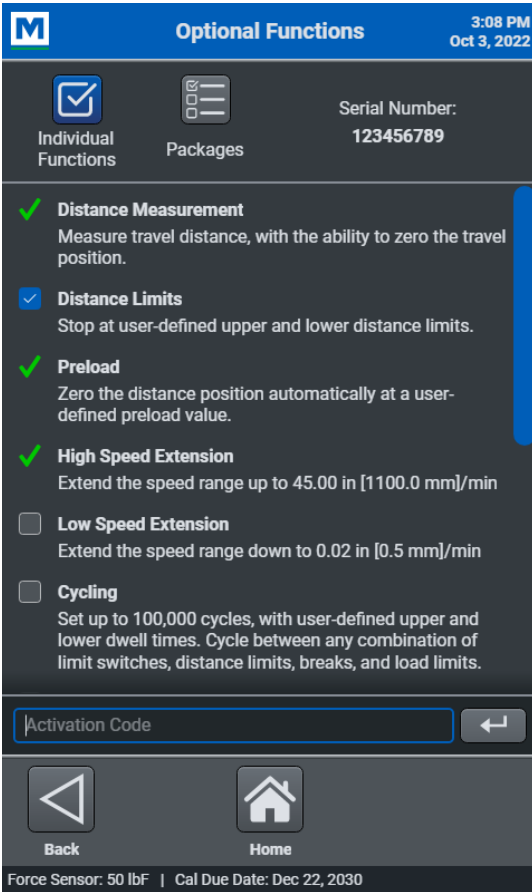

Individual Functions

In this example, *Distance Measurement*, *Preload*, and *High Speed Extension* functions are activated. The user has selected *Distance Limits* and will enter the Activation Code provided by Mark-10 into the space provided.

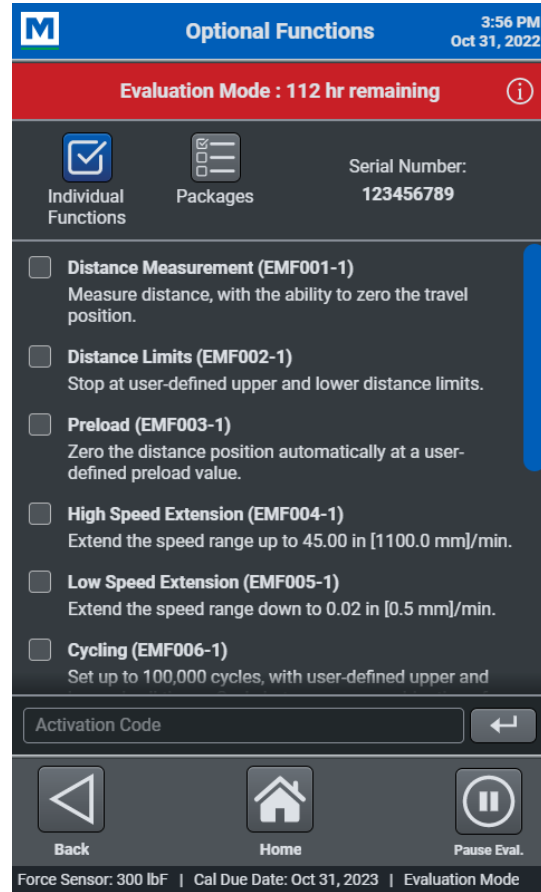

Function Packages

Checkmarks and “padlocks” indicate whether functions within a package are activated. When activating a package, it will activate whichever remaining individual functions are not yet enabled.

In this example view, *Evaluation Mode* is active. The number of remaining hours is indicated. To pause *Evaluation Mode*, press **Pause Eval.** Press **Resume** to resume.

6 MANUAL CONTROL

Manual Control allows the user to move the crosshead up and down and observe load and distance data, without creating a test. Manual control is useful when needing to manually adjust the crosshead prior to starting a test.

Note: Data cannot be saved in **Manual Control**.

The screen appears as follows:



6.1 Status Bar

Along the top of the screen, a notification bar displays the current status of the system, such as moving up or down, stopped, ready, overload, or other information.

6.2 Load and Distance Measurement

Load

Load is displayed in the unit of measurement selected in **Preferences**. Use the **Mode** button to toggle between three display modes:

Load

The real-time load.

Peak Compression Load

Maximum observed compression load.

Peak Tension Load

Maximum observed tension load.

The load bar below the load reading indicates when approaching an overload. The bar increases to the right for compression readings, and to the left for tension readings. The bar colors are as follows:

- Green** 0 - 80% of force sensor capacity
- Yellow** 80 to 100% of force sensor capacity
- Red** 100+% of force sensor capacity

At 120% of force sensor capacity, the load reading is replaced by the word, "**OVER**", which indicates an overload. The status window background color turns red.

Load **Zero** zeroes the live load and clears the peaks.

Distance (only displayed if the optional **Distance Measurement** function is installed)

Distance is displayed in the unit of measurement selected in Preferences. Press **Zero** to zero the distance reading.

6.3 Motion Control Modes

Jog Mode

The crosshead moves the specified distance each time **Up** or **Down** is selected. Three presets are available, as shown below:

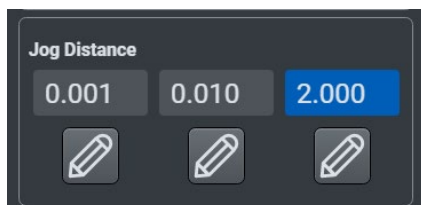

Select the desired preset. Select **Edit** to change the jog distance for the corresponding preset.

Momentary Mode

The crosshead will move only while selecting and holding down the **Up** or **Down** button. To set the speed, type the value into the box or drag the slider to the desired value, as shown below. The speed range depends on whether the optional **Low Speed Extension** and **High Speed Extension** options are activated.

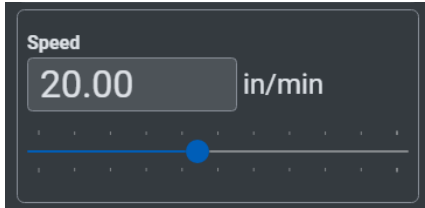

Maintained Mode

The crosshead will move continuously after selecting the **Up** or **Down** button. Set the speed in the same manner as **Momentary Mode**.

FollowMe® Mode

The crosshead responds to pushing or pulling on the force sensor's load cell shaft by hand. Increasing load produces greater speeds.



Exercise extreme caution when using FollowMe® with low-capacity force sensors, as overload can more easily occur.

If no load is detected for 5 seconds after selecting **FollowMe®**, the function deactivates.

6.4 Set Home







When **Manual Control** is accessed from an active test screen, instead of from the **Home Screen**, the **Set Home** button appears in the lower right corner, as follows:



Pressing this button establishes the current crosshead position as **Home**. Refer to subsequent sections for more details on how this position relates to test configurations.

7 CREATING A BASIC TEST

To create a basic test, press **New Test** on the **Home** screen, then select one of the following test types:

	Load Crosshead stops at a specified load limit.
	Distance / Limit Switch Crosshead stops at a specified distance limit (optional Distance Measurement function required) or limit switch. If Distance Measurement is not installed, the test is labeled as Limit Switch .
	Break (optional function) Crosshead stops when the sample breaks.
	Load Hold (optional function) Crosshead moves until a specified load, then maintains the load for a specified period of time.
	Cycle Test (optional function) Crosshead cycles a specified number of times between a selection of limit condition types.
	Averaging Crosshead stops at a specified time, load, or distance and calculates the average load.

Many of the configuration screens are common to each of the above tests. Full instructions are provided below for a **Load Test**. For other tests, instructions are provided only for their unique functions and settings.

7.1 Load Test

The test creation process is divided into three sections:

1. **Basic Settings**
2. **Data Collection & Results**
3. **Graphing**

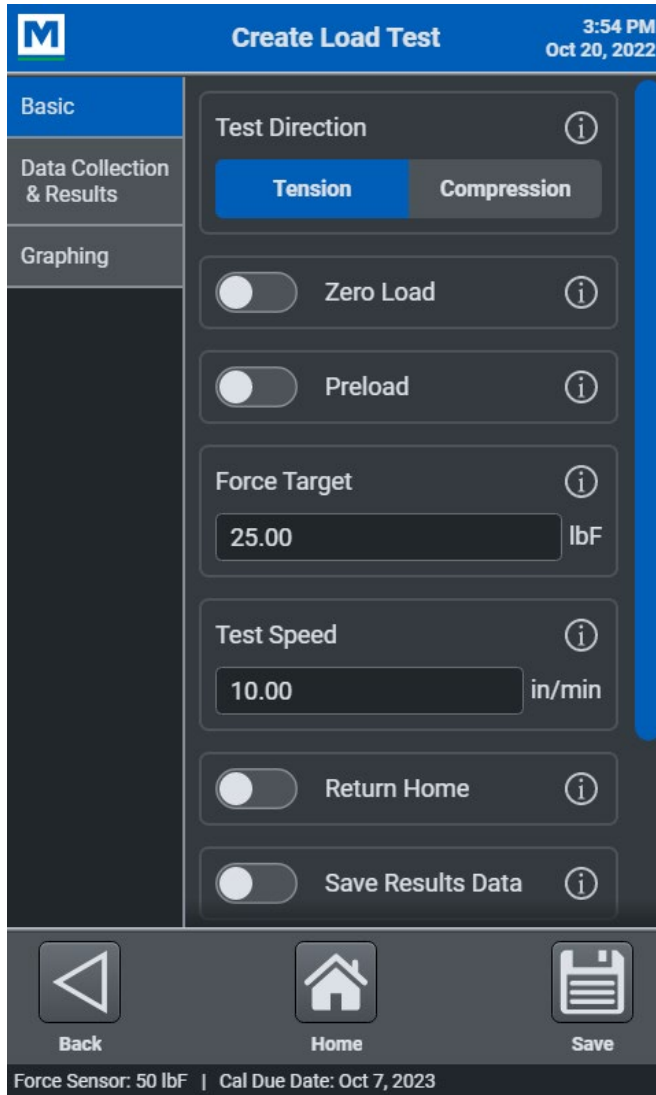

7.1.1 Basic Settings

Test Direction

Specify Tension (moving up) or Compression (moving down).

Zero Load

Zero the load value at the start of the run.

Preload

Zero the distance value upon contact with the sample, defined as a user-specified load. The speed of the crosshead as it approaches the preload target may be set independently of the **Test Speed**.

Load Target

The crosshead will stop when the specified load is reached.

Test Speed

The speed at which the crosshead travels. The speed range depends on whether the optional **Low Speed Extension** and **High Speed Extension** options are activated.

Return Home

At the completion of the test, the crosshead automatically returns at maximum speed to the **Home** position.

The **Home** position is initially established at the current crosshead location. To change this position, complete the test setup, open the test, then press **Manual Control** in the lower right corner of the screen. Then, move the crosshead to the desired position and press **Set Home**, in the lower right corner of the screen.

Save Results Data

Automatically saves results data for each run.

Save Run Data

Automatically saves the raw, continuous data for each run.

8.1.2 Data Collection & Results

Test Result

Select a result to save with the run. The result is displayed in the **Results** table and plotted in the graph if **Single Reading** mode is enabled. Viewing the **Results** table and graph requires the optional **Graphing & Reporting** function.

Final Distance (requires the optional **Distance Measurement** function)

The position at which the run ends.

Max Load

The maximum load which occurred during the run.

Pass / Fail Limits

Specify upper and lower acceptable limits for the selected result. A *Pass* or *Fail* indicator is present in the **Run** screen and **Results** table. Horizontal red dotted lines also appear in the graph. Viewing the **Results** table and graph requires the optional **Graphing & Reporting** function.

Data Collection Rate

Specifies the number of data points collected per second, applicable to plotting on the graph as well as calculating results such as Average load in an **Averaging** test.

Available range: 0.01 – 100 Hz

Stop Button Exception

When the **Stop** button is pressed before the run is complete, EasyMESUR flags the run as an *exception*. The result from this run will be considered invalid, and not included in statistical calculations (requires the optional **Graphing & Reporting** function).

7.1.3 Graphing

Show Graph

Display a graph for the test.

Graph Type

Select a graphing type:

Continuous

The graph plots one run continuously at the specified **Data Collection Rate**.

Single

Plots a single result for each run.

X-Axis

Select the data type for the X-axis of the graph – time or distance (requires the optional **Distance Measurement** function).

Start Plotting At

The graph will start plotting when one of the following thresholds is reached:

Time Delay

When the specified time has elapsed. To start plotting immediately, set this value to 0.

Load

When the specified load threshold is reached.

Distance (requires the optional **Distance Measurement** function)

When the distance threshold is reached.

This could be a positive or a negative value. Since the crosshead position can be zeroed at any location along the column, downward movement from the zero point is displayed as negative values, while upward movement is displayed as positive values.

Scope Mode

The graph will only display points within the specified buffer time.

For example, if the buffer time is set to 20 s, the graph will dynamically display only the most recent 20 s of data. Note that regardless of buffer setting, all run data is collected.

Invert Y-Axis

Inverts Y-axis data. Suggested for tension loads, which plot in the negative direction by default (compression loads are positive).

Invert X-Axis

Inverts X-axis data (distance only). Suggested for compression loads, which plot in the negative direction by default.

Upward or rightward motion is displayed as increasing distance values, while downward or leftward motion is displayed as decrementing values. If the movement continues past a distance of 0, a positive values becomes negative, and vice versa, as illustrated below:

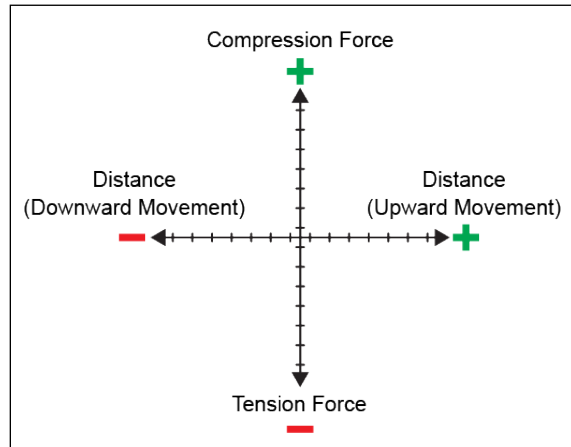

The most common method to plot a curve is to plot up and to the right. To achieve this trajectory, or other type of trajectory, data for each axis may be inverted to compensate for the plotting protocol mentioned above.

Example:

To plot a tension test up and to the right, invert the Y-axis (load), while leaving the X-axis un-inverted. Had the Y-axis not been inverted, increasing tension load would be displayed by a downward dipping plot, as illustrated below:

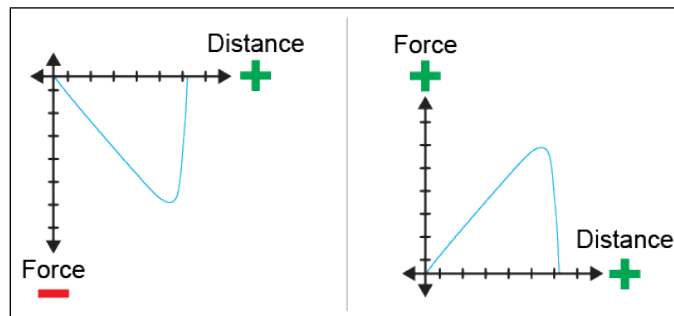

Press Next to save the test. The screen appears as follows:

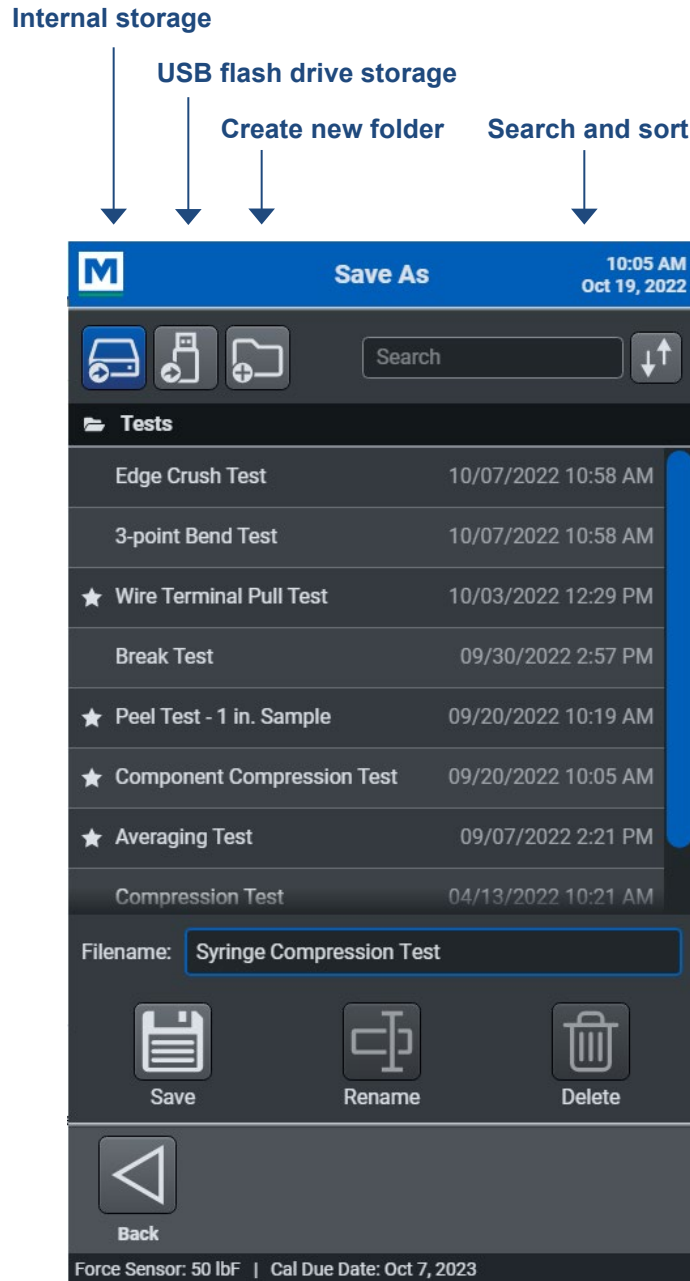

Select the desired file location – internal storage within the EasyMESUR control panel's hard drive or USB flash drive. Optionally create a new folder in which to save the file. Then, type a filename, and press **Save**. After saving, a prompt will allow the user to run the test or open it at a later time. For instruction on running a test, refer to the next section, **Running a Test**.

From this screen, it is also possible to rename or delete a file.

7.2 Distance Test / Limit Switch Test

If the optional **Distance Measurement** function is not installed, this test is labeled as “Limit Switch”, since the only target type is a limit switch.

7.2.1 Basic Settings

Same as in a **Load Limit** test, except for available target types:

Limit Switch

The crosshead will stop when it reaches the upper or lower limit switch.

Distance (requires the optional **Distance Measurement** function)

The crosshead will stop when it reaches the specified distance.

7.2.2 Data Collection & Results

Same as in a **Load Limit** test, except for available results:

Final Load

The load measured when the target was reached.

Max Load

The maximum load which occurred during the run.

7.2.3 Graphing

Same as in a **Load Limit** test.

Press Next to save the test, and proceed as instructed in a **Load Limit** test.

7.3 Break Test (optional function)

7.3.1 Basic Settings

Same as in a **Load Limit** test, except for parameters which define a break:

Load Threshold

The load threshold required for EasyMESUR to start monitoring for a break, defined as a percentage drop from the maximum load. Set this value lower than the anticipated breaking load, however, not too low as to trigger prematurely.

Break % Drop

EasyMESUR identifies a break when the load decreases to a specified percentage of the maximum load.

Example: If **Break % Drop** is set to 40% and the maximum load is 100 lbF, the crosshead will stop when the load drops to 60 lbF.

7.3.2 Data Collection & Results

Same as in a **Load Limit** test, except for available results:

Max Load

The maximum load which occurred during the run.

7.3.3 Graphing

Same as in a **Load Limit** test.

Press Next to save the test, and proceed as instructed in a **Load Limit** test.

7.4 Load Hold Test (optional function)

7.4.1 Basic Settings

Same as in a **Load Limit** test, except for parameters which define a load hold:

Load Target

The crosshead will stop at this specified load and automatically adjust in either direction to maintain the load for a specified period of time.

Hold Time

The amount of time the crosshead will maintain the load.

7.4.2 Data Collection & Results

Same as in a **Load Limit** test, except for available results:

Final Distance (requires the optional **Distance Measurement** function)

The position at which the run ends.

Max Load

The maximum load which occurred during the run.

7.4.3 Graphing

Same as in a **Load Limit** test.

Press Next to save the test, and proceed as instructed in a **Load Limit** test.

7.5 Cycle Test (optional function)

7.5.1 Basic Settings

Same as in a **Load Limit** test, except for parameters specific to a cycle test:

Cycle Type

Select one of the following cycle types. One cycle is defined as an up stroke followed by a down stroke, or a down stroke followed by an up stroke.

Cycles

Specify the number of cycles.

Time

Specify the amount of time to cycle.

7.5.2 Cycle Settings

Upper Target

Select the target type for the end of an upward stroke.

Load

Specify the load target. Indicate tension or compression by pressing the appropriate button.

Distance

Specify one of the following distance targets:

Limit Switch

The crosshead will stop when it reaches the upper or lower limit switch.

Distance (requires the optional **Distance Measurement** function)

The crosshead will stop when it reaches the specified distance.

Dwell Time

Specify the time the crosshead waits at a target between strokes.

Lower Target

Same parameters as **Upper Target**.

7.5.3 Data Collection & Results

Same as in a **Load Limit** test, except for available results:

Max Load

The maximum load which occurred during the run.

7.5.4 Graphing

Same as in a **Load Limit** test.

Press Next to save the test, and proceed as instructed in a **Load Limit** test.

7.6 Averaging Test

An averaging test measures the average load for a specified portion of the run. The following graph illustrates an example of a time-based averaging test with post-trigger delay:

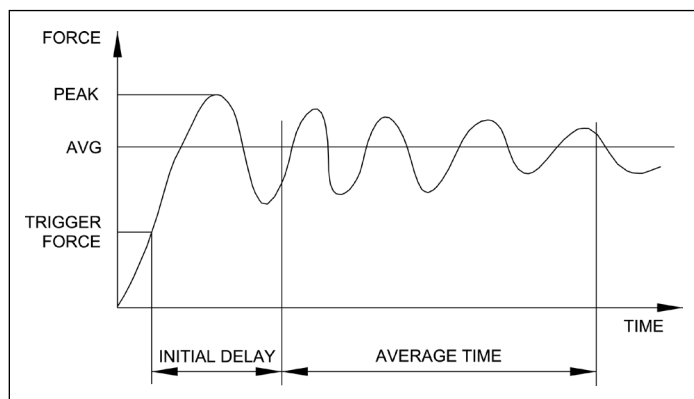
**7.6.1 Basic Settings**

Averaging settings are the same as in a **Load Limit** test, except for parameters specific to an averaging test:

Trigger Load

The minimum load required to start the averaging sequence. To start averaging immediately, set this value to zero.

Post-Trigger Delay

An initial delay may be configured, for example to omit the initial load spike at the beginning of a peel test. To start averaging immediately after the **Trigger Load**, set this value to zero.

Stop Condition

Stop averaging when one of the following conditions is met:

Time

Specify a period of time, in seconds.

Load

Specify a load.

Distance

Specify one of the following distance conditions:

Limit Switch

The crosshead will stop when it reaches the upper or lower limit switch.

Distance (requires the optional **Distance Measurement** function)

The crosshead will stop when it reaches the specified distance.

7.6.2 Data Collection & Results

Same as in a **Load Limit** test, except for available results:

Average Load

The average load which occurred during the run.

7.6.3 Graphing

Same as in a **Load Limit** test.

Press Next to save the test, and proceed as instructed in a **Load Limit** test.

8 OPENING AND RUNNING A TEST

8.1 Favorite Tests

Saved tests may be designated as favorites, for quick access when selecting **Open Test** from the **Home** screen. The screen appears as follows:

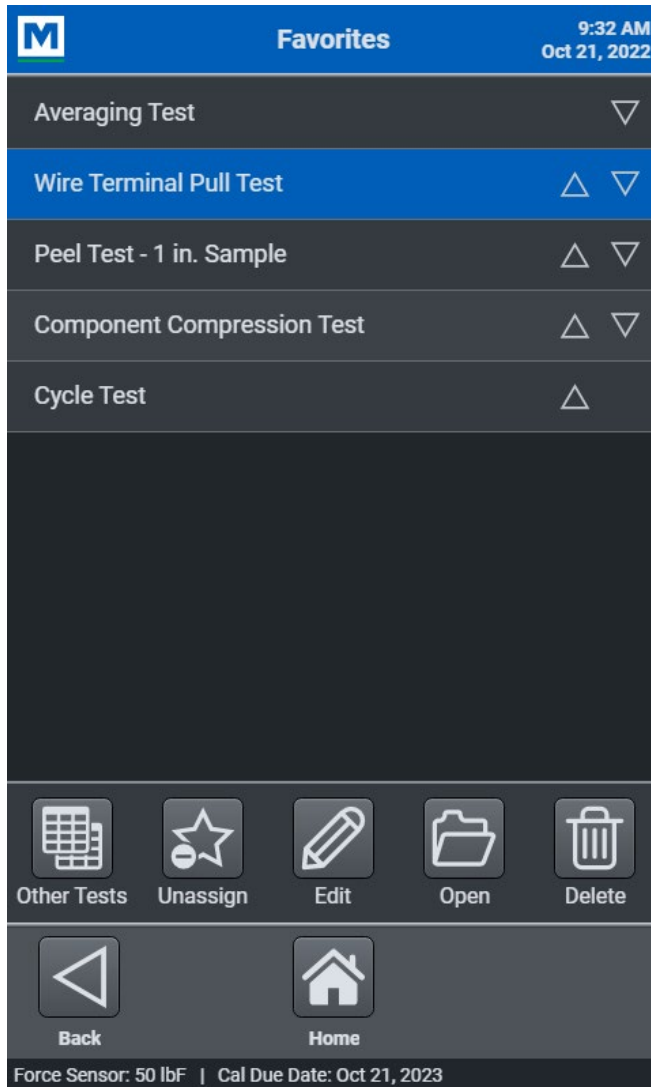

The list of tests may be rearranged by using the up and down arrows. To view additional tests, press **Other Tests**.

To remove a test from the **Favorites** list, edit the test, open the test, or delete the test, highlight the test name first, then press the button corresponding to the desired function.

8.2 Other Tests

Press **Other Tests** to view a complete list of all tests. The screen appears as follows:

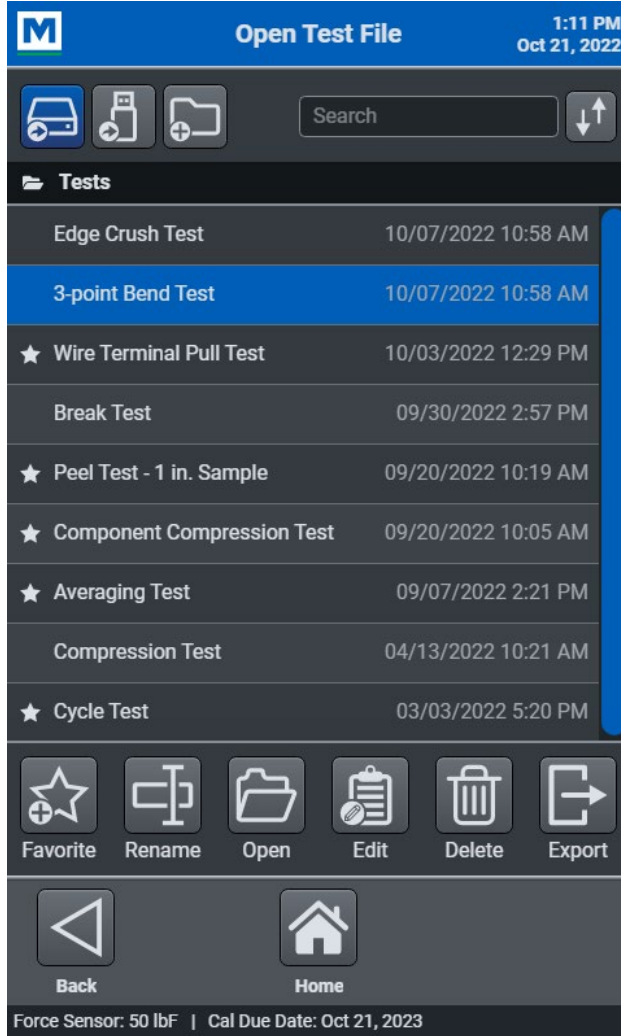

Select the desired file location – internal storage within the EasyMESUR control panel or USB flash drive. Optionally create a new folder in which to save an imported file.

First press the test name, then perform any of the functions at the bottom of the screen:

Favorite / Unassign

Add the test to the **Favorites** list or unassign it from the list. A favorite test is noted with a star to the left of the file name.

Rename

Rename the test.

Open

Open the test.

Edit

Edit the parameters of the test.

Delete

Delete the test.

Export / Import

Save the test file onto a USB flash drive or import a test file from a USB flash drive. Imported files may be saved to a new folder by pressing **New Folder** and specifying the folder name.

8.3 Running a Test

Upon opening a test, the screen appears as one of the following:



8.3.1 Running a Load vs. Distance Test with Graphing

This example view includes Load, Distance, a graph of Load vs. Distance, and Pass / Fail limits enabled. The **Distance Measurement** option is installed.

Status Bar

Along the top of the screen, a notification bar displays the current status of the system, such as moving up or down, stopped, ready, overload, or other information.

Load and Distance Measurements

Load and Distance are displayed in the units of measurement selected in **Preferences**.

Within the Load window, the maximum compression or tension value is always displayed above the current reading, corresponding to the test direction.

The load bar is displayed underneath the current reading, and operates the same way described in the **Manual Control** section.

Manual Control

Before starting the test, the user may want to adjust the position of the crosshead to an appropriate starting position. To do so, press **Manual Control**, then adjust the crosshead, zero the values, and set the **Home** position as needed, as described in the **Manual Control** section.

Start and Stop

To start the test, press the green **Start** button. The test will proceed as specified in the test setup. To stop the test before it has completed, press the red **Stop** button.

If the **Stop** button was pressed before the test completed, the results of this run are considered invalid, and marked as an “exception” in the Pass / Fail indicator area, as well as in the **Results** table.

If the crosshead reaches a limit switch before reaching a non-limit switch target, the run will be marked as an “exception”.

Graph

The graph is displayed according to the configuration specified in the test setup. Possible configurations are as follows:

Continuous Graph of Load vs. Distance or Load vs. Time

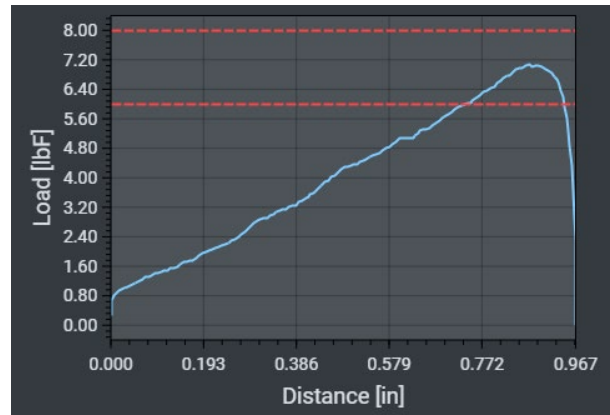

The red dashed lines represent the upper and lower pass / fail limits.

Single Point Readings for Load Only or Load vs. Distance

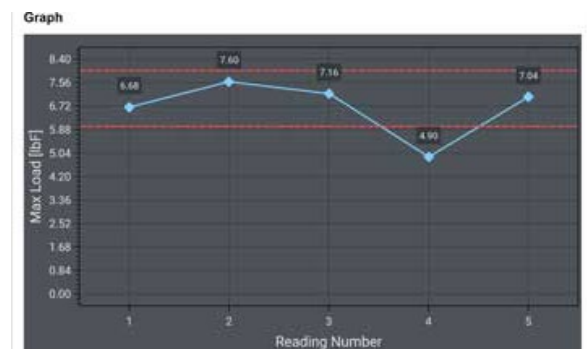

The graph above contains single points pertaining to maximum values from five separate runs. Pass / fail lines help to visually identify failures.

Return to Home

If the test was not configured to automatically return to the **Home** position, or if the test was stopped prematurely, press this button to manually return to **Home**.



Results

Go to the **Results** view. Refer to the next section for instructions.

8.3.2 Running a Load vs. Distance Test without Graphing

This example view includes Load and Distance, without a graph. Either the **Distance Measurement** option is not installed, or graphing was not enabled in the test setup. In this example, Pass / Fail limits are not enabled.

All other features and functions are the same as described in the previous section.

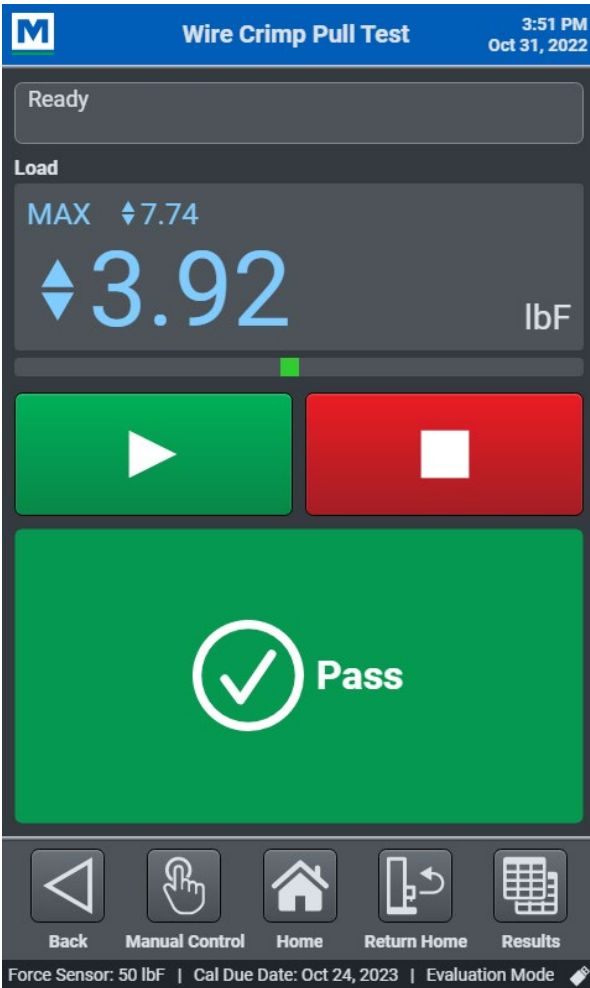

8.3.3 Running a Load Test without Graphing

This example view includes Load only, without a graph. Either the **Distance Measurement** option is not installed, or graphing was not enabled in the test setup. In this example, Pass / Fail limits are enabled.

All other features and functions are the same as described in the previous section.

8.4 Results (requires the optional Graphing & Reporting function)

Press **Results** to view a table of results for each test run and continuous data from the most recent run.

The default view is **Run Results**. Press either **Run Results** or **Last Run**, and switch views as needed.

Data may be saved, exported, or converted into a report. The screens appear as follows:

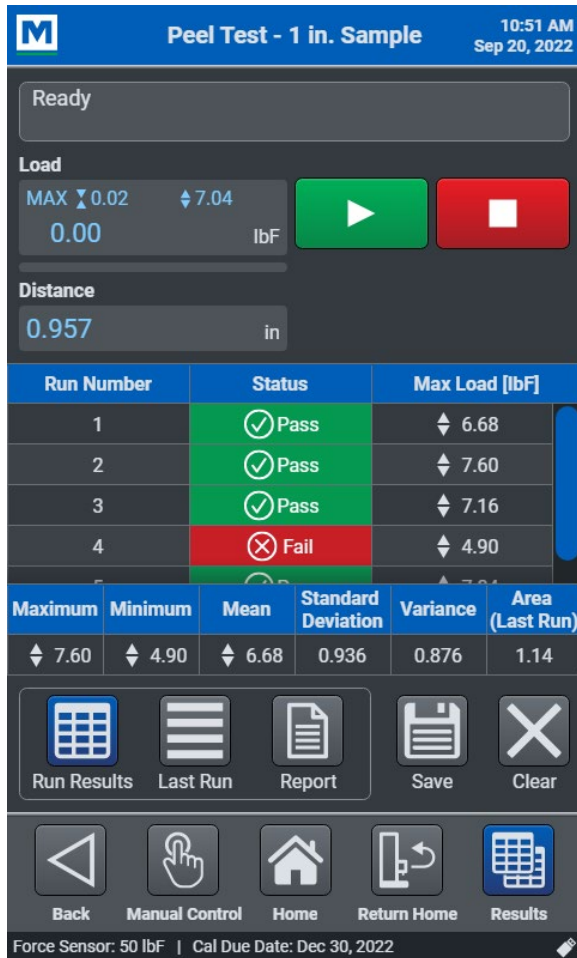

8.4.1 Run Results (Results Table)

This example view includes Load and Distance. Pass / Fail limits are enabled. The **Distance Measurement** option is installed.

The table displays the run number, pass / fail / exception status, and result. In the example at left, **Maximum Load** is displayed for a batch of peel tests.

Statistics

Statistics for the results are displayed below the Results table. "Area" refers to the area under the curve for the most recent run.

Note: Result for runs marked as "exception" are not included in the statistical calculations.

Save

Save the results to internal storage within the EasyMESUR control panel or export a .csv file to a USB flash drive. An example .csv file opened in *Excel* appears as follows:

	A	B	C	D	E	F	G
1	Peel Test - 1 in. Sample						
2							
3	System Information:						
4	EasyMESUR Version: 1.0.0						
5	Test Frame Model: F305						
6	Test Frame Serial Number: 4144714						
7	Test Frame Capacity: 300 lbF / 4800 ozF / 150 kgF / 1500 N / 1.5 kN						
8	Test Frame Firmware Version: 1.09.09						
9	Force Sensor Model: FS05-50						
10	Force Sensor Serial Number: 4081158						
11	Force Sensor Capacity: 50 lbF / 800 ozF / 25 kgF / 25000 gF / 250 N						
12	Force Sensor Calibration Date: Dec 30, 2021						
13	Force Sensor Calibration Due Date: Dec 30, 2022						
14							
15	Run Num	Status	Max Load [lbF]				
16	1	Pass	6.68				
17	2	Pass	7.6				
18	3	Pass	7.16				
19	4	Fail	4.9				
20	5	Pass	7.04				
21							
22	Maximum	Minimum	Mean	Std. Devia	Variance	Area Under Curve	
23	7.6	4.9	6.68	0.94	0.88	33.4	
24							

Results can be recalled by going to the **Home** screen, then selecting **Recall Test Data**.

Clear

Clear the data from the screen. The values will not be saved.

Other Features

The status bar, measurements, start / stop functions, and functions along the bottom of the screen are the same as in other views.

Peel Test - 1 in. Sample			
			9:41 AM Oct 24, 2022
Reading Number	Time [s]	Load [lbF]	Distance [in]
41	0.41	6.84	2.339
42	0.42	7.02	2.341
43	0.43	7.16	2.342
44	0.44	7.38	2.344
45	0.45	7.54	2.347
46	0.46	7.66	2.349
47	0.47	7.90	2.351
48	0.48	8.02	2.354
49	0.49	8.00	2.356
50	0.50	8.08	2.359
51	0.51	8.06	2.361
52	0.52	8.08	2.364
53	0.53	8.08	2.366
54	0.54	8.20	2.369
55	0.55	8.22	2.372



Run Results

Last Run

Report

Save

Clear

Back

Manual Control

Home

Return Home



Results

Force Sensor: 50 lbF | Cal Due Date: Oct 21, 2023

8.4.2 Last Run

The table displays the reading number and associated elapsed time, load, and distance values (if the optional **Distance Measurement** function is installed).

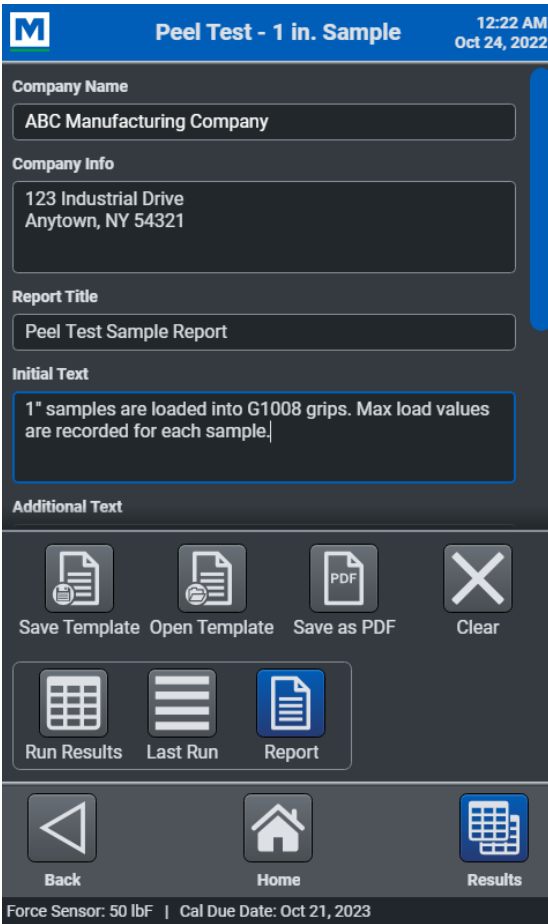
Save and clear data from the table in the same manner as **Run Results**.



M Peel Test - 1 in. Sample 12:22 AM
Oct 24, 2022

Company Name
ABC Manufacturing Company

Company Info
123 Industrial Drive
Anytown, NY 54321

Report Title
Peel Test Sample Report

Initial Text
1" samples are loaded into G1008 grips. Max load values are recorded for each sample.

Additional Text

Save Template Open Template Save as PDF Clear

Run Results Last Run Report

Back Home Results

Force Sensor: 50 lbf | Cal Due Date: Oct 21, 2023

^ Report template setup

8.4.3 Report

A report may be created, containing the results, graph, equipment used, and other pertinent information.

Press **Report** to access the report creation template. The report template appears as shown at left.

Create a template by filling out any of the following information:

- Company Name
- Company Info
- Report Title
- Initial Text
- Additional Text
- Conclusion Text
- Include: System Information, Results, Graph

System Information consists of the following:

- EasyMESUR software version
- Test frame model number
- Test frame force capacity
- Test frame serial number
- Test frame firmware version
- Force sensor model number
- Force sensor force capacity
- Force sensor serial number
- Force sensor previous calibration date
- Force sensor next calibration date

Press **Save Template** to save this information into a template for future access. Press **Clear** to clear all fields and selections.

Reports may be saved as a .pdf file. Press **Save as PDF**, then save the results to internal storage within the EasyMESUR control panel or to a USB flash drive.

An example .pdf report is shown at left.

ABC Manufacturing Company
123 Industrial Drive
Anytown, NY 54321

Peel Test Sample Report

Peel Test - 1 in. Sample

1" wide samples are loaded into G1008 grips. Max load values are recorded for each sample.

System Information:

EasyMESUR Version: 1.00.00
Test Frame Model: F305
Test Frame Serial Number: 4144714
Test Frame Capacity: 300 lbF / 4800 ozF / 150 kgF / 1500 N / 1.5 kN
Test Frame Firmware Version: 1.09.09
Force Sensor Model: FS05-50
Force Sensor Serial Number: 4081158
Force Sensor Capacity: 50 lbF / 800 ozF / 25 kgF / 25000 gF / 250 N
Force Sensor Calibration Date: Dec 30, 2021
Force Sensor Calibration Due Date: Dec 30, 2022

Results

Run Number	Data Context	Status	Max Load [lbF]
1	Load	⊙ Pass	6.68
2	Load	⊙ Pass	7.60
3	Load	⊙ Pass	7.16
4	Load	⊙ Fail	4.90
5	Load	⊙ Pass	7.04

Statistics

Maximum	Minimum	Mean	Standard Deviation	Variance	Area Under Curve
7.60	4.90	6.68	0.936	0.876	33.38

Graph

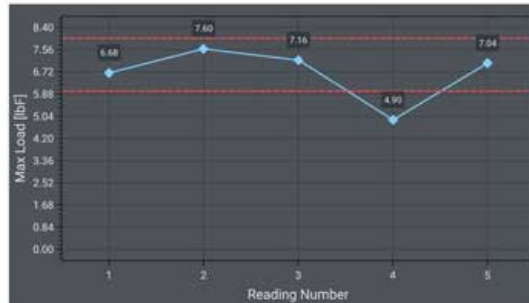

The tests were completed successfully.

^ .pdf report

9 PC CONTROL

Series F test frames can be controlled by a third-party custom software application, largely bypassing the EasyMESUR control panel. Mark-10 publishes a library of serial commands which may be used for motion control and data collection. While PC Control is active, users only have access to the Manual Control screen in EasyMESUR.

Note: PC control requires the optional **PC Control** function. The USB-C port for a flash drive is disabled during PC control.

9.1 Configuration

1. Set the baud rate under Preferences to match the setting on the PC.
2. Connect a USB cable from the rear of the test frame to the PC.
3. Install the Mark-10 USB driver, downloadable from the Mark-10 website, www.mark-10.com > Resources > Software & Driver Downloads > Mark-10 USB Driver - Windows.
4. From the **Home** screen, select **PC Control**. The screen appears as follows:



PC Control is now active. Only manual controls are possible through EasyMESUR until exiting **PC Control** mode by pressing **Back**.

9.2 Command Set

A list of supported ASCII commands is provided below.

Note: All commands are a fixed format and do not require a terminating character. Responses from request commands are terminated with a CR-LF pair. (CR = 0xD, LF = 0xA)

Command	Description	Example
a	Request speed	
b	Set travel unit to inches	
c	Enter cycle mode	
d	Move crosshead down or left	
e	Set speed	
	Inch format: eXX.XX Two leading zeroes and two decimal places required.	e02.85 = 2.85 in/min
	Millimeter format: eXXXX.X Four leading zeroes and one decimal place required.	e0200.3 = 200.3 mm/min
f	Set cycles. Format: fXXXX (leading zeroes required)	f0500 = 500 cycles
g	Set lower travel limit	
	Inch format: g-XX.XXX Negative sign (if applicable), two leading zeroes, and three decimal places required.	g-00.550 = -0.55 in g01.258 = 1.258 in
	Millimeter format: g-XXX.XX Negative sign (if applicable), three leading zeroes, and two decimal places required.	g-007.52 = -7.52 mm g010.70 = 10.7 mm
h	Set upper travel limit	
	Inch format: h-XX.XXX Negative sign (if applicable), two leading zeroes, and three decimal places required.	h-00.550 = -0.55 in h01.258 = 1.258 in
	Millimeter format: h-XXX.XX Negative sign (if applicable), three leading zeroes, and two decimal places required.	h-007.52 = -7.52 mm h010.70 = 10.7 mm
i	Set travel unit to millimeters	
j	Set crosshead speed to maximum speed	
k	Set crosshead speed to minimum speed	
l	Enter travel limit mode ¹	
m	Enter manual mode	
n	Transmit travel and load readings	
o	Set crosshead speed to programmed speed	
p	Request test frame status ²	
q	Request number of cycles completed	
r	Request number of cycles set	
s	Stop crosshead	
t	Reset cycle counter to zero	
u	Move crosshead up or right	
v	Request upper travel limit	
w	Request lower travel limit	
x	Request travel value	
z	Reset position to zero	
A	Displays current unit	
F	Toggles between Normal and Data Collect modes	
P	Steps through Normal mode, Tension Peak mode, and Compression Peak mode	
R	Zeroes the instrument (zeroes all modes)	
S	Sends current mode (Normal, Tension Peak, Compression Peak, or Data Collect)	
U	Steps through units	
X or ?	Sends currently displayed reading	
Y	Enables RS-232 output and sends continuous data stream when in Data Collect mode	
Z	Zeroes the peak values	

1. If travel limit mode is disabled, the crosshead will only stop at limit switches. Load and distance limits are ignored.
2. The transmission of ASCII "p" will return the test frame status. The following are the return codes and their definitions (upper case):

	Response	Description
Crosshead status	U	Crosshead moving up
	D	Crosshead moving down
	S	Crosshead stopped
Operating mode	C	Cycle mode
	L	Limit mode
	M	Manual mode
Limit switch status	UL	Crosshead at upper limit
	DL	Crosshead at lower limit

The command set is compatible with legacy Nexygen™ TCD software (not available from Mark-10).

Note: Series F test frames do not respond to Mark-10 force gauge commands which may be present in a legacy application (Mark-10 commands are denoted with a forward slash "/" (no quotations), followed by the commands, followed by a back slash "\").

10 CALIBRATION

10.1 Force Sensor Calibration

Mark-10 recommends calibrating force sensors at least once per year. Series FS05, FS06, and R07 force sensors may be calibrated while installed on a Series F test frame, or may be removed the frame and calibrated with a Mark-10 Model M5I or Model M7I indicator.

10.1.1 Calibrating on a Series F Frame

1. Using **Manual Control**, move the crosshead high enough to accommodate calibration fixtures and equipment.

A master load cell should be mounted to the test frame and interface with the force sensor, along with appropriate mounting brackets and fixtures. Compression and tension springs are recommended. Caution should be taken while handling such equipment.

2. Select **Calibration** from the **Settings** screen. The screen appears as follows:

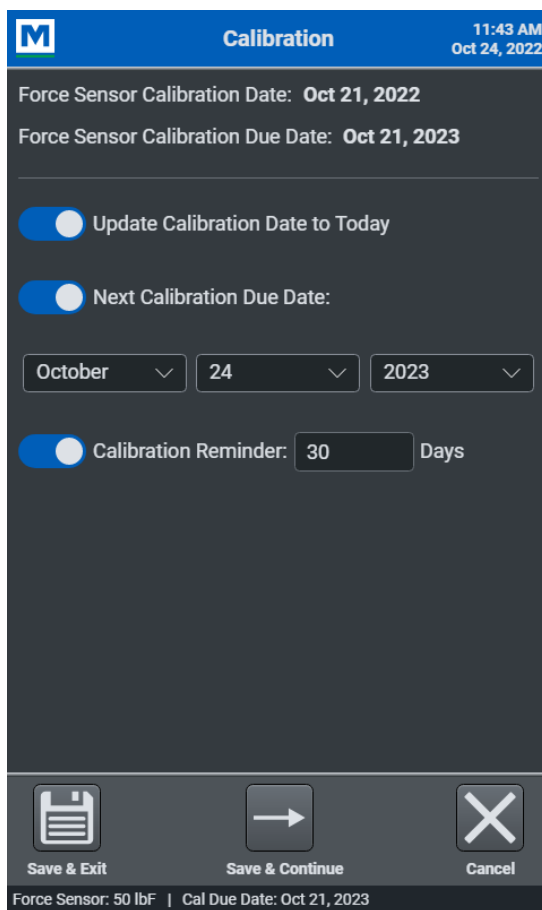

The previous **Force Sensor Calibration Date** and **Due Date** are displayed at the top.

To update the calibration date to today's date, press **Update Calibration Date to Today**, then set the **Next Calibration Due Date** as desired. The calibration date may be updated regardless of whether calibration takes place. This accounts for situations in which the force sensor accuracy has been verified to within specification and re-calibration is not necessary. Note that the due date may be modified regardless of whether the calibration date was updated.

Optionally configure a **Calibration Reminder**, in days.

To save the settings and return to the **Home** screen without calibrating, press **Save and Exit**. To continue with calibration, press **Save & Continue**.



The calibration date is intended for informational purposes only. Because it may be modified independently of the actual calibration, it should not be relied upon as evidence of successful calibration.

3. After pressing **Save & Continue**, the first screen of the calibration wizard appears as follows:

Calibration instruction

Crosshead motion control

Crosshead motion controls are similar to those in **Manual Control**. They are available through all calibration steps to apply the required load. **FollowMe** mode may not be used in steps requiring the application of load; it can only be used in crosshead positioning steps.



For finest control, and to help prevent an overload, **Momentary** mode is recommended. Start with a slow rate of speed.

The force sensor can be calibrated at up to 10 points in each direction. Enter the number of calibration points for each direction (tension and compression). At minimum, the sensor must be

calibrated at full scale in both directions.

Note: To achieve highest possible accuracy, it is recommended to calibrate the force sensor at five or more even intervals in both tension and compression directions. For example, an FS05-10 force sensor (10 lbF max) should be calibrated at 2, 4, 6, 8, and 10 lbF loads in each direction.

Press **Start**.

4.

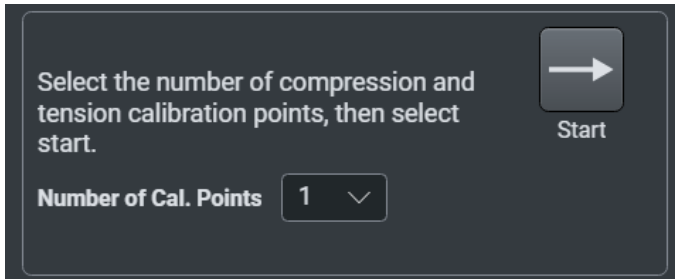

Select the number of calibration points in each direction, then press **Start**.

5.

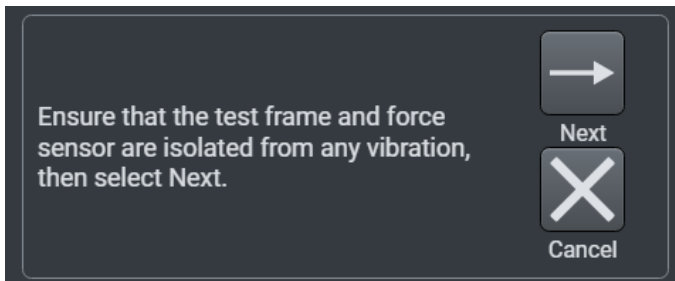

Ensure that the equipment is isolated from any vibration, then press **Next**. Press **Cancel** at any time to exit Calibration without saving calibration data.

6.

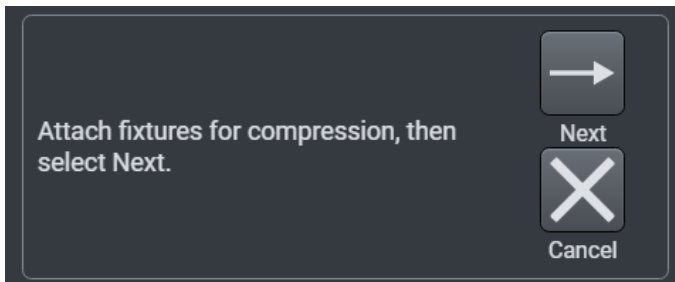

Attach fixtures to enable compression loading, then press **Next**.

7.

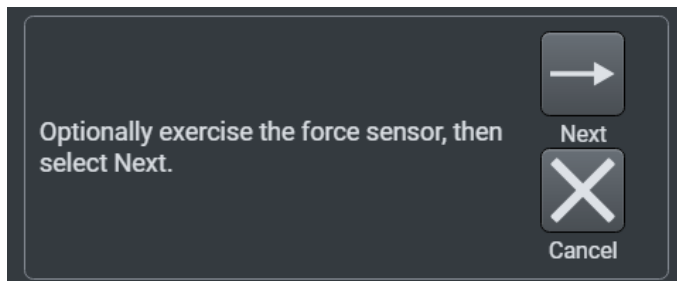

Optionally load and unload the force sensor to full scale several times, then press **Next**.

8.

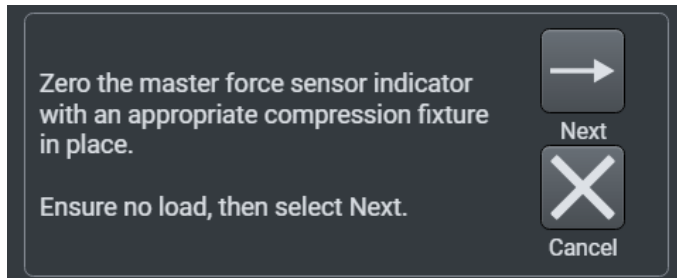

Zero the indicator associated with the master load cell. Engage the calibration fixtures, and ensure that there is no load applied to the force sensor. Then press **Next**.

9.

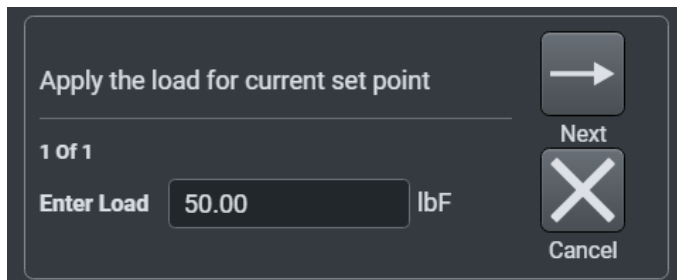

Apply the indicated compression load using the **crosshead motion controls**. The load value defaults to even intervals. For example, for a 50 lbF force sensor with five calibration points, the first default load value is 10 lbF. All load values may be edited by up to $\pm 20\%$.

Press **Next**. Follow the same procedure for all required loads.

10. After the final compression load, the screen appears as follows:

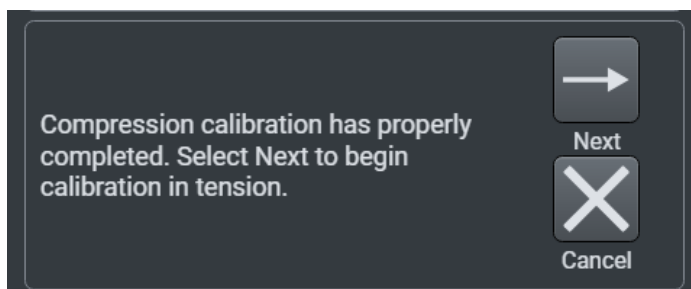

11.

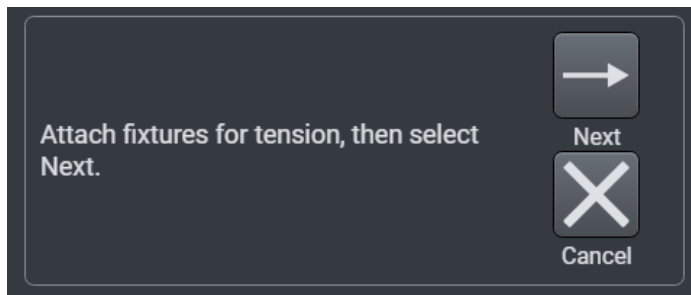

Configure the calibration fixtures and equipment for tension loading. Then press **Next**.

12. Subsequent steps are the same as in compression:

- Exercise the force sensor
- Install necessary fixtures
- Apply the required loads

13. When tension calibration is complete, the screen appears as follows:

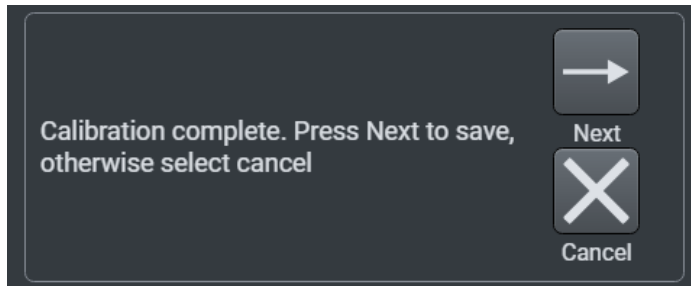

Press **Next** to complete the calibration and save the calibration data to the force sensor.

10.1.2 Calibrating with a Mark-10 Indicator

Series FS05, FS06, and R07 force sensors may be removed and calibrated in a different location with a Mark-10 model M5I or M7I indicator with minimum firmware version of 2.2.8.

Series R07 force sensors plug directly into an indicator via its Plug & Test® connector, as shown below:



Series FS05 and FS06 force sensors require an adapter part no. AC1083 to plug into an indicator, as shown below:



The optional extension cable part no. AC1084 can be useful in addition to AC1083 where the indicator cannot be positioned close to the force sensor.

For calibration instructions, refer to the indicator's user's guide.

10.2 Speed and Distance Calibration

Mark-10 recommends verification of speed and distance accuracy once per year. Note that no adjustments may be made. Calibration is offered by Mark-10, as well as certain distributors and third-party laboratories.

11 MAINTENANCE & SERVICE – MODELS F105 / F305 / F505 / F505H

11.1 Physical Maintenance

Series F test frames should be operated in a dry and clean area. Under these circumstances the main consideration is lubrication of the ball screw and slider. Periodic lubrication improves performance and increases the longevity of test frame components.

11.1.1 Ball screw lubrication – twice per year

Ball screw lubrication frequency should increase if the frame is operated in adverse environmental conditions, including airborne dust, temperature and humidity extremes, and other factors. Follow these instructions:

1. Remove the upper and lower bellows to expose the ball screw, by separating the Velcro strips at each end of the crosshead. Velcro locations are identified in the image below:



2. Using a brush, apply a small amount of general-purpose bearing grease to the screw, as shown in the image below:



3. Cycle the crosshead up and down several times until the newly applied grease has been spread evenly over the length of the screw.
4. Re-install the bellows.

11.1.2 Slider lubrication – once per year

Slider lubrication frequency should increase when used in in adverse conditions. Follow these instructions:



Two people are recommended for this procedure, due to the risk of tipping.

1. Flip the test frame upside down, as shown below. Be sure to do this on a flat and secure working surface.



2. While one person is supporting the column, the other person removes six screws from the underside of the base of the test frame, as shown below:



3. Remove the base, then remove the two screws on the right, as shown below:

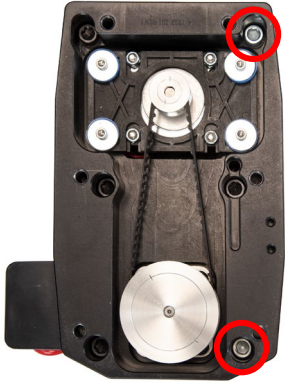

4. Remove the Mark-10 logo strip, then remove all screws from the side of the test frame, as shown below:



5. Locate the grease receptacle on the slider, as identified below:

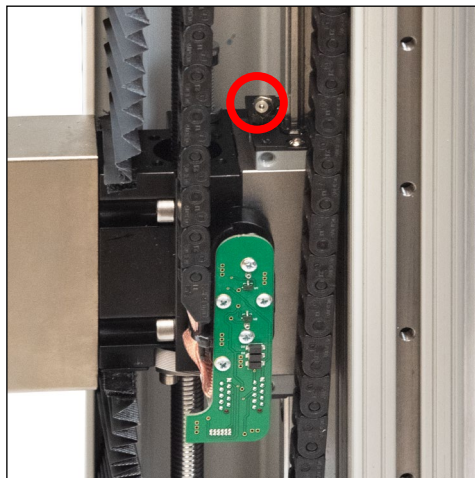

- Using a grease gun, add general purpose bearing grease to the inside of the slider until full. Wipe clean any spillage. Refer to the image below:

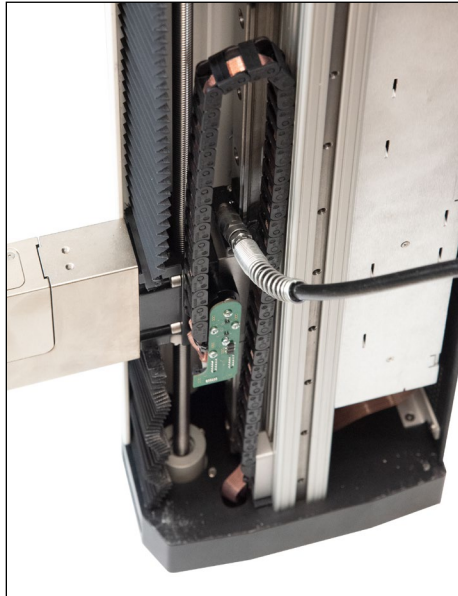

- Cycle the crosshead up and down several times until the newly applied grease has been spread evenly over the length of the slide.
- Re-assemble by repeating steps 1 through 4 in reverse.

11.1.3 Check for loosened grips and attachments – daily

Check to ensure that the grips attached to the force sensor and base plate are firmly secured. Looseness could result in a potentially hazardous situation.

11.1.4 Check for loosened components – once per month

- Remove the test sample from the test frame.
- Attempt to loosen subcomponents of the test frame (ex. fasteners, brackets, etc.). All components should be firmly attached. If any looseness is detected, stop using the test frame and contact Mark-10 or a distributor for instructions.

11.2 Removing the Motor Drive Unit (MDU)

The MDU is the self-contained location of most of the test frame's electronics, and is designed for quick removal and replacement in the event of service or repair. If requested by Mark-10 or a distributor to remove and/or replace the MDU, follow these instructions:

1. Disconnect power to the test frame.
2. Remove the screws from the rear panel, then remove the panel.
3. When the MDU is accessible, disconnect the four connectors and ground wire identified in the image below. To more easily access the ground wire, loosen one of the screws connecting the T-shaped bracket to the base, and swing it around.
4. Partially loosen the four screws securing the MDU to the frame, lift the MDU up slightly, and pull out, as shown in the image below-right. Reinstall in the same fashion.

Locations of connectors, ground wire, and bracket



Removing the MDU



12 MAINTENANCE & SERVICE – MODELS F1505 / F1505S / F755 / F755S

12.1 Physical Maintenance

Series F test frames should be operated in a dry and clean area. Under these circumstances the main consideration is lubrication of the ball screw and slider. Periodic lubrication improves performance and increases the longevity of test frame components. On average, lubrication is recommended twice per year. However, the frequency should increase if the frame is operated in adverse environmental conditions, including airborne dust, temperature and humidity extremes, and other factors.

12.1.1 Ball screw lubrication

Follow these instructions for proper ball screw lubrication:

1. Remove the upper and lower bellows to expose the ball screw, by separating the Velcro strips at each end of the crosshead. Velcro locations are identified in the image below:



2. Using a brush, apply a small amount of general-purpose bearing grease to the screw, as shown in the image below:



3. Cycle the crosshead up and down several times until the newly applied grease has been spread evenly over the length of the screw.
4. Re-install the bellows.

12.1.2 Slider lubrication

As with the ball screw, periodic lubrication of the slider improves performance and increases the longevity of test frame components. Frequency depends on environmental conditions and usage.

Follow these instructions for proper slider lubrication:

1. Lay the test frame on its side on a flat and secure working surface. Exercise caution while doing so, as the test frame is heavy.
2. Remove the upper and lower bellows to expose the slider, as per the instructions above.
3. Locate the grease receptacle on the slider, identified in the below image:

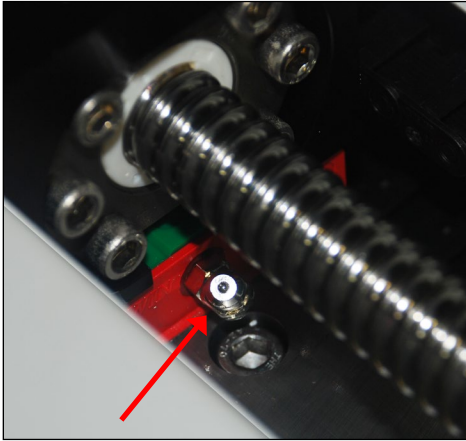

4. Using a grease gun, add general purpose bearing grease to the inside of the slider until full. Wipe clean any spillage. Refer to the image below:

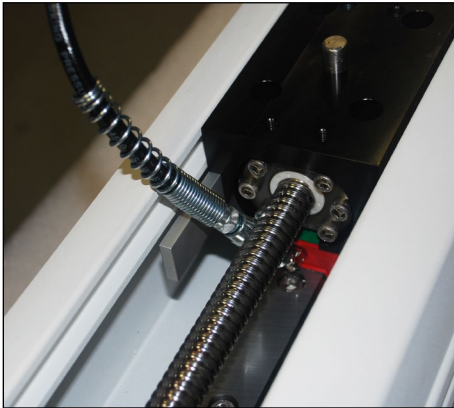

5. Cycle the crosshead up and down several times until the newly applied grease has been spread evenly over the length of the slide.
6. Re-install the bellows.

12.1.3 Check for loosened grips and attachments – daily

Check to ensure that the grips attached to the force sensor and base plate are firmly secured. Looseness could result in a potentially hazardous situation.

12.1.4 Check for loosened components – once per month

1. Remove the test sample from the test frame.
2. Attempt to loosen subcomponents of the test frame (ex. fasteners, brackets, etc.). All components should be firmly attached. If any looseness is detected, stop using the test frame and contact Mark-10 or a distributor for instructions.

12.2 Removing the Motor Drive Unit (MDU)

The MDU is the self-contained location of most of the test frame's electronics, and is designed for quick removal and replacement in the event of service or repair. If requested by Mark-10 or a distributor to remove and/or replace the MDU, follow these instructions:

1. Disconnect power to the test frame.
2. Remove the screws from the lower rear panel.
3. When the MDU is accessible, disconnect the four connectors and ground wire identified in the image below.
4. Partially loosen the four screws securing the MDU to the frame, lift the MDU up slightly, and pull out, as shown in the image below-right. Reinstall in the same fashion.

Locations of connectors and ground wire



Removing the MDU



13 ACCESSORY INSTALLATION

13.1 Installing the External Emergency Switch Connector

When a shield is used, the standard emergency stop switch is located within the enclosure, preventing its use during a test. An external limit switch is, therefore, included with Mark-10 shields.

For all Series F test frames, the connector must be installed in the rear of the MDU. It may be factory-installed if ordered at time of order (reference part no. 09-1315), or installed by the customer in the field (reference part no. 09-1315-1). Follow these instructions for field installation:



This process involves handling sensitive electronic components. We recommend proceeding only if you have experience working with electronics. Mark-10 offers a factory retrofit.

1. Remove the MDU as instructed in previous sections.
2. Punch out the opening below the label, "External Emergency Switch", as highlighted below:



3. Remove the back panel from the MDU housing with the four screws, highlighted below:



4. Route the two wires from the rear of the connector through the hole, as shown below:



5. Connect the two cables to the white mating plug, as shown below:

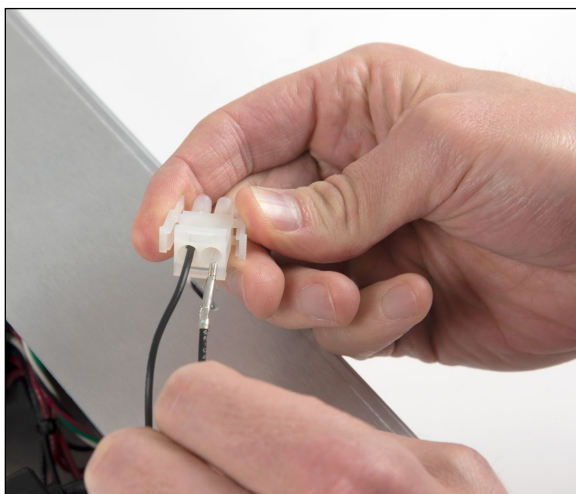

6. Install the connector to the housing by inserting the spacer over the body of the connector, then tightening the nut, as shown below:

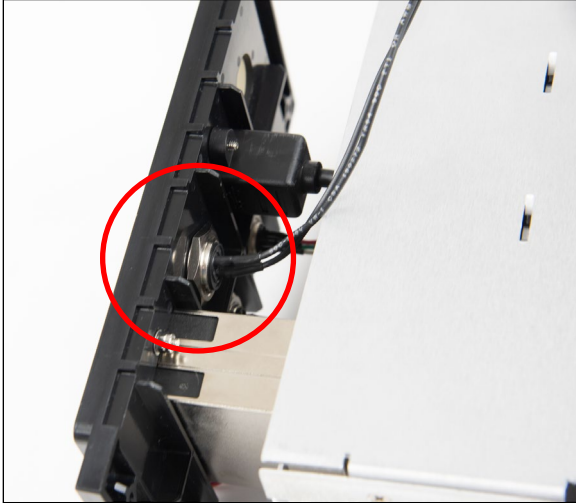

7. Reassemble the MDU and reinstall, as instructed in earlier sections.
8. Connect the cable from the remote emergency stop switch.

13.2 Separating the Column From The Base / Column Extension Installation – F105 / F305 / F505 / F505H

The column may be separated from the base to accommodate alternative mounting arrangements, for considerations such as safety, increased sample clearance, integration into existing equipment, etc.

13.2.1 Removing the base from the column

To remove the base, follow these instructions:

1. Power off the test frame and disconnect the power cable.
2. Lay the test frame on its side and remove the six screws from the underside of the base. Carefully remove the base from the frame. Refer to the image below:

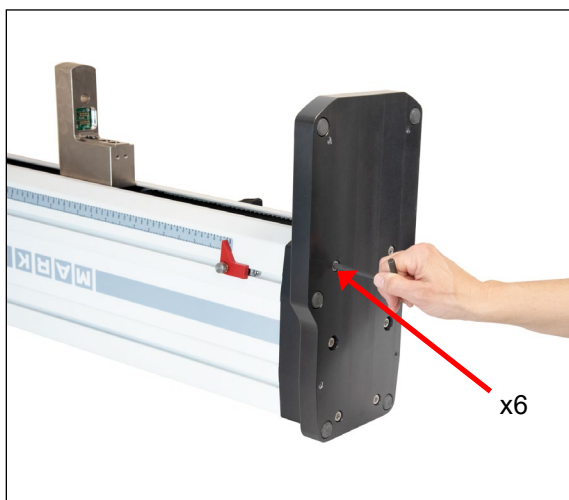

13.2.2 Retrofitting a Mark-10 AC1094-1 / -2 / -3 single column extension (optional)

If a single column extension is ordered upfront, it is pre-installed at the factory and shipped assembled. To retrofit in the field, follow these instructions:

1. Remove the two sheet metal covers from the column extensions by loosening the 16 screws, as identified in the images below:

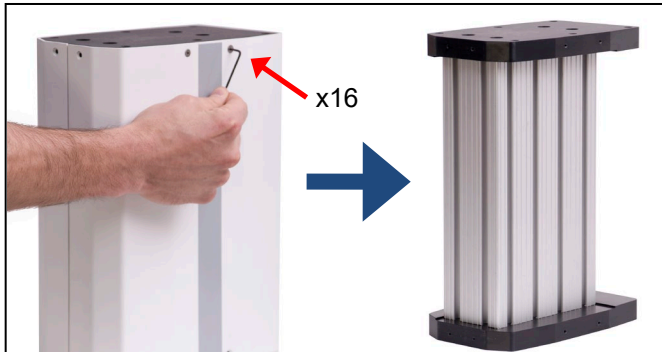

2. Using the 6 screws removed from the test frame base, reinstall the base onto the lower flange of the column extension, as shown in the image below:

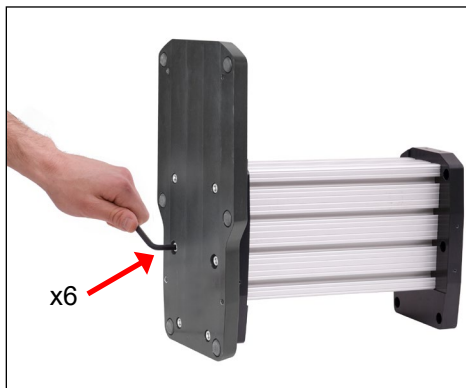

3. Attach the top flange to the bottom of the test frame column utilizing the 6 supplied screws, as shown in the image below:



4. Position the test frame vertically and reinstall the sheet metal covers, as shown below:



Vertical column extensions present an increased tipping hazard. It is strongly recommended that the base be fastened to a workbench utilizing the holes on the underside of the base. Refer to the dimensional drawing for hole locations.

13.3 Installing a double column extension – F105 / F305 / F505

Models AC1095-1 / -2 / -3 column extensions are shipped fully assembled. To mount the test frame to the assembly, locate the 6 thru holes, match them up to the corresponding threaded holes on the underside of the frame, and install the screws. Refer to the image below:

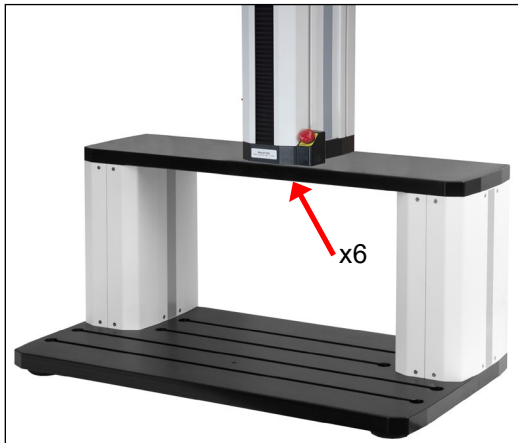

14 UPDATING SOFTWARE AND FIRMWARE

From time to time, new EasyMESUR software versions and new test frame firmware versions will become available. To update, go to **Settings**, then press **Update**.

14.1 Update EasyMESUR

Press **Update EasyMESUR**. The screen appears as follows:

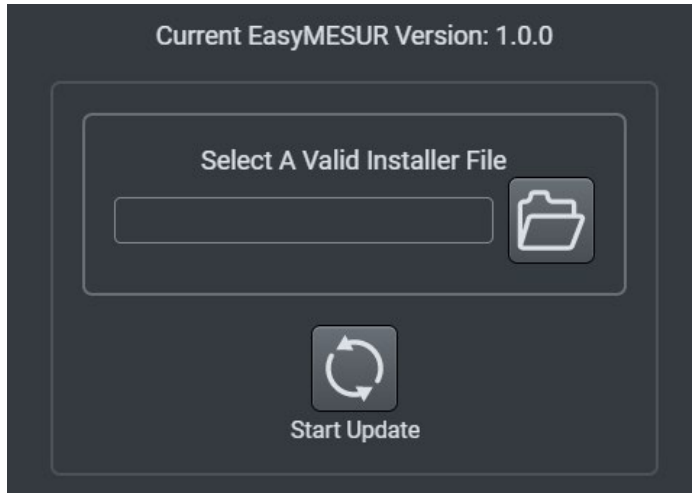

The file will be supplied by Mark-10 or a distributor. Save the file to a PC or USB flash drive, browse to it, then press **Start Update**.



Do not power off the test frame or disconnect the EasyMESUR control panel until the update is complete.

14.2 Update Test Frame Firmware

Press **Update Test Frame Firmware**. The screen appears as follows:

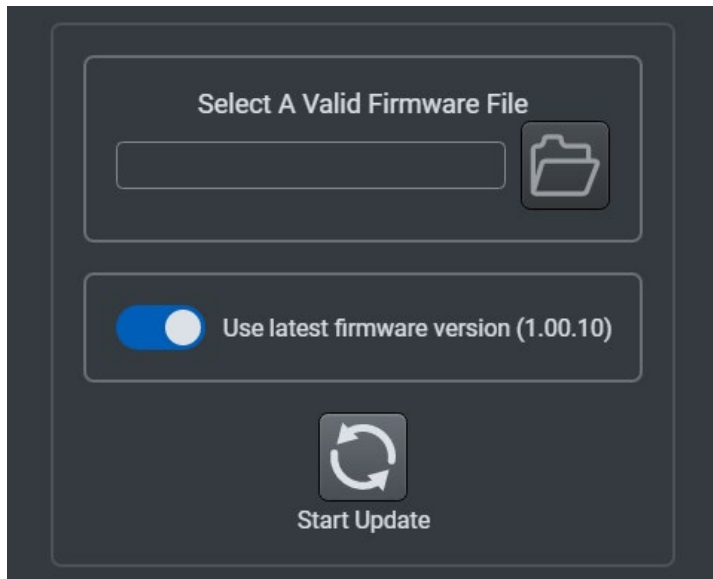

Follow the same instructions as the EasyMESUR update.

When a new EasyMESUR version is installed, the latest test firmware file is included, however, it does not need to be installed at that time.

Select "Use latest firmware version ()" to install the latest available firmware version associated with the current EasyMESUR version.

Otherwise, browse to the desired location and install another firmware file.



For best performance, Mark-10 strongly recommends using the latest firmware version.

15 SPECIFICATIONS & DIMENSIONS

15.1 Specifications

	F105	F305	F505	F505H	F755	F755S	F1505	F1505S
Load capacity*:	100 lbF [0.5 kN]	300 lbF [1.3 kN]	500 lbF [2.2 kN]		750 lbF [3.4 kN]		1,500 lbF [6.7 kN]	
Maximum travel:	18.0 in [457 mm]				32 in [813 mm]	14.2 in [360 mm]	32 in [813 mm]	14.2 in [360 mm]
Standard speed range:	0.5 – 13 in/min [13 – 330 mm/min]				0.5 - 24 in/min [10 - 600 mm/min]			
Optional speed range:	0.02 – 45 in/min [0.5 – 1,100 mm/min]				0.001 - 60 in/min [0.02 - 1,525 mm/min]		0.001 - 70 in/min [0.02 - 1,800 mm/min]	
Load accuracy (% of full scale):	Test frame: ±0.1% Force sensor: Series FS05: ±0.1% Series FS06: ±0.15% Series R07: ±0.15%							
Load sampling rate:	5,000 Hz							
Data acquisition rate:	100 Hz							
Speed accuracy:	±0.2% of setting, virtually no variation with load							
Position accuracy:	±0.006 in [0.15 mm], at any load or position							
Distance resolution:	0.001 in [0.02 mm]							
Limit switch repeatability:	±0.001 in [0.03 mm]							
Power:	Universal input 100-240 VAC, 50/60 Hz, 120W				Universal input 100-240 VAC, 50/60 Hz, 300W		Universal input 100-240 VAC, 50/60 Hz, 450W	
Fuse type:	1.2 A, 250V, 3AG, SLO BLO				4A, 3AG, SLO BLO			
Weight:	60 lb [27 kg]		70 lb [32 kg]		184 lb [83 kg]	149 lb [68 kg]	197 lb [89 kg]	157 lb [71 kg]
Shipping Weight:	75 lb [34 kg]		85 lb [39 kg]		235 lb [107 kg]	195 lb [88 kg]	247 lb [112 kg]	205 lb [93 kg]
Environmental conditions:	<ul style="list-style-type: none"> - Indoor use only - Up to 6,500 ft [2,000 m] above sea level - Temperature range: 40 - 95°F [5 - 35°C] - Humidity range: up to 80% relative humidity at 31°C, decreasing linearly to 50% relative humidity at 40°C, non-condensing - Mains supply voltage fluctuations up to ±10 % of the nominal voltage - Transient overvoltages up to the levels of Overvoltage Category II - Use in environments up to Pollution Degree 2 							
Conformance:	CE, UKCA							
Warranty:	3 years [see individual statement for further details]							

* Load capacity is reduced at higher speeds in the following models:

- F305: limited to 200 lbF [1 kN] above 24 in [610 mm]/min
- F505 / F505H: limited to 300 lbF [1.3 kN] above 24 in [610 mm]/min
- F755 / F755S: limited to 500 lbF [2.3 kN] above 35 in [900 mm]/min
- F1505 / F1505S: limited to 1,000 lbF [4.5 kN] above 60 in [1,525 mm]/min

15.2 Dimensions IN [MM]

15.2.1 Models F105 / F305 / F505

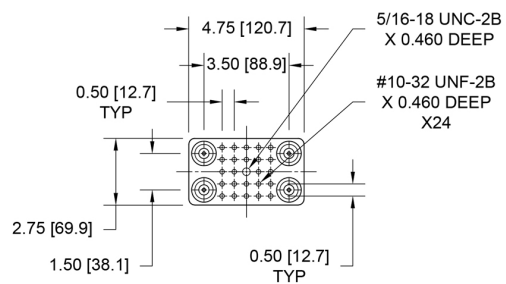
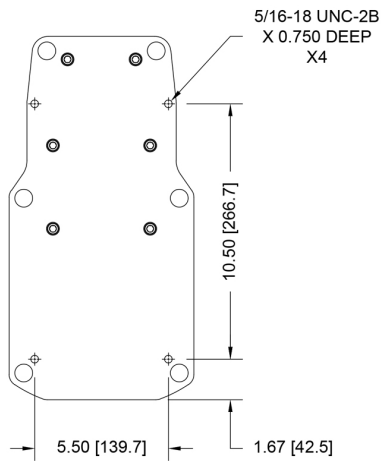
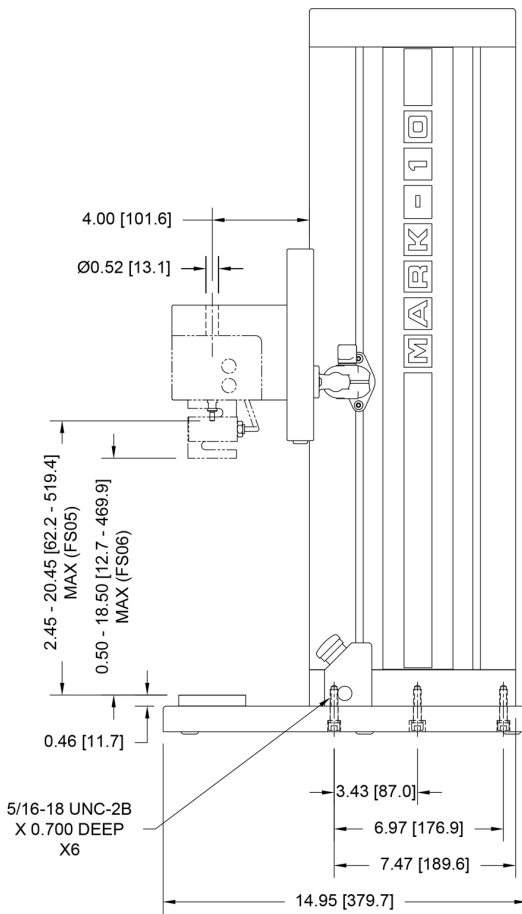
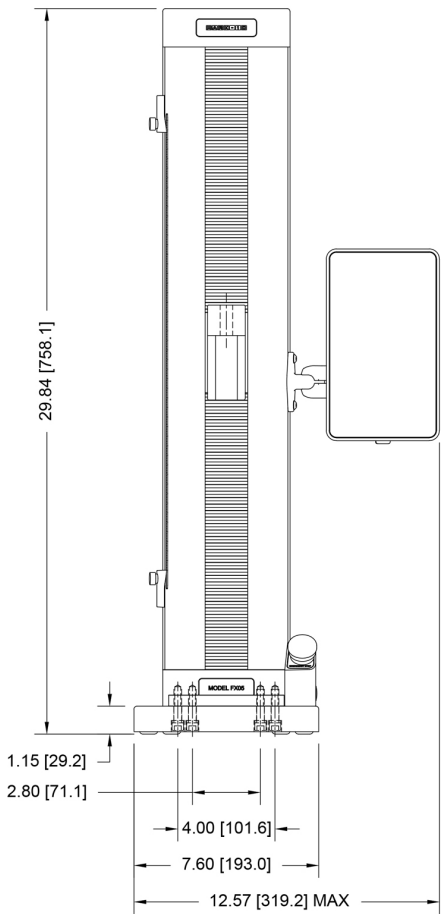

**BENCH MOUNTING HOLES
BOTTOM VIEW**

**MOUNTING PLATE
TOP VIEW**

15.2.2 Model F505H

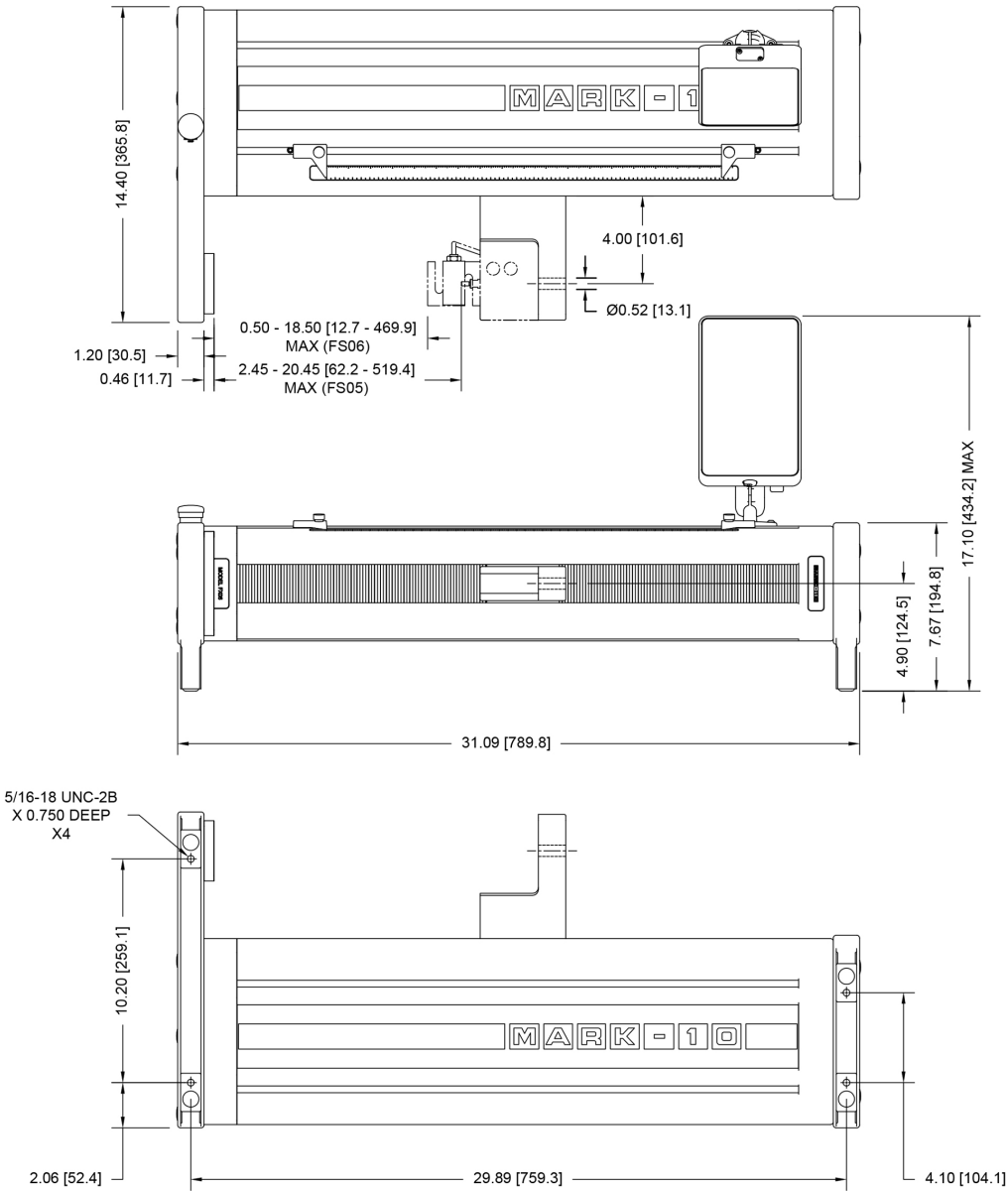

**BENCH MOUNTING HOLES
BOTTOM VIEW**

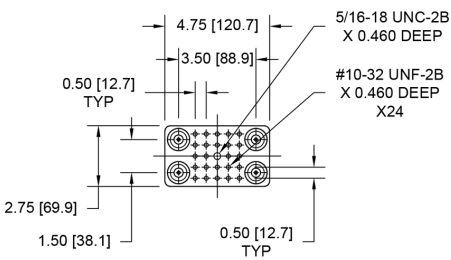

**MOUNTING PLATE
TOP VIEW**

15.2.3 Models F755 / F755S / F1505 / F1505S

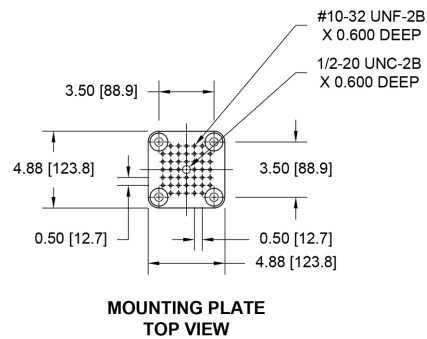
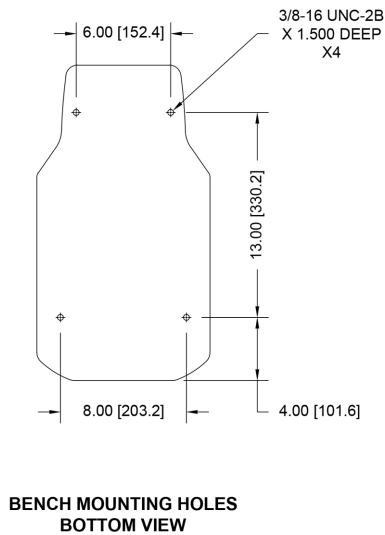
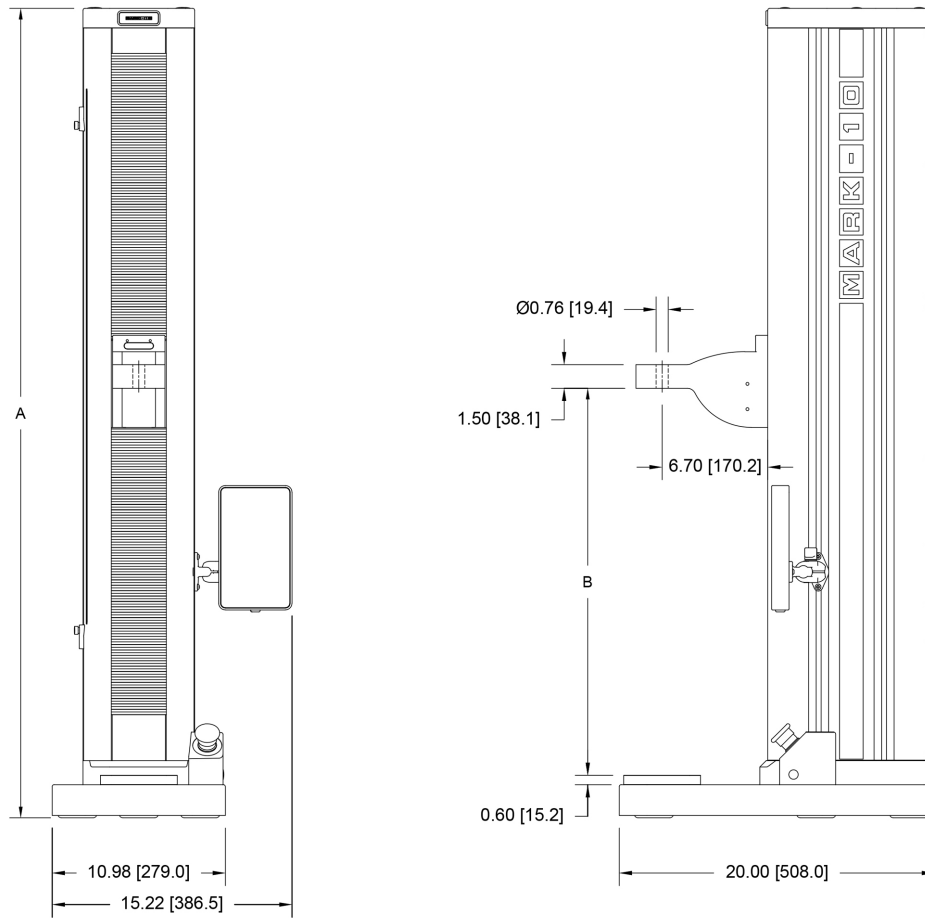

	F755	F755S	F1505	F1505S
A	50.85 [1291.6]	33.39 [848.1]	51.35 [1304.3]	33.89 [860.9]
B	8.13 – 40.13 [206.4 – 1019.2]	8.13 – 22.33 [206.4 – 567.1]	8.13 – 40.13 [206.4 – 1019.2]	8.13 – 22.33 [206.4 – 567.1]



Mark-10 Corporation has been an innovator in the force and torque measurement fields since 1979. We strive to achieve 100% customer satisfaction through excellence in product design, manufacturing and customer support. In addition to our standard line of products we can provide modifications and custom designs for OEM applications. Our engineering team is eager to satisfy any special requirements. Please contact us for further information or suggestions for improvement.

MARK-10.

Force and torque measurement engineered better

Mark-10 Corporation

11 Dixon Avenue
Copiague, NY 11726 USA
888-MARK-TEN
Tel: 631-842-9200
Fax: 631-842-9201
www.mark-10.com
info@mark-10.com