

Series **5**

---

DIGITAL FORCE GAUGES

# **User's Guide**

**MARK-10**®

## Thank you...



Thank you for purchasing a Mark-10 Series 5 digital force gauge, designed for tension and compression testing applications from 0.12 to 2,000 lbf (0.5 N to 10,000 N) full scale. The Series 5 is an essential component of a force testing system, typically also comprising a test stand, grips, and data collection software.

With proper usage, we are confident that you will get many years of great service with this product. Mark-10 force gauges are ruggedly built for many years of service in laboratory and industrial environments.

This User's Guide provides setup, safety, and operation instructions. Dimensions and specifications are also provided. For additional information or answers to your questions, please do not hesitate to contact us. Our technical support and engineering teams are eager to assist you.

**Before use, each person who is to use a Series 5 force gauge should be fully trained in appropriate operation and safety procedures.**

## TABLE OF CONTENTS

OVERVIEW .....	2
POWER .....	3
SETUP .....	4
HOME SCREEN AND CONTROLS .....	6
OPERATING MODES .....	9
DIGITAL FILTERS .....	12
SET POINTS .....	13
DATA MEMORY AND STATISTICS .....	15
COMMUNICATIONS AND OUTPUTS .....	17
CALIBRATION .....	23
PASSWORDS .....	28
OTHER SETTINGS .....	30
SPECIFICATIONS .....	33

## 1 OVERVIEW

### 1.1 Included Items

Qty.	Part No.					Description
	M5-012 – M5-20	M5-50 – M5-100	M5-200 – M5-500	M5-750 – M5-2000	M5-2-COF	
1	12-1049	12-1049	12-1049	12-1049	12-1049	Carrying Case
1	08-1022	08-1022	08-1022	08-1022	08-1022	AC adapter body with US, EU, or UK prong
1	08-1026	08-1026	08-1026	08-1026	08-1026	Battery (inside the gauge)
1	G1024	G1024	G1031	G1031	G1024	Extension rod
1	G1026	G1026	G1033	G1033	G1026	Cone
1	G1025	G1025	G1032	G1032	G1025	Chisel
1	G1027	G1027	G1034	G1034	G1027	V-groove
1	G1029	G1029	G1036	G1036	G1029	Flat
1	G1028	G1038	G1035	G1042	G1028	Hook (not incl. with M5-1500 or M5-2000)
1	-	G1039	G1037	-	-	Coupling
1	-	-	-	G1041	-	Thread adapter
1	-	-	-	-	-	Certificate of calibration
1	09-1165	-	-	-	-	USB cable
-	USB driver, MESUR® Lite software, MESUR®gauge evaluation software, User's Guide					
	<b>Download at: <a href="http://www.mark-10.com/resources">www.mark-10.com/resources</a></b>					

### 1.2 Safety / Proper Usage

#### Caution!

**Note the force gauge's capacity before use and ensure that the capacity is not exceeded. Producing a force greater than 200% of the gauge's capacity can damage the internal load cell. An overload can occur whether the gauge is powered on or off.**

Typical materials able to be tested include many manufactured items, such as springs, electronic components, fasteners, caps, films, mechanical assemblies, and many others. Items that should not be used with the gauge include potentially flammable substances or products, items that can shatter in an unsafe manner, and any other components that can present an exceedingly hazardous situation when acted upon by a force.

The following safety checks and procedures should be performed before and during operation:

1. Never operate the gauge if there is any visible damage to the AC adapter or the gauge itself.
2. Ensure that the gauge is kept away from water or any other electrically conductive liquids at all times.
3. The gauge should be serviced by a trained technician only. AC power must be disconnected and the gauge must be powered off before the housing is opened.
4. Always consider the characteristics of the sample being tested before initiating a test. A risk assessment should be carried out beforehand to ensure that all safety measures have been addressed and implemented.
5. Wear eye and face protection when testing, especially when testing brittle samples that have the potential to shatter under force. Be aware of the dangers posed by potential energy that can accumulate in the sample during testing. Extra bodily protection should be worn if a destructive failure of a test sample is possible.

6. In certain applications, such as the testing of brittle samples that can shatter, or other applications that could lead to a hazardous situation, it is strongly recommended that a machine guarding system be employed to protect the operator and others in the vicinity from shards or debris.
7. When the gauge is not in use, ensure that the power is turned off.

## 2 POWER

The gauge is powered either by an 8.4V NiMH rechargeable battery or by an AC adapter. Since these batteries are subject to self discharge, it may be necessary to recharge the unit after a prolonged period of storage. Plug the accompanying charger into the AC outlet and insert the charger plug into the receptacle on the gauge (refer to the illustration below). The battery will fully charge in approximately 8 hours.







### Caution!

**Do not use chargers or batteries other than supplied or instrument damage may occur.**

If the AC adapter is plugged in, an icon appears in the lower left corner of the display, as follows: 

If the AC adapter is not plugged in, battery power drainage is denoted in a five-step process:

1. When battery life is greater than 75%, the following indicator is present: 
2. When battery life is between 50% and 75%, the following indicator is present: 
3. When battery life is between 25% and 50%, the following indicator is present: 
4. When battery life is less than 25%, the following indicator is present: 
5. When battery life drops to approximately 2%, the indicator from step 4 will be flashing. Several minutes after (timing depends on usage and whether the backlight is turned on or off), a message appears, "BATTERY VOLTAGE TOO LOW. POWERING OFF". A 4-tone audio indicator will sound and the gauge will power off.

The gauge can be configured to automatically power off following a period of inactivity. Refer to the **Other Settings** section for details.

If battery replacement is necessary, the battery may be accessed by separating the two halves of the gauge. Refer to the **Setup** section for details.

## 3 SETUP

### 3.1 Mechanical Setup

#### 3.1.1 Loading shaft orientation

In order to accommodate a variety of testing requirements, the orientation of the loading shaft may be set up in either of the two positions shown below. In order to change the loading shaft orientation, loosen the two captive screws on the back side of the housing, separate the two housing halves, rotate one half 180 degrees, and reassemble. Contact between the two halves is made by the spring pins and contact pads on the printed circuit boards. Note that models M5-1000, M5-1500, and M5-2000 do not utilize a load cell shaft, however, the same rotation procedure applies.

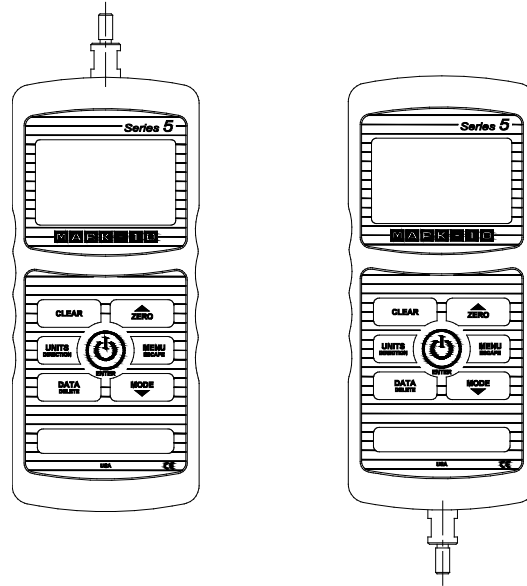

Load cell shaft up

Load cell shaft down

#### 3.1.2 Mounting to a plate

Although the gauge may be used by hand, proper mounting is important if attached to a fixture or test stand. The round steel insert with a hole in the back of the housing is provided to withstand the load during a test. A mating dowel pin should be used (see illustration below). Mounting plates on Mark-10 test stands include a dowel pin and clearance holes for the four threaded holes located near the corners of the housing. These holes are designed to accommodate screws in order to hold the gauge in place (Mark-10 test stands include a set of thumb screws for gauge mounting). The screws must **not** be used for load bearing purposes. Failure to use a dowel pin properly can result in a hazardous situation.

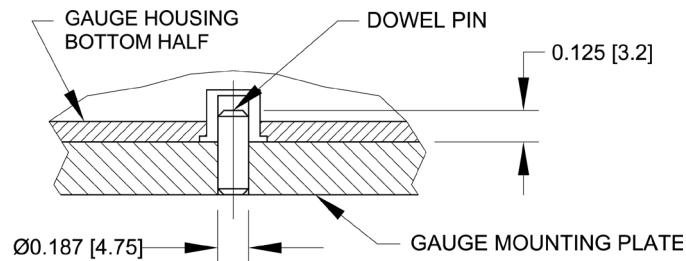

### 3.1.3 Mounting attachments to the gauge

The force gauge's threaded loading shaft is designed to accommodate common grips and attachments with female mounting holes. To mount a grip, gently thread it onto the shaft. Other mounting adapters are also available to prevent rotation. Ensure that the grip or fixture is positioned to ensure axial load with respect to the loading shaft of the force gauge. When using a grip, ensure that it secures the sample in such a way that it is prevented from slipping out during a test, preventing a potential safety risk to the operator and others in the vicinity. If using a grip or fixture from a supplier other than Mark-10, ensure that it is constructed of suitably rugged materials and components.

Do not use jam nuts or tools to tighten grips or attachments onto the shaft. **Finger-tighten only.**

### 3.2 Installing the USB driver

If communicating via USB, install the USB driver available at: [www.mark-10.com/resources](http://www.mark-10.com/resources)

#### **Caution!**

**Install the USB driver before physically connecting the gauge to a PC with the USB cable.**

Further instructions for configuring and using the gauge's outputs are provided in the **Communications and Outputs** section.

## 4 HOME SCREEN AND CONTROLS

### 4.1 Home Screen

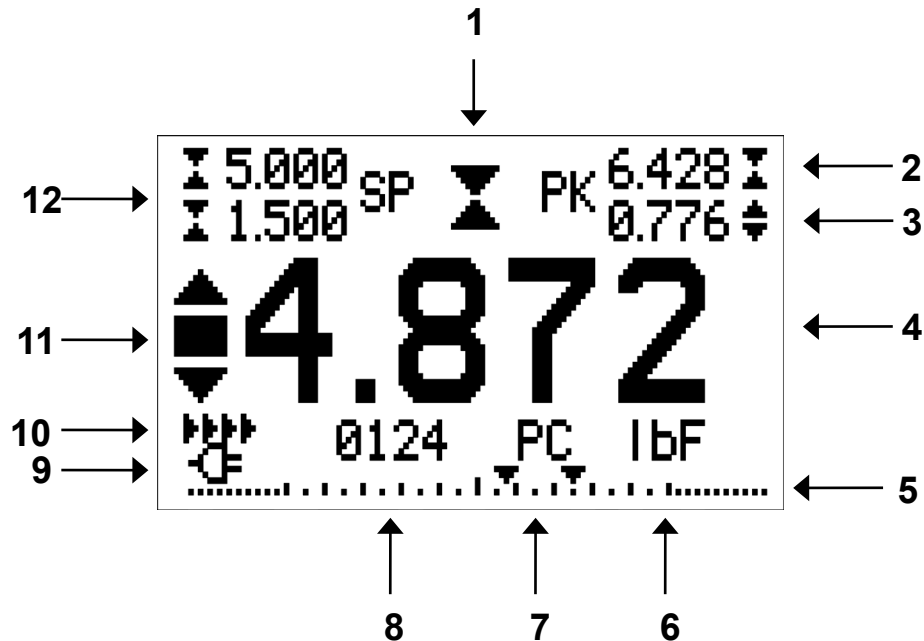



No.	Name	Description
1	Tension / compression indicator	<p>  - indicates a compression (push) direction   - indicates a tension (pull) direction            These indicators are used throughout the display and menu.         </p>
2	Compression Peak	The maximum measured compression peak reading. This reading may be reset by pressing <b>ZERO</b> or by powering the gauge off and on.
3	Tension Peak / Static COF	The maximum measured tension peak or static coefficient of friction (for M5-2-COF gauge). May be reset by pressing <b>ZERO</b> or by powering the gauge off and on.
4	Primary reading / Kinetic COF	The current displayed force reading. See <b>Operating Modes</b> section for details. For the M5-2-COF gauge, this reading represents the kinetic coefficient of friction when the gauge is set to COF unit of measurement (see <b>Units</b> indicator below) and has completed an <b>Average</b> sequence (see <b>Operating Modes</b> section for details).
5	Load bar	Analog indicator to help identify when an overload condition is imminent. The bar increases either to the right or to the left from the midpoint of the graph. Increasing to the right indicates compression load, increasing to the left indicates tension load. If set points are enabled, triangular markers are displayed for visual convenience. This indicator reflects the actual load, which may not correspond to the primary reading (depends on operating mode). The <b>ZERO</b> key does not reset the load bar. See <b>Operating Modes</b> section for details.
6	Units	The current measurement unit. Abbreviations are as follows: lbF – Pound-force ozF – Ounce-force kgF – Kilogram-force gF – Gram-force N – Newton

		<p>kN – Kilonewton  mN – Millinewton  COF – Coefficient of friction (M5-2-COF gauge only)</p> <p><b>Note:</b> not all gauge capacities measure in all the above units. Refer to the capacity / resolution table in the <b>Specifications</b> section for details.</p>
7	<b>Mode</b>	<p>The current measurement mode. Abbreviations are as follows:</p> <p>RT – Real Time  PC – Peak Compression  PT – Peak Tension (static COF for M5-2-COF gauge)  A – Average Mode (kinetic COF for M5-2-COF gauge)  ET – External Trigger Mode</p> <p>See <b>Operating Modes</b> section for details about each of these modes</p>
8	<b>Number of stored data points</b>	<p>The number of stored data points in memory, up to 1000. Displayed only if <b>Memory Storage</b> is enabled for the <b>DATA</b> key.</p>
9	<b>Battery / AC adapter indicator</b>	<p>Either the AC adapter icon or battery power icon will be shown, depending on power conditions. Refer to the <b>Power</b> section for details.</p>
10	<b>Automatic data output indicator</b>	<p>If <b>Auto Output</b> has been enabled under <b>Serial / USB Settings</b>, this indicator is displayed. When automatic data output is occurring, the icon becomes animated. See <b>Communications and Outputs</b> section for details.</p>
11	<b>High / low limit indicators</b>	<p>Correspond to the programmed set points. Indicator definitions are as follows:</p> <p>▲ – the displayed value is greater than the upper force limit  ■ – the displayed value is between the limits  ▼ – the displayed value is less than the lower force limit</p>
12	<b>Set points</b>	<p>The programmed force limits. Typically used for pass/fail type testing. 1, 2, or no indicators may be present, depending on the configuration shown in the <b>Set Points</b> menu item.</p>



## 4.2 Controls

Primary Label	Primary Function	Secondary Label	Secondary Function
	Powers the gauge on and off. Press briefly to power on, press and hold to power off. Active only when the home screen is displayed.	<b>ENTER</b>	Various uses, as described in the following sections.
<b>ZERO</b>	Zeroes the primary reading and peaks.	 <b>(UP)</b>	Navigates up through the menu and sub-menus .
<b>MENU</b>	Enters the main menu.	<b>ESCAPE</b>	Reverts one step backwards through the menu hierarchy.
<b>MODE</b>	Toggles between measurement modes.	 <b>(DOWN)</b>	Navigates down through the menu and sub-menus.
<b>DATA</b>	Stores a value to memory, transmits the current reading to an external device, and/or initiates automatic data output, depending on setup.	<b>DELETE</b>	Enables and disables <b>Delete</b> mode while viewing stored data.
<b>UNITS</b>	Toggles between measurement units.	<b>DIRECTION</b>	Reverses the display during calibration, and toggles between tension and compression directions while configuring set points and other menu items.
<b>CLEAR</b>	Zeroes the peak readings, but retains the primary reading.	<b>N/A</b>	N/A

## 4.3 Menu navigation basics

Most of the gauge's various functions and parameters are configured through the main menu. To access the menu press **MENU**. Use the **UP** and **DOWN** keys to scroll through the items. The current selection is denoted with clear text over a dark background. Press **ENTER** to select a menu item, then use **UP** and **DOWN** again to scroll through the sub-menus. Press **ENTER** again to select the sub-menu item.

For parameters that may be either selected or deselected, press **ENTER** to toggle between selecting and deselecting. An asterisk (\*) to the left of the parameter label is used to indicate when the parameter has been selected.

For parameters requiring the input of a numerical value, use the **UP** and **DOWN** keys to increment or decrement the value. Press and hold either key to auto-increment at a gradually increasing rate. When the desired value has been reached, press **ENTER** to save the change and revert back to the sub-menu item, or press **ESCAPE** to revert back to the sub-menu item without saving. Press **ESCAPE** to revert one step back in the menu hierarchy until back into normal operating mode.

Refer to the following sections for details about setting up particular functions and parameters.

## 5 OPERATING MODES

---

### Caution!

In any operating mode, if the capacity of the instrument has been exceeded by more than 110%, the display will show “OVER” to indicate an overload. A continuous audible tone will be sounded until the MENU key has been pressed or the load has been reduced to a safe level.

Five operating modes are possible with Series 5 gauges. To cycle between the modes, press **MODE** while in the home screen.

### 5.1 Real time (RT)

The primary reading corresponds to the live measured reading.

### 5.2 Peak Compression (PC)

The primary reading corresponds to the peak compression reading observed. If the actual force decreases from the peak value, the peak will still be retained in the primary reading area of the display. Pressing **ZERO** will reset the value.

### 5.3 Peak Tension / Static Coefficient of Friction (PT)

Same as Peak Compression, but for tension readings.

In the M5-2-COF gauge, the reading in this mode represents the static coefficient of friction.

**Note:** The static COF is always represented in the upper right corner of the display by the peak tension value, regardless of the operating mode.

### 5.4 Average Mode / Kinetic Coefficient of Friction (AVG)

Average mode is used to obtain an average force over time. This reading also represents the kinetic coefficient of friction for the M5-2-COF gauge. Applications include measurement of peel force, COF, muscle strength, frictional force, and other tests requiring time-averaged readings.

Before the parameters of Average Mode can be configured, it must be enabled. To do so, select **Average Mode** from the menu, scroll to **Enable** and press **ENTER**. The display appears as follows:

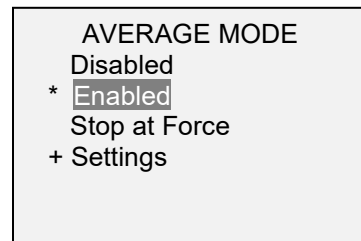

The averaging function operates in one of two ways:

1. Averaging occurs between the trigger force and defined time limit, as illustrated below:

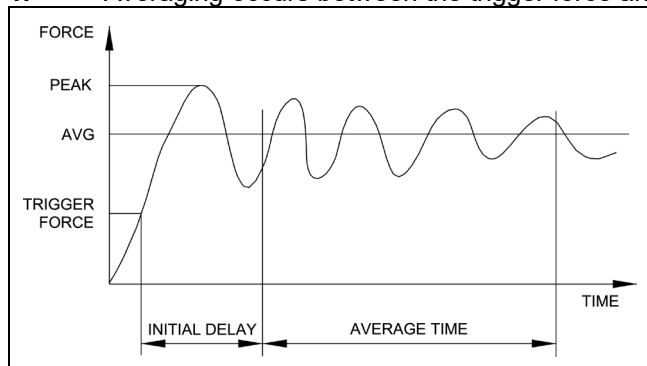

2. Averaging occurs only while above the trigger force. As the force drops back down to this trigger, averaging stops. To enable this function, scroll to **Stop at Force** and press **ENTER**.

Select **Settings** to configure **Trigger Force**, **Initial Delay**, and **Averaging Time**:

AVERAGE MODE SETTINGS	
Trigger Force	1.00 lbF
Initial Delay	1.0 sec.
Averaging Time	5.0 sec.

Parameter	Description
<b>Trigger Force</b> or <b>Start / Stop Force</b>	The minimum force required to start the averaging sequence. Toggle between compression and tension directions by pressing the <b>DIRECTION</b> key. Initial delay follows the trigger force. If <b>Stop at Force</b> is enabled, this parameter is referred to as <b>Start / Stop Force</b> , denoting the minimum force for which averaging will be active.
<b>Initial Delay</b>	The time delay, after the trigger force, before the averaging sequence commences. <i>Available settings: 0.0 – 300.0 sec., in 0.1 sec. increments</i>
<b>Averaging Time</b>	The time duration of the averaging sequence. This setting is ignored when <b>Stop at Force</b> is enabled, unless the 300 sec. limit is reached. <i>Available settings: 0.1 – 300.0 sec., in 0.1 sec. increments</i>

After the parameters have been configured and the menu has been exited, press **MODE** until **AVG** is displayed. Then press **ZERO**. Average mode is now armed, and the averaging sequence will commence when the trigger force has occurred. The current status of the averaging sequence is displayed below the primary reading, as follows:

Step	Status	Description
1	TRIG WAIT	The trigger force has not yet occurred.
2	INIT DLY	The initial delay is currently taking place.
3	AVERAGING	The gauge is collecting readings. The status will be flashing until averaging has been completed.
4	AVRG DONE	Averaging has been completed. The average force is displayed in the primary reading.

At the completion of the averaging sequence, the peak values are retained until **ZERO** is pressed. Another averaging sequence may be started after **ZERO** has been pressed. To exit Average mode, press **MODE** and select the desired measuring mode.

### 5.5 COF Sled Weight (for M5-2-COF gauge only)

The M5-2-COF performs COF calculations by dividing the force by the sled weight. For example, a force of 100 gF divided by 200 g equals 0.5 COF. Although many COF testing applications require a sled weight of 200 g, the gauge allows the user to change the sled weight to comply with other requirements. To modify the sled weight, select **COF** from the menu. The display appears as follows:

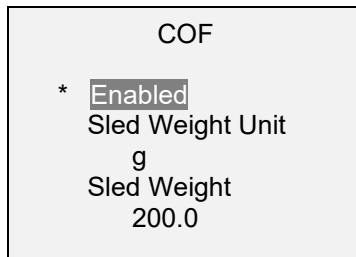

Available sled weight settings: 100 – 1000 g

### 5.6 External Trigger (ET)

This mode of operation is useful for measuring electrical contact activation force as well as synchronization of multiple instruments for a “snapshot” view of applied forces. It is possible to capture the reading with a normally open contact (high to low transition of the trigger signal) or a normally closed contact (low to high transition).

Before the parameters of External Trigger Mode can be configured, it must be enabled. To do so, enter the main menu, select **External Trigger**, scroll to one of the four available options and press **ENTER**. The options are as follows:



Option	Description
Momentary High → Low	The display will freeze the captured reading until <b>ZERO</b> is pressed. Applies to a high to low transition of the trigger signal.
Momentary Low → High	The display will freeze the captured reading until <b>ZERO</b> is pressed. Applies to a low to high transition of the trigger signal.
Maintained High	The display will show the captured reading only for as long as a high signal is maintained.
Maintained Low	The display will show the captured reading only for as long as a low signal is maintained.

After the selection has been made and the menu has been exited, press **MODE** until **ET** is displayed. External Trigger mode is now armed. Refer to the pin diagram in the **Communications and Outputs** section for connection information.

To exit External Trigger mode, press **MODE** and select the desired measuring mode.

**Note:** As long as external trigger has been enabled, it is still active even if the gauge is in **Real Time** mode. After the display freezes, any programmed set points will be active. However, if the gauge is in **External Trigger** mode, any programmed set points will be inactive.

### 5.6.1 External Trigger Schematic Diagram

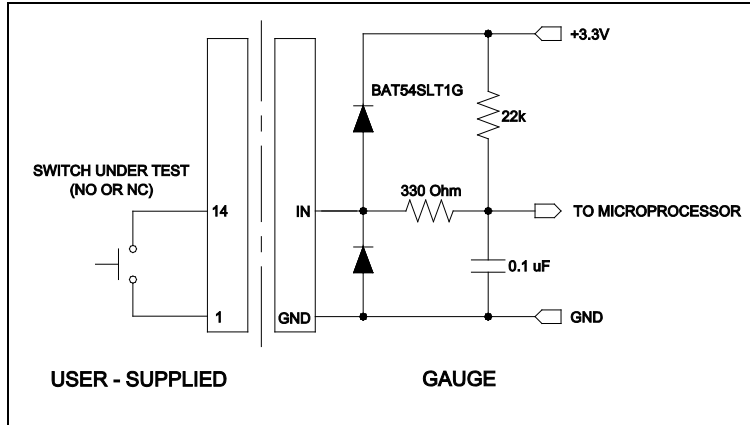

**Note:** Custom cabling is required to connect to a switch, or to connect a switch and a Mark-10 test stand simultaneously.

## 6 DIGITAL FILTERS

Digital filters are provided to help smooth out the readings in situations where there is mechanical interference in the work area or test sample. These filters utilize the moving average technique in which consecutive readings are pushed through a buffer and the displayed reading is the average of the buffer contents. By varying the length of the buffer, a variable smoothing effect can be achieved. The selection of 1 will disable the filter since the average of a single value is the value itself.

To access digital filter settings, select **Filters** from the menu. The display appears as follows:

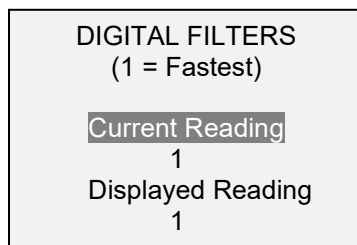

Two filters are available:

**Current Reading** – Applies to the peak capture rate of the instrument.

**Displayed Reading** – Applies to the primary reading on the display.

Available settings: 1, 2, 4, 8, 16, 32, 64, 128, 256, 512, 1024. It is recommended to keep the current reading filter at its lowest value for best performance, and the displayed reading filter at its highest value for best stability.

## 7 SET POINTS

### 7.1 General Information

Set points are useful for tolerance checking (pass/fail), triggering an external device such as a motorized test stand, or alarm indication in process control applications. Two limits, high and low, are specified and stored in the non-volatile memory of the instrument and the primary reading is compared to these limits. The results of the comparisons are indicated through the three outputs provided on the 15-pin connector, thus providing “under”, “in range”, and “over” signaling. These outputs can be connected to indicators, buzzers, or relays as required for the application.

### 7.2 Configuration

To configure set points, select **Set Points** from the menu. The screen appears as follows:

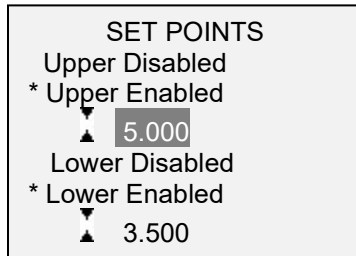

Either one, two, or none of the set points may be enabled. To toggle between the tension and compression directions, press the **DIRECTION** key.

If two set points have been enabled, they are displayed in the upper left corner of the display. If only one set point has been enabled, the word “OFF” appears in place of the value. If no set points have been enabled, the upper left corner of the display will be blank.

When set points are enabled, the following indicators are shown to the left of the primary reading:

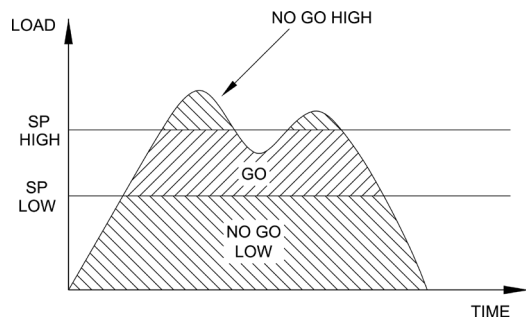

- ▲ – the displayed value is greater than the upper force limit (NO GO HIGH)
- – the displayed value is between the limits (GO)
- ▼ – the displayed value is less than the lower force limit (NO GO LOW)

**Note:** Set point indicators and outputs reference the displayed reading, not necessarily the current live load.

### 7.3 Set Point Outputs Schematic

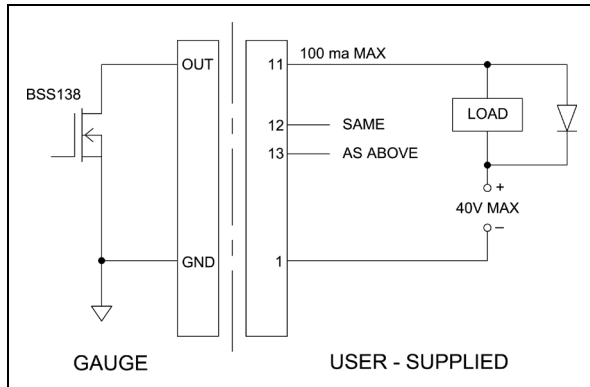

### 7.4 Using Set Points to Control a Mark-10 Test Stand

When using set points to stop/cycle Mark-10 motorized test stands, the upper and lower set points must be set to **opposite** measuring directions. Both set points must be set, even if the intended application is to stop/cycle at only one of the set points. The opposite set point should be a value sufficiently large that it does not get triggered during the course of the test.

For certain Mark-10 test stands, the upper and lower set point directions are reversed.

## 8 DATA MEMORY AND STATISTICS

Series 5 gauges have storage capacity of 1,000 data points. Readings may be stored, viewed, and output to an external device. Individual, or all, data points may be deleted. Statistics are calculated for the data presently in memory.

To enable memory storage, select **DATA Key** from the menu, then scroll to **Memory Storage** and press **ENTER**. Then exit the menu. In the home screen, the data record number **0000** appears below the primary reading. Press **DATA** at any time to save the displayed reading. The record number will increment each time **DATA** is pressed. If **DATA** is pressed when memory is full the message "MEMORY FULL" will be flashed at the bottom of the display and a double audio tone will be sounded.

To view, edit, and output stored readings and statistics, select **Memory** from the menu. The screen appears as follows:

MEMORY	
View Data	
View Statistics	
Output Data	
Output Statistics	
Output Data & Stats	
Clear All Data	

### 8.1 View Data

All the saved data points may be viewed. The record number is displayed, along with the corresponding value and presently set unit of measurement. Any readings may be deleted individually. To do so, scroll to the desired reading and press **DELETE**. The letter "D" appears to the left of the record number, indicating that the gauge is in **Delete** mode, as follows:

0001	2.458 lbF
0002	2.224 lbF
0003	2.446 lbF
0004	1.890 lbF
D 0005	2.098 lbF
0006	1.998 lbF
0007	2.042 lbF

Press **ENTER** to delete the value. To exit **Delete** mode, press **DELETE** again. Any number of readings may be individually deleted, however, all readings may also be cleared simultaneously. Refer to the **Clear All Data** section for details.

### 8.2 Statistics

Statistical calculations are performed for the saved values. Calculations include number of readings, minimum, maximum, mean, and standard deviation.

### 8.3 Output Data

Press **ENTER** to output data to an external device. The display will show, "SENDING DATA...", then "DATA SENT". If there was a problem with communication, the display will show, "DATA NOT SENT". Saved data can be downloaded by some Mark-10 data collection programs. Refer to their respective user's guides for details.

### 8.4 Output Statistics

Press **ENTER** to output statistics to an external device. The display will show, "SENDING STATS...", then "STATS SENT". If there was a problem with communication, the display will show, "STATS NOT SENT".



### 8.5 Output Data & Stats

Press **ENTER** to output data and statistics to an external device. The display will show, "SENDING DATA", then "SENDING STATS...", then "DATA SENT", then "STATS SENT". If there was a problem with communication, the display will show, "DATA NOT SENT" and/or "STATS NOT SENT".

### 8.6 Clear All Data

Press **ENTER** to clear all data from the memory. A prompt will be shown, "CLEAR ALL DATA?". Select **Yes** to clear all the data, or **No** to return to the sub-menu.

For output of data and/or statistics, RS-232 or USB output must be enabled. Data formatting is <CR><LF> following each value. Units can be either included or excluded. Output of data via the Mitutoyo output is possible, however, output of statistics is not. Refer to the **Communications and Outputs** section for details.

**Note:** Data is not retained while the gauge is powered off. However, the gauge protects against accidental or automatic power-off. If manually powering the instrument off, or if the inactivity time limit for the **Automatic Shutoff** function has been reached, the following warning message appears:



If no option is selected, this screen will be displayed indefinitely, or until battery power has been depleted.

## 9 COMMUNICATIONS AND OUTPUTS

Communication with Series 5 force gauges is achieved through the micro USB or 15-pin serial ports located at the bottom of the instrument, as shown in the illustration in the **Power** section. Communication is possible only when the gauge is in the main operating screen (i.e. not in a menu or configuration area).

### 9.1 Serial / USB

To set up RS-232 and USB communication, select **Serial/USB Settings** from the menu. The screen appears as follows:

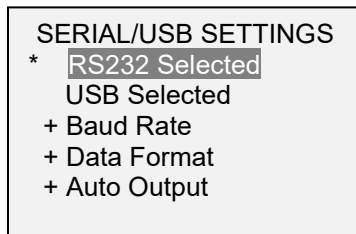

Select either RS-232 or USB input (output is always simultaneous through both the USB and RS-232 ports). RS-232 must be selected when communicating through a Mark-10 test stand controller. When communicating from the gauge directly to a PC or data collector, either RS-232 or USB can be selected as required. Press **DATA** to transmit individual data points or to commence an automatic output sequence (see **Automatic Output** sub-section for details). Single point or continuous data may also be requested via ASCII commands from an external device (see **Command Set** sub-section for details).

Communication settings are permanently set to the following:

<b>Data Bits:</b>	<b>8</b>
<b>Stop Bits:</b>	<b>1</b>
<b>Parity:</b>	<b>None</b>

Other settings are configured as follows:

#### 9.1.1 Baud Rate

Select the baud rate as required for the application. It must be set to the same value as the receiving device. When communicating with a Mark-10 test stand controller, the baud rate must be set to 115,200.

### 9.1.2 Data Format

Select the desired data format. The screen appears as follows:

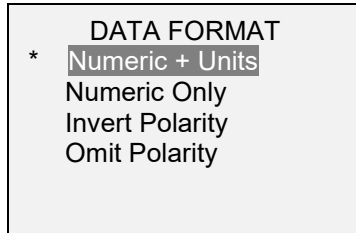

Selection	Description
Numeric + Units	Output format includes the value and unit of measure. Compression values have positive polarity, tension values have negative polarity.
Numeric Only	Output format includes the value only. Polarity same as above.
Invert Polarity	Compression values have negative polarity, tension values have positive polarity. May be selected in addition to the Numeric + Units / Numeric Only selection.
Omit Polarity	Both directions are formatted with positive polarity. May be selected in addition to the Numeric + Units / Numeric Only selection.

### 9.1.3 Automatic Output

The gauge has the ability to output data continuously via RS-232 or USB. To enable automatic output, select **Auto Output** from the **Serial/USB Settings** sub-menu. The screen appears as follows:

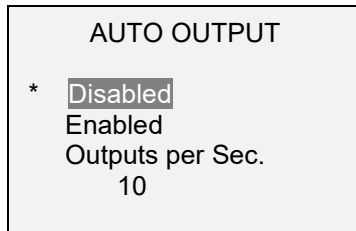

Select **Enabled** to activate automatic output. The number of outputs per second can be set to 1, 2, 5, 10, 25, 50, 125, or 250. The capabilities of the receiving device should be considered when selecting the data output rate.

After the settings have been saved, revert to the home screen. An icon appears in the lower left corner of the display, as follows: **■■■■**. This indicates that automatic data output has been armed. Automatic output of data may be initiated by pressing **DATA** or by sending the appropriate ASCII command from an external device (see **Command Set** sub-section for details). The icon will become animated, signaling that automatic output is occurring. Press **DATA** again to end the data transmission.

## 9.2 Mitutoyo BCD settings

This output is useful for connection to data collectors, printers, multiplexers, or any other device capable of accepting Mitutoyo BCD data. Individual data points may be transmitted by pressing **DATA** or by requesting it from the Mitutoyo communication device (if available). To enable Mitutoyo output, select the desired format – either with polarity or without polarity. The screen appears as follows:



## 9.3 Analog Output

This output can be used for chart recorders, oscilloscopes, data acquisition systems, or any other compatible devices with analog inputs. The output produces  $\pm 1$  volt at full scale of the instrument. The polarity of the signal is positive for compression and negative for tension.

## 9.4 DATA Key Functions

The **DATA** key can be configured to perform several functions. To configure the **DATA** key, select **DATA Key** from the menu. The display appears as follows:

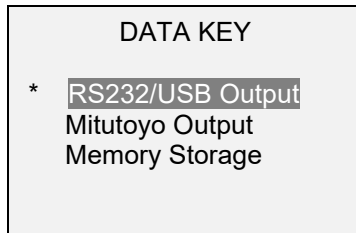

Three options are available:

Selection	Function when pressing DATA
<b>RS232/USB Output</b>	Outputs data via the serial and USB ports
<b>Mitutoyo Output</b>	Outputs data via Mitutoyo (Digimatic) through the serial port
<b>Memory Storage</b>	Stores a reading to memory (refer to the <b>Memory</b> section for details)

Any combination of the above functions may be selected.

## 9.5 I/O Connector Pin Diagram (DB-15HD female)

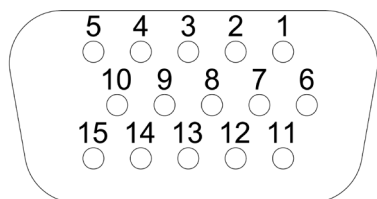

Pin No.	Description	Input / Output
1	Signal Ground	---
2 *	Tension Overload *	Output
3	RS-232 Receive	Input
4	RS-232 Transmit	Output
5	+12V DC	Input / Output
6	Analog Output	Output
7 *	Compression Overload *	Output
8	Mitutoyo Clock Output Bit 2	Output
9	Mitutoyo Data Output Bit 0	Output
10	Mitutoyo Request Input Bit 3	Input
11 **	Set Point Pin 1 **	Output **
12 **	Set Point Pin 2 **	Output **
13 **	Set Point Pin 3 **	Output **
14	External Trigger	Input
15	Mitutoyo Ready Output Bit 1	Output

\* Maximum voltage: 40V.

\*\* The output assignments depend on several factors described in the table below. Output functions always reference the primary reading on the display, regardless of the current mode.

Force	Pin 11	Pin 12	Pin 13
<b>Upper and Lower Set Points are Compression</b>			
Greater than or equal to upper set point	On	Off	Off
Between upper and lower set points	Off	Off	On
Less than or equal to lower set point	Off	On	Off
<b>Upper and Lower Set Points are Tension</b>			
Greater than or equal to upper set point	Off	On	Off
Between upper and lower set points	Off	Off	On
Less than or equal to lower set point	On	Off	Off
<b>Upper Set Point is Compression, Lower Set Point is Tension</b>			
Greater than or equal to upper set point, in compression	Off	On	Off
Between upper and lower set points	Off	Off	On
Greater than or equal to lower set point, in tension	On	Off	Off
<b>Upper Set Point is Tension, Lower Set Point is Compression</b>			
Greater than or equal to upper set point, in tension	Off	On	Off
Between upper and lower set points	Off	Off	On
Greater than or equal to lower set point, in compression	On	Off	Off

## 9.6 Command Set / Gauge Control Language 2 (GCL2)

Series 5 force gauges may be controlled by an external device through the RS-232 or USB channels. The following is a list of supported commands and their explanations. All commands must be terminated by a CR (Carriage Return) character, 0x0D, or a CR-LF (Carriage Return – Line Feed) pair, where the Line Feed, 0x0A, is ignored.

### Request Readings

?	Request the displayed reading (dependent on operating mode)
?C	Request the current (real time) reading
?PT	Request the peak tension reading
?PC	Request the peak compression reading
?ET	Request the reading obtained during the External trigger mode
?A	Request the average reading obtained during the Average mode

### Units

LB	Switch units to pound-force
OZ	Switch units to ounce-force
KG	Switch units to kilogram-force
G	Switch units to gram-force
N	Switch units to Newtons
MN	Switch units to Milli-Newtons
KN	Switch units to Kilo-Newtons

### Basic Functions

CUR	Current mode (real time mode) for primary reading
PT	Peak Tension mode for primary reading
PC	Peak Compression mode for primary reading
CLR	Clear peaks
Z	Zero display and perform the CLR function

### Filters

FLTPn	Digital filter for displayed readings
FLTCn	Digital filter for current readings n= 0-10, filter = 2 <sup>n</sup> , ex: n=0= no filter, n=10=1024 samples averaged

### Memory & Statistics

MEM	Transmit all stored readings
STA	Transmit statistics
CLRMEM	Clear all stored readings from memory

### Set Points

SPHD	Disable high set point
SPLD	Disable low set point
SPHn	High set point. n=value (+ for compression, - for tension)
SPLn	Low set point. n=value (+ for compression, - for tension)

### USB/RS-232 Communication

FULL	USB/RS-232 transmission with units
NUM	USB/RS-232 transmission without units (only numeric values)
AOUTn	Auto-transmit n times per second n=1,2,5,10,25,50,125,250. 0=disabled <b>Note:</b> n = 1 = yields 50 times per second. This is provided for backward compatibility with legacy gauges.
IPOLn	Invert polarity of output. n=1=invert polarity. n=0=normal (default) <b>Note:</b> Normal polarity is positive for compression and negative for tension.
OPOLn	Omit polarity of output. n=1=omit polarity. n=0=include polarity (default) <b>Note:</b> The "+" sign is always omitted. A "-" sign is sent when polarity is enabled.

**Mitutoyo Communication**

MIT	Enable Mitutoyo output
MITD	Disable Mitutoyo output
POL	Mitutoyo output with polarity (+ for compression, - for tension)
NPOL	Mitutoyo output without polarity (absolute value)
PM	Print/send data to a Mitutoyo-compatible device

**Averaging**

A	Enable Average mode
AD	Disable Average mode
AM	Select Average mode (if enabled) for primary reading
ATn	Average time. n=0.1-300.0 seconds
DELn	Initial delay. n=0.1-300.0 seconds
TRFn	Trigger force. n=value (+ for compression, - for tension)

**External Trigger**

ETH	Enable high level-triggered External trigger mode
ETL	Enable low level-triggered External trigger mode
ETHL	Enable reading captured on a high to low transition
ETLH	Enable reading captured on a low to high transition
ETD	Disable External trigger mode

**Input / Output Bits**

Sn	Set output bit (open drain, pull to ground). n=0,1,2
Cn	Clear output bit. n=0,1,2
Rn	Read current status of output bit or level of input pin. n=0,1,2,3

**Personality**

RN	Read product name
RM	Read model number
RV	Read firmware version number
RS	Read serial number

**Other Commands**

AOFFn	Auto-shutoff. n=0-30 minutes. 0=auto shutoff disabled
SAVE	Save current settings in nonvolatile memory
LIST	List current settings and status

**9.7 Command Responses**

In response to a reading request command (those which begin with '?') the gauge will return a string with the load data, followed by a space, then the load unit (if enabled under the **Serial/USB Settings** → **Data format** sub-menu). It will be terminated by a CR-LF pair.

Example return strings:

```
-0.486 lbF<CR><LF>    0.486 lbF of tension force
1.724 N<CR><LF>      1.724 N of compression force
```

The number of digits after the decimal point is dependent of the gauge's capacity and resolution.

By default, the minus sign (-) indicates tension, and the absence of a sign indicates compression. However, positive / negative polarity may be inverted or omitted under the **Serial/USB Settings** → **Data Format** sub-menu.

Following is an example LIST output:

```
V1.00;LBF;CUR;FLTC8;FLTP1;AOUT00;AOFF5;FULL;IPOL0;OPOL0;MIT;POL;B0
```

All fields are separated by “;”. The first field shows the firmware version, the last field shows the remaining battery power (B0=full charge, B3=minimum power). All other fields show the status of settings and features using the same abbreviations as the commands to set them.

Any detected errors are reported back by means of the following error codes:

- \*10 Illegal command
- \*11 Not applicable
- \*21 Invalid specifier
- \*22 Value too large
- \*51 Command string too long (25 characters maximum)

## 10 CALIBRATION

### 10.1 Initial Physical Setup

The gauge should be mounted vertically to a test stand or fixture rugged enough to withstand a load equal to the full capacity of the instrument. Certified deadweights or master load cells should be used, along with appropriate mounting brackets and fixtures. Caution should be taken while handling such equipment.

### 10.2 Calibration Procedure

1. Select **Calibration** from the menu. The display appears as follows:

CALIBRATION

To invert the display, press the DIRECTION button, then press ENTER.

2. Press **DIRECTION** to invert the display, if desired. **ENTER** to continue. The display appears as follows:

CALIBRATION

Enter # cal points  
(1 to 10)

Compression:

5

Tension:

5

The gauge can be calibrated at up to 10 points in each direction. Enter the number of calibration points for each direction (compression and tension). At least one point must be selected for each direction.

**Note:** To achieve the accuracy specification of  $\pm 0.1\%$ , it is recommended to calibrate the gauge at 5 or more even increments in both tension and compression directions. For example, a gauge with capacity of 10 lbf should be calibrated at 2, 4, 6, 8, and 10 lb loads in each direction.



3. To escape the **Calibration** menu at any time, press **ESCAPE**. The display appears as follows:

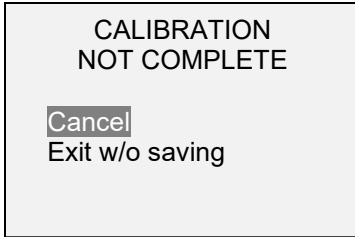

Selecting “Cancel” will revert back to the Calibration setup. Selecting “Exit w/o saving” will return to the menu without saving changes

4. After the number of calibration points has been entered, press **ENTER**. The display appears as follows:

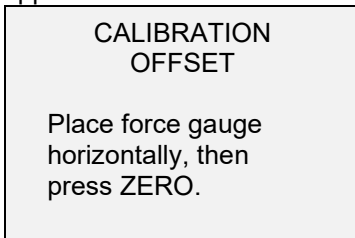

5. Place the force gauge horizontally on a level surface free from vibration, then press **ZERO**. The gauge will calculate internal offsets, and the display appears as follows:

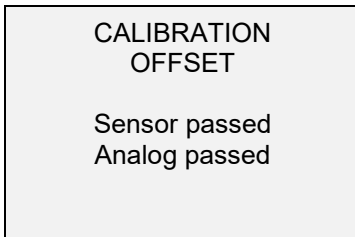
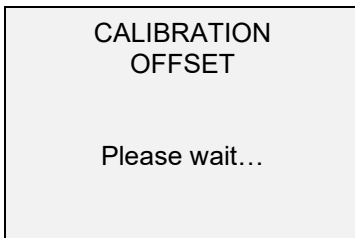

If failed:

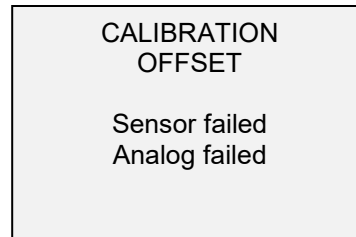

6. The following screen appears after the offsets have been calculated:



Attach weight fixtures (brackets, hooks, etc), as required. Do not yet attach any weights or apply any calibration loads. Press **ENTER**.

7. The display appears as follows:

```
CALIBRATION
COMPRESSION

Optionally exercise
sensor, then press
ENTER.
```

Optionally exercise the load cell shaft several times (at full scale, if possible), then press **ENTER**.

8. The display appears as follows:

```
CALIBRATION
COMPRESSION
Gain adjust
Apply full scale load
10.000 lbF +/-20%,
then press ENTER.
```

Apply a weight equal to the full scale of the instrument, then press **ENTER**.

9. After displaying "Please wait..." the display appears as follows:

```
CALIBRATION
COMPRESSION

Ensure no load,
then press ZERO.
```

Remove the load applied in Step 8, leave the fixtures in place, then press **ZERO**.

10. The display appears as follows:

```
CALIBRATION
COMPRESSION
Apply load
1 OF 5
Enter load:
2.000 lbF
Press ENTER.
```

Use the **UP** and **DOWN** keys to adjust the load value as required. The load values default to even increments, as indicated by the previously entered number of data points (even increments are recommended for best results). For example, if a 50 lbF capacity gauge is calibrated, and 5 data points were selected, the load values will default to 10, 20, 30, 40, and 50 lb. Apply the calibration load. Then press **ENTER**.

Repeat the above step for the number of data points selected.

11. After all the compression calibration points have been completed, the display appears as follows:

```
CALIBRATION  
COMPRESSION COMPLETE  
Reverse direction  
for tension.  
Attach necessary  
weight fixtures,  
then press ENTER.
```

Press **ENTER**.

12. The display appears as follows:

```
CALIBRATION  
  
To invert the  
display, press the  
DIRECTION button,  
then press ENTER
```

Reverse the orientation of the load cell shaft by rotating the gauge 180 degrees. Press **DIRECTION** to invert the display. Then attach weight fixtures. The following screens will step through the same procedure as with the compression direction. Proceed in the same manner.

13. At the completion of the tension calibration, the display appears as follows:

```
CALIBRATION  
COMPLETE  
  
Save & exit  
Exit w/o saving
```

To save the calibration information, select "Save & exit". To exit without saving the data select "Exit without saving".

14. Any errors are reported by the following screens:

CALIBRATION  
Units must be gF.  
Please try again  
Press ENTER.

Displayed at the start of calibration if a disallowed unit is selected.

CALIBRATION  
Load not stable.  
Please try again.

Ensure that the load is not swinging, oscillating, or vibrating in any manner. Then try again.

CALIBRATION  
COMPRESSION  
Load too low.  
Please try again.

The calibration weight does not match the set value.

CALIBRATION  
TENSION  
Load too close  
to previous.  
Please try again.

The entered calibration point is too close to the previous point.

## 11 PASSWORDS

Two separate passwords may be set to control access to the Calibration section and to the menu and other keys. To access the passwords setup screen, select **Passwords** from the menu. The display appears as follows:

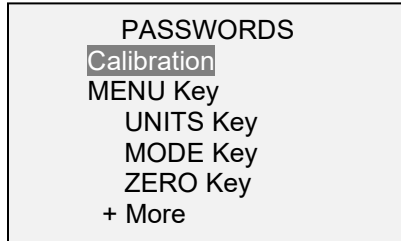

Select "+ More" for additional options:

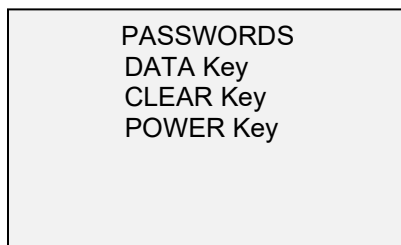

### 11.1 Calibration Password

Select **Calibration** from the sub-menu. The display appears as follows:

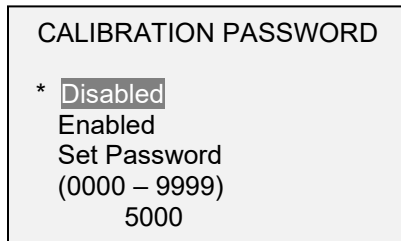

To set the password, select **Enabled**, then **Set Password**. Use the **UP** and **DOWN** keys to increment and decrement the value, from 0 to 9999. When the desired value has been selected, press **ENTER**, then **ESC** to exit the sub-menu.

### 11.2 Menu Key Password

If enabled, every time the **MENU** key is selected, a password must be provided. Select **Menu Key** from the sub-menu. Follow the same procedure as described in the previous sub-section.

### 11.3 Locking Out Other Keys

Other keys may be locked out individually. Select any combination of keys (**UNITS**, **MODE**, **ZERO**, **DATA**, **CLEAR**, **POWER**) by pressing **ENTER** in the **Passwords** sub-menu. Pressing a locked key will prompt the message "KEY PROTECTED" instead of performing the key's function.

### 11.4 Password Prompts

If passwords have been enabled, the following will be displayed when pressing the **MENU** key or accessing the **Calibration** section:



Use the **UP** and **DOWN** keys to select the correct password, then press **ENTER** to continue.

If the incorrect password has been entered, the display appears as follows:

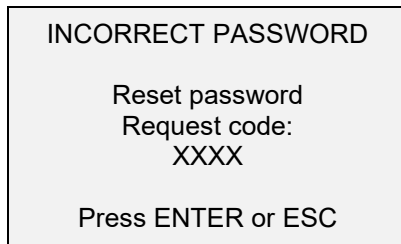

To re-enter the password, press **ESC** to exit to the home screen. Then, access the desired function and enter the password again when prompted.

If the password has been misplaced, it can be reset. Press **ENTER** to generate a *request code*. The *request code* must be supplied to Mark-10 or a distributor, who will then provide a corresponding *authorization code*. Enter the *activation code* to disable the password.

## 12 OTHER SETTINGS

### 12.1 Automatic Shutoff

The gauge may be configured to automatically power off following a period of inactivity while on battery power. Inactivity is defined as the absence of any key presses or load changes of 100 counts or less. To access these settings, select **Automatic Shutoff** from the menu. The display appears as follows:

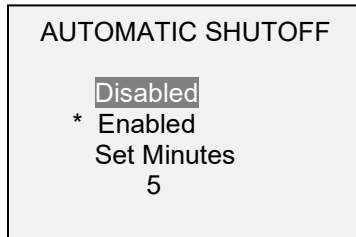

Selection	Description
<b>Disabled</b>	Disable automatic shutoff.
<b>Enabled</b>	Enable automatic shutoff.
<b>Set Minutes</b>	The length of time of inactivity. Available settings: 5-30, in 5 minute increments.

**Note:** If the AC adapter is plugged in, the gauge will ignore these settings and remain powered on until the **POWER** key is pressed.

### 12.2 Backlight

Although the backlight may be turned on and off at any time by pressing the **BACKLIGHT** key, there are several available initial settings (applicable upon powering on the gauge). To access these settings, select **Backlight** from the menu. The display appears as follows:



Selection	Description
<b>Off</b>	Backlight to be off upon powering on the gauge.
<b>On</b>	Backlight to be on upon powering on the gauge.
<b>Auto</b>	Backlight to be on upon powering gauge, but will shut off after a period of inactivity (as defined in the <b>Automatic Shutoff</b> sub-section). The backlight will turn on again when activity resumes. The length of time of inactivity is programmed in minutes via the <b>Set Minutes</b> parameter. Available settings: 1-10, in 1 minute increments.

**Note:** If the AC adapter is plugged in, the gauge will ignore these settings and keep the backlight on.

### 12.3 LCD Contrast

The contrast of the display may be adjusted. Select **LCD Contrast** from the menu. The screen appears as follows:



Press **ENTER** to modify the contrast. Select a value from 0 to 25, 25 producing the most contrast.

### 12.4 Tones

Audible tones can be enabled for all key presses and alerts, such as overload, set point value reached, etc. The Set Point alert can be configured to be either a momentary tone or a continuous tone (until the load is restored to a value between the set points). To configure the functions for which audible tones will apply, select **Tones** from the menu. The screen appears as follows:

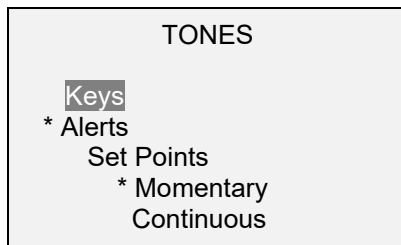

### 12.5 Initial settings

This section is used to configure the initial settings upon powering on the gauge. The initial units of measurement and the primary reading measurement mode may be configured. To access these settings, select **Initial Settings** from the menu. The screen appears as follows:

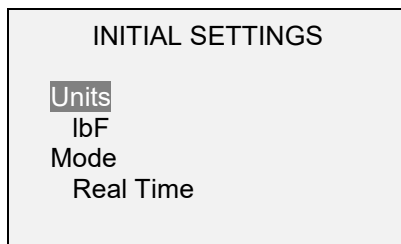

The default values are lbF and Real Time.



## 12.6 Restore Default Settings

Default factory settings can be restored by selecting **Restore Defaults** from the menu. The settings may be found in the **Specifications** section. The screen appears as follows:



## 12.7 Information / Welcome Screen

The following screen is displayed at power-up and can be accessed at any time by selecting **Information** from the menu:

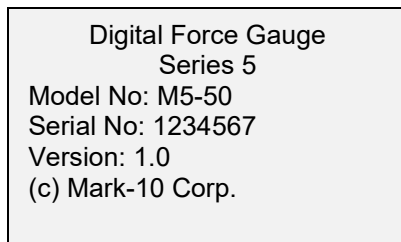

## 13 SPECIFICATIONS

### 13.1 General

<b>Accuracy:</b>	±0.1% of full scale
<b>Sampling rate:</b>	7,000 Hz
<b>Power:</b>	AC or rechargeable battery. Low battery indicator appears when battery level is low, and gauge powers off automatically when power reaches critical stage.
<b>Battery life:</b>	<b>Backlight on:</b> up to 7 hours of continuous use <b>Backlight off:</b> up to 24 hours of continuous use
<b>Measurement units:</b>	lbF, ozF, gF, kgF, N, kN, mN, COF (depending on model)
<b>Outputs:</b>	<b>USB / RS-232:</b> Fully configurable up to 115,200 baud. Includes Gauge Control Language 2 for full computer control. <b>Mitutoyo (Digimatic):</b> Serial BCD suitable for all Mitutoyo SPC-compatible devices. <b>Analog:</b> ±1 VDC, ±0.25% of full scale at capacity, <b>General purpose:</b> Three open drain outputs, one input. <b>Set points:</b> Three open drain lines.
<b>Safe overload:</b>	200% of full scale (display shows "OVER" at 110% and above)
<b>Weight:</b>	<b>M5-012 - M5-100, M5-2-COF:</b> 1.0 lb [0.45 kg] <b>M5-200 - M5-500:</b> 1.2 lb [0.54 kg] <b>M5-750 – M5-2000:</b> 1.8 lb [0.82 kg]
<b>Included accessories:</b>	Carrying case, chisel, cone, V-groove, hook, flat, extension rod, thread adapter (M5-1000 only), AC adapter, battery, USB cable, NIST-traceable certificate of calibration with data
<b>Environmental requirements:</b>	40 - 100°F, max. 93% humidity, non-condensing
<b>Warranty:</b>	3 years (see individual statement for further details)
<b>Literature &amp; Software:</b>	<b>Download at:</b> <a href="http://www.mark-10.com/downloads">www.mark-10.com/downloads</a>

## 13.2 Factory Settings

Parameter	Setting
Set points	
Upper	Disabled (defaults to 80% of full scale, compression, when enabled) M5-2-COF: Disabled (defaults to 0.8 COF [tension] when enabled)
Lower	Disabled (defaults to 40% of full scale, compression, when enabled) M5-2-COF: Disabled (defaults to 0.4 COF [tension] when enabled)
Filters	
Current	8
Displayed	512
Average mode	Disabled (enabled for M5-2-COF gauge)
Initial Delay	0
Trigger Force	10% of full scale
Averaging Time (sec.)	5.0
External Trigger	Disabled
DATA Key Functions	
RS-232/USB Output	Enabled
Mitutoyo Output	Disabled
Memory Storage	Enabled
Serial/USB	
RS-232 Output Selected	Enabled
USB Output Selected	Disabled
Baud Rate	115,200
Data Format	Numeric + units
Auto Output	Disabled
Outputs per Sec.	125
Mitutoyo BCD Output	Disabled
Tones	
Keys	Enabled
Alerts	Enabled
Set Points	Momentary
Automatic Shutoff	Enabled
Minutes	5
Backlight	Auto
Minutes	1
Initial Settings	
Units	lbF M5-2-COF: COF
Mode	Real Time M5-2-COF: Average
COF (M5-2-COF only)	Enabled
Sled Weight	200 g
Passwords	All passwords disabled

### 13.3 Capacity x Resolution

Model	lbF	ozF	kgF	gF	N	kN	mN
<b>M5-012</b>	0.12 x 0.00002	2 x 0.0005	-	50 x 0.01	0.5 x 0.0001	-	500 x 0.1
<b>M5-025</b>	0.25 x 0.00005	4 x 0.001	-	100 x 0.02	1 x 0.0002	-	1000 x 0.2
<b>M5-05</b>	0.5 x 0.0001	8 x 0.002	-	250 x 0.05	2.5 x 0.0005	-	2500 x 0.5
<b>M5-2*</b>	2 x 0.0005	32 x 0.01	1 x 0.0002	1000 x 0.2	10 x 0.002	-	-
<b>M5-5</b>	5 x 0.001	80 x 0.02	2.5 x 0.0005	2500 x 0.5	25 x 0.005	-	-
<b>M5-10</b>	10 x 0.002	160 x 0.05	5 x 0.001	5000 x 1	50 x 0.01	-	-
<b>M5-20</b>	20 x 0.005	320 x 0.1	10 x 0.002	10000 x 2	100 x 0.02	-	-
<b>M5-50</b>	50 x 0.01	800 x 0.2	25 x 0.005	25000 x 5	250 x 0.05	-	-
<b>M5-100</b>	100 x 0.02	1600 x 0.5	50 x 0.01	50000 x 10	500 x 0.1	-	-
<b>M5-200</b>	200 x 0.05	3200 x 1	100 x 0.02	-	1000 x 0.2	1 x 0.0002	-
<b>M5-300</b>	300 x 0.1	4800 x 2	150 x 0.05	-	1500 x 0.5	1.5 x 0.0005	-
<b>M5-500</b>	500 x 0.1	8000 x 2	250 x 0.05	-	2500 x 0.5	2.5 x 0.0005	-
<b>M5-750</b>	750 x 0.5	12000 x 10	375 x 0.2	-	3750 x 2	3.75 x 0.002	-
<b>M5-1000</b>	1000 x 0.5	16000 x 5	500 x 0.2	-	500 x 10	5 x 0.002	-
<b>M5-1500</b>	1500 x 1	24000 x 20	750 x 0.5	-	7500 x 5	7.5 x 0.005	-
<b>M5-2000</b>	2000 x 1	32000 x 20	1000 x 0.5	-	1000 x 0.5	10 x 0.005	-

\* Model M5-2-COF also includes the COF unit, with capacity of 5 and resolution of 0.001. The capacity is variable, depending on sled weight. The value of 5 represents the capacity based on the default sled weight of 200 g.

13.4 Dimensions (in [mm])

M5-012 – M5-500

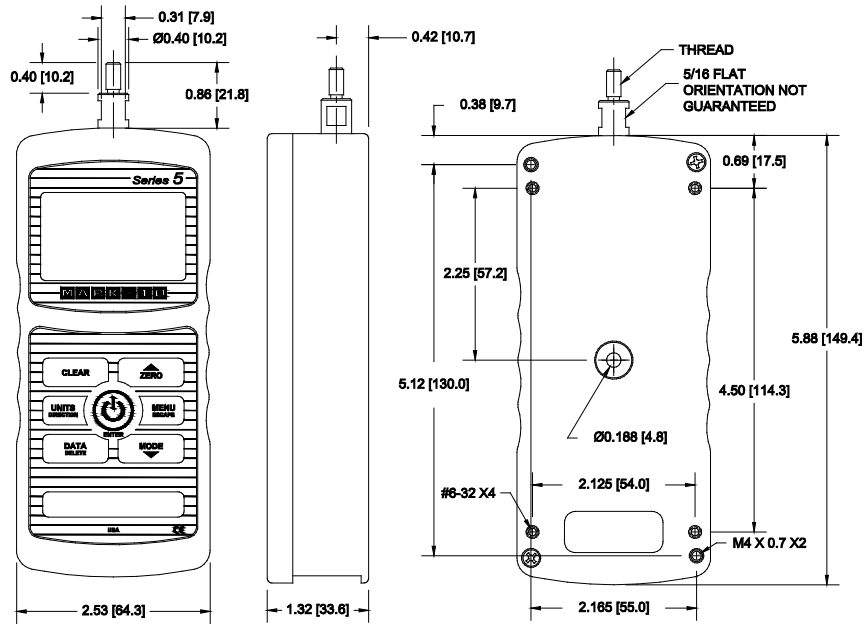

	Thread	Flat
M5-012 – M5-100, M5-2-COF	#10-32M UNF	5/16 [7.94]
M5-200 – M5-500	5/16-18M UNC	5/16 [7.94]

M5-750 – M5-2000

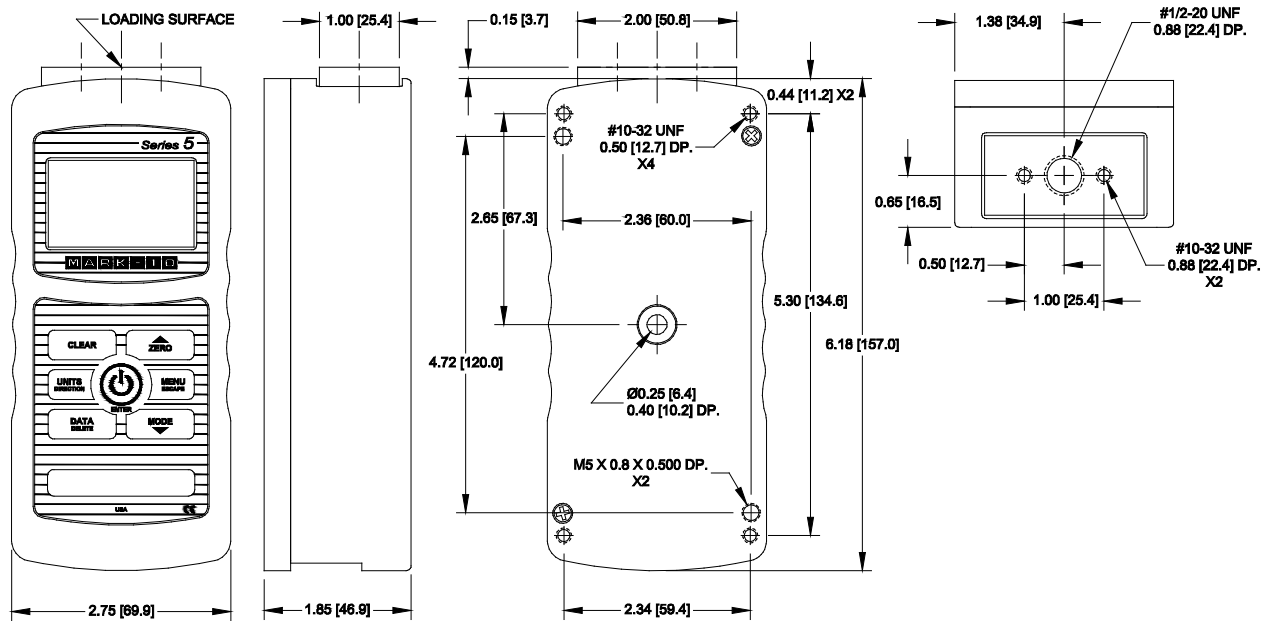

**NOTES:**



*Mark-10 Corporation has been an innovator in the force and torque measurement fields since 1979. We strive to achieve 100% customer satisfaction through excellence in product design, manufacturing and customer support. In addition to our standard line of products we can provide modifications and custom designs for OEM applications. Our engineering team is eager to satisfy any special requirements. Please contact us for further information or suggestions for improvement.*



*Force and torque measurement engineered better*

**Mark-10 Corporation**

11 Dixon Avenue  
Copiague, NY 11726 USA  
1-888-MARK-TEN  
Tel: 631-842-9200  
Fax: 631-842-9201  
Internet: [www.mark-10.com](http://www.mark-10.com)  
E-mail: [info@mark-10.com](mailto:info@mark-10.com)