

Models:

F105 | F305 | F505 | F505H
F755 | F755S | F1505 | F1505S

IntelliMESUR[®] Software

User's Guide

↓ TABLE OF CONTENTS ↓

TABLE OF CONTENTS

TABLE OF CONTENTS.....	1
1 OVERVIEW.....	3
1.1 Intended purpose.....	4
1.2 Models F105 / F305 / F505 / F505H.....	4
1.3 Models F755 / F755S / F1505 / F1505S.....	6
2 SAFETY.....	8
2.1 Checks and procedures.....	8
2.2 Connecting power.....	9
2.3 Emergency Stop.....	9
3 SETUP.....	10
3.1 Intended Use.....	10
3.2 Moving the frame into position.....	10
3.3 Mounting and placement.....	10
3.4 Limit switches.....	10
3.5 Connections and outputs.....	11
3.6 Installing Series FS05 Force Sensors to Models F105 / F305 / F505 / F505H.....	12
3.7 Installing Series R07 Force Sensors to Models F755 / F755S / F1505 / F1505S.....	13
3.8 Installing Series FS05 Force Sensors to Models F755 / F755S / F1505 / F1505S.....	13
3.9 Installing a Third-Party Force Sensor.....	14
3.10 Installing the IntelliMESUR control panel.....	15
4 INSTALLING INTELLIMESUR.....	16
4.1 Hardware Requirements.....	16
4.2 Installation.....	17
5 INTELLIMESUR BASICS.....	18
5.1 Opening IntelliMESUR.....	18
5.2 Home Screen.....	19
6 SETTINGS.....	21
6.1 Information.....	21
6.2 User Management.....	22
6.3 Calibration.....	24
6.4 Preferences.....	24
6.5 Optional Functions.....	26
6.6 Overloads.....	27
6.7 Deflection Compensation.....	27
6.8 Update Software and Update Firmware.....	27
7 MANUAL CONTROL.....	28
7.1 Load and Distance Measurement.....	29
7.2 Motion Control Modes.....	29
7.3 Height / Length Offset.....	30

7.4 Set Home	31
8 CREATING A BASIC TEST	31
8.1 Load Limit	31
8.2 Distance Limit	42
8.3 Break Limit	43
8.4 Load Hold.....	43
8.5 Cycle Test.....	43
8.6 COF Test	47
9 CREATING A MULTI-STEP TEST.....	49
9.1 Multi-Step Overview.....	49
9.2 Step Types.....	51
10 RUNNING A TEST.....	54
10.1 Favorite Tests	54
10.3 Results View	59
10.4 Data Details View.....	63
10.5 Creating a Report.....	64
10.6 Recalling Previous Data	67
11 CALIBRATION	67
11.1 Force Sensor Calibration	67
11.2 Speed and Distance Calibration	72
11.3 Test Frame Deflection Compensation	72
12 MAINTENANCE & SERVICE – MODELS F105 / F305 / F505 / F505H.....	73
12.1 Physical Maintenance	73
12.2 Removing the Motor Drive Unit (MDU).....	77
13 MAINTENANCE & SERVICE – MODELS F1505 / F1505S / F755 / F755S.....	78
13.1 Physical Maintenance	78
13.2 Removing the Motor Drive Unit (MDU).....	80
14 ACCESSORY INSTALLATION.....	81
14.1 Installing the External Emergency Switch Connector.....	81
14.2 Separating the Column From The Base / Column Extension Installation – F105 / F305 / F505 / F505H	83
14.3 Installing a double column extension – F105 / F305 / F505.....	86
15 UPDATING SOFTWARE AND FIRMWARE.....	87
16 SPECIFICATIONS & DIMENSIONS	88
16.1 Specifications.....	88
16.2 Dimensions IN [MM]	89

1 OVERVIEW

1.1 Intended purpose



Series F test frames produce tension and compression forces. When combined with a force sensor and IntelliMESUR software, users can measure force and distance, set up a test, record, analyze, and output data. Test frames are offered in several models, corresponding to different heights and force ranges.

Series FS05 or Series R07 force sensors are required for use with these test frames.

IntelliMESUR software is required to run Series F test frames and extract force and distance data from the test frame and force sensor. IntelliMESUR is offered pre-configured on a tablet with mounting bracket, or as a standalone software application which may be installed on the user's device.

1.2 Models F105 / F305 / F505 / F505H

1.2.1 Included items

Qty.	Description
1	Control panel, mounting bracket, and hardware (-IMT models only)
1	Mounting bracket, column end (F505H only)
1	USB flash drive containing software installation files (-IM models only)
1	USB dongle (-IM models only)
1	USB cable -IMT models: right-angle C to B -IM models: A to B
1	Accessories kit: <ul style="list-style-type: none"> - #10-32M medium hook - 5/16-18M large hook - #10-32F 2" diameter compression plate - #10-32 M/F 2" extension rod - #10-32 F/F coupler - Adapter, 5/16-18M to #10-32F - Set screw, #10-32 x 3/4" (1) - Hex nut, #10-32 (2) - Allen wrench set
1	Power cord
1	Allen wrench set

1.2.2 Physical features

Note the following physical features. The user's guide will reference this terminology. Model F305-IMT is shown below:

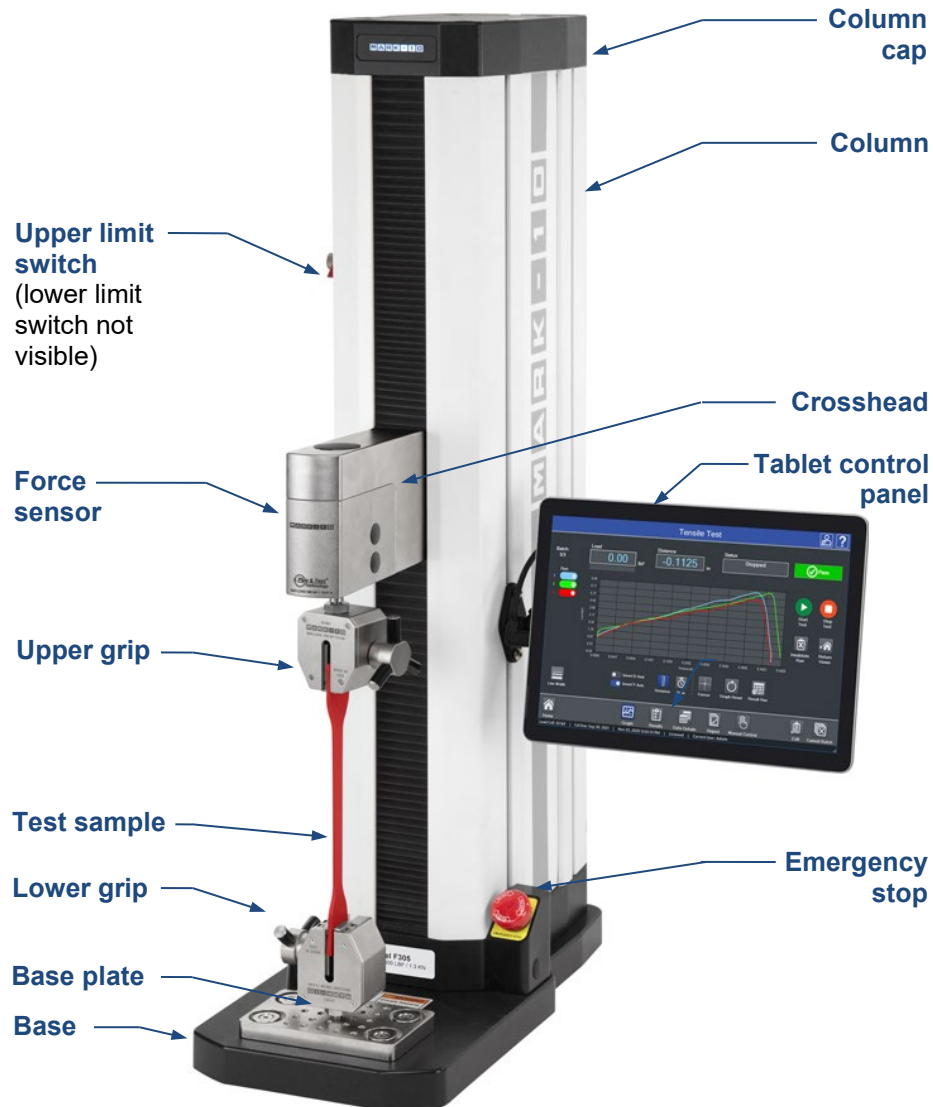

1.2.3 Installing the Column End Cap for F505H

The end cap is shipped in a separate box within the main box for the F505H test frame. Line it up with the right end of the column, then install with the four included screws, as shown below:



1.3 Models F755 / F755S / F1505 / F1505S

1.3.1 Included items

Qty.	Description
1	Control panel, mounting bracket, and hardware (-IMT models only)
1	USB flash drive containing software installation files (-IM models only)
1	USB dongle (-IM models only)
1	USB cable -IMT models: right-angle C to B -IM models: A to B
1	Eye end kit for base
2	Lock ring for eye end
2	Spanner wrench
1	Power cord
1	Allen wrench set

1.3.2 Physical features

Note the following physical features. The user's guide will reference this terminology. Model F1505-IMT is shown below:

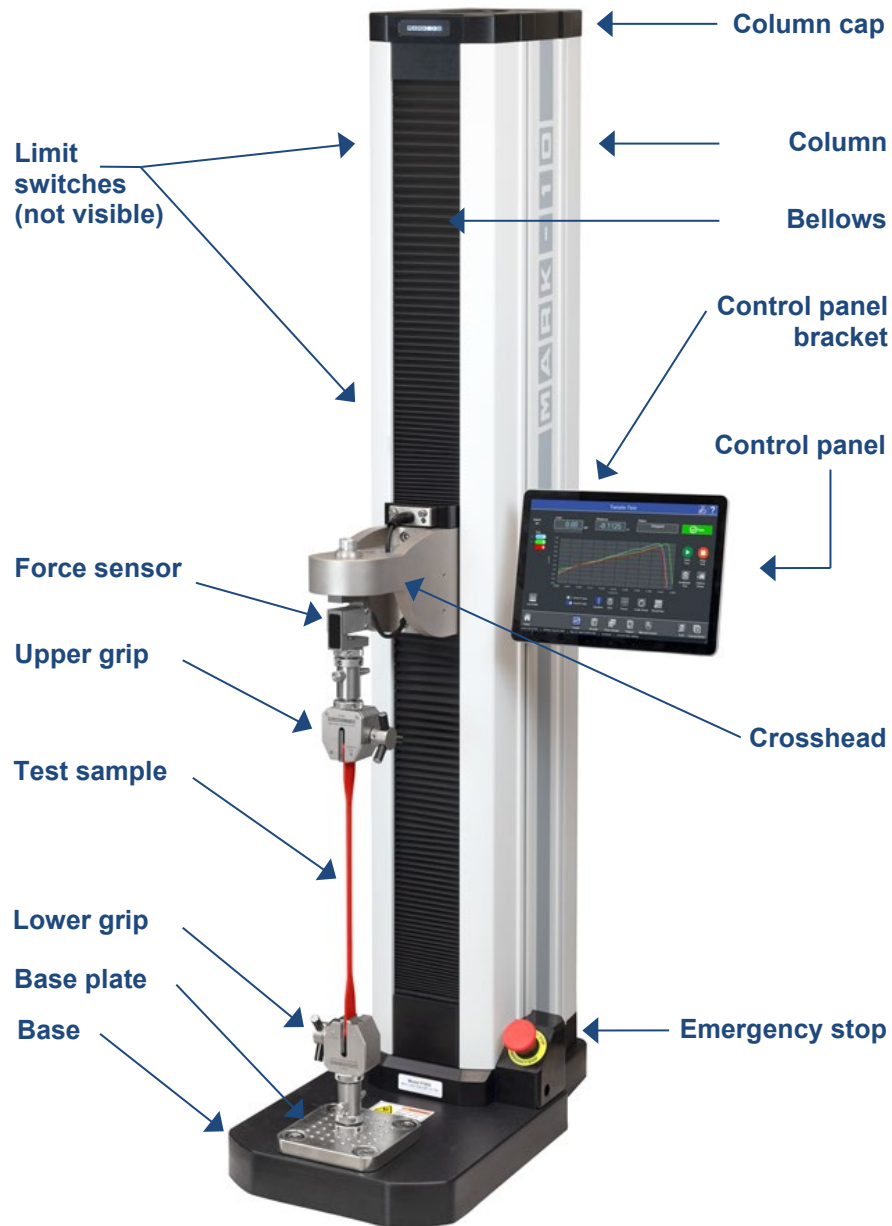

2 SAFETY

Safety features provided by Series F test frames may be impaired if equipment is used in a manner not specified by Mark-10.

2.1 Checks and procedures

The following safety checks and procedures should be performed before and during operation:

1. Always consider the characteristics of the sample being tested before initiating a test. A risk assessment should be carried out beforehand to ensure that all safety measures have been addressed and implemented.
2. Wear eye and face protection when testing, especially when testing brittle samples that have the potential to shatter under force. Be aware of the dangers posed by potential energy that can accumulate in the sample during testing. Extra bodily protection should be worn if a destructive failure of a test sample is possible.
3. Keep away from moving parts of the test frame. Loose articles of clothing should not be worn. Long hair should be covered to avoid a hazardous situation. A Crush Hazard warning label is located on the base of the test frame. It appears as follows:



Definition: Keep any body parts and clothing clear of the area between the base of the test frame and the moving crosshead.

4. Ensure that grips and fixtures are positioned to ensure axial load with respect to the load axis of the force sensor. Ensure that they secure the sample in such a way that it is prevented from slipping out during a test, which is a safety risk to the operator and others in the vicinity. If using a grip or fixture from a supplier other than Mark-10, ensure that it is constructed of suitably rugged materials and components.
5. In those applications where samples can shatter, or other applications that could lead to a hazardous situation, use of a shield is strongly recommended.
6. When the test frame is not in use, ensure that the power is turned off to prevent accidental engagement of any of the controls.

2.2 Connecting power

Plug one end of the power cord into its receptacle at the rear of the stand and the other end into a wall outlet with local earth ground (3-prong connector).

Before turning on power, the following safety checks and procedures should be performed:

1. Never operate the test frame if there is any visible damage to the power cord or the test frame itself. The test frame is powered by 110V/220V. Any contact with this high voltage can cause serious injury or even death.
2. Ensure that the test frame is kept away from water or any electrically conductive liquids at all times.
3. Make sure the electrical outlet powering the test frame has local earth ground (3-prong connector).
4. The test frame should be serviced by a trained technician only. Power must be disconnected before the column covers are removed.
5. Never use a detachable mains supply cord with inadequate ratings.

After the above safety checks and procedures have been performed, the test frame may be powered on and is ready for operation.

2.3 Emergency Stop

The emergency stop switch is located where the lower right end of the column is attached to the base, as shown below:

Models F105 / F305 / F505 / F505H



Models F755 / F755S / F1505 / F1505S



Press down to stop crosshead motion. Rotate clockwise to release the switch.

3 SETUP

3.1 Intended Use

Series F test frames with IntelliMESUR software are designed for tension and compression force measurement applications. The test frame applies force, while a force sensor measures the applied forces. IntelliMESUR software displays force and position information, and includes analytical tools to help quality control, engineering, and manufacturing professionals determine the mechanical properties and quality of their samples.

3.2 Moving the frame into position

Place the frame on a sturdy, clean, and level work area free from vibration.

In Models F755, F755S, F1505, and F1505S, a recessed lifting hook is located at the top of the column, for ease of lifting, as shown below:

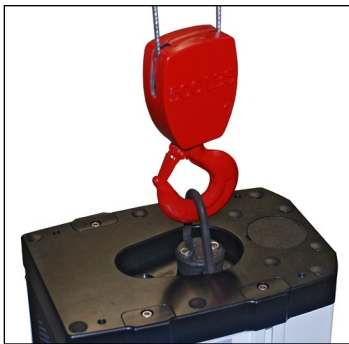

For Models F105, F305, F505, and F505H frames, orient the rear of the test frame towards the edge of a table, tilt backwards, then lift underneath the base and underneath the rear of the column.

3.3 Mounting and placement

Place the test frame on a clean, flat and level work area free from vibration. Ensure that the rear of the column is easily accessible, so that the power cord can be disconnected in an emergency.

It is suggested to mount the test frame to a work bench via screws fastened into the underside of the base. Failure to properly mount the test frame may make it more vulnerable to tipping, especially if a column extension is used, causing a hazardous situation.

3.4 Limit switches



Upper and lower limit switches are supplied to stop travel in both directions. They may be moved up and down by loosening and tightening the thumb screws, as shown at left.

A dual-graduated inch/mm ruler adjacent to the limit switches can be helpful for positioning.

3.5 Connections and outputs

The following connections and outputs are supplied in the rear of the test frame, as shown in the illustration below:



Auxiliary Limits

For interfacing an external limit switch, such as an interlock for a shield door. A pin diagram is shown in the next sub-section.

USB port

For interfacing with a Windows device running IntelliMESUR.

Control Panel

Inactive.

External Emergency Switch

May be used to connect an optional external emergency stop switch. May be installed at the factory at time of order, or installed in the field as a retrofit. Required for use with optional shields. Refer to the **Accessory Installation** section for instructions.

Power switch

Refer to the **Connecting Power** sub-section for important safety information.

Power plug receptacle

Plug the power cord in here. Refer to the **Connecting Power** sub-section for important safety information.

3.5.1 Auxiliary Limits pin diagram

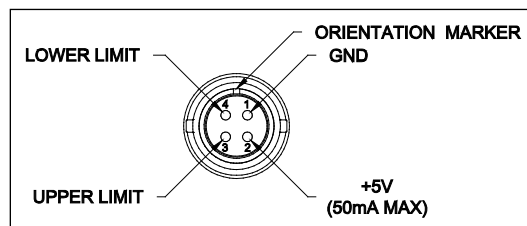

Note that when pins 3 and 4 are not connected, the auxiliary limits are inactive. When the +5V from pin 2 is connected to either pin 3 or pin 4, the respective limit becomes active and the crosshead is prevented from movement in that direction.

3.6 Installing Series FS05 Force Sensors to Models F105 / F305 / F505 / F505H



To avoid overload and damage, select a force sensor with sufficient capacity to accommodate the application.

Series FS05 force sensors mount directly to the crosshead. Once the test frame is in a stable and secure position, install the force sensor by matching the gold-plated pads on the top surface with the pins in the underside of the crosshead, as shown below:



While holding the force sensor in place with one hand, use an Allen wrench with the other hand to tighten the screw that joins the force sensor to the crosshead, as shown below:



Optionally cover the screw head with the included black plastic cap.

Grips and fixtures may be threaded onto the threaded shaft protruding from the bottom of the force sensor, for example:



To avoid damage to the internal load cell or shaft, do not use tools to tighten grips or attachments onto the shaft. Hand-tighten only.

3.7 Installing Series R07 Force Sensors to Models F755 / F755S / F1505 / F1505S

Install the sensor to the underside of the crosshead using the supplied socket head screw and hardware. Plug the connector into the receptacle in the top front surface of the crosshead, then fasten the thumb screws into the crosshead, as shown below:



Grips and fixtures may be threaded onto the underside of the sensor.

3.8 Installing Series FS05 Force Sensors to Models F755 / F755S / F1505 / F1505S

Series FS05 force sensors may be installed via the optional AC1083 adapter, as shown below:



3.9 Installing a Third-Party Force Sensor



Before installing the sensor, refer to the Model PTA / PTAF user's guide for complete instructions.

3.9.1 Models F105 / F305 / F505 / F505H

Using the optional Model PTAF adapter, a third-party force sensor may be mounted to the test frame. Insert a screw of sufficient length and appropriate thread size through the crosshead, through the PTAF, and into the force sensor, as shown in the following example:



3.9.2 Models F755 / F755S / F1505 / F1505S

Using the optional Model PTAF adapter and AC1083 adapter, a third-party force sensor cell may be mounted to the test frame. Insert a screw of sufficient length and appropriate thread size through the crosshead, through the AC1083 adapter, through the PTAF, and into the force sensor, as shown in the following example:



3.10 Installing the IntelliMESUR control panel

For test frame part numbers ending in “-IMT”, for example Model F305-IMT, a Windows tablet with attached ball mount and mounting bracket are included, packaged separately.

The mounting arm is pre-installed into the front right slot in the test frame column via two screws, as shown below:



Loosen the knob sufficiently to slide the ball, mounted to the rear of the tablet, into the arm. Orient the tablet horizontally, with the USB-C port positioned on the left side. Adjust the viewing angle as desired, then tighten the knob.



Do not attempt to adjust the viewing angle before loosening the knob.

Connect the included USB cable between the USB-C port and the USB-B port in the rear of column, and connect the AC adapter connector, as shown below:



Plug in the AC adapter and press the Power button, in the lower right corner of the tablet. The tablet will boot up directly into the IntelliMESUR application. If not, select the IntelliMESUR icon in the Windows home screen.

4 INSTALLING INTELLIMESUR

4.1 Hardware Requirements

4.1.1 Pre-configured tablet

IntelliMESUR is pre-installed onto the tablet provided with “-IMT” model numbers, ex. F305-IMT.



To ensure optimal performance for IntelliMESUR, do not install any additional applications onto the tablet.

4.1.2 User device installation

For model numbers ending in “-IM”, a separate license is provided to install onto the user's device, provided it meets the following specifications:

- Windows 10 or later operating system
- Minimum 4GB RAM
- Minimum monitor resolution of 1310 x 885
- Minimum of two USB ports (one for a dongle, one for a cable to the test frame)

4.2 Installation

Windows Administrator privileges are required to install IntelliMESUR.

1. Insert the installation flash drive into the device's USB port, or download the zipped installation folder. Locate and double-click the file "setup.exe". The screen appears as follows:

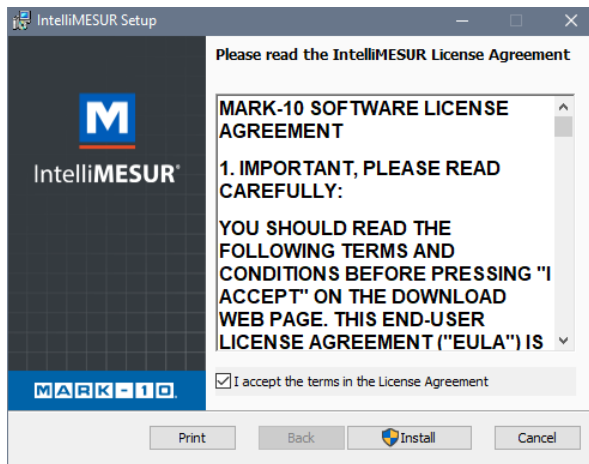

2. Accept the terms, then click Install. All required files will be installed, including the Mark-10 USB driver. When installation is complete, the screen appears as follows:

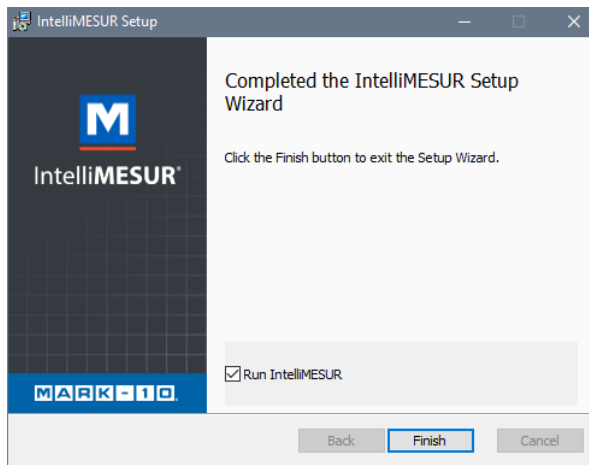

3. Click Finish and run IntelliMESUR.

5 INTELLIMESUR BASICS

5.1 Opening IntelliMESUR

Ensure that the device is connected to the test frame with a USB cable. Then open IntelliMESUR.

5.1.1 Mark-10-supplied tablet

Press the Power button. The tablet will boot directly into IntelliMESUR. If the tablet was asleep or hibernating, double-tap the IntelliMESUR icon.

5.1.2 Customer-supplied Windows device

1. Insert the dongle into a USB port, as shown below:



The dongle contains a one-seat license. It must be plugged in at all times to run IntelliMESUR. To run IntelliMESUR on a different device, install the application, then move the dongle to that device.

2. Double-tap or double-click the IntelliMESUR icon.
If the dongle is not installed, IntelliMESUR prompts a message asking if you would like to use a 90-day trial. Make the appropriate selection. The trial is fully functional, and allows full use.
3. After plugging in the dongle or starting the trial, a login screen will appear as follows, if **User Login** is enabled:







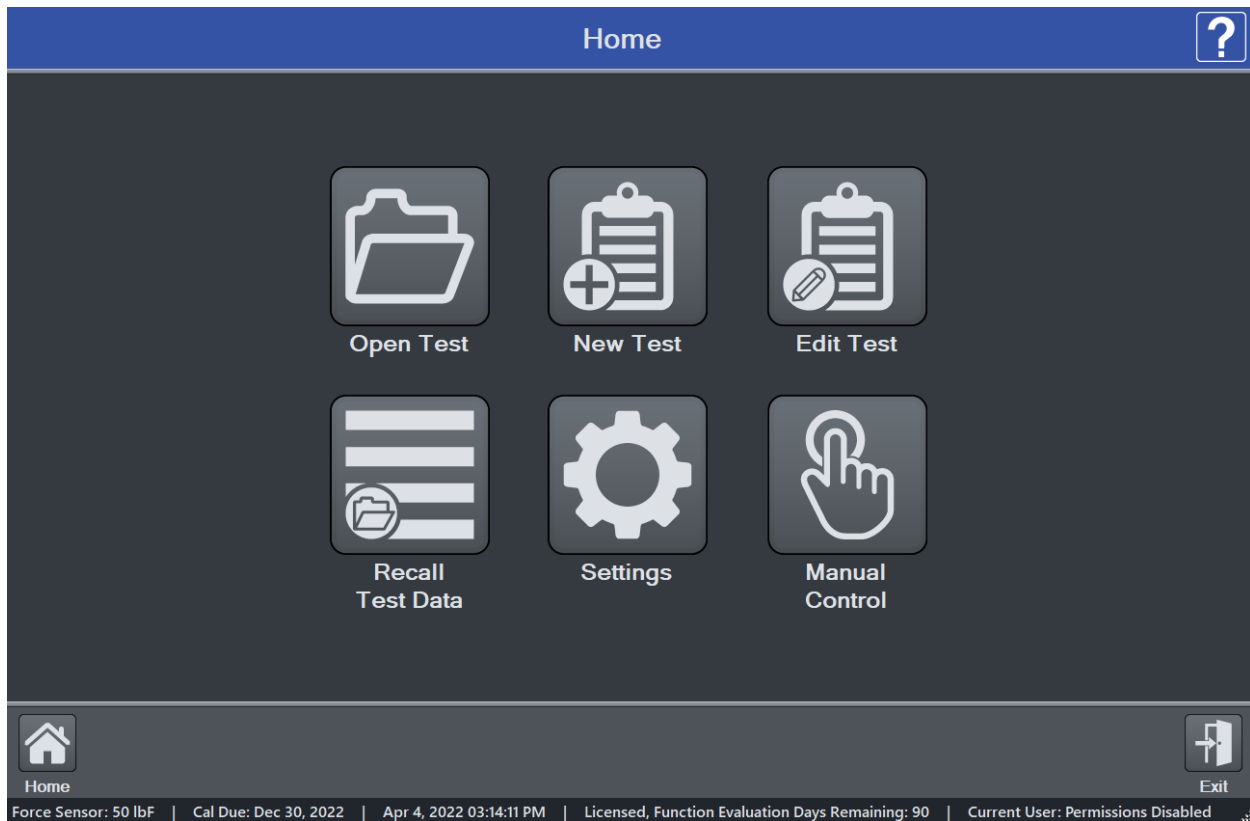

Otherwise, IntelliMESUR opens directly to the **Home** screen.

5.2 Home Screen



IntelliMESUR launches into the Home Screen, with the following selections:

-  **Open Test**
Recall a previously saved test.
-  **New Test**
Create a new test.
-  **Edit Test**
Edit the parameters of a previously saved test.
-  **Recall Test Data**
Recall data from previously saved test runs.
-  **Settings**
Includes preferences, calibration, overload log, and other functions.
-  **Manual Control**
Manually control the up and down motion of the test frame, and see live load, peak load, and live distance.

Lower Footer

Within the lower footer, note the following selections:



Home

This icon is present in most screens, and links back to the Home screen.



Reconnect

If the test frame has been disconnected, then reconnected, select this button to restore communication.



Exit

Select to exit the software. If running IntelliMESUR on a Mark-10-supplied tablet, a prompt will offer the user two choices:

- Exit into *Windows*
- Exit and shut down the tablet

Bottom Footer

Along the bottom edge of all IntelliMESUR screens, the following information is always displayed, from left to right:

- Force sensor capacity or “Test Frame Not Connected” message
- Connection status of the test frame
- Calibration status of the force sensor
- Date and time
- License / demo time status (see following section)
- Current user



Question Mark

Select this button at any time to be directed to the PDF User's Guide.

5.1.3 90-day trial

IntelliMESUR can be run as a 90-day fully-functional trial, without a license. The number of days remaining is indicated when launching the application, and can be viewed at any time in the **Information** screen or the **bottom footer**, visible at all times:

Trial Mode Days Remaining: 90

Optional functions may be evaluated for 90 days. If an evaluation is in progress, the number of remaining days is shown in the **bottom footer**:

Licensed, Function Evaluation Days Remaining: 90

6 SETTINGS



6.1 Information

Contains serial numbers, software and firmware versions, and other information about the equipment. The screen appears as follows:

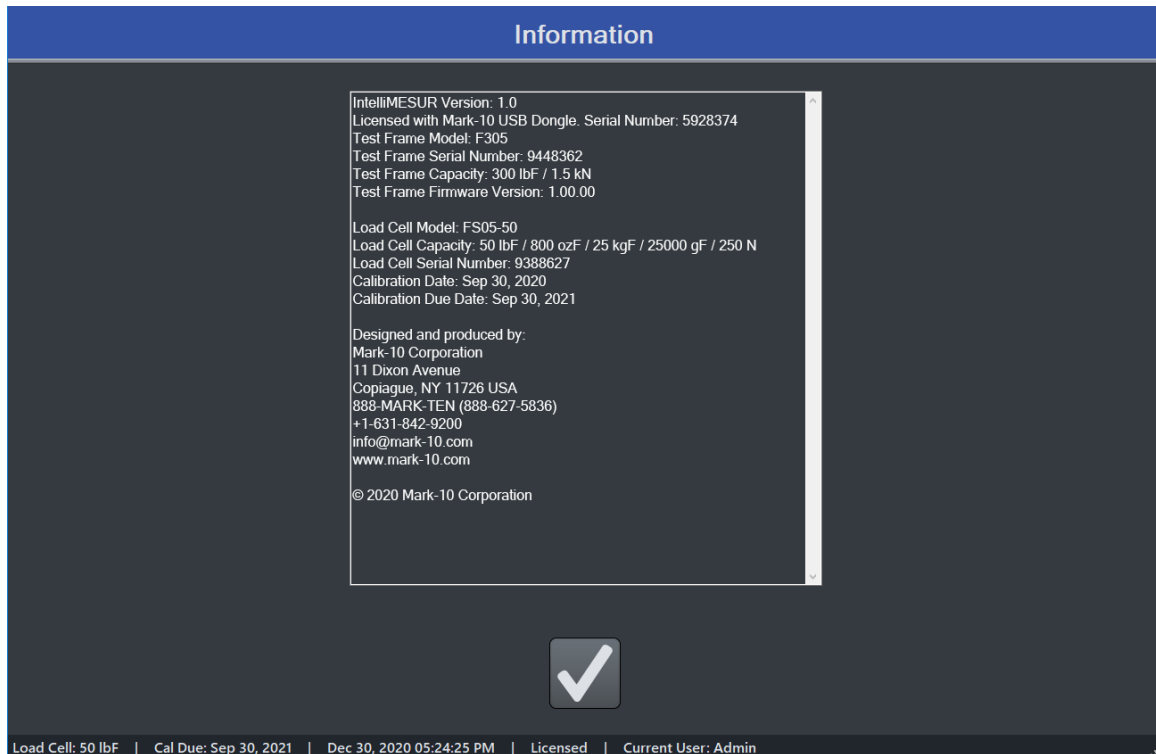

6.2 User Management

6.2.1 Enabling User Login

IntelliMESUR can be run with or without a user login. By default, **User Login** is not enabled. Make the appropriate selection in the following screen:

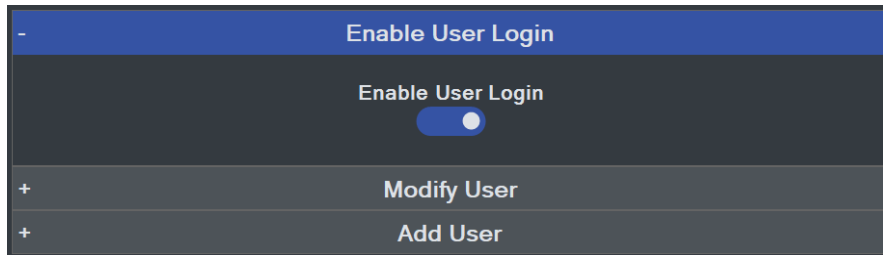

When **User Login** is enabled, the **User Login** button is always present in the upper corner of the screen, as follows:



Select this button to log out and log in as a new user.

6.2.2 User Permission Levels

IntelliMESUR provides three user permission levels, summarized as follows:

	Operator	Supervisor	Administrator
Manual Control	X	X	X
Recall and run a test	X	X	X
Create a test		X	X
Create a report	X	X	X
Calibration		X	X
Update software			X
User management			X

User name *Admin* is pre-installed, with Administrator level access. The default password is *admin*, and may be changed if desired. Refer to the following sections for instructions.

6.2.3 Adding a User

Select **Add User**. The screen appears as follows:

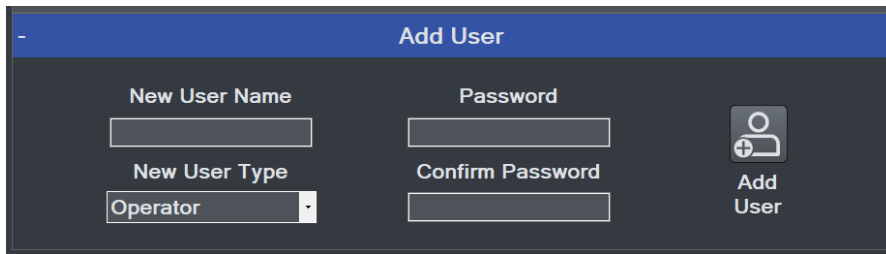

Specify the user name, type, and password, then select **Add User**.

To modify a user, select **Modify User**. The screen appears as follows:

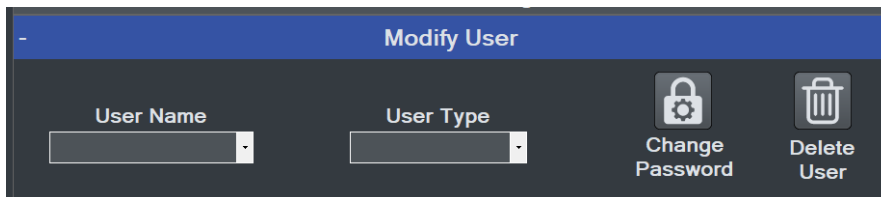

Select the user, then modify the user type, change the password, and/or delete the user. Note that the user *Admin* cannot be deleted.

To change the password, select **Change Password**. The screen appears as follows:

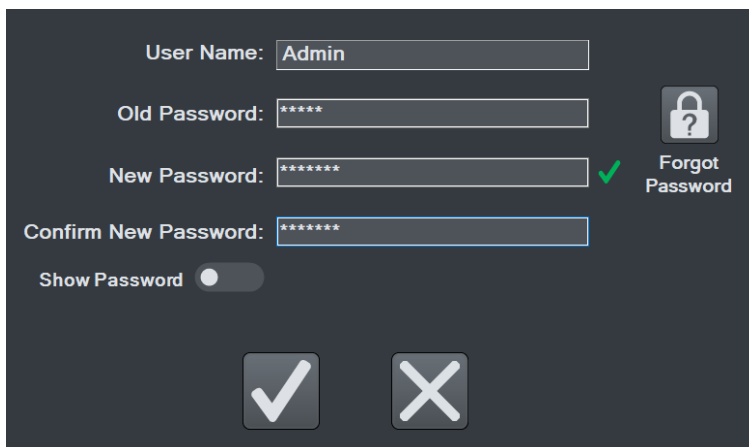

Optionally select **Show Password** to view the passwords.

Enter the requested passwords. If the password has been forgotten, select **Forgot Password**. The screen appears as follows:

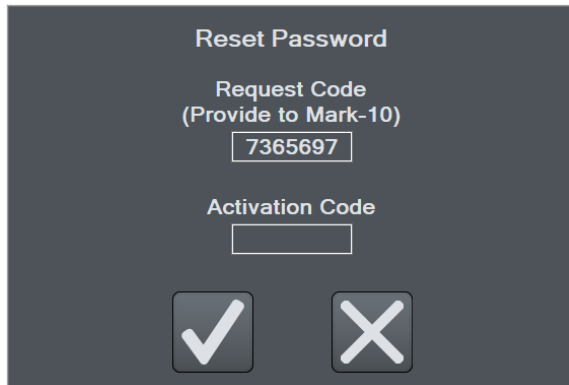

Reset Password

Request Code
(Provide to Mark-10)

7365697

Activation Code

✓ ✕

IntelliMESUR automatically generates a *request code*. Supply this code to Mark-10 or a distributor, who will then provide a corresponding *authorization code*, which allow the user to reset the password.

6.3 Calibration

Refer to the Calibration section for instructions on calibrating a force sensor.

6.4 Preferences

Default units of measure, date and time format, and other settings may be accessed from the Preferences screen. Select **Settings**, then **Preferences**.

Default Settings

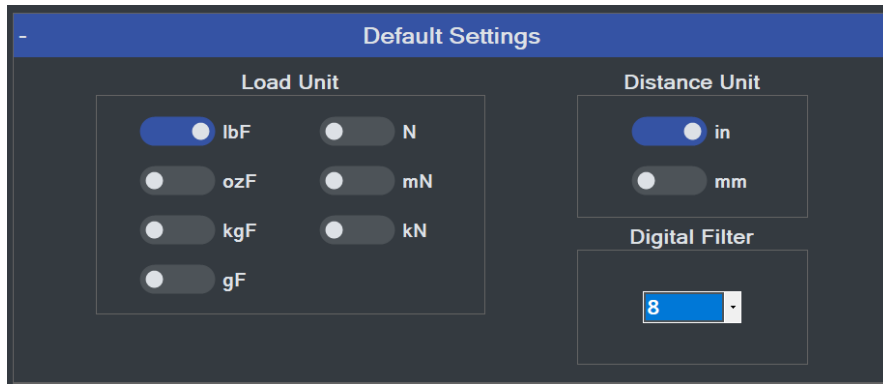

Load and Distance Units

Select the desired units of measure. Note that not all units are supported by all force sensors. Refer to the force sensor's specifications for list of supported units.

Digital Filter

The digital filter smooths out load readings in situations where there is mechanical interference in the work area or test sample. The filter utilizes a moving average technique in which consecutive readings are pushed through a buffer and the displayed reading is the average of the buffer contents. By varying the length of the buffer, a variable smoothing effect can be achieved. The selection of 1 will disable the filter since the average of a single value is the value itself.

Available settings: 1 through 16,384.

It is recommended to keep the filter as low as possible for best performance.

Default Folders

Select the corresponding **Open** buttons to browse to the desired folder locations for test configuration files, data, results, and reports.

All above file types created by IntelliMESUR are encrypted, for data integrity purposes, except .csv file exports.

Date and Time Format

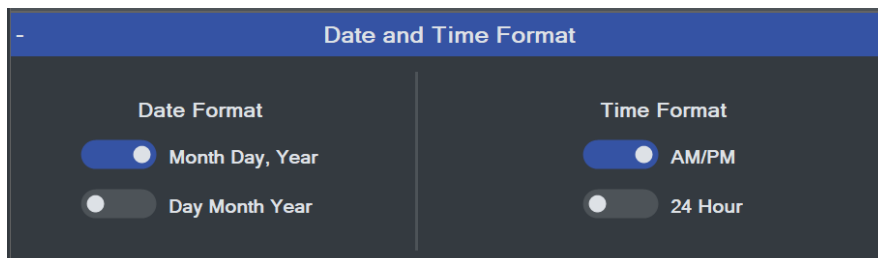

Select the desired date and time format.

The current date and time are linked to the *Windows* clock. To change the time on a touch-enabled device, press and hold the clock in the lower-right corner of the screen. If using a mouse, right-click, then select **Adjust date/time**. The time is displayed along the lower edge of the IntelliMESUR screen.

Note: if the device is not connected to the internet, the *Windows* clock may drift by up to several minutes per year.

6.5 Optional Functions

A number of optional software functions are available within IntelliMESUR®. This section provides a means of evaluating optional functions for 90 days, and activating these options permanently.

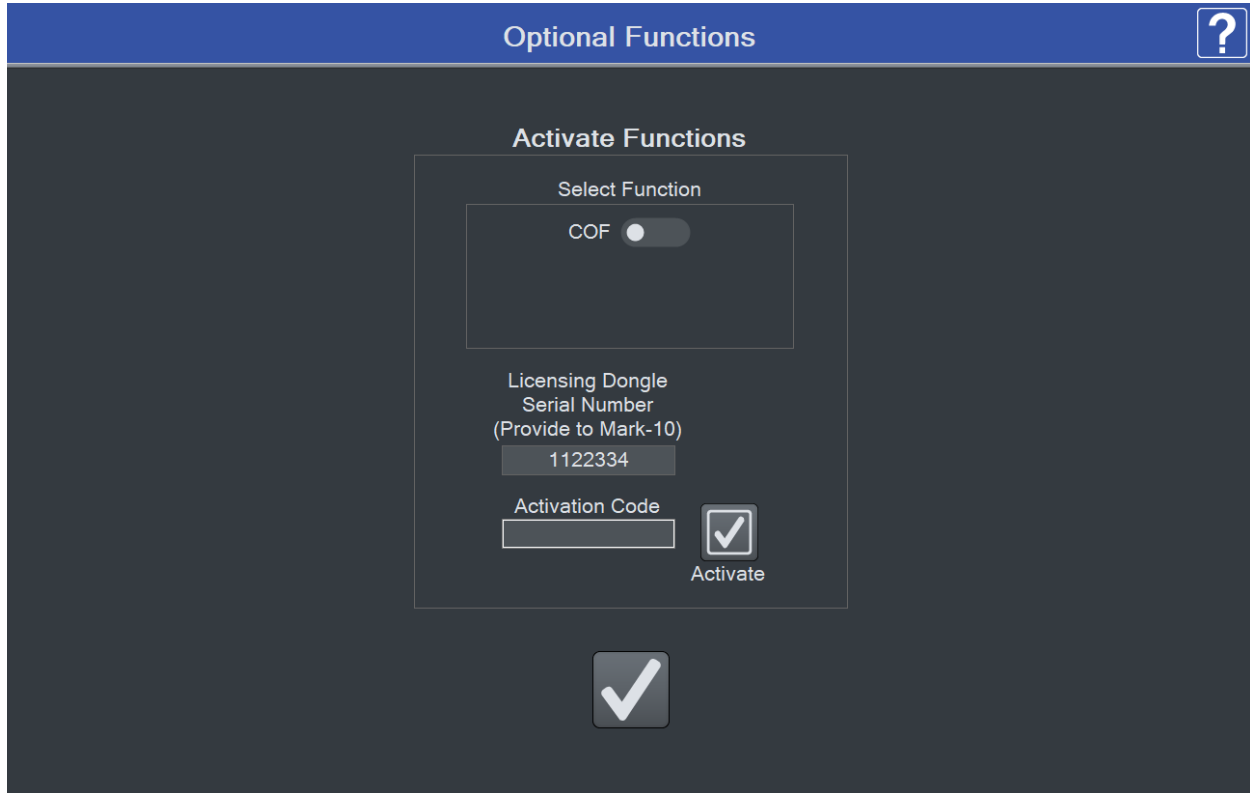

Activating a Function

To activate an optional function, select the desired function. Then, provide Mark-10 with the *Test Frame Serial Number* or *Licensing Dongle Serial Number*. Mark-10 will supply a corresponding *Activation Code*. Enter this code into the provided space, then select **Activate** to permanently enable the function.

Functions may also be evaluated for 90 days. Select **Start** to initialize the evaluation period. During this period, "Evaluation Mode" will appear above the list of functions. A function may be activated at any time before, during, or after the evaluation period.

6.6 Overloads

IntelliMESUR constantly monitors the force sensor, and stops the crosshead when the load reaches 120% of capacity. However, it is still possible to overload a force sensor when it is stationary by manually applying excessive force to it.

Overload History provides a record of the 50 most recent overloads, containing a time stamp, motion direction, and force direction for each occurrence. An example screen appears as follows:

Overloads				
	Date	Time	Motion Direction	Force Direction
1	December 05, 2019	01:38:41 PM	Up	Tension
2	January 01, 200	01:00:01 AM	Stop	Compression
3	January 22, 2020	04:25:51 PM	Stop	Compression
4	January 01, 200	01:26:01 AM	Stop	Compression
5	April 27, 2020	10:11:20 AM	Down	Compression
6	April 27, 2020	11:35:31 AM	Down	Compression
7	April 27, 2020	12:35:32 AM	Stop	Compression
8	April 27, 2020	01:35:33 PM	Down	Compression
9	June 08, 2020	11:16:13 AM	Stop	Compression
10	June 09, 2020	11:40:00 AM	Up	Tension
11	June 09, 2020	12:40:01 AM	Stop	Compression
12	June 09, 2020	01:40:02 PM	Stop	Compression
13	June 10, 2020	05:39:00 PM	Up	Tension
14	June 15, 2020	02:30:23 PM	Up	Tension
15	June 15, 2020	03:30:24 PM	Up	Tension
16	July 23, 2020	02:50:53 PM	Down	Compression
17	August 06, 2020	04:45:44 PM	Down	Compression
18	August 06, 2020	05:45:45 PM	Up	Tension
19	December 01, 2020	12:39:30 AM	Up	Tension
20	December 01, 2020	01:39:31 PM	Up	Tension
21	December 17, 2020	02:51:00 PM	Stop	Compression

Note: Overloads which may occur while the force sensor is disconnected from a Series F test frame, or while the test frame is powered off, are not recorded in **Overload History**.

6.7 Deflection Compensation

Refer to the **Calibration** section for further information.

6.8 Update Software and Update Firmware

Refer to the **Maintenance and Service** section for further information.

7 MANUAL CONTROL

Manual Control allows the user to move the crosshead up and down and observe force and distance data, without creating a test. Manual control is useful when needing to manually adjust the crosshead prior to starting a test, and also provides a means of creating a reference point for **Height Mode**.

Note: Data cannot be saved in **Manual Control**.

The screen appears as follows:

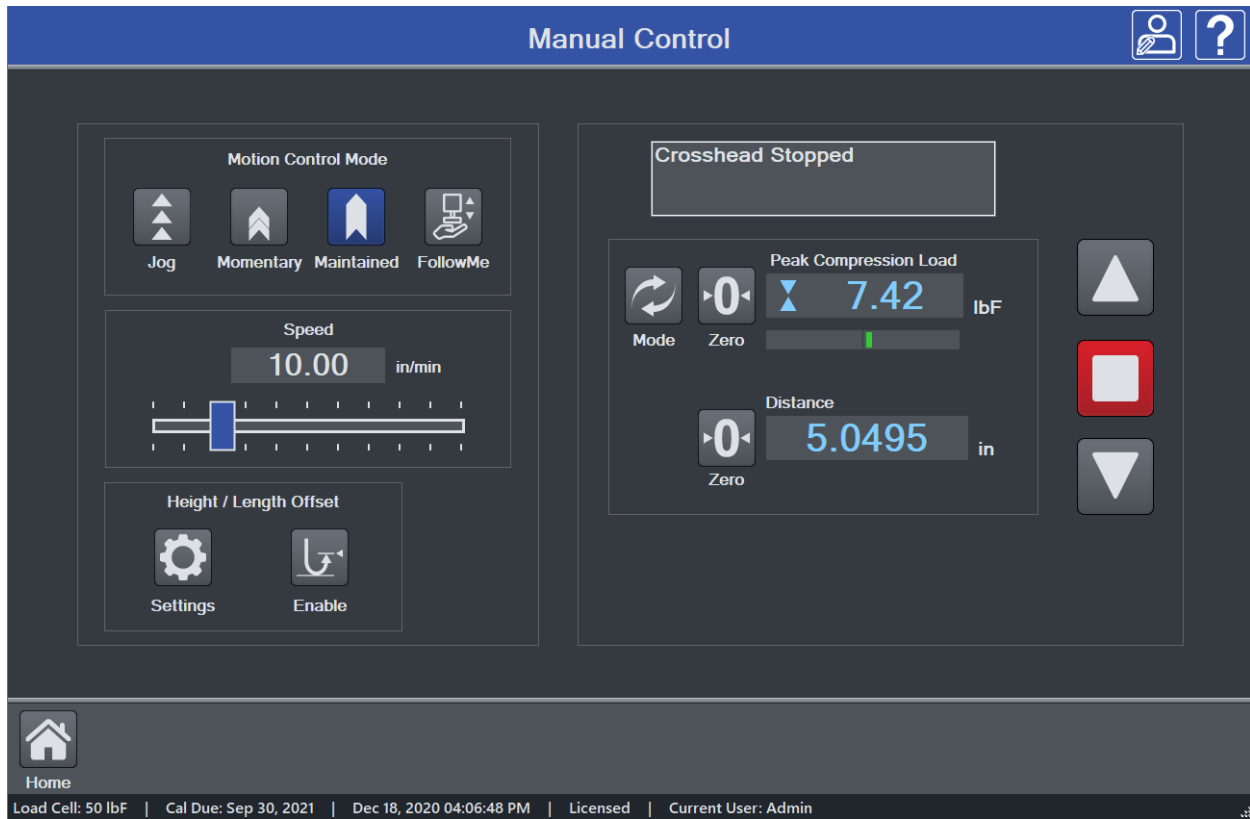

7.1 Load and Distance Measurement

Load and distance measurement are displayed as below:

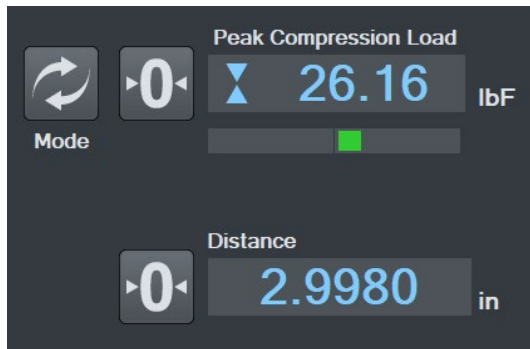

Load

Load is displayed in the unit of measurement selected in **Default Settings**. Use the **Mode** button to toggle between three display modes:

Load

The real-time load.

Peak Compression Load

Maximum observed compression load.

Peak Tension Load

Maximum observed tension load.

The load bar below the load reading indicates when approaching an overload. The bar increases to the right for compression readings, and to the left for tension readings. The bar colors are as follows:

- Green** 0 - 80% of force sensor capacity
- Yellow** 80 to 100% of force sensor capacity
- Red** 100+% of force sensor capacity

At 110% of force sensor capacity, the load reading is replaced by the word, "**OVER**", which indicates an overload. The status window background color turns red.

Load **Zero** zeroes the live load and clears the peaks.

Distance **Zero** zeroes the distance.

7.2 Motion Control Modes

Jog Mode

The crosshead moves the specified distance each time **Up** or **Down** is selected. Three pre-sets are available, as shown below:

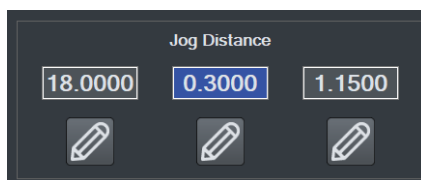

Select the desired preset. Select **Edit** to change the jog distance for the corresponding preset.

Momentary Mode

The crosshead will move only while selecting and holding down the **Up** or **Down** button. To set the speed, type the value into the box or drag the slider to the desired value, as shown below:

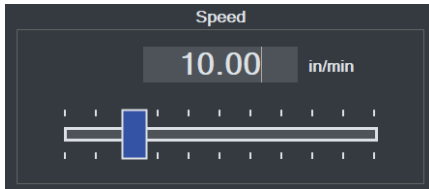

Maintained Mode

The crosshead will move continuously after selecting the **Up** or **Down** button. Set the speed in the same manner as **Momentary Mode**.

FollowMe® Mode

The crosshead responds to pushing or pulling on the force sensor's load cell shaft by hand. Increasing force produces greater speeds.



Exercise extreme caution when using FollowMe® with low-capacity force sensors, as overload can more easily occur.

If no load is detected for 5 seconds after selecting **FollowMe®**, the function deactivates.

7.3 Height / Length Offset

When measuring sample heights, for example in spring testing, a datum (base reference) must be established. This function allows you to establish the datum at a preload. To configure the settings, select **Settings**. The screen appears as follows:

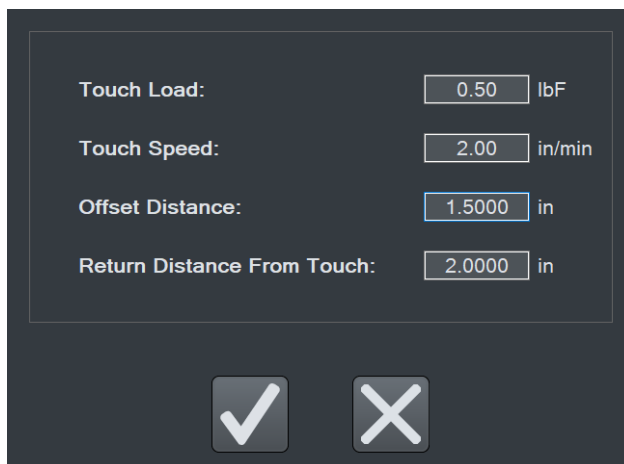

Configure the **Touch Load** and **Touch Speed**, as desired. In many applications, a flat compression plate is used to engage the top of the sample, for example, in compression spring testing. However, when a grip with more complex geometry is used, and it is not possible to touch the sample contact surface to the test frame base or the lower fixture, an **Offset Distance** may be specified. If specified, IntelliMESUR automatically increases the displayed distance value by this value when the preload occurs.

When finished, select **OK**, then select **Enable** in the **Manual Control** screen. The button will be highlighted. Then select **Up** or **Down** to perform the function. After the preload has been reached, the crosshead will reverse until the **Return Distance From Touch** is reached.

7.4 Set Home

When **Manual Control** is accessed from an active test screen, instead of from the **Home Screen**, the **Set Home** button appears as follows:

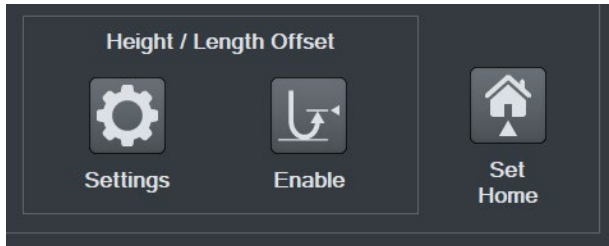

Selecting this button establishes the current crosshead position as **Home**. Refer to subsequent sections for more details on how this position relates to test configurations.

8 CREATING A BASIC TEST

To create a new basic test, select "**New Test**" from the **Home** screen, then select "**Basic Test**", then select one of the following test types:

	Load Limit Crosshead stops at a specified load limit.
	Distance Limit Crosshead stops at a specified distance limit or height.
	Break Limit Crosshead stops when the sample breaks.
	Load Hold Crosshead moves until a specified load, then maintains the load for a specified period of time.
	Cycle Test Crosshead cycles a specified number of times between a selection of limit condition types.
	COF Test (optional function) Crosshead stops at a specified distance and calculates static and dynamic COF.

8.1 Load Limit

The screen appears as follows:



The Basic Test Wizard consists of four steps. Each stepped is grouped into panels containing settings. The four steps are as follows:

1. **Pre-Test Setup**
2. **Test Setup**
3. **Results Setup**
4. **Post-Test Setup**

8.1.1 Pre-Test Setup

Basic Setup Panel

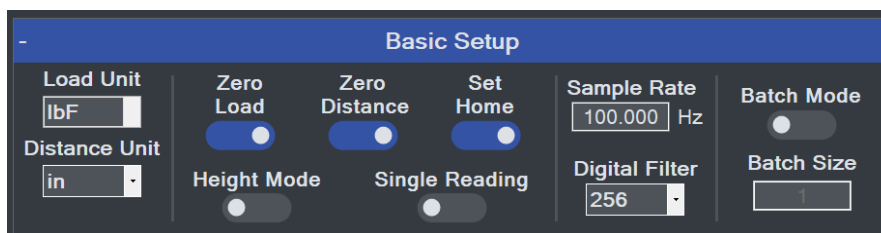

Load Unit

Select the desired unit of measurement. Note that not all units are supported by all force sensors cells. Refer to the sensor's specifications for a list of supported units.

Distance Unit

Select the desired unit of measurement.

Zero Load

Zero the load value at the start of the run.

Zero Distance

Zero the position value at the start of the run.

Set Home

Establish the starting position of the crosshead as the Home position. You can auto-return to this position; this may be set in subsequent sections of the wizard.

Height Mode

To measure distance relative to a reference point established via the **Height / Length Offset** function in **Manual Control**, enable **Height Mode**. Height measurements are commonly used in spring testing.

Single Reading

Only a single result and graph data point are displayed, useful when running a batch of tests requiring only one result, such as a maximum load. Select the desired result in **Results Setup**.

Sample Rate

By default, IntelliMESUR records continuous data points for each run. Set the desired rate, up to 1,000 Hz (data points per second). IntelliMESUR can capture up to 1 million data points per run, up to 10 runs, for a total of 10 million data points.

Digital Filter

Smooths out load readings in situations where there is mechanical interference in the work area or test sample, as explained in the **Preferences** section.

Batch Mode

To set up a batch of multiple runs, enable this mode, then specify the number of runs.

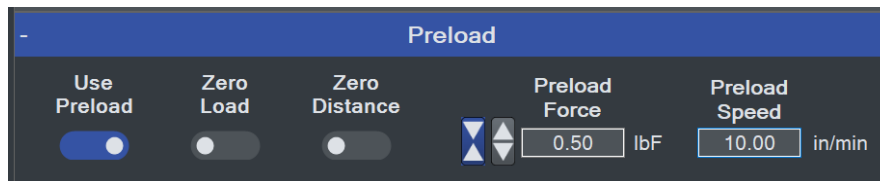
Preload Panel

The preload function zeroes the load and/or position values upon contact with the sample, defined as a user-specified force. The speed of the preload phase of the test may also be set independently of the main test speed, which is configured in the subsequent step, **Load Limit Setup**.

If preload is desired, enable the appropriate functions and specify the desired preload force and speed.

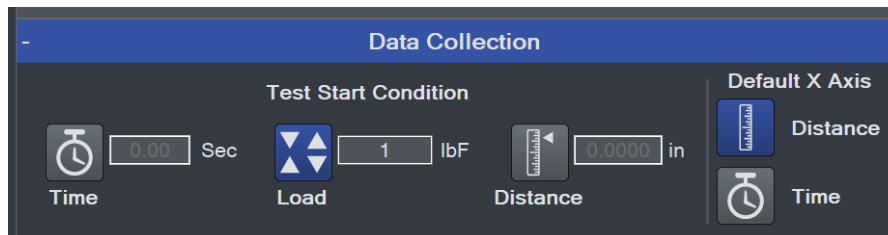
Data Collection Panel

Configure the trigger at which data collection will start. Select from an elapsed time (relative to the start of crosshead motion), load, or distance. The default graph x-axis may be also configured, although this can be changed at time of test in the **Graph** screen.

Prompts Panel

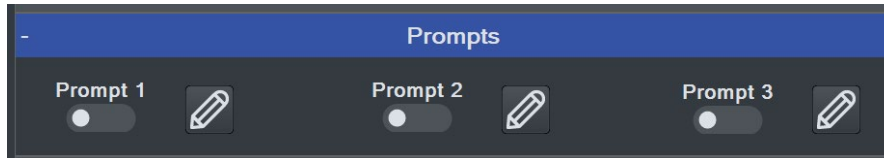

IntelliMESUR can prompt a message or ask a question requiring a response. Up to three consecutive prompts may be configured.

Select the **Edit** icon to configure the prompt. The screen appears as follows:

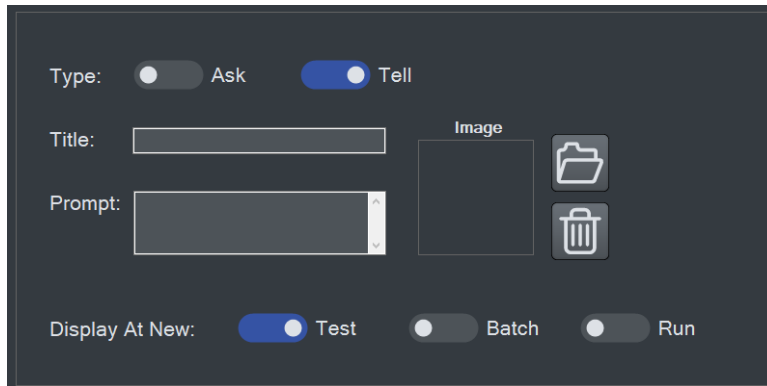

Select **Tell** to provide information to the user, or **Ask** to ask a question requiring a response, such as a serial number or lot number. The response to an **Ask** prompt can be saved in the **Results** table of a test.

Optionally include an image to be displayed with the prompt. Select **Open** or the empty image frame, then browse to the desired location. To remove an image, select **Delete**.

The prompt can be displayed when the test is opened, at the start of a new batch, or at the start of each run. Make the desired selection.

Example prompts, as they appear during a test:

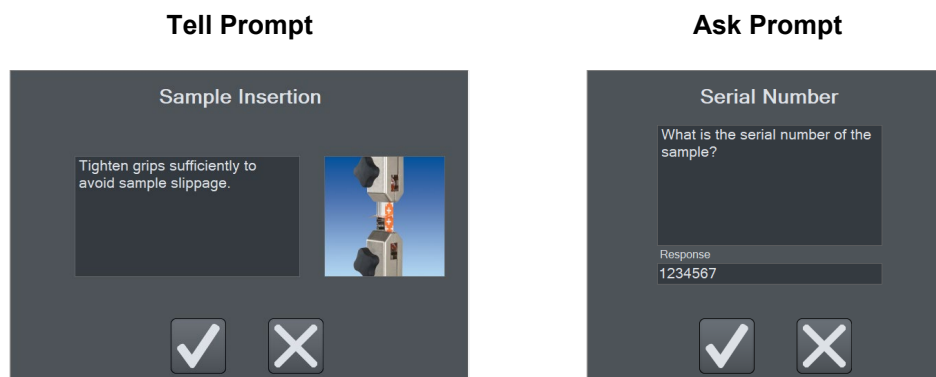

For convenience in high-volume testing applications, a USB barcode scanner can be used to input a response (not available from Mark-10).

Deflection Compensation

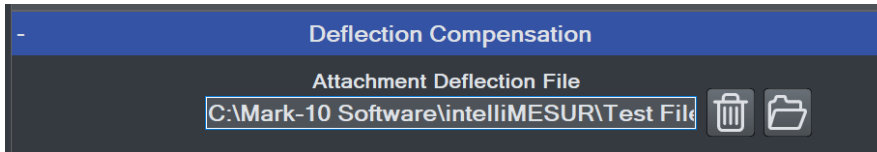

Force sensors and test frames deflect under load, affecting the accuracy of distance measurements. Series F test frames and force sensors are compensated at the factory.

To account for deflection within grips or fixtures associated with the test, IntelliMESUR provides a utility for additional compensation. For instructions on running this utility, refer to the **Deflection Compensation** section. When this process has been completed and the file has been saved, browse to the desired file in this panel.

Description

Optionally type a test description, which can be useful in identifying tests at a later date. Example:

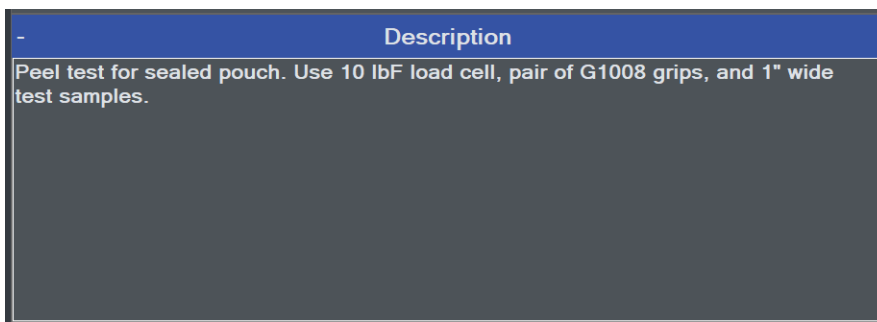

When opening a test, the description appears to the right of the file listing, as follows:

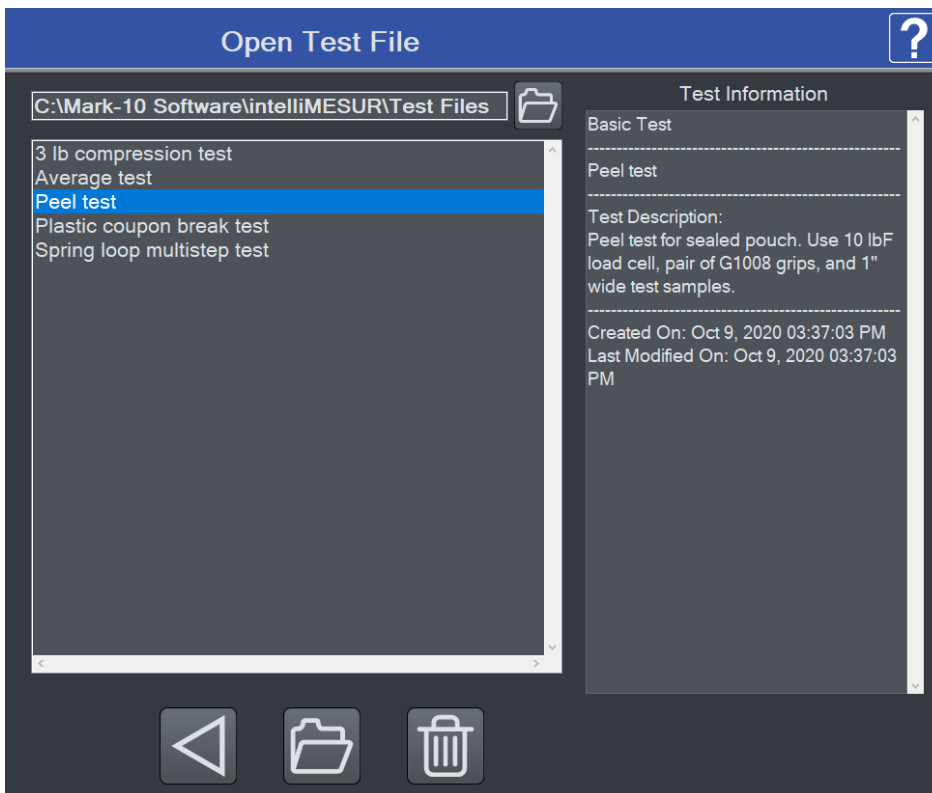

8.1.2 Load Limit Setup

Basic Setup Panel

The screen appears as follows:

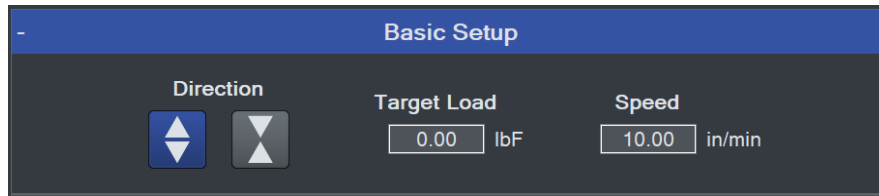

Specify the target load and direction, then specify the test speed.

Pass / Fail Limits

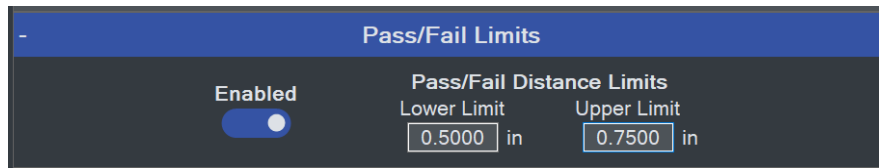

Pass and fail limits may be specified to differentiate an acceptable sample versus a reject. Enable if desired, then specify upper and lower limits. The types of limits in this panel correspond to the type of test. For **Load Limit** and **Load Hold** tests, the pass/fail limits are distance values. For **Distance Limit** and **Break Limit** tests, the pass/fail conditions are load values.

When enabled, a Pass/Fail indicator appears in the upper right corner of the **Graph** and **Results** screens. In addition, a color-coded Pass/Fail column is added to the **Results** table.

Exception Limits

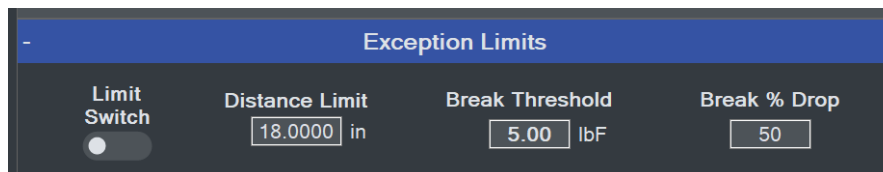

If a test does not reach its target, a number of exception limits may be specified to abort the test. Enable if desired, then specify exception limits. An exception is triggered at whichever trigger occurs first. If an exception is triggered, the crosshead stops, and the Pass/Fail status becomes "Exception". Values obtained in an exception run are not included in results calculations.

Exception options:

Limit Switch

Refers to the physical upper and lower (or right and left) limit switches, positionable along the length of the test frame column.

Distance Limit

A specified distance has been reached.

Break Threshold and Break % Drop

A specified drop in load has occurred, for example when a sample breaks or a sample slips out from a grip. Specify a drop in load from the maximum value (**Break % Drop**). IntelliMESUR starts monitoring for a break after the **Break Threshold** has been reached.

8.1.3 Results Setup

IntelliMESUR can calculate a number of results and calculate statistics for results over multiple runs. For example, IntelliMESUR can calculate the mean of Max Load values over a 5-run batch.

The Results appear as follows:

Load Results

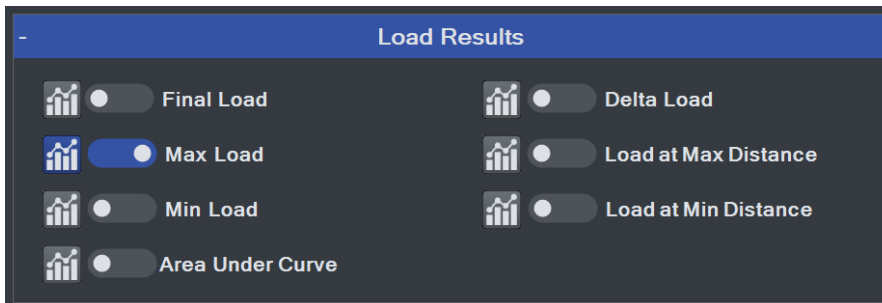

Enable the desired results, then select **Statistics**  to specify Statistics. The screen appears as follows:

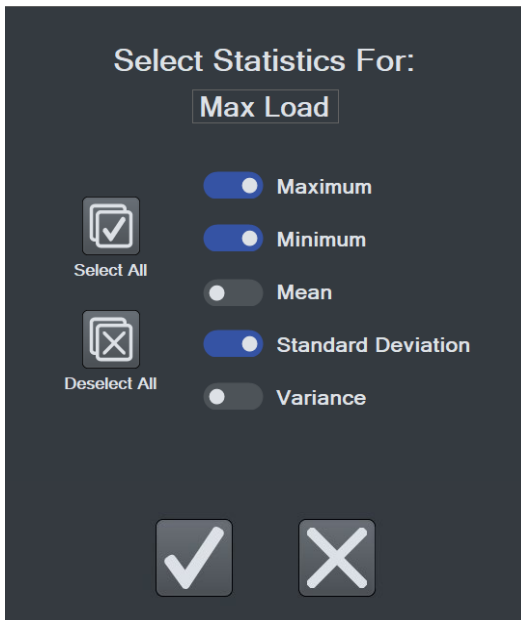

Make the desired selections, then continue.

Distance Results

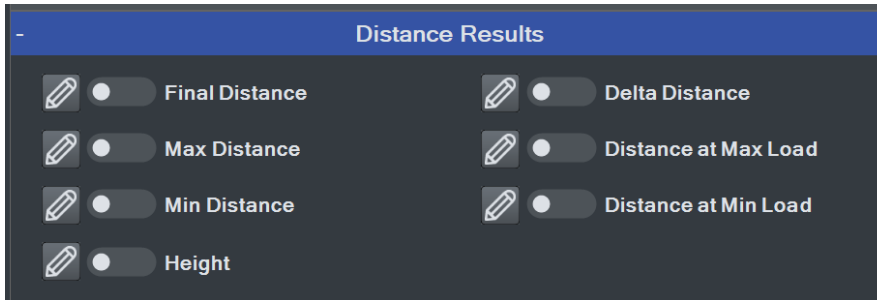

Load Averaging

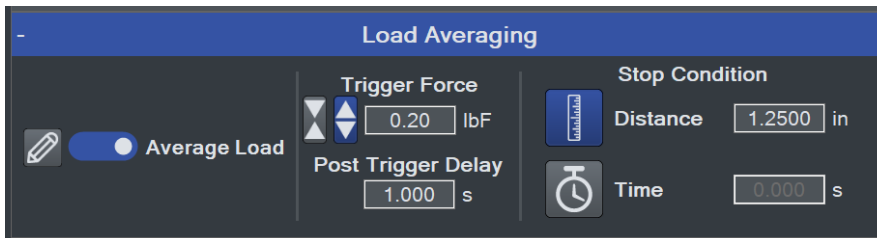

Load Averaging dynamically captures data points and averages the result over a distance or period of time. This requirement is common in peel testing and coefficient of friction testing applications.

Enable the result, and any required statistics, then configure the following settings:

Trigger Force

The minimum force required to start the averaging sequence. Select compression or tension. To start averaging immediately, set this value to zero.

Post-Trigger Delay

An initial delay may be configured, for example to omit the initial force spike at the beginning of a peel test. To start averaging immediately after the trigger force, set this value to zero.

Stop Condition

Stop averaging when the specified distance is reached or time period elapses.

The following graph is a representative example of a time-based averaging test with post-trigger delay:

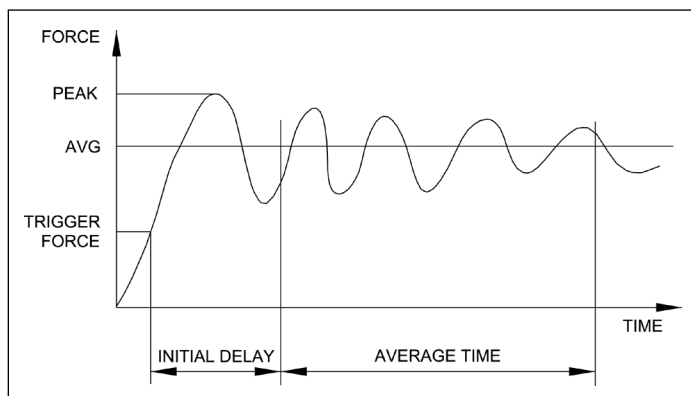

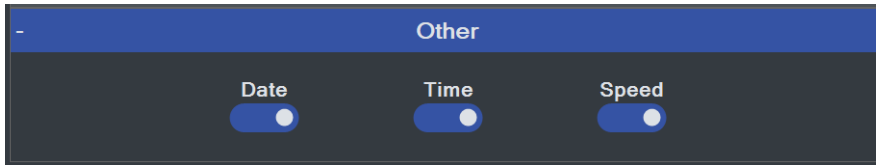
Other

Optionally include the date and time of the test, along with corresponding crosshead speed.

8.1.4 Post-Test Setup

In this step, a number of post-test preferences and settings can be configured.

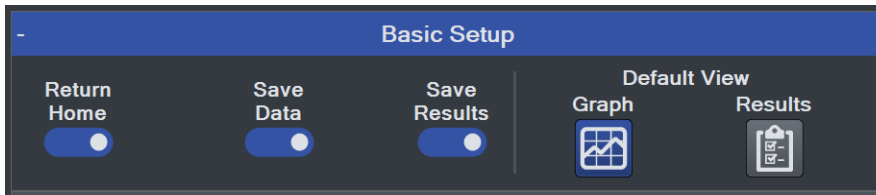
Basic Setup**Return Home**

Crosshead returns to the previously set **Home** position at the end of the test.

Save Data

Automatically save all raw, continuous data for each run.

Save Results

Automatically save results for the test. Results are visible in the **Results** screen.

Default View

When opening a test, default to the **Graph** view or **Results** view. Regardless of the default, you can switch between views after the test has completed.

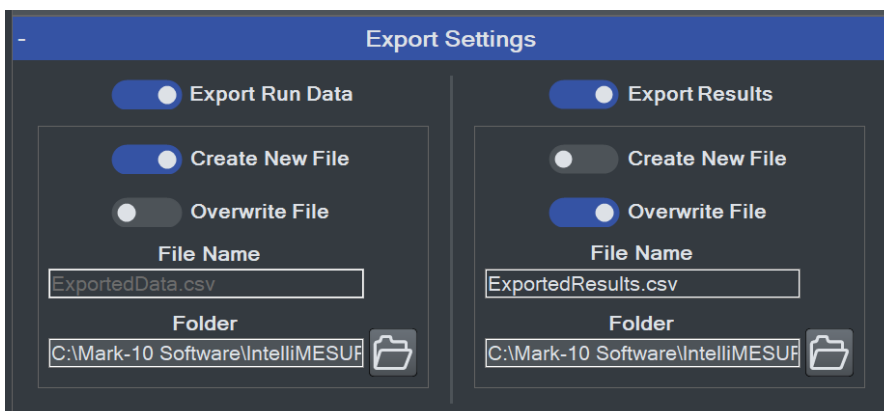
Export Settings

IntelliMESUR® can automatically export data from a single run or results from a batch of runs, or both. Files are exported as .csv using the same formatting described in the manual export function in the **Running a Test** section.

Export Run Data

Enable if desired, then select an export preference:

Create New File

Creates a new file automatically. The file name includes the test name and time stamp, for example: *Peel Test-Dec-7-2020-03-25-57-PM*

Specify the destination folder by browsing to the appropriate location.

Overwrite File

Overwrites an existing file. This function is useful for third-party applications which read periodically from the same file, such as SPC software. Specify the file name as desired.

Specify the file name and browse to an appropriate destination folder.

Export Results

Enable if desired, and follow the same instructions as above.

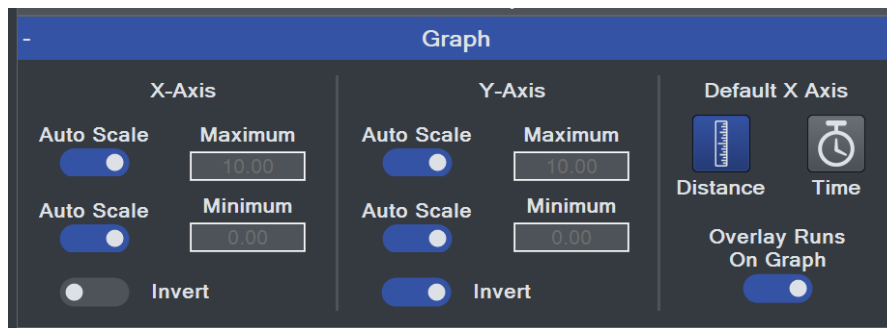
Graph Setup*Auto-Scale*

Auto-Scale automatically increases the X- and Y-axis maximum values as the test proceeds, ensuring that the graph curve is zoomed in as much as possible while fitting the entire curve.

Maximum & Minimum

To specify fixed maximum and minimum axis values instead of automatical scaling, enter the desired values.

Invert

IntelliMESUR processes force, distance, and time data as follows:

- Tension forces are plotted as negative values.
- Compression forces are plotted as positive values.
- Upward or rightward motion is displayed as increasing distance values, while downward or leftward motion is displayed as decrementing values. If the movement continues past a distance of 0, a positive values becomes negative, and vice versa, as illustrated below:

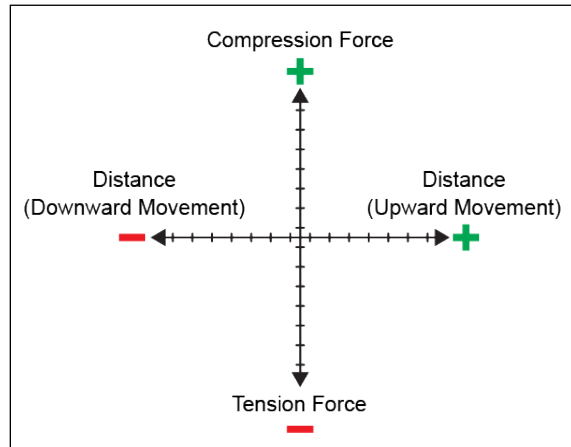

The most common method to plot a curve is to plot up and to the right. To achieve this trajectory, or other type of trajectory, data for each axis may be inverted to compensate for the plotting protocol mentioned above.

Example:

To plot a tension test up and to the right, invert the Y-axis (load), while leaving the X-axis un-inverted. Had the Y-axis not been inverted, increasing tension force would be displayed by a downward dipping plot, as illustrated below:

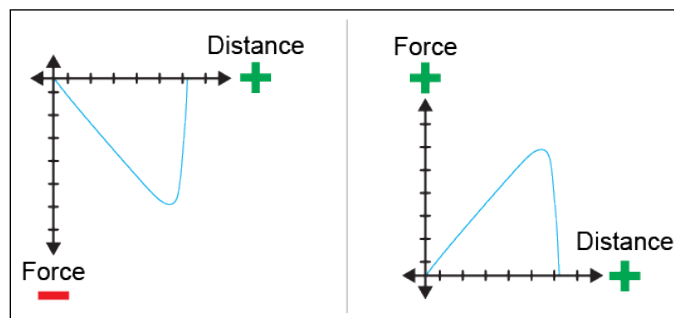

Default X-Axis

Set the default x-axis to distance or time. Note that following any test, you can toggle between distance or time via dedicated buttons in the **Graph** screen.

Overlay Runs on Graph

Up to 10 most recent runs may be plotted on the graph simultaneously. For more information, refer to the **Graph** screen section.

Folders

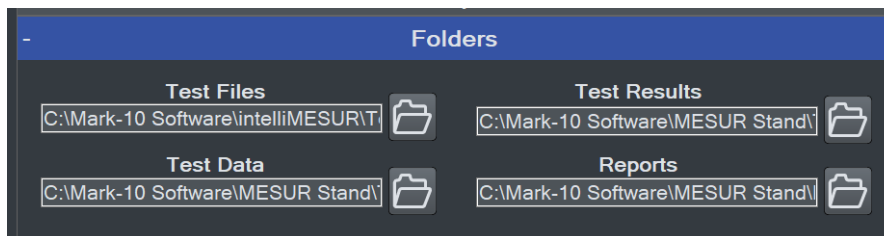

Browse to the desired folder locations for test configuration files, data, results, and reports.

Select **Next** to complete the test setup. When prompted, select **Save & Run**, **Save & Go Home**, or **Cancel**. If saving the test, the screen appears as follows:

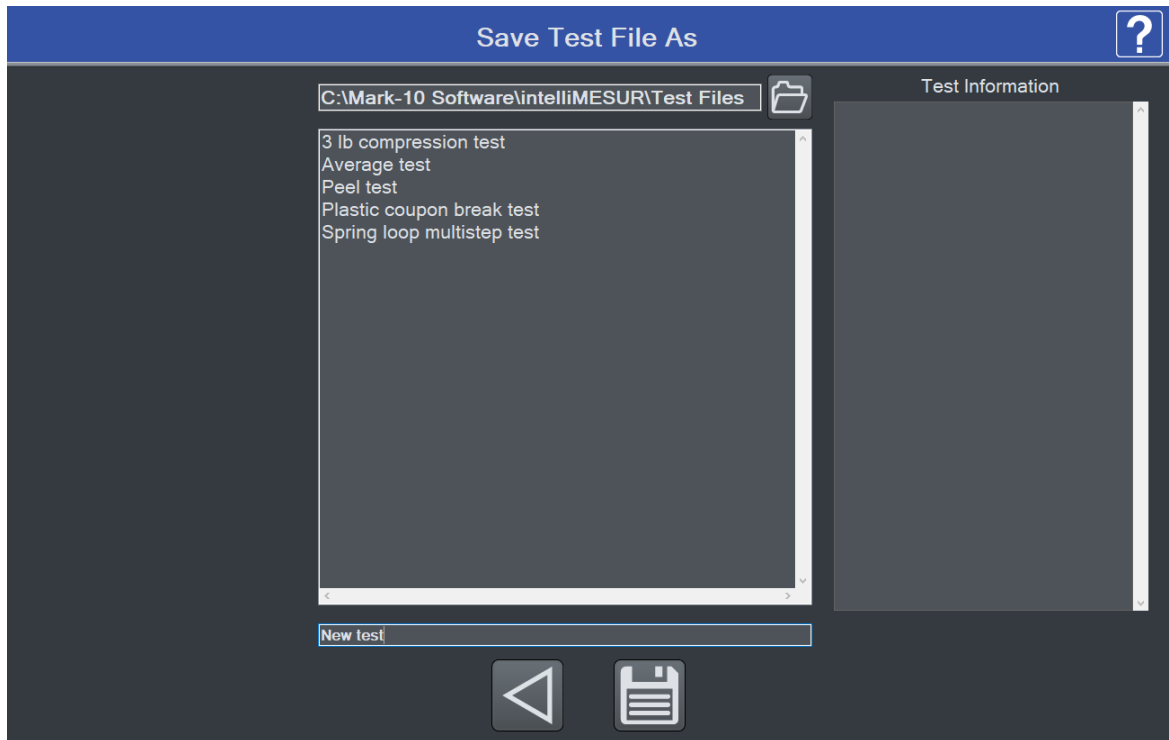

8.2 Distance Limit

A **Distance Limit** test shares most attributes with a **Load Limit** test, with the exception of the **Basic Setup** panel of the **Test Setup** step. The panel appears as follows:

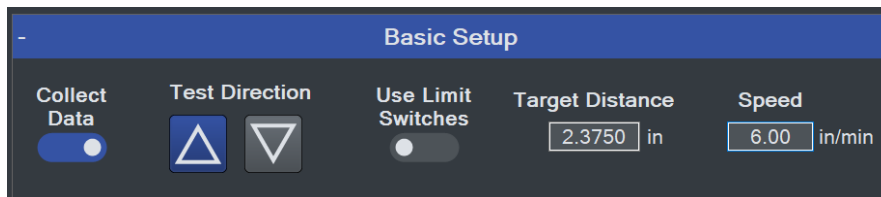

The unique settings are as follows:

Test Direction

Select **upward** or **downward** motion for vertical test frames, or **rightward** and **leftward** for model F505H.

Target Distance

Crosshead will stop at the specified distance.

8.3 Break Limit

Break Limit tests are useful for a wide variety of destructive applications, including peel testing, wire crimp pull-off testing, tensile testing, and many others. The crosshead will stop once IntelliMESUR has detected that the sample has broken.

Setting up a **Break Limit** test is similar to **Load Limit** and **Distance Limit** tests, with the exception of the **Basic Setup** panel of the **Test Setup** step. The panel appears as follows:

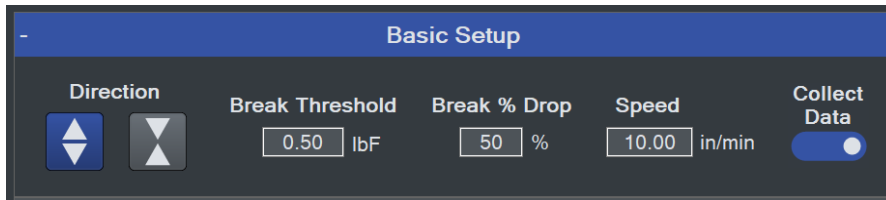

IntelliMESUR starts monitoring for a break when the **Break Threshold** has been reached. This value should be set lower than the anticipated breaking load. IntelliMESUR identifies a break when the load has dropped by the specified percentage from the maximum load.

Example: If **Break % Drop** is set to 40% and the maximum load is 100 lbF, the crosshead will stop when the load drops to 60 lbF.

8.4 Load Hold

With IntelliMESUR's load holding function, the crosshead stops at a specified load, then dynamically adjusts its position to maintain that load over a specified period of time.

Setting up a Load Hold test is similar to **Load Limit** and **Distance Limit** tests, with the exception of the **Basic Setup** panel of the **Test Setup** step. The panel appears as follows:

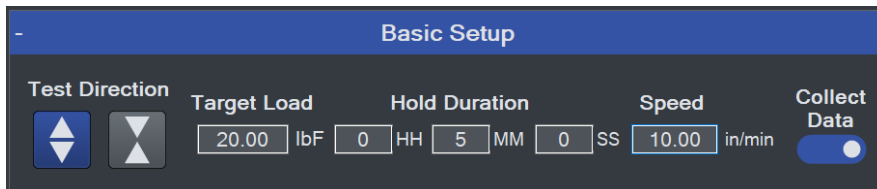

Set a target load, hold duration in hours, minutes, and seconds, then the approach speed.

8.5 Cycle Test

IntelliMESUR's Cycle Test is designed for repetitive applications such as fatigue and durability.

Setting up a Cycle Test is mostly similar to **Load Limit** and **Distance Limit** tests. Note the following unique features:

8.5.1 Cycle Test Setup

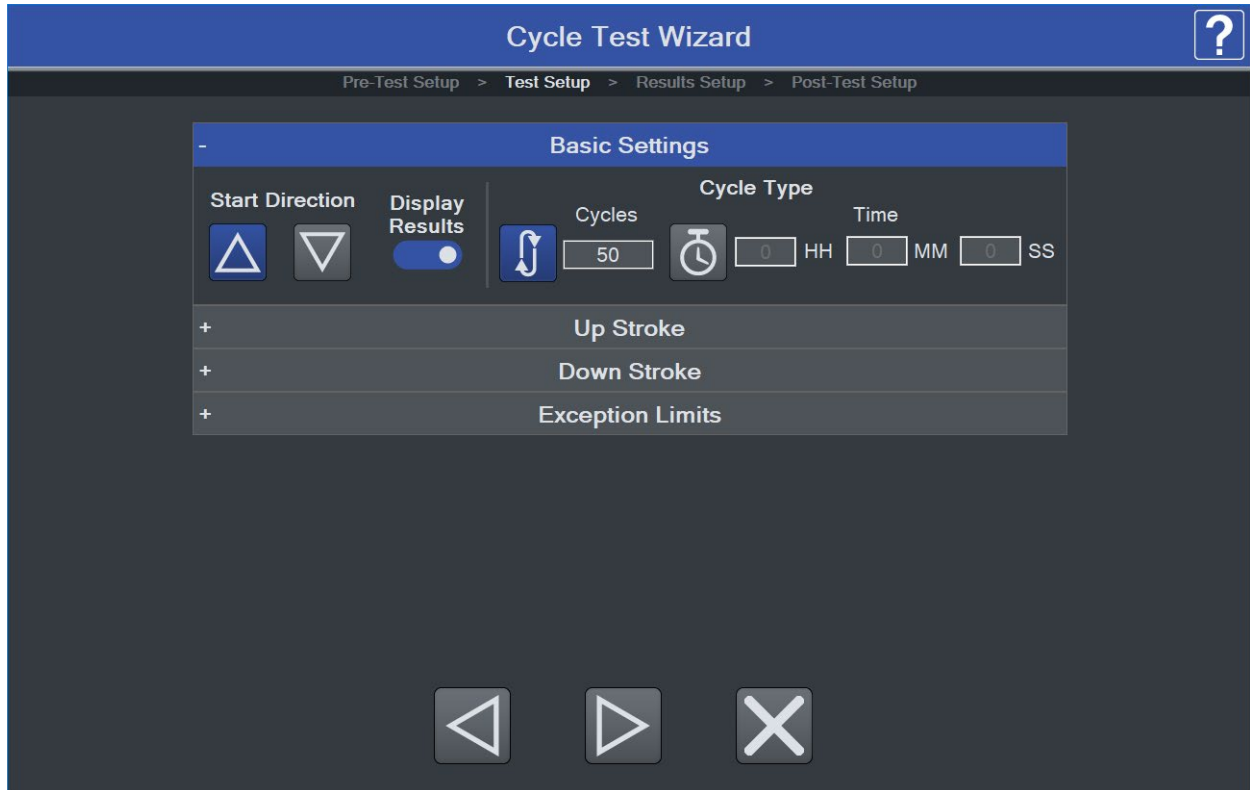
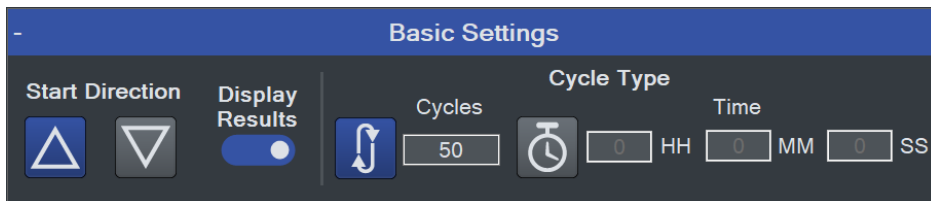
**Basic Settings****Display Results**

Display Results, when selected, will display the results for each cycle of the test in the Results table. When the test completes, the final results will also be added to the Results table.

Cycle Type

Select number of cycles, or specify a period of time, in hours, minutes, and seconds.

Up Stroke / Down Stroke Settings

Up Stroke (crosshead moving up or right) and **Down Stroke** (crosshead moving down or left) settings may be set independently of each other. The crosshead will stop at one of the following three targets:

Load

Select tension or compression, then specify the load.

Distance

Specify as desired.

Limit Switch

Crosshead stops when it reaches the upper physical limit switch.

Speed

Specify the crosshead speed.

Dwell Time

Specify how much time the crosshead waits at the target before reversing.

Exception Limits

Specify exception limits for each stroke independently.

8.5.2 Results Setup

Results setup is the same as in other tests, with the addition of the **Cycles Results** panel. The following additional results may be displayed in the **Results** table:

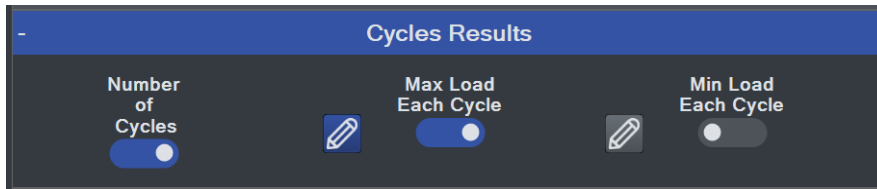

Number of Cycles

Maximum Load Each Cycle

Optionally add statistics for this result.

Minimum Load Each Cycle

Optionally add statistics for this result.

8.6 COF Test

Note: The COF Test module is optional. See **Optional Functions** under **Settings** for activation instructions.

In a typical coefficient of friction test, a sled wrapped with sample material is dragged along another piece of material clamped onto a base fixture. Below is an example configuration for paper testing:



A **COF Test** shares most attributes with a **Distance Limit** test, with the exception of the **Basic Setup** panel of the **Test Setup** step. The panel appears as follows:

Basic Setup		
Sled Weight	Trigger Load	Post-Trigger Delay
<input type="text" value="200.0"/> g	<input type="text" value="0.0"/> gF	<input type="text" value="0.000"/> s
Test Distance	Speed	Display Result
<input type="text" value="5.0000"/> in	<input type="text" value="5.00"/> in/min	<input checked="" type="checkbox"/>
+	Pass/Fail Limits	
+	Exception Limits	

The settings are as follows:

Sled Weight

The weight of the sled.

Trigger Load

The load threshold at which IntelliMESUR starts to collect data.

Post-Trigger Delay

Specify a time delay after the **Trigger Load** before collecting data.

Test Distance

Specify as desired. Data collected between the **Trigger Load** and **Test Distance** are used to calculate the static and dynamic coefficients of friction.

Speed

Specify the crosshead speed.

Display Result

Include results. The **Results** step adds the following COF results:

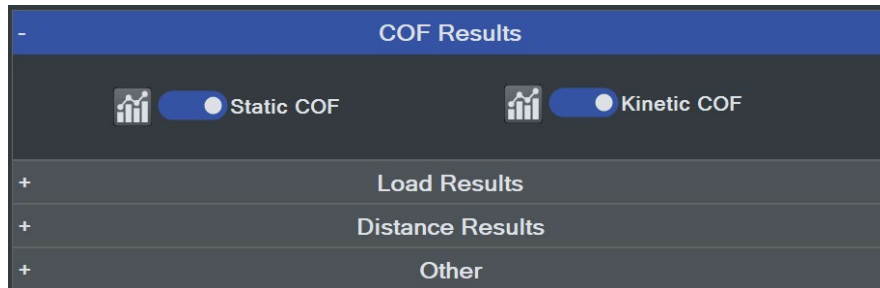

Static COF Maximum force divided by the sled weight.

Kinetic COF Average force divided by the sled weight.

9 CREATING A MULTI-STEP TEST

A **Multi-Step** test can string together any number of basic test functions, data collection steps, data zero steps, cycling, and prompts. Steps may be placed in the desired order, then re-ordered as desired.

9.1 Multi-Step Overview

The initial screen appears as follows:

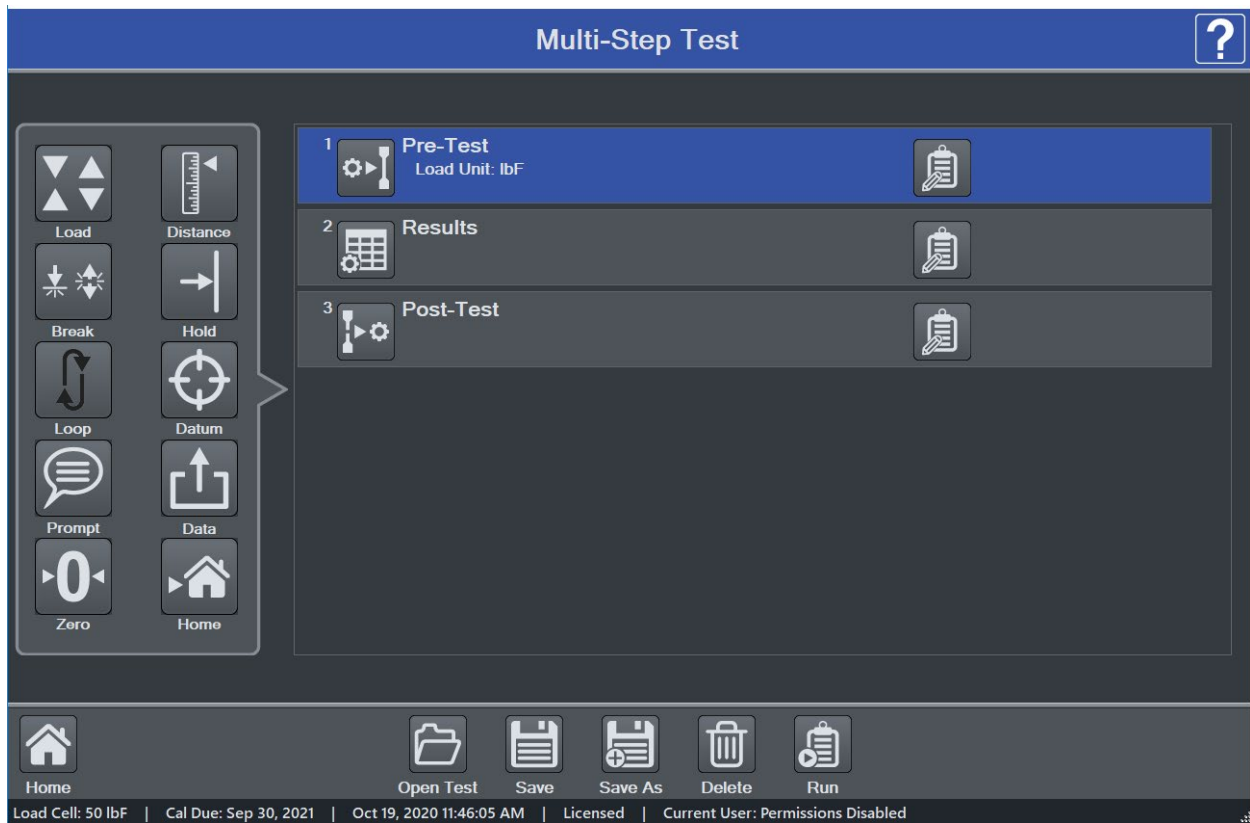

Available steps are listed in the left side of the screen, and may be inserted into the step sequence to the right.

To insert a step, highlight an existing step. It will become blue. Then click the desired step. It will be inserted after the currently selected step. An example test is below:

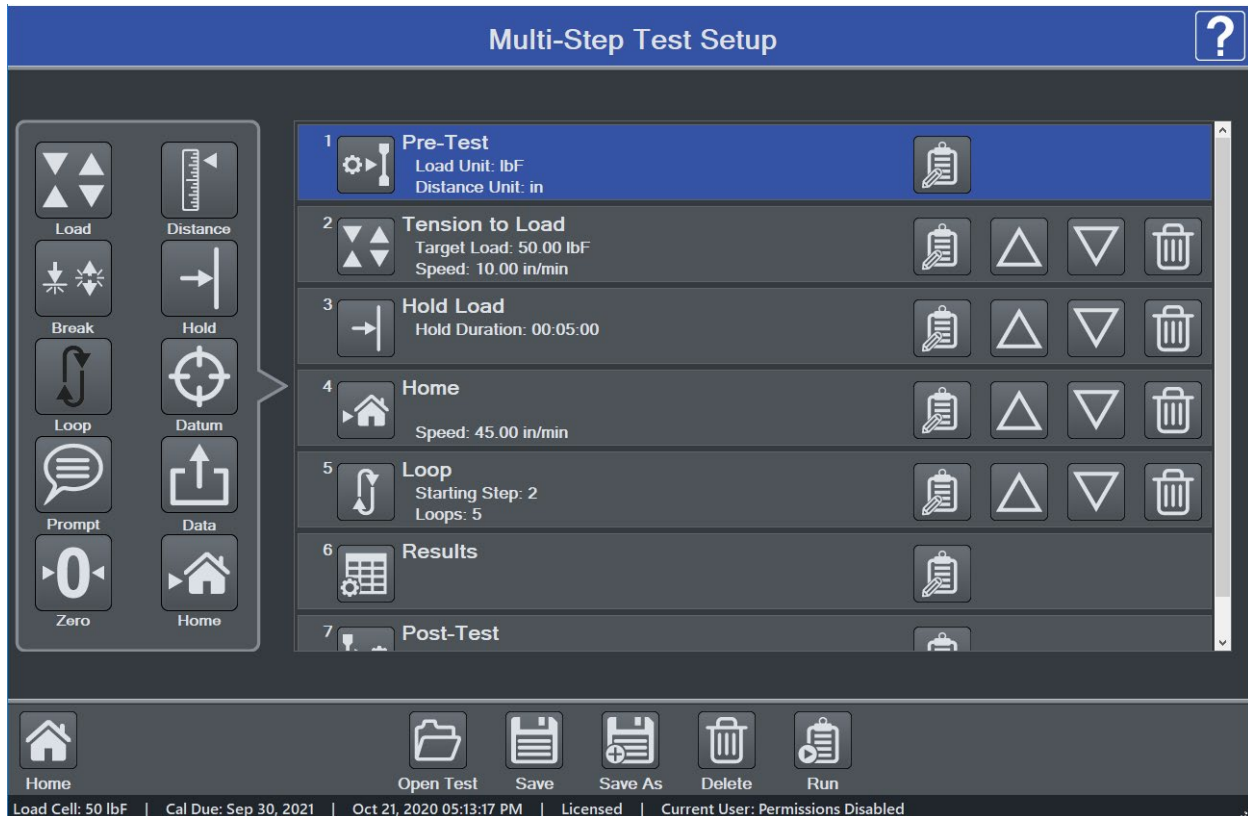

The step sequence must contain the three steps listed above: **Pre-Test**, **Results**, and **Post-Test**. To edit these steps, select **Edit**, and configure the parameters the same way as in **Basic Test** setup.

To move a step forward or back, use the **Up** and **Down** buttons. Select the **Delete** button to remove the step.

The selection of results is expanded as compared to **Basic Test** setup, as follows:

Load Results:

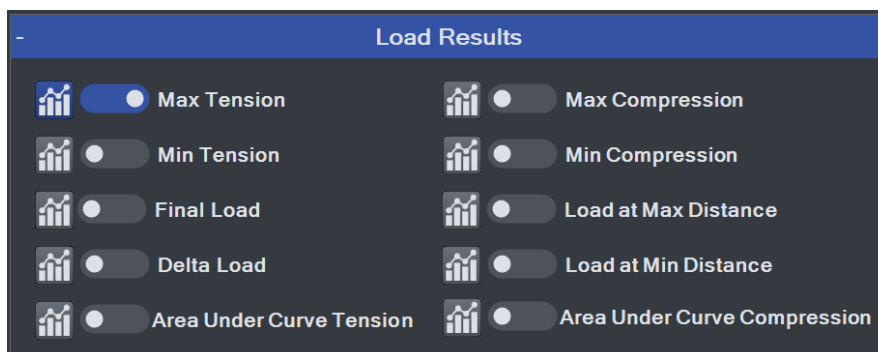

Distance Results:**9.2 Step Types**

Multi-step tests build upon the same functions as in Basic Tests, while separating out datum, prompting, zero, and go-home functions. Preload is not integrated into steps as in Basic Tests. Instead, a preload must be manually configured as a separate **Load Limit** step, followed by a **Zero** step.

Available steps are as follows:

9.2.1 Load, Distance, and Break

Each of these steps may be set up in the same manner described in **Basic Test** setup.

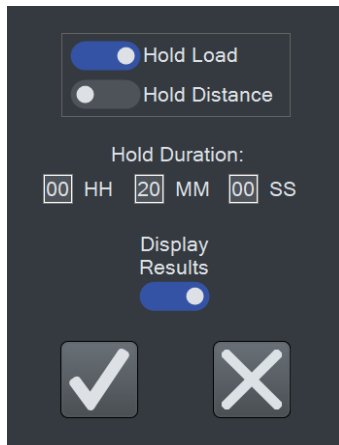
9.2.2 Hold

Hold a load (as described in **Basic Test** setup) or hold a position. Specify the hold period in hours, minutes, and seconds.

To include the data points received during the **Hold** step in the **Results** calculations, enable **Display Results**.

9.2.3 Loop

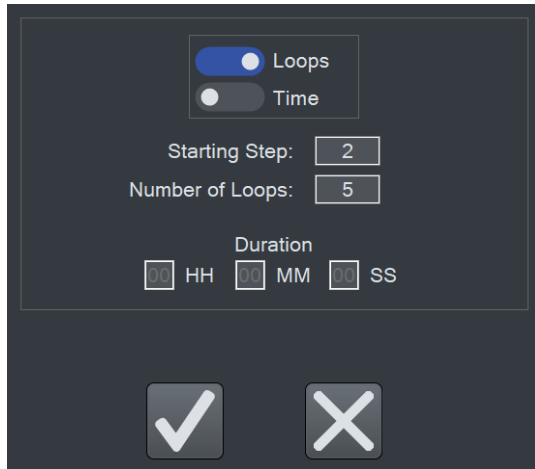

The **Loop** function repeats a range of steps. Insert this step after the last step to be repeated.

Select either a number of loops or a time duration for constant looping. Then, enter the **Starting Step** number. Enter **Number of Loops** or **Duration**.

9.2.4 Datum

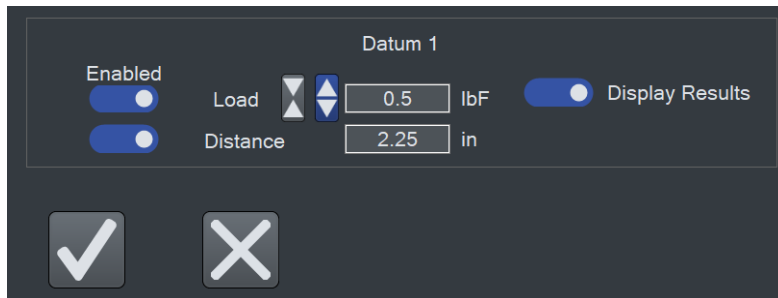

A datum establishes a local offset of load and/or distance. When the datum step is reached, the load and/or distance will change by the values set in the **Load** and **Distance** fields. Enable one or both of these fields.

Note that datums do not change the system offset established in the **Height / Length Offset** utility, but rather, only offsets the data collected during the test.

To include the data points received during the **Hold** step in the **Results** calculations, enable **Display Results**.

Up to two datums may be used per test.

9.2.5 Prompt

Setting up a prompt in a multistep test is the same as described in the **Basic Test Setup** section.

9.2.6 Data

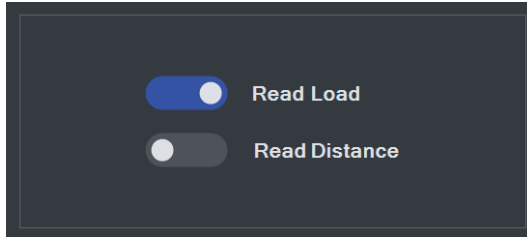

A **Data** step saves the current load and/or distance value in the **Results** table. Make the desired selections.

9.2.7 Zero

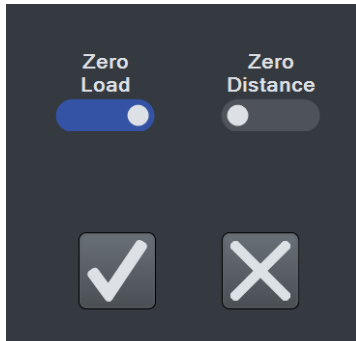

A **Zero** step zeroes the load and/or distance. Make the desired selections.

9.2.8 Home

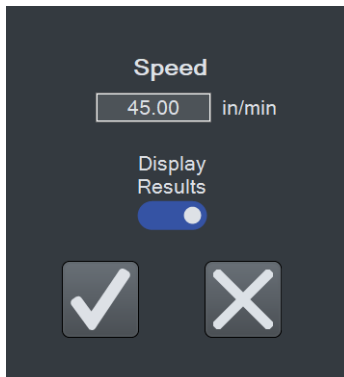

A **Home** step returns the crosshead to the **Home** position at the specified speed.

To include the data points received during the **Home** step in the **Results** calculations, enable **Display Results**.

10 RUNNING A TEST

10.1 Favorite Tests

Saved tests may be designated as favorites, for quick access when selecting **Open Test** from the **Home** screen. The screen appears as follows:

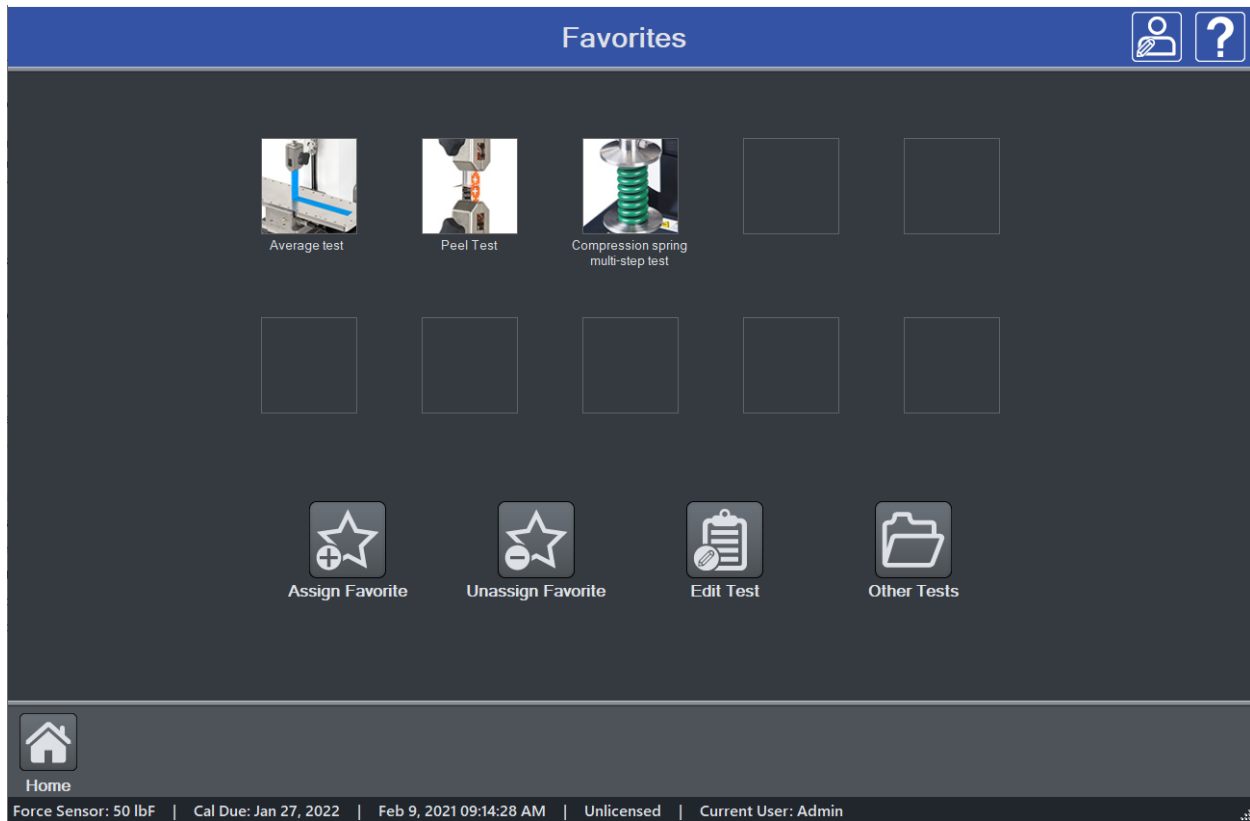

10.1.1 Creating a Favorite

Select **Assign Favorite**, then select the desired box location. The screen appears as follows:

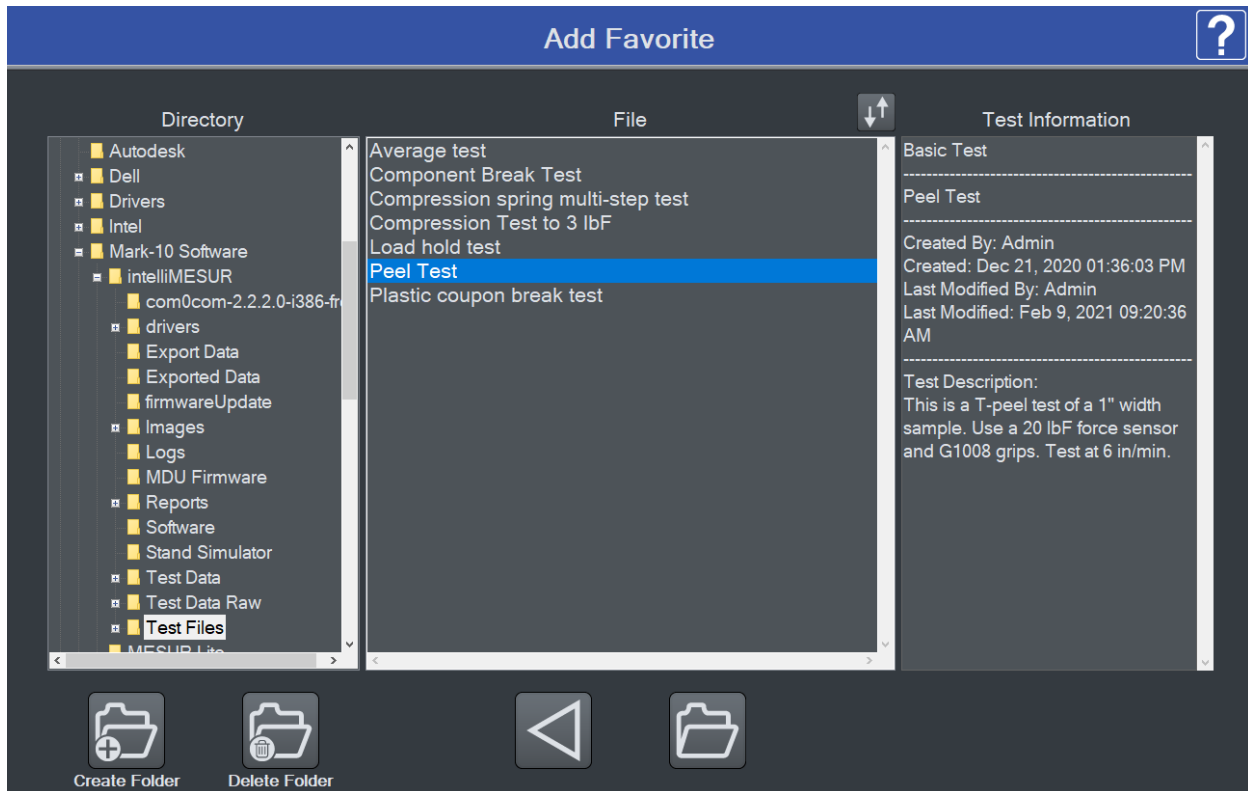

Browse to the desired file, then select **Open**. Optionally associate an image with the favorite box by making the appropriate selection to the next screen:

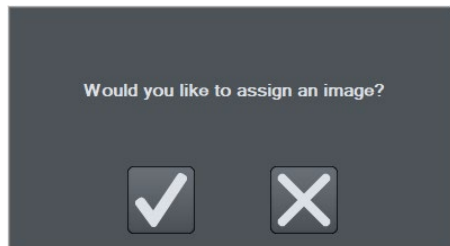

If selecting **Yes**, browse to the desired image, then select **Open**. The screen appears as follows:

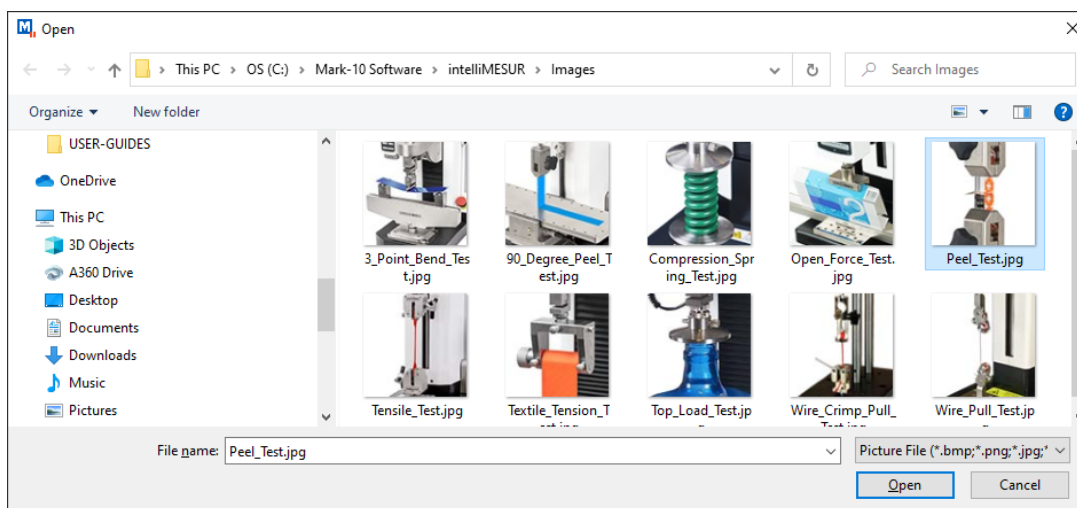

10.1.2 Unassigning a Favorite

Select **Unassign Favorite**, then select the desired test.

10.1.3 Edit a Test

Select **Edit Test**, then select the desired test.

10.1.4 Opening a Test

Select a previously assigned favorite, or select **Other Test** to browse for other tests not assigned as favorites.

Depending on the test setup, the initial view is either **Graph** or **Results**.

10.2 Graph View

The screen appears as follows:

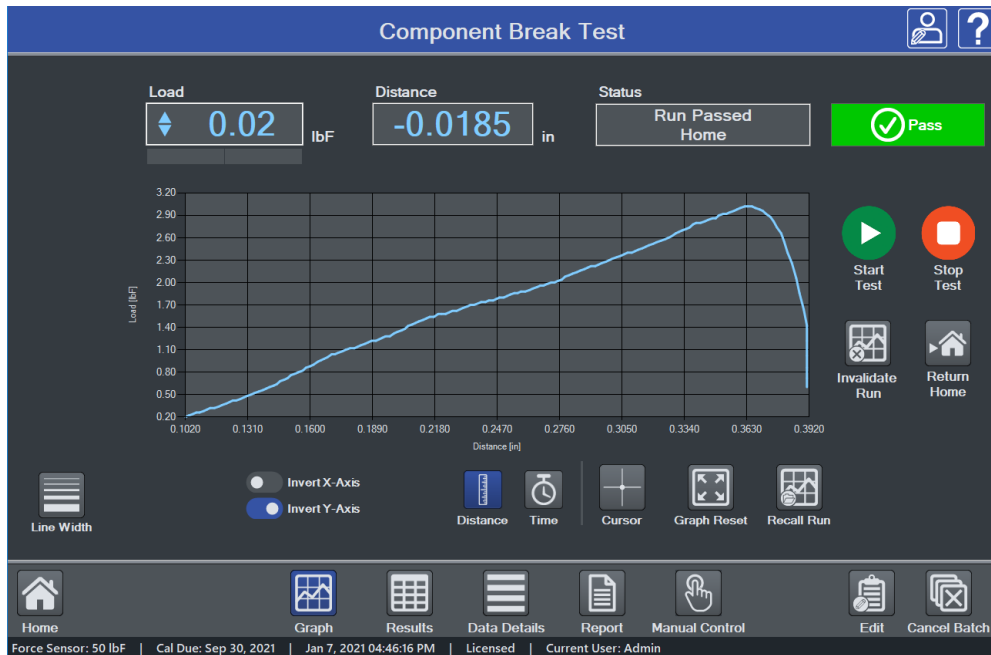

Multiple runs may be viewed on the graph at the same time. If **Overlay Runs on Graph** is selected in the test setup, the screen appears as follows:

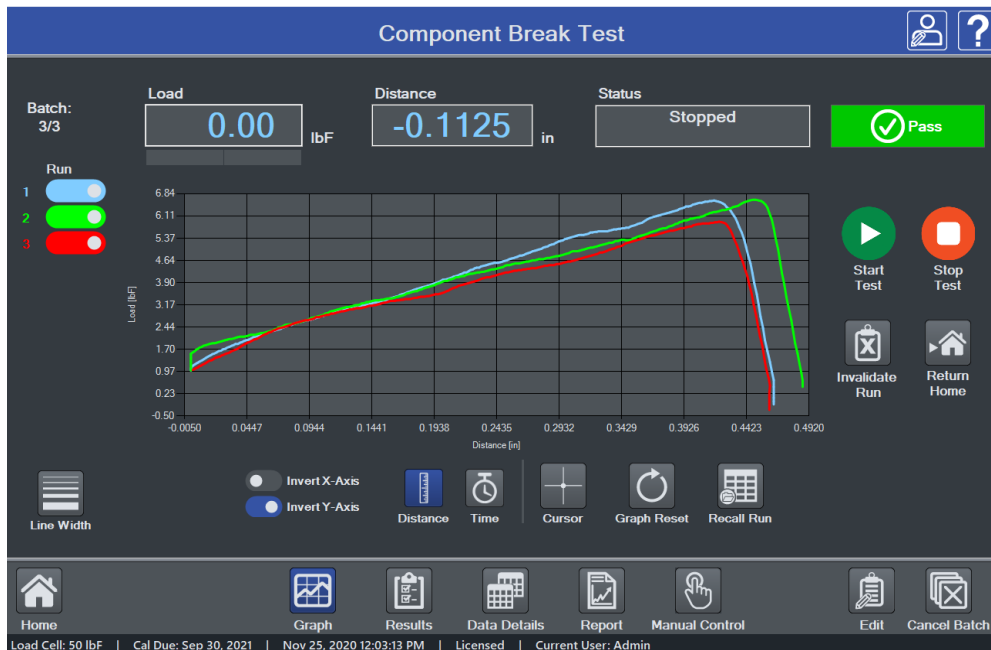

Select the desired runs to view.

10.2.1 Basic Information

Along the top of the screen, the following information is always displayed:

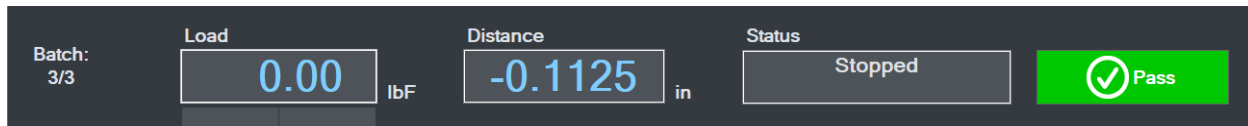

Batch counter – if **Batch** is enabled in the test setup, the current run number and batch size are displayed. Ex. “Batch: 2/3” = 2 runs completed out of a batch of 3.

Load – current load.

Distance – current distance.

Status – crosshead motion status, such as **Moving Up**, **Moving Down**, **Stopped**, **Home**, **Emergency Stop**, etc.

Pass / Fail Indicator – if **Pass / Fail Limits** are enabled in the test setup, a **Pass**, **Fail**, or **Exception** indicator will be displayed at the end of each run. If an exception occurs, the type of exception will be shown in the **Status** window and in the **Results** table.

For multi-step tests, a pass / fail indicator can be configured for each step, and is represented in the **Results** table (refer to the **Results View** section for more information). If any step within a multi-step test has failed, IntelliMESUR considers that the entire run has failed, and displays **Fail** in the main indicator described above.

10.2.2 Graph Controls

The following controls are provided below the graph:

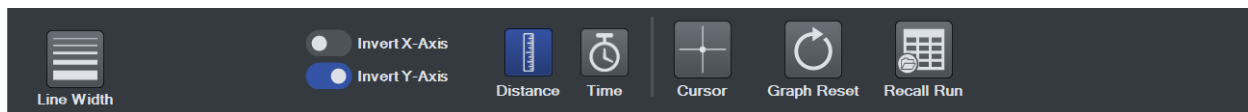

Line Width

Select the button, then choose the desired plot thickness:

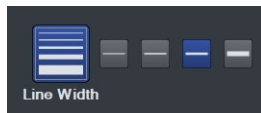

Invert X-Axis, Invert Y-Axis

Invert the plots, as desired. Further explanation is provided in the **Graph Setup** sub-section of **Creating a Basic Test**. Note that inverting axes in this screen will not be saved to the test setup. Edit the test to save default axis settings.

Distance / Time selector

Select **Distance** or **Time** as the x-axis. The y-axis is always **Load**.

Cursor

Use the cursor to identify the x- and y-values along any point of a plot. Click or touch any point along a plot to see the values. Example below:



The cursor will snap to the closest plot when multiple runs are displayed simultaneously.

Zoom

To zoom by hand, pinch fingers to zoom in and out. To zoom in via mouse, click and drag to create a zoom window.

To zoom out, select **Graph Reset**.

Graph Reset

Zooms out to show the complete plot.

10.2.3 Starting The Test

To start the test, select **Start**. To interrupt a test while it is running, select **Stop**.

10.3 Results View

10.3.1 Basic and Multi-step Test Result Tables

The screen appears as follows for a basic test:

Component Break Test

Load
0.00 lbF

Distance
-0.1125 in

Status
Stopped

✔ **Pass**

Start Test

Stop Test

Run No.	Status	Serial Number	Date	Time	Speed (in/min)	Final Load (lbF)	Max Load (lbF)	Max Distance (in)
1	Pass	12345	Nov 25, 2020	12:02:02 PM	10.00	0.12	6.62	0.4640
2	Pass	45678	Nov 25, 2020	12:02:19 PM	10.00	0.46	6.64	0.4870
3	Pass	98765	Nov 25, 2020	12:02:33 PM	10.00	0.30	5.92	0.4610

	Final Load (lbF)	Max Load (lbF)	Max Distance (in)
Max	0.46	6.64	0.4870
Min	0.12	5.92	0.4610
Mean	0.02	6.40	0.4705
Std. Dev.	0.3243	0.3348	0.0116
Variance	0.1052	0.1121	0.0001

Invalidate Run

Return Home

Save Results

Recall Results

Export Results

Clear Results

Batch:
3/3

Home

Graph

Results

Data Details

Report

Manual Control

Edit

Cancel Batch

Load Cell: 50 lbF | Cal Due: Sep 30, 2021 | Nov 25, 2020 12:19:15 PM | Licensed | Current User: Admin

Results and statistics are presented as configured in the test setup. The **Statistics** table below the **Results** table is aligned to the results, as depicted below:

	Final Load (lbF)	Max Load (lbF)	Max Distance (in)
↕	0.12	6.62	0.4640
↕	0.46	6.64	0.4870
↕	0.30	5.92	0.4610
↕	0.46	6.64	0.4870
↕	0.12	5.92	0.4610
↕	0.02	6.40	0.4705
	0.3243	0.3348	0.0116
	0.1052	0.1121	0.0001

Below is an example of a one-loop, two-cycle multi-step test:

Run No.	Cycle Count	Step No.	Step Type	Status	Date	Time	Final Distance (in)
1	1	4	Load Limit	Pass	Dec 22, 2020	12:19:14 PM	-0.2145
1	1	6	Load Limit	Pass	Dec 22, 2020	12:19:14 PM	-0.4220
1	2	4	Load Limit	Pass	Dec 22, 2020	12:19:14 PM	-0.2165
1	2	6	Load Limit	Pass	Dec 22, 2020	12:19:14 PM	-0.4225
1			Overall Run	Pass	Dec 22, 2020	12:19:14 PM	0.3215
Maximum							0.3215
Minimum							-0.4225
Mean							-0.1910
Std. Dev.							0.2723
Variance							0.0742

The following additional information is displayed in a multi-step test versus a basic test:

Run No.

Run number.

Step No.

Indicates the step number within the multi-step sequence. Only steps configured to display results are shown in this table.

If more than one loop is configured in the test, the table includes the **Loop No.** and **Cycle Count** columns, as shown below:

Run No.	Loop No.	Cycle Count	Step No.	Step Type	Status	Date	Time	Final Distance (in)
1	1	1	4	Load Limit	Pass	Dec 22, 2020	01:50:11 PM	-0.2140
1	1	1	6	Load Limit	Pass	Dec 22, 2020	01:50:11 PM	-0.4210
1	1	2	4	Load Limit	Pass	Dec 22, 2020	01:50:11 PM	-0.2150
1	1	2	6	Load Limit	Pass	Dec 22, 2020	01:50:11 PM	-0.4250
1	2	1	9	Load Limit	Complete	Dec 22, 2020	01:50:11 PM	-0.3140
1	2	2	9	Load Limit	Complete	Dec 22, 2020	01:50:11 PM	-0.3175
				Overall		Dec 22,	01:50:11	

Since any number of loops may be configured in a multi-step test, **Loop No.** identifies the loop within the test. **Cycle Count** refers to the cycle number within a specific **Loop** step.

Overall Run Status

When there is more than one pass/fail status per run, an additional row is added to the Results table, labeled **Overall Run**. This provides a comprehensive pass/fail determination for the entire run. If all steps pass, the **Overall Run** status is **Pass**. If any step fails, the overall status is **Fail**.

Basic information and test start and stop functions are the same as in the **Graph** screen.

10.3.2 Results Presentation

If the run fails, the entire row will appear red, and the **Status** cell includes a description of the failure. Example:

2	Fail (Lower Distance Limit)	Dec 21, 2020	02:00:58 PM	20.00	-0.1830
---	-----------------------------	--------------	-------------	-------	---------

An exception is denoted in the same manner, highlighted orange. Example:

3	Exception (Distance Limit)	Dec 21, 2020	02:17:45 PM	20.00	0.5000
---	----------------------------	--------------	-------------	-------	--------

When an exception occurs, the crosshead stops. It will not return to the **Home** position, even if **Return Home** is enabled in the test setup. To manually return home, select **Return Home**.

10.3.3 Invalidating a Result

There may be an occasion where the result must be invalidated, for example, if the test was started accidentally, or the sample slipped out of the grip. In such instances, a run may be invalidated.

Highlight anywhere within the row, then select **Invalidate Run**. A message box appears as follows:

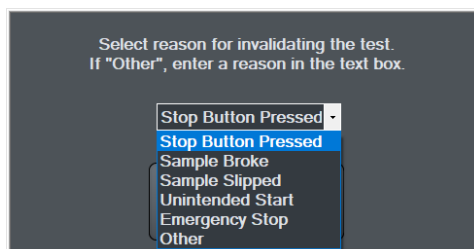

Select the reason from a pre-populated list, or select **Other** and enter a custom reason.

The **Status** cell will be highlighted yellow, as shown in the following example:



Note: once a run has been invalidated, it cannot be re-validated.

10.3.4 Results Processing

Save Results

Save results to a file, which can later be recalled. IntelliMESUR automatically assigns a file name containing the test name, followed by a time stamp. Example: *Peel test-Dec-7-2020-03-25-57-PM*

The file name may be changed if desired.

Recall Results

Recall previously saved results.

Note: Any currently displayed results will be deleted when previous results are recalled. Consider saving current results first.

Export Results

Export results to a .csv file. The file name is automatically assigned as described above. An example results file opened in *Excel* appears as follows:

	A	B	C	D	E	F	G	H	I
1	Component Break Test								
2									
3	System Information:								
4	IntelliMESUR Version: 1.0								
5	Test Frame Model: F305								
6	Test Frame Serial Number: 1234567								
7	Test Frame Capacity: 300 lbf / 1.5 kN								
8	Test Frame Firmware Version: 1.00.00								
9	Load Cell Model: FS05-100								
10	Load Cell Capacity: 100 lbf								
11	Load Cell Serial Number: 7777777								
12	Calibration Date: 9/30/2020								
13	Calibration Due Date: 09/30/2021								
14									
15	Run No.	Status	Serial Number	Date	Time	Speed (in/min)	Max Load (lbf)	Max Distance (in)	
16	1	Pass	12345	11-Dec-20	12:43:37 PM	10	-4.74	0.3805	
17	2	Pass	98765	11-Dec-20	12:43:48 PM	10	-4.54	0.365	
18	3	Pass	02468	11-Dec-20	12:43:58 PM	10	-5.16	0.375	
19									
20	Statistics								
21	Maximum						-5.16	0.3805	
22	Minimum						-4.54	0.365	
23	Mean						-4.82	0.3735	
24	Std. Dev.						0.2584	0.0064	
25	Variance						0.0668	0	
26									

Clear Results

Clear all results from the table.

Note: Clearing results also clears the graph.

10.4 Data Details View

Data Details view tabulates raw data for a run, including reading number, load, distance, and elapsed time. The screen appears as follows:

The screenshot displays the 'Peel test' data details view. On the left, there are three toggle switches labeled 1, 2, and 3. The main area contains a table with the following data:

Reading	Load [lbF]	Distance [in]	Time [s]
1	0.54	0.1375	1.030
2	0.66	0.1390	1.040
3	0.82	0.1410	1.050
4	0.98	0.1425	1.060
5	1.16	0.1440	1.070
6	1.36	0.1460	1.080
7	1.60	0.1475	1.090
8	1.82	0.1490	1.100
9	2.06	0.1510	1.110
10	2.32	0.1525	1.120
11	2.56	0.1545	1.130
12	2.82	0.1565	1.140
13	3.06	0.1580	1.150
14	3.30	0.1595	1.160
15	3.54	0.1615	1.170
16	3.78	0.1630	1.180
17	4.02	0.1645	1.190
18	4.24	0.1660	1.200
19	4.46	0.1680	1.210
20	4.68	0.1695	1.220
21	4.88	0.1715	1.230
22	5.10	0.1730	1.240

Below the table are four buttons: 'Tabulate All Run Data', 'Recall Run', 'Save Run Data', and 'Export Run'. At the bottom, there is a navigation bar with icons for 'Home', 'Graph', 'Results', 'Data Details', 'Report', and 'Manual Control'. The status bar at the very bottom shows: 'Load Cell: 50 lbF | Cal Due: Sep 30, 2021 | Dec 22, 2020 02:35:44 PM | Licensed | Current User: Admin'.

If **Overlay Runs on Graph** is selected in the test setup, data for up to 10 runs may be viewed by selecting the desired run number to the left of the table.

10.4.1 Additional Functions

Tabulate All Run Data

The table populates up to 4,000 data points. If the run contains more than 4,000 points, IntelliMESUR filters the data to maintain a maximum of 4,000 points. To view up to 1 million points per run, the maximum per run, select **Tabulate All Run Data**. Larger data sets may require several minutes to fully tabulate.

Recall Run

Recall data from a previously saved run.

Save Run Data

Save the run data for future recall.

Export Run

Export the run data to a .csv file. An example results file opened in *Excel* appears as follows:

	A	B	C	D	E	F	G	H
1	Peel test							
2								
3	System Information:							
4	IntelliMESUR Version: 1.0							
5	Test Frame Model: F305							
6	Test Frame Serial Number: 1234567							
7	Test Frame Capacity: 300 lbf / 1.5 kN							
8	Test Frame Firmware Version: 1.00.00							
9	Load Cell Model: FS05-50							
10	Load Cell Capacity: 50 lbf							
11	Load Cell Serial Number: 9876543							
12	Calibration Date: 9/30/2020							
13	Calibration Due Date: 09/30/2021							
14								
15								
16	Reading	Load [lbf]	Distance [in]	Time [s]				
17	1	-0.52	0.1395	1.04				
18	2	-0.56	0.141	1.05				
19	3	-0.6	0.143	1.06				
20	4	-0.62	0.1445	1.07				
21	5	-0.64	0.146	1.08				
22	6	-0.68	0.148	1.09				
23	7	-0.7	0.1495	1.1				
24	8	-0.74	0.151	1.11				
25	9	-0.76	0.153	1.12				
26	10	-0.8	0.1545	1.13				
27	11	-0.84	0.1565	1.14				
28	12	-0.86	0.1585	1.15				
29	13	-0.9	0.16	1.16				
30	14	-0.94	0.1615	1.17				
31	15	-0.98	0.163	1.18				
32	16	-1.02	0.165	1.19				

10.5 Creating a Report

A report may be created, containing the results, graph, equipment used, and other pertinent information. The screen appears as follows:

The screenshot shows the 'Peel test' report creation interface. The header is blue with the title 'Peel test' and user icons. The main area is dark grey with several sections:

- Company Logo:** ABC Manufacturing logo with an 'Include' toggle.
- Company Info:** ABC Manufacturing Company, 123 Industrial Drive, Anytown, NY 12345.
- Report Title:** Peel Test.
- Initial Text:** A batch of T-peel tests were performed on 1" samples, at a rate of 6 in/min. Peak results were obtained and compared against pass/fail criteria.
- Conclusion Text:** All samples passed.
- Test Image:** A small image of a test setup with an 'Include' toggle.
- Include:** System Information, Results, and Graph toggles.
- Additional Text:** Equipment used: - F305 test frame, - FS05-20 load cell, - G1008 grips.

At the bottom, there are icons for Print Preview, Print, Save Template, and Open Template. A navigation bar at the very bottom contains icons for Home, Graph, Results, Data Details, Report, and Manual Control.

10.5.1 Creating a Template

Open a previously saved template by selecting **Open Template**, or create a new one. As shown in the above image, any of the following information may be specified in a report template, as desired:

Company Logo

Browse for a company logo, or other image, and select the desired alignment at the top of the report.

Test Image

If the test is saved in **Favorites** with an associated image, that same image is included in the report template by default. Otherwise, browse to the desired image.

Include*System Information*

- IntelliMESUR software version
- Test frame model number
- Test frame force capacity
- Test frame serial number
- Test frame firmware version
- Force sensor model number
- Force sensor force capacity
- Force sensor serial number
- Force sensor previous calibration date
- Force sensor next calibration date

*Results**Graph***Company Info**

Use this space to enter your company's contact information, or any other pertinent information. This will appear directly below the logo.

Report Title**Initial Text, Additional Text, Conclusion Text**

After filling in the above information, optionally save the template by selecting **Save Template**. Otherwise, select **Print Preview** to preview the report or **Print** to create it.

An example report is as follows:



ABC Manufacturing Company
123 Industrial Drive
Anytown, NY 12345



Peel Test

Peel Test.tst

A batch of T-peel tests were performed on 1" samples, at a rate of 6 in/min. Peak results were obtained and compared against pass/fail criteria.

Equipment used:

- F305 test frame
- FS05-20 load cell
- G1008 grips

System Information:

IntelliMESUR Version: 1.0.0
Frame Model: F305
Test Frame Serial Number: 1234567
Test Frame Capacity: 300 lbf / 1.5 kN
Test Frame Firmware Version: 1.00.00
Load Cell Model: RM105-0
Load Cell Serial Number: 9876543
Calibration Date: Sep 30, 2020
Calibration Due Date: Sep 30, 2021

Results

Run No.	Status	Date	Time	Speed (in/min)	Max Load (lbf)
1	Pass	Dec 22, 2020	04:22:45 PM	10.00	◆ 5.60
2	Pass	Dec 22, 2020	04:22:51 PM	10.00	◆ 5.20
3	Pass	Dec 22, 2020	04:22:57 PM	10.00	◆ 5.02

Statistics

Statistics	Status	Date	Time	Speed (in/min)	Max Load (lbf)
Maximum					◆ 5.60
Minimum					◆ 5.02
Mean					◆ 5.28
Std. Dev.					0.2424
Variance					0.0588

Graph

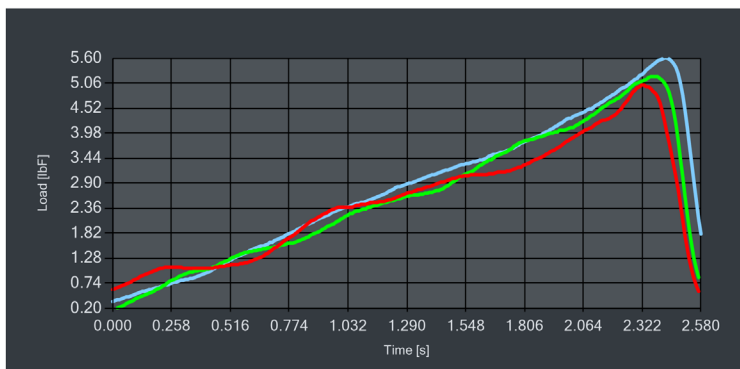

All samples passed.

10.6 Recalling Previous Data

To recall previously saved data, select **Recall Test Data** from the **Home** screen.

Then select **Recall Run** or **Recall Results**, as appropriate, and select the desired file.

11 CALIBRATION

11.1 Force Sensor Calibration

Mark-10 recommends calibrating force sensors at least once per year. Series FS05 and R07 force sensors may be calibrated while installed on a Series F test frame, or may be removed the frame and calibrated with a Mark-10 Model M5I or Model M7I indicator.

11.1.1 Calibrating on a Series F Frame

- Using **Manual Control**, move the crosshead high enough to accommodate calibration fixtures and equipment.

A master load cell should be mounted to the test frame and interface with the force sensor, along with appropriate mounting brackets and fixtures. Compression and tension springs are recommended. Caution should be taken while handling such equipment.

- Select **Calibration** from the **Settings** screen. The screen appears as follows:

The **Previous Calibration Date** and **Previous Calibration Due Date** are displayed at the top.

To update the calibration date to today's date, select **Update Calibration Date to Today**, then set the **Next Calibration Due Date** as desired. The calibration date may be updated regardless

of whether calibration takes place. This accounts for situations in which the force sensor accuracy has been verified to within specification and re-calibration is not necessary. Note that the due date may be modified regardless of whether the calibration date was updated.

Optionally configure a **Calibration Reminder**, in days.

To save the settings and return to the **Home** screen without calibrating, select **Save and Exit**. To continue with calibration, select **Save and Calibrate**.



The calibration date is intended for informational purposes only. Because it may be modified independently of the actual calibration, it should not be relied upon as evidence of successful calibration.

- After selecting **Save and Calibrate**, the first screen of the calibration wizard appears as follows:

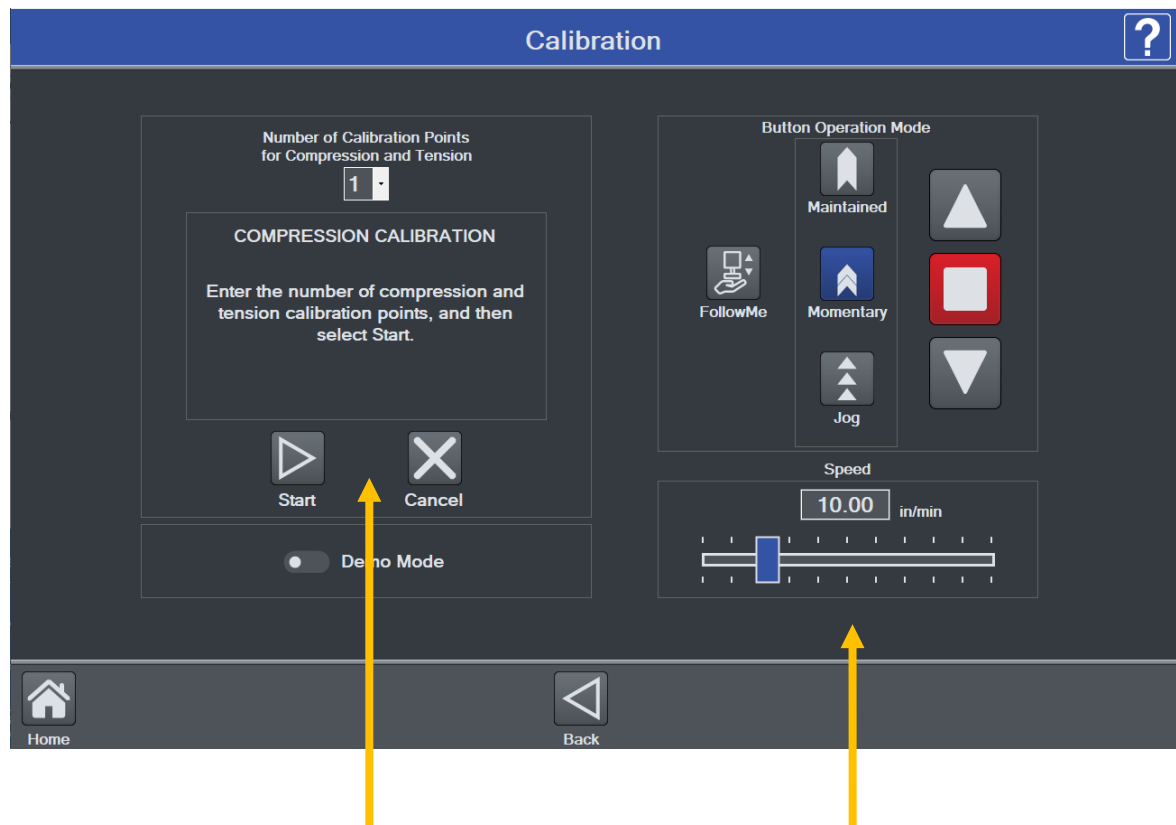

Calibration instruction

Crosshead motion control

Optionally use **Demo Mode** to become familiar with the steps required for calibration, without having to physically perform any actions.

Crosshead motion controls are similar to those in **Manual Control**. They are available through all calibration steps to apply the required force. **FollowMe** mode may not be used in steps requiring the application of load; it can only be used in crosshead positioning steps.



For finest control, and to help prevent an overload, **Momentary** mode is recommended. Start with a slow rate of speed.

- The force sensor can be calibrated at up to 10 points in each direction. Enter the number of calibration points for each direction (tension and compression). At minimum, the sensor must be calibrated at full scale in both directions.

Note: To achieve highest possible accuracy, it is recommended to calibrate the force sensor at 5 or more even intervals in both tension and compression directions. For example, an FS05-10 force sensor (10 lbF max) should be calibrated at 2, 4, 6, 8, and 10 lbF loads in each direction.

Select **Start**.

-
-
-
-
-

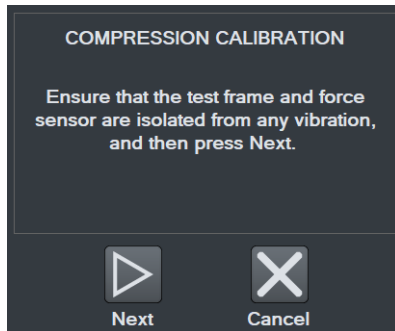

-
-
-
-
-
- Ensure that the equipment is isolated from any vibration, then select **Next**.



Attach fixtures to enable compression force loading, then select **Next**.

-
-
-
-
-
-
-

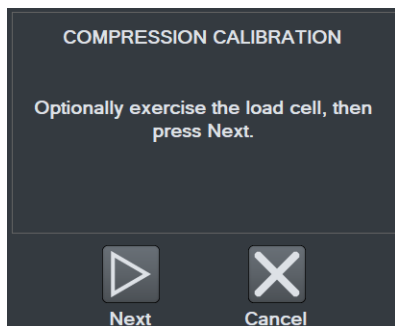

Optionally load and unload the force sensor to full scale several times, then select **Next**.

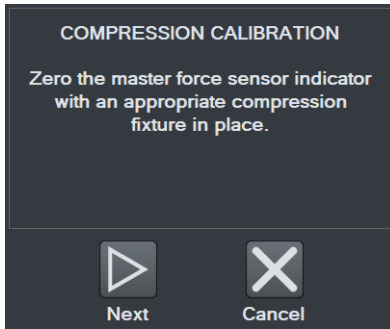

Zero the indicator associated with the master load cell. Engage the calibration fixtures, and ensure that there is no load applied to the force sensor. Then select **Next**.

9.

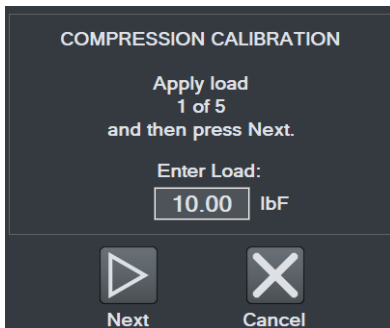

Apply the indicated compression load using the **crosshead motion controls**. The load value defaults to even intervals. For example, for a 50 lbF force sensor with 5 calibration points, the first default load value is 10 lbF. All load values may be edited by up to $\pm 20\%$.

Select **Next**. Follow the same procedure for all required loads.

10. After the final compression load, the screen appears as follows:

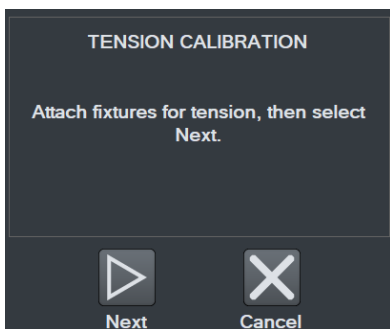

Configure the calibration fixtures and equipment for tension loading. Then select **Next**.

11. Subsequent steps are the same as in compression:
 - Exercise the force sensor
 - Install necessary fixtures
 - Apply the required loads
12. When tension calibration is complete, the screen appears as follows:



Select **Finish** to complete the calibration, or **Cancel** to exit without saving the calibration.

11.1.2 Calibrating with a Mark-10 Indicator

Series FS05 and R07 force sensors may be removed and calibrated in a different location with a Mark-10 model M5I or M7I indicator with minimum firmware version of 2.2.8.

Series R07 force sensors plug directly into an indicator via its Plug & Test® connector, as shown below:



Series FS05 force sensors require an adapter part no. AC1083 to plug into an indicator, as shown below:



The optional extension cable part no. AC1084 can be useful in addition to AC1083 where the indicator cannot be positioned close to the force sensor.

For calibration instructions, refer to the indicator's user's guide.

11.2 Speed and Distance Calibration

Mark-10 recommends verification of speed and distance accuracy once per year. Note that no adjustments may be made. Calibration is offered by Mark-10, as well as certain distributors and third-party laboratories.

11.3 Test Frame Deflection Compensation

Load cells within force sensors deflect under load. Test frames also deflect under load, affecting the accuracy of distance measurements. Series F test frames, Series FS05 force sensors, and Series R07 force sensors are compensated at the factory.

However, to account for additional deflection within grips or fixtures associated with the test, IntelliMESUR provides a utility for further compensation.

1. Install the necessary grips and fixtures. If compensating in the compression direction, ensure that the upper fixture is self-leveling, to make full and even contact with the lower fixture. Using **Manual Control**, carefully move the grips or fixtures close together until they are almost touching.
2. Select **Deflection Compensation** from the **Settings** screen. The screen appears as follows:

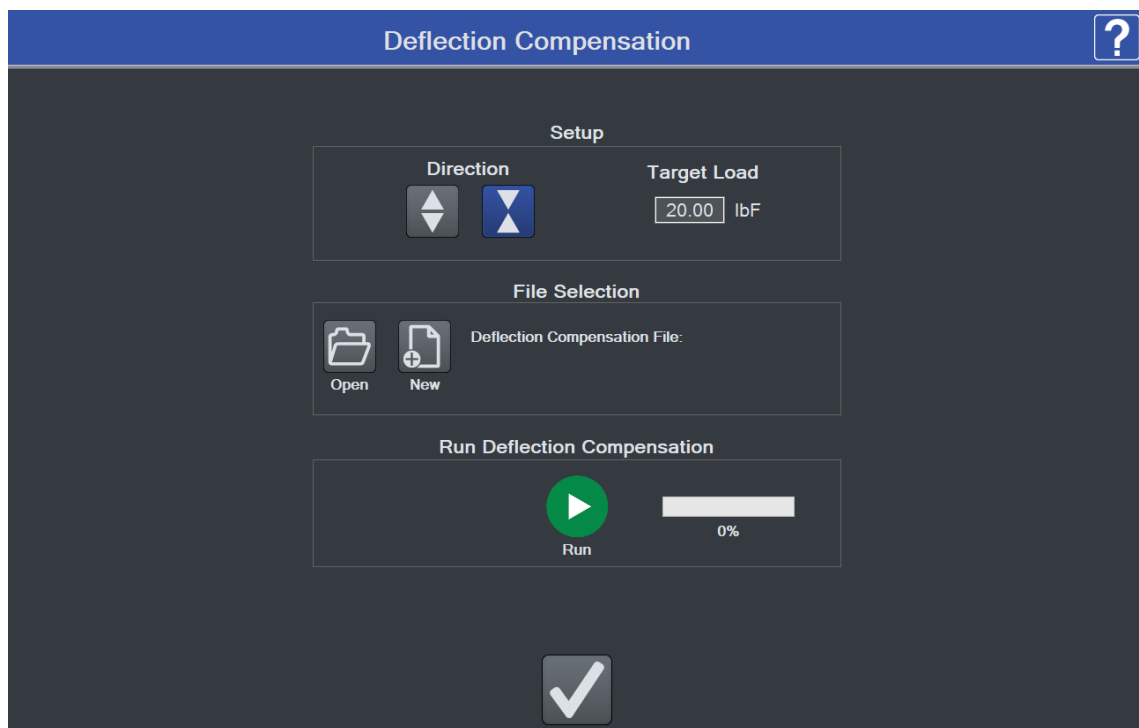

3. Configure the direction, tension or compression, then set the target load.
4. Create a new deflection compensation file, or overwrite a previously saved file, by browsing to the desired file location.
5. Select **Run**. IntelliMESUR will indicate when the compensation is complete.
6. The saved deflection compensation file may now be associated with any test, as described in previous sections.

12 MAINTENANCE & SERVICE – MODELS F105 / F305 / F505 / F505H

12.1 Physical Maintenance

Series F test frames should be operated in a dry and clean area. Under these circumstances the main consideration is lubrication of the ball screw and slider. Periodic lubrication improves performance and increases the longevity of test frame components.

12.1.1 Ball screw lubrication – twice per year

Ball screw lubrication frequency should increase if the frame is operated in adverse environmental conditions, including airborne dust, temperature and humidity extremes, and other factors. Follow these instructions:

1. Remove the upper and lower bellows to expose the ball screw, by separating the Velcro strips at each end of the crosshead. Velcro locations are identified in the image below:



2. Using a brush, apply a small amount of general-purpose bearing grease to the screw, as shown in the image below:



3. Cycle the crosshead up and down several times until the newly applied grease has been spread evenly over the length of the screw.
4. Re-install the bellows.

12.1.2 Slider lubrication – once per year

Slider lubrication frequency should increase when used in in adverse conditions. Follow these instructions:



Two people are recommended for this procedure, due to the risk of tipping.

1. Flip the test frame upside down, as shown below. Be sure to do this on a flat and secure working surface.



2. While one person is supporting the column, the other person removes six screws from the underside of the base of the test frame, as shown below:



3. Remove the base, then remove the two screws on the right, as shown below:

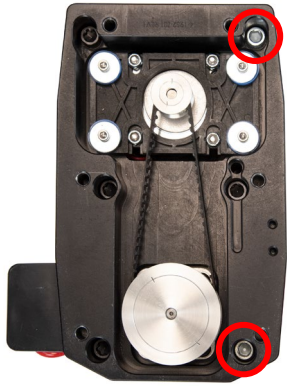

4. Remove the Mark-10 logo strip, then remove all screws from the side of the test frame, as shown below:



5. Locate the grease receptacle on the slider, as identified below:

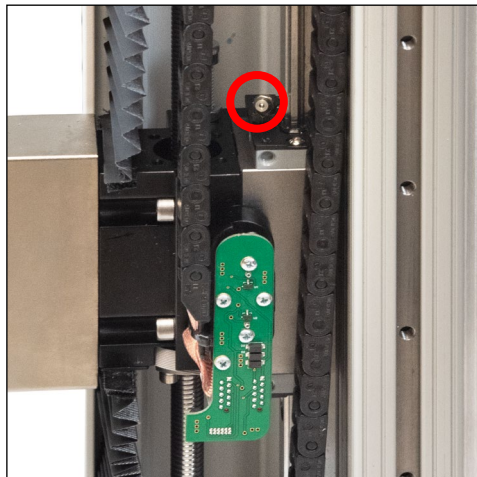

- Using a grease gun, add general purpose bearing grease to the inside of the slider until full. Wipe clean any spillage. Refer to the image below:

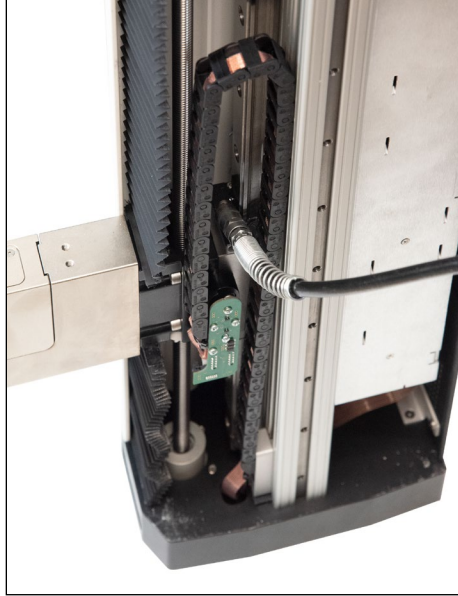

- Cycle the crosshead up and down several times until the newly applied grease has been spread evenly over the length of the slide.
- Re-assemble by repeating steps 1 through 4 in reverse.

12.1.3 Check for loosened grips and attachments – daily

Check to ensure that the grips attached to the force sensor and base plate are firmly secured. Looseness could result in a potentially hazardous situation.

12.1.4 Check for loosened components – once per month

- Remove the test sample from the test frame.
- Attempt to loosen subcomponents of the test frame (ex. fasteners, brackets, etc.). All components should be firmly attached. If any looseness is detected, stop using the test frame and contact Mark-10 or a distributor for instructions.

12.2 Removing the Motor Drive Unit (MDU)

The MDU is the self-contained location of most of the test frame's electronics, and is designed for quick removal and replacement in the event of service or repair. If requested by Mark-10 or a distributor to remove and/or replace the MDU, follow these instructions:

1. Disconnect power to the test frame.
2. Remove the screws from the rear panel, then remove the panel.
3. When the MDU is accessible, disconnect the four connectors and ground wire identified in the image below. To more easily access the ground wire, loosen one of the screws connecting the T-shaped bracket to the base, and swing it around.
4. Partially loosen the four screws securing the MDU to the frame, lift the MDU up slightly, and pull out, as shown in the image below-right. Reinstall in the same fashion.

Locations of connectors, ground wire, and bracket



Removing the MDU



13 MAINTENANCE & SERVICE – MODELS F1505 / F1505S / F755 / F755S

13.1 Physical Maintenance

Series F test frames should be operated in a dry and clean area. Under these circumstances the main consideration is lubrication of the ball screw and slider. Periodic lubrication improves performance and increases the longevity of test frame components. On average, lubrication is recommended twice per year. However, the frequency should increase if the frame is operated in adverse environmental conditions, including airborne dust, temperature and humidity extremes, and other factors.

13.1.1 Ball screw lubrication

Follow these instructions for proper ball screw lubrication:

1. Remove the upper and lower bellows to expose the ball screw, by separating the Velcro strips at each end of the crosshead. Velcro locations are identified in the image below:

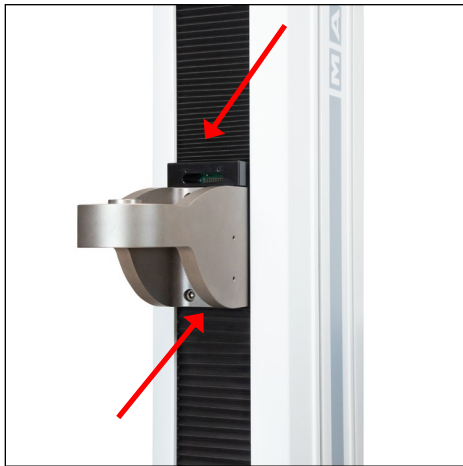

2. Using a brush, apply a small amount of general-purpose bearing grease to the screw, as shown in the image below:



3. Cycle the crosshead up and down several times until the newly applied grease has been spread evenly over the length of the screw.
4. Re-install the bellows.

13.1.2 Slider lubrication

As with the ball screw, periodic lubrication of the slider improves performance and increases the longevity of test frame components. Frequency depends on environmental conditions and usage.

Follow these instructions for proper slider lubrication:

1. Lay the test frame on its side on a flat and secure working surface. Exercise caution while doing so, as the test frame is heavy.
2. Remove the upper and lower bellows to expose the slider, as per the instructions above.
3. Locate the grease receptacle on the slider, identified in the below image:

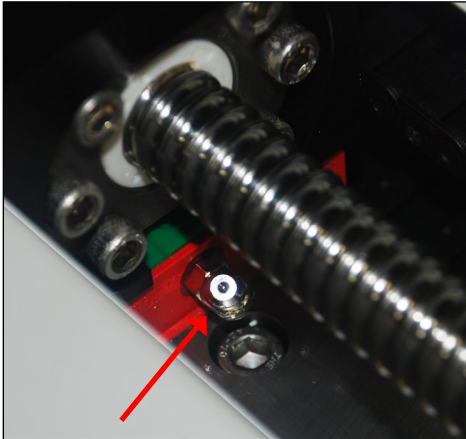

4. Using a grease gun, add general purpose bearing grease to the inside of the slider until full. Wipe clean any spillage. Refer to the image below:



5. Cycle the crosshead up and down several times until the newly applied grease has been spread evenly over the length of the slide.
6. Re-install the bellows.

13.1.3 Check for loosened grips and attachments – daily

Check to ensure that the grips attached to the force sensor and base plate are firmly secured. Looseness could result in a potentially hazardous situation.

13.1.4 Check for loosened components – once per month

1. Remove the test sample from the test frame.
2. Attempt to loosen subcomponents of the test frame (ex. fasteners, brackets, etc.). All components should be firmly attached. If any looseness is detected, stop using the test frame and contact Mark-10 or a distributor for instructions.

13.2 Removing the Motor Drive Unit (MDU)

The MDU is the self-contained location of most of the test frame's electronics, and is designed for quick removal and replacement in the event of service or repair. If requested by Mark-10 or a distributor to remove and/or replace the MDU, follow these instructions:

1. Disconnect power to the test frame.
2. Remove the screws from the lower rear panel.
3. When the MDU is accessible, disconnect the four connectors and ground wire identified in the image below.
4. Partially loosen the four screws securing the MDU to the frame, lift the MDU up slightly, and pull out, as shown in the image below-right. Reinstall in the same fashion.

Locations of connectors and ground wire



Removing the MDU



14 ACCESSORY INSTALLATION

14.1 Installing the External Emergency Switch Connector

When a shield is used, the standard emergency stop switch is located within the enclosure, preventing its use during a test. An external limit switch is, therefore, included with Mark-10 shields.

A corresponding connector is pre-installed on Models F755, F755S, F1505, and F1505S test frames. For Models F105, F305, and F505, the connector must be installed in the rear of the MDU. It may be factory-installed if ordered at time of order (reference part no. 09-1315), or installed by the customer in the field (reference part no. 09-1315-1). Follow these instructions for field installation:



This process involves handling sensitive electronic components. We recommend proceeding only if you have experience working with electronics. Mark-10 offers a factory retrofit.

1. Remove the MDU as instructed in previous sections.
2. Punch out the opening below the label, "External Emergency Switch", as highlighted below:



3. Remove the back panel from the MDU housing with the four screws, highlighted below:



4. Route the two wires from the rear of the connector through the hole, as shown below:



5. Connect the two cables to the white mating plug, as shown below:



6. Install the connector to the housing by inserting the spacer over the body of the connector, then tightening the nut, as shown below:

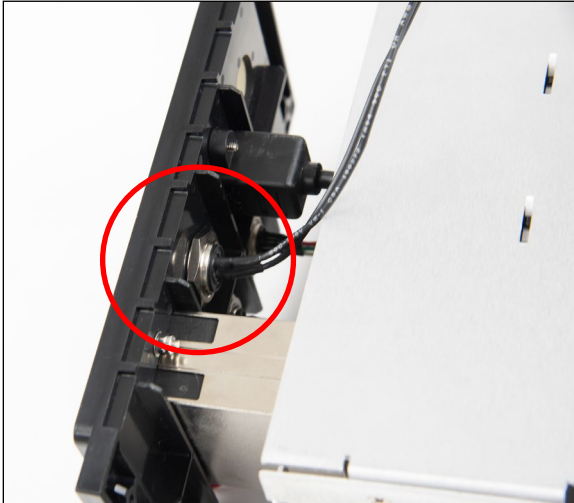

7. Reassemble the MDU and reinstall, as instructed in earlier sections.
8. Connect the cable from the remote emergency stop switch.

14.2 Separating the Column From The Base / Column Extension Installation – F105 / F305 / F505 / F505H

The column may be separated from the base to accommodate alternative mounting arrangements, for considerations such as safety, increased sample clearance, integration into existing equipment, etc.

14.2.1 Removing the base from the column

To remove the base, follow these instructions:

1. Power off the test frame and disconnect the power cable.
2. Lay the test frame on its side and remove the six screws from the underside of the base. Carefully remove the base from the frame. Refer to the image below:

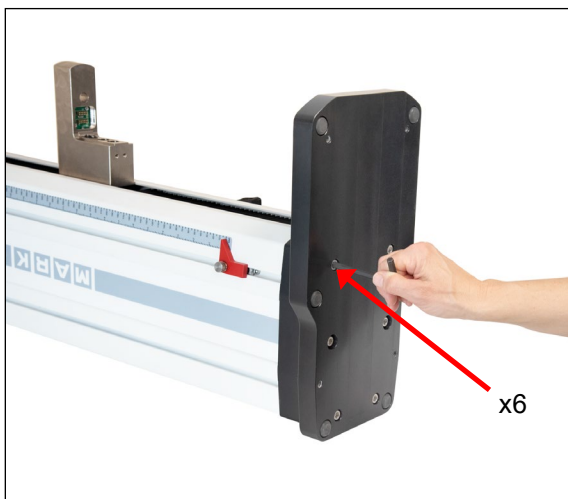

14.2.2 Retrofitting a Mark-10 AC1094-1 / -2 / -3 single column extension (optional)

If a single column extension is ordered upfront, it is pre-installed at the factory and shipped assembled. To retrofit in the field, follow these instructions:

1. Remove the two sheet metal covers from the column extensions by loosening the 16 screws, as identified in the images below:



2. Using the 6 screws removed from the test frame base, reinstall the base onto the lower flange of the column extension, as shown in the image below:

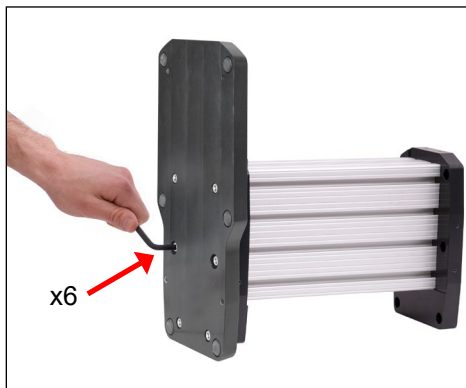

3. Attach the top flange to the bottom of the test frame column utilizing the 6 supplied screws, as shown in the image below:

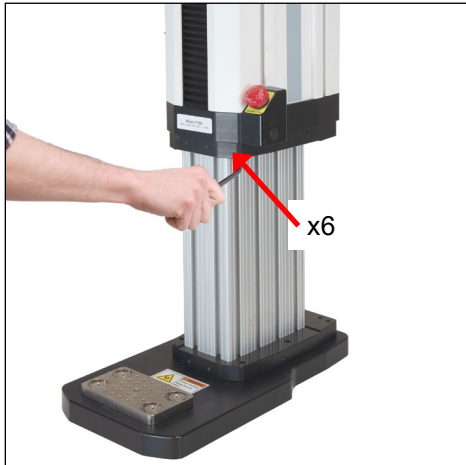

4. Position the test frame vertically and reinstall the sheet metal covers, as shown below:



Vertical column extensions present an increased tipping hazard. It is strongly recommended that the base be fastened to a workbench utilizing the holes on the underside of the base. Refer to the dimensional drawing for hole locations.

14.3 Installing a double column extension – F105 / F305 / F505

Models AC1095-1 / -2 / -3 column extensions are shipped fully assembled. To mount the test frame to the assembly, locate the 6 thru holes, match them up to the corresponding threaded holes on the underside of the frame, and install the screws. Refer to the image below:

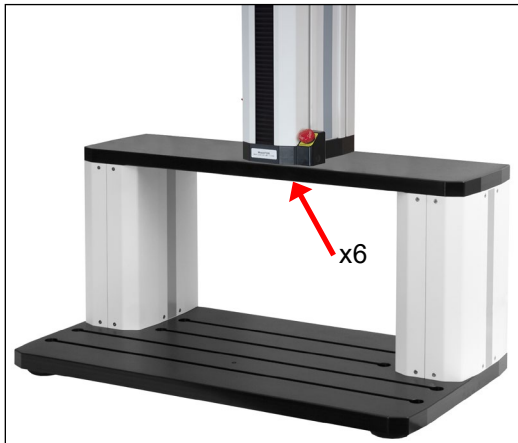

15 UPDATING SOFTWARE AND FIRMWARE

From time to time, new IntelliMESUR software versions and new test frame firmware versions will become available. To update, select **Update Software** or **Update Firmware** the **Settings** screen. The screen appears as follows:

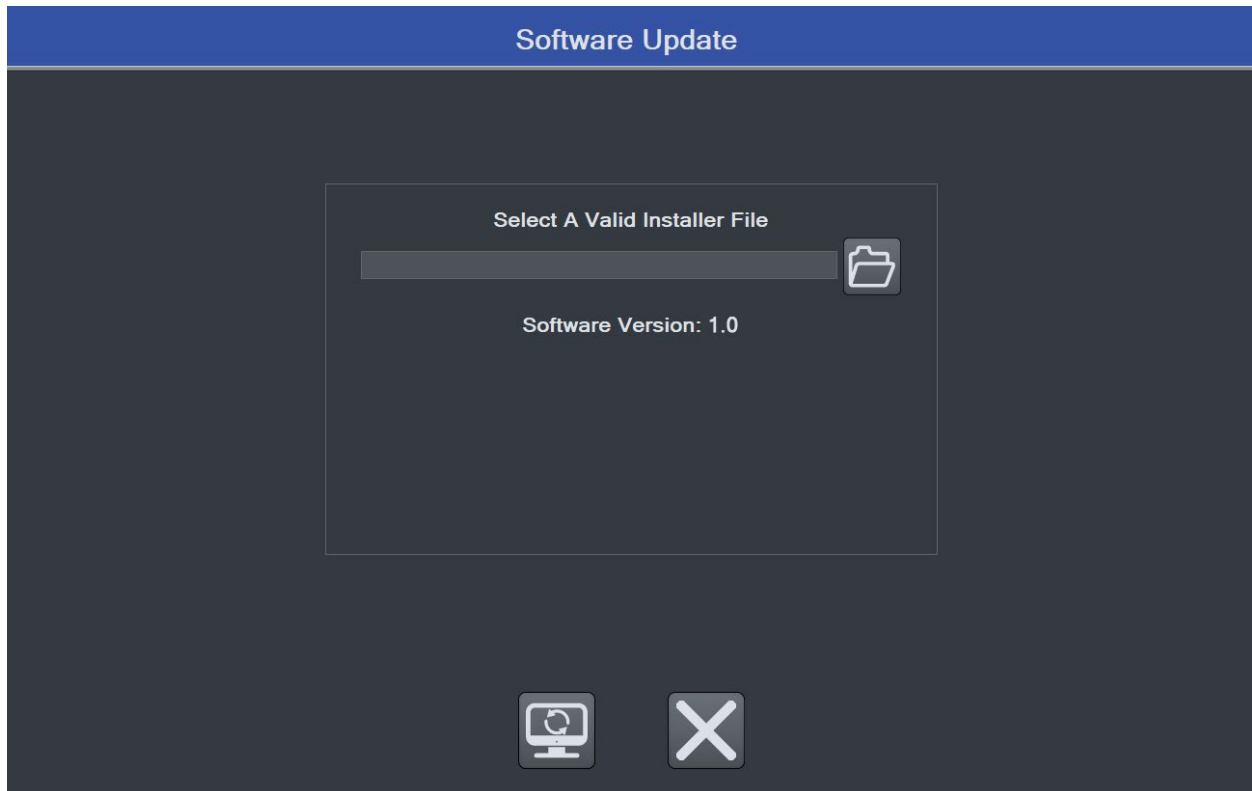

The file will be supplied by Mark-10 or a distributor. Save the file to the desired file location, browse to it, then select the **Update** button at the bottom of the screen.



Do not exit IntelliMESUR or access another screen until the update is complete.

16 SPECIFICATIONS & DIMENSIONS

16.1 Specifications

	F105	F305	F505	F505H	F755	F755S	F1505	F1505S
Load capacity*:	100 lbF [0.5 kN]	300 lbF [1.3 kN]	500 lbF [2.2 kN]		750 lbF [3.4 kN]		1,500 lbF [6.7 kN]	
Maximum travel:	18.0 in [457 mm]				32 in [813 mm]	14.2 in [360 mm]	32 in [813 mm]	14.2 in [360 mm]
Speed range:	0.02 – 45 in/min [0.5 – 1,100 mm/min]				0.001 - 60 in/min [0.02 - 1,525 mm/min]		0.001 - 70 in/min [0.02 - 1,800 mm/min]	
Load accuracy (% of full scale):	Test frame: ±0.1% Force sensor: Series FS05: ±0.1% Series R07: ±0.15%							
Load sampling rate:	20,000 Hz							
Data acquisition rate:	1,000 Hz							
Speed accuracy:	±0.2% of setting, virtually no variation with load							
Distance accuracy:	±0.002 in / 0.05 mm, factory-compensated at up to full load							
Distance resolution:	0.0005 in / 0.01 mm							
Limit switch repeatability:	±0.001 in [0.03 mm]							
Power:	Universal input 100-240 VAC, 50/60 Hz, 120W				Universal input 100-240 VAC, 50/60 Hz, 300W		Universal input 100-240 VAC, 50/60 Hz, 450W	
Fuse type:	1.2 A, 250V, 3AG, SLO BLO				4A, 3AG, SLO BLO			
Weight:	60 lb [27 kg]		70 lb [32 kg]		184 lb [83 kg]	149 lb [68 kg]	197 lb [89 kg]	157 lb [71 kg]
Environmental conditions:	<ul style="list-style-type: none"> - Indoor use only - Up to 6,500 ft [2,000 m] above sea level - Temperature range: 40 - 95°F [5 - 35°C] - Humidity range: up to 80% relative humidity at 31°C, decreasing linearly to 50% relative humidity at 40°C, non-condensing - Mains supply voltage fluctuations up to ±10 % of the nominal voltage - Transient overvoltages up to the levels of Overvoltage Category II - Use in environments up to Pollution Degree 2 							
Conformance:	CE							
Warranty:	3 years [see individual statement for further details]							

* Load capacity is reduced at higher speeds in the following models:

- F305: limited to 200 lbF [1 kN] above 24 in [610 mm]/min
- F505 / F505H: limited to 300 lbF [1.3 kN] above 24 in [610 mm]/min
- F755 / F755S: limited to 500 lbF [2.3 kN] above 35 in [900 mm]/min
- F1505 / F1505S: limited to 1,000 lbF [4.5 kN] above 60 in [1,525 mm]/min

16.2 Dimensions IN [MM]

16.2.1 Models F105 / F305 / F505

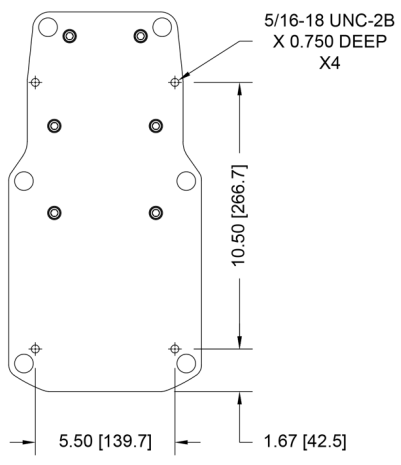
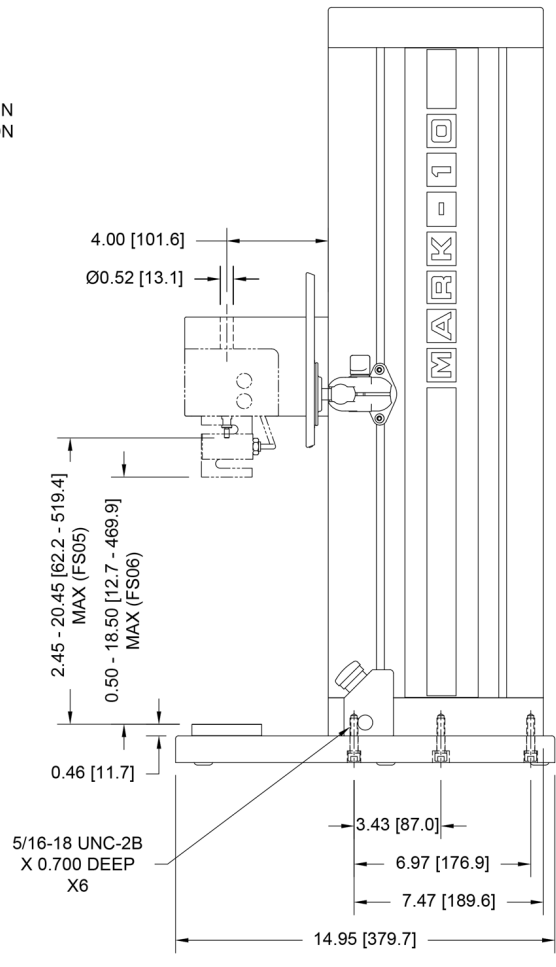
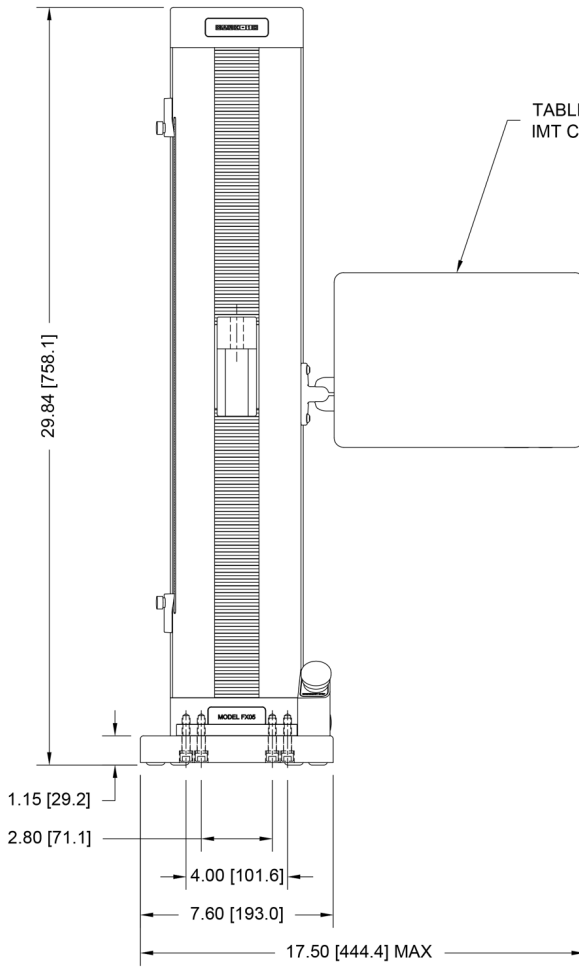

**BENCH MOUNTING HOLES
BOTTOM VIEW**

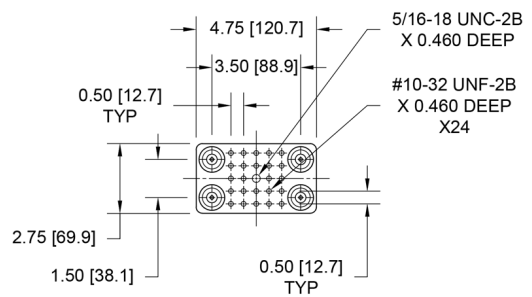

**MOUNTING PLATE
TOP VIEW**

16.2.2 Model F505H

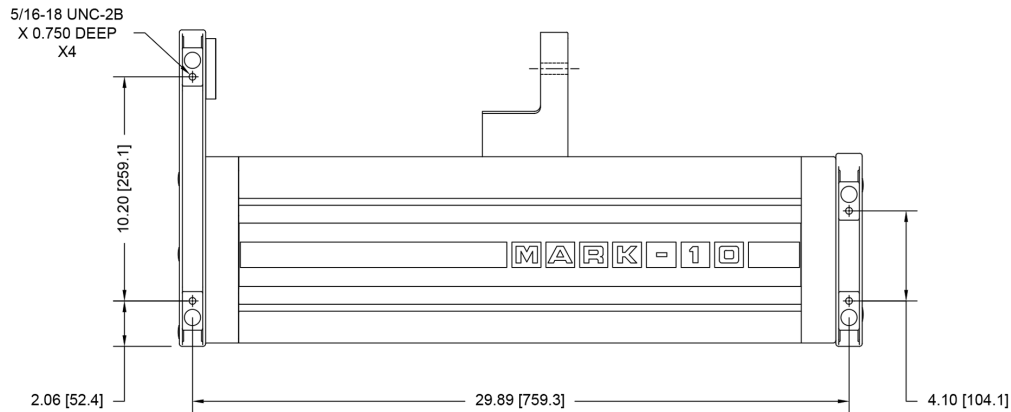
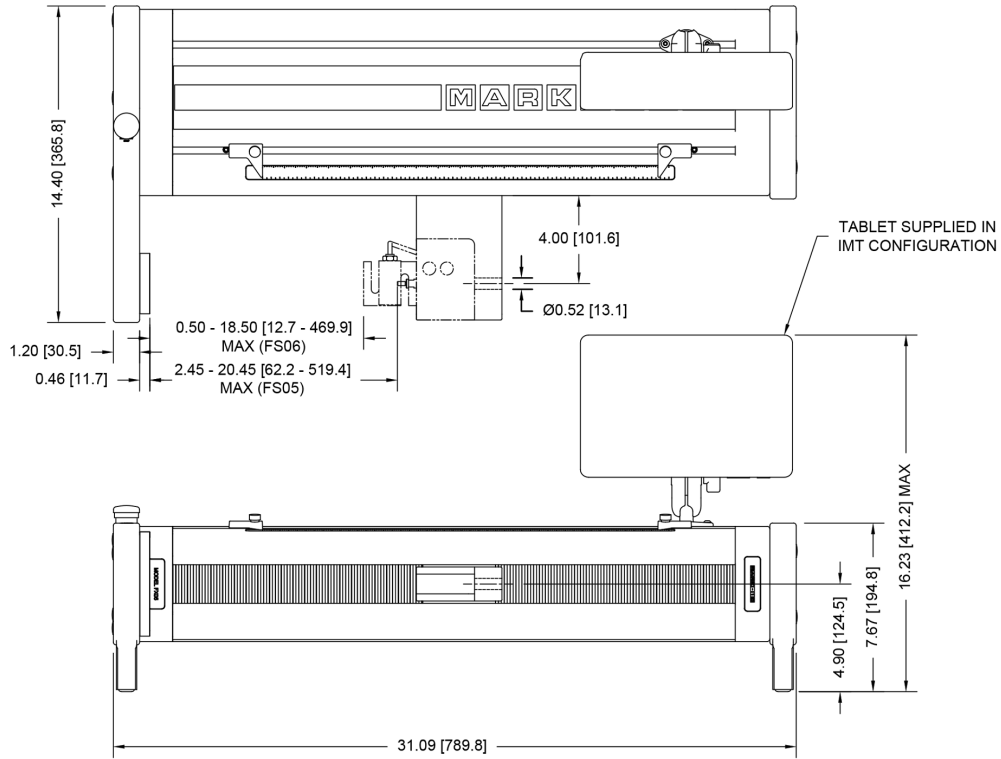

**BENCH MOUNTING HOLES
BOTTOM VIEW**

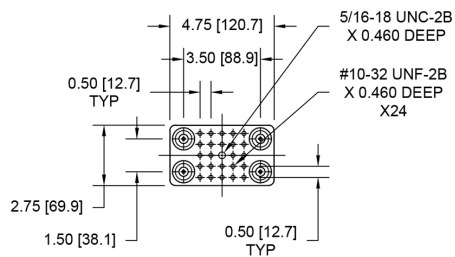

**MOUNTING PLATE
TOP VIEW**

16.2.3 Models F755 / F755S / F1505 / F1505S

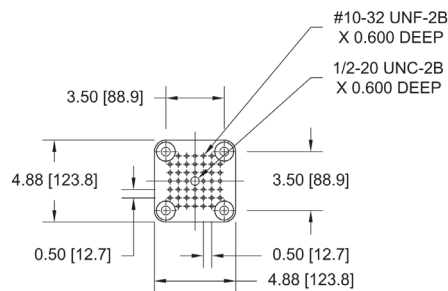
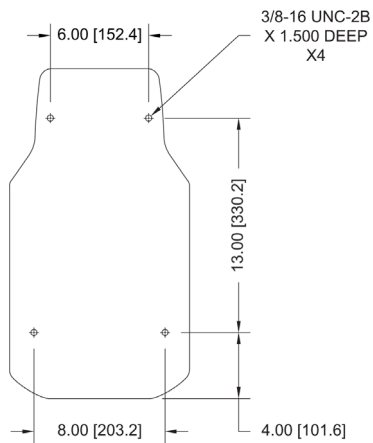
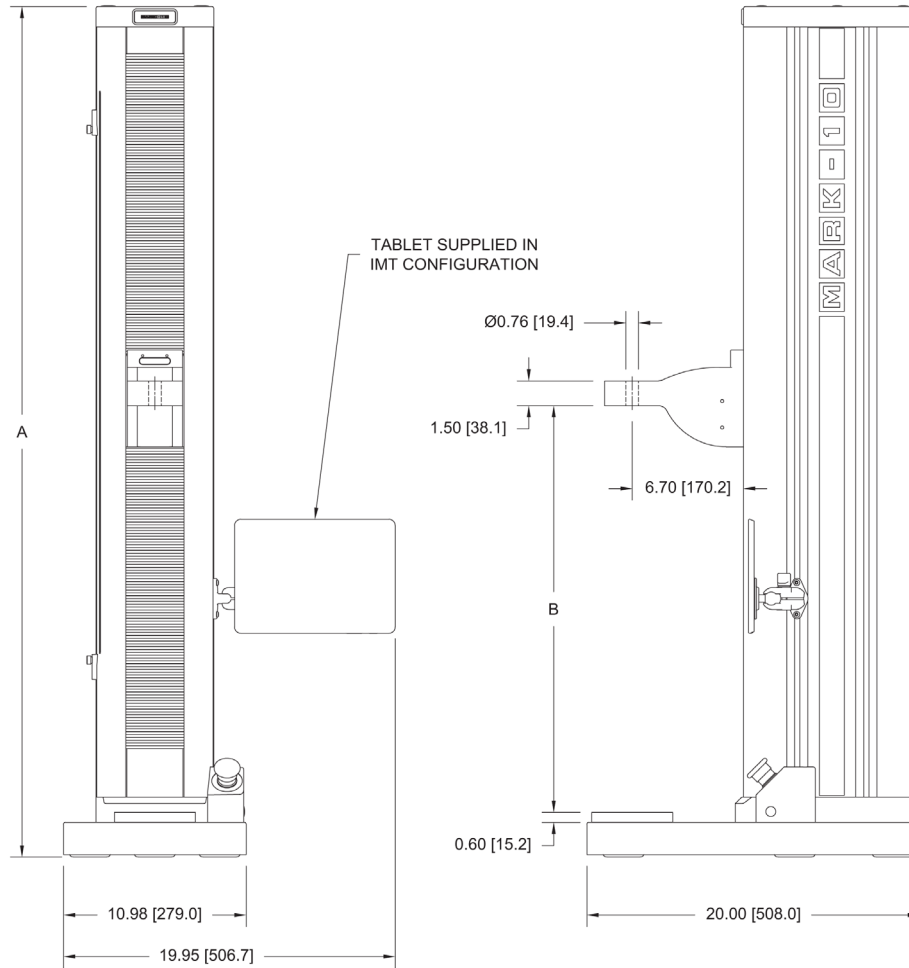

BENCH MOUNTING HOLES
BOTTOM VIEW

MOUNTING PLATE
TOP VIEW

	F755	F755S	F1505	F1505S
A	50.85 [1291.6]	33.39 [848.1]	51.35 [1304.3]	33.89 [860.9]
B	8.13 – 40.13 [206.4 – 1019.2]	8.13 – 22.33 [206.4 – 567.1]	8.13 – 40.13 [206.4 – 1019.2]	8.13 – 22.33 [206.4 – 567.1]



Mark-10 Corporation has been an innovator in the force and torque measurement fields since 1979. We strive to achieve 100% customer satisfaction through excellence in product design, manufacturing and customer support. In addition to our standard line of products we can provide modifications and custom designs for OEM applications. Our engineering team is eager to satisfy any special requirements. Please contact us for further information or suggestions for improvement.



Force and torque measurement engineered better

Mark-10 Corporation

11 Dixon Avenue
Copiague, NY 11726 USA
888-MARK-TEN
Tel: 631-842-9200
Fax: 631-842-9201
www.mark-10.com
info@mark-10.com