



Model **M3I**

DIGITAL FORCE / TORQUE INDICATOR

User's Guide

MARK-10.

Thank you...



Thank you for purchasing a Mark-10 Model M3I digital force / torque indicator, designed for use with interchangeable remote force and torque sensors. An M3I+sensor combination can be used with some Mark-10 test stands grips, and data collection software.

With proper usage, we are confident that you will get many years of great service with this product. Mark-10 instruments are ruggedly built for many years of service in laboratory and industrial environments.

This User's Guide provides setup, safety, and operation instructions. Dimensions and specifications are also provided. For additional information or answers to your questions, please do not hesitate to contact us. Our technical support and engineering teams are eager to assist you.

Before use, each person who is to use a Model M3I indicator should be fully trained in appropriate operation and safety procedures.

TABLE OF CONTENTS

OVERVIEW 2

POWER 4

SETUP 5

HOME SCREEN AND CONTROLS 7

DIGITAL FILTERS 9

SET POINT INDICATORS 10

OPERATING MODES 11

CHANGING THE UNITS 11

COMMUNICATIONS AND OUTPUTS 12

CALIBRATION 14

OTHER SETTINGS 18

SPECIFICATIONS 20

1 OVERVIEW

1.1 List of included items

Qty.	Part No.	Description
1	12-1049	Carrying Case
1	08-1022	AC adapter body with US, EU, or UK prong
1	08-1026	Battery (inside the indicator)
1	-	Certificate of calibration
1	09-1165	USB cable
-	USB driver, MESUR [®] Lite software, MESUR [®] gauge evaluation software, User's Guide Download at: www.mark-10.com/resources	

1.2 General Overview



From left to right: Model M5I indicator with Series R01 force sensor, Model M3I indicator with Series R02 force sensor, and Model M7I indicator with Series R50 torque sensor

The M3I is a universal indicator designed for displaying measurements from interchangeable mark-10 Plug & Test[®] sensors. Sensor capacities are available from 0.25 to 10,000 lbF (1 N to 50 kN) of force, and from 10 ozFin to 5,000 lbFin (7 Ncm to 550 Nm) of torque. These sensors can be handheld or mounted to a fixture or test stand for more sophisticated testing requirements.

Plug & Test[®] sensors are used with the M7I, M5I, or M3I indicators. They may be disconnected from one indicator and connected to another without the need for re-calibration or re-configuration. All such data is saved within a PCB located inside the smart connector.

and serial numbers are also identified in the **Information** screen of the indicator.

The model number, serial number, and capacity of the sensor are identified in the rectangular label located on the Plug & Test[®] connector. The model

1.3 Accuracy and Resolution

Indicator accuracy must be combined with sensor accuracy to determine the total accuracy of the system. Since sensors may be used with the M7I, M5I or M3I indicators, the accuracy of the indicator being used must be identified and taken into account, as follows:

Indicator Model	Accuracy
M3I	±0.2% of full scale
M5I / M7I	±0.1% of full scale

The total system accuracy can be calculated by adding the sensor accuracy and indicator accuracy. Refer to the following examples:

Example 1

Model RTQ50-50Z sensor with Model M3I Indicator

MR50-50Z ±0.35% of full scale	+	M3I ±0.2% of full scale	=	Total ±0.55% of full scale
---	---	-----------------------------------	---	--------------------------------------

This translates into a fixed error of up to:
 $0.55\% \times 50 \text{ ozFin} = 0.275 \text{ ozFin}$

Example 2

Model MR01-100 sensor with Model M5I Indicator

MR01-100 ±0.15% of full scale	+	M5I ±0.1% of full scale	=	Total ±0.25% of full scale
---	---	-----------------------------------	---	--------------------------------------

This translates into a fixed error of up to:
 $0.25\% \times 100 \text{ lbF} = 0.25 \text{ lbF}$

Because accuracy is defined as a *percentage of full scale*, the fixed error is possible anywhere on the scale from 0 to the capacity. As such, this value represents an increasingly large error as *percentage of reading* towards the low end of the scale. It is, therefore, recommended that a sensor is selected with capacity as close as possible to the expected load.

The resolution may be different for some sensors depending on whether an M7I, M5I, or M3I indicator is being used. For example, a Series R01 force sensor will display finer resolution when connected to a M5I indicator than when connected to an M3I indicator. Resolution information is shown in the sensors' user's guide.

1.4 Safety / Proper Usage

Read through the following safety instructions thoroughly before using the M3I with a sensor:

1. Note the sensor's capacity before use and ensure that the capacity is not exceeded. **Producing a load greater than the indicated safe overload value can damage the sensor.** An overload can occur whether the sensor's indicator is powered on or off.
2. In order to extend the life of the sensor, avoid repetitive shock and impact loading.
3. When moving the sensor to another location, never lift from the cable or strain relief. This can cause damage to the sensor. Always lift the sensor housing itself.
4. Always ensure that load is applied axially with respect to the sensor.
5. Ensure that the sensor is kept away from water or any other electrically conductive liquids at all times.
6. The sensor and indicator should be serviced by a trained technician only. AC power must be disconnected and the indicator must be powered off before the housing is opened.
7. Always consider the characteristics of the sample being tested before initiating a test. A risk assessment should be carried out beforehand to ensure that all safety measures have been addressed and implemented.

8. Typical materials able to be tested include many manufactured items, such as springs, electronic components, fasteners, caps, films, mechanical assemblies, and many others. Items that should not be used with the sensor include potentially flammable substances or products, items that can shatter in an unsafe manner, and any other components that can present an exceedingly hazardous situation when acted upon by a force. Always wear eye and face protection when testing, especially in aforementioned hazardous cases. Extra bodily protection should be worn if a destructive failure of a test sample is possible.
9. In aforementioned hazardous situations, it is strongly recommended that a machine guarding system be employed to protect the operator and others in the vicinity from shards or debris.
10. Sensors have threaded holes or chucks, designed for the mounting of grips, fixtures, or attachments. If any such accessories are used, ensure they are mounted firmly to prevent a potential safety risk to the operator and others in the vicinity. If using an accessory from a supplier other than Mark-10, ensure that it is constructed of suitably rugged materials and components. Similar precautions should be taken when mounting the sensor to a test stand, work bench, or other piece of equipment.

2 POWER

The M3I is powered either by an 8.4V NiMH rechargeable battery or by an AC adapter. Since these batteries are subject to self discharge, it may be necessary to recharge the unit after a prolonged period of storage. Plug the accompanying charger into the AC outlet and insert the charger plug into the receptacle on the indicator (refer to the illustration below). The battery will fully charge in approximately 8 hours.

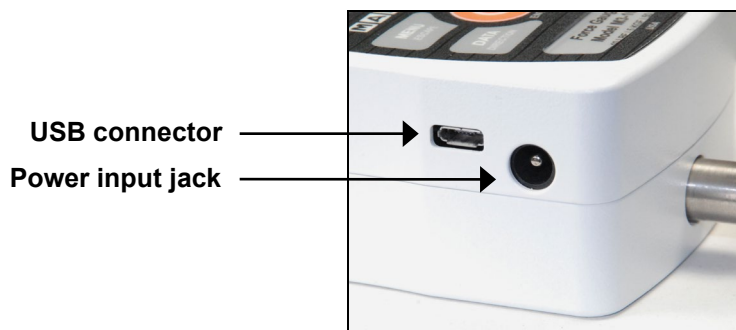





Caution!

Do not use chargers or batteries other than supplied or instrument damage may occur.

If the AC adapter is plugged in, an icon appears in the lower left corner of the display, as follows: 

If the AC adapter is not plugged in, battery power drainage is denoted in a five-step process:

1. When battery life is greater than 75%, the following indicator is present: 
2. When battery life is between 50% and 75%, the following indicator is present: 
3. When battery life is between 25% and 50%, the following indicator is present: 
4. When battery life is less than 25%, the following indicator is present: 

- When battery life drops to approximately 2%, the indicator from step 4 will be flashing. Several minutes after (timing depends on usage and whether the backlight is turned on or off), a message appears, "BATTERY VOLTAGE TOO LOW. POWERING OFF". A 4-tone audio indicator will sound and the indicator will power off.

The indicator can be configured to automatically power off following a period of inactivity. Refer to the **Other Settings** section for details.

If battery replacement is necessary, the battery may be accessed by loosening the two captive screws in the rear half of the housing and separating the two halves of the housing.

3 SETUP

3.1 Connecting a sensor

The Plug & Test® connector must be inserted into the receptacle of the M7I, M5I, or M3I indicator with the side marked "Plug & Test® Technology" facing up (see Fig. 3.1). When fully inserted, the connector will lock into place with a "click".



Fig. 3.1
Appropriate orientation of Plug & Test® connector. Sensor model number, serial number, and load capacity may be found on the labels affixed to the connector.

To release the connector, press both buttons on either side of the indicator housing to release the sensor (see Fig. 3.2). Pull the connector completely out of the indicator by holding the curved aluminum section. **DO NOT** pull on the cable or strain relief.



Fig. 3.2
Press both buttons on either side of the indicator housing to release the Plug & Test® connector.

3.2 Mounting to a plate

The M3I can be mounted to a plate with four thumb screws fastened into the appropriate holes in the rear half of the housing. Refer to the **Dimensions** section for detailed hole information and locations.

3.4 Installing the USB driver

If communicating via USB, install the USB driver available at: www.mark-10.com/resources

Caution!

Install the USB driver before physically connecting the indicator to a PC with the USB cable.

Further instructions for configuring and using the indicator's outputs are provided in the **Communications and Outputs** section.

4 HOME SCREEN AND CONTROLS

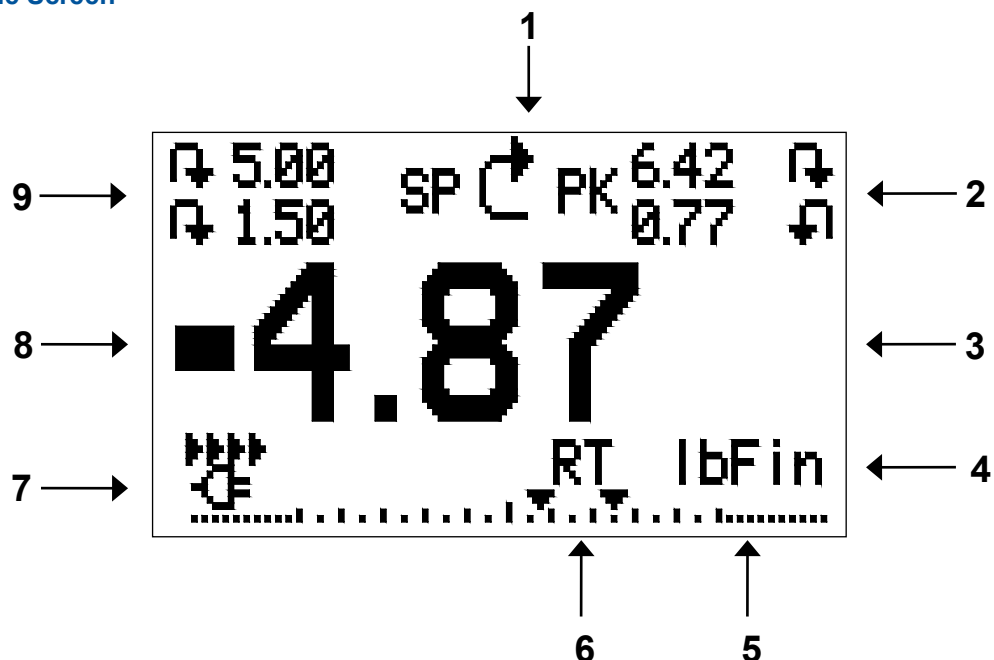

4.1 Home Screen



No.	Name	Description
1	Measurement direction indicator	<ul style="list-style-type: none"> ⬇ – indicates compression direction (for force sensors) ⬆ – indicates tension direction (for force sensors) ↻ – indicates clockwise direction (for torque sensors) ↺ – indicates counter-clockwise direction (for torque sensors) These indicators are used throughout the display and menu.
2	Peaks	The maximum measured compression/tension or clockwise/counter-clockwise readings. These readings are reset by pressing ZERO or by powering the indicator off and on.
3	Primary reading	The current displayed load reading. See Operating Modes section for details. If a sensor is not plugged in, this value will be replaced by a message, as follows: SENSOR NOT CONNECTED
4	Load bar	Analog indicator to help identify when an overload condition is imminent. The bar increases either to the right or to the left from the midpoint of the graph. Increasing to the right indicates compression or clockwise load, increasing to the left indicates tension or counter-clockwise load. If set points are enabled, triangular markers are displayed for visual convenience. This indicator reflects the actual load, which may not correspond to the primary reading (depends on operating mode). The ZERO key does not reset the load bar. See Operating Modes section for details.
5	Units	The current measurement unit. Abbreviations are as follows: Force units: <ul style="list-style-type: none"> lbF – Pound-force ozF – Ounce-force kgF – Kilogram-force gF – Gram-force N – Newton kN – Kilonewton

		<p>Torque units: lbFin – Pound-inch ozFin – Ounce-inch kgFm – Kilogram-meter kgFmm – Kilogram-millimeter Nm – Newton-meter Ncm – Newton-centimeter</p> <p>Note: not all sensor models display all the above units. Refer to the capacity / resolution table for the respective sensor series for details.</p>
6	Mode	<p>The current measurement mode. Abbreviations are as follows: RT – Real Time PC – Peak Compression (for force sensors) PT – Peak Tension (for force sensors) PCW – Peak Clockwise (for torque sensors) PCCW – Peak Counter-clockwise (for torque sensors)</p> <p>See Operating Modes section for details about each of these modes</p>
7	Battery / AC adapter indicator	Either the AC adapter icon or battery power icon will be shown, depending on power conditions. Refer to the Power section for details.
8	High / low limit indicators	<p>Correspond to the programmed set points. Indicator definitions are as follows: ▲ – the displayed value is greater than the upper load limit ■ – the displayed value is between the load limits ▼ – the displayed value is less than the lower load limit</p>
9	Set points	The programmed load limit values. Typically used for pass/fail type testing. One, two, or no indicators may be present, depending on the configuration shown in the Set Points menu item.

4.2 Controls

Primary Label	Primary Function	Secondary Label	Secondary Function
	Powers the indicator on and off. Press briefly to power on, press and hold to power off. Active only when the home screen is displayed.	ENTER	Various uses, as described in the following sections.
ZERO	Zeroes the primary reading and peaks.	 (UP)	Navigates up through the menu and sub-menus .
MENU	Enters the main menu.	ESCAPE	Reverts one step backwards through the menu hierarchy.
MODE	Toggles between measurement modes.	 (DOWN)	Navigates down through the menu and sub-menus.
DATA	Transmits the current reading to an external device via the USB port.	DIRECTION	Toggles between tension and compression (or clockwise and counter-clockwise) directions while configuring set points and other menu functions.

Note: Measurement units are configured through the menu. Refer to the **Changing The Units** section for details.

4.3 Menu navigation basics

Most of the indicator's various functions and parameters are configured through the main menu. To access the menu press **MENU**. Use the **UP** and **DOWN** keys to scroll through the items. The current selection is denoted with clear text over a dark background. Press **ENTER** to select a menu item, then use **UP** and **DOWN** again to scroll through the sub-menus. Press **ENTER** again to select the sub-menu item.

For parameters that may be either selected or deselected, press **ENTER** to toggle between selecting and deselecting. An asterisk (*) to the left of the parameter label is used to indicate when the parameter has been selected.

For parameters requiring the input of a numerical value, use the **UP** and **DOWN** keys to increment or decrement the value. Press and hold either key to auto-increment at a gradually increasing rate. When the desired value has been reached, press **ENTER** to save the change and revert back to the sub-menu item, or press **ESCAPE** to revert back to the sub-menu item without saving. Press **ESCAPE** to revert one step back in the menu hierarchy until back into normal operating mode.

Refer to the following sections for details about setting up particular functions and parameters.

Note: As described above, the Plug & Test® smart connector retains all configuration and calibration data for the sensor, which includes menu settings. As such, a sensor must be connected in order for menu changes to be saved with that particular sensor. If a sensor is not connected and the **MENU** key is pressed, it is possible to browse through the menu parameters and make changes, but changes will not be saved.

5 DIGITAL FILTERS

Digital filters are provided to help smooth out the readings in situations where there is mechanical interference in the work area or test sample. These filters utilize the moving average technique in which consecutive readings are pushed through a buffer and the displayed reading is the average of the buffer contents. By varying the length of the buffer, a variable smoothing effect can be achieved. The selection of 1 will disable the filter since the average of a single value is the value itself.

To access digital filter settings, select **Filters** from the menu. The display appears as follows:

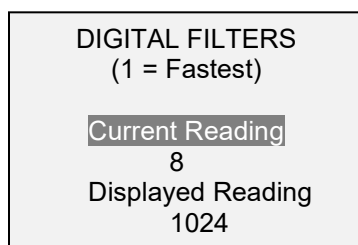

Two filters are available:

Current Reading – Applies to the peak capture rate of the instrument.

Displayed Reading – Applies to the primary reading on the display.

Available settings: 1, 2, 4, 8, 16, 32, 64, 128, 256, 512, 1024. It is recommended to keep the current reading filter at its lowest value for best performance, and the displayed reading filter at its highest value for best stability.

6 SET POINT INDICATORS

6.1 General Information

Set points are useful for tolerance checking (pass/fail). Two limits, high and low, are specified and stored in the non-volatile memory of the instrument and the primary reading is compared to these limits.

6.2 Configuration

To configure set points, select **Set Points** from the menu. The screen appears as follows:

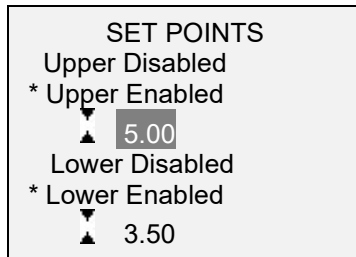

Either one, two, or none of the set points may be enabled. To toggle between the tension and compression (or clockwise and counter-clockwise) directions, press the **DIRECTION** key.

If two set points have been enabled, they are displayed in the upper left corner of the display. If only one set point has been enabled, the word "OFF" appears in place of the value. If no set points have been enabled, the upper left corner of the display will be blank.

When set points are enabled, the following indicators are shown to the left of the primary reading:

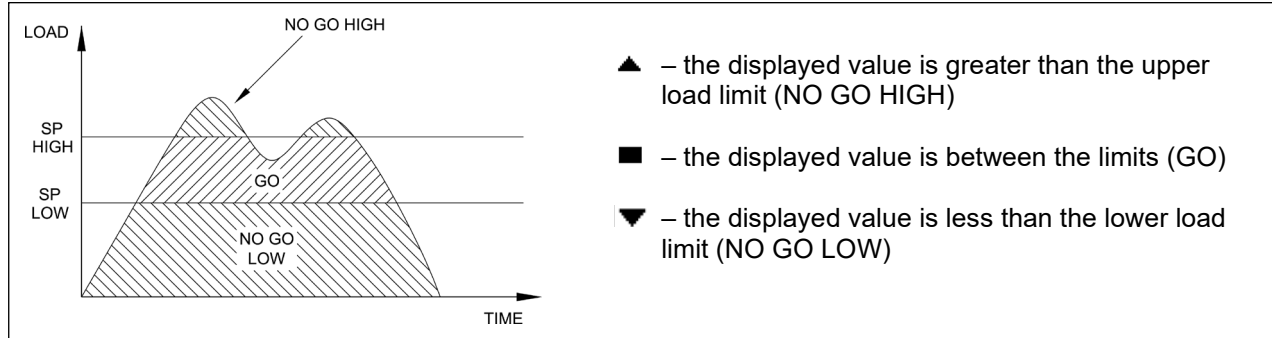

Note: Set point indicators reference the displayed reading, not necessarily the current live load.

7 OPERATING MODES

Caution!

In any operating mode, if the capacity of the instrument has been exceeded by more than 110%, the display will show "OVER" to indicate an overload. A continuous audible tone will be sounded (if beeps are enabled) until the MENU key has been pressed or the load has been reduced to a safe level.

Three operating modes are possible with the M3I indicator. To cycle between the modes, press **MODE** while in the home screen.

7.1 Real time (RT)

The primary reading corresponds to the live measured reading.

7.2 Peak Compression (PC) / Peak Clockwise (PCW) - for force / torque sensors, respectively

The primary reading corresponds to the peak compression or clockwise reading observed. If the actual load decreases from the peak value, the peak will still be retained in the primary reading area of the display. Pressing **ZERO** will reset the value.

7.3 Peak Tension (PT) / Peak Counter-clockwise (PCCW) – for force / torque sensors, respectively

Same as above, but for tension / counter-clockwise readings.

8 CHANGING THE UNITS

The M3I can display several measurement units, depending on the sensor. To change the unit, select **Units** from the menu. The display will list the available units, for example:

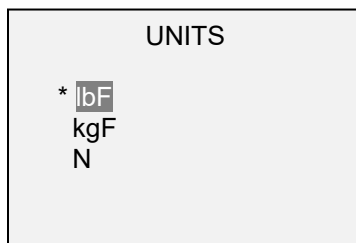

The indicator will always power on with the unit selected.

9 COMMUNICATIONS AND OUTPUTS

9.1 Communication Settings

To set up communication settings, select **USB Settings** from the menu. The screen appears as follows:

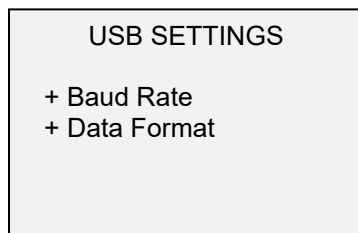

Communication settings are permanently set to the following:

Data Bits: 8
Stop Bits: 1
Parity: None

Other settings are configured as follows:

9.1.1 Baud Rate

Select the baud rate as required for the application. It must be set to the same value as the receiving device.

9.1.2 Data Format

Select the desired data format. The screen appears as follows:

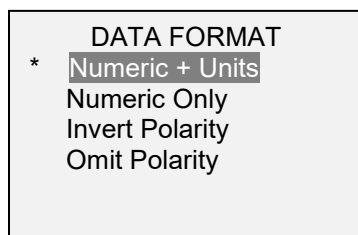

Selection	Description
Numeric + Units	Output format includes the value and unit of measure. Compression/clockwise values have positive polarity, tension/counter-clockwise values have negative polarity.
Numeric Only	Output format includes the value only. Polarity same as above.
Invert Polarity	Compression/clockwise values have negative polarity, tension/counter-clockwise values have positive polarity. May be selected in addition to the Numeric + Units / Numeric Only selection.
Omit Polarity	Both directions are formatted with positive polarity. May be selected in addition to the Numeric + Units / Numeric Only selection.

9.2 Data Output

Communication with the M3I is achieved through the micro USB port located along the left side of the housing, as shown in the illustration in the **Power** section. Communication is possible only when the indicator is in the main operating screen (i.e. not in a menu or configuration area).

The current reading is transmitted from the indicator when the **DATA** key is pressed. The M3I may also be controlled by an external device through the USB channel by sending ASCII command '?' (no quotes). The command must be terminated by a CR (Carriage Return) character, 0x0D, or a CR-LF (Carriage Return – Line Feed) pair, where the Line Feed, 0x0A, is ignored.

9.3 Command Responses

In response to the reading request command '?' the indicator will return a string with the load data, followed by a space, then the load unit (if enabled under the **USB Settings** → **Data format** sub-menu). It will be terminated by a CR-LF pair.

Example return strings:

```
-18.78 lbFin<CR><LF> 18.78 lbFin of counter-clockwise torque  
1.724 N<CR><LF>      1.724 N of compression force
```

The number of digits after the decimal point is dependent of the sensor's capacity and resolution.

Polarity may be inverted or omitted, as shown in the table above.

Any detected errors are reported back by means of error code *10 (illegal command).

The M3I can send individual data points or continuous data to *MESUR®gauge* and *MESUR® Lite* software.

10 CALIBRATION

Any Mark-10 Plug & Test[®] sensor or compatible third-party sensor (with Model PTA adapter) may be calibrated with an M3I indicator, except Series FS05 and R07. These sensor series must be calibrated with an M5I or M7I indicator.

10.1 Initial Physical Setup

The sensor should be mounted vertically to a test stand or fixture rugged enough to withstand a load equal to the full capacity of the sensor. Certified deadweights, torque arms/wheels, and/or master load cells should be used, along with appropriate mounting brackets and fixtures. Caution should be taken while handling such equipment.

10.2 Calibration Procedure

The following instructions use force terminology only. Such wording is displayed only when a force sensor is being calibrated. When a torque sensor is being calibrated, the terms **COMPRESSION** and **TENSION** are replaced by **CLOCKWISE** and **COUNTER-CLOCKWISE**, respectively.

1. Select **Calibration** from the menu. The display appears as follows:

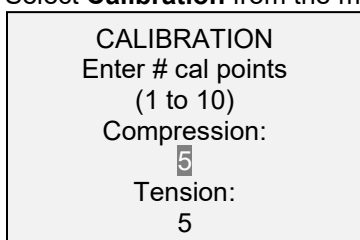

The sensor can be calibrated at up to 10 points in each direction. Enter the number of calibration points for each direction (compression and tension or clockwise and counter-clockwise). At least one point must be selected for each direction. For single-direction sensors such as Mark-10's Series R02, only one direction is allowed.

Note: To achieve the accuracy specification of $\pm 0.2\%$ + sensor, it is recommended to calibrate the sensor at 5 or more even increments in both the tension and compression directions. For example, a sensor with capacity of 10 lbF should be calibrated at 2, 4, 6, 8, and 10 lbF loads in each direction.

2. To escape the **Calibration** menu at any time, press **ESCAPE**. The display appears as follows:

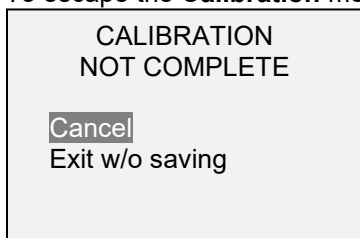

Selecting "Cancel" will revert back to the Calibration setup. Selecting "Exit w/o saving" will return to the menu without saving changes.

3. After the number of calibration points has been entered, press **ENTER**. The display appears as follows:

CALIBRATION
OFFSET

Place sensor
horizontally, then
press ZERO.

- Place the force sensor horizontally on a level surface free from vibration, then press **ZERO**. The indicator will calculate internal offsets, and the display appears as follows:

CALIBRATION
OFFSET

Please wait...

CALIBRATION
OFFSET

Sensor passed
Analog passed

If failed:

CALIBRATION
OFFSET

Sensor failed
Analog failed

- The following screen appears after the offsets have been calculated:

CALIBRATION
COMPRESSION

Attach necessary
weight fixtures,
then press ENTER.

Attach weight fixtures (brackets, hooks, etc), as required. Do not yet attach any weights or apply any calibration loads. Press **ENTER**.

- The display appears as follows:

CALIBRATION
COMPRESSION

Optionally exercise
sensor, then press
ENTER.

Optionally exercise the sensor several times (at full scale, if possible), then press **ENTER**.

- The display appears as follows:

CALIBRATION
COMPRESSION
Gain adjust
Apply full scale load
10.000 lbF +/-20%,
then press ENTER.

Apply a weight equal to the full scale of the instrument, then press **ENTER**.

8. After displaying "Please wait..." the display appears as follows:

CALIBRATION
COMPRESSION

Ensure no load,
then press ZERO.

Remove the load applied in Step 8, leave the fixtures in place, then press **ZERO**.

9. The display appears as follows:

CALIBRATION
COMPRESSION
Apply load
1 OF 5
Enter load:
2.000 lbF
Press ENTER.

Use the **UP** and **DOWN** keys to adjust the load value as required. The load values default to even increments, as indicated by the previously entered number of data points (even increments are recommended for best results). For example, if a 50 lbF capacity sensor is calibrated, and 5 data points were selected, the load values will default to 10, 20, 30, 40, and 50 lb. Apply the calibration load. Then press **ENTER**.

Repeat the above step for the number of data points selected.

10. After all the compression calibration points have been completed, the display appears as follows:

CALIBRATION
COMPRESSION COMPLETE
Reverse direction
for tension.
Attach necessary
weight fixtures,
then press ENTER.

Press **ENTER**.

11. At the completion of the tension calibration, the display appears as follows:

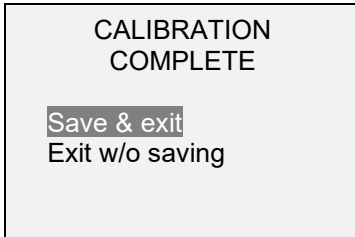

To save the calibration information, select "Save & exit". To exit without saving the data select "Exit without saving".

12. Any errors are reported by the following screens:

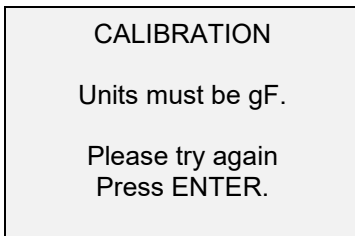

Displayed at the start of calibration if a disallowed unit is selected.



Ensure that the load is not swinging, oscillating, or vibrating in any manner. Then try again.



Causes:

1. The calibration weight does not match the set value.
2. If using a PTA configurable adapter, ensure that the output signal leads (SG+ and SG-) have been installed into the appropriate terminal blocks. Some sensor manufacturers consider SG+ to be a compression value, while others consider it to be a tension value. If the indicator is expecting a compression load but it is receiving a tension signal, calibration cannot continue. Verify that the tension/compression indicator on the home screen properly corresponds to the load direction, and switch the signal leads, if required.

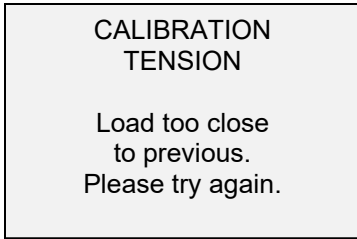

The entered calibration point is too close to the previous point.

11 OTHER SETTINGS

11.1 Automatic Shutoff

The indicator may be configured to automatically power off following a period of inactivity while on battery power. Inactivity is defined as the absence of any key presses or load changes of 100 counts or less. To access these settings, select **Automatic Shutoff** from the menu. The display appears as follows:

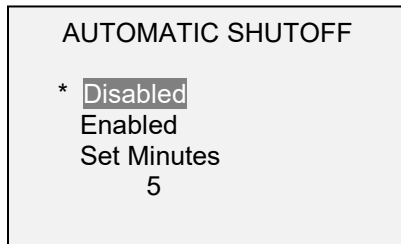

Select **Disabled** to disable automatic shutoff. Select **Enabled** to enable it. The length of time of inactivity is programmed in minutes via the **Set Minutes** parameter. Available settings: 5-30, in 5 minute increments.

Note: If the AC adapter is plugged in, the indicator will ignore these settings and remain powered on until the **POWER** key is pressed.

11.2 Backlight

There are several available initial settings (applicable upon powering on the indicator). To access these settings, select **Backlight** from the menu. The display appears as follows:



Selection	Description
Off	Backlight to be off upon powering on the indicator.
On	Backlight to be on upon powering on the indicator.
Auto	Backlight to be on upon powering indicator, but will shut off after a period of inactivity (as defined in the Automatic Shutoff sub-section). The backlight will turn on again when activity resumes. The length of time of inactivity is programmed in minutes via the Set Minutes parameter. Available settings: 1-10, in 1 minute increments.

Note: If the AC adapter is plugged in, the indicator will ignore these settings and keep the backlight on. Selecting the **On** or **Off** setting in the **Backlight** menu will manually turn the backlight on or off.

11.3 LCD Contrast

The contrast of the display may be adjusted. Select **LCD Contrast** from the menu. The screen appears as follows:



Press **ENTER** to modify the contrast. Select a value from 0 to 25, 25 producing the most contrast.

11.4 Tones

Audible tones can be enabled for all key presses and alerts, such as overload, set point value reached, etc. The Set Point alert can be configured to be either a momentary tone or a continuous tone (until the load is restored to a value between the set points). To configure the functions for which audible tones will apply, select **Tones** from the menu. The screen appears as follows:

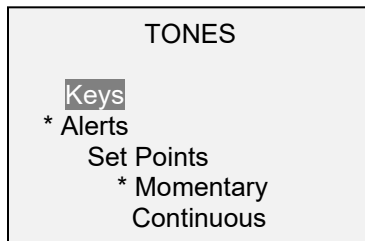

11.5 Initial Mode

This section is used to configure the initial mode upon powering on the indicator. To access this parameter, select **Initial Mode** from the menu. The screen will display the available modes, which is determined by whether a force or torque sensor is connected. An example is as follows:

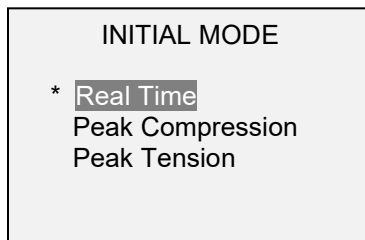

The default value is Real Time.

11.6 Restore Default Settings

Default factory settings can be restored by selecting **Restore Defaults** from the menu. The settings may be found in the **Specifications** section. The screen appears as follows:

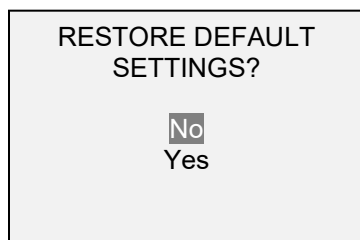

11.7 Information / Welcome Screen

The following screen is displayed at power up and can be accessed at any time by selecting **Information** from the menu:

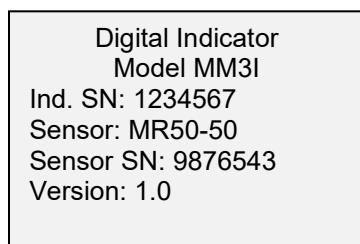

12 SPECIFICATIONS

12.1 General

Accuracy:	±0.2% of full scale + sensor
Sampling rate:	2,000 Hz
Power:	AC or rechargeable battery. Low battery indicator appears when battery level is low, and indicator powers off automatically when power reaches critical stage.
Battery life:	Backlight on: up to 7 hours of continuous use Backlight off: up to 24 hours of continuous use
Measurement units:	lbF, gF, kgF, N, kN, lbFin, ozFin, kgFm, kgFmm, Nm, Ncm, (depending on sensor)
USB output:	Configurable up to 115,200 baud
Safe overload:	150% of full scale (display shows "OVER" at 110% and above)
Weight:	0.7 lb [0.3 kg]
Included accessories:	Carrying case, AC adapter, battery, USB cable, and certificate of calibration
Environmental requirements:	40 - 100°F, max. 96% humidity, non-condensating
Warranty:	3 years (see individual statement for further details)
Literature & Software:	Download at: www.mark-10.com/resources

12.2 Factory Settings

Parameter	Setting
Set points	
Upper	Disabled (defaults to 80% of full scale, C/CW, when enabled)
Lower	Disabled (defaults to 40% of full scale, C/CW, when enabled)
Filters	
Current	8
Displayed	1024
Backlight	Auto
Minutes	1
USB Output	
Baud Rate	9,600
Data Format	Numeric + units
Automatic Shutoff	Enabled
Minutes	5
Tones	
Keys	Enabled
Alerts	Enabled
Set Points	Momentary
Initial Mode	Real Time
Units	Depends on sensor

12.3 Dimensions

IN [MM]

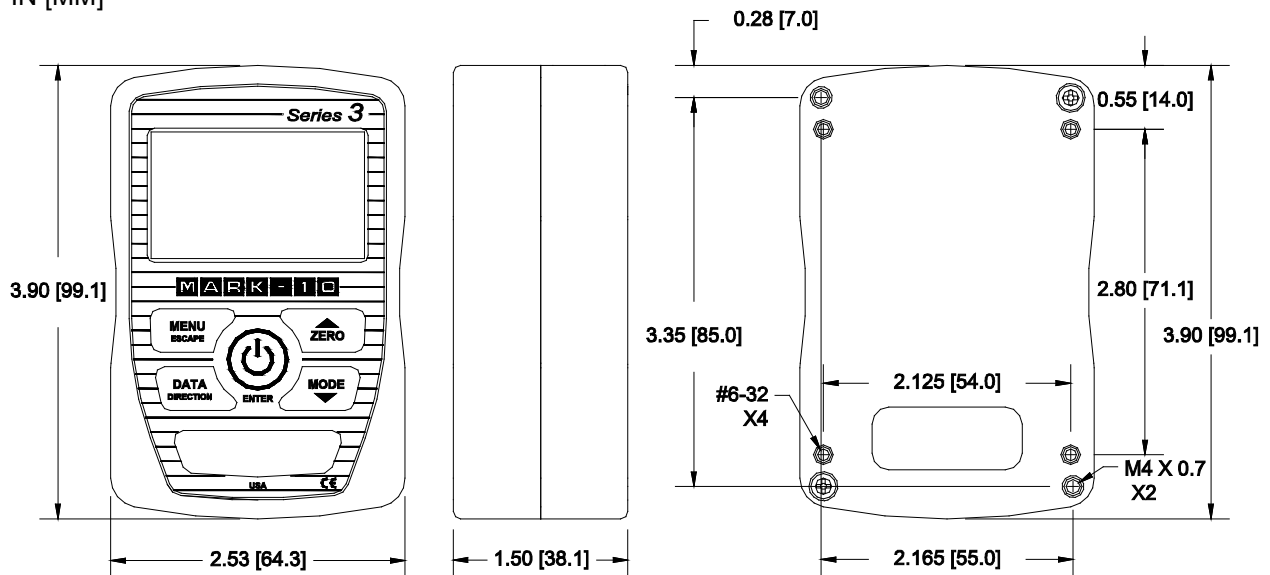



Mark-10 Corporation has been an innovator in the force and torque measurement fields since 1979. We strive to achieve 100% customer satisfaction through excellence in product design, manufacturing and customer support. In addition to our standard line of products we can provide modifications and custom designs for OEM applications. Our engineering team is eager to satisfy any special requirements. Please contact us for further information or suggestions for improvement.



Force and torque measurement engineered better

Mark-10 Corporation

11 Dixon Avenue
Copiague, NY 11726 USA
1-888-MARK-TEN
Tel: 631-842-9200
Fax: 631-842-9201
Internet: www.mark-10.com
E-mail: info@mark-10.com