

# Measurements on RF and AF Filters with Rohde & Schwarz Value Instruments

## Application Note

### Products:

- R&S®FSC
- HAMEG HMS-X
- R&S®ZND
- R&S®ZVL
- R&S®HMC804x
- HAMEG HMF25xx
- R&S®SMC100A
- R&S®RTM20xx
- HAMEG HMOxxxx
- HAMEG HM8118
- HAMEG HM8012

This application note describes the basic frequency filter measurements that are often required during service repairs, during development of simple circuits and for training purposes. These measurements do not always require high-end T&M equipment. Instruments in this class typically offer a very wide range of measurement functions coupled with the best-possible RF performance. However, these features are not necessary for simple applications. This application note therefore describes measurements using instruments from the cost-effective Rohde & Schwarz Value Instruments series. The instruments in this series offer the measurement accuracy demanded by quality-conscious users plus easy operation and all of the functionality needed for everyday measurement tasks.

### Note:

Please find the most up-to-date document on our homepage

<http://www.rohde-schwarz.com/appnote/1MA243>

# Table of Contents

<b>1</b>	<b>Filter Types and Applications</b>	<b>5</b>
1.1	Lowpass Filters	6
1.2	Highpass Filters	8
1.3	Bandpass Filters	10
1.4	Bandstop Filters	12
<b>2</b>	<b>Practical Implementation of Filter Measurements</b>	<b>14</b>
2.1	Component Measurements Using an LCR Bridge	14
2.1.1	Test Setup	14
2.1.2	Example: Capacitor, Coil and Resistor Measurements Using the HM8118 LCR Bridge	14
2.2	Resistance and Capacitance Measurements Using an HMC8012 Digital Multimeter	19
2.2.1	Test Setup	19
2.2.2	Example: Resistance and Capacitance Measurements	20
2.3	Filter Measurements Using a Spectrum Analyzer	22
2.3.1	Test Setup	23
2.3.2	Example: Lowpass Filter Measurements Using the FSC Spectrum Analyzer	24
2.4	Filter Measurements Using a Vector Network Analyzer	25
2.4.1	Test Setup	26
2.4.2	Example: Bandpass Filter Measurements Using the ZND Vector Network Analyzer	26
2.5	Filter Measurements Using an Oscilloscope	36
2.5.1	Test Setup	36
2.5.2	Example: RC Lowpass Filter Measurements Using the HMO3004 Oscilloscope and the HMF2550 Arbitrary Generator	36
<b>3</b>	<b>Brief Presentation of the Measuring Instruments Used</b>	<b>43</b>
3.1	FSC Spectrum Analyzer	43
3.2	ZND Vector Network Analyzer	44
3.3	HMO3000 Digital Oscilloscope Series	45
3.4	HMF25xx Arbitrary Function Generator	46
3.5	HM8118 200 kHz LCR Bridge	46
3.6	HMC804x Power Supply	47
3.7	HMC8012 Digital Multimeter	48
<b>4</b>	<b>Literature</b>	<b>49</b>

**5 Ordering Information ..... 50**  
**A Bandfilter Measurements on the ZND without the S-Parameter Wizard .....53**

The following abbreviations are used in this Application Note for Rohde & Schwarz and HAMEG test equipment:

- The R&S® FSC spectrum analyzer is referred to as the FSC.
- The R&S® ZND vector signal analyzer is referred to as the ZND.
- The HAMEG HMO3000 oscilloscope is referred to as the HMO3000.
- The HAMEG HM8118 LCR bridge is referred to as the HM8118.
- The HAMEG HMF2550 50 MHz arbitrary generator is referred to as the HMF2550.
- The HAMEG HMC8012 digital multimeter is referred to as the HMC8012.
- The R&S® HMC804x power supply is referred to as the HMC804x.

# 1 Filter Types and Applications

Frequency filters are electronic circuits that change the amplitude and phase angle of an electrical signal based on the frequency. These filters have preconfigured, frequency-dependent transmission characteristics. This means that certain input signal frequency ranges are completely suppressed or that different frequency ranges are either preferred or even amplified during transmission.

Filters are either passive or active. Passive filters contain only passive components such as capacitors, coils and resistors. In contrast, active filters contain active components; typically an operational amplifier (see Fig. 1-1). Active filters without inductors and with operational amplifiers are preferred for the lower frequencies because they prevent difficulties such as space requirements, calibration, aging and the high price tag associated with large inductors.

Filters are also categorized by their order. The order corresponds to the number of frequency-dependent components used in the circuit (see Fig. 1-2). High-order filters offer a better selectivity between the wanted signal frequencies and those that should be suppressed, for example.

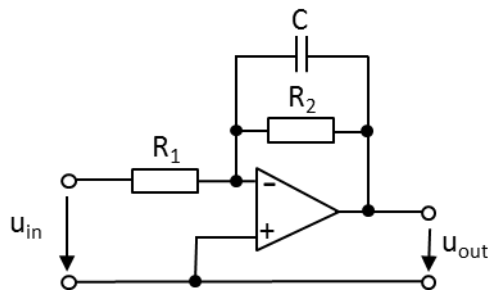

Fig. 1-1: Active RC lowpass, 1st order.

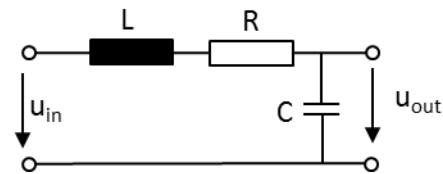

Fig. 1-2 Passive RC lowpass, 2nd order.

Digital filters should also be mentioned here for the sake of completeness. Unlike analog filters that are made up of discrete components, digital filters are implemented with logic components such as ASICs, FPGAs or with a signal processor in the form of a sequential program. A digital filter can thus be seen as a mathematical filter used for manipulating a signal.

Without frequency filters, many applications in audio, communications and RF engineering would not be possible. A few important examples of how frequency filters are used:

- Broadcast receivers: Filtering of the intermediate frequency using bandpass filters in order to suppress interference. Channel tuning with an adjustable bandpass for a direct detection receiver.
- Image frequency rejection in transceivers, radio and TV receivers, measuring receivers, spectrum analyzers, etc.
- Multi-way loudspeakers: Different audio signal frequencies are distributed to the appropriate loudspeakers for high, bass and mid-range tones using a frequency filter.

- Limiting the signal bandwidth using a lowpass filter before the analog/digital conversion to ensure that the sampling rate bandwidth is sufficient for the sampling theorem being used.

## 1.1 Lowpass Filters

A lowpass filter permits all lower frequency components of a signal up to a defined cutoff frequency  $f_g$  to pass through with little to no attenuation. Frequencies above the cutoff frequency are attenuated. The degree to which the high frequency components are suppressed and the selectivity between low and high frequencies both depend on the transmission function being performed and thus on the design of the filter. Fig. 1-3 shows the simplest form of a lowpass filter circuit, consisting of a resistor and a capacitor.

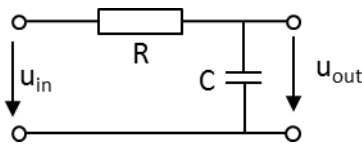

Fig. 1-3: Passive RC lowpass, 1st order.

By using the voltage divider rule with the transition to complex quantities, the following amplitude response results for a lowpass filter of the 1st order with  $\omega = 2\pi f$ :

$$\text{Equation 1: } G(\omega) = \frac{u_{out}}{u_{in}} = \frac{1}{\sqrt{1+(\omega RC)^2}}$$

The phase response is calculated as:

$$\text{Equation 2: } \varphi(\omega) = -\arctan(\omega RC)$$

A resistor in the voltage divider, in this case the capacitor, is frequency dependent. At a low frequency ( $f \rightarrow 0$ ) the capacitor represents an infinitely high resistance. In this case, it receives the entire input voltage ( $U_{in} = U_{out}$ ), which corresponds to an amplification of 1 or of 0 dB on the logarithmic scale. At a high frequency ( $f \rightarrow \infty$ ) the capacitor represents a short circuit, so that the entire input voltage is applied at resistor R ( $U_{out} \rightarrow 0$  or the logarithmic amplification  $\rightarrow -\infty$ ). This corresponds to infinitely high stopband attenuation. The frequency response of the lowpass is shown in Fig. 1-3. At the cutoff frequency  $f_c$ , the output voltage sinks to the value  $u_{out} = \frac{u_{in}}{\sqrt{2}}$ . On the logarithmic scale, this corresponds to an attenuation of 3 dB. In terms of electrical power, the output power is only half of the input power. The cutoff frequency  $f_c$  can be calculated using the following equation:

$$\text{Equation 3: } f_c = \frac{1}{2\pi RC}$$

If the equation for the cutoff frequency is incorporated into the phase response (Equation 2), the result is  $\varphi(f_c) = -\arctan(1) = -45^\circ$  (see Fig. 1-5).

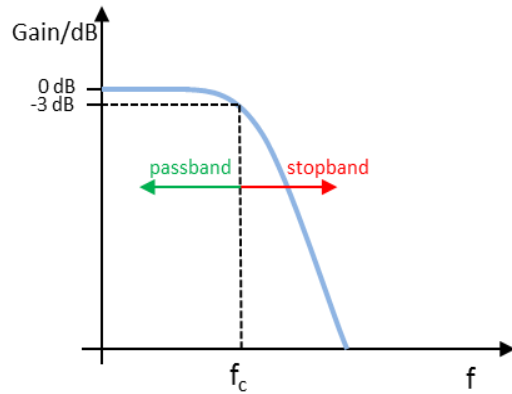

Fig. 1-4: Frequency response RC lowpass, displayed logarithmically.

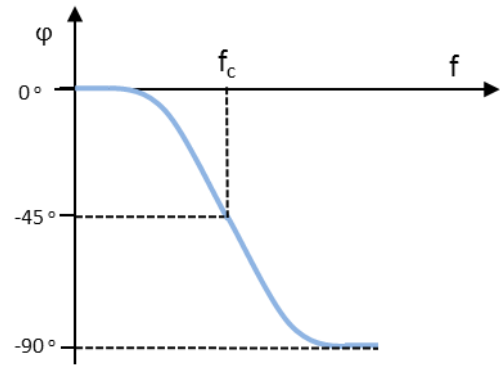

Fig. 1-5: Phase response RC lowpass.

A lowpass can also consist of a coil and a resistor. The output voltage is tapped at the resistor (Fig. 1-6).

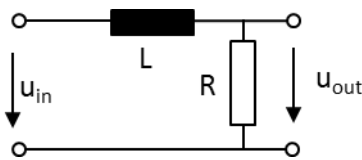

Fig. 1-6: Passive LR lowpass 1st order.

The following applies for an LR lowpass:

Amplitude response:  $G(\omega) = \frac{u_{out}}{u_{in}} = \frac{1}{\sqrt{1 + \left(\frac{\omega L}{R}\right)^2}}$

Phase response:  $\varphi(\omega) = -\arctan\left(\frac{\omega L}{R}\right)$

Cutoff frequency:  $f_c = \frac{R}{2\pi L}$

LC filters are used to achieve a very steep edge (40 dB per decade). In an LC lowpass, the output voltage is tapped at the capacitor (Fig. 1-7). Because both the coil and the capacitor are frequency-dependent components, an LC filter is always a filter of the 2nd order.

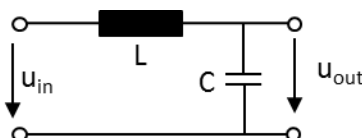

Fig. 1-7: Passive LC lowpass 2nd order.

The following applies for an LC lowpass:

$$\text{Amplitude response: } G(\omega) = \frac{u_{out}}{u_{in}} = \frac{1}{1-\omega^2 LC}$$

$$\text{Cutoff frequency: } f_c = \frac{1}{2\pi\sqrt{LC}}$$

## 1.2 Highpass Filters

A highpass filter permits all high frequency components of a signal up to a defined cutoff frequency to pass through with little to no attenuation. Frequencies below the cutoff frequency are attenuated. The degree to which the low frequency components are suppressed and the selectivity between high and low frequencies both depend on the transmission function being performed and thus on the design of the filter. Fig. 1-8 shows the simplest form of a highpass filter circuit, consisting of a resistor and a capacitor. Compared to a lowpass filter, the output voltage is tapped at resistor R in a highpass filter, i.e. R and C are swapped.

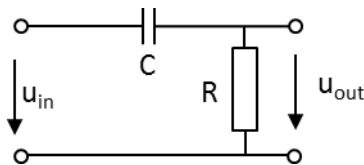

Fig. 1-8: Passive RC highpass, 1st order.

By using the voltage divider rule with the transition to complex quantities, the following amplitude response is the result for a highpass filter of the 1st order with  $\omega = 2\pi f$ :

$$\text{Equation 4: } G(\omega) = \frac{u_{out}}{u_{in}} = \frac{\omega CR}{\sqrt{1+(\omega RC)^2}}$$

The phase response is calculated as:

$$\text{Equation 5: } \varphi(\omega) = \arctan\left(\frac{1}{\omega RC}\right)$$

Like with the lowpass filter, a resistor in the voltage divider – in this case the capacitor – is frequency dependent. At a low frequency ( $f \rightarrow 0$ ) the capacitor represents an infinitely high resistance. This means that no voltage is received at resistor R ( $U_{out} = 0$ ), corresponding to an amplification of 0, or an infinitely high attenuation. In the case of a rising frequency ( $f \rightarrow \infty$ ), the capacitor represents a short circuit, so that the entire input voltage is received at resistor R ( $U_{out} = U_{in}$ ). This corresponds to an amplification of 1 or 0 dB on the logarithmic scale. The frequency response of the highpass is shown in Fig. 1-9. The cutoff frequency  $f_c$  is calculated the same as for a lowpass filter as:  $f_c = \frac{1}{2\pi RC}$ .

If the equation for the cutoff frequency is incorporated into the phase response (Equation 5), the result is  $\varphi(f_c) = \arctan(1) = 45^\circ$  (see Fig. 1-10).



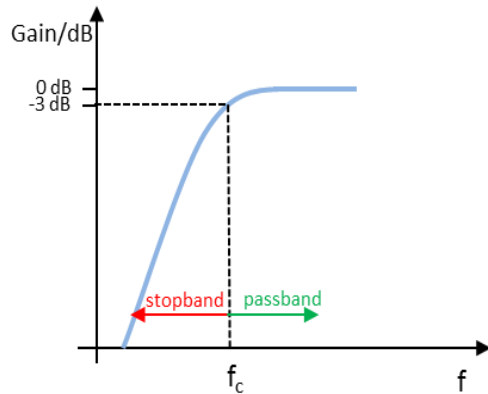

Fig. 1-9: Frequency response RC highpass, displayed logarithmically.

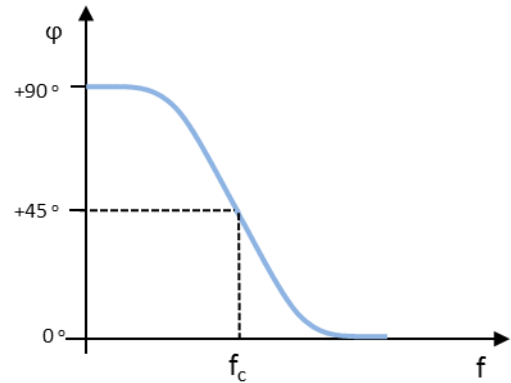

Fig. 1-10: Phase response RC highpass.

Like for the lowpass filter, a lowpass filter can also consist of a coil and a resistor. In contrast to the lowpass filter, though, the output voltage is tapped at the coil instead of the resistor (Fig. 1-11).

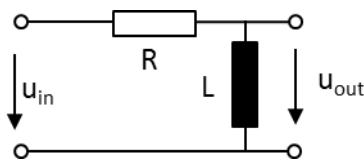

Fig. 1-11: Passive RL highpass 1st order.

The following applies for an RL highpass:

$$\text{Amplitude response: } G(\omega) = \frac{u_{out}}{u_{in}} = \frac{1}{\sqrt{1 + \left(\frac{R}{\omega L}\right)^2}}$$

$$\text{Phase response: } \varphi(\omega) = -\arctan\left(\frac{R}{\omega L}\right)$$

$$\text{Cutoff frequency: } f_c = \frac{R}{2\pi L}$$

LC filters are used to achieve a very steep edge (40 dB per decade). On an LC highpass filter, the output voltage is tapped at the coil (Fig. 1-12). Because both the coil and the capacitor are frequency-dependent components, an LC filter is always a filter of the 2nd order.

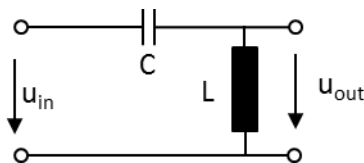

Fig. 1-12: Passive LC highpass 2nd order.

The following applies for an LC highpass:

$$\text{Amplitude response: } G(\omega) = \frac{u_{out}}{u_{in}} = \frac{1}{1 - \frac{1}{\omega^2 LC}}$$

$$\text{Cutoff frequency: } f_c = \frac{1}{2\pi\sqrt{LC}}$$

### 1.3 Bandpass Filters

A bandpass filter permits only the signals within a specific frequency band to pass. Signal frequencies below and above the passband are blocked or attenuated. The easiest method of implementing a bandpass filter is to connect highpass and lowpass filters in series (see Fig. 1-13). These filters are always 2nd order. Bandpass filters with symmetrical transfer function near the center frequency  $f_0$  always have an even filter order. The lower cutoff frequency  $f_L$  of the bandpass is defined by the highpass and the upper cutoff frequency  $f_H$  by the lowpass filter. Fig. 1-14 shows the bandpass transfer function with a passband that is characterized by the 3 dB bandwidth  $B$  around the center frequency  $f_0$ . The center frequency is also known as the resonance frequency and is defined as the geometric mean of  $f_L$  and  $f_H$ :  $f_0 = \sqrt{f_H \cdot f_L}$

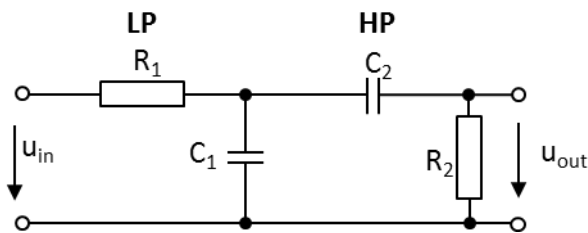

Fig. 1-13: Bandpass 2nd order consisting of RC lowpass and RC highpass.

The output voltage  $u_{out}$  is tapped at the highpass filter on the output side, which has high impedance for the low frequency range. As the input frequency increases, the output amplitude can increase only slowly. After the cutoff frequency of the lowpass filter has been reached, its stopband begins, which represents the passband for the highpass filter. As the frequency increases, the impedance of the lowpass decreases along with the output amplitude.

The advantage of connecting a 2nd order highpass and lowpass is seen in the simplified calculation of the transfer function and the low demands placed on the circuit subassemblies. The disadvantage is that narrowband bandpass filters are not possible because the insertion loss increases as the filter band narrows. Bandpass filters consisting of series-connected highpass and lowpass filters that exhibit acceptable attenuation in the passband are only feasible starting with the 4th order and multiples thereof.

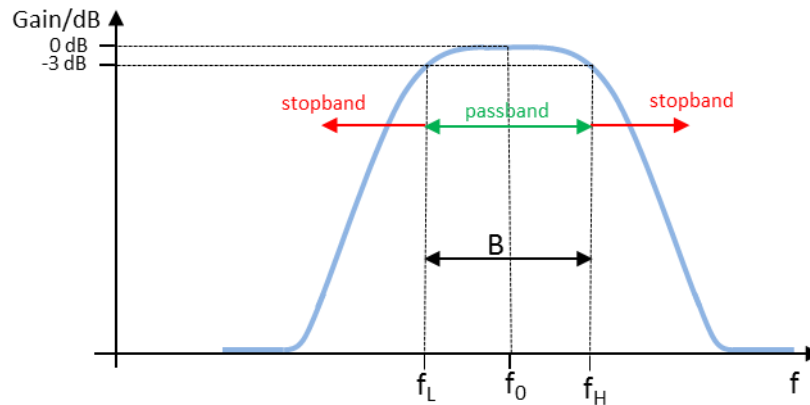

Fig. 1-14: Frequency response RC bandpass 2nd order, displayed logarithmically.

In practice, the component values are selected so that the resistor values and the capacitor values are always the same. The following applies:  $R_1 = R_2 = R$  and  $C_1 = C_2 = C$ . In this case, the following applies for the transfer function:

Equation 6: 
$$G(\omega) = \frac{u_{out}}{u_{in}} = \frac{1}{\sqrt{9 + \left(\frac{1 - (\omega RC)^2}{3\omega RC}\right)^2}}$$
 amplitude response

Equation 7:  $\varphi(\omega) = \arctan\left(\frac{1 - (\omega RC)^2}{3\omega RC}\right)$  phase response; Fig. 1-15 shows the phase characteristic graphically

For the center frequency, the following applies:

Equation 8: 
$$f_0 = \frac{1}{2\pi RC}$$

Assuming that signals are attenuated at the cutoff frequencies by 3 dB or that the output voltage  $u_{out}$  is decreased to  $u_{in} = \frac{1}{\sqrt{2}}$ , the following formulas apply for the cutoff frequencies:

Equation 9: 
$$f_L = \frac{0.302}{2\pi RC}$$

Equation 10: 
$$f_H = \frac{3.302}{2\pi RC}$$

If the two cutoff frequencies  $f_L$  and  $f_H$  are included into Equation 7 for the bandpass phase response, the following phase values apply as seen in Fig. 1-15:

$$\varphi(f_L) = \arctan(1) = 45^\circ$$

$$\varphi(f_H) = \arctan(-1) = -45^\circ$$

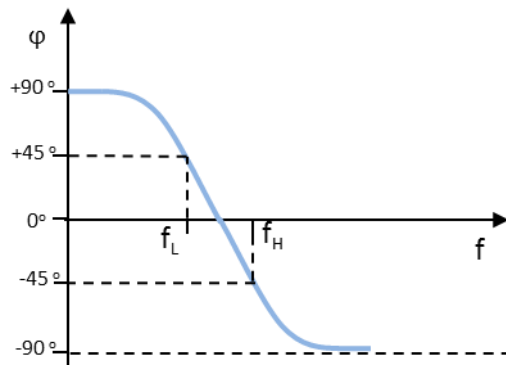

Fig. 1-15: Phase response bandpass 2nd order.

A bandpass filter can also be defined by its quality  $Q$ :

Equation 11: 
$$Q = \frac{f_0}{B}$$

From this, it can be concluded that a bandpass with a high quality has a narrower band than a bandpass with a low quality.

## 1.4 Bandstop Filters

The purpose of the bandstop filter is to suppress a specific signal frequency range and to permit all other frequencies to pass with low attenuation as possible. The frequency response of the bandstop filter is shown in Fig. 1-16. A bandstop filter is the opposite of a bandpass filter.

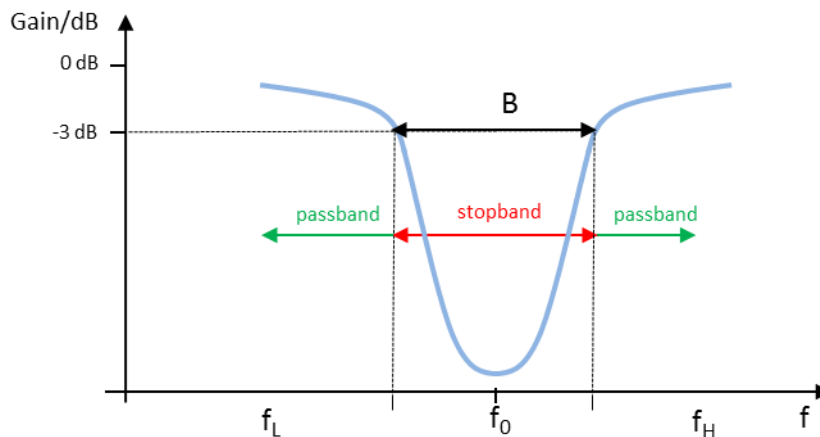

Fig. 1-16: Frequency response bandstop filter, displayed logarithmically.

Fig. 1-17 provides an example of an RC bandstop filter. This configuration (as a T filter) makes it possible to implement bandstop filters with a high attenuation in the stopband.

Like for the bandpass, the center frequency for the bandstop filter is calculated as:

$$f_0 = \frac{1}{2\pi RC}$$

The lower and upper 3 dB cutoff frequency can be calculated as follows:

$$f_L = \frac{0.25}{2\pi RC}$$

$$f_H = \frac{2}{\pi RC}$$

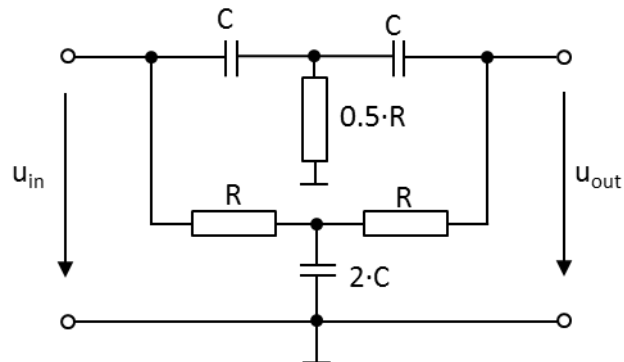

Fig. 1-17: Example of an RC bandstop filter.

## 2 Practical Implementation of Filter Measurements

### 2.1 Component Measurements Using an LCR Bridge

When the task is to build filters or frequency filters for audio signals from discrete components, then the quality of the components used will primarily determine whether the defined characteristics such as center frequency, cutoff frequency, etc. are achieved. The further the actual values from the coils, resistors and capacitors used deviate from the calculated values, the more the filter characteristics will deviate from the expected characteristics. However, even before a filter is constructed, the high-precision HM8118 LCR bridge helps with the selection of the most suitable components.

#### 2.1.1 Test Setup

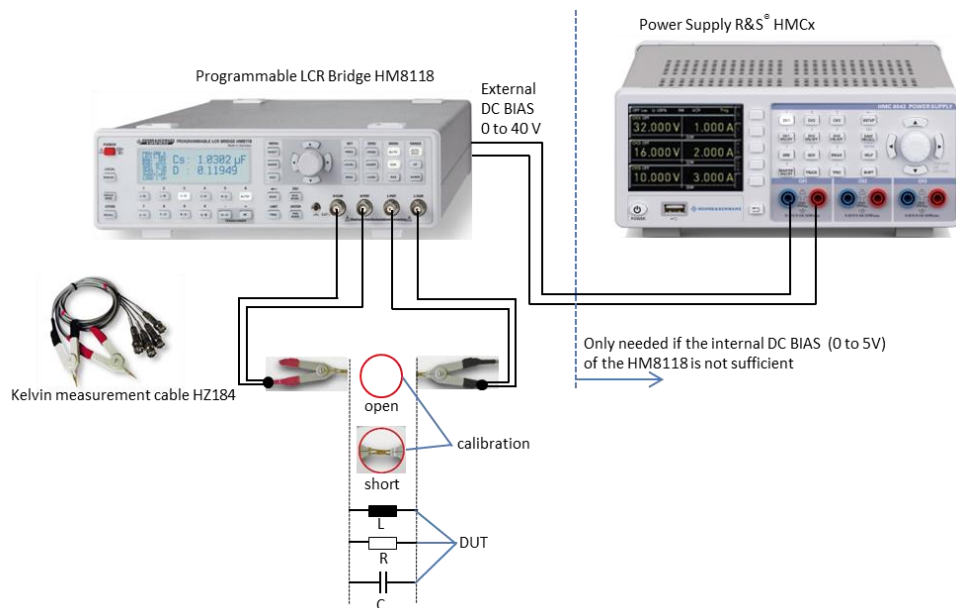

Fig. 2-1: Component measurement using the HM8118 LCR bridge.

#### 2.1.2 Example: Capacitor, Coil and Resistor Measurements Using the HM8118 LCR Bridge

- Press the *RECALL* key and the 9 (*R-X*) key to load the instrument default settings.
- Before starting the measurement, check whether the AC supply frequency is set correctly, as an invalid setting can result in an unstable reading display:
  - Press the *SELECT* key.
  - Press the *C-R* key and select the SYST menu.

- Use the rotary knob or the arrow keys to select *MAINS FREQ*.
  - Press the rotary knob to enable *MAINS FREQ* and set the correct value of 50 Hz or 60 Hz for the AC supply frequency.
- Connect test cable HZ184:
- Connect the lead with the red terminal to **H CUR** and **H POT**.
  - Connect the lead with the black terminal to **L CUR** and **L POT**.
- The LCR bridge must be calibrated in order to eliminate any influences on the measurement as a result of fringing capacitance, residual inductance and residual resistance from the test cable. ☞ Test tip: During the calibration, the cable should be connected in the same configuration as will be used later during the component measurements.
- Press the *SELECT* key and then use the *C-D* key to select the *CORR* menu.
  - Use the rotary knob to select *MODE*.
  - Press the rotary knob to enable *MODE* and then use the rotary knob to set *ALL*.
  - Press the *ESC* key.
  - With the test terminals disconnected, use the *OPEN* key to start the open circuit calibration.
  - Connect the test terminals and then use the *Short* key to start the short-circuit calibration. The LCR bridge is now calibrated for all 69 available frequency sample points in the range from 20 Hz to 200 kHz.
- Note: The calibration must be performed each time the LCR bridge is switched on.*
- Measuring a capacitor
- Connect the capacitor between the red (+) and black (–) terminals of HZ184 (Fig. 2-1). **Important: You must check the polarity on unipolar capacitors!**
  - Note: Electrolytic and tantalum capacitors require a bias voltage for a correct measurement. This should be high enough that no polarity reversal occurs when an AC voltage is applied, or else it should ideally be equivalent to the DC value in the actual circuit. Press the *BIAS* key and then use the rotary knob to set the required bias voltage (pressing the *BIAS* key a second time will switch the bias voltage off again). The set DC voltage is then superimposed on the measured AC voltage. The internal bias voltage can be a maximum of 5 V and is set in 10 mV increments. If this supply voltage is not sufficient, an external power source is used to supply a DC bias voltage of up to 40 V (Fig. 2-1). The constant voltage (CST V) must be switched on for this purpose. Press the *SELECT* key and use the rotary knob to select *SETUP* in the menu. Press the rotary knob to enable *CST V* and then use the rotary knob to set *ON*. Press the *ESC* key.
  - The correct measurement function or circuit type is set automatically in Auto mode, which is enabled by default (see Fig. 2-8 and Section 2.1.2.1). In this case, C-D is displayed, i.e. capacitance C and dissipation factor D (Fig. 2-2).

Other parameters such as impedance and phase angle are displayed by pressing a key and selecting the appropriate measurement functions as described in the manual. In the case of an ideal capacitor, the phase angle is  $-90^\circ$ . Fig. 2-3 shows the measurement of an actual lossy capacitor with a phase angle of  $-87.4^\circ$ .

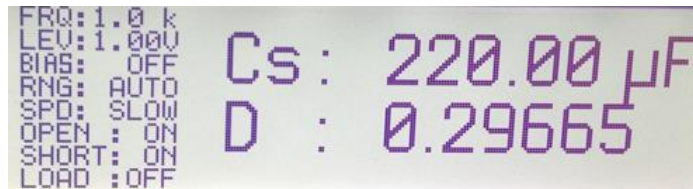

Fig. 2-2: Display of capacitance and dissipation factor for a capacitor at 1 kHz.

- By default, the measurement frequency is set to 1 kHz. To change the frequency, press the *FREQ* key and use the rotary knob to set the desired value.



Fig. 2-3: Display of impedance and phase angle for a capacitor.

#### Measuring a coil

- Connect the coil between the red (+) and black (-) terminals of HZ184 (Fig. 2-1).
- The correct measurement function is set automatically in Auto mode, which is enabled by default (see Fig. 2-8 and Section 2.1.2.1). In this case, L-Q is displayed, i.e. inductance L and quality Q (Fig. 2-4). Other parameters such as impedance and phase angle are displayed by pressing a key and selecting the appropriate measurement functions as described in the manual. In the case of an ideal coil, the phase angle is  $+90^\circ$ . Fig. 2-5 shows the measurement of an actual lossy coil with a phase angle of  $+81^\circ$ .

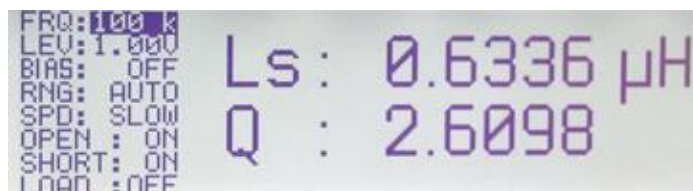

Fig. 2-4: Display of inductance and quality for a coil at 100 kHz.

- By default, the measurement frequency is set to 1 kHz. To change the frequency, press the *FREQ* key and use the rotary knob to set the desired value.



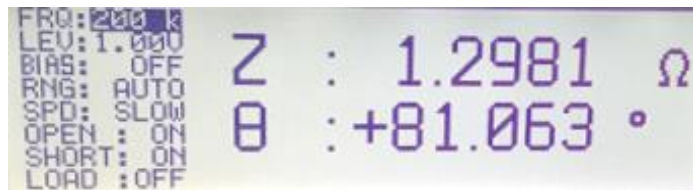

Fig. 2-5: Display of impedance and phase angle for a coil.

- For the current-dependent measurement of inductance, an internal bias current (BIAS) of up to 200 mA can be set in 1 mA increments.
- Press the *SELECT* key and use the rotary knob to select *SETUP* in the menu. Press the rotary knob to enable *CST V* and then use the rotary knob to set *ON*.
- Press the *ESC* key.
- Press the *BIAS* key and then use the rotary knob to set the required bias current. Pressing the *BIAS* key a second time will switch the bias current off again. **Caution: The coil must be discharged before it is disconnected from the test instrument.** After the bias current has been switched off, "Please wait ..." appears on the display during the discharge process. The coil can be disconnected from the LCR bridge as soon as this message is no longer displayed.

Measuring a resistor

- Connect the resistor between the red (+) and black (–) terminals of HZ184 (Fig. 2-1).
- The correct measurement function is set automatically in Auto mode, which is enabled by default (see Fig. 2-8 and Section 2.1.2.1). In this case, R-Q is displayed, i.e. resistance R and quality Q ( Fig. 2-6). Other parameters such as impedance and phase angle are displayed by pressing a key and selecting the appropriate measurement functions as described in the manual. In the case of an ideal resistor, the phase angle is 0°. Fig. 2-7 shows the measurement of an actual lossy resistor with a phase angle of 0.0152°.

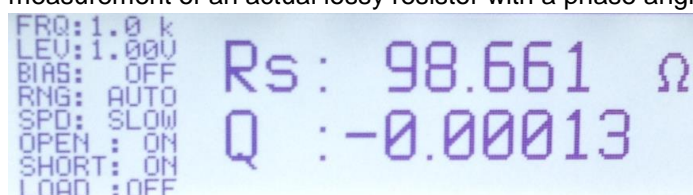

Fig. 2-6: Display of resistance and quality for a resistor at 1 kHz.

- By default, the measurement frequency is set to 1 kHz. To change the frequency, press the *FREQ* key and use the rotary knob to set the desired value.

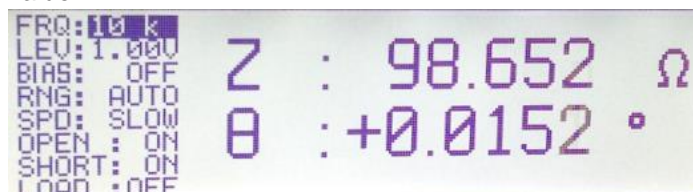

Fig. 2-7: Display of impedance and phase angle for a resistor.

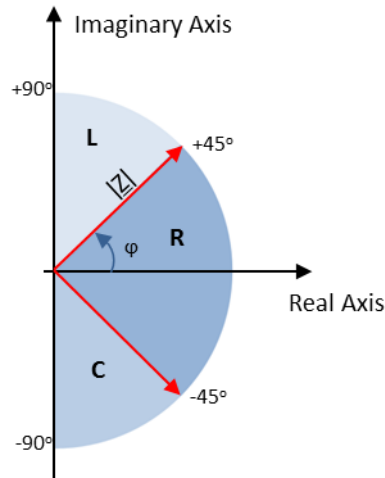

Fig. 2-8: HM8118 measurement principle in Auto mode: DUTs with a phase angle  $>+ 45^\circ$  are interpreted as a coil. If the phase angle is  $< - 45^\circ$ , the capacitive characteristics predominate and the component is considered to be a capacitor. Components with a phase angle between  $-45^\circ$  and  $+45^\circ$  are assessed to be resistors.

### 2.1.2.1 Selecting the Circuit Type for L, C, R Measurements:

In Auto mode (Auto key), the HM8118 LCR bridge uses the most suitable circuit type (serial or parallel) based on the component type and the measured impedance  $|Z|$ . The circuit type is shown in the equivalent circuit model for the test circuit. For impedances  $< 1 \text{ k}\Omega$ , the serial equivalent circuit model for coils and capacitors is used. For impedances  $> 1 \text{ k}\Omega$ , the parallel equivalent circuit model is used. A coil or capacitor with a quality value of  $Q=500$  or higher is considered to be ideal. In this case, the equivalent circuit model is no longer applicable. The measurement principle for Auto mode is shown in Fig. 2-9.

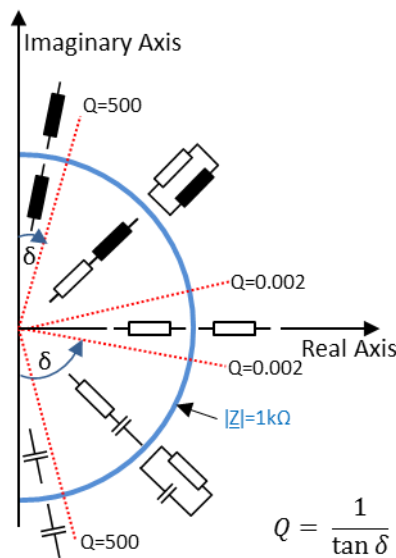

Fig. 2-9: HM8118 measurement principle using serial or parallel equivalent circuit model.

Coils with predominantly ohmic losses are typically measured in a series connection. In the case of coils with an iron core (for which core losses are the most significant) a parallel circuit is better suited for the equivalent circuit model for the test circuit.

- To set the circuit type manually, press the *SER* or *PAR* key. In the display, the circuit type is indicated by the subscript index **s** (serial) or **p** (parallel); for example, for a capacitor measurement, it would be displayed as  $C_s$  or  $C_p$ .

## 2.2 Resistance and Capacitance Measurements Using an HMC8012 Digital Multimeter

If it is not important to know the frequency response and the phase angle of capacitors and resistors, a digital multimeter such as the HMC8012 can be used in the place of the LCR bridge described in Section 2.1. In addition to the obvious voltage and current measurement functions, this multimeter also provides functionality for measuring resistance and capacitance. Inductance measurements are not possible using only the digital multimeter because it is not possible to measure inductance directly. To determine inductance, the phase relationship of the current and the voltage must be known in addition to the amplitude. However, it is not possible to determine the phase using a multimeter.

### 2.2.1 Test Setup

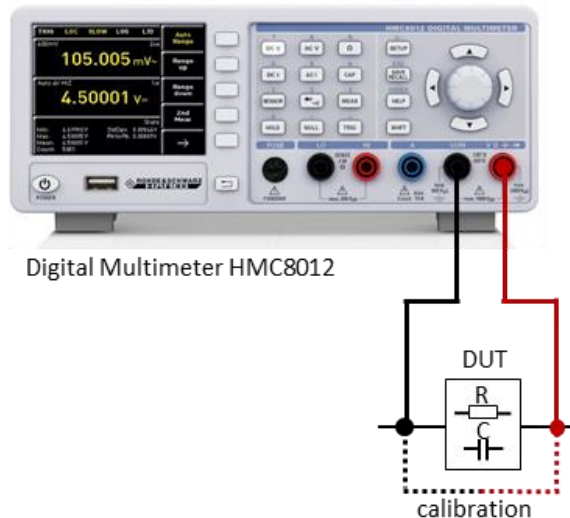

Fig. 2-10: Resistance and capacitance measurement using an HMC8012 digital multimeter.

## 2.2.2 Example: Resistance and Capacitance Measurements

- At the front of the instrument, connect the test cable to the appropriate sockets **COM** and **V** as shown in Fig. 2-10.
- Press the **SETUP** key and then use the *Default Settings* softkey to set the digital multimeter to the default state.
- The test setup must be calibrated before beginning the measurement in order to eliminate interference caused by the resistance from the test lead or by the contact resistances and thermopile voltages at the transitions from one metallic material to another.
  - To perform the calibration, connect the two test leads and press the **NULL** key. An offset correction is performed over the entire measurement path. The offset value is displayed under the main measurement result ( Fig. 2-11) and the **NULL** key is lit.
  - *Note: The calculated offset value is not saved. In other words, the calibration must be repeated each time the HMC8012 is started.*



Fig. 2-11: Display of the offset value after calibration.

- Measuring resistance
  - Connect the resistor between the two test cables.
  - Press the **Ω** key. The measured resistance is displayed.
  - Additional statistical values such as max., min., mean, etc. are displayed under the main measurement result (Fig. 2-12). To hide the values or to change the settings, press the **MEAS** key and select the **STATS** softkey.

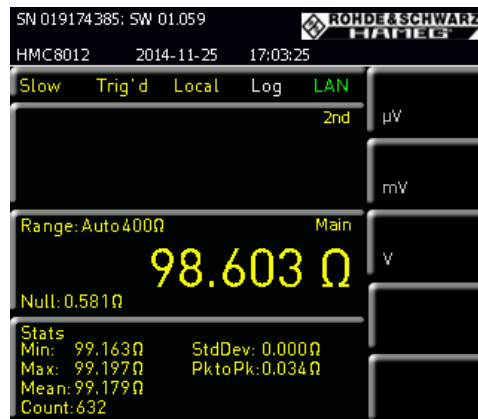

Fig. 2-12: Display of a resistance measurement.

■ Measuring capacitance

- Connect the capacitor between the two test cables.
- Press the *CAP* key. The measured capacitance is displayed.
- Additional statistical values such as max., min., mean, etc. are displayed under the main measurement result (Fig. 2-12). To hide the values or to change the settings, press the *MEAS* key and then select the *STATS* softkey.

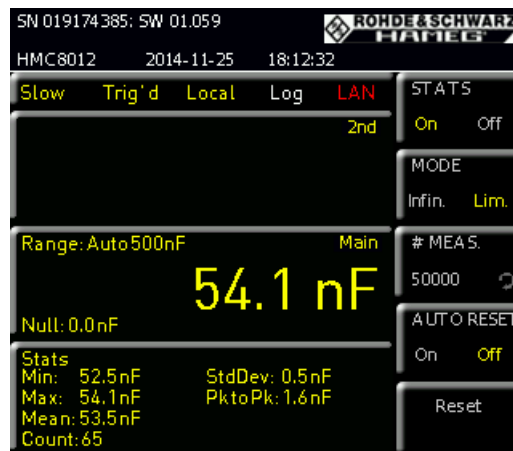

Fig. 2-13: Display of a capacitance measurement.

## 2.3 Filter Measurements Using a Spectrum Analyzer

The transmission characteristics of a filter are easily determined by using a spectrum analyzer and an internal tracking generator to perform a transmission measurement. The tracking generator supplies a sine signal with a constant amplitude and a frequency that remains synchronized to the frequency display for the spectrum analyzer. Fig. 2-16 shows the test setup for a filter measurement. A calibration must be performed before the measurement is started. To do this, through-connect the cable ends that will later be connected to the filter, then start a calibration. The calibration measures and saves the insertion loss for the test cable over the defined frequency range. During the measurement with the DUT inserted between the two cable ends, the FSC subtracts the calculated cable loss. This means that the transmission characteristics of the DUT are measured without any influence from the test cable.

Fig. 2-14 The transmission measurement in Fig. 2-14 shows the insertion loss for the two through-connected RF cables. Fig. 2-15 shows the same measurement after the calibration. The influence of the RF cable is almost completely eliminated and a flat trace results at the 0 dB line. This also makes it easy to determine whether the calibration was successful.

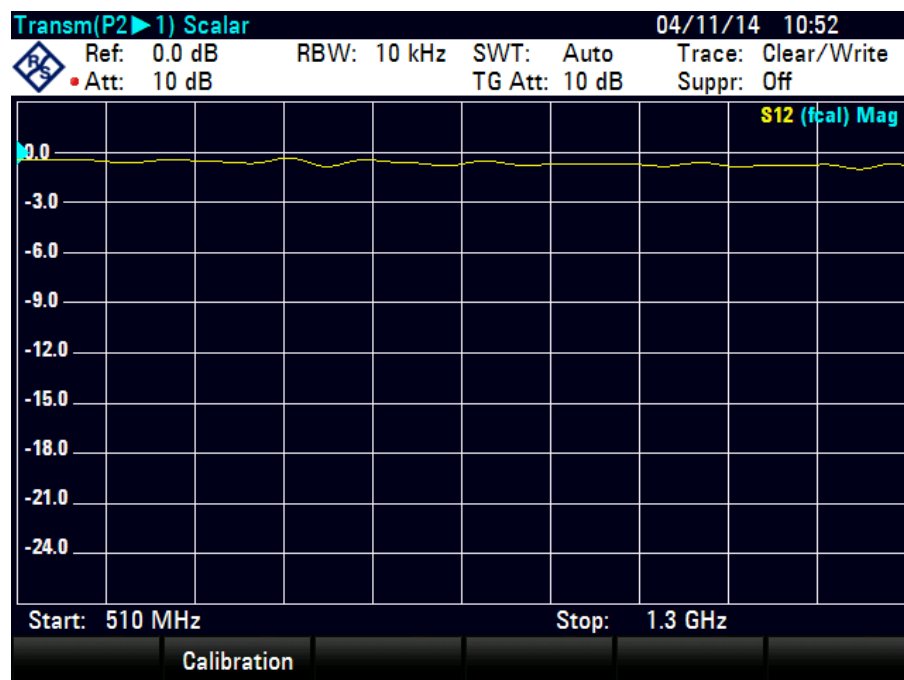

Fig. 2-14: Measurement of a through connection without calibration.

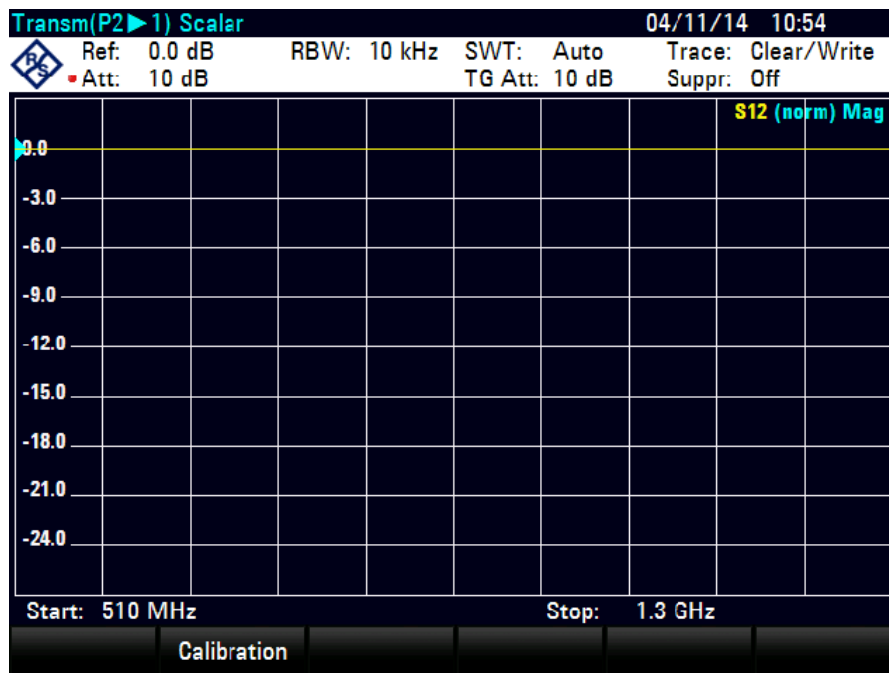

Fig. 2-15: Measurement of a through connection after calibration.

### 2.3.1 Test Setup

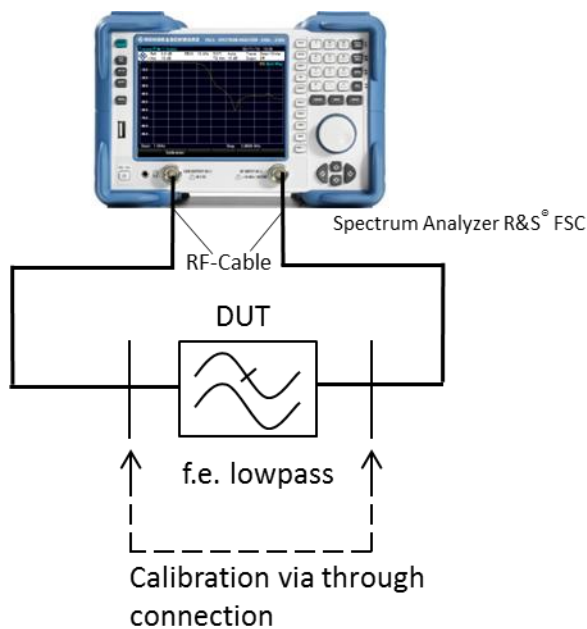

Fig. 2-16: Filter characteristics measurement using the FSC spectrum analyzer with internal tracking generator.

### 2.3.2 Example: Lowpass Filter Measurements Using the FSC Spectrum Analyzer

Calibration:

- ▮ Press the *PRESET* key to restore the FSC to a predefined default state.
- ▮ *FREQ* → Start Freq: 500 MHz → Stop Freq: 3 GHz.
- ▮ *MEAS* → Calibration → Normalize Transmission.
- ▮ Follow the instructions on the screen to create a through connection.
- ▮ *Continue* to start the calibration.
- ▮ After a successful calibration, you will see "S12 (norm) Mag" at the top right corner of the display.

Note:

*The calibration is performed in the same frequency range as the later measurement. After the calibration is completed, the frequency range can be further limited without losing the calibration. However, because the measurement points will no longer correspond to those used during the calibration, they will be interpolated during the correction. This is indicated at the top right corner of the display with "S12 (interp) Mag". The measurement uncertainty is increased as a result; however, it remains negligible in most cases. On the other hand, increasing the frequency range would make the calibration invalid because no calibration data is available outside the calibrated frequency range.*

Measurement:

- ▮ Disconnect the through connection and insert the filter.
- ▮ The filter transfer function is shown on the display, see [Fig. 2-17](#).
- ▮ Press the *AMPT* key and use *Range* to select a suitable scaling.
- ▮ Use *Ref Position: 9* to shift the reference line down.
- ▮ To measure the minimum attenuation in the filter passband:
  - Press the *MKR* key and select menu option *Set to Peak*, then set the value. In this example, the attenuation in the passband is 0.22 dB.
- ▮ To measure the filter cutoff frequency (–3 dB):
  - Press the *MKR* key and use *New Marker* to enable a second marker M2.
  - Use *Marker Type* to change M2 into a delta marker D2.
  - Use the rotary knob to shift the delta marker until it displays a value of –3 dB.
  - The filter cutoff frequency = frequency M1 + frequency D2. In this example, it is  $f_c = 607 \text{ MHz} + 718 \text{ MHz} = 1325 \text{ MHz}$
- ▮ To measure the maximum stopband attenuation:
  - Press the *MKR->* key and *Set to Minimum*. In this example, the attenuation is 58.55 dB.





Fig. 2-17: Measurement of the 3 dB cutoff frequency and the maximum stopband attenuation on a lowpass filter.

## 2.4 Filter Measurements Using a Vector Network Analyzer

As described in Section 2.3, a spectrum analyzer with a tracking generator can be used to determine the amplitude response of a filter. However, additionally determining the reflection and phase response requires either a spectrum analyzer with vector network analysis function or a vector network analyzer. In addition to a signal source that essentially corresponds to the tracking generator on a spectrum analyzer, vector network analyzers also have at least one VSWR bridge and at least one reference channel. The analyzer uses the VSWR bridge to receive the signal reflected from the DUT. The analyzer can use the relationship of the reflected signal to the generator signal to calculate the reflection factor of the connected DUT and to display it over the frequency, for example. The reference channel is used to measure the phase in relationship to the test signal from the internal generator. Unlike with a scalar measurement, the additional phase measurement makes a vector error correction possible. This helps to correct systematic measurement errors by implementing the appropriate calibrations. These can be summarized as follows:

- Frequency response of the generator, cables, directional coupler/bridge
- Directivity of directional coupler/bridge
- Mismatch of port 1 and port 2
- Isolation (crosstalk between the measurement channels)

Compared to a scalar measurement, this results in a significantly improved measurement accuracy and dynamic range. Vector network analyzers are available in single-port or multiport models. An analyzer with only one test port can only measure the reflection. With a multiport model, the transmission characteristics of the DUT can

also be determined. Multiport analyzers must also specify whether they can measure in one direction (unidirectional) or in both directions (bidirectional). In the following example, the filter measurement uses the unidirectional model of the ZND vector network analyzer. The ZND can be upgraded for bidirectional measurements by entering an optionally available license key.

### 2.4.1 Test Setup

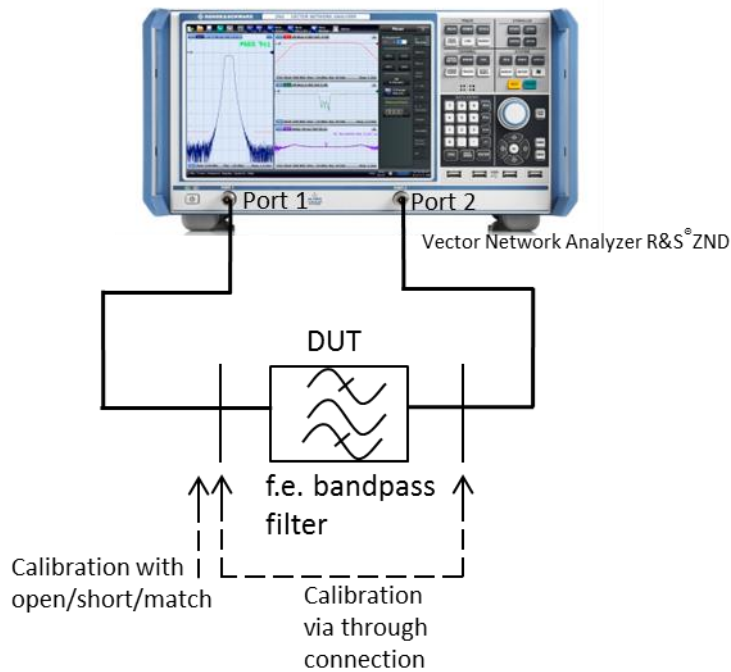

Fig. 2-18: Measurement of the filter characteristics using the ZND vector network analyzer.

### 2.4.2 Example: Bandpass Filter Measurements Using the ZND Vector Network Analyzer

As shown in Fig. 2-18 the test setup is calibrated before the measurement. For a vectorial measurement, the test cables must be through-connected, followed by three additional calibration steps. A short circuit, an open circuit and a high-precision 50  $\Omega$  resistor are used as calibration standards. It must be ensured that the correct calibration standard is connected to the cable end. The RF characteristics (essentially the reflection) of each standard are known, making it possible to calculate the associated correction values. Unlike with scalar measurements using the spectrum analyzer, the length of the through connection must be known because this will affect the phase measurement.

*Note:*

*For an overview measurement, e.g. to determine a reasonable frequency range for the calibration, there is no need to calibrate the ZND. This is because the ZND is calibrated at the factory over the entire frequency range. This calibration will not*

provide the maximum possible measurement accuracy, but it does provide usable results.

The ZND offers a wizard that greatly simplifies the device configuration and the measurement. It guides the user through all of the device settings relevant to the selected measurement task. The example provided in this section uses the wizard. The attachment describes how to perform this bandpass filter measurement without using the wizard.

Measurement steps:

- Press the *PRESET* key to restore the ZND to a predefined default state.
- Press the *MEAS* key and select the S-Parameter wizard.
- In the wizard splashscreen, press *Next*.
- Select the *Single-ended 2-port* test setup and then press *Next* to continue.
- Select *Use Default* for both logical ports L1 and L2.

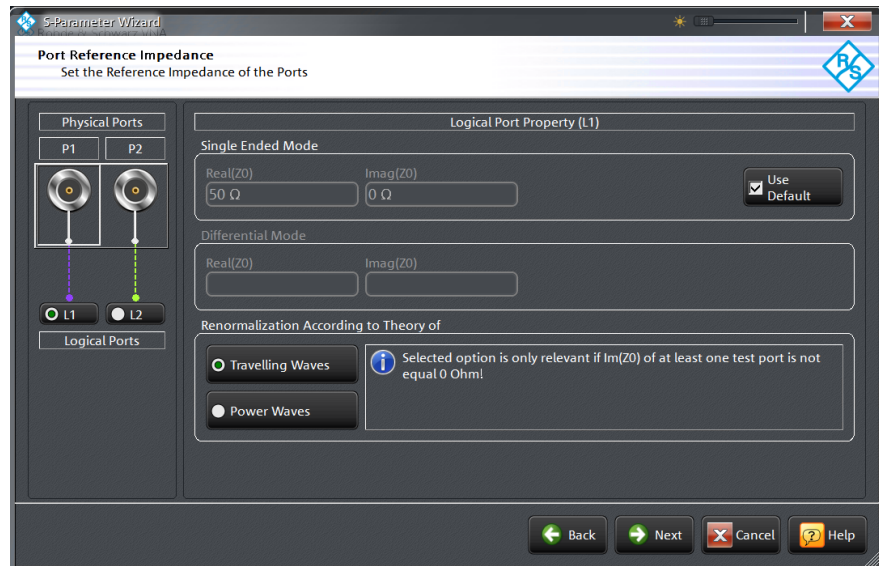

Fig. 2-19: ZND port configuration.

- Press *Next* and select *Dual split  $S_{11}$ ,  $S_{21}$  (dBMag)* reflection and transmission in the forward direction) as the desired measurement result.

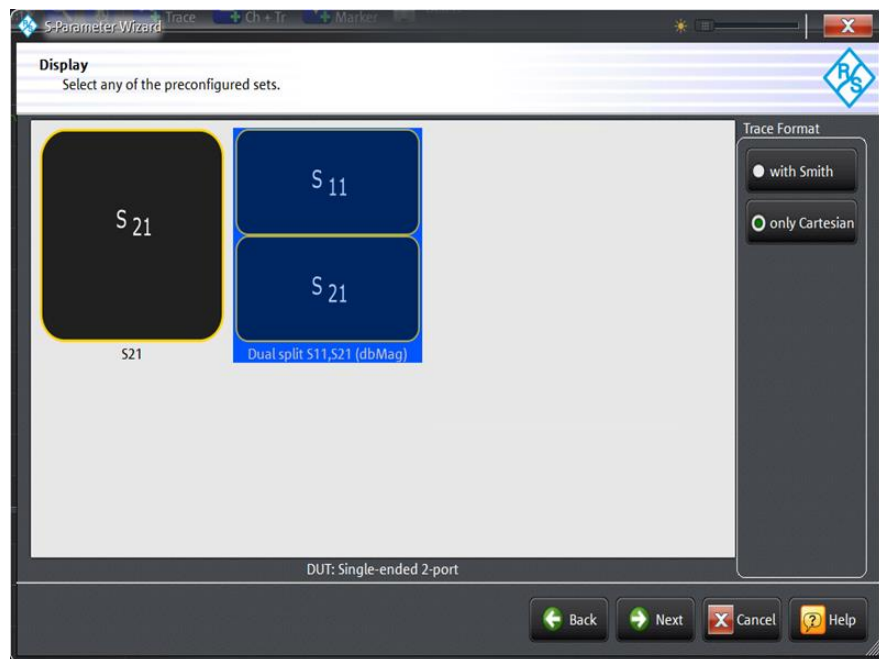

Fig. 2-20: Selecting the predefined measured value display.

- Press *Next* and define a frequency range appropriate for the filter and the desired number of measurement points. (Note: The number of measurement points will affect the measurement speed.)

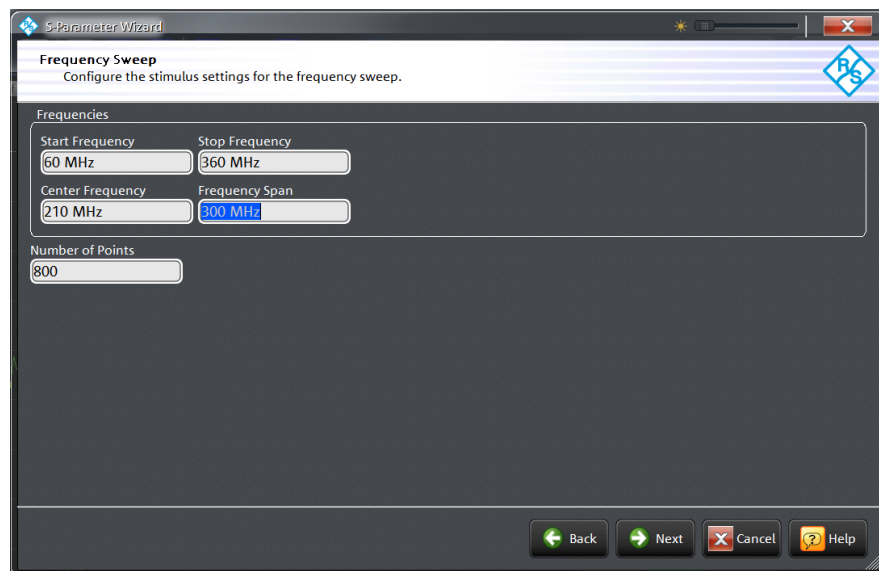

Fig. 2-21: Setting the frequency range and number of measurement points.

- Press *Next* and define the desired measurement speed and dynamic range over the measurement bandwidth. Also define the output power at port 1.

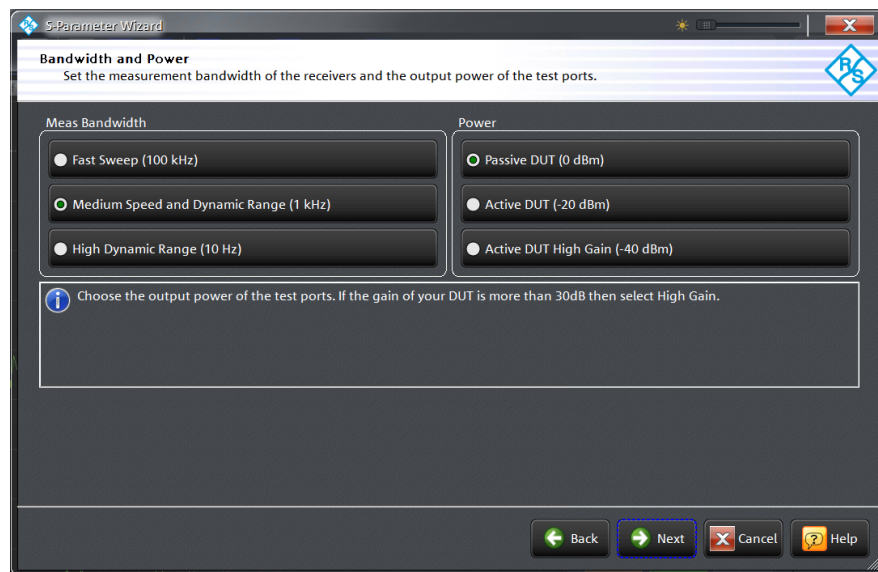

Fig. 2-22: Setting the sweep time and output power.

- Press *Next* and select *Continue with Manual Calibration*, then click *Finish* to close the wizard.

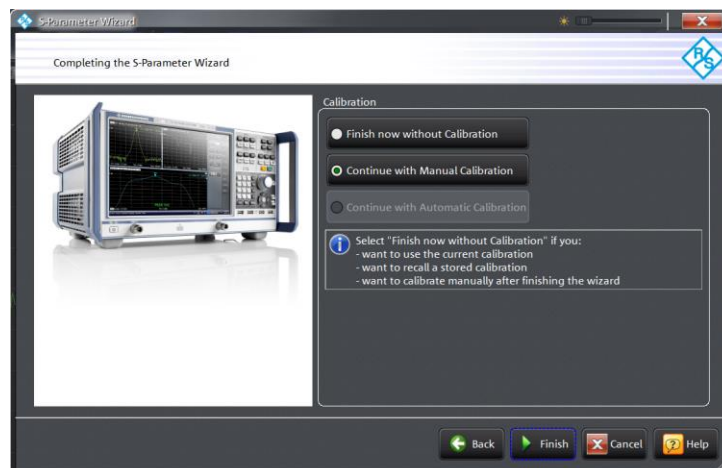

Fig. 2-23: Closing the wizard and starting the manual calibration.

- The transmission and reflection characteristics of the filter are measured in the forward direction. Therefore, the *One Path Two Ports* calibration must be selected.

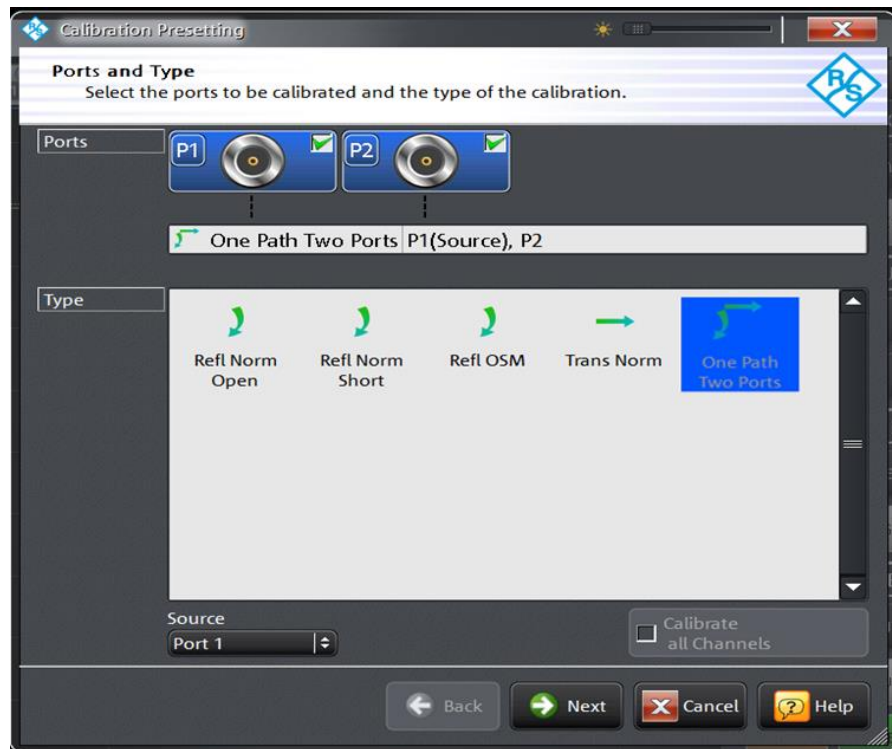

Fig. 2-24: Selecting the possible calibration types for a unidirectional measurement.

*Note:*

If the ZND is equipped with the R&S® ZND-K5 or R&S® ZND-K8 bidirectional measurement options, it is recommended that the **Through / Open / Short / Match (TOSM)** calibration be used. The advantage of this calibration type lies in its improved measurement accuracy through the use of a vector 12-term error correction. This includes the RF characteristics of the second test port in the measurement and as a result reduces its influence on the measurement results. The degree of influence that port 2 has on the results depends on how the filter output is adapted and how great the insertion loss is.

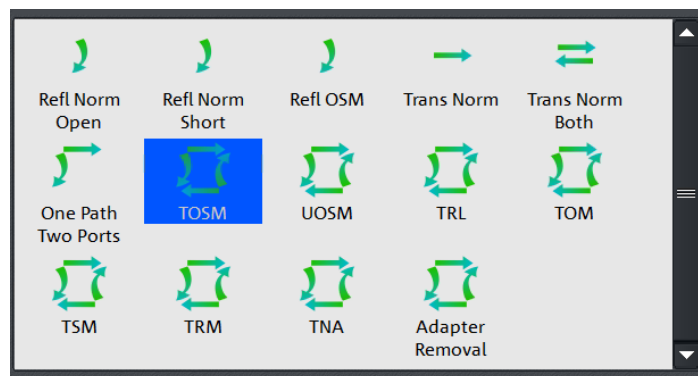

Fig. 2-25: Selecting the TOSM calibration.

- Select the connector type and gender for port 1, port 2 and select the calibration kit being used. If the calibration kit is not listed, use *Import Calkit...* to load the calibration kit data into the ZND. Press *Start* to start the calibration routine.

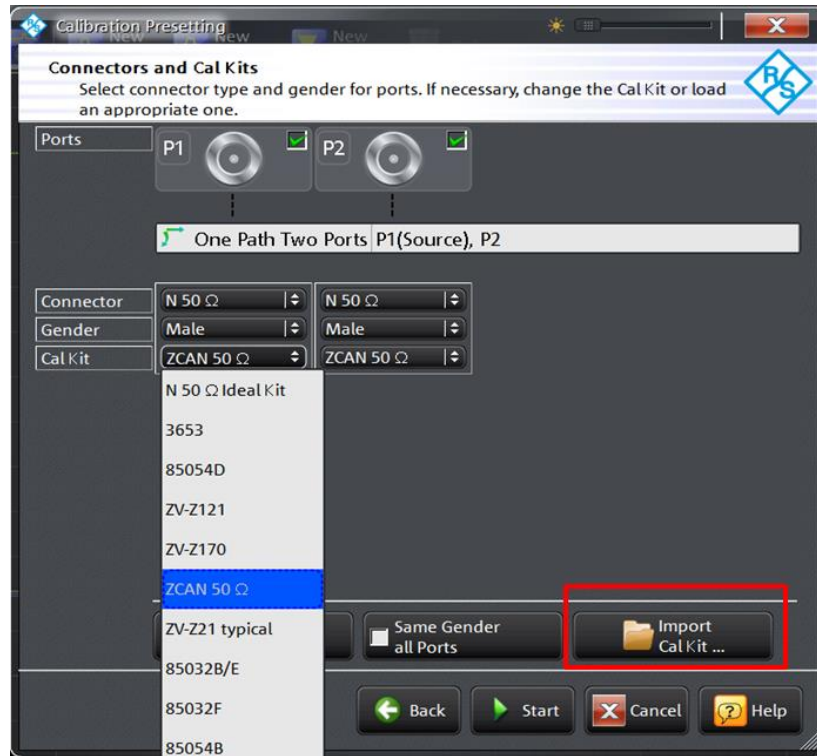

Fig. 2-26: Selecting the connector type and the calibration kit.

- Select the four calibration standards Open, Short, Match and Through in sequence, then connect the appropriate standard to port 1, or in the case of the through standard, create a through connection between ports 1 and 2. (Note: "Port 1" and "port 2" refer here to the ends of the test cable being used.)

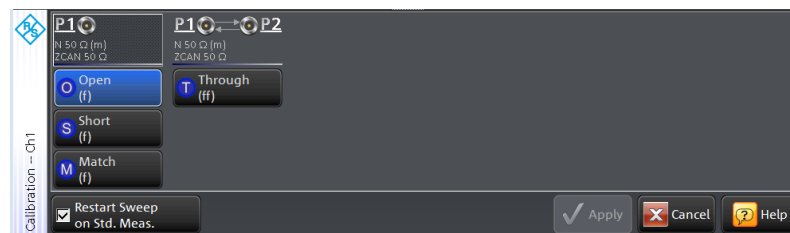

Fig. 2-27: Selecting the calibration standard.

- Use *Start CAL Sweep* to start the calibration. Important note: The calibration standards must not be swapped out during the calibration. This is the only way to ensure that the vector error correction returns correct results.

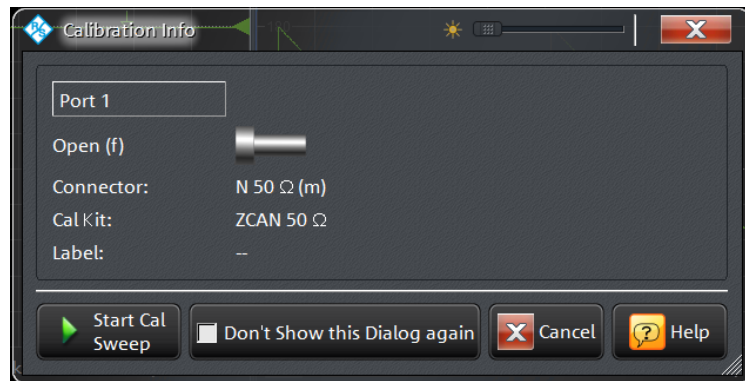

Fig. 2-28: Starting the calibration.

- Once all four calibration steps are completed, end the calibration with *Apply*.

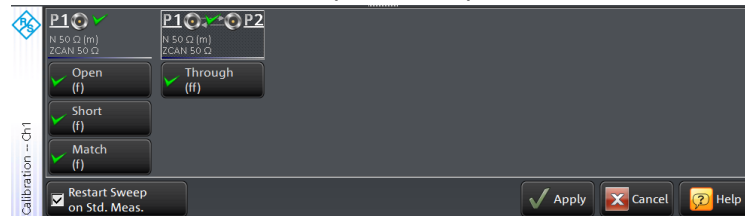

Fig. 2-29: The calibration with all calibration standards was completed.

- Connect the filter between the two test cables as shown in Fig. 2-18.
- The reflection ( $S_{11}$ ) is shown in the upper half of the split screen and the transmission ( $S_{21}$ ) in the lower half ( Fig. 2-30). Press the *SCALE* key and adjust the y-axis scaling as needed.

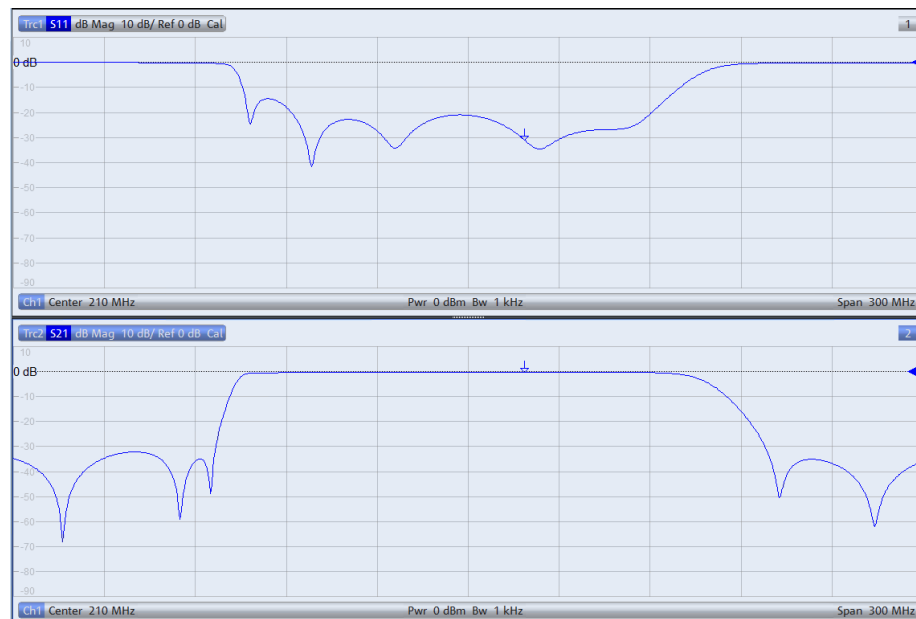

Fig. 2-30: Bandpass filter measurement with display of reflection and transmission.



- Press the *DISPLAY* key and select *Overlay All*. Both traces are now displayed in one diagram (Fig. 2-31). The superimposed reflection and transmission measurements show that the input signal is reflected significantly less in the passband than it is in the stopband. (The greater the return loss, displayed in dB, the better the filter is adapted and the less the input signal is reflected at the filter input.)



Fig. 2-31: Reflection and transmission in one diagram.

- Trace 2 must be active in order to measure the filter center frequency, bandwidth, quality, etc. This is checked by looking at the text highlighted in blue at the top of the screen in the example (see Fig. 2-31). If trace 2 is not active, press the *Trace* key and select *Active Trace, Trc2*.
- Press the *MARKER* key and select the *Bandfilter* tab.
- Bandwidth*: Enter 3 dB and then enable *Bandpass Ref to Max*. As shown in Fig. 2-32, all relevant values for the bandpass are displayed at the top right corner of the screen.

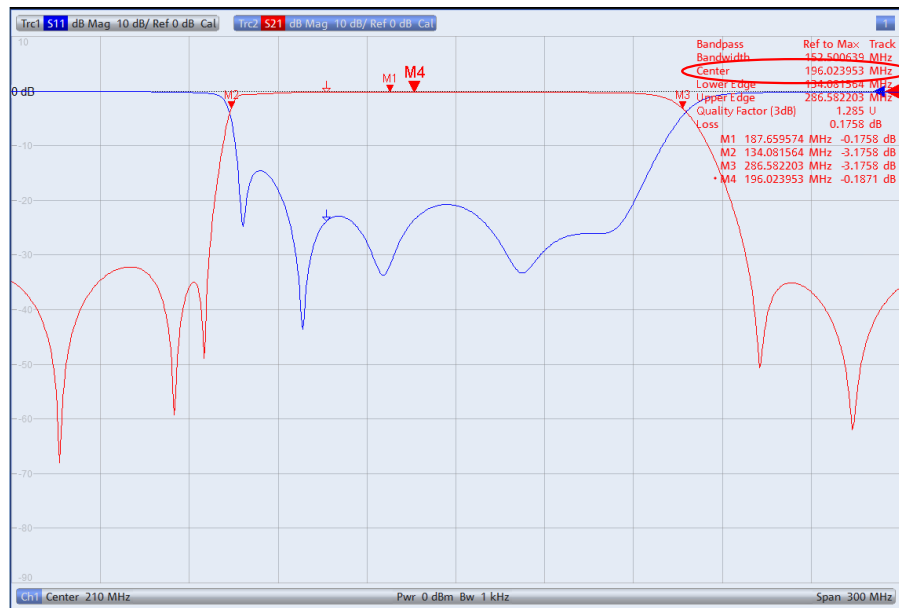

Fig. 2-32: Display of all relevant values for a bandpass.

- By default, the geometric mean (marker M4)  $f_0 = \sqrt{f_H \cdot f_L}$  ( $f_L=M2$ ;  $f_H=M3$ ) is displayed for the center frequency; in this case:  $f_0= 196.023953$  MHz (Fig. 2-32). To display the arithmetic mean:
  - Press the *SETUP* key and select *System Config...* Select the *Advanced* tab and disable *Geometric Calculation of Bandfilter Center*. In place of the geometric mean, the absolute center frequency of 210.33 MHz is now displayed (Fig. 2-33).

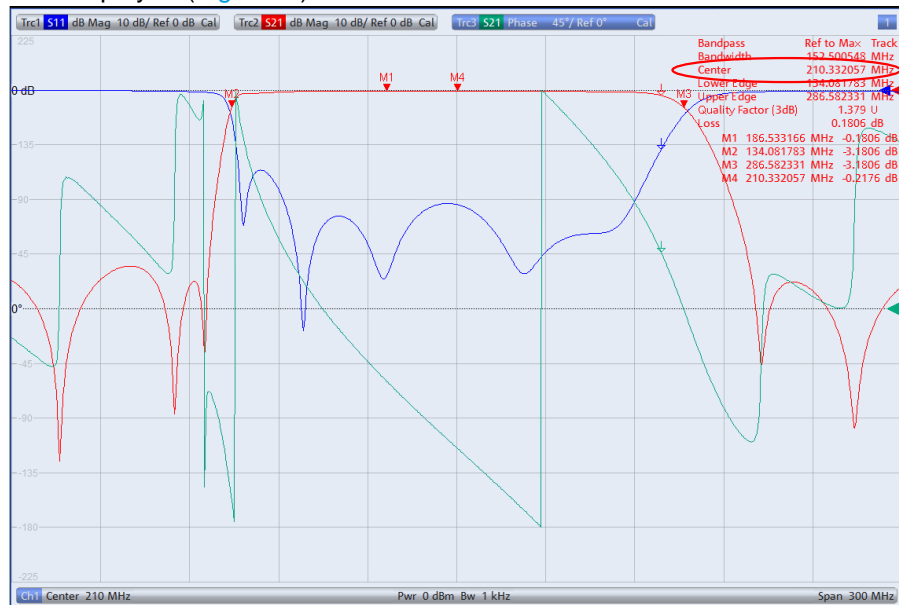

Fig. 2-33: Display of the absolute bandpass center frequency.

In addition to the transmission value, the phase response can also be displayed (Fig. 2-34).

- Press the *TRACE CONFIG* key and use *Add Trace* to generate another trace. Press the *FORMAT* key and select *Phase*.

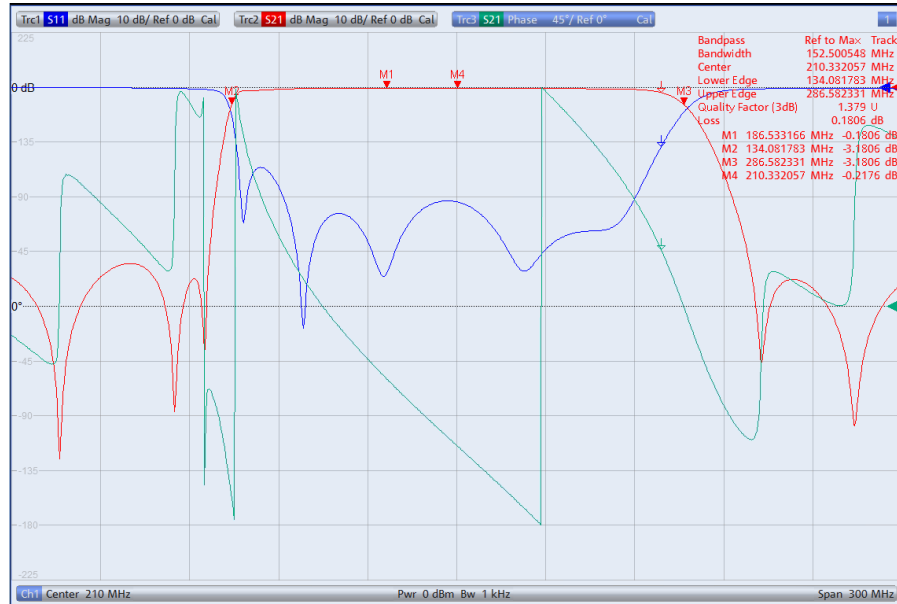

Fig. 2-34: Additional phase response measurement for  $S_{21}$  (green trace).

- To display all three measured values (reflection, transmission and phase) in separate diagrams (Fig. 2-35), press the *DISPLAY* key and select *Split All*.

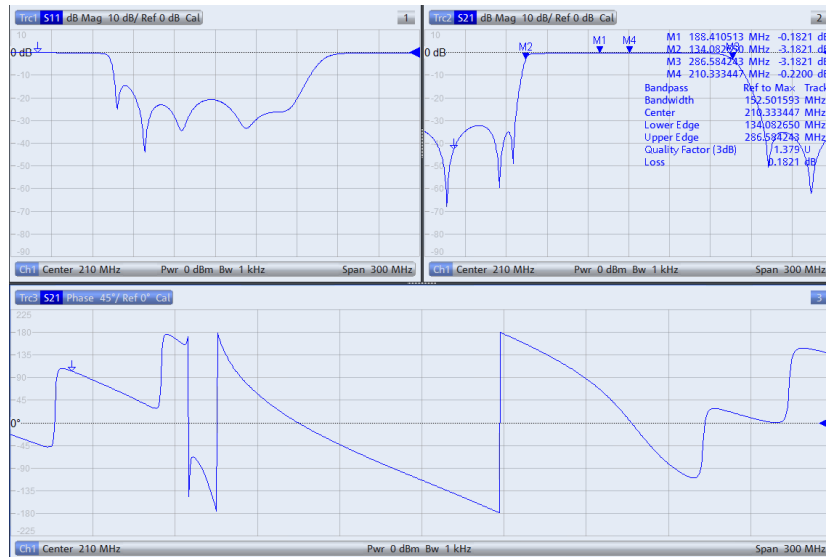

Fig. 2-35: Display of all key filter parameters in split screen.

## 2.5 Filter Measurements Using an Oscilloscope

The characteristics of frequency filters can be determined by using measurements in the time domain in the place of measurements in the frequency domain. This is especially useful for audio filters because the necessary measurement equipment, such as an oscilloscope and a signal generator, are typically already available at the workstation.

### 2.5.1 Test Setup

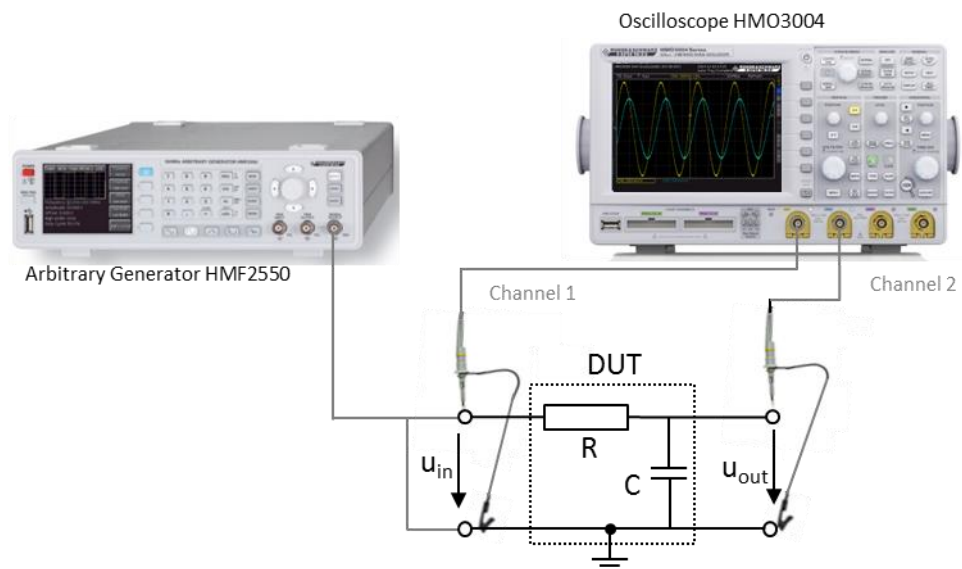

Fig. 2-36: Measuring the filter characteristics using the HMO3004 oscilloscope.

### 2.5.2 Example: RC Lowpass Filter Measurements Using the HMO3004 Oscilloscope and the HMF2550 Arbitrary Generator

A simple RC lowpass 1st order ( $R=100\ \Omega$ ,  $C=47\ \text{nF}$ ) is used as the DUT. The HM8118 LCR bridge (see also 2.1) measured the following values for the resistor and the capacitor:  $R=98.4\ \Omega$ ;  $C=54.7\ \text{nF}$

Per Equation 3, this results in a cutoff frequency of

$$f_c = 1/(2 \cdot \pi \cdot 98.4\ \Omega \cdot 54.7\ \text{nF}) = 29.56\ \text{kHz}.$$

Note: Alternatively, a digital multimeter such as the HMC8012 can also be used to measure the components (see also 2.2).

To check the calculated cutoff frequency:

HMF2550:

- Set the generator to the default state: Press the *MENU* key and then select *Save Recall* → *Device Settings* → *Default Settings*.

- Connect the signal generator output to the filter input as shown in Fig. 2-36.
- Use the *Frequency* softkey to set low frequency in the filter passband (e.g. 500 Hz).
- Use the *Amplitude* softkey to set the desired output voltage (e.g.  $U_{in}=5V$ ).

HMO3004:

- Connect a probe and a ground cable to the filter input as shown in Fig. 2-36. Connect the second probe and ground cable to the output.  $u_{in}$  is measured with CH1 and  $u_{out}$  with CH2.
- Set the oscilloscope to the default state: Press and hold *AUTO SET* for longer than 3 s.

HMF2550

- Use the *OUTPUT* key to switch on the signal.

HMO3004:

- Press the *CH2* key.
- Press the *Auto Set* key. Triggering is on the rising edge of the input voltage  $u_{in}$  (CH1). X and y deflection are set automatically (Fig. 2-37).

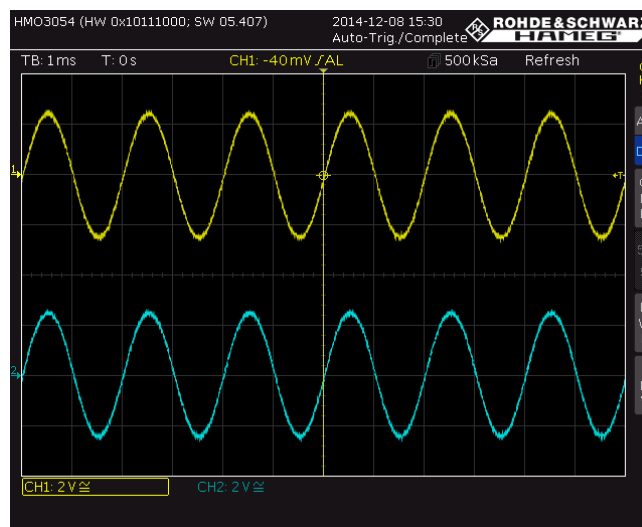

Fig. 2-37: Display of  $u_{in}$  (CH1, yellow) and  $u_{out}$  (CH2, blue) after the "AUTO SET".

- Shift signal  $u_{out}$  to the horizontal zero line (CH2: 0V) using the *VERTICAL POSITION* rotary knob. To increase the measurement accuracy, use the *V/DIV* rotary knob to increase the vertical deflection as much as possible. Press the *V/DIV* rotary knob to fine-tune. The signal amplitude should remain visible.
- Press the *CH1* key and repeat the above settings for  $u_{in}$ .
- Use the *TIME/DIV* rotary knob to change the y deflection until a complete signal oscillation is visible. Use the horizontal position rotary knob to shift the signal until it passes through the zero crossing (Fig. 2-38).

- As described in 1.1, the capacitor represents an infinitely high resistance at low frequencies, so that the entire voltage is received at the capacitor ( $U_{in}=U_{out}$ ). As is to be expected, the output voltage has no phase response (Fig. 2-38).

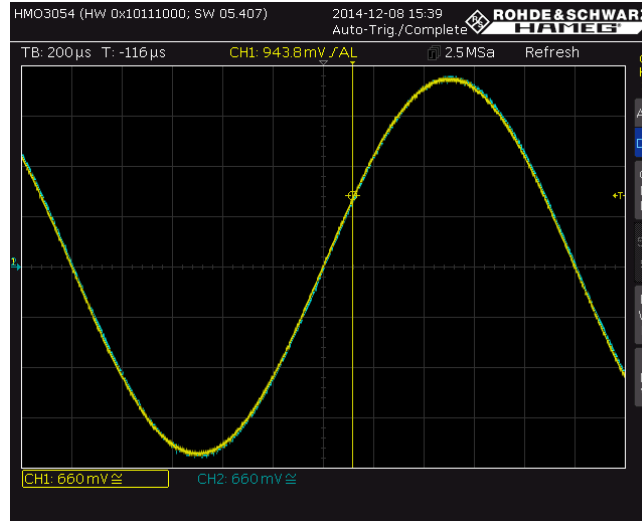

Fig. 2-38: Superimposed display of CH1 and CH2.

- Press the *QUICK View* key. All relevant parameters of the input signal  $u_{in}$  are displayed (Fig. 2-39),  $U_{in} = V_{pp} = 4.99\text{ V}$ . (Note: You can also use the *CH2* key to switch to the output voltage  $U_{out}$ .)

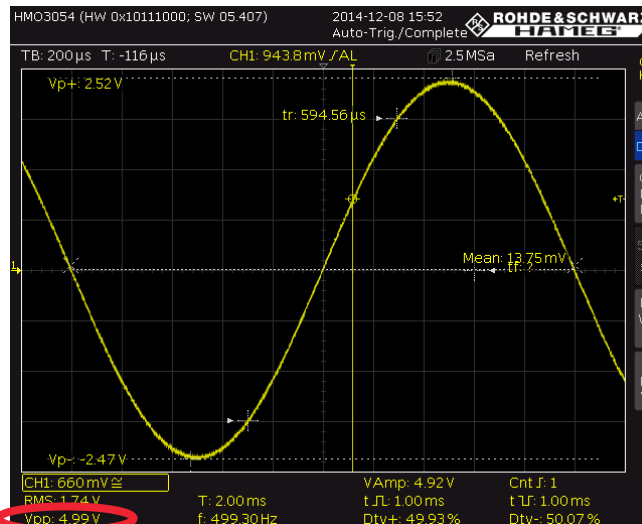

Fig. 2-39: Display of all relevant signal values.

HMF2550:

- Use the *Frequency* softkey to set the calculated cutoff frequency  $f=29.56\text{ kHz}$ .

HMO3004:

- Press the *QUICK View* key.

- Use the *TIME/DIV* rotary knob to change the y deflection until a complete signal oscillation is visible.
- The higher frequency changes the matching conditions between the signal generator and the DUT, which in turn affects the input voltage. To correctly measure the cutoff frequency, the input voltage must therefore be adjusted on the HMF2550 to the voltage value measured at  $f=500$  Hz (Fig. 2-40).

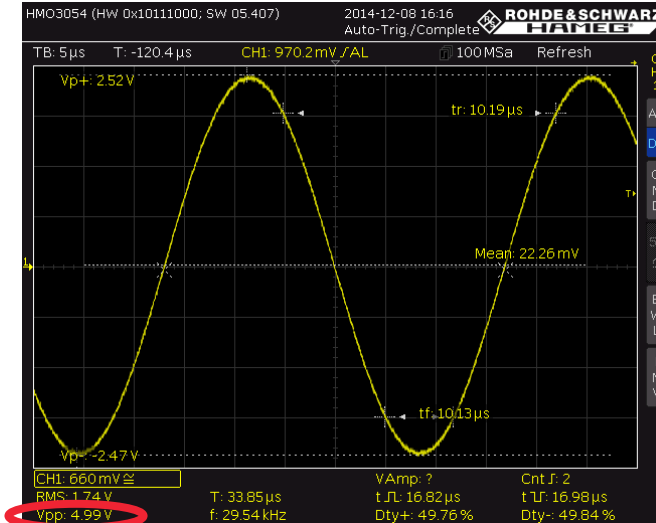

Fig. 2-40: Adjusted amplitude of  $U_{in}$  at the cutoff frequency.

- Press the *Quick View* key to switch off the Quick View function. Fig. 2-41 shows the attenuation and the phase response of the output voltage at the cutoff frequency.

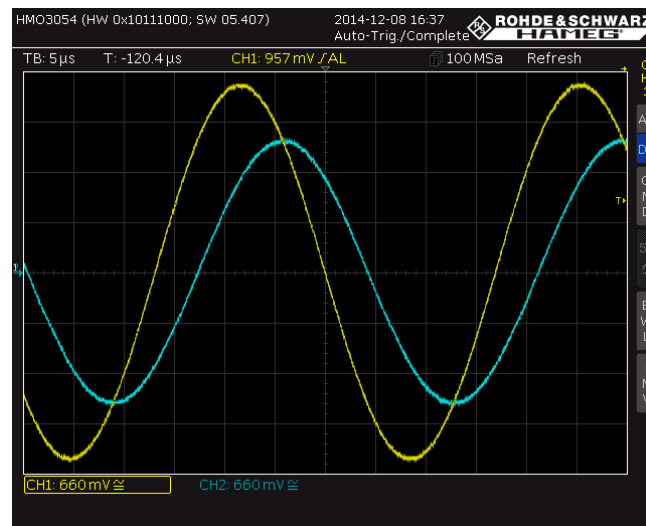

Fig. 2-41: Display of  $u_{in}$  (CH1, yellow) and  $u_{out}$  (CH2, blue) at the lowpass cutoff frequency.

- Press the *CH2* key.
- Press the *QUICK View* key.

- As described in Section 1.1, the following relationship exists for the output voltage at the cutoff frequency:  $u_{out} = \frac{u_{in}}{\sqrt{2}}$ . For this example, that calculates out to:  $u_{out} = \frac{4.99V}{\sqrt{2}} = 3.528 V$ . As seen in Fig. 2-42, the calculated value matches very well with the measured output voltage of 3.54 V.

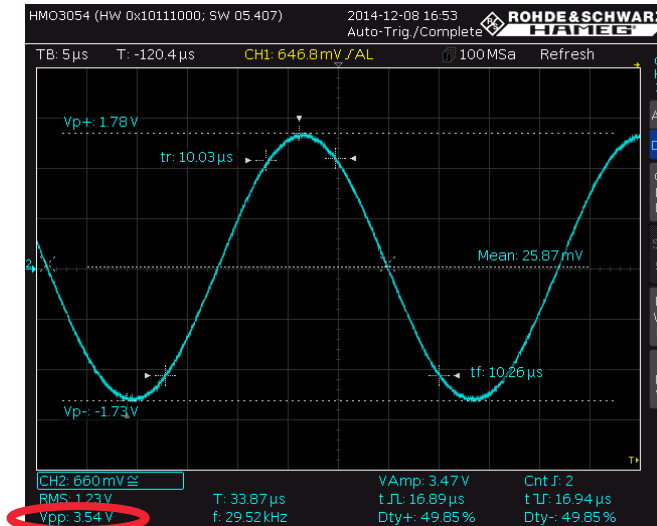

Fig. 2-42: Measured output voltage on the lowpass at the cutoff frequency.

To measure the phase response at the cutoff frequency:

- Press the *Quick View* key to switch off the Quick View function.
- Press the *AUTO MEASURE* key.
- Press the *MEASURE 1* softkey (=on).
- Press the *TYPE* softkey and use the *CURSOR/MENU* rotary knob to select the *Phase*, then press the rotary knob to confirm.
- To ensure that the phase is displayed with the correct sign, it must be determined which of the two signals is to be the reference signal and which is to be the test signal. Because the phase response of the lowpass output signal is referenced to the input signal, channel 1 is used as the reference. This requires the following settings:
  - Press the *REF. SOURCE* softkey, select *CH1* and press the rotary knob to confirm.
  - Press the *MEAS. SOURCE* softkey, select *CH2* and press the rotary knob to confirm.
- If "Phs?" is displayed at the bottom of the screen, reduce the horizontal deflection until the "?" is replaced with a value.
- As can be expected, the measured phase response of  $u_{out}$  is nearly  $-45^\circ$  at the cutoff frequency (see Fig. 2-43).



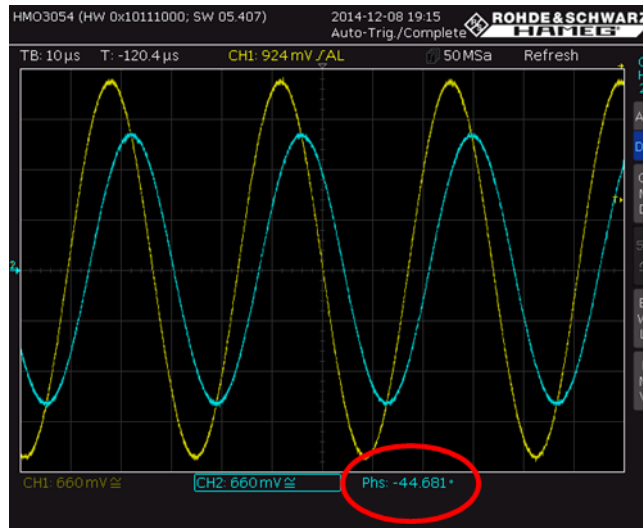

Fig. 2-43: Phase response between  $u_{in}$  and  $u_{out}$ .

To measure the amplitude and frequency response:

Using the procedure described in 2.5.2 as a basis, it is possible to determine the amplitude and the frequency response at the filter cutoff frequency as well as over a broad frequency range. The latter is accomplished by measuring the output voltage or the phase at different frequencies. The measured input voltage must be monitored to ensure that it remains constant up to the higher frequencies and adjustments must be made on the signal generator as needed. The amplitude response  $u_{in}/u_{out}$  and the phase response are then displayed over the frequency in a diagram (see Fig. 2-44 and Fig. 2-45).

f/kHz	0.1	1	5	10	15	20	25	30	35	40	100	300	500	1000	10000
$u_{in} / V$	5.0	5.0	5.0	5.0	5.0	5.0	5.0	5.0	5.0	5.0	5.0	5.0	5.0	5.0	5.0
$u_{out} / V$	5.0	5.0	4.99	4.75	4.47	4.16	3.82	3.51	3.23	2.99	1.48	0.5058	0.312	0.14	0.12
$u_{in}/u_{out}$	1	1	0.998	0.95	0.894	0.832	0.764	0.702	0.646	0.598	0.296	0.10116	0.0624	0.028	0.024

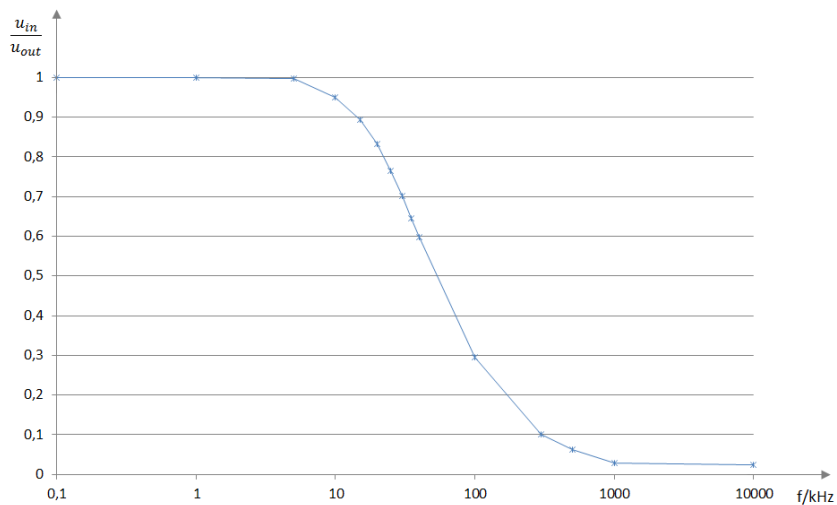

Fig. 2-44: Measured amplitude response for an RC lowpass 1st order.

f/kHz	0.1	1	5	10	15	20	25	30	35	40	100	300	500	1000
$\varphi$	0	-1.1	-10.6	-19.4	-27.5	-34.1	-40.2	-46.3	-50.1	-53.2	-70.2	-81.8	-84.5	-86.9

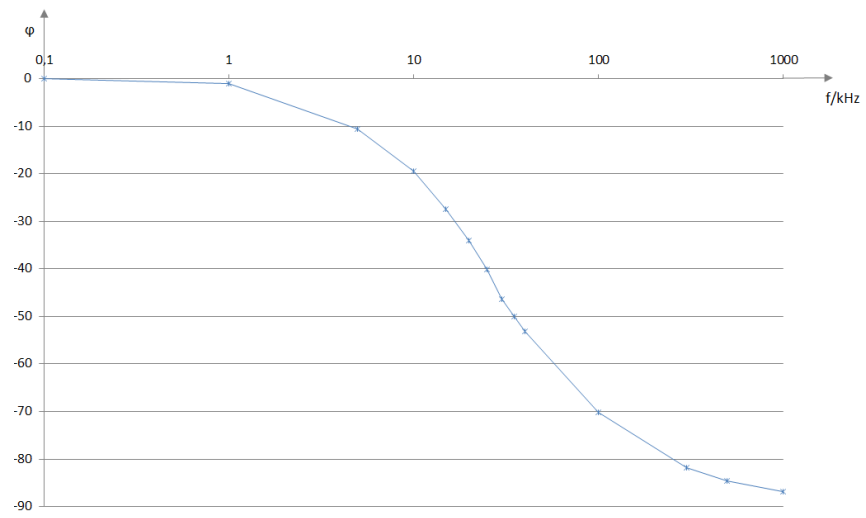

Fig. 2-45: Measured phase response for an RC lowpass 1st order.

## 3 Brief Presentation of the Measuring Instruments Used

Whether you work in a major electronics R&D facility or a small service lab, you are not always performing complex measurements and do not always need the ultimate in high-end T&M equipment. What you need are precise, reliable, universal measuring instruments. That is exactly what you get with Value Instruments from Rohde & Schwarz: instruments that combine practical features with excellent measurement characteristics, instruments that are easy to use and easy on the budget.

The practical implementation of frequency filter measurements is described on the basis of R&S® Value Instruments including the FSC Spectrum Analyzer, the ZND Vector Network Analyzer and the HMO 3004 Oscilloscope. All R&S® Value Instruments used for this Application Note are briefly presented in the following.

### 3.1 FSC Spectrum Analyzer

The FSC is a compact, cost-efficient solution that offers all essential features of a professional spectrum analyzer. It covers a wide range of applications from simple development tasks to production, or can be used for training RF professionals. Moreover, it is ideal for applications in service or maintenance. Its good RF characteristics and its high measurement accuracy help to ensure reliable and reproducible measurement results. The FSC features a wealth of functions for simplifying and speeding up the development and testing of RF products. Four different FSC models are available in the frequency range from 9 kHz to 3 GHz or 6 GHz. Owing to its compact design, the FSC takes up only a minimum of space on a lab bench. When installed in a rack, two FSC or one FSC and one SMC signal generator fit into the 19" rack space.

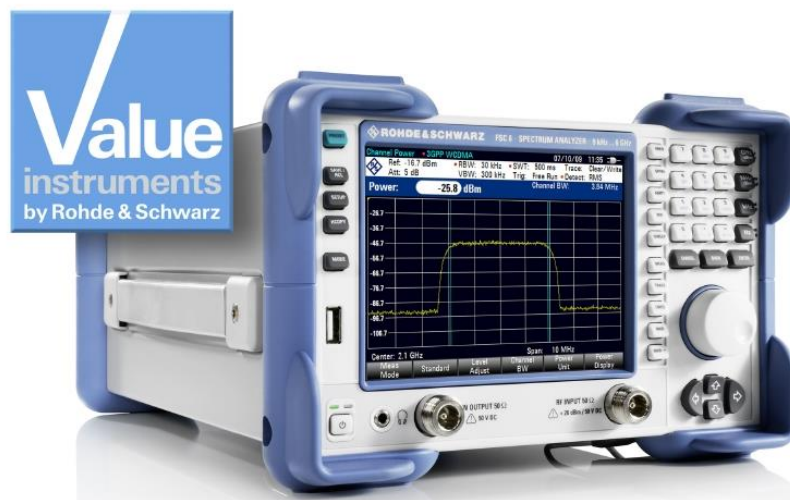

### Key Facts:

- Frequency range 9 kHz to 3 GHz
- High sensitivity up to  $-161$  dBm (1Hz)
- Resolution bandwidths 10 Hz to 3 MHz
- Measurement uncertainty  $< 1$  dB
- Internal tracking generator (depending on the model)
- Compact dimensions and low power consumption (12 W)
- Remote control vial USB or LAN

### 3.2 ZND Vector Network Analyzer



The ZND is a cost-efficient solution that offers all essential features of a professional vector network analyzer. The unidirectional ZND base model can be used to measure the S parameters  $S_{11}$  and  $S_{21}$ . The ZND can easily be upgraded to provide bidirectional measurements and to extend the frequency range up to 8.5 GHz<sup>1)</sup>. Users can tailor the instrument to their specific needs in RF component production and development. The easy-to-operate ZND is also ideal for training purposes. Multiple results can be display simultaneously on the analyzer's large touchscreen.

<sup>1)</sup> Recalibration required

**Key Facts:**

- Two-port network analyzer for unidirectional measurements up to 4.5 GHz
- Frequency range can be extended to 8.5 GHz
- Test set can be enhanced for bidirectional measurements
- Touchscreen operation
- Dynamic range up to 120 dB
- Power sweep range up to 48 dB
- Bandwidths from 1 Hz to 300 kHz

### 3.3 HMO3000 Digital Oscilloscope Series

An excellent sampling rate in combination with a large memory depth is the key for precise signal analysis. The highly resolved measurement data and the powerful zoom function expose even minor signal details. Depending on the requirements, users can choose between 300 and 500 MHz bandwidths. Three 2-channel versions and three 4-channel versions are available.

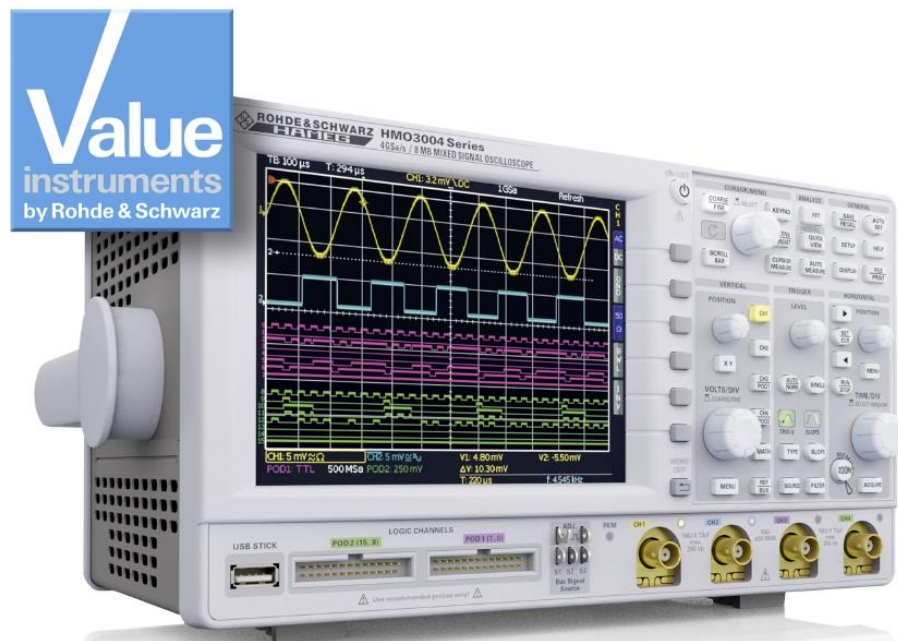

**Key Facts:**

- 4 Gsample/s realtime sampling rate
- 8 Msample memory depth
- High accuracy due to low-noise flash A/D converter
- Vertical sensitivity down to 1 mV/div
- Bandwidth upgrade via software
- 28 auto measurement parameters plus statistics and formula editor

### 3.4 HMF25xx Arbitrary Function Generator

The HMF series arbitrary function generators with 25 MHz and 50 MHz, respectively, at 250 MSample/s provide 14-bit resolution. Featuring a 9 cm QVGA-TFT display and 8 ns rise time, the HMF25xx set the standard in their class.



#### Key Facts:

- Frequency range 10  $\mu$ Hz to 25 MHz / 50 MHz (HMF2525 / HMF2550)
- Arbitrary waveform generator: 250 Msample/s, 14 bit, 256k points
- Sine, square, pulse, triangle, ramp, arbitrary, waveforms incl. standard curves (white noise, cardiac, etc.)
- Burst, sweep, gating, external trigger modulation modes: AM, FM, pulse, PWM, FSK (internal and external)

### 3.5 HM8118 200 kHz LCR Bridge

The HM8118 is a versatile auto balancing LCR bridge with high accuracy (0.05 % basic). It is a perfect tool for applications in R&D, production, service and education.

In addition to the characterization of the resistance, inductance and capacity of passive components, the HM8118 offers measurements of nonideal characteristics of real components. At the push of one button, it will measure the  $R_s$  of the series equivalent circuit or the  $R_p$  of the parallel equivalent circuit of a capacitor or an inductor. It also calculates derived parameters such as the quality factor  $Q$ , the dissipation factor  $D$ , the phase angle  $\Theta$ , as well as the complex values of the impedance  $Z$  and the admittance  $Y$ .



**Key Facts:**

- Basic accuracy 0.05 %
- Measurement functions L, C, R, |Z|, X, |Y|, G, B, D, Q,  $\Theta$ ,  $\Delta$ , M, N
- Test frequencies 20 Hz to 200 kHz
- Transformer parameter measurement
- Internal programmable voltage and current bias
- External capacitor bias up to 40 V

**3.6 HMC804x Power Supply**

One, two or three channels – HMC804x power supplies with their specifications and wide range of functions are ideal for use in development labs and industrial environments. Thanks to their high energy efficiency, the linear power supplies remain cool and quiet, even at maximum load. Practical interfaces and connectors allow users to work quickly and conveniently with the HMC804x, even in 19" racks.



**Key Facts:**

- 100 W total power output
- 10 A total current output
- Low residual ripple due to linear postregulation
- Overvoltage and overpower protection (OVP, OPP) for all outputs
- EasyArb function for user-definable V/I curves

### 3.7 HMC8012 Digital Multimeter

The HMC8012 is a 5<sup>3</sup>/<sub>4</sub>-digit digital multimeter. With a base accuracy of 0.015 % in the DC range, the multimeter shows up to three measured values on the brilliant TFT color display. The display may include a DC voltage, an AC voltage and related statistics. The multimeter offers 12 different measurement functions: VDC and IDC, True RMS VAC and IAC, frequency, 2- and 4-wire resistance, capacity, continuity, diode, temperature and performance.



**Key Facts:**

- 5<sup>3</sup>/<sub>4</sub>-digit display
- Simultaneous display of three measurements
- Up to 200 measurements per second
- 12 measurement functions: V (DC), I (DC), true RMS, V (AC), I (AC), frequency, two- and four-wire resistance, capacitance, continuity, diode test, temperature, power
- Mathematic functions: limit testing, minimum/maximum, average, offset, DC power, dB, dBm



## 4 Literature

- [1] FSC Operating Manual, PDF Version: 01 (FW2.20)
- [2] R&S® ZND/ZNC User Manual, Version 23 (V2.30), Sep 18, 2014
- [3] Mixed Signal Oscilloscope HMO series 3000 300 to 500 MHz, User Manual
- [4] Programmable HM8118 LCR Bridge, Manual

## 5 Ordering Information

Designation	Type	Order No.
<b>Spectrum analyzers</b>		
Spectrum Analyzer, 9 kHz to 3 GHz, with tracking generator	R&S®FSC3	1314.3006.13
Spectrum Analyzer, 9 kHz to 6 GHz, with tracking generator	R&S®FSC6	1314.3006.16
Spectrum Analyzer, 100 kHz to 1.6 GHz	HAMEG HMS-X	5800.2283.02
Options:		
Bandwidth Upgrade to 3 GHz	HAMEG HMS-3G	5800.2254.02
Unlock Built-in Tracking Generator	HAMEG HMS-TG	5800.2260.02
3GHz VSWR Bridge	HAMEG HZ547	3594.6424.02
<b>Vector network analyzer</b>		
Vector Network Analyzer, two ports, 4.5 GHz, N	R&S®ZND	1328.5170.92
Options:		
Extended Frequency Range, unidirectional, 8.5 GHz	R&S®ZND-K1 <sup>2)</sup>	1328.5306.02
Full Test Set, base unit, bidirectional, 4.5 GHz	R&S®ZND-K5 <sup>2)</sup>	1328.5312.02
Full Test Set, base unit, bidirectional, 8.5 GHz	R&S®ZND-K6 <sup>2)</sup>	1328.5329.02
Extended Frequency Range, full test set, bidirectional, 8.5 GHz	R&S®ZND-K8	1328.5412.02
<sup>2)</sup> Recalibration required For suitable calibration kits and measurement cables, please see the R&S®ZND product brochure or data sheet		
<b>Digital oscilloscopes</b>		
50 MHz 2-Channel Digital Oscilloscope	HAMEG HMO1002	5800.2825.02
70 MHz Upgrade Option for HMO1002	HAMEG HV572	5800.2883.02
100 MHz Upgrade Option (requires HV572) for HMO1002	HAMEG HV712	5800.2902.02
100 MHz Upgrade Option for HMO1002	HAMEG HV512	5800.2890.02
70 MHz 2-Channel Digital Oscilloscope	HAMEG HMO722	5800.0000.02
70 MHz 4-Channel Digital Oscilloscope	HAMEG HMO724	5800.0016.02

Designation	Type	Order No.
100 MHz 2-Channel Digital Oscilloscope	HAMEG HMO1022	5800.0022.02
100 MHz 4-Channel Digital Oscilloscope	HAMEG HMO1024	5800.0039.02
150 MHz 2-Channel Digital Oscilloscope	HAMEG HMO1522	5800.0045.02
150 MHz 4-Channel Digital Oscilloscope	HAMEG HMO1524	5800.0051.02
200 MHz 2-Channel Digital Oscilloscope	HAMEG HMO2022	5800.0068.02
200 MHz 4-Channel Digital Oscilloscope	HAMEG HMO2024	5800.0074.02
300 MHz 2-Channel Mixed Signal Oscilloscope	HAMEG HMO3032	5800.1835.02
300 MHz 4-Channel Mixed Signal Oscilloscope	HAMEG HMO3034	5800.1841.02
400 MHz 2-Channel Mixed Signal Oscilloscope	HAMEG HMO3042	5800.1858.02
400 MHz 4-Channel Mixed Signal Oscilloscope	HAMEG HMO3044	5800.1864.02
500 MHz 2-Channel Mixed Signal Oscilloscope	HAMEG HMO3052	5800.1870.02
500 MHz 4-Channel Mixed Signal Oscilloscope	HAMEG HMO3054	5800.1887.02
350 MHz 2-Channel Digital Oscilloscope	R&S®RTM2032	5710.0999.32
350 MHz 4-Channel Digital Oscilloscope	R&S®RTM2034	5710.0999.34
500 MHz 2-Channel Digital Oscilloscope	R&S®RTM2052	5710.0999.52
500 MHz 4-Channel Digital Oscilloscope	R&S®RTM2054	5710.0999.54
<b>Signal generators</b>		
25 MHz Arbitrary Function Generator	R&S®HMF2525	3594.4509.02
50 MHz Arbitrary Function Generator	R&S®HMF2550	3594.4515.02
Signal Generator	R&S®SMC100A	1411.4002.02
RF-Path, 9 kHz to 1.1 GHz	R&S®SMC-B101	1411.6505.02
RF-Path, 9 kHz to 3.2 GHz	R&S®SMC-B101	1411.6605.02
<b>LCR Measurement Bridge</b>		
200kHz LCR Bridge	HAMEG HM8118	3594.4480.02

Designation	Type	Order No.
<b>Power supplies</b>		
Power Supply, 99 W, 0 to 32 V, 3 channels, 33 W / channel, 3 A (max.), GPIB interface	R&S®HMC8043-G	5800.2760.02
Power Supply, 99 W, 0 to 32 V, 3 channels, 33 W / channel, 3 A (max.)	R&S®HMC8043	5800.2754.02
Power Supply, 100 W, 0 to 32 V, 2 channels, 50 W / channel, 5 A (max.), GPIB interface	R&S®HMC8042-G	5800.2748.02
Power Supply, 100 W, 0 to 32 V, 2 channels, 50 W / channel, 5 A (max.)	R&S®HMC8042	5800.2731.02
Power Supply 100 W, 0 to 32 V, 1 channel, 10 A (max.), GPIB interface	R&S®HMC8041-G	5800.2725.02
Power Supply, 100 W, 0 to 32 V, 1 channel, 10 A (max.), GPIB interface	R&S®HMC8014	5800.2719.02
Arbitrary Power Supply, 3 channels 2x 0 to 32 V / 0 to 2 A, 1x 5V / 0 to 2 A	HAMEG HM8143	3594.3360.02
Programmable 2-Channel Power Supply	HAMEG HMP2020	5800.0122.02
Programmable 3-Channel Power Supply	HAMEG HMP2030	5800.0139.02
Programmable 4-Channel Power Supply	HAMEG HMP4030	5800.2160.02
Programmable 5-Channel Power Supply	HAMEG HMP4040	5800.2177.02
<b>Multimeters</b>		
Digital Multimeter	HAMEG HMC8012	5800.2025.02

## Appendix

### A Bandfilter Measurements on the ZND without the S-Parameter Wizard

Measurement steps:

- Press the *PRESET* key to restore the ZND to a predefined default state.
- Use the *START*, *STOP* or *Center*, *SPAN* keys to define the frequency range.
- Press the *SWEEP* key and enter the desired number of measurement points under *Number of Points*.
- Press the *POWER BW AVG* key and enter *Power 0dBm*.
- On the *Bandwidth* tab, define the desired bandwidth, e.g. 1 kHz (large bandwidth -> reduced dynamic range with fast measurement speed, small bandwidth -> high dynamic range with slow measurement speed).
- Press the *TRACE CONFIG* key and use *Add Trace* to generate a second trace.
- Set *Active Trace* to *Trc1*.
- Press the *DISPLAY* key and select *Split All*.
- Press the *MEAS* key and select *S11*. The reflection is now displayed on the top half of the screen and the transmission on the bottom half.
- Calibration: Press the *CAL* key. On the *Start Cal* tab, use *Start... (Manual)* to start the calibration.
- The transmission and reflection characteristics of the filter are measured in the forward direction. Therefore, the *One Path Two Ports* calibration must be selected.

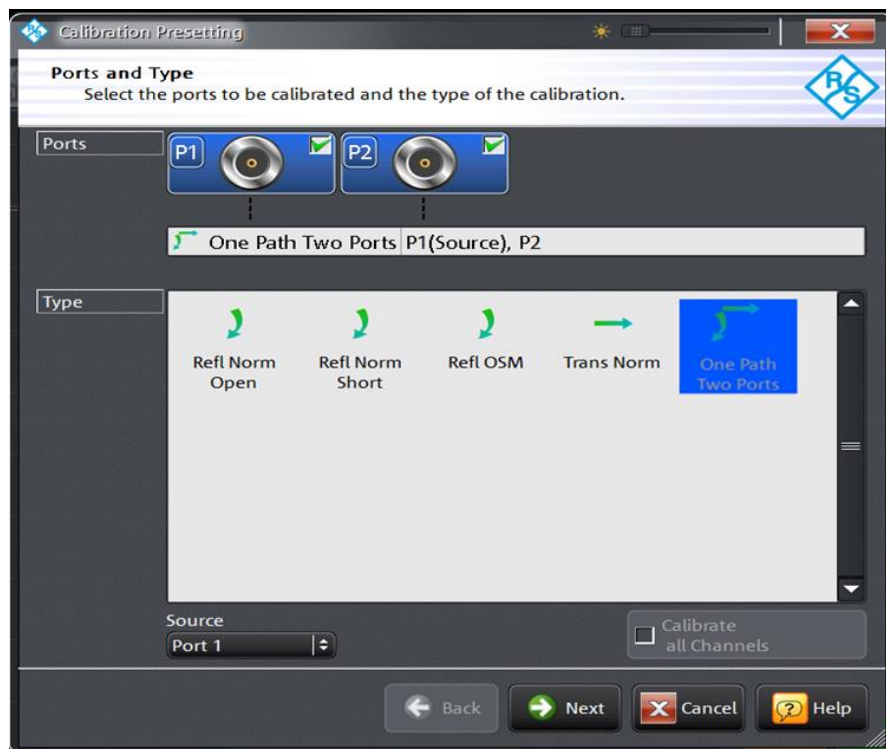

Fig. 5-1: Selecting the possible calibration types for a unidirectional measurement.

Note:

If the ZND is equipped with the R&S® ZND-K5 or R&S® ZND-K8 bidirectional measurement options, it is recommended that the **Through / Open / Short / Match (TOSM)** calibration be used. The advantage of this calibration type lies in its improved measurement accuracy through the use of a vector 12-term error correction. This includes the RF characteristics of the second test port in the measurement and as a result reduces its influence on the measurement results. The degree of influence that port 2 has on the results depends on how the filter output is adapted and how great the insertion loss is.

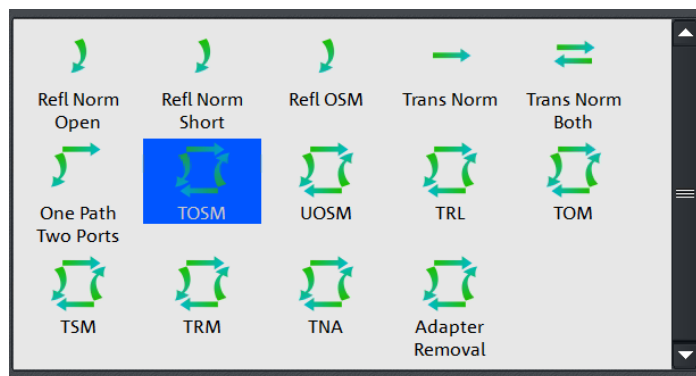

Fig. 5-2: Selecting the TOSM calibration.

- Select the connector type and gender for port 1, port 2 and select the calibration kit being used. If the calibration kit is not listed, use *Import Calkit* to load the calibration kit data into the ZND. Press *Start* to start the calibration routine.

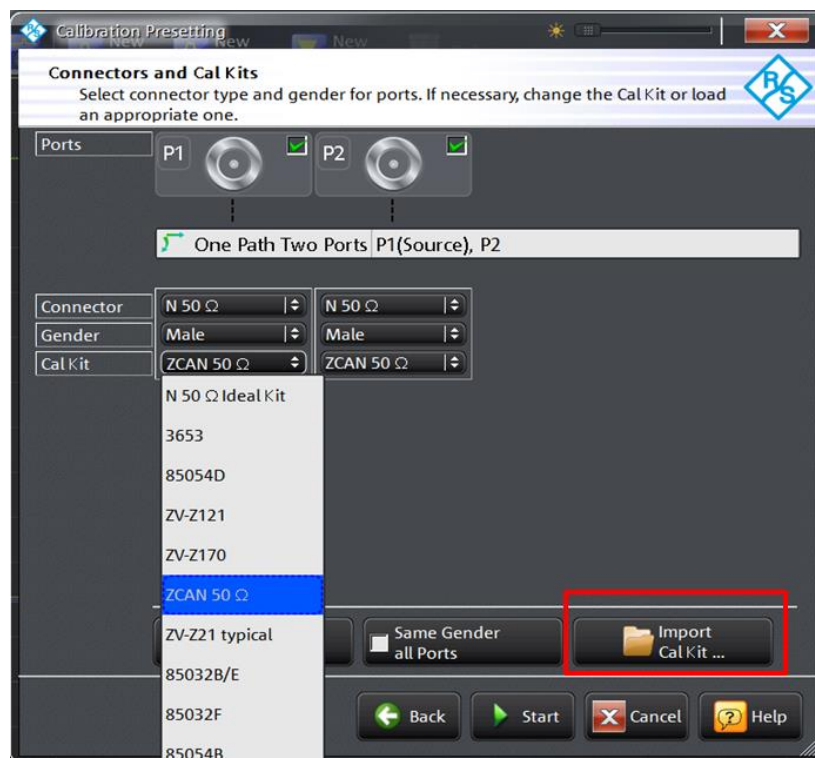

Fig. 5-3: Selecting the connector type and the calibration kit.

- Select the four calibration standards Open, Short, Match and Through in sequence, then connect the appropriate standard to port 1, or in the case of the through standard, create a through connection between ports 1 and 2. (Note: "Port 1" and "port 2" refer here to the ends of the test cable being used.)

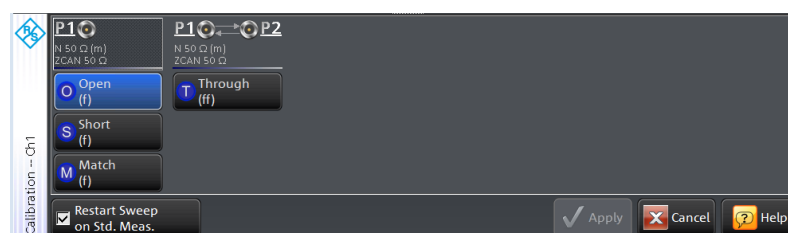

Fig. 5-4: Selecting the calibration standard.

- Use *Start CAL Sweep* to start the calibration. Important note: The calibration standards must not be swapped out during the calibration. This is the only way to ensure that the vector error correction returns correct results.

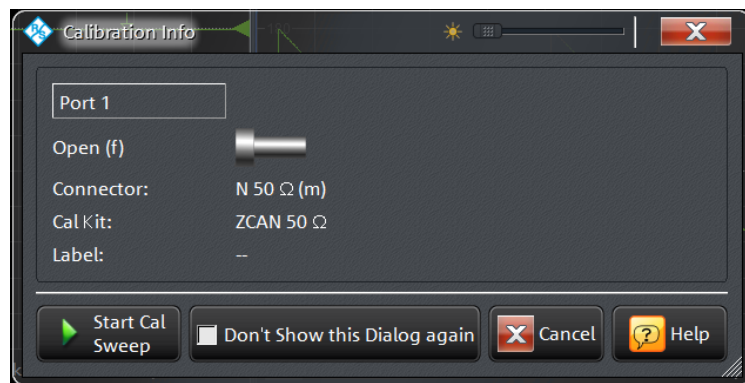

Fig. 5-5: Starting the calibration.

- Once all four calibration steps are completed, end the calibration with *Apply*.

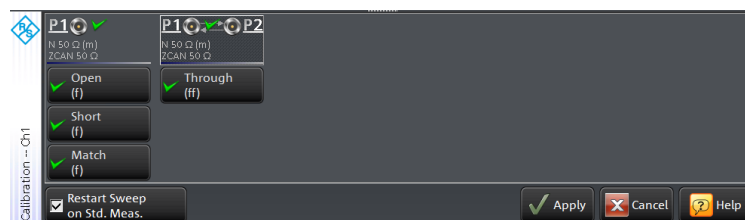

Fig. 5-6: The calibration with all calibration standards was completed.

- Connect the filter between the two test cables as shown in Fig. 2-18.
- The reflection (S11) is shown in the upper half of the split screen and the transmission (S21) in the lower half (Fig. 5-7). Press the *SCALE* key and adjust the y-axis scaling as needed.

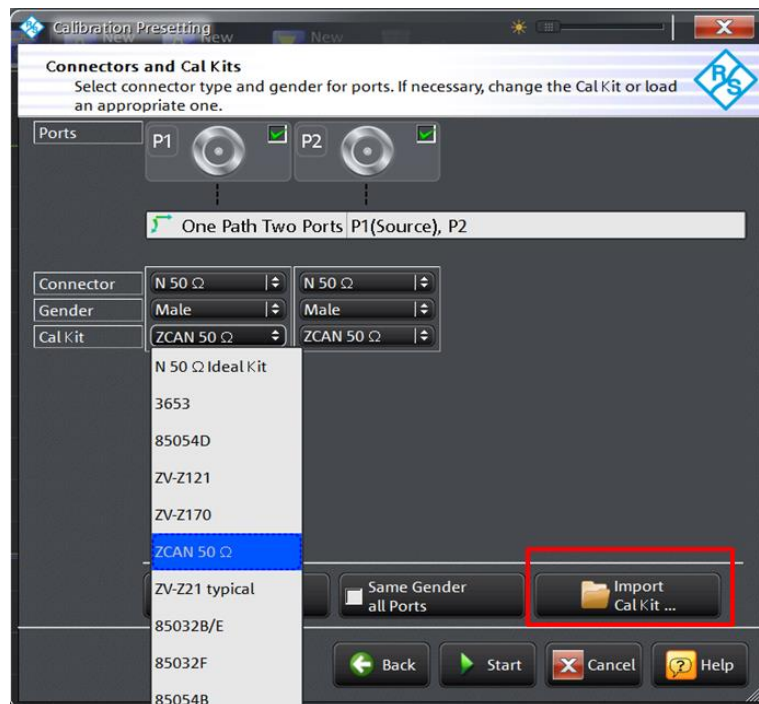

Fig. 5-7: Bandpass filter measurement with display of reflection and transmission.



- Press the *DISPLAY* key and select *Overlay All*. Both traces are now displayed in one diagram (Fig. 5-8). The superimposed reflection and transmission measurements show that the input signal is reflected significantly less in the passband than it is in the stopband. (The greater the return loss, displayed in dB, the better the filter is adapted and the less the input signal is reflected at the filter input.)



Fig. 5-8: Reflection and transmission in one diagram.

- Trace 2* must be active in order to measure the filter center frequency, bandwidth, quality, etc. This is checked by looking at the text highlighted in blue at the top of the screen in the example (see Fig. 5-8). If trace 2 is not active, press the *Trace* key and select *Active Trace Trc2*.
- Press the *MARKER* key and select the *Bandfilter* tab.
- Bandwidth*: Enter 3 dB and then enable *Bandpass Ref to Max*. As shown in Fig. 5-9, all relevant values for the bandpass are displayed at the top right corner of the screen.



Fig. 5-9: Display of all relevant values for a bandpass.

- By default, the geometric mean (marker M4)  $f_0 = \sqrt{f_H \cdot f_L}$  ( $f_L=M2$ ;  $f_H=M3$ ) is displayed for the center frequency; in this case:  $f_0= 196.023953$  MHz ( Fig. 5-9). To display the arithmetic mean:
  - Press the *SETUP* key and select *System Config...*
  - Select the *Advanced* tab and disable *Geometric Calculation of Bandfilter Center*. In place of the geometric mean, the absolute center frequency of 210.33 MHz is now displayed (Fig. 5-10).

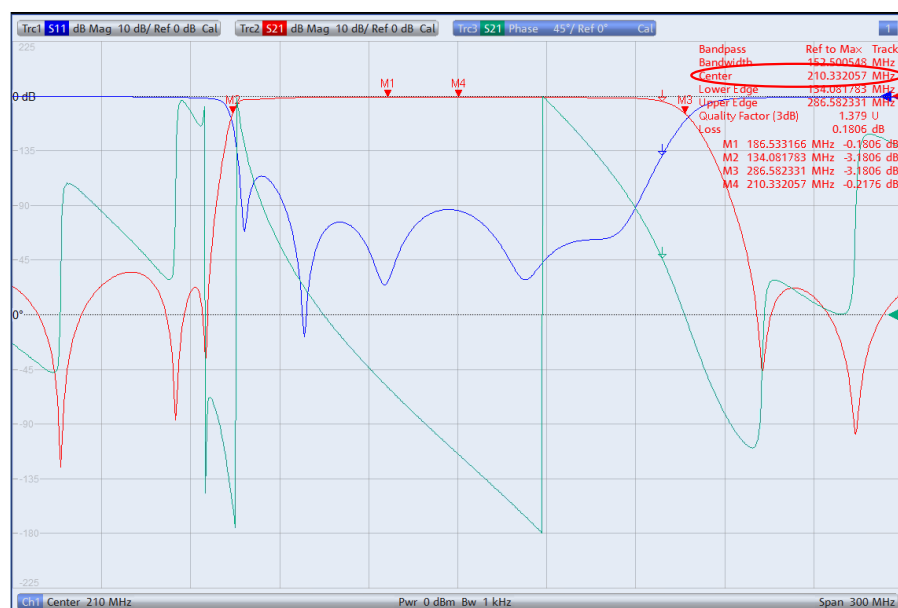

Fig. 5-10: Display of the absolute bandpass center frequency.

- In addition to the transmission value, the phase response can also be displayed (Fig. 5-11). Press the *TRACE CONFIG* key and use *Add Trace* to generate another trace. Press the *FORMAT* key and select *Phase*.

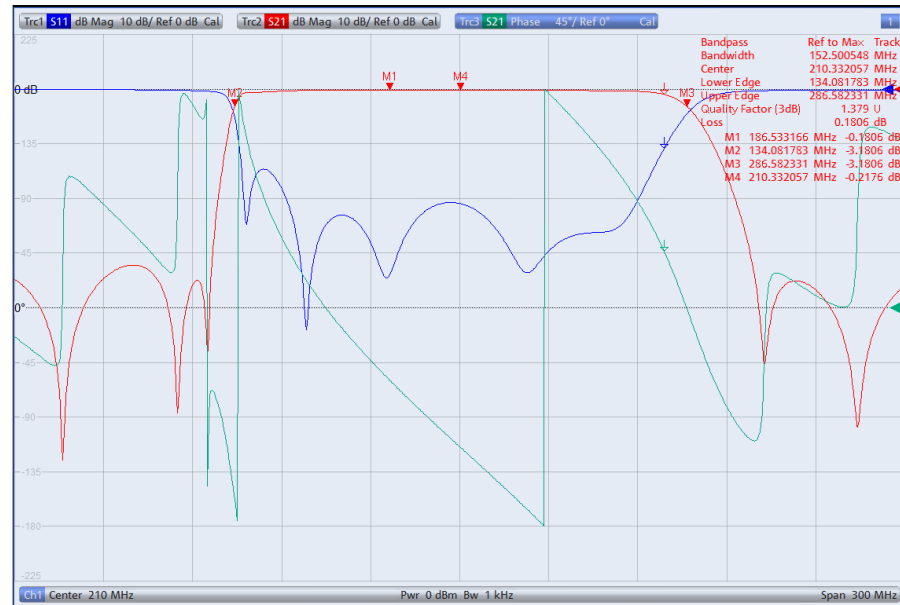

Fig. 5-11: Additional phase response measurement for S21 (green trace).

- To display all three measured values (reflection, transmission and phase) in separate diagrams (Fig. 5-12), press the *DISPLAY* key and select *Split All*.

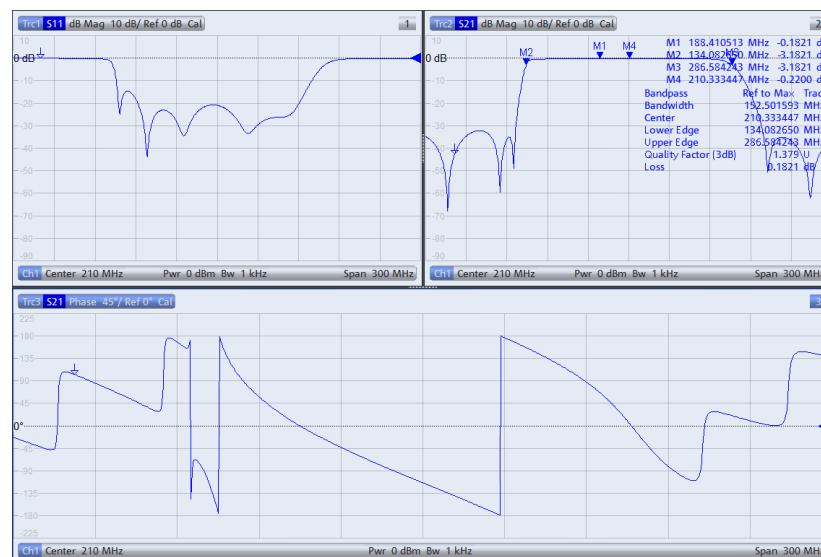

Fig. 5-12: Display of all key filter parameters in split screen.

## Rohde & Schwarz

The Rohde & Schwarz electronics group offers innovative solutions in the following business fields: test and measurement, broadcast and media, secure communications, cybersecurity, radiomonitoring and radiolocation. Founded more than 80 years ago, this independent company has an extensive sales and service network and is present in more than 70 countries.

The electronics group is among the world market leaders in its established business fields. The company is headquartered in Munich, Germany. It also has regional headquarters in Singapore and Columbia, Maryland, USA, to manage its operations in these regions.

## Regional contact

Europe, Africa, Middle East  
+49 89 4129 12345  
[customersupport@rohde-schwarz.com](mailto:customersupport@rohde-schwarz.com)

North America  
1 888 TEST RSA (1 888 837 87 72)  
[customer.support@rsa.rohde-schwarz.com](mailto:customer.support@rsa.rohde-schwarz.com)

Latin America  
+1 410 910 79 88  
[customersupport.la@rohde-schwarz.com](mailto:customersupport.la@rohde-schwarz.com)

Asia Pacific  
+65 65 13 04 88  
[customersupport.asia@rohde-schwarz.com](mailto:customersupport.asia@rohde-schwarz.com)

China  
+86 800 810 82 28 | +86 400 650 58 96  
[customersupport.china@rohde-schwarz.com](mailto:customersupport.china@rohde-schwarz.com)

## Sustainable product design

- Environmental compatibility and eco-footprint
- Energy efficiency and low emissions
- Longevity and optimized total cost of ownership



This and the supplied programs may only be used subject to the conditions of use set forth in the download area of the Rohde & Schwarz website.

R&S® is a registered trademark of Rohde & Schwarz GmbH & Co. KG. Trade names are trademarks of the owners.