

# *MegaPulse*

IMPULSE TESTER

# *CODE 360*

## Instruction Manual

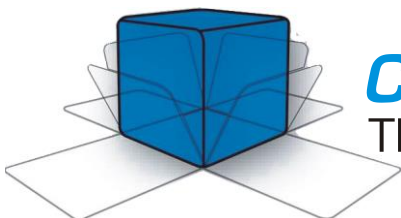

***COMPLIANCE WEST USA***

The blue box that tests. And tests.



*Dear Customer:*

*Congratulations! Compliance West USA is proud to present you with your MegaPulse Code 360 Impulse Tester. Your instrument features a groundbreaking logic-controlled circuit design and ergonomic front panel and represents the latest in high voltage impulse testing.*

*To fully appreciate all the features of your new instrument, we suggest that you take a few moments to review this manual. Compliance West USA stands by your instrument with a full one-year warranty. If the need arises, please don't hesitate to call on us.*

*Thank you for your trust and confidence.*



# Table of Contents

Introduction to Impulse Testing with the MegaPulse PF series tester .....	1
Safety Precautions .....	1
Test Personnel .....	1
Testing Area .....	1
Safety Techniques .....	2
Safety Markings .....	2
Using the MegaPulse Impulse Tester .....	3
Section 2 .....	4
Getting Started .....	4
Unpacking and Inspection .....	4
Packaging .....	4
Product Package for DF-80PF DSW Tester .....	4
Returning the Instrument .....	4
AC Line Voltage Requirements .....	5
Fuse Replacement .....	5
Section 3 .....	6
Specifications and Controls .....	6
Front and Rear Panel Features .....	7
Section 4 .....	11
Operating Instructions .....	11
External Interlock .....	11
Front Keyboard and Voltage Knob Enable .....	11
Discharging Residual Voltage .....	11
Polarity Pulse Selection .....	12
Voltage Set Point Adjustment .....	12
Charge and Trigger a Pulse .....	12
Testing .....	13
Section 5 .....	14
Maintenance and Calibration .....	14
Service Information .....	14
General Maintenance .....	14
Cleaning .....	14
Calibration Information .....	14
Section 6 .....	16
Technical Assistance .....	16



## Section 1

# Introduction to Impulse Testing with the MegaPulse PF series tester

The impulse test is designed to simulate impulse surges which occur in everyday life due to nearby lightning strikes, switching transients, and other high-frequency faults on the power distribution network. Impulse testing is the fundamental method for empirical verification of the adequacy of insulation. Other methods of ensuring adequate insulation (AC or DC Dielectric Withstand testing, measurement of over-surface creep age, through-air clearance, or distance-through-insulation) are all extrapolated from the results of impulse testing. The impulse test is performed to ensure that the insulation in question will be able to function properly when subjected to similar impulse surges in the field.

### Safety Precautions

The impulse withstand test can generate voltages in excess of 5000V peak at potentially lethal current levels. Currents of as little as 5mA at 120 volts can cause death; the MegaPulse can deliver currents of more than 500 Amps peak for very short time duration. The potential for serious injury or death exists and personnel should be aware when they conduct this test.

### Test Personnel

Personnel require special training to conduct the impulse test. They should understand electrical fundamentals clearly and be aware that high voltage is adept and creative at completing a path to ground. Instructions should include a warning against any metal jewelry. Operators should not allow others in the testing area, especially when tests are being conducted. Organization is to be stressed. The operator should keep the area free of unused leads and equipment.

### Testing Area

The area used for conducting the impulse test should be as remote as possible from normal production line activities. Only personnel conducting the test should be allowed in the area, and it should be taped or roped off to preclude casual entry by other employees. In addition, the area should be marked "WARNING - HIGH VOLTAGE TESTING" or the equivalent to warn others of the nature of the testing taking place.

The bench being used should be non-conductive, and any exposed metal parts should be tied together and grounded. If a conductive surface must be used, it should be grounded. Because of sparking during an impulse test failure, it is not safe to conduct impulse testing in combustible atmospheres.

It is imperative that a good ground be provided to the MegaPulse tester. Before connecting the equipment, ensure that the building wiring provides a low-resistance ground. If the MegaPulse tester is used on a high-resistance grounding circuit, dangerous high voltages may be present to the operator. In addition, the power to the Testing Area should be provided with an easily reached shutoff switch which can be actuated by personnel outside the Area if needed.

**CAUTION:** Plug on power cord is disconnect device. The power to the Testing Area should be provided with an **easily reached shutoff switch** which can be actuated by personnel outside the area if needed.



## Safety Techniques

The high voltage circuit of the MegaPulse Code 360 can be shut off at any time by turning OFF the rear power switch. Always press TRIGGER to discharge the tester before turning OFF.









The MegaPulse tester is provided with a digital **VOLTAGE ADJUST** knob on the front panel. This voltage setting should always confirm by pressing the VOLTAGE ADJUST knob before start any testing.

The MegaPulse tester is provided with a **CHARGE** switch that is in the unarmed "Standby" setting when the tester is first turned ON. When the yellow **CHARGE** button is lit, the tester will not provide high voltage until the **CHARGE** Button and the **TRIGGER** Button have been pressed in order. To prevent inadvertent operation, the operator should be instructed not to press the **CHARGE** Button until the test is ready.

The MegaPulse tester has been designed for one-touch operation with the right hand. If possible, it should be set up to the left and in front of the equipment under test. The equipment under test should be connected to the MegaPulse tester and then left alone by the operator. After the operator is clear of the Tester and the equipment under test, the operator should turn the rear-panel power switch to ON, press the **CHARGE** Button, adjust the voltage to the desired level (as displayed on the front panel meter), then press the **TRIGGER** Button, with his right hand. This will allow the greatest separation between the operator and the test being conducted. Note that the CHARGE process will stop after 2 minutes if the TRIGGER button is not pressed.

The MegaPulse tester is designed to bleed the high voltage away after the test has concluded. In order to ensure that any voltage present in the equipment being tested has been completely bled away, the operator should not unplug the equipment under test from the MegaPulse until the front panel meter reads a safe level (40 volts or less is generally considered a safe level). Pressing the TRIGGER button before disconnecting main power (or turning the equipment off) will ensure that the internal capacitors are discharged as much as possible.

## Safety Markings

	Direct Current		On (Power)
	Alternating Current		Off (Power)
	Refer to instructions		Caution, possibility of electric shock
	Earth (ground) TERMINAL		High Voltage



## Using the MegaPulse Impulse Tester

The impulse test involves high voltage and caution should be exercised when using the tester. The **RETURN** lead is referenced to building ground when properly connected. However, both the **OUTPUT** and **RETURN** leads must always be treated as Hazardous whenever the power switch of the MegaPulse is in the ON position.

The MegaPulse PF tester is designed to bleed the high voltage away after the test has concluded. In order to ensure that any voltage present in the equipment being tested has been completely bled away, the operator should not unplug the equipment under test from the MegaPulse until the front panel meter reads a safe level (40 volts or less is generally considered a safe level). Pressing the TRIGGER button before disconnecting main power (or turning the equipment off) will ensure that the internal capacitors are discharged as much as possible.

### CAUTION

**High voltage generated by the MegaPulse tester is exposed during this test. A risk of shock exists. Exercise care when using the MegaPulse unit.**

Pressing the POLARITY switch on the front panel can change the polarity of the output waveform. The polarity is Normal when the **NOR** indicator is lit. In this case, the high voltage will appear on the **OUTPUT** as a positive pulse relative to the **RETURN** jack. When the polarity switch is in the Reverse position (**REV** indicator is lit), the high voltage will appear on the **OUTPUT** as a negative pulse relative to the **RETURN** jack. The polarity switch only operates when the **CHARGE LED** is lit, i.e. the output is not charged.

Note that the voltage meter may indicate that some residual voltage is present on the main storage capacitor, even when the tester is first turned ON. This is due to inherent charging of the internal capacitors. Pressing the **TRIGGER** switch will discharge the capacitors (be sure not to touch the output and return leads when pressing the trigger switch).

Note that the peak amplitude of the measured output waveform is proportional to the voltage that is read on the front panel of the MegaPulse, but it will always be somewhat lower. This is because the meter on the MegaPulse is measuring the voltage on the main impulse storage capacitor. This voltage will intentionally dissipate to some extent before reaching the output leads. Therefore, it is important to measure the peak amplitude of the output waveform, and adjust the output of the MegaPulse accordingly.

Determination of Passing and Failing results can prove difficult. To obtain the most accurate results, it is generally necessary to perform multiple impulse tests on a few different test samples (that have adequate insulation to pass the impulse test). Take note of the impulse waveshape, amplitude, and duration. Also note how much variance there is in the waveshape from test to test. Also (if possible), perform impulse testing on some test samples that are known to have inadequate (or damaged) insulation. Take note of the impulse waveshape, amplitude, and duration, when an insulation breakdown occurs.

## **Section 2**

### **Getting Started**

This manual contains complete operating, maintenance and calibration information for the Compliance West USA MegaPulse Code 360 Impulse Tester.

Your tester is warranted for a period of one year upon shipment of the instrument to the original purchaser.

This section contains information for the unpacking, inspection, preparation for use and storage of your Compliance West product.

### **Unpacking and Inspection**

#### **Packaging**

Your Tester is shipped in a special protective container that should prevent damage to the instrument during shipping. Check the shipping order against the contents of the container and report any damage or short shipment to Compliance West USA. Please save the shipping carton and packing material for the carrier's inspection. Our customer support department will assist you in the repair or replacement of your instrument. Please do not return your product without first notifying us and receiving an RMA (return material authorization) number. To receive an RMA number, please contact our customer support department at (1-800-748-6224).

#### **Product Package for Code 360 Tester**

	<b>Description</b>	<b>Part Number</b>
Code 360	MegaPulse Tester	
	User Manual	
	High Voltage Test Lead, Red	00-HVL7R (Qty 1)
	High Voltage Test Lead, Black	00-HVL7B (Qty 1)
	18 AWG AC Power Cord	70-101
TestMinder (Optional)	User Manual	
	Software CD	MegaPulse TestMinder P/PF
	RS232 cable	60-134
	USB D box	00-USBD BOX
	USB cable	60-221

### **Returning the Instrument**

When it's necessary to return the instrument for servicing or calibration, repackage the instrument in its original container, please include all accessories and test leads. Indicate the nature of the problem or type of service needed. Also, please mark the container as "FRAGILE" to insure proper handling.

If you do not have the original packaging materials, please follow these guidelines:

- Wrap the instrument in a bubble pack or similar foam including all the included cables.
- Use a strong double-wall container that is made for shipping instrumentation.
- Use a layer of shock absorbing material 70 to 100mm (3 to 4 inch) thick around all sides of the instrument. Protect the control panel with cardboard.
- Seal the container securely.
- Mark the container as "FRAGILE" to insure proper handling.

- Please contact Compliance West USA (1-800-748-6224) to inform about the service for your instrument.

## **AC Line Voltage Requirements**

AC line voltage requirements for your Tester are noted on the rear panel of the instrument. Do not connect the instrument to a different voltage source. The cord packaged with your MegaPulse Tester is for use in the United States. If another power cord must be used, the cord must be rated for the maximum current noted on the rear panel. It must also meet the requirements of IEC 227 or IEC 245, and mains cords that are certified or approved by any recognized national test house are regarded as meeting this requirement.

## **Fuse Replacement**

There is a user-replaceable fuse (F1) located on the rear panel of the instrument. It is located behind a door in the Power Inlet-Power Switch-Fuse Holder device. The fuse rating is noted on the rear panel. Do not attempt to replace it with a fuse of any other rating.

Use the following procedure to replace the fuse F1:

1. Turn the power switch to the OFF position.
2. Unplug the instrument from the source of supply.
3. Remove the power inlet cord from the instrument.
4. Using a small screwdriver, pry open the fuse holder door.
5. Replace the fuse with a new one of the correct rating.
6. Replace the fuse holder door and power inlet cord.

## Section 3

### Specifications and Controls

Specifications for the MegaPulse Code 360 are listed in the table below and the component designations are shown in **Error! Reference source not found.**

<b>ELECTRICAL</b>	
Output Voltage:	5000 V tolerance $\pm 1\%$
Main Capacitance:	35 $\mu\text{F}$ $\pm 3\%$ (Dry capacitor type, 2.5 million cycles life)
Main Inductance:	50 mH $\pm 3\%$
Energy Output:	360J $\pm 5\%$ with 50 $\Omega$ load at the Output.
Voltage Control:	Digital Set point adjusted by frontal VOLTAGE knob or by PC TestMinder.
Polarity Control:	Positive and Negative. Alternating control available with optional computer control.
Voltage Display:	4 Digit LED Display.
Voltage Meter resolution:	2V
Duty Cycle:	1 pulse every 20s.
Input Voltage:	120V~ 50/60Hz 230V~ 50/60Hz (CE for EU)
<b>ENVIROMENTAL</b>	
Operating Temperature:	15 - 40 °C
Relative Humidity Range:	0 - 90% non-condensing
Altitude	0 - 3000 meters
<b>GENERAL</b>	
Dimensions:	17" wide x 10.5" high x 17" in deep
Weight:	45 lbs. approx.

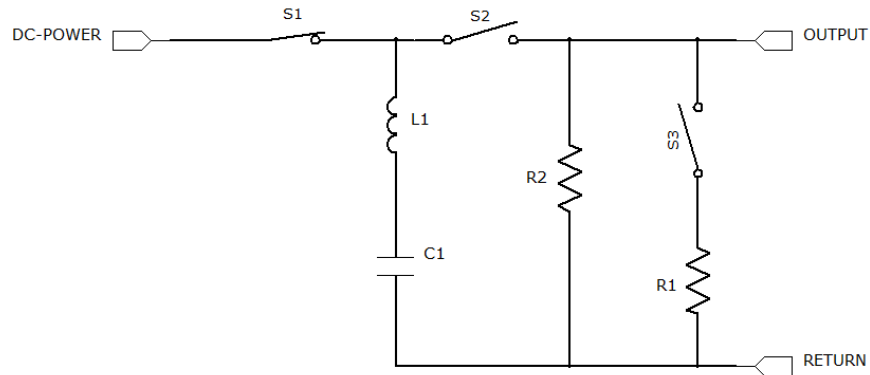

**Figure 1 Code 360 Output Circuit**

Model	Max. Voltage	C1	R1*	R2	L1
Code 360	5000V	35 $\mu\text{F}$	50 $\Omega$	47k $\Omega$	50mH

\*R1 only for waveform verification

## Front and Rear Panel Features

Before using your Tester, take a few minutes to become familiar with the use of its controls, indicators and connectors. The front panel features of the MegaPulse are shown in Figure 2 and described in Table 1. The rear panel features of the MegaPulse are shown in Figure 3 and described in Table 2

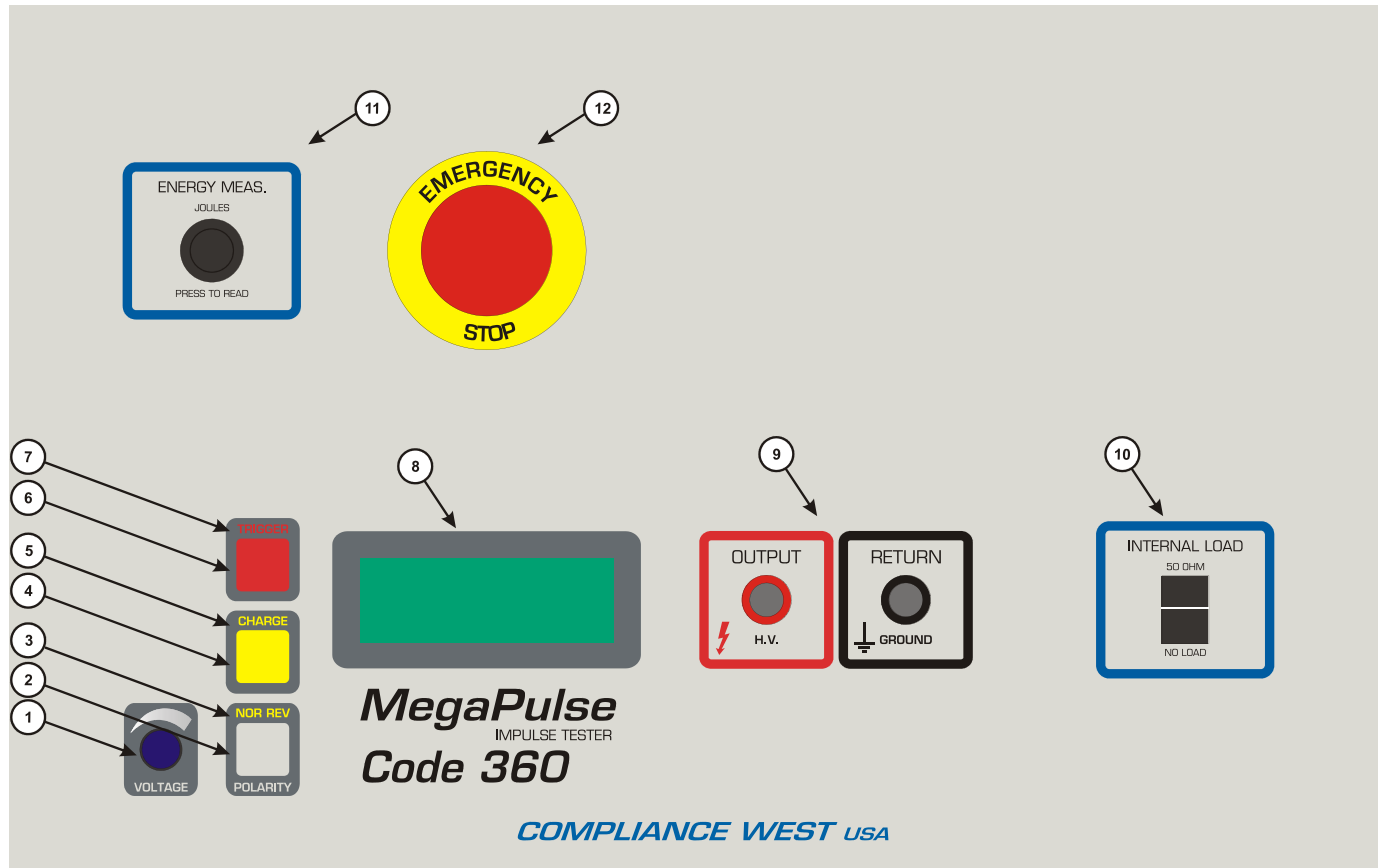
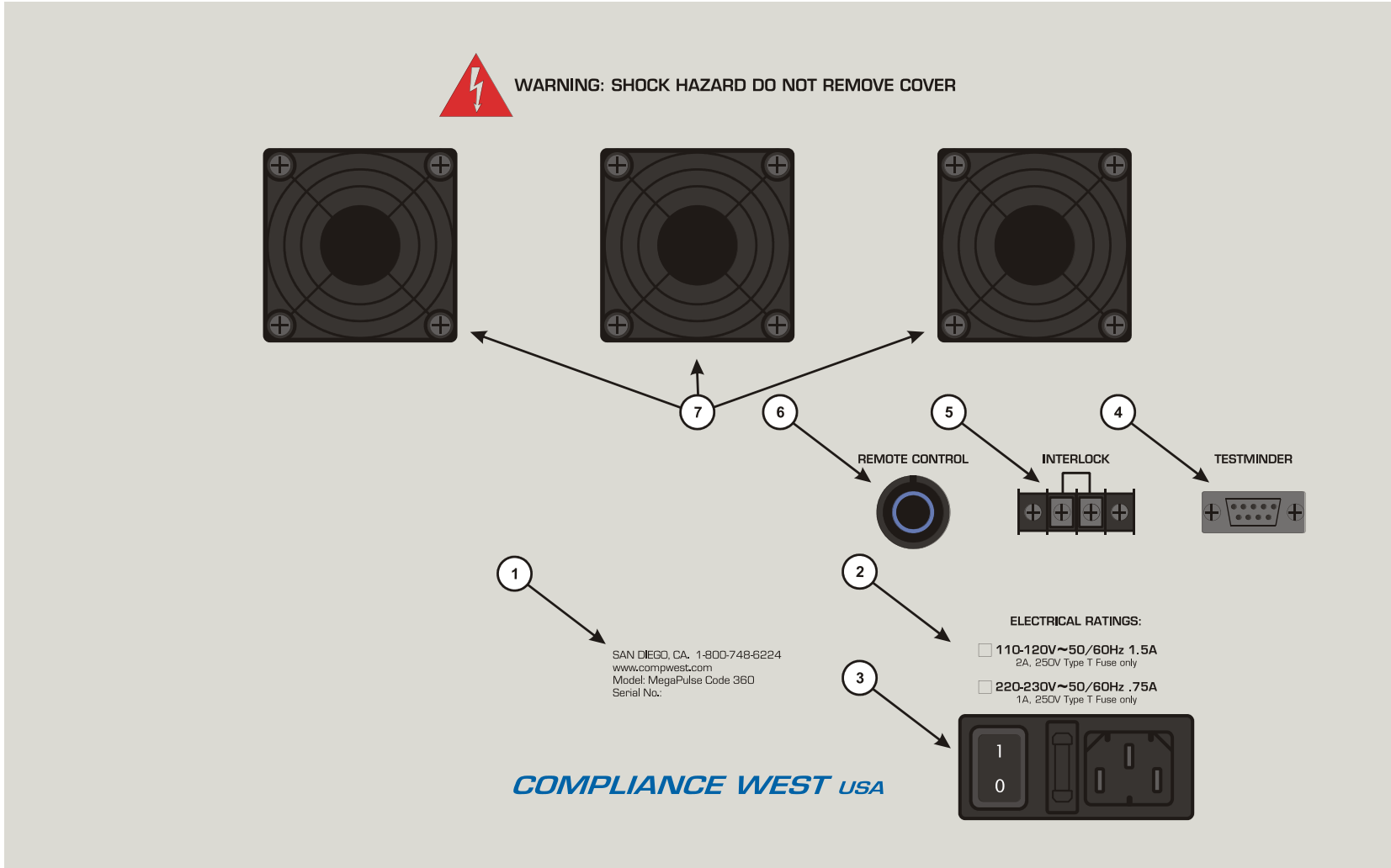

Figure 2. MegaPulse Code 360 Front Panel

**Table 1 MegaPulse Code 360 Front Panel Features**

ITEM	NAME	FUNCTION
1	VOLTAGE Adjust Knob	Adjust the digital voltage set point in the tester. Press the voltage knob to display the voltage set point. This setting will blink for a few seconds on the front meter. Turn Clockwise to increase the setting Voltage Setting Point before pressing <b>CHARGE</b> button
2	POLARITY switch	Toggles the output pulse polarity from Normal to Reverse, Normal for positive and Reverse for Negative, the pulse will appear on the Output jack relative to the return jack The polarity switch only operates when the <b>CHARGE</b> indicator is lit and the voltage on the display meter is less than 180V. The polarity is Normal when the <b>NOR</b> indicator is lit and Reverse when the <b>REV</b> indicator is lid.
3	NOR REV indicator	Indicates the state of the Output Polarity switch. <b>NOR</b> indicates Normal (Positive) position. <b>REV</b> indicates Reverse (Negative) position.
4	CHARGE switch	Starts the charge process of the tester capacitor. The <b>CHARGE</b> indicator will turn off after the <b>CHARGE</b> switch is pressed and the <b>TRIGGER</b> indicator will turn on. The charge process will stop after 2 minutes if the <b>TRIGGER</b> button is not pressed.
5	CHARGE indicator	This Yellow indicator is lit to show that pressing the <b>CHARGE</b> switch is the next logical step in a test sequence. <b>CHARGE</b> indicator is lit when the tester is turn ON an after pressing <b>TRIGGER</b> button. <b>CHARGE</b> indicator will go out after pressing <b>CHARGE</b> button. <b>CHARGE</b> and <b>TRIGGER</b> Indicators will be blinking if the Interlock Switch is open. (Only testers with Interlock Switch Option)
6	TRIGGER switch	Triggers the output impulse waveform. The impulse waveform will appear across the output leads.
7	TRIGGER indicator	This Red indicator is lit to show that the tester can be triggered. <b>TRIGGER</b> indicator is lit for 2 minutes after the <b>CHARGE</b> button is pressed. <b>TRIGGER</b> indicator will go out after pressing <b>TRIGGER</b> button. <b>TRIGGER</b> and <b>CHARGE</b> Indicators will be blinking if the Interlock Switch is open (Only testers with Interlock Switch Option) <b>TRIGGER</b> indicator will blink at when the Voltage. This effect will remain on until the <b>TRIGGER</b> switch is pressed. (Only testers with PC Interface option)
8	VOLTAGE meter	Displays the output voltage set point. The voltage reading will increase from zero to the voltage set point when the <b>CHARGE</b> button is pressed. Note that the Voltage meter may indicate that some residual voltage is present on the main storage capacitor, even when the tester is first turned ON. This is due to inherent charging of the internal capacitors. Pressing the <b>TRIGGER</b> switch will discharge the capacitors. Note that the peak amplitude of the measured output waveform is proportional to the voltage that is read of the front panel of the MegaPulse, but it will always be somewhat lower. This is because the meter on the MegaPulse is measuring the voltage on the main impulse storage capacitor. This voltage will intentionally dissipate to some extent before reaching the output leads. The meter will start to flash at <b>5050V</b> to indicate that voltage is in the maximum limits. If unit includes PC Interface and the Keyboard is locked, the display will show OFF when a button is pressed.
9	OUTPUT jack	The impulse waveform appears on the <b>OUTPUT</b> jack, referenced to the <b>RETURN</b> jack
	RETURN jack	This is the return for the impulse waveform. This jack is referenced to the chassis of the MegaPulse and is referenced to earth ground if the MegaPulse is properly grounded. Even though this jack is referenced to ground, it should be treated as hazardous whenever the MegaPulse is turned ON.
10	INTERNAL LOAD	Used for waveform verification purposes, connects a 50Ω load at the Output.
11	ENERGY MEAS. Switch	By pressing this switch, the front display will blink showing for a few seconds the energy measurement from the last pulse. Note: This function only works when the MegaPulse unit is not charging or triggering.
12	E-STOP Switch	When pressed, stops tester functions and discharges voltage. Puts tester in interlock mode until it is restored. Turn knob clockwise to restore it to normal operation.



**Figure 3. MegaPulse Code 360 Rear Panel**

**Table 2 MegaPulse Code 360 Rear Panel Features**

ITEM NO.	NAME	FUNCTION
1	Tester Information	Contains Tester name and Serial Number and contact information.
2	Fuse replacement warning / Rating of power supply	Specifies replacement fuse and required supply voltage.
3	Appliance Inlet / Fuse holder / Power Switch	Use supplied cordset to connect the MegaPulse Code 360 tester to an appropriate source of supply. Fuse holder provides access for Fuse replacement, and the Power Switch is used to turn the tester ON and OFF.
4	TestMinder	Allow the communication between the tester and computer interface; a RS-232 to USB.
5	Interlock Switch (Optional)	Emergency Stop Close: Enables the tester buttons for operation. Open: Stops any process in the tester and disables the buttons. The <b>TRIGGER</b> and <b>CHARGE</b> Indicators will be blinking
6	Remote Control Interface	Interface where the remote control is connected.
7	Fans	The Fans on the rear panel maintain the air flow to cool down the tester.



## Section 4

### Operating Instructions

The Code 360 tester consists of two parts; the pulse generation portion and the measurement portion. Please refer to the general electric circuit shown in Figure 3 to show the function of the Code 360.

The following procedure will explain how to generate a high voltage pulse with the MegaPulse unit.

#### External Interlock

The external interlock is a two position terminal block located on the rear panel. When the External Interlock is open:

- TRIGGER and CHARGE lights will be blinking.
- The front keyboard will be disabled.
- If the unit is connected with a computer with the TestMinder software, the interlock status will be shown on the computer, condition that will also disable polarity changes, charge, and trigger conditions.

When the Interlock is closed, it enables all normal operations of the MegaPulse features

#### Front Keyboard and Voltage Knob Enable

If the MegaPulse tester has disabled the keyboard or Voltage Knob, it is possible to enable them by using the next keyboard sequence:

1. Turn OFF the MegaPulse P tester.
2. Press and hold the **TRIGGER** and **NOR-REV** buttons.
3. Turn ON the MegaPulse tester.
4. Wait until the display shows rESE.
5. Release the TRIGGER and NOR-REV buttons.

#### Discharging Residual Voltage

Note that the Voltage meter may indicate that some residual voltage is present on the main storage capacitor, even when the MegaPulse tester is first turned ON. This is due to inherent charging of the internal capacitors. The following procedure will explain how to discharge a remaining voltage stored on the main internal capacitor.

#### CAUTION

**High voltage generated by the MegaPulse tester is exposed during this test. A risk of shock exists. Exercise care when using the MegaPulse unit.**

1. Turn the rear-panel Power Switch OFF.
2. Disconnect the high voltage cables from the output connectors.
3. Turn the rear-panel Power Switch ON.
4. Press the red **TRIGGER** button to discharge the main capacitor into the internal resistor of the MegaPulse unit.
5. Turn the rear-panel Power Switch OFF.

## Polarity Pulse Selection

### NOTE

**If the red Trigger light is lit or more than 200V remains on the internal capacitor, the polarity pulse selection will be automatically blocked for safety reasons.**

1. Turn the rear-panel Power Switch ON. Positive polarity always is set by default after the unit is turned ON.
2. Press the POLARITY switch button to toggle between positive and negative.

## Voltage Set Point Adjustment

### NOTE

**If the front display shows the word “Off” when trying the adjustment, it means the front Voltage knob had been disabled by the testminder software. See section “Front Keyboard and Voltage Knob Enable”**

To adjust the Voltage Set Point:

1. Press the VOLTAGE Adjust knob one time to enable the adjustment mode, digits for thousands and hundreds will start blinking for a few seconds.
2. While digits still blinking, turn up or down the VOLTAGE Adjust knob to change the value of the blinking digits.
3. While digits still blinking, press again the VOLTAGE Adjust knob and the tens and unit digits will blinking for a few seconds.
4. While digits are blinking, turn up or down the VOLTAGE Adjust knob to change the value of the blinking digits.
5. After a few seconds without any change on the VOLTAGE Adjust knob, the me

## Charge and Trigger a Pulse

The following procedure will explain how to generate a high voltage pulse with the MegaPulse unit. The Megapulse is capable to maintain a specific voltage charge selected by the Voltage Set Point.

### CAUTION

**High voltage generated by the MegaPulse tester is exposed during this test. A risk of shock exists. Exercise care when using the MegaPulse unit.**

1. Confirm the Voltage Set Point by pressing the VOLTAGE Adjust Knob, the setting will blink for a few seconds on the front meter.
2. If a different Voltage Set Point is need it, see section “Voltage Set Point Adjustment.”
3. Set the front panel switches depending the type of test need it. Follow the front panel directions or see Figure 3 for the electrical diagram.
4. Push the yellow CHARGE button to start charging the internal high voltage capacitor and wait until the front meter reaches value set on step1 or 2. Verify the red TRIGGER indicator is now lit.
5. Once the desired voltage is reached, press the red **TRIGGER** button to deliver the high voltage pulse (be sure not to touch the output and return leads when pressing the trigger switch).
6. Turn the rear-panel Power Switch OFF.

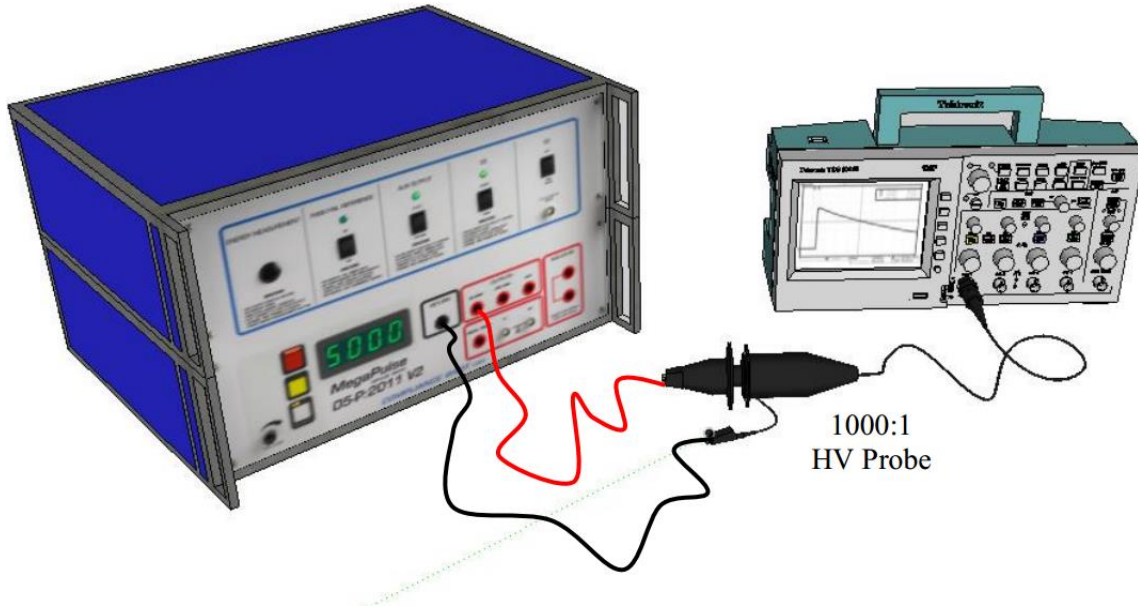

Figure 4. Waveform Measurement Setup (Image for reference only)

## Testing

This section describes how the MegaPulse Code 360 tester is used to conduct a test. The test can be stopped immediately at any time by turning OFF the rear-panel power switch.

**CAUTION:** Make sure you have a load of at least  $50\Omega$  connected between Output and Return or use internal load for testing purposes.

1. Connect the tester to a proper source of supply using the included 18 AWG power supply cord.
2. Plug the Output and Return test leads into the jacks on the front panel.
3. Connect the ends of the test leads to the equipment under test.
4. Turn the Tester on. Toggle the **POLARITY** switch as needed so that the **NOR** or **REV** indicator is lit.
5. Note that the Voltage meter may indicate that some residual voltage is present on the main storage capacitor, even when the tester is first turned ON. This is due to inherent charging of the internal capacitors. Pressing the **TRIGGER** switch will discharge the capacitors (be sure not to touch the output and return leads when pressing the trigger switch).
6. If no load is connected at the Output, turn ON the  $50\Omega$  load switch.
7. Push the yellow **CHARGE** button. Verify the red **TRIGGER** indicator is now lit.
8. Adjust the digital **VOLTAGE** knob up to the desired level. Push the red **TRIGGER** button, when the desired voltage is displayed on the front panel meter.
9. Note that the peak amplitude of the measured output waveform is proportional to the voltage that is read off the front panel of the MegaPulse, but it will always be somewhat lower. This is because the meter on the MegaPulse is measuring the voltage on the main impulse storage capacitor. This voltage will intentionally dissipate to some extent before reaching the output leads.

## **Section 5**

### **Maintenance and Calibration**

#### **WARNING**

**MAINTENANCE AND CALIBRATION INSTRUCTIONS ARE FOR QUALIFIED PERSONNEL ONLY. TO AVOID ELECTRIC SHOCK, DO NOT PERFORM ANY SERVICING OTHER THAN THE CONTAINED IN THE OPERATING INSTRUCTIONS.**

This section of the manual contains maintenance information for the MegaPulse Code 360 impulse tester. A 1-year calibration cycle is recommended to maintain the specifications of the factory. The test equipment required for the performance test is a digital oscilloscope, high voltage oscilloscope probe, digital meter and a high voltage probe.

#### **Service Information**

The MegaPulse tester is warranted to the original purchaser for a period of 1 year. This warranty does not cover problems due to misuse or neglect. Malfunctions which occur within the limits of the warranty will be corrected at no charge. Mail the instrument post paid to the manufacturer. Dated proof of purchase is required for all in-warranty repairs. The manufacturer is also available for calibration and / or repair of instruments that are beyond their warranty period. Contact the manufacturer for a cost quotation. Ship the instrument and your remittance according to the instructions given by the manufacturer.

#### **General Maintenance**

To avoid contaminating the PWB with oil from your fingers, handle it by the edges or wear gloves. If the PWB becomes contaminated, refer to the cleaning procedures given later in this section.

#### **WARNING**

**Dangerous voltages exist when energized. Exercise extreme care when working on an energized circuit.**

#### **Cleaning**

Clean the front panel and case with a mild solution of detergent and a damp sponge. Clean dust from the PWB with clean, dry, low pressure (<20 psi)

#### **CAUTION**

**Do not use aromatic hydrocarbons or chlorinated solvents for cleaning. These solutions will react with the plastic materials used in the instrument.**

#### **Calibration Information**

The Calibration Procedure should be performed annually and any time the instrument has been repaired. The calibration procedure should be performed at an ambient temperature of 23°C ±5°C (73.4°F ±9°F). The procedure consists on internal components tolerance verification and calibrating the meter reading to agree with the capacitor bank. The Calibration procedure must be performed by qualified personnel, for more information contact Compliance West USA.

## **Voltage Stop Disable / Keyboard Enable by Keyboard.**

If the MegaPulse Code 360 tester includes TestMinder option and has the Voltage Stop by the PC command activated, it is possible to disable it using the next keyboard sequence:

### **Note: Disabling Voltage Stop enables the keyboard.**

**Turn OFF** the MegaPulse tester.

Hold in the **TRIGGER** and **NOR-REV** buttons.

**Turn ON** the MegaPulse tester.

Wait until the display shows **rESE**.

Release the **TRIGGER** and **NOR-REV** buttons.

## **Section 6**

### **Technical Assistance**

Technical Assistance from Compliance West USA is available:

**Phone:** (800) 748-6224

**Hours:** 8:30 AM - 4:30 PM Pacific Time.

Also available on our web site at: **[www.compwest.com](http://www.compwest.com)**

**Contact:**

Compliance West USA  
650 Gateway Center Way Suite D  
San Diego, CA 92102 USA.

**Phone:** (619) 878-9696

**FAX:** (858) 481-8527