



**GUIDE TO  
CLAMP-ON  
GROUND  
TESTING**

**Megger** <sup>®</sup>

[WWW.MEGGER.COM](http://WWW.MEGGER.COM)



## TABLE OF CONTENTS

Contents	
Introduction.....	2
Clamp-On Testing versus Fall of Potential Testing.....	3
Fall of Potential Testing.....	3
Clamp-On Testing.....	4
Clamp-On Ground Testing Theory and Methodology.....	6
Series Circuit.....	6
Parallel Circuit.....	7
Parallel-Series Circuit.....	7
Clamp-On Test Methodology.....	8
Summary.....	11
Ground Leakage Current Measurement.....	11
Applications.....	12
Utility Poles/Service Entrance or Meter.....	12
Street Lighting.....	14
Lightning Protection.....	14
Street Cabinets.....	16
Telephone Pedestals.....	16
Cell Towers (applications with buried ground ring).....	17
Pad Mounted Transformer.....	17
Pole Mounted Transformer.....	18
Potential Sources of Error.....	19
Factors in Selecting a Clamp-On Ground Tester.....	20
Jaw Design.....	20
Clamp Head Size and Shape.....	21
Instrument Size.....	23
Category (CAT) Rating.....	24
Noise Filtering.....	25
Backlight.....	25
Data Hold.....	25
Ergonomics.....	26
Alarm Limit Function.....	26
Result Storage.....	26
Clamp-on Ground Testers Available from Megger.....	27
Models DET14C/24C.....	27

## Introduction

Testing the quality of the grounding system has been a critical part of any electrical maintenance program for many years. Ground electrodes are used to provide a safe path to earth for the dissipation of fault currents, lightning strikes, static charges and EMF/RFI signals. Over time, ground systems deteriorate due to either environmental conditions or catastrophic events (like lightning strikes). Alternatively, facility expansion may change needs in the installed ground system.

The risks from ground system deterioration include potentially deadly electrical shocks, plant-wide equipment damage, disruption in the performance of sensitive electrical equipment, heat build-up and eventually fire on a single piece of electrical equipment and disruption in digital communication service. Grounding systems present a unique challenge because they are out of site, buried beneath the soil. The only way to ensure that the system remains capable of dissipating fault currents is to measure its resistance periodically.

Good grounding protects people and equipment and improves the performance of sensitive electronic equipment. The bonding to the ground system is also a critical part of the system. Testing the quality of grounds and bonding should be an active part of any electrical maintenance strategy. Ground (or earth) testing is done to determine the effectiveness of the ground system and connections to protect personnel and equipment and ensure optimal equipment performance. Fall of potential (and its variants) was the only method of testing ground system integrity until the 1980s. Clamp-on, or stake-less, ground testing first appeared in the 1980s and has gained in popularity and acceptance in the years since its introduction.

This booklet will focus on the clamp-on method of ground testing and is designed to give the reader a better understanding of the test method and where it can and cannot be used. Factors that a technician may want to consider when selecting a clamp-on ground tester will also be addressed. Please refer to Megger's booklet "Getting Down to Earth" for further information on fall of potential tests and soil resistivity tests.

## Clamp-On Testing versus Fall of Potential Testing

### Fall of Potential Testing

As mentioned, clamp-on, or stake-less, ground testing is a relatively new method of determining the quality of a ground system. The fall of potential method dates back to the 1930s and is based on the research of H.B. Dwight. It is the most accurate way of measuring and confirming ground rod resistance, but it has several major disadvantages. The basic methodology follows. This booklet will not go into the theory or math behind this method.

Proper fall of potential testing involves placing a current probe in the soil at a distance from the ground electrode being tested (please note that the ground electrode must be disconnected from the system). The actual distance is determined by the size of the ground electrode/system. The ground tester is then connected to the ground electrode under test, the current probe and a potential probe. The potential probe is placed in the soil at distances of 10%, 20%, 30%, up to 90% of the distance between the ground electrode and the current probe and a reading is taken at each location. The readings are then plotted against the distances and the point where the curve flattens is the approximate resistance of the ground electrode (see figure below).

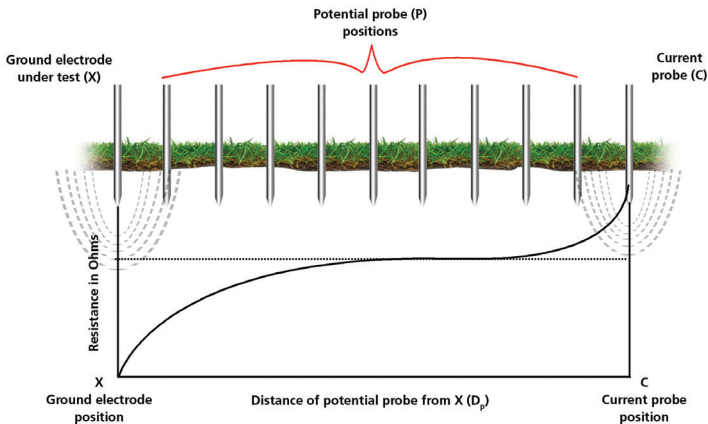

The fall of potential method is extremely reliable, as the results can be checked by testing at different current probe distances. This built-in proof capability means that results do not have to be accepted on faith. The operator has complete control of the test set-up. This method can be used on any size ground system as long as the current probe can be placed far enough from the ground system under test. It conforms to IEEE 81 and is IEEE approved. In an ideal world, fall of potential would be the only method used. Unfortunately, nothing is ideal and this method has three important disadvantages:

1. It is exceedingly time consuming and labor intensive. Temporary probes must be placed and moved. Cables must be run. Readings must be taken and plotted.
2. The operator must disconnect the ground electrode to make the test. As a result, the system is not protected during the test. The ground electrode must then be reconnected after the test, which, in addition to being time consuming, leaves the possibility for error if it is poorly bonded.
3. In real-world situations, space constraints can make it difficult to place the remote probes.

## Clamp-On Testing

The clamp-on ground tester is an effective and time-saving method when used correctly because the user does not have to disconnect the ground system to make a measurement or place probes in the ground. The theory behind this method and the methodology itself will be covered in more detail later in this booklet. The method is based on Ohm's Law, where  $R$  (resistance) =  $V$  (voltage) /  $I$  (current). The clamp includes a transmit coil, which applies the voltage and a receive coil, which measures the current. The instrument applies a known voltage to a complete circuit, measures the resulting current flow and calculates the resistance (see figure on next page).

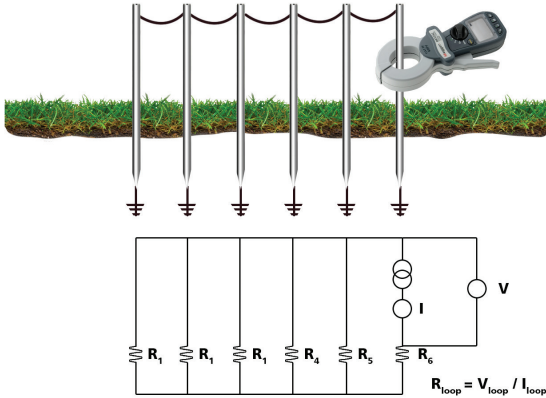

The clamp-on method requires a complete electrical circuit to measure. The operator has no probes and therefore cannot set up the desired test circuit. The operator must be certain that earth is included in the return loop. The clamp-on tester measures the complete resistance of the path (loop) that the signal is taking. All elements of the loop are measured in series. The method assumes that only the resistance of the ground electrode under test contributes significantly. Based on the math behind the method (to be reviewed later), the more returns, the smaller the contribution of extraneous elements to the reading and, therefore, the greater the accuracy.

The major advantage of the clamp-on method is that it is quick and easy. The ground electrode does not have to be disconnected from the system to take the measurement and no probes need to be driven and no cables connected. In addition, it includes the bonding and overall connection resistance. Good grounding must be complemented by “bonding”, having a continuous low-impedance path to ground. Fall of potential measures only the ground electrode, not the bonding (leads must be shifted to make a bonding test). Because the clamp-on uses the grounding conductor as part of the return, an “open” or high resistance bond will show up in the reading. The clamp-on ground tester also allows

the operator to measure the leakage current flowing through the system. If an electrode has to be disconnected, the instrument will show whether current is flowing to indicate whether it is safe to proceed.

Unfortunately, the clamp-on ground tester is often misused in applications where it will not give an effective reading. The clamp-on method is effective only in situations where there are multiple grounds in parallel. It cannot be used on isolated grounds as there is no return path. Therefore, it cannot be used for installation checks or commissioning new sites. It also cannot be used if an alternate lower resistance return exists not involving the soil (such as with cell towers). Unlike with fall of potential testing, there is no way of proofing the result, meaning the results must be taken on "faith." The clamp-on ground tester does fill a role as one tool that the technician could have in his "bag", but not the only tool.

## Clamp-On Ground Testing Theory and Methodology

Understanding how and why the clamp-on method works helps in understanding where it will and will not operate, and how to optimize its use. As mentioned, the clamp-on test method is based on Ohm's Law ( $R = V/I$ ). Understanding Ohm's law and how it applies to series and parallel circuits is the first step to understanding how and why a clamp-on ground tester works. The following graphics will show a series circuit, a parallel circuit and a series-parallel circuit, and the math used to determine the total current and resistance.

### Series Circuit

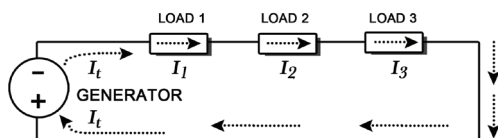

In a series circuit, total current and total resistance are calculated as follows:

$$I_t = I_1 = I_2 = I_3$$

$$R_t = R_1 + R_2 + R_3$$



## Parallel Circuit

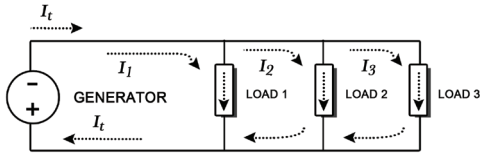

In a parallel circuit, total current and total resistance are calculated as follows:

$$I_t = I_1 + I_2 + I_3$$
$$R_t = 1 / (1/R_1 + 1/R_2 + 1/R_3)$$

## Parallel-Series Circuit

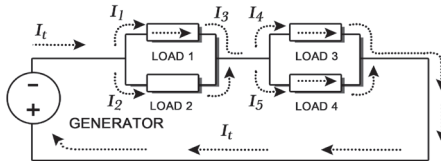

In a parallel-series circuit, total current and total resistance are calculated as follows:

$$I_t = I_1 + I_2 = I_3 + I_4 + I_5$$
$$R_t = 1 / (1/R_1 + 1/R_2) + 1 / (1/R_3 + 1/R_4)$$

## Clamp-On Test Methodology

The head of a clamp-on ground tester includes two cores (see figure at right). One core induces a test current and the other measures how much was induced. The input or primary voltage of the test current inducing core is kept constant, so the current actually induced into the test circuit is directly proportional to the loop resistance.

The important thing to remember with clamp-on testing is that clamp-on ground testers effectively make loop resistance measurements. Clamp-on measurements are loop measurements. For the clamp-on method to work there must be a series-parallel resistance path (and the lower the better). The more electrodes or ground paths in the system the nearer the measurement gets to the actual electrode under test's true resistance. The following figure shows a pole ground configuration, one of the most effective applications of the clamp-on ground tester.

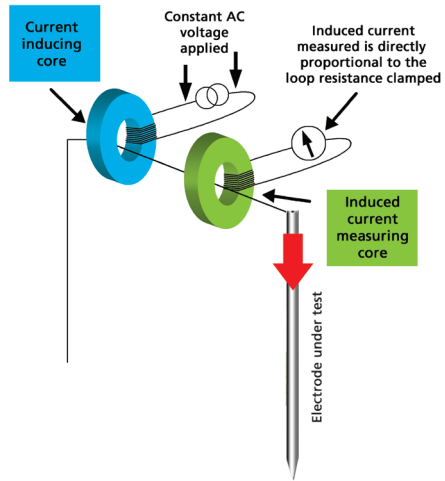

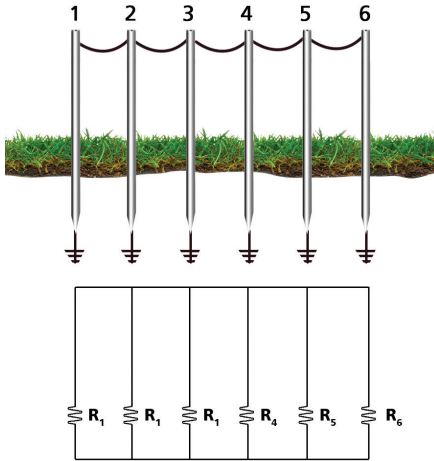

The circuit diagram for this configuration follows (based on a clamp-on ground tester being clamped around pole #6):

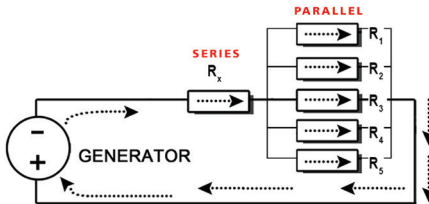

The clamp-on ground tester is clamped around one of the electrodes and then measures the resistance of the entire loop. The remaining ground electrodes are all in parallel, and, as a group, are in series with the ground electrode being measured. If the clamp-on tester is clamped around pole #6, the measurement of the resistance of the entire loop would be calculated using the following equation:

$$R_{loop} = R_6 + (1 / (1/R_1 + 1/R_2 + 1/R_3 + 1/R_4 + 1/R_5))$$

For six similar ground electrodes with a resistance of  $10\Omega$  each, the measurement of the total loop resistance would be:

$$R_{\text{loop}} = 10 + (1 / (1/10 + 1/10 + 1/10 + 1/10 + 1/10))$$

$$R_{\text{loop}} = 10 + (1 / (5/10))$$

$$R_{\text{loop}} = 10 + 2$$

$$R_{\text{loop}} = 12\Omega$$

The measurement of the loop resistance is relatively close to the resistance of the ground electrode being tested. If there were 60 similar ground electrodes with a resistance of  $10\Omega$  each, the measurement of the total loop resistance would be:

$$R_{\text{loop}} = 10\Omega + 0.17\Omega = 10.17\Omega$$

The more ground electrodes in parallel, the smaller the impact of the resistance of the electrodes not being tested and the closer the loop resistance is to the resistance of the electrode being tested. If the electrode being measured has a high resistance, the test will indicate that there is a problem. Using the six electrode example, if electrode number 6 had a resistance of  $100\Omega$  and all the other electrodes had resistances of  $10\Omega$ , the measurement of the loop resistance would be:

$$R_{\text{loop}} = 100 + (1 / (1/10 + 1/10 + 1/10 + 1/10 + 1/10))$$

$$R_{\text{loop}} = 100 + (1 / (5/10))$$

$$R_{\text{loop}} = 100 + 2$$

$$R_{\text{loop}} = 102\Omega$$

In the following example, the clamp-on ground tester would indicate the bad ground. If the  $100\Omega$  electrode was one of the electrodes not being measured, the impact on the overall measurement would be minimal:

# Megger.

$$R_{\text{loop}} = 10 + (1 / (1/10 + 1/100 + 1/10 + 1/10 + 1/10))$$

$$R_{\text{loop}} = 10 + (1 / (41/100))$$

$$R_{\text{loop}} = 10 + 2.44$$

$$R_{\text{loop}} = 12.44\Omega$$

Please note that the measured resistance will always be higher than the actual resistance of the ground electrode being tested. Any error present is on the side of safety, as resistance guidelines are for maximum ground resistance. This means that if the measured resistance is below target level for the ground electrode, the operator can be assured that actual resistance will also be below the target.

## Summary

In summary, remember that a clamp-on ground tester measurement is a measurement of the resistance of the entire loop. There must be a loop resistance to measure. If there isn't a loop to measure the operator can create one with a temporary jumper lead. The greater the number of parallel paths, the closer the measured value will be to the actual earth resistance of the electrode under test. The clamp-on ground tester can easily indicate a poor electrode whether there are a few parallel paths in series with the measured value, or many parallel paths present.

Remember that the earth path must be in the circuit to measure ground resistance. This caveat sounds obvious, but if you have metal structures involved there may be a connection through that, rather than the earth mass.

## Ground Leakage Current Measurement

In addition to measuring the loop resistance, a clamp-on ground tester should also have the ability to measure ground leakage current. Operator safety is the most important reason to measure leakage current. If the tester indicates leakage current, the operator knows that the circuit is live and that he/she should not contact it without the proper precautions.

Beyond the safety aspect, the leakage current measurement can indicate if there is a load imbalance on the system. If the loads are balanced,

there will not be any current flowing. If a 3-phase system has been split and different pieces of equipment are being run off different phases, there is the potential for an imbalance. The system will try to compensate and dump the imbalance on the ground system. This situation results in wasting energy (and money) and stressing the ground system. Leakage current flow may also result from gradually deteriorating insulation that is not bad enough to trip the breaker. Whatever the cause, the presence of leakage current indicates that further action should be taken.

## Applications

As with any type of testing, it is critical that the operator understand the apparatus (in this case, the ground system) that is being tested. The clamp-on measurement works in many situations, but is not applicable in certain configurations. In this section, we will look at various types of applications and outline whether the clamp-on method is viable or not.

### Utility Poles/Service Entrance or Meter

The more parallel earths in series with the electrode under test, the nearer the measurement will be to the actual earth resistance value. Utility poles (see below) are an ideal application for the clamp-on method.

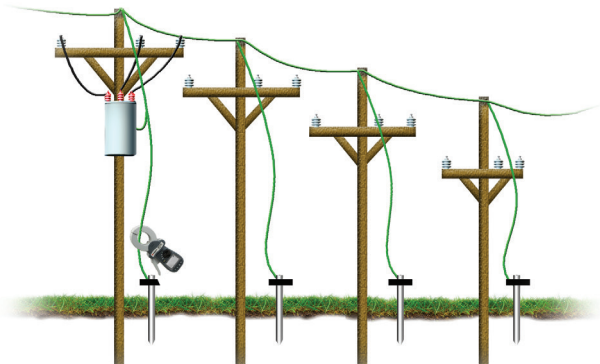

# Megger.

The earth systems on utility poles have many parallel ground connections making this a perfect location for using the clamp-on method. Each pole has a ground electrode to maintain fault and lightning protection, and pole mounted transformers have two electrodes on star configured systems. It is important that these electrodes are checked. The overall earth value of such systems typically needs to be less than  $0.3 - 0.5\Omega$ , while each electrode typically needs to be below  $10 - 20\Omega$  to be effective.

Another related application is to test the ground electrode resistance on a service entrance or meter (see graphic below). Here, there is the possibility of multiple earth paths, two electrodes, or maybe connection to a water pipe, so take care to identify the best positions to make a measurement. Sometimes it is best to clamp the electrode itself below where the earth connections are made.

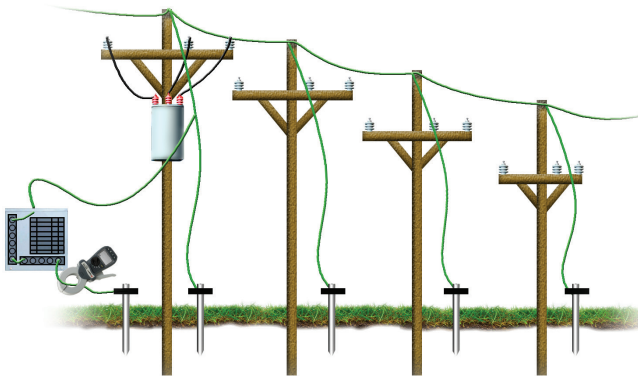

## Street Lighting

A similar application to utility pole electrodes is street lighting. The cable running to each street light's electrode may be clamped, but remember to clamp the correct side of the grounding conductor as shown below.

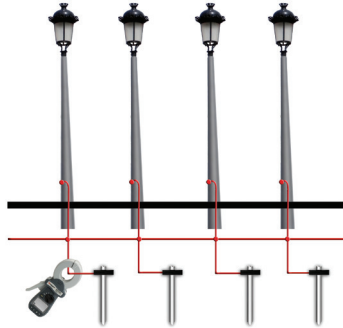

## Lightning Protection

Another ideal application for the clamp-on test method is to test ground electrodes on lightning protection. Lightning protection on any building is only as effective as the quality of its grounding. Electrodes are normally placed at each corner of a building with extra electrodes between on larger buildings. The conductors used are typically copper tapes up to 50 mm wide. The following figure shows a typical lightning protection circuit where a clamp-on ground tester is clamped around the electrode.

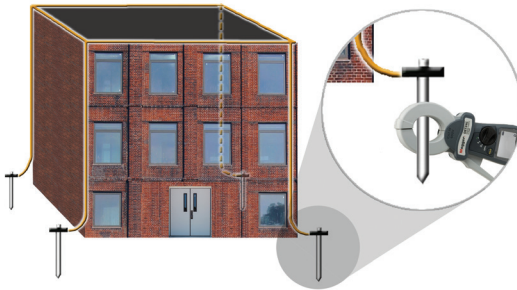



# Megger.

In many cases this is difficult because the electrode is buried in a small pit. In addition, many lightning protection down tapes are fitted with removable links to allow the application of a two-wire continuity test. These removable links, often referred to as 'jug handles', are time consuming to remove, but make ideal locations to use a clamp-on tester. The clamp-on tester will measure the whole loop, including all of the connections and tape bonds, just the same as a two wire test.

Many lightning protection systems on factory buildings, especially in European countries, use lightning receptors mounted at regular intervals on the roof. These receptors are all interconnected as shown in the following figure. This approach further decreases the series resistance of the parallel earth path, meaning the measured value is even closer to the true earth resistance of an electrode under test.



Remember there could be other connections to the lightning protection system. The user must remember to clamp around the tape below all connections. Otherwise the ground electrode will be tested in parallel to any other paths to earth. There may be connections to external metal work such as metal balconies and hand rails. These must also be above the point where the clamp-on tester is clamped. Remember the importance of a visual inspection as well. With the price of copper, grounding tapes can be cut and stolen. Depending where the tape is cut, and how the system is linked, the instrument could return a good, but false, reading.

## Street Cabinets

Another application is to test the ground electrode installed inside primary cross-connection points, sometime called street cabinet/ flexibility points (see figure below). These electrodes typically need to be below  $25\Omega$  to maintain reliability. In this application there may not be more than two parallel earth paths in series with the electrode. However, based on the math, if the clamp-on ground tester provides a measurement below  $25\Omega$ , then the electrode must certainly be below  $25\Omega$ .

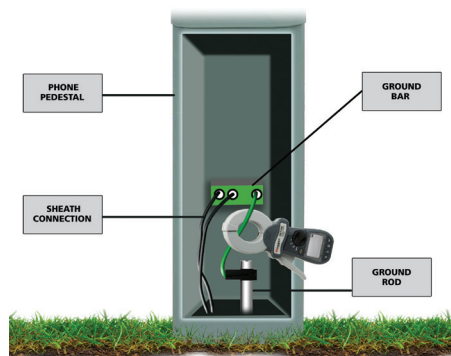

## Telephone Pedestals

Telephone pedestal ground electrodes can be tested using the clamp-on method. Cable sheaths are all connected to a ground bar, which in turn is connected to the ground electrode. The clamp-on can be placed around the cable connecting the ground bar to the electrode to perform a test. If access is difficult a temporary extension cable can be fitted to facilitate fitting on the clamp-on tester.

## Cell Towers (applications with buried ground ring)

A ground resistance measurement cannot be made if the rods are linked together by a ring that is buried beneath the soil. This type of configuration, which is common in cell towers, allows access somewhere above the ring. Cell towers are grounded at the base, with each guy wire grounded and all of them connected together in a ring of grounds.

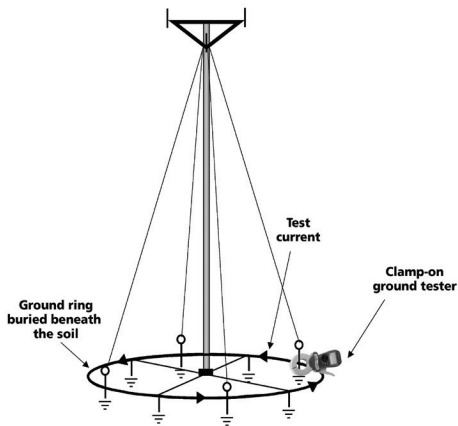

If the operator clamps around the head of one of the guy wire grounds, the test current will simply complete the circuit in the ground ring and not through the soil. The test current circulates through the conductor that connects the individual elements (ground rods) that comprise the ring. As such, the clamp-on ground tester will not be measuring the quality of the ground system. The reading will actually be a reading of the resistance of the "loop". This measurement does allow the operator to verify the connections beneath the soil.

## Pad Mounted Transformer

Pad-mounted transformer ground electrodes can be verified using the clamp-on method. However, sometimes there are a number of connections to the same electrode so the user may have to clamp around the electrode itself below the connections. Should all these connections be to a large buried ground mat this measurement would then become a continuity measurement because the test loop will not include an earth path.

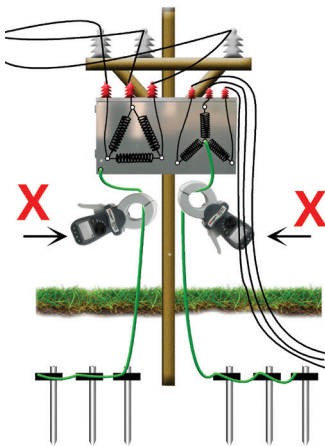
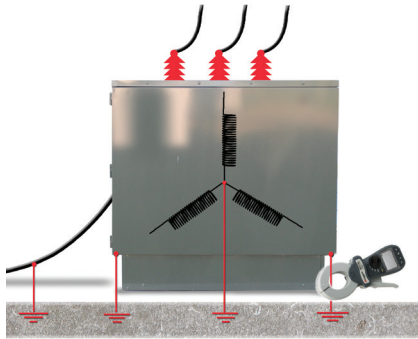

## Pole Mounted Transformer

Remember the first of the two golden rules of clamp-on testing, "there must be a loop resistance to measure."

There are some occasions with utility poles where that loop does not exist, at least not where you want it to be anyway. The figure below illustrates a system with a star-delta transformer mounted on a pole with two sets of electrodes.

Neither set of electrodes are connected to an overhead earth cable. One is connected to the metal case of

# Megger.

the transformer, and the other is connected to the star point of the LV secondary winding. The danger here is that the loop measured could be between the two sets of electrodes, with part of the loop being the resistance of the wood pole, resulting in a high measurement. This could mislead the user into believing there is a problem when in fact there isn't one.

In contrast, in the graphic below, there is a connection to local distribution and its local ground system. This means we now have an earth loop to measure and a measurement may be taken. However, remember the resistance measurement taken is a combination of the two earths in series. A measurement of  $40\Omega$  will not mean each electrode system is below  $25\Omega$  of course, one could be  $10\Omega$  and the other  $30\Omega$ . If the measurement is, for example,  $10\Omega$  then we know we are going to be okay.

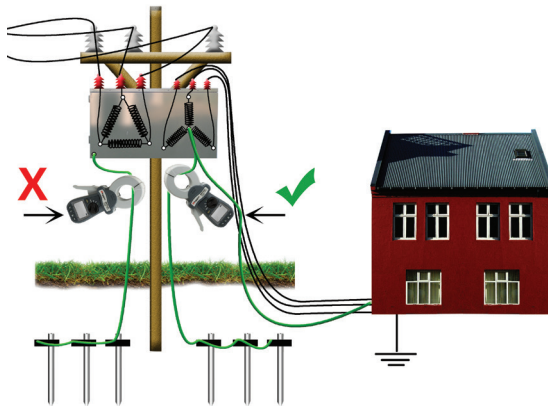

## Potential Sources of Error

If used correctly, the clamp-on test will give reliable measurements as long as the operator uses a good quality instrument. To highlight and forewarn users here are some potential sources of error:

We have already discussed one potential source of error; that the user might not understand the circuit under test. Remember that there must be a loop resistance to measure and that the earth path must be in the circuit to measure earth resistance. The example with the pole-mounted transformer discussed previously is a prime example of an application where the earth path was not in the circuit.

There are two other key sources of error that the user must understand:

1. **Dirt Trapped in the Clamp Head:** Dirt trapped between the closing gap in the head will modify the magnetic circuit. Magnetic flux will bleed over between the inducing core and the measuring core. The result will be a false low reading which in some cases could result in a poor electrode being measured as being good. Many instruments use interlocking laminations or teeth as they are sometimes referred to. These can trap the dirt and are difficult to clean. They are also easily damaged. Damaged teeth will either result in poor, inaccurate measurements, or render the instrument useless.
2. **Noise Current Affecting the Measurement:** Testing in noisy environments can result in high levels of noise current flowing down the electrode under test. This can cause readings to vary, making them difficult to interpret, or if the current is too high, make measurement impossible.

## Factors in Selecting a Clamp-On Ground Tester

The most common reason for users not being able to use the clamp-on ground tester is poor access. Often cable or tape sizes are too large for the clamp or the instrument design and size make it difficult to fit in tight spaces. This section will cover the factors that a user should consider before buying a clamp-on ground tester. In addition to access, we will look at safety and performance factors.

### Jaw Design

There are two ways to design the jaws of the clamp on a clamp-on ground tester. The easier way to get the jaws to mate properly is to use interlocking teeth on the core ends. The more complex way, from an

# Megger.

engineering standpoint, is to use flat core ends. This latter approach, when implemented, provides greater measurement integrity and instrument reliability.

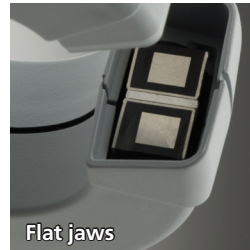

As mentioned in the section on potential sources of error on the previous page, dirt trapped between the closing gap in the clamp head can result in erroneous readings. Clamp-on ground testers are used outdoors in environments that are often dusty and dirty. They are exposed to materials that can end up on the core ends of the jaws. With flat core ends, the surfaces can be cleaned easily. This same material tends to get stuck in the interlocking teeth and is very hard to remove.

The interlocking teeth are also delicate and relatively easy to damage or shift out of alignment. Damaged teeth cause the instrument to give inaccurate readings or can cause the instrument to not work at all. Often, an instrument with damaged teeth must be scrapped.

When considering a clamp-on ground tester, make sure to look at the clamp head and jaw mating surfaces.

## Clamp Head Size and Shape

Ground electrodes come in different shapes and sizes and can be positioned in difficult-to-access locations. The clamp head size and shape should be considered when choosing an instrument. Clamp-on ground testers have different head shapes (round, oval or elliptical), opening sizes and thicknesses.



An elliptical shaped head can allow much easier access to ground electrodes in recessed wells.

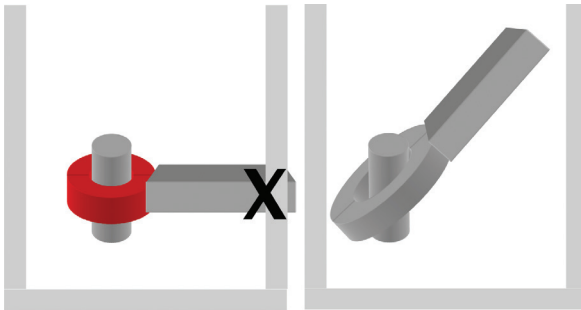

A larger inner area allows for clamping around larger ground rods or ground tapes (some of which can have a width of 50 mm). With a smaller internal opening on the instrument, the larger ground tape must be cut and a thinner copper bar welded in between to allow the instrument to make a measurement.



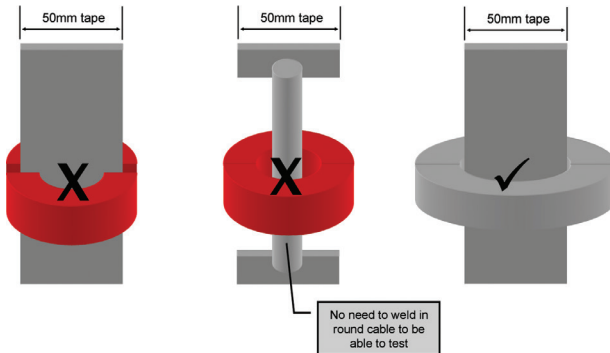

Some ground electrodes are secured quite close to the building wall or utility pole, making it difficult to clamp the head around the rod. The thicker the head, the more difficult this process is. A thinner head is preferable, if performance is not compromised.

Before selecting an instrument, the user should consider the size and location of the ground electrodes to be tested and compare this information with the specifications of the instruments being considered. If the user is unsure of what future requirements might be, he/she should err on the side of there being larger ground rods/tapes to test in the future.

## Instrument Size

The early clamp-on ground tester models were quite long. In recent years, technology has allowed manufacturers to make these instruments shorter. Why is shorter better? A shorter instrument will allow better access in difficult locations, especially in recessed wells.



## Category (CAT) Rating

The CAT rating of a test instrument defines where in the electrical supply chain the instrument can be safely used. This is usually printed on the instrument across the test connections and appears as CATII, CATIII or CATIV. CATI is generally no longer used as it has no practical application.

The CAT rating defines the level of transient (spike or surge) the instrument has been designed to withstand. These transients vary in size and duration depending on the source of the transient. The transient riding on a high-energy supply is more dangerous than a transient on an isolated cable as it can deliver larger currents when a fault occurs (a spike on steroids, for example).

A transient may be several kV in amplitude but its duration is typically very short, maybe only 50 microseconds. On its own the transient will cause little damage. However, when it occurs on top of the normal mains sinusoidal supply voltage it can start an arc, which continues until the end of the cycle. In the case of a CAT IV system the available short circuit current can be in excess of 1000 amps. This generates hundreds of kilowatts of heat in a small space for a few milliseconds, creating a big bang, possibly causing burns, fire or explosion.

Instruments designed with the correct category rating have sufficient clearance between critical parts to prevent an arc from creating the initial breakdown when a transient occurs. The electrical supply can be broken down into categories from CATI to CATIV as shown below:

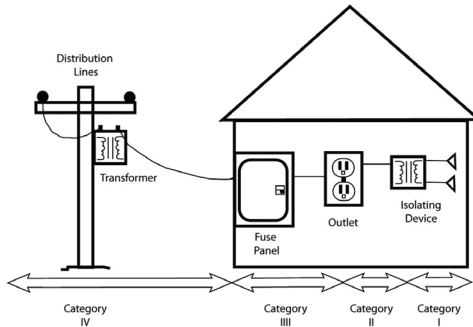

# Megger.

As most ground electrode testing takes place outside, users should consider buying an instrument rated to CATIV 600 V.

## Noise Filtering

As mentioned, testing in electrically noisy environments can result in high levels of electrical noise current flowing down the electrode under test. This situation can cause the readings to vary, making them difficult to read. If the current is too high, it can make measurement impossible. If the user is going to measure ground resistance in an electrically noisy environment like a switch yard, he/she should look at clamp-on ground testers that include noise filtering functions. The instrument should detect the presence of noise and indicate it to the user. Noise filtering increases noise immunity (usually with a slight increase in measurement time).

## Backlight

Ground tests are not always made in the sunlight or in clear weather. As an example, measurements are often made in low light environments like cable basements. If the user may be working in such an environment, he/she should consider an instrument that includes backlight capability.

## Data Hold

Depending on the location of the ground electrode, the instrument's screen may not always be visible when taking a reading. In this situation, the user cannot see the reading being taken by the instrument. Including a hold function on the instrument allows the user to freeze the reading and then view it when the screen is again visible. Accessing a data hold button can be difficult during a test and activating it at the time that the reading settles requires guesswork. Instruments with intelligent data hold capability allow the user to activate the data hold function before clamping around the ground electrode. The unit then automatically captures the reading once it settles and indicates that the measurement is done by an audible sound.

## Ergonomics

Clamp-on ground testers can be used to make many measurements in a single day (think about the pole ground application). It is important to consider the instrument's ergonomic features, especially in relation to opening the jaw. The trigger design should be easy and comfortable to operate. If it is too small, it will require more force to open (as there is less leverage) and have a greater chance of the fingers slipping off, causing the jaw to snap shut.



## Alarm Limit Function

The ability to set audible and visual alarm limits can be quite useful, especially for inexperienced users. Limit alarms should be able to be set for both resistance and current. A current alarm is an operator safety feature.

## Result Storage

Result storage is another capability that the user should consider before buying an instrument. Traditionally, ground tester results are written down manually. Buying an instrument that stores the results can save time and prevent recording errors. Accuracy is improved if the results are time and date stamped.



## Clamp-on Ground Testers Available from Megger

### Models DET14C/24C

The DET14C and DET24C are advanced clamp-on ground resistance testers that set new standards pertaining to access, performance, features, simplicity of operation and safety. Designed with flat core ends, they prevent dirt build-up, ensuring measurement integrity and improved reliability over products with interlocking teeth. Other enhancements include safety to CATIV 600V, a built-in filter function for electrically noisy environments, time and date stamped stored test results and ultra long battery life.







**Megger makes high quality instruments for the following electrical testing applications:**

- Insulation Testing
- Relay Testing
- Oil Testing
- Circuit Breaker Testing
- Power Quality Analysis
- Low Resistance Testing
- Battery Testing
- Watthour Meter Testing
- Transformer Testing
- Cable Fault Locating
- Power Factor Testing
- Hi Pot Testing

Megger manufactures electrical test and maintenance instruments for electrical power, process manufacturing, building wiring, engineering services and communications.

Visit our website for local assistance worldwide at [www.megger.com](http://www.megger.com).

TEquipment.NET  
205 Westwood Ave  
Long Branch, NJ 07740

**Megger**<sup>®</sup>