

Megger[®]

DET14C and DET24C
Digital Earth Clamp-on Tester

USER GUIDE



SAFETY WARNINGS

These safety warnings are provided to ensure the safety of personnel and proper operation of the instrument.

- Safety warnings and precautions must be read and understood before the instrument is used. They must be observed during use.
- Do not leave the instrument connected to the system under test when not in use.
- Do not touch circuit connections and exposed metalwork of the installation or equipment under test.
- Do not use the instrument or connect it to any external system if it shows any visible signs of damage, malfunction or if it has been stored in unfavourable conditions.
- Always keep body parts behind the tactile barrier on the handles of the instrument.
- Always inspect the instrument prior to use. Replace any defective parts immediately or return the instrument to an authorised service centre for repair.
- Do not use the instrument or connect it to any external system if the casing is open or any parts of the case are missing.
- Do not use rechargeable batteries in this instrument.
- Always use caution when clamping the instrument around energised electrical conductors.
- Always use extreme caution when clamping around bare conductors: under fault conditions, high voltages and currents may be present and may pose a shock hazard.
- The instrument is not suitable for measuring AC currents in multi-core cables or DC currents.
- The instrument should not be used if any part of it is damaged.
- This instrument is not intrinsically safe and must not be used in hazardous atmospheres.
- If this equipment is used in a manner not specified by the manufacturer, the protection provided by the equipment may be impaired.
- Use extreme caution when using the instrument in proximity to bare conductors. Avoid contact between the metal in the jaws and bare conductors. A short circuit would create an arc-flash explosion hazard

OPERATION PRECAUTIONS

- It is important to keep the mating jaw surfaces clean as even small amounts of contamination can cause measurement problems
- It is important to not damage the mating jaw surfaces. Take care when clamping around electrodes as scratches on the mating surfaces
- will cause measurement problems
- It is important to avoid impacts to the clamp head as any damage will cause measurement problems
- Damage including scratches to the mating jaw surfaces is considered misuse and will invalidate the warranty

NOTE: THE INSTRUMENT MUST ONLY BE USED BY SUITABLY TRAINED AND COMPETENT PERSONS.

Users of this equipment and/or their employers are reminded that National Health and Safety Legislation requires them to carry out valid risk assessments of all electrical work so as to identify potential sources of electrical danger and risk of electrical injury such as inadvertent short circuits.

The safety warnings provided in this document are indicative of safe practice and shall not be considered exhaustive. Additionally, they are not intended to replace local safety procedures where the instrument is being used.

CONTENTS

 SAFETY WARNINGS	2
CONTENTS	3
GENERAL DESCRIPTION	3
APPLICATION	6
MODES OF OPERATION	8
GENERAL OPERATION	9
GENERAL SPECIFICATIONS	12
MEASUREMENT SPECIFICATIONS	14
ORDERING INFORMATION AND ACCESSORIES	15
PREVENTATIVE INSTRUMENT MAINTENANCE	15
REPAIR AND WARRANTY	18
END OF LIFE DISPOSAL	18

Symbols used on the instrument



Caution: refer to accompanying notes.



Equipment protected throughout by Double Insulation.



Equipment complies with current EU directives.



Equipment complies with current "C tick" requirements.



Do not dispose of in the normal waste stream.



Equipment can be clamped around and removed from hazardous live conductors [IEC 61010-2-032 Type A clamp].



Equipment not suitable for use where the magnetic field exceeds this limit.

CAT IV
600 V

CAT IV 600 V Overvoltage category IV (equipment installed at or near the origin of the electrical supply to a building.)

600 V refers to the rms phase-to-earth voltage that this instrument can withstand to the overvoltage category IV rating.

GENERAL DESCRIPTION

The DET14C and DET24C represent a new generation of earth/ground clamp-on resistance testers. These instruments induce a test current into earth systems and measure ground resistance in multi ground installations without needing to disconnect the ground. They offer market leading access, advanced features, simple operation and CAT IV 600 V safety protection.

Designed with flat core ends, they prevent dirt build up, ensuring measurement integrity and improved reliability over products with interlocking teeth. Other enhancements over current generation products include improved accuracy and up to 300% increase in battery life. In electrically noisy environments the built-in filter function offers increased noise immunity.

DET14C and DET24C also offer a true RMS AC current measurement facility up to 35 Amps. The instrument's ability to measure current flowing in an earth cable is a useful safety feature, especially if the earth cable has to be disconnected. A high current flow to earth could draw an arc on disconnection with potentially severe consequences.

The elliptical shaped head design offers improved access to cables and earth straps in constrained spaces (locations). The clamp head accommodates up to 39 mm diameter cable and 50 mm earth tapes making them suitable for use in power stations, sub-stations, towers and many more facilities. Operation in dark and restricted areas is facilitated by a display with backlight and an audible tone associated with the hold key. (The special jaw opening mechanism ensures proper jaw closure yet minimises the force required to open them).

The DET14C offers storage of results for later on-screen recall and the DET24C supports a download of results via Bluetooth® into PowerDB and Power DB Lite, Megger's Acceptance & Maintenance Test Data Management software. Stored data is indexed using a sequential serial number together with a time and date stamp for each record.

FEATURES AND BENEFITS

- 39 x 55 mm elliptical head
- Auto-current measurement safety feature
- Memory to record and view results
- Automatic self calibration
- Auto ranging
- High and low alarms
- Real time clock for date and time stamping of results

DET24C ADDITIONAL FEATURES

- Bluetooth® interface to PC
- Advanced memory functionality with download
- Megger PowerDB/PowerDB Lite™ compatible

Figure 1: DET14C / DET24C Instrument Front View

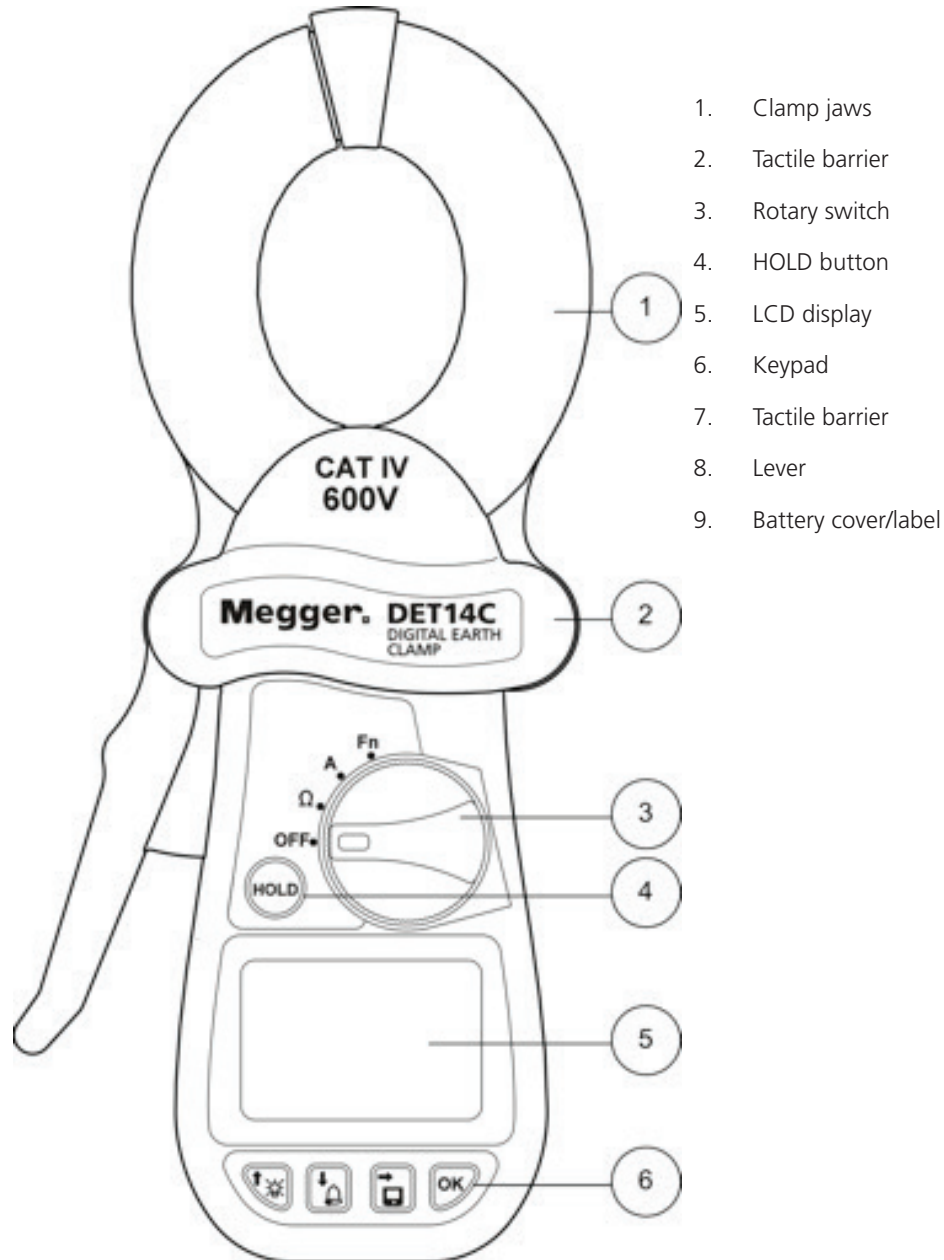

Figure 2: DET14C / DET24C Instrument Rear View

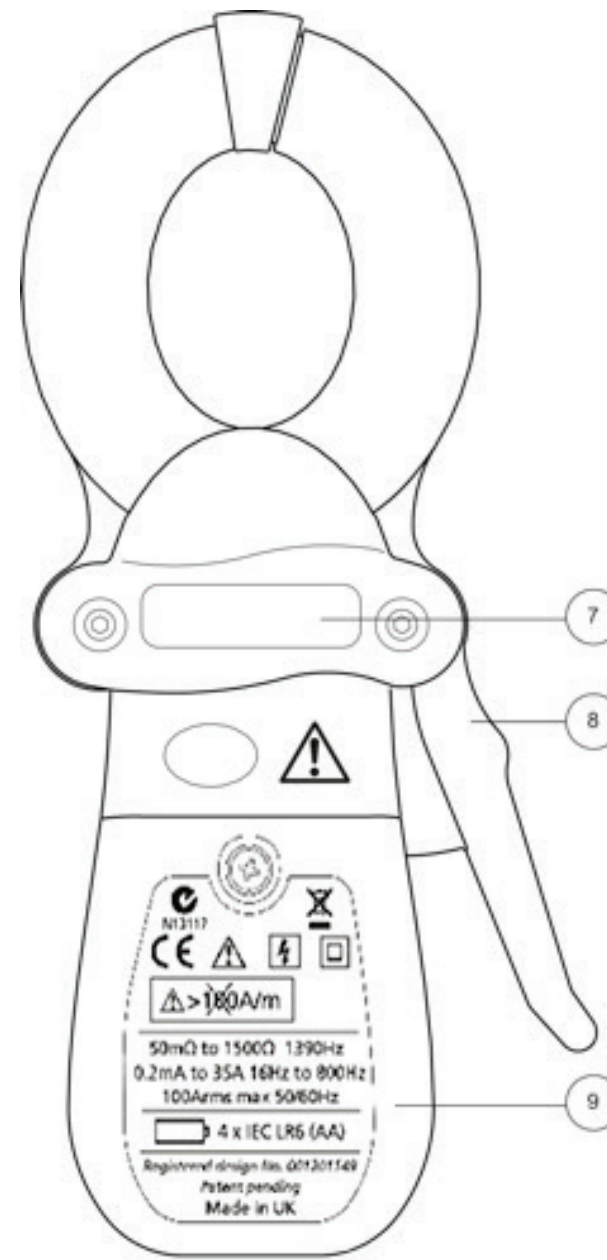
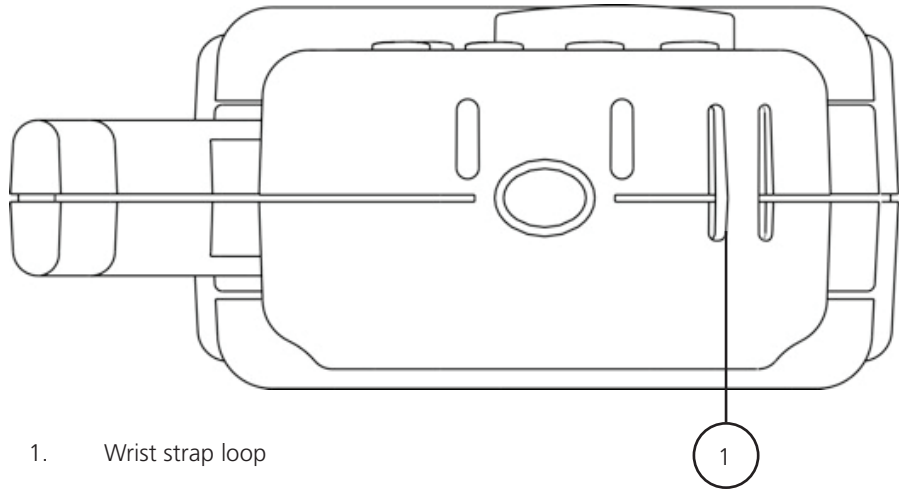
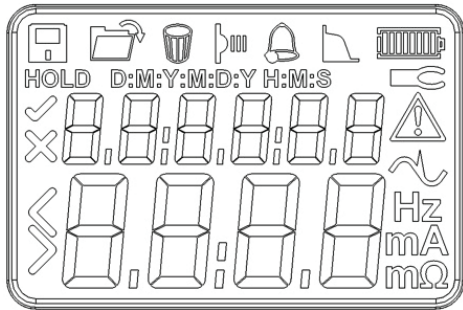

Figure 3: DET14C / DET24C Instrument Bottom View



1. Wrist strap loop

Figure 4: DET14C / DET24C Instrument Display View



- | | | | | | |
|--|-----------------------------|--|-----------------------|--|----------------|
| | Save | | Bluetooth® menu | | Battery |
| | Tick = set | | Alarm | | HOLD |
| | Open | | Less than | | D:M:Y
M:D:Y |
| | Cross = not set | | Filter | | H:M:S |
| | Delete | | More than | | Clamp open |
| | Warning refer to user guide | | Signal noise detected | | |

APPLICATION

The DET14C / DET24C digital earth clamp meters are particularly suitable for measuring earth resistance in various installations such as buildings, pylons and RF transmitter sites without system disconnection. In addition, they can be used for the inspection and verification of lightning protection systems and virtually any installation where a current loop can be generated.

Principle of Operation

A defined test voltage is injected into the system under test using a voltage transducer coil to induce a current, I , to flow which can be measured by the current sensing coil. The resistance follows from Ohm's law, $R = V/I$.

The system shown in Figure 5 can be simplified to the resistance of the electrode under test, R_g and the resistance of the other electrodes in parallel, i.e. $R_1 \parallel R_2 \parallel R_3 \dots \parallel R_n$. Therefore, the current induced by the test voltage is $I = V/[R_g + (R_1 \parallel R_2 \parallel R_3 \dots \parallel R_n)]$. It follows that as the resistance of the other electrodes in parallel approaches zero, then the resistance measured, approaches the value of the electrode under test.

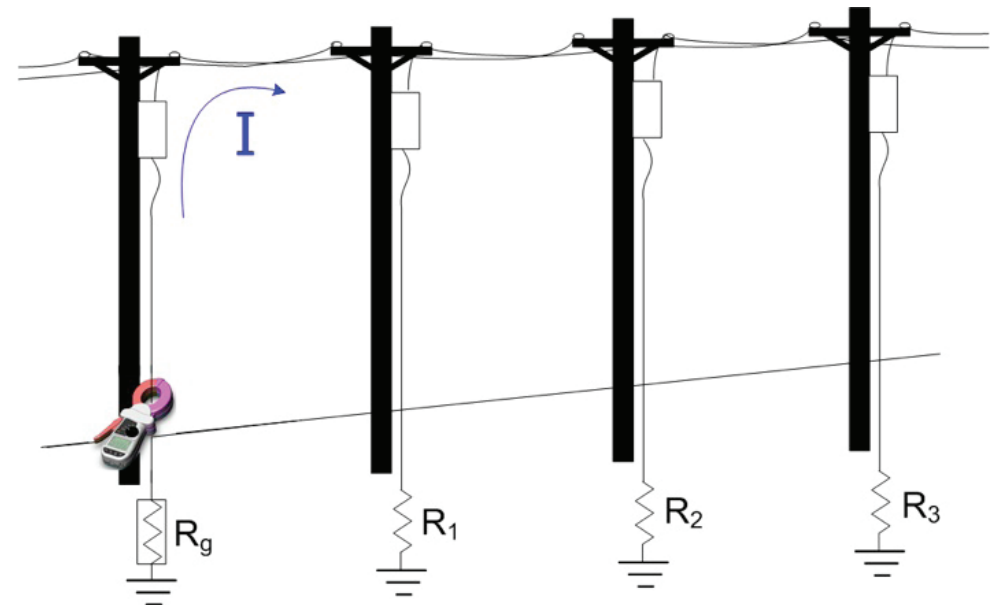



MODES OF OPERATION

The DET14C / DET24C can operate in one of three main modes, selected using the rotary switch:

- OFF Turn instrument off
- Ω Resistance measurement
- A Current measurement
- Fn Setup and configuration

When in a measurement mode, there are other functions which are selected using the buttons:

- HOLD Hold the displayed measurement value.
-  Enable / disable display backlight.
-  Enable / disable buzzer function.
-  Save displayed result to memory.

When in the setup and configuration mode (Fn), some buttons have different functions:



-  Increment value.
-  Decrement value.
-  Advance to next field.
- OK Accept value.

Figure 6: Main mode selection using the rotary switch

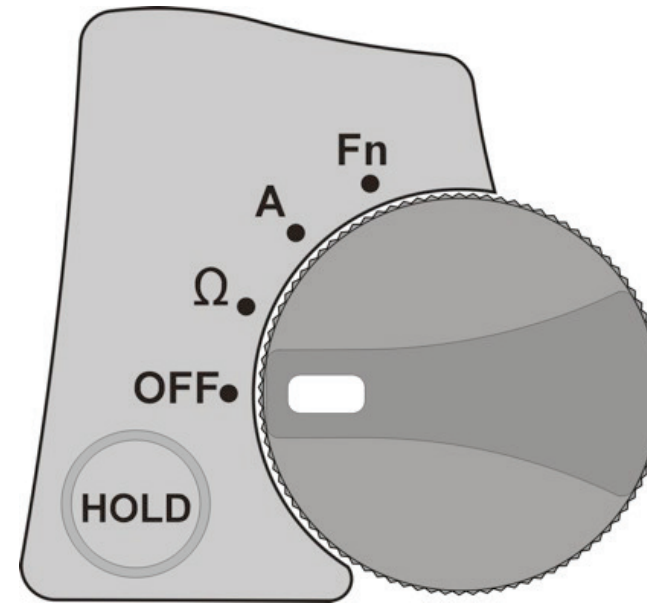

Figure 7: Other functions using buttons



GENERAL OPERATION

Powering on the Instrument

The instrument is switched on by turning the rotary switch to one of the three mode positions,

i.e. Ω , A or Fn. The Ω (resistance) and A (AC current) measurements are both auto-ranging.

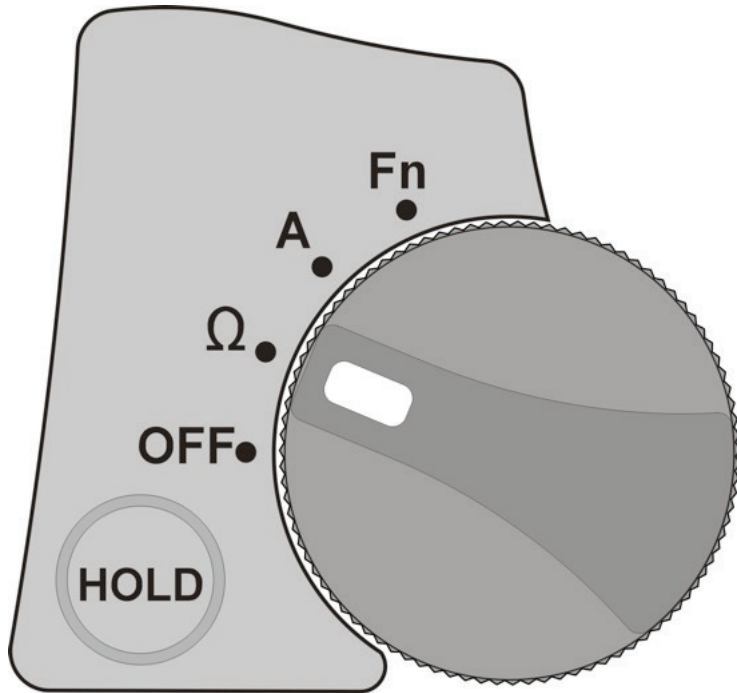

Fig 8. Resistance measurement mode

Measuring Resistance Mode

With the resistance (Ω) mode selected simply open the clamp and clamp around a ground conductor to be measured. The instrument automatically senses the jaw opening and activates the open jaw icon (☐) on the display. As soon as the jaw is closed the open icon is removed and a resistance measurement is initiated. A reading is taken periodically and the display updated until the user presses the HOLD key to freeze the reading or turns off the instrument.

Resistance measurements in high noise environments can be problematic resulting in no reading. The DET14C / 24C instruments incorporate a noise symbol (⚡) to indicate presence

of noise during a measurement. A filter function indicated by the filter icon (⏸), is activated automatically in the presence of noise. The filter results in a slightly longer measurement period but offers improved noise immunity.

Measuring Current Mode

To measure true RMS AC current simply set the rotary switch to the current mode (A) and clamp around the cable or tape to be measured. RMS current is displayed on the screen in either A or mA.

HOLD

The HOLD key can be used to freeze a result in either resistance or current mode. Once held, the result can be saved to memory using the save (💾) button.

HOLD has two modes depending on when it is activated:

- If a measurement is in progress and HOLD is pressed it will freeze the result even if the clamp is opened and removed from the unit under test.
- The user may also use the HOLD function with the clamp closed before a measurement is taken. This mode assists users to take readings in difficult to reach areas where the instrument display may not be visible during the measurement. Depressing the HOLD button for two seconds with the clamp closed and no conductor present will activate an automatic hold of the next result. HOLD will flash on screen until the measurement is taken or it times out. The instrument will sense open jaws, closed jaws and take a reading, then freeze the reading on screen and beep to indicate that the measurement is complete.

Backlight



A low intensity backlight is provided on the instrument display to facilitate measurements in dark conditions. The backlight button (💡) toggles the backlight on and off. An auto off timer will switch the backlight off after 20 seconds to conserve power.

Saving Data

Data is saved in either resistance mode (Ω) or current mode (A). Pressing the save key (💾) will record a result with a time and date stamp. It is important to regularly ensure that the time and date settings are correct. Time and date are set from the Function mode (Fn).

Function Mode



The Function mode (Fn) contains five minor functions on the instrument:



- Recall records ()
- Delete records ()
- Bluetooth® download (**bt**)
- Alarm setting ()
- Set Time/Date (H:M:S/D:M:Y M:D:Y Y:M:D)

In Function mode (Fn) the buttons shown in Figure 7 operate as arrow buttons and are depicted in green matching the green (Fn) icon on the rotary switch. The right arrow button is used to scroll through minor functions in the order listed.



Recalling Data



Stored data can be recalled and viewed on the instrument from the recall records () function, which is the default screen on switching to function mode (Fn). Press the OK button to enter the recall function.

Results are showed with an index number. Pressing the right arrow button () will show the result and date the result was taken and a second press of the right arrow button () will show the time the result was recorded on that day. Pressing the right arrow button () a third time will show the result and index number again.

Pressing the up arrow () button will increment the saved result index and show the next result. Pressing the down arrow button () will decrement the memory index and show the previous result.

Deleting Data

Data can be deleted in two ways; either delete the last recorded result or delete all stored results. From the Function mode (Fn) press the right arrow button () once to get to the delete record function (), which will appear at the top of the screen, then press the OK button to enter the delete function.

In the delete function, the right arrow () button will toggle between the full range of results, depicted by a range, e.g. 1-53 or the last result, which in this case would be the 53rd result. A cross on the left side of the screen indicates that delete will not operate yet. To confirm the deletion, use the up arrow () or down arrow () to toggle the cross to a tick. When the tick shows press the OK button to delete. Operation is returned to the Function mode (Fn) after the OK button has been pressed.

Download Data instructions (DET24C only)

1. Install a version of PowerDB and run it up.

First ensure the DET24C Bluetooth has been paired with your device.

2. On the DET24C select the Fn range
3. Press the right arrow key until the display shows "b t"
4. On your laptop or device select the add a device
5. Select DET24C to pair device, when asked for the pair code type 0000
6. Once paired the instrument is ready to download test results

Now to downloading stored data

7. With DET24C still with BT selected on Fn range
8. For first use to ensure the correct port is selected it is recommended that a note of the assigned port number is made
9. Open the PC control panel and select "Devices and Printers"
10. Right click the DET24C icon and select properties
11. Select the Services tab and note the COM number assigned to the Bluetooth serial port
12. On Power DB Lite select the DET clamp icon and the instrument configuration window will open
13. Click refresh button, and then select the correct serial port as noted above from the drop down list
14. Should the required port number not appear on the drop down list it may be required to open the PC control panel and open the device manager. If there are a large number of assigned Bluetooth ports listed it may be necessary to temporarily disable some of the ports to a small number. Then return back to step 12
15. When prompted to select an instrument, look under the 'Earth' series of instruments and click on the button marked DET-xxx.
16. Select form 24480, earth resistance DET24C.
17. Press OK on the instrument to show the number of results to be downloaded then press OK again. The 'BT' flashes indicating that it is waiting to download.
18. On Power DB Lite, click the 'Import From Instrument' soft button and click OK on the prompt to start the download.
19. The DET24C download progress can be monitored on the progress bar shown on Power DB Lite. On completion of the download the instrument will show "DonE" on it's display
20. Power DB Lite will display a Stored Data List
21. Select the test results you wish to import into the test form and click OK
22. Alternatively Save to CSV to save a file that may be used in Excell

When the download completes the results are shown in a spreadsheet window in front of the main PowerDB form. Select all data or specific data required for import and click OK. Data should appear in the form. Complete relevant data and information as required and save the form with a name of your choice.

Activating Alarm

Alarms can be activated and deactivated in either resistance mode (Ω) or current mode (A) by pressing the alarm button (🔔). There are two alarms, identified by "HI" and "LO" that can be set in resistance mode and another two in current mode. Alarms are set in the function mode (Fn).

Setting Alarm Thresholds

Resistance mode (Ω) and current mode (A) each have two settable alarms (HI and LO). To set the alarms from the Function mode (Fn) navigate to the alarm mode (🔔) using the right arrow (➡) button and press the OK button. To set or clear alarms press the right arrow button (➡) and a cross will appear with a default 'HI' alarm setting. To change the setting press and hold the up (⬆) or down (⬇) arrow buttons until the required value is reached. Press the OK button to set the HI resistance alarm level and move onto set the LO resistance alarm. Adjust the level and set it using the OK button.

Current mode (A) alarms, HI and LO, are set in the same way and follow directly on after setting resistance alarms. If either resistance or current alarms are not required, simply leave a cross in the relevant alarm setting. The mode of alarm is depicted by either Ω or A in the bottom right of the display.

Setting the Time and Date

The time and date is set from the Function mode (Fn) using the right arrow (➡) button navigate through the icons until a date is displayed. Press the OK button to change the setting. The user is prompted to select a date format required. The format, say M:D:Y, will flash. Use the up (⬆) or down (⬇) arrow buttons to scroll through the formats until the required format is flashing. Press the right arrow (➡) button to set the date format. The first part of the date will flash, adjust using the up (⬆) or down (⬇) arrow buttons pressing the right arrow (➡) button to set each date setting. After setting the date continue using the right arrow button (➡) and up (⬆) or down (⬇) arrow buttons to set time in hours and minutes. Press the OK button to set the date and time and return to the Function (Fn) mode.

GENERAL SPECIFICATIONS

Maximum jaw opening	39 mm
Maximum jaw inner dimensions	39 mm x 55 mm
Display type	4 digit + 6 digit with backlight
Battery type	4x 1.5 V IEC LR6 alkaline
Battery life	>24 hours continuous testing – see Note 1
Auto power down	300s (reset by jaw action or button press)
Data logging	256 records (DET14C) 2 k records (DET24C)
Data download	Data download via Bluetooth Instrument contains FCC ID: QQQWT12 and IC: 5132A-BGTW12A
Range selection	Automatic within each mode
Sample time	< 1s
Hold function	Yes with visual indicator
Alarm function	Yes with visual indicator
Warning buzzer	Yes
Operating temperature and humidity	-20 °C to +50 °C, <85% RH
Storage temperature and humidity	-40 °C to +60 °C, <75% RH
Weight	985 g
Instrument dimensions	248 mm (l) x 141 mm (w) x 49 mm (h)
IP rating	IP30 with jaws closed

Note 1: Whilst measuring a 25 Ω resistance

Safety	EN 61010-2-032 CAT IV 600 V, Pollution degree 2
--------	--

Measurement category IV is applicable to test and measuring circuits connected at the source of the building's low-voltage mains installation. This part of the installation is expected to have a minimum of one level of over-current protective devices between the transformer and connecting points of the measuring circuit.

Due to potential high short-circuit currents which can be followed by a high energy level, measurements made within these locations are extremely dangerous. Great precautions shall be made to avoid any chance of a short circuit.

MEASUREMENT SPECIFICATIONS

The following reference conditions define the allowable range in which the product may be calibrated.

Subsequent accuracy checks that occur under different conditions (but still within the allowable range of reference conditions) will incur operational error.

To overcome this, the instrument should be re-calibrated using the manual procedure contained in the service manual before any accuracy checks are made.

Reference Conditions

Temperature	+20 °C ± 3 °C
Humidity	50% RH ± 10%
Battery Voltage	6 V ± 0.2 V
Operating Position	Instrument horizontal
Conductor Position	Perpendicular to jaws and centred in the aperture
Current	Sinusoidal (THD <0.6%) at 50 Hz and 60 Hz
Resistance	Non-inductive
Interference Current	Nil
Interference Voltage	Nil
External Electrical Field	<1 V/m
External Magnetic Field	<40 A/m

Resistance Measurement

Ground Resistance Range	Resolution	Intrinsic Certainty
0.05 Ω to 0.99 Ω	0.01 Ω	±1.5% ±0.05 Ω
1.00 Ω to 9.99 Ω	0.01 Ω	±1.5% ±0.1 Ω
10.0 Ω to 99.9 Ω	0.1 Ω	±2% ±0.5 Ω
100.0 Ω to 199.9 Ω	0.1 Ω	±5% ±1 Ω
200 Ω to 400 Ω	1 Ω	±10% ±10 Ω
400 Ω to 600 Ω	1 Ω	±10% ±10 Ω
600 Ω to 1200 Ω	10 Ω	±20%
1200 Ω to 1500 Ω	10 Ω	±35%

Note 1: Frequency of measurement: 1390 Hz

Operational Error for Resistance

Parameter	Specification	Typical	Max
Operating Position	Instrument Horizontal	3.4%	12.9%
Conductor Position	E1 ±90 °	1.6%	9.7%
Battery Voltage	E2 4.4 V to 7.0 V	2.0%	18.0%
Temperature	E3 0 °C to +35 °C	2.1% / °C	6.3% / °C
Series interference voltage	E4 3V dc and 3V rms	DC: 9% AC: 0.98%	DC: 25.7% AC: 3.0%
Interference Current	3A rms	4.2%	-
Magnetic field	10 A/m 30 A/m 100 A/m	4.5% 3.6% 2.8%	13.0% 10.0% 8.0%

Current Measurement

Current Range	Resolution	Intrinsic Certainty
0.5 mA to 0.99 mA	0.01 mA	±2% ±0.05 mA
1.00 mA to 9.99 mA	0.01 mA	±2% ±0.05 mA
10.0 mA to 99.9 mA	0.1 mA	±2% ±0.1 mA
100 mA to 999 mA	1 mA	±2% ±1 mA
1.00 A to 9.99 A	0.01 A	±2% ±0.01 A
10.0 A to 35.0 A	0.1 A	±2% ±0.1 A

Operational Error for Current

Parameter	Specification	Typical	Max
Operating Position	Instrument Horizontal	0.26%	0.51%
Conductor Position	E1 ±30 °	0.65%	2.0%
Battery Voltage	E2 4.4 V to 7.0 V	0.69%	5.7%
Temperature	E3 0 °C to +35 °C	0.38% / °C	0.63% / °C
Distortion	E9	0.92%	3.9%
Magnetic Field	E11 10 A/m Class 3 30 A/m Class 2 100 A/m Class 1	1.1% 1.2% 2.5% >1.0 mA	5% 7% 25% > 1.0 mA
Load Current	E12 0.2 mArms to 35 Arms (50 Hz and 60 Hz)	1.2%	6.0%
Frequency of Current	E14 162/3Hz to 400 Hz	2.8% 50 Hz to 400 Hz 1% / Hz < 50 Hz	-
Repeatability	E15	0.72%	7%

Alarm Setting

Alarm Type	Range
Ω HI	0.05 Ω to 1500 Ω
Ω LO	0.05 Ω to 1500 Ω
A HI	0.5 mA to 35 A
A LO	0.5 mA to 35 A

Notes

1. All values are AC rms.
2. True RMS readings up to a crest factor of 5.0 (peak current 40 A).
3. Accuracy guaranteed for 50 Hz and 60 Hz.
4. Measurement over the range 16 Hz to 400 Hz.
5. Maximum current is 100 A rms continuous and 200 A rms for 60s max at 50 Hz and 60 Hz only.

ORDERING INFORMATION AND ACCESSORIES

DET14C Digital Earth Test Clamp-on meter	1000-761
DET24C Digital Earth Test Clamp-on meter	1007-331

Included Accessories (DET14C and DET24C)

Carrying case	1001-715
Carrying strap (wrist loop)	1001-716
User guide CD-ROM	1001-198
Calibration check	1001-498
Battery AA (Alkaline) (4 required)	25511-841

Included Accessories (DET24C)

PowerDB Lite software	1000-576
-----------------------	----------

PREVENTIVE INSTRUMENT MAINTENANCE

1. The DET series instruments require very little maintenance other than cleaning and calibration checks. It is recommended that the instrument's calibration is checked and adjusted, if necessary, on an annual basis.
2. It is extremely important that the mating jaw surfaces are free from damage or scratches.
3. Any damage will cause measurement problems, and if arising from misuse, will invalidate the warranty
4. It is extremely important that the mating jaw surfaces are kept as clean as possible to prevent measurement problems. Even the smallest amount of contamination or ice crystals will cause an excessive air gap between the mating jaw surfaces. This will result in either the clamp open (insert clamp symbol) warning appearing on the display or high value measurements being displayed when nothing has been clamped around, and can even affect lower value accuracy
5. It is recommended that the mating jaw surfaces are regularly cleaned using a damp lint free cloth. Do not use fluffy cloths that will leave fibres behind.
6. Occasionally or when measurement problems are experienced a lint free cloth dampened with isopropyl alcohol may be used to clean stubborn dirt from mating jaw surfaces
7. Ensure batteries are removed if the instrument is to be left unused for extended periods
8. When necessary the instrument case can be cleaned with a damp cloth

REPAIR AND WARRANTY

The instrument circuit contains static sensitive devices, and care must be taken in handling the printed circuit board. If the protection of an instrument has been impaired it should not be used, and be sent for repair by suitably trained and qualified personnel. The protection is likely to be impaired if, for example, the instrument shows visible damage, fails to perform the intended measurements, has been subjected to prolonged storage under unfavourable conditions, or has been exposed to severe transport stresses.

Note: Any unauthorised prior repair or adjustment will automatically invalidate the Warranty. Instrument Repair and Spare Parts

For service requirements for Megger Instruments contact:

Megger Limited
Archcliffe Road
Dover
Kent
CT17 9EN
England

Tel: +44 (0) 1304 502100
Fax: +44 (0) 1304 207342

Megger
Valley Forge Corporate
Center
2621 Van Buren Avenue
Norristown PA
19403
USA

Tel: +1 (610) 676-8500
Fax: +1 (610) 676-8610

Megger
4271 Bronze Way
Dallas TX
75237-1017
USA

Tel: +1 (800) 723-2861
(U.S.A. only)
Tel: +1 (214) 330-3203
(International)
Fax: +1 (214) 337-3038

or an approved repair company.

Approved Repair Companies

A number of independent instrument repair companies have been approved for repair work on most Megger instruments, using genuine Megger spare parts. Consult the Appointed Distributor / Agent regarding spare parts, repair facilities and advice on the best course of action to take.

Returning an Instrument for Repair

If returning an instrument to the manufacturer for repair, it should be sent freight pre-paid to the appropriate address. A copy of the invoice and of the packing note should be sent simultaneously by airmail to expedite clearance through Customs. A repair estimate showing freight return and other charges will be submitted to the sender, if required, before work on the instrument commences.

END OF LIFE

WEEE

The crossed out wheeled bin placed on the Megger products is a reminder not to dispose of the product at the end of its product life with general waste.

Megger is registered in the UK as a Producer of Electrical and Electronic Equipment.

The Registration No is WEE/HE0146QT

Batteries

The crossed out wheeled bin placed on the batteries is a reminder not to dispose of them with general waste at the end of their life.

This product contains four alkaline AA batteries located in the battery compartment on the rear of the instrument

Spent alkaline AA batteries are classified as Portable Batteries and should be disposed of in the UK in accordance with Local Authority requirements.

For disposal of batteries in other parts of the EU contact your local distributor. Megger is registered in the UK as a producer of batteries. The registration number is BPRN00142

Megger Limited
Archcliffe Road
Dover
Kent
CT17 9EN
England

Tel: +44 (0) 1304 502100
Fax: +44 (0) 1304
207342

Megger
Valley Forge Corporate Center
2621 Van Buren Avenue
Norristown PA
19403
USA

Tel: +1 (610) 676-8500
Fax: +1 (610) 676-8610

Megger
4271 Bronze Way
Dallas, TX
75237-1017
USA

Tel: +1 (800) 723-2861 (U.S.A. only)
Tel: +1 (214) 330-3203

(International)
Fax: +1 (214) 337-3038

Megger SARL
Z.A. Du Buisson de la Couldre
23 rue Eugène Henaff
78190 TRAPPES
France

Tel : +33 (1) 30.16.08.90
Fax : +33 (1) 34.61.23.77

This instrument is manufactured in the united kingdom.

The company reserves the right to change the specification or design without prior notice.

Megger is a registered trademark.

DET14C--DET24C_UG_EN_V09 -- 11 NOVEMBER 2015 1:28 PM

www.megger.com