

Waterbath

WTB6

Ideal for the temperature control of ointments, emulsions, samples, plates and nutrient solutions in the laboratory, as well as warm storage and calibration in the industrial segment



On this page, you can find all the essential technical data on the Memmert water bath. Our customer relations team will be pleased to help if you want further information. If you should require a customised special solution, please contact our technical specialists at sales@memmert.com.

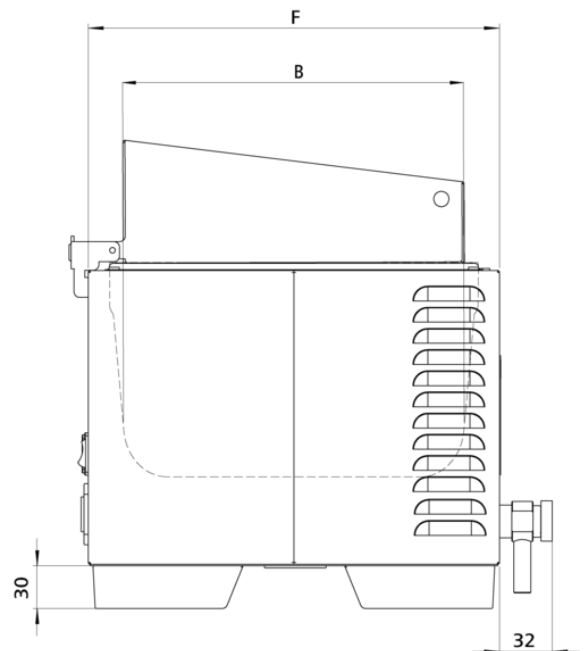
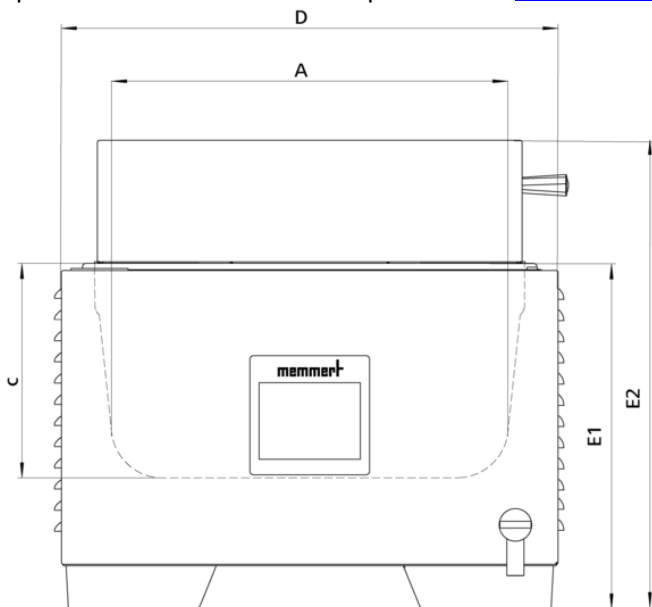

Temperature

Temperature sensor	digital temperature sensor, mounted on the outside of the bath
Temperature	Setting Celsius / Fahrenheit
Working temperature range	at least 5 above ambient to +100 (depending on ambient pressure)
Setting temperature range	+10 to +100 °C
Setting accuracy temperature	0.1 °C

Control technology

Calibration	2-point calibration
Controller	intuitive 3.5" colour graphic display with touch screen
Controller	digital display of set and actual temperature and of (remaining) programme time

Safety

Temperature control	two-stage safety system to prevent overtemperature
Temperature control	individually adjustable overtemperature alarm, visual and acoustic
Temperature control	Independent temperature limiter to switch off the heating in case of failure
Autodiagnostic system	microprocessor PID-temperature controller with integrated autodiagnostic system with fault indicator

Heating concept

Heating	corrosion-proof large-area heating on the outside of the interior
----------------	---

Standard equipment

Drain system	innovative drain system - easy to empty
Timer	digital timer from 1 min. up to 99 hours 59 min., visual and acoustic

Stainless steel interior

Interior	Deep-drawn stainless steel tray (stainless steel W.St. 1-4301), without corners and edges for easy cleaning incl. central drain (no disturbing installations)
Dimensions W x H x D in mm	$w_{(A)} \times h_{(C)} \times d_{(B)}$: 277 x 150 x 217 mm
Volume	7 l
Liquid level min.	40 mm

Textured stainless steel casing

Dimensions $w_{(D)} \times h_{(E2)} \times d_{(F)}$: 349 x 348 x 289 mm

Electrical data

Voltage 230 V, 50/60 Hz

Electrical load approx. 1000 W

Voltage 115 V, 50/60 Hz

Electrical load approx. 1000 W

Ambient conditions

Installation The vent openings in the left and back side must remain unobstructed. Minimum wall spacing on all sides is 80 mm. The minimum spacing from the top of the bath to the next ceiling is 750 mm.

Ambient temperature +5 °C to +40 °C

Humidity rh max. 80 %, non-condensing

Overvoltage category II

Pollution degree 2

Packing/shipping data

Transport information The appliances must be transported upright

Customs tariff number 8419 8998

Country of origin Federal Republic of Germany

WEEE-Reg.-No. DE 66812464

Dimensions approx incl. carton w x h x d: 570 x 450 x 420 mm

Net weight approx. 6 kg

Gross weight carton approx. 10 kg

Standard units are safety-approved and bear the test marks

