



875 Bassett Rd.
Westlake Ohio 44145 USA
(800) 817-7890
WesternEnterprises.com
Meriam.com

User Manual

Manufacturer of innovative compressed gas fittings, regulators and measurement tools.

Autoclave Analyzer

AA100



Contents

General Information	4
Notification Statements.....	4
Warranty	5
General warnings and cautions	6
Preventing injury	6
Safety symbols.....	6
For your safety	7
Perform these checks each time	7
Autoclave Analyzer	9
Features of the Autoclave Analyzer	9
Optional: Accessories kit	10
Optional: Accessories kit specifications	10
Connect an autoclave to the Autoclave Analyzer	12
Application	13
Six colored controls.....	13
Touch screen or mouse	13
Three modes in the application	13
Power up Autoclave Analyzer	14
Set Date and Time.....	14
Setup mode	14
Test mode	18
Review mode.....	19
Graphing data.....	19
Application update rates.....	21
Settings button	21
Menu button	23
Specifications	25
Power Requirements.....	25
Pressure measurement.....	25
Temperature measurement.....	25
Environmental range	26
Display	26
Materials	26
Certifications	26
Dimensions.....	26
Weight	26
Maintenance and cleaning	27
Don't void your warranty	27
Cleaning.....	27
Recommended maintenance	27
Prepare for storage	27
Recycling compliance.....	27
Troubleshooting	28

Temperature measurements display ???	28
No measurements in the graph	28
The application didn't start automatically	28
Help	29
Register your product	29
Find downloads and documents	29
Returning for repair or calibration	30
Western Contact Information	31

General Information

Notification Statements

Disclaimer

Autoclave Analyzer is a diagnostic instrument for measuring temperature & pressure of Autoclave sterilization systems. The Autoclave Analyzer is not used to verify successful sterilization. The Autoclave Analyzer is not a medical device, and does not have an FDA product class.

Every precaution has been taken in the preparation of this manual. Nevertheless, Western / Scott Fetzer Co. assumes no responsibility for errors or omissions or any damages resulting from the use of the information contained in this publication, including, without limitation, incidental, special, direct or consequential damages. Western / Scott Fetzer Co. MAKES NO REPRESENTATIONS OR WARRANTIES WITH RESPECT TO THE ACCURACY OR COMPLETENESS OF THE CONTENTS HEREOF AND SPECIFICALLY DISCLAIMS ANY IMPLIED WARRANTIES OF MERCHANTABILITY OR FITNESS FOR ANY PARTICULAR PURPOSE. Western / Scott Fetzer Co. reserves the right to revise this publication and to make changes from time to time in the content hereof without obligation to notify any person of such revision or changes.

In no event shall Western / Scott Fetzer Co. be liable for any indirect, special, incidental, consequential, or punitive damages or for any lost profits arising out of or relating to any services provided by Western / Scott Fetzer Co. or its affiliates.

It is not possible for Western / Scott Fetzer Co. to identify all foreseeable uses or misuses, therefore all persons involved in commissioning, using, or maintaining this product must satisfy their self that each intended application is acceptable.

The intended product service life is 10 years.

Copyright

This publication is proprietary to Western / Scott Fetzer Co. and no ownership rights are transferred. Neither this manual, nor any of the material contained herein, may be reproduced without the prior written consent of Western / Scott Fetzer Co..

Trademark information

Trademark statement

All other trademarks are the property of their respective owners.

Warranty

Components of this system are warranted under use against any and all manufacturing defects from the listed date of manufacture for six (6) years.

Other components are covered by their manufacturers' warranties. Any failure resulting from defective parts or faulty workmanship, as determined during evaluation by the manufacturer, will be repaired under warranty. This warranty will be null and void for any unit that has been subject to misuse, negligence, accident, or repairs other than those performed by an approved affiliate of Western / Scott Fetzer Co.

General warnings and cautions

Preventing injury

Failure to follow all instructions could result in injury:



- Read the entire manual before using the Autoclave Analyzer.
- Understand the contents before using the Autoclave Analyzer.
- Follow all safety warnings and instructions provided with this product.

Safety symbols

The following table defines the safety symbols, signal words, and corresponding safety messages used in the manual. These symbols:

- Identify potential hazards.
- Warn you about hazards that could result in personal injury or equipment damage.

Safety symbols	Explaining the symbols
DANGER	Indicates a potentially hazardous situation which, if not avoided, will result in death or serious injury.
WARNING	Indicates a potentially hazardous situation which, if not avoided, could result in death or serious injury.
CAUTION	Indicates a potentially hazardous situation which, if not avoided, could result in minor or moderate injury.
NOTICE	Indicates information essential for proper product installation, operation or maintenance.

For your safety

Fire and explosion hazard

⚠ DANGER

- Never use the Autoclave Analyzer in hazardous areas.
- Don't open the Autoclave Analyzer case. There are no customer serviceable components inside. Opening the case voids the warranty.
- Substitution of components may impair operation and safety.

Pressure limits

⚠ WARNING

- Don't exceed the sensor limit.
- Full Scale calibrated range = 110 % of range.
- Compound Isolated (CI) unit: 2x range
- Failure to operate within the specified pressure limit could result in death or serious injury.
- Exceeding limits can permanently damage the sensors.

Protect the Autoclave Analyzer

⚠ CAUTION

- Protect the Autoclave Analyzer from water or liquid spills.

Prevent trip hazards

⚠ CAUTION

1. Don't suspend any hose, cable, or input connections from the device.
2. Watch out for hoses, cables, or power cords when you set up device connections.

Perform these checks each time

1. Check the specified pressure and temperature connection types and rating ranges for accessories.
2. Only use accessories from other vendors that match the connection type or ratings of the device sensors.
3. Examine the power cord and adapter to make certain they are not damaged.
4. Place the device on a flat, stable surface before connecting cables or hoses.

5. Check the steam pressure hoses to make certain they have no cracks, holes, defects, or unusual wear and tear.
6. Look for cracks, residue, or other damage around the sensor ports. If you see any, **don't use the device**. Contact the appropriate personnel.
7. Check all input, hose, and cable connections to make sure they are correctly and securely attached.
8. Check the computer screen to make sure it is not cracked or damaged.

NOTICE

1. Don't let sharp or hard objects touch the screen.
2. Using the device above 6561 ft (2000 m) may display unreliable results.

Autoclave Analyzer

Features of the Autoclave Analyzer

Included with the Autoclave Analyzer:

- 10.2 in. touchscreen computer.
- Four RTD temperature sensors
- Two Compound Isolated 100 psi pressure sensors.
- One wireless keyboard and mouse.
- Power cord/AC adaptor

Serial number

The serial number is located on the bottom of the case.

Sensors

Use two wrenches to install or remove pressure connections

Connection: 1/8 in. female NPT, 316LSS.

- Use PTFE tape for NPT fittings.
- Always use a 3/4 in. wrench on the pressure manifold when you install or remove the 1/8 in. NPT fitting.
- Applying torque to the manifold can damage the enclosure and voids the warranty.
- Don't over tighten.

Sensor manifold types



No serviceable customer parts

NOTICE

If you open the case, you void the warranty.

Optional: Accessories kit

- Four 3.3 m 4 pin M12 M-F A coded cables.
- Two 3 m FVCO-FVCO 100 psi minimum rated steam pressure hoses.
- Four 1/8 in. MNPT-MVCO pressure fittings.
- Four Class A RTD M12 A coded probe connectors.

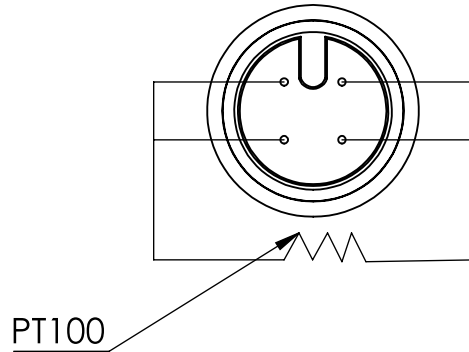

Optional: Accessories kit specifications

RTD temperature probe limits

- Functional range: -50 °C to 120 °C

RTD temperature probe accuracy

- Tolerance: $\pm (0.15 + 0.002[t])^\circ\text{C}$
- End to end probe inclusive.

Note: End to end probe inclusive accuracy only applies when using our recommended Class A PT100 RTD probe or your own vendor equivalent.

RTD temperature probe type

- Pt100 Class A, 4-Wire Platinum RTD Elements per IEC 60751 Standard.
- M12 connection.

Pressure hoses limits

- Maximum allowable working pressure is 800 psi at 70 °F.
- Rated temperature range: -65 °F to 450 °F.

Pressure hose type

- Connection material: 316 Stainless Steel.
- Collar Material: 300 Series Stainless Steel.
- Hose core material: PTFE.
- Hose cover material: Fiber braid.
- Connection 1 size: 1/4 in.

- Connection 1 type: VCO O-Ring face seal fitting.
- Connection 2 size: 1/4 in.
- Connection 2 type: VCO O-Ring face seal fitting.

Connect an autoclave to the Autoclave Analyzer

The method of connecting the Autoclave Analyzer may differ from device to device. The Autoclave Analyzer is designed to give the operator maximum flexibility during test set up.

Customers can choose to purchase the optional accessories kit P/N ZAA101 or use their own vendors to purchase hoses, cables, and RTD probes to meet their requirements.

1. Connect the power cord to Autoclave Analyzer and plug in the AC power adapter.
2. Inspect the pressure hoses, temperature cables, and probes.
3. Install the RTD probes into the autoclave under test. Connect the M12 cables between the RTD probes and the Autoclave Analyzer.
4. Connect the hoses to the Autoclave Analyzer. An adapter fitting may be necessary. Use PTFE tape for NPT fittings.
5. Connect the other ends of hoses to the appropriate fittings installed into the autoclave under test.
6. Connect keyboard and mouse.
7. Turn on the device and wait for the **Setup** mode to appear.
8. Zero the pressure sensors. Zeroing removes the change in atmospheric pressure.
9. Set required measurement units and sensor names.
10. Confirm the Autoclave Analyzer is reading reasonable process values.
11. Set the test parameters you require: Operator, Location, Test name, Interval, Duration.
12. Setup cycle for autoclave under test.
13. Press the **Record** button on the Autoclave Analyzer.
14. Start the autoclave cycle.
15. Add process notes to the report as needed.
16. Wait for the test to complete, or manually stop it.

Note: The test automatically stops after the specified duration or after you tap Stop. Review mode appears after the test stops.

17. Review the test graph.
18. Transfer data to the USB drive to analyze the data later.
19. Tap the **Return** button to view Live data in the six indicators.

Application

Six colored controls

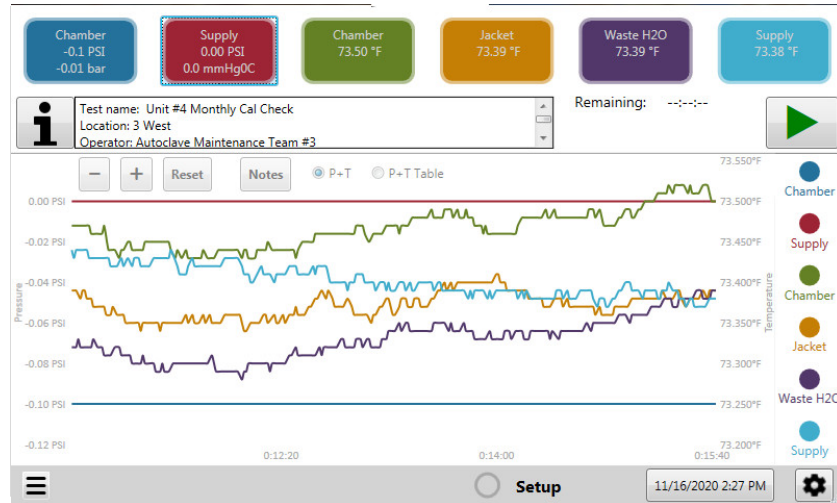

Six measurement controls

- Six controls at the top of the screen display measurements as soon as you connect the cables.
- Six different colors are used to distinguish the six sensors.
- Tap each control to make changes.

Six visibility controls

- The six visibility controls are circles on the right side of the graph. They match the colors of the six measurement indicators.
- Tap a visibility control to hide or display a measurement line in the graph.

Touch screen or mouse

Two options are available:

1. Tap the touch screen.
 2. Click with a mouse and use the keyboard.
- Keyboard and mouse dongle are located in the mouse battery compartment and plugs into the USB connection on the unit.

Three modes in the application

The application has three modes of operation:

1. Setup mode.
2. Test mode.
3. Review mode.

Power up Autoclave Analyzer

- Press the power button located on the front of the Autoclave Analyzer (next to the Meriam logo)
- The Autoclave Analyzer will go through a boot up sequence and then go directly into setup mode
- Ensure that all sensors are properly connected before powering on device or display/data errors may occur.

Set Date and Time

Check the date and time on the **Setup** screen

- Autoclave Analyzer uses the date and time displayed in the corner of the screen for the timestamp in reports.
- Tap the time in the right hand corner to change the date and time.
- Attaching the USB mouse and keyboard may make changing the Date and Time settings easier for you.

NOTICE

You can't change the **date format** or the **time format**.

Setup mode

Overview of Setup mode

The application opens in the **Setup** mode.
Configure all test settings in this mode.



Test information in Setup mode

To edit test information select the  button near the top of the setup screen. This moves you to the Test Setup display. These fields have limits on the number of characters you may enter.

Enter the test specific information into these fields:

- **Test name** has a limit of 32 characters.
- **Operator** has a limit of 32 characters.
- **Location** has a limit of 32 characters.
- **Sampling** has a maximum rate of 1 per second and minimum rate of 1 per 60 seconds.
- **Duration** has a minimum of 10 minutes. As soon as the duration for a test completes, Autoclave Analyzer switches to Review mode.
- All fields must be entered before test can be executed.
- A yellow bar at the right hand side of a field indicates the data is not valid , or the character limit has been reached.

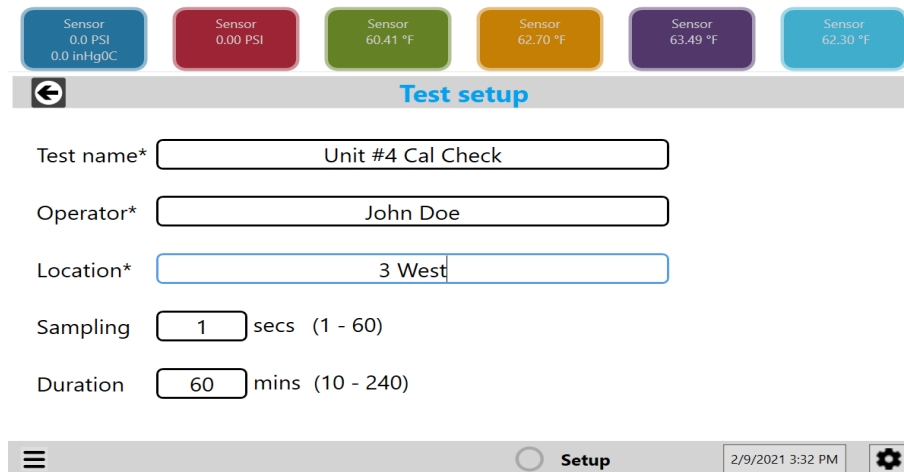

The screenshot shows the 'Test setup' screen. At the top, there are six sensor status boxes: 0.0 PSI (0.0 inHgOC), 0.00 PSI, 60.41 °F, 62.70 °F, 63.49 °F, and 62.30 °F. Below these is a grey bar with a left arrow icon and the text 'Test setup'. The main area contains five input fields: 'Test name*' with 'Unit #4 Cal Check', 'Operator*' with 'John Doe', 'Location*' with '3 West', 'Sampling' with '1' and 'secs (1 - 60)', and 'Duration' with '60' and 'mins (10 - 240)'. At the bottom is a grey bar with a menu icon, a radio button labeled 'Setup', a timestamp '2/9/2021 3:32 PM', and a settings gear icon.

Select the left arrow near the top left of screen to exit.

Functions in Setup mode

Pressure indicators

The two pressure indicators display the following information:

- Sensor name
- Current measurement values
- Units of measurement

Pressure features

Tap a pressure indicator to view the following items: current values, range, calibration date, serial number and firmware revision. They display in a table on the right.

- Set the primary and secondary units of measurement for all pressure sensors
- Set a specific sensor's name
- Zero a specific sensor
- Exit the indicator by tapping the **indicator** button again.

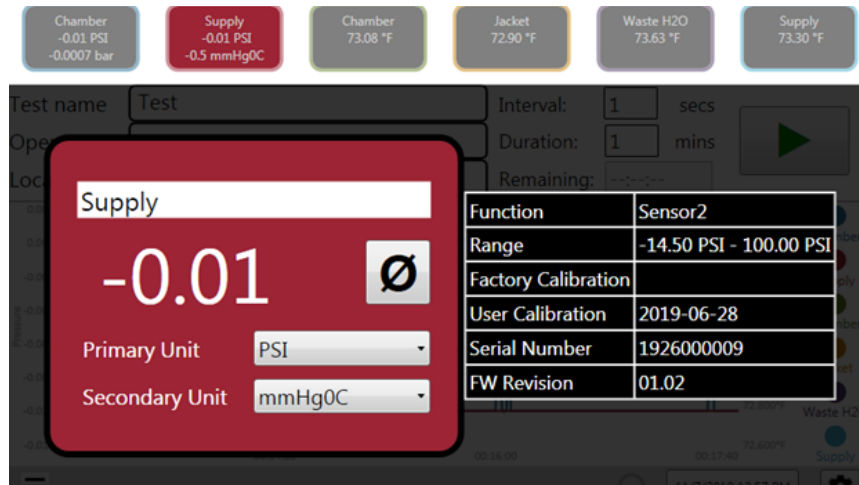

Temperature indicators

The four temperature indicators display:

- Sensor name
- Current measurement values
- Unit of measurement

Temperature features

Tap a pressure indicator to view the following items: current values, range, calibration date, serial number and firmware revision.

- Set the unit of measurement for all temperature sensors
- Set a specific sensor's name
- Exit the indicator by tapping the **indicator** button again.

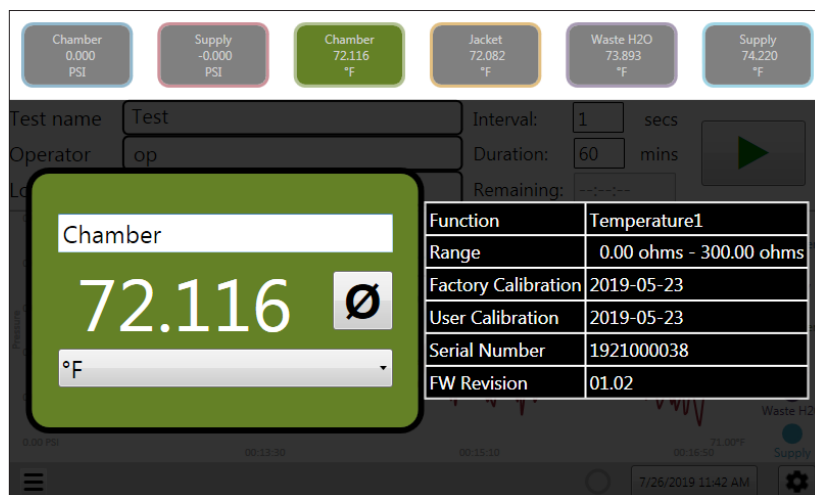

Power off the Autoclave Analyzer

- Tap the **Menu**  button to shut down.

Start test

From the **Setup** screen, you start a test.



Review prior test files

You may review prior test files before configuring or starting a new test by tapping the **Menu** button.

Test mode

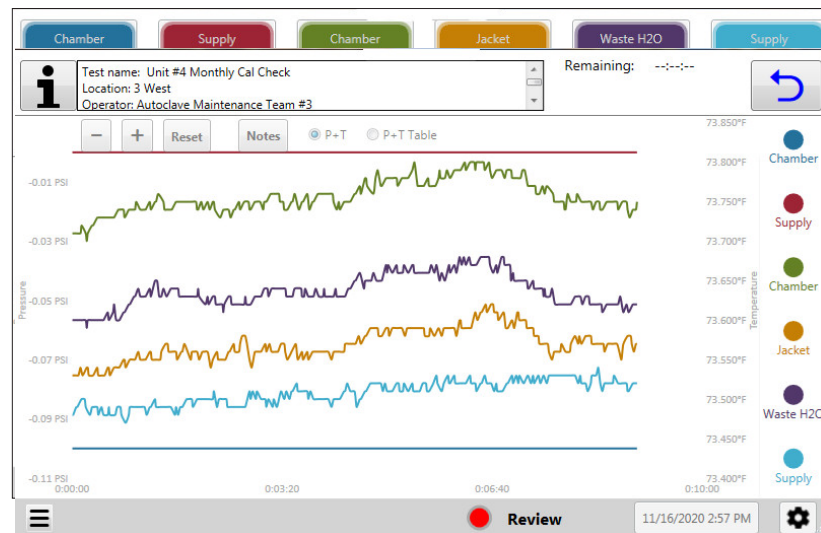
Test information in Test mode

*Record button*

When you tap the **Record** button , data logging begins and the **Stop** button  appears. Data logging:

1. Clears the graph.
2. Starts a new data log file.
3. Locks the Test information text boxes: Test name, Operator, Location, Interval, and Duration.
4. Locks all sensor indicators for pressure and temperature.
5. Saves all data in a file for review.
6. Displays a count down based on the time set in **Duration**.

Add note button 



Add a note at any point while the record is active. Notes are timestamped and added to the beginning of a data log file.

Stop button

When you tap the **Stop** button , data logging stops and the **Return** button  appears. Data logging:

1. Stops taking measurements.
2. Stops the graph.
3. Creates a report.
4. Stops and Review mode opens.

Return button

When you tap the **Return** button , the Setup screen displays and the **Record** button  appears.

- The test information boxes can be edited.
- The graph resets and starts to display live data.

Review mode

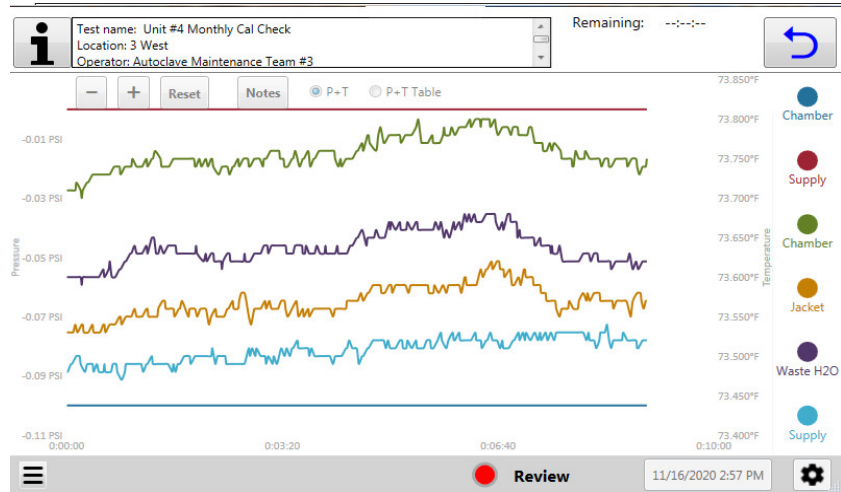

What can you do in review mode?

- View the completed test data in a static graph.
- View the file from the most recent test or any of the tests you have previously run in the graph.
- View the notes added during a test.
- Transfer files to USB drive.
 - Tap the **Menu** button.
- Review a prior test.
 - Tap the **Menu** button.
- Shut down the Autoclave Analyzer.
 - Tap the **Menu** button.

Graphing data

The graph displays in all three modes.

1. Setup
2. Test mode
3. Review mode



What happens to the graph in all modes?

- Hide or display measurement lines on the graph by clicking the visibility buttons along the right side.

What is different about the graph in each mode?

- In **Setup** mode, the graph starts from right to left. View live readings, but these are not recorded.
- In **Test** mode, the graph starts from left to right. View what Autoclave Analyzer is recording in your report. The / / control buttons are active.
- In **Review** mode, the graph displays data from the entire duration of the selected test. The graph does not advance. The / / control buttons are active

Status circle

- Solid **Gray**  means no data logging.
- Blinking **Green**  means data logging is recording data.
- Solid **Red**  means Autoclave Analyzer is locked while you review the log reports.

Note: The Menu, Setting, and indicator buttons are unavailable when the status circle is red.

Application update rates



Graph update rates

- The graph updates once every **one second**.

Data Logging update rates

- Data logging update rates are based on the interval you selected in the **Setup** screen.
- Data logging stops when you tap the **Stop**  button.

Settings button

- Tap the **Settings** button  to delete logs, view system information, calibrate the touch screen, and update the firmware and application from a USB drive.
- Tap the **Settings** button  again to return to the **Setup** screen.

Delete logs

- **Delete logs** button.
- Select one or all files to delete them.

Storage status

- A pie chart with the percentage displays the remaining storage space.

Update

- Plug a USB drive in the USB port to update the Autoclave Analyzer. This button is only active when a USB is plugged in.
- Click the **Update** button to begin.
-

Calibrate Touch Screen (Cal Touch)

- Tap the **Cal Touch** button to perform a calibration of the computers touch screen.
- Follow the on screen prompts to touch and hold the target points for calibration.

System Information

- Device Application Revision
- Sensor Firmware
- Serial Number
- Model Name

The screenshot displays the Autoclave Analyzer's main interface. At the top, there are six status indicators in colored boxes: Chamber (-0.01 PSI, -0.0003 bar), Supply (-0.01 PSI, -0.4 mmHg0C), Chamber (73.90 °F), Jacket (73.68 °F), Waste H2O (74.08 °F), and Supply (74.07 °F). Below these is a 'Settings' section. On the left, a pie chart shows 71.79% remaining storage, with 28 GB of 39 GB remaining. On the right, a table lists system parameters: System Serial Number (0123456789), System Model Name (model), SW (1.0.5.10), and five Sensor entries (01.02, 01.02, 01.02, 01.01, 01.01). At the bottom, there are buttons for 'Delete logs', 'Cal Touch', and 'Update'. The footer shows a hamburger menu, a power button, and the date/time '11/6/2019 12:37 PM' with a settings gear icon.

Settings	
System Serial Number	0123456789
System Model Name	model
SW	1.0.5.10
Sensor	01.02
Sensor	01.02
Sensor	01.02
Sensor	01.01
Sensor	01.01
Sensor	01.01

Menu button

The menu button  provides you with these options:

- **Open prior test**
- **Transfer files**
- **Power off**

Open prior test data

- Select any prior test file to display its data in the graph or table.
- **Open** button.

Transfer files

- Select the file to transfer and tap the **Transfer One** button to transfer one file to the USB drive.
- Tap the **Transfer All** button to transfer all files to a USB drive.
- Log report names appear as duplicates. One file is TSV format and the other is PDF format.
- The folder name is **"AA"**.

NOTICE *You can't transfer files from USB drive to the Hard disk and you can't copy files on the hard disk.*



Shutdown

NOTICE

Don't unplug the power cord while the application is running.

1. Tap **Power off** from the menu button.
2. After the computer turns off, unplug the power cord.

*Note: Pressing the **Power** button and holding it for four seconds, shuts down the device.*

Power button

The power button is located on the front panel. The Meriam logo is on the left and the **Power** button is on the right.

All the data during a test is lost when:

NOTICE

1. The power plug is unplugged.
2. The power goes out.
3. The **Power** button is pressed and held, the device turns off.

Remember: No batteries are in this device.

Specifications

Power Requirements

Wall adaptor

- Input: 100 V ac to 240 V ac 50/60 Hz.
- Output: 12 V dc @ 2-3 A with 4 Pin Mini Din plug.

Autoclave Analyzer device

- Input: 12 V dc to 24 V dc @ 3 A maximum with 4 Pin Mini Din port.

Pressure measurement

Pressure sensor limits



- Minimum rated pressure: -14.5 psi.
- Maximum rated pressure: 100 psi gauge:
- Don't exceed the sensor limit of -14.5 psi to 100 psi.
- Full Scale calibrated range = 110 % of range.
- Compound Isolated (CI) unit: 2x range.

Pressure sensor accuracy

- = \pm (0.02 % of reading + 0.005 % of Full Scale)
total error band from -20 °C to 50 °C.

Pressure sensor type

- The Compound Isolated type of pressure sensor can be used with gases and liquids compatible with 316LSS.
- 1/8 in. female NPT, 316LSS connection.

Temperature measurement

RTD temperature sensor limits

- 100 Ω at 0 °C, 0.00385 TCR (alpha).
- Functional sensor limits: -50 °C to 250 °C (-58 °F to 482 °F)

Temperature sensor accuracy

- \pm 0.3 °C total error band from -20 °C to 50 °C.

Temperature sensor type

- Pt100 Class A, 4-Wire Platinum RTD Elements per IEC 60751 Standard.

Environmental range

Operate and store this device in climate controlled facilities.

- Operating: 5 °C to 40 °C (41 °F to 104 °F)
- Storage: 0 °C to 60 °C (32 °F to 140 °F)

Display

- 10.2 in. diagonal touchscreen with resistive touch
- 800 × 480 pixels

Materials

- Enclosure: Aluminum.
- End caps: PC + ABS
- Soft case: Nylon.
- Sensor manifolds: Stainless steel 316.

Certifications

- NIST traceable certificates for pressure and temperature modules.

Dimensions

- External dimensions: Length × Width × Depth:
32 cm × 23 cm × 10 cm (12.5 in × 9.0 in × 3.9 in).

Weight

- Device = 9.0 lb
- Device in softcase = 12.0 lb

Warm up time

- 5 minutes

Maintenance and cleaning

Don't void your warranty

NOTICE

Don't attempt to repair the Autoclave Analyzer or the warranty is void.

Cleaning

- Turn off the device and unplug the power cord before cleaning.
- Clean the device once a month using a damp, lint-free cloth—water or isopropyl alcohol only.

Recommended maintenance

- Western / Scott Fetzer Co. recommends that you return the Autoclave Analyzer once a year for calibration.
- The device displays the last calibration date on-screen when you click a sensor's indicator.

Prepare for storage

- The recommended storage temperature is between:
0 °C to 60 °C (32 °F to 140 °F).

Recycling compliance

Dispose of the Autoclave by following the applicable electronic recycling guidelines in your area.

Troubleshooting

Temperature measurements display ???

The RTDs are not properly connected.

1. Check the connections of the RTD cable on the panel and on the RTD.
2. If the connections are good, then swap the cable at the port.

Did the dashes follow the cable?

Yes - the port is ok.

No - the port is the problem not the cable.

If **yes**, then swap the cable at the probe.

Did the dashes follow the cable?

Yes - the cable is the problem.

No - the probe is the problem.

No measurements in the graph

Pressure and temperature measurements don't appear in the graph.

1. The visibility controls may be turned off. Tap them to see if they turn on.
2. The networked sensors may have locked up.
3. Turn the Autoclave Analyzer off.
4. Unplug the Autoclave Analyzer
5. Wait 1 minute.
6. Turn the Autoclave Analyzer on.

The application didn't start automatically

1. Press and hold the power button to turn the device off.
2. Press the power button to turn the device on.

Help

Register your product

We want you to get the most out of your purchase, and that starts with a few, easy registration steps.

1. Go to www.meriam.com
2. In the **Product Registration** section, **Register a product.**

Find downloads and documents

1. Go to www.meriam.com.
2. In the **Technical Resources** section, **Learn More.**
3. Select one of these categories to find the files you need:
 - Product manuals** | *User Manuals and Quick Start Guides*
 - Downloads** | *Applications (software), firmware, updates, installation instructions*
 - Certifications** | *Certifications and approvals*
 - SDS (MSDS)** | *Safety Data Sheets*
 - Control Drawings** | *Intrinsically Safe Drawings*

Returning for repair or calibration

If the device cannot be zeroed, calibrated, or is damaged, it must be returned to the factory for servicing.

First — Request a number

In the event that a device requires service and must be returned, please contact Western / Scott Fetzer Co. using one of the methods listed in the following table to request a Return Material Authorization (RMA) number.

Method	Provide the following information
Website	http://www.meriam.com/resources/service-repair-authorization/ Complete the information online and submit the form.
Fax	If you printed and completed the Service & Repair Authorization form, then fax it to: US and International Customers + 1 216 281 0228
Email	We need the following information in the email: <ul style="list-style-type: none"> ▪ Look on the product label to find the model number & the serial number. ▪ Give a brief description of the problem. ▪ Send the e-mail to: returnforms@westernenterprises.com

Return Material Authorization

- Do not send any unit for repair unless you contacted Western / Scott Fetzer Co. for a Return Material Authorization (RMA) number.
- Important: If you have not received this number and have not clearly marked it on the package being shipped back, we will return the unit at your expense.
- The Western Service & Repair Department will provide you with this number when you complete the website form, fax or e-mail your information.
- An RMA number must accompany all incoming packages to insure proper tracking, processing, and repair work.

Questions? Call Western / Scott Fetzer Co.

US Customers..... (800) 817-7849

International Customers + 1 216 281 1100

Ship the box to

Western / Scott Fetzer Co.
10920 Madison Avenue
Cleveland Ohio 44102 USA

Western Contact Information

Meriam brought to you by Western / Scott Fetzer Co.

Address

Western / Scott Fetzer Co.
10920 Madison Avenue
Cleveland Ohio 44102 USA

Telephone

- US customers (800) 817-7849
- International customers + 1 216 281 1100

Fax

- US and International customers + 1 216 281 0228

E-mail addresses

- Return Material Authorization and Service and Repair
Department
returnforms@westernenterprises.com

Websites

WesternEnterprises.com
Meriam.com

Find a local Meriam representative

Use this map to help you find a Meriam representative.

- <http://www.meriam.com/representatives-map/>