

MITUTOYO PRODUCT FUNDAMENTALS

AN ESSENTIAL GUIDE OF MITUTOYO PRECISION
TOOLS AND INSTRUMENTS

GENERAL



Outside micrometers are industry standard measuring tools because of their high accuracy and resolution and ease of use. Mechanical OD micrometers are available in .001" and .0001" (0.01mm and 0.001mm) graduations. Electronic OD micrometers normally have .0001" or .00005" and 0.001mm resolutions. Standard OD micrometers are available up to 40"/1,000mm, but larger OD micrometers can be manufactured as a special-order item.

The accuracy of a micrometer is derived from several factors. The most significant factors are: 1) thread accuracy, 2) flatness of measuring faces, 3) parallelism between the faces and 4) rigidity of the frame which holds the anvil and spindle.

OD micrometers are available in a variety of spindle and anvil configurations to allow the operator to measure difficult-to-reach features on a workpiece. The measuring range on a typical OD micrometer is 1" (25mm). Some special application micrometers have a smaller or greater range than 1" (25mm).

Wide range OD micrometers (interchangeable anvil micrometers) are available and reduce the cost of a micrometer set versus the cost of individual micrometers to cover the same range (typically a 6" range).

Micrometer standards are used to verify (not calibrate) the zero opening position on micrometers when the micrometer spindle doesn't contact the micrometer anvil, such as micrometers over 1" (25mm) and some specialty micrometers.

What makes a micrometer work

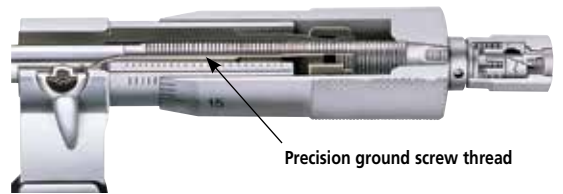

Precision ground screw thread

The precision ground thread on the spindle is the basis for a micrometer's high accuracy and resolution. An English micrometer spindle uses 40 TPI. One revolution of the spindle advances the measuring face by .025". The sleeve is graduated every .025", and the thimble is graduated every .001". In addition, the sleeve may have a vernier scale that allows the operator to resolve the micrometer reading to .0001".

Parts of a Micrometer



The measuring faces are important too

In order to ensure an accurate measurement, the measuring faces of a micrometer must be both flat and parallel. Micrometer measuring faces (anvil and spindle) are normally faced with carbide to reduce wear caused by repeated use. Hardened steel is sometimes used as the measuring face to reduce manufacturing cost.

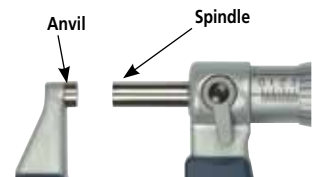

Micrometer Thimbles

Several types of thimbles are available on micrometers--a plain thimble (no constant force device) or with constant force device. The constant force device helps the operator apply a consistent amount of torque to the thimble for every measurement. A constant force device helps ensure that deviations in measurements between operators are minimized. In addition, a "speeder" is available for plain thimbles, ratchet stop and ratchet thimble micrometers. Speeders reduce the time it takes to open or close the micrometer spindle.

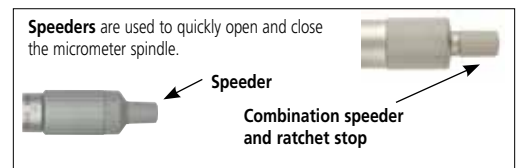

Plain Thimble

The plain thimble's advantage is reduced cost. The disadvantage is its reliance on operator "feel" to ensure accurate measurements.



Friction Thimble

The chief advantage of the friction thimble is the close proximity to the operators hand, allowing an operator to use the mic one-handed and still use the friction thimble. Friction thimbles are generally not used on mics over 2". The disadvantage is a somewhat "mushy" feel and a lack of audible feedback.



Ratchet Stop

The advantage of the ratchet stop is the tactile and audible feedback. A speeder is incorporated in the ratchet stop to reduce the time it takes to open or close the mic. The disadvantage is that it usually takes two hands to make a measurement. This is not a disadvantage on larger mics (over 2").



Ratchet Thimble

A ratchet thimble is the best of a friction thimble and a ratchet stop. It is easy to reach like a friction thimble and provides the tactile and audible feedback of a ratchet stop. The ratchet thimble can incorporate a speeder.

Many types of specialty micrometers are available to measure difficult-to-reach features. While many types of slip-on anvil adapters are available, a specialty micrometer designed for the purpose is the best tool for the job.

Point Micrometers



Pointed spindle and anvil for measuring the web thickness of drills, small grooves and other hard-to-reach dimensions. Available in steel or carbide 15° or 30° points.

Blade Micrometers



Blade micrometers are typically used to measure groove diameters on shafts or other narrow, recessed features. Available in steel or carbide blades of varying thickness.

Spline Micrometers



Spline micrometers have reduced diameter spindle and anvil to allow it to measure spline minor diameters, slots and keyways.

Tubing Micrometers



Spherical Anvil

Cylindrical Anvil

Used to measure the wall thickness on tubing, pipe and other hard-to-reach places. Spherical or cylindrical anvils are available.

Indicating Micrometers



Indicating micrometers are used as a go/no go gage. The spindle is locked after setting and a button retracts the anvil for easy part insertion. Indicating hands on the dial allow the operator to easily check for go/no go.

Quick Travel Micrometer



Quick travel micrometers allow the spindle to retract or advance at more than ten times the rate of a standard micrometer. This allows the micrometer to be used in applications where the spindle must be retracted to clear a feature before being advanced for the measurement.

Disc Micrometers



Disc micrometers are used to measure features along the length of a shaft or gear teeth requiring clearance from the micrometer frame and thimble. Available with rotating or non-rotating discs.

Spherical Face Micrometers



Spherical anvil and spherical anvil/spindle micrometers are used to measure the thickness of curved parts such as rod or crank bearings and pipe wall thickness.

Screw Thread Micrometers



Screw thread micrometers have interchangeable anvils that allow it to measure the pitch diameter of a thread.

Crimp Height Micrometers



Crimp height micrometers are designed to measure the crimp height of electrical connectors after they are crimped on a wire.

Uni-Mike



Measures tube thickness, shoulder distances, rivet head height, etc. with interchangeable anvils (flat anvil, rod anvil, V-anvil). Supplied with flat and rod anvils.

Digit Micrometers



Digit micrometers have both an "odometer" style counter and standard thimble graduations. The micrometer may be graduated English or English and Metric.

Wide Range Micrometers



Wide range micrometers have an oversize frame and multiple anvils to allow a single micrometer to be used over a 6" range. This reduces tool cost for infrequently measured ranges.

MDH Micrometer



High-accuracy sub-micron digimatic micrometer enables .000005"/0.1µm resolution measurement. This micrometer is ideal for highly accurate measurements with a hand-held tool.

Calipers are versatile measuring tools. Most calipers 12"/300mm and under can perform OD, ID and step measurements and normally have a depth rod for measuring deep recesses.

Calipers are available with plastic, stainless steel and carbide jaws to match your measurement requirements. Calipers are available with either vernier, dial or electronic displays.

English dial calipers are normally graduated in .001" and have either .100" or .200" range per rev.

Metric dial calipers are normally graduated in 0.01mm or 0.02mm and have either 1.0mm or 2.0mm range per rev.

Parts of a Caliper

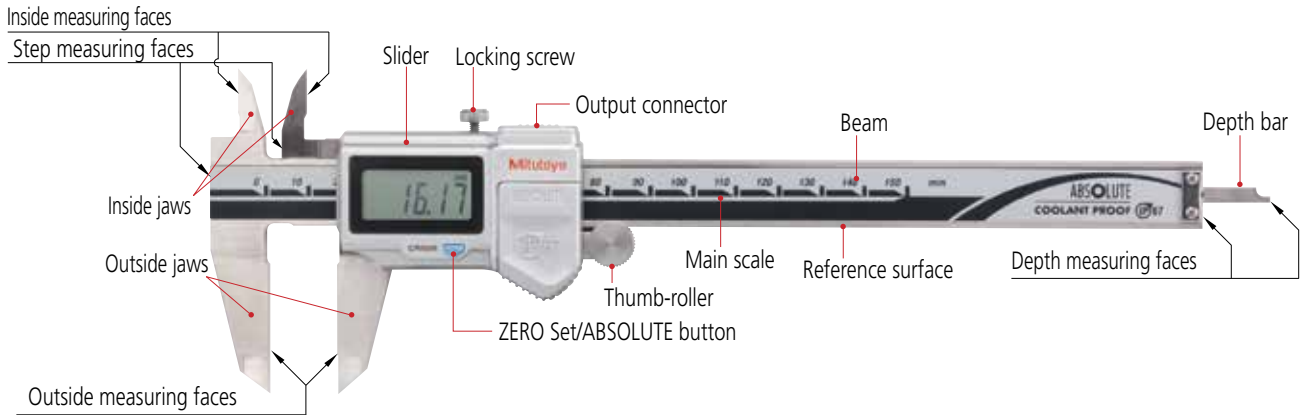

Vernier Calipers

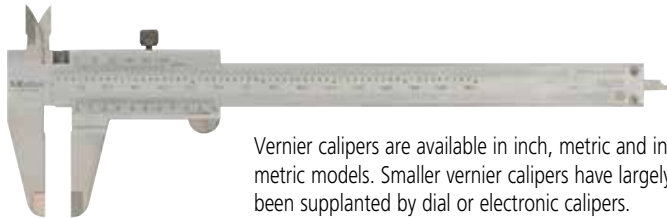

Vernier calipers are available in inch, metric and inch/metric models. Smaller vernier calipers have largely been supplanted by dial or electronic calipers.

Standard Electronic Calipers



Standard electronic calipers are available with or without digital output. They are used throughout industry due to their rugged design and easy-to-read display.

Low-Cost Electronic Calipers

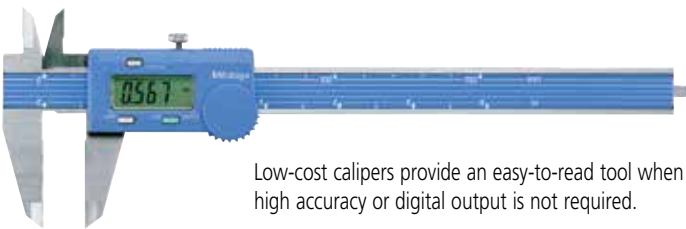

Low-cost calipers provide an easy-to-read tool when high accuracy or digital output is not required.

Dial Calipers



Dial calipers are a versatile measuring tool. They can measure OD, ID, steps, and normally have a depth rod for measuring deep recesses. They are easier to read than vernier calipers and are available in inch or metric models.

Waterproof Electronic Calipers



Waterproof electronic calipers are designed to be used in harsh fluid or dusty environments. They are available with or without digital output. They are currently available in IP65 to IP67 protection levels. IP67 has the greatest waterproof rating and can be subjected to fluid coolant.

Solar Electronic Calipers



Solar electronic calipers eliminate the problem of battery replacement/disposal and the inherent costs. They are available with or without digital output. IP67 rated waterproof models are available.

Carbon-Fiber Calipers

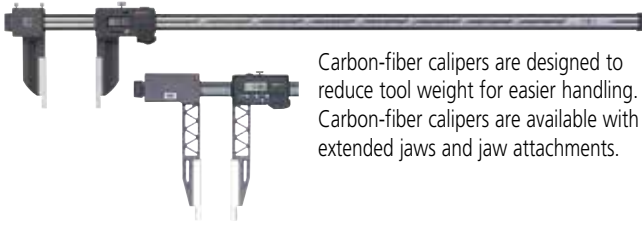

Carbon-fiber calipers are designed to reduce tool weight for easier handling. Carbon-fiber calipers are available with extended jaws and jaw attachments.

Long-Length Calipers



Long-length calipers are available with standard and nib-style ID jaws in lengths up to 80" (vernier).

Low-Force Calipers



Low-force calipers are designed to measure soft or deflectable workpieces. Contact force is 50 to 100 gf.

Tube Thickness Calipers



Tube thickness calipers are used to measure the wall thickness of tubing or pipes with an ID as small as 1/8".

Offset Jaw Calipers



Offset jaw calipers are designed with a sliding main scale jaw to measure stepped parts.

Reduced-Point Calipers



Reduced-point calipers have smaller points to reach features that standard calipers can't.

Offset Centerline Calipers



Offset centerline calipers are designed to measure hole to hole or edge to hole centerline distance. Measurements can be taken in the same or offset planes.

Special OD Jaw Calipers



Special OD jaw calipers are designed for difficult-to-measure areas, such as OD grooves or recessed areas.

Blade-Type Calipers



Blade-type calipers have inserted carbide OD jaws that are relieved to increase measuring clearance. They are designed for use where a standard jaw won't fit.

Special ID Jaw Calipers

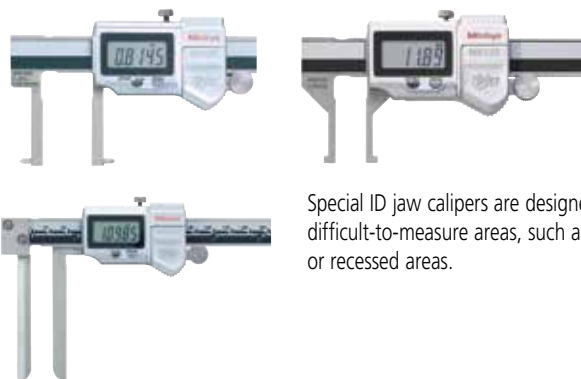

Special ID jaw calipers are designed for difficult-to-measure areas, such as ID grooves or recessed areas.

Snap Calipers



Snap calipers have a snap lever to retract the sliding jaw to allow the calipers to be used for quick go/no go measurements.

Carbide Jaw Calipers



Carbide jaw calipers are available with carbide OD and ID jaws. They are designed to be used where standard stainless steel jaws wear too quickly.

Dial and electronic indicators are used throughout the industry on gage fixtures, indicator stands and on mag bases to measure both static and dynamic features. Dial indicators are available in several dial sizes, graduations and spindle travel. Electronic indicators have a variety of functions such as Max/Min/TIR, have output and some can be remotely accessed.

Dial Indicators



Dial Face Styles

Dial Indicators are available with four general types of dial faces: balanced, continuous, reversed (continuous) and single revolution. The dial face may also have a revolution counter. Balanced and single rev dial faces are normally used on gage fixtures for a run of parts or to check for TIR. A continuous dial face is normally used to measure the dimension of a feature.

Graduations and Range

Dial indicator graduations range from .00002" to .010" and spindle travel from .001" to 12". Long-range indicators (over one inch) are subject to accuracy errors due to cosine error (a mounting problem) and gear train error (over the long distance).

Bearings and Jewels

Dial indicators use either plain bearings, bushings or jeweled bearings. Jeweled bearings are recommended for indicators subject to high usage and indicators graduated in .0001".

Dial Face Size

Dial indicators are available in a variety of dial face sizes ranging from series 0 to series 4, with series two (2 to 2-3/8" diameter face) being the most common size.

Mounting

Dial indicators can be mounted by their mounting stem or by using special mounting backs. The mounting stem is available in either 3/8" Ø for inch indicators or 8mm Ø for full metric indicators. A hybrid metric indicator with a 3/8" stem is available to fit American gage fixtures.

Indicator mounting backs are available in different configurations, with the lug back being the most common.

Dial Indicator Accuracy

American Gage Design (AGD) specifications require that a dial indicator be accurate to within ± one graduation in the first 2-1/3 revolutions of the dial face.

Dial Indicator Points

The standard thread on an AGD style indicator point is #4-48. Metric indicators use M2.5 x 0.45. Indicator points will normally interchange between different brands of indicators.

Electronic Indicators

Selecting an Electronic Indicator

Electronic indicators are available in many different package sizes, resolutions, spindle travel and features. Some electronic indicators can be controlled via remote control or cabled interfaces.

When selecting an electronic indicator, you must define your requirements. Start with resolution and stroke length. Will you need a single or multiple resolution indicator? What features will you need, such as, Max/Min/TIR, preset, go/no go, analog/digital display, battery or AC-powered or solar-power source? Do you need data output, or does the indicator need to control a process via a PLC? Do you need the indicator to perform internal calculations, or will the indicator replace the dial indicator on a dial bore gage?

Package Size

If package size or a remote display are the main considerations in choosing an electronic indicator, most electronic indicators with output can be wired to a remote display. Separate LVDT style, or small profile gages, are available with remote displays. Top reading electronic indicators (similar to a back-plunger dial indicator) are another option if space is limited.

A word of caution when using electronic indicators: high-static environments may cause erratic indicator readings. If you must use an electronic indicator in a high-static environment, insulate the indicator stem and point, and ground the fixture.



A variety of package sizes, features, and resolutions are available for electronic indicators.

Indicator Styles

Dial test indicators are available in several styles that allow the operator to see the dial face while measuring the workpiece. The most common test indicator is the horizontal style. Normally attached to a height gage or transfer stand to take measurements on a surface plate, it is also used in a milling machine to align or center workpieces.

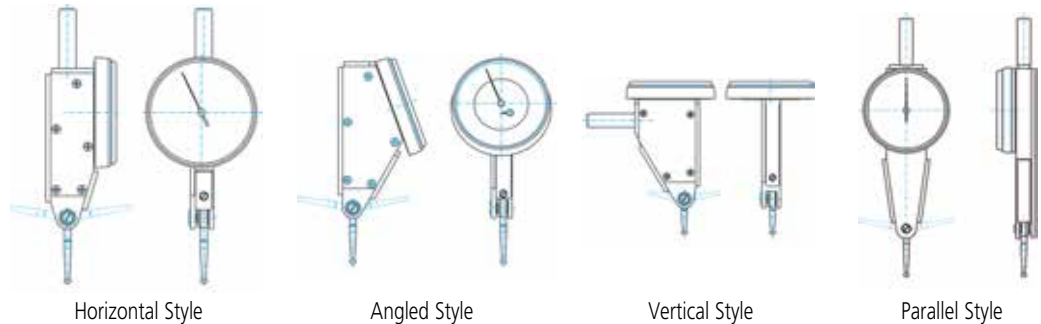

Dial test indicators are available in styles that allow an operator to reach into pockets using the pocket style or long-point style indicator. The swivel point test indicator moves in two planes and allows the operator to swivel the contact point 360°. Uses: Dial test indicators are used to transfer measurements to a height master, check for flatness or TIR, tram in a hole on a machine tool, center a workpiece in a lathe and measure small steps.

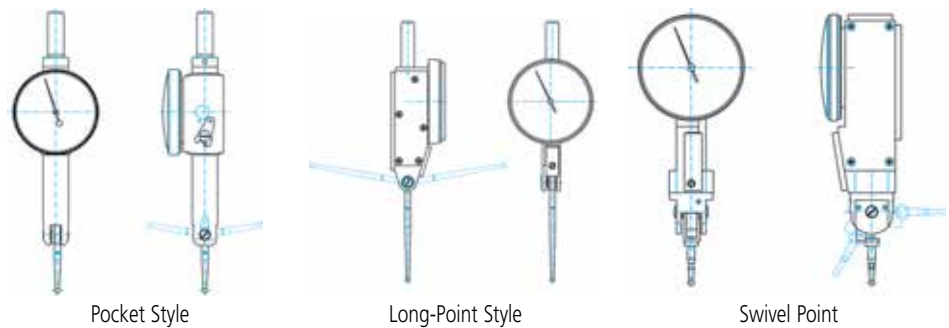

Dial Face

Available as:

Inch
Metric
Combination: Inch/Metric

Resolutions available:

Inch .001", .0005", .0001", .00005"
Metric 0.01mm, 0.002mm, 0.001mm



Balanced dial face

Most dial test indicators have a balanced dial face, meaning that zero is at the 12 o'clock position and the numbers on the right side of the dial face are repeated on the left side of the dial face. Most test indicators are single rev, but those with longer travel have rev counters, and the hand will sweep more than one revolution.

Contact Point Angle

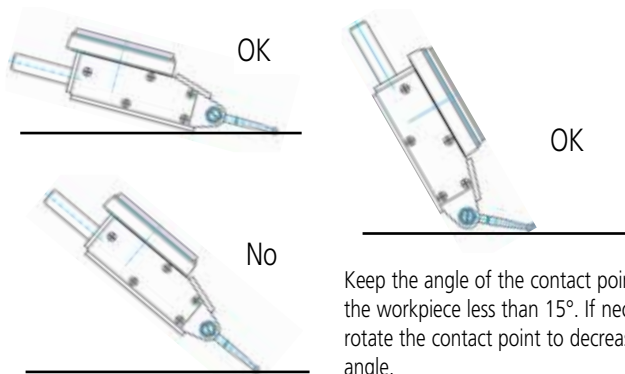

Keep the angle of the contact point to the workpiece less than 15°. If necessary, rotate the contact point to decrease the angle.

Indicator Points

Dial test indicators are available with different contact points.

Ball diameter:

1mm is used when required for very small features.
2mm is a good general purpose size for most applications.
3mm is used when the surface is rough to dampen the reading.

Length:

Standard and long-length contact points are available. Only use a long contact point when required by a measured feature. A long contact point is easy to bump and may damage the dial test indicator. NOTE: Different length points are not interchangeable due to cosine error.

Contact point ball material:

Carbide: Use for extra wear resistance
Ruby: Lighter weight, greater wear resistance



Mounting

Dial test indicators are generally mounted using a stem that attaches to dovetails on the test indicator or on an arm with a dovetail swivel that may also have mounting holes for the stem. A variety of attachments are available to enable the test indicator to be used in a multitude of attitudes. However the test indicator is mounted, it must be a rigid setup to ensure accurate and repeatable measurements.



Handheld bore measurement tools are available in mechanical, electronic and air configurations. Mechanical and electronic tools can be divided into two basic styles: two-point or three-point contact. Mechanical tools can be subdivided into two additional categories: with or without direct reading scales. Air gaging is in a category all its own and could be considered a multipoint contact gage.

Two- or Three-Point Contact Tools

One of the first considerations when measuring a bore is whether to use a two- or three-point contact tool. There are distinct advantages and disadvantages to both styles of bore gages. Two-point tools can detect bore geometries such as ovality, barrel, taper and bell mouth. Three-point contact tools give an averaged reading. Two-point contact tools are generally slower to use than three-point contact tools, although some electronic two-point tools have a MIN hold function that reduces measurement time. Some advantages can also be disadvantages, such as the ability to check for ovality in a two-point tool or the averaging tendency of a three-point tool, depending on the end application of the bore.

Transfer Measurement Style Bore Gages



Bore gages without built-in scales are the lowest cost bore measuring gages. They also require more operator expertise to use and generally are not used where a high-degree of precision is necessary. After the tool is rocked through the bore to find the minimum reading, it is necessary to then measure the anvils on the tool to determine the bore diameter.

Bore Gages with Transverse Mounted Scales

This style tool can be used to measure deeper into a bore than an inline mike head style gage.



Three-Point Bore Measuring Tools

Three-point bore measuring tools are available with mechanical mike heads, electronic displays and with quick-acting snap style release. They are normally quicker to use and require less operator experience than two-point tools.



Two-Point Bore Measuring Tools

Two-point bore measuring tools are available with dial or electronic displays and can even be used with high-accuracy LVDTs and remote displays.

Bore Gages with Inline Mike Heads



Bore gages with inline mike heads have the greatest range of handheld bore measuring tools. Rods or tubes are added to the mike head to measure bores up to 80".



Electronic Tubular Inside Mike

The gage is rocked through the bore while rotating the mike head spindle to locate the minimum bore size. The operator's feel and patience will influence the final measurement. The bore measurement is the combination of the original bore gage setting (in a setting ring) and \pm the mike head reading.

Mastering Bore Gages

Before most bore gages can be used to measure a bore, they must be mastered to a known size. An easy and accurate way to set the bore gage is to use a ring gage. Ring gages are available up to 12" as standard items; larger sizes can be custom-ordered.



Ring Gage



Using height master to set bore gage

Bore gage setting tools or attachments for height masters or gage blocks also can be used to master bore gages. For longer length gages, such as tubular inside mikes, it is sometimes necessary to build special fixtures to master the bore gage.

Height gages are normally used on a granite surface plate to measure and/or scribe part features from a datum plane. Generally a scriber, test indicator, touch probe or CMM style probe is used to locate the measured feature. Height gages are an indispensable part of flat plate layout.

Mechanical Height Gages

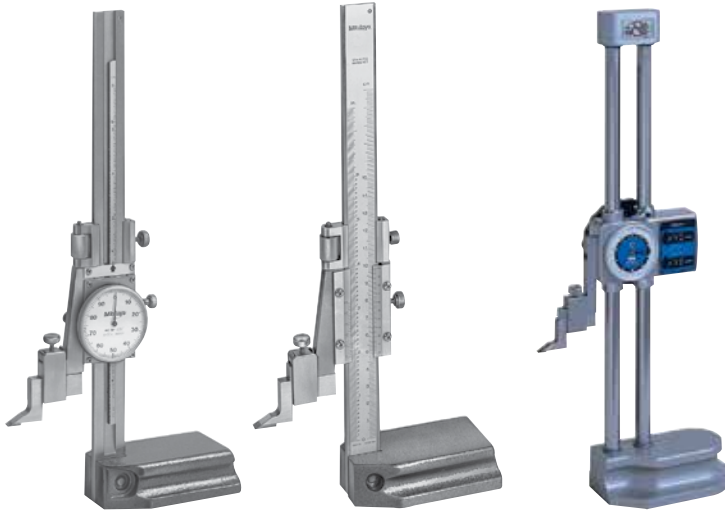

Dial Height Gages

Vernier Height Gages

Digital Counter Height Gages

Mechanical height gages have been used in flat plate layout for many years. There are three basic types of mechanical height gages.

Dial Height Gages are generally available only in sizes below 12"/300mm. It is easier to read than a vernier height gage, and the small size makes it ideal as a personal height gage that can be stored in a machinist toolbox.

Vernier Height Gages are available from 6 inches to 6 feet in height--its chief advantage. It can have one or two (both inch and metric) scales on the beam.

Digital Counter Height Gages with dial and dual-digit counters decrease the time necessary to lay out a part. Not only is the dial easier to read than a vernier scale, but the dual-digit counters allow one counter to be set at the reference datum and the other to be used as a floating zero.

Electronic Height Gages



Group 1

Group 2

Group 3

Electronic height gages can be divided into three distinct groups.

Group 1 has accuracies similar to mechanical height gages. Generally, they will have inch/metric conversion, absolute zero and floating zero, and data output.

Group 2 includes all of the first group features but the accuracy of the tool is a magnitude of order better and may have additional features, such as tolerance setting (with red/green screen indicator), ID/OD measurement, max/min, TIR and probe compensation.

Group 3 will generally have all the features of the second group and a higher accuracy rating. Most height gages in this class will have air bearings, a motorized touch probe, the ability to generate and store part programs, and a computer interface. They also can measure a part feature in two dimensions by rotating the workpiece. Use these height gages when higher accuracies are required or to help reduce the demand on your CMM.

Understanding Height Gage Tolerances

Height gage tolerances can become a little confusing with all the different specs that are used. A height gage can have a tolerance spec for accuracy, quantizing error, repeatability, perpendicularity and straightness.

For this discussion, accuracy will be defined (by fiat) as the ability of the height gage to measure a known distance (such as a gage block) and have the height gage read the same number as the gage block. An accuracy spec could be $.002''$ or $\pm .002''$. This means that if you measure a gage block, the height gage reading will be within $.002''$ of the actual size. Example: Measuring a 1" block, $.998''-1.002''$; measuring a 7" block, $6.998''-7.002''$: The tolerance applies anywhere on the height gage.

Accuracy also can be defined over a given length, ie. $.00008'' + (.00004'' \times L/24)$ where L is in inches. For a 24" measurement, this is $.00008'' + (.00004'' \times 24''/24) = .00008'' + (.00004'' \times 1) = .00008'' + .00004'' = .00012''$ accuracy over 24".

Toolmaker's microscopes and measuring microscopes differ from standard microscopes in one unique way--their ability to measure via a movable microstage, which allows the workpiece to be moved under the optics system. A measuring device (mike heads or DRO system) can measure the micro-stage travel while the operator moves the workpiece below a crosshair in the optics system from one feature to another feature. The Mitutoyo toolmaker's microscope has a built-in protractor for measuring feature angles. **Measuring microscopes** are the big brother of toolmaker's microscopes. They generally have larger stages and provisions for video systems.

Lighting

Toolmaker's and stereo microscopes are optical instruments. Lighting is critical to enable the microscopes to function correctly. Use of contour (back lighting) and surface lighting with ring lights and fiber-optic lights are used to provide a brightly illuminated shadow-free workpiece.

Measuring Reticles

Eyepiece reticles are used to measure features, such as a radius, short distances or threadforms. The standard cross-hair reticle allows an operator to line up a feature and move the micro-stage to the next feature to measure a linear dimension within range of the micro-stage.

Stage travel can be gaged using mechanical mike heads, electronic mike heads or DRO systems. A DRO system with a remote display that can be easily read by the operator is the most convenient to use.

Built-in Protractor

The protractor allows the operator to easily measure angular dimensions on a workpiece.



Toolmaker's Microscope
Stage travel: 4" X 2"



Measuring Microscope
Stage travel: 8" X 6.7"

Stereo microscopes are generally used for visual inspection of small parts rather than dimensional inspection. Measuring reticles may be used if dimensional inspection is required. In addition to fixed and zoom lenses, stereo microscopes may be fitted with a camera or video system.

Magnification

Stereo microscopes can use either fixed magnification lenses, stepped-magnification lenses or zoom lenses. Fixed-magnification lenses require the lenses to be removed and replaced to change the magnification. Stepped-magnification microscopes have a means of changing lens magnification without physically removing the lens from the microscope (such as a turret). A zoom lens allows an operator to continuously vary the magnification throughout the lens magnification range.

Magnification can range from 1X to 120X, depending on the lenses. Total magnification is the product of the eyepiece lens times the objective lens. A 10X eyepiece lens with a 4X objective lens provides a total 40X magnification.



Stereo Microscope with Zoom Lens



Stereo Microscope with Stepped-Magnification Lenses

Video Systems and Cameras

Video systems reduce operator fatigue and allow the microscope workpiece to be viewed by many people at once. Camera systems are a good way to preserve inspection information.

Fundamentals of Rockwell, Rockwell Superficial & Micro Vickers Hardness Testing

Rockwell and Rockwell superficial hardness testers are the most common types of hardness testers used in the United States. In the Rockwell hardness and the Rockwell superficial hardness tests, a conical diamond indenter with a 120° angle and a radius of curvature of 0.2mm, or a carbide ball indenter ranging from 1/16" to 1/2" ball diameter, is pressed into the specimen. A preliminary test force (minor load) is applied, followed by the total test force (major load) for the prescribed dwell time. The hardness number is determined by the difference of the indentation depth of the indenter between the first (minor load) and second (major load) applications of the test force. The Rockwell hardness test uses a preliminary load of 10kgf and total test force of 60kgf, 100kgf and 150kgf. The Rockwell superficial hardness test uses a preliminary test force of 3kgf and total test force of 15kgf, 30kgf and 45 kgf. The 30 Rockwell and Rockwell superficial scales are produced using these six total test forces and five indenter types to cover a variety of both hardness and material thickness. A few examples of these are the HRC, HRBW and HR15TW scales.

Indenters can be diamond or carbide balls depending on the Rockwell scale being used.

Loads can be changed, depending on the style of the tester by physically changing weights on the tester or by dialing in the correct weight for the scale being used.



Calibration Block Set



Analog Rockwell/Rockwell Superficial Hardness Tester



Digital Rockwell/Rockwell Superficial Hardness Tester



Overarm Style Rockwell/Superficial Hardness Tester

Benchtop-style Rockwell/superficial hardness testers (above) are available in both analog and digital styles. Digital styles generally have an electronic output for archival or SPC use. Units are available in both manual and automated configurations. Fully automated testers can apply the pre-load, full load, calculate the hardness value and retract the indenter away from the workpiece.

In the Vickers hardness test, a diamond pyramid indenter with a 136° angle between opposite faces is pressed into the specimen under a test force F (kgf). The hardness number (HV) is obtained by dividing F by the area, A (mm²), of contact between the indenter and specimen. These calculations are usually performed for the operator by a built-in calculator or by using look up tables. All the operator needs to do is measure diagonal length of the indentation when the indenter is removed. The Vickers hardness test is a versatile hardness testing method when multiple load ranges and varying conditions are used.



Digital Micro Vickers Hardness Tester

The Micro-Vickers hardness test, which commonly uses load settings of 1 kgf (9.807N) or less, is well suited for thin or small parts or where a hardness at a specific location across a gradient is required.

Vickers hardness testing at loads of 1 kilogram and up is also known as heavy-load Vickers or macro Vickers. The testing parameters are similar to lighter load Vickers testing. This type of testing may be used to meet the requirements of international specifications or to replace Rockwell testing.



Rebound-Style Portable Hardness Tester

Rebound-style HL (Hardness Leeb) portable hardness testers are widely used for in the field testing of large and heavy workpieces (such as the ways of a lathe bed). Although not as accurate as a benchtop hardness tester, these portable models are used where it is impracticable or impossible to use a benchtop tester. This is also one of the few portable methods where international test methods exist.

What is a Laser Scan Micrometer (LSM)?

An LSM is a non-contact measuring device designed for use on the shop floor as an in-process measuring tool.

An LSM shines when something is moving, such as a drawn wire, glass tube or a moving film. Another application area includes parts with a mirror finish that can't be touched, such as photocopier drums.

An **LSM** can be used as a stand-alone tool or integrated into a complex measuring system. It also can be used to monitor/drive a manufacturing process, such as a wire drawing operation.

The **LSM processor/display** enhances the capability of the LSM. Built-in functions allow the LSM to measure features such as TIR, arithmetical average/moving average, odd number of flute measurements, along with abnormal data elimination and statistical calculation.

Data I/O boards in the processor allow the LSM to communicate to the outside world and allow it to be controlled externally.



Don't forget the QC lab

The LSM is used in QC rooms because of its non-contact measuring ability, repeatability/reproducibility, ease of use, accuracy and high resolution. Good applications are fuel injection metering pins and gage pins.

How Do Laser Scan Micrometers Work?

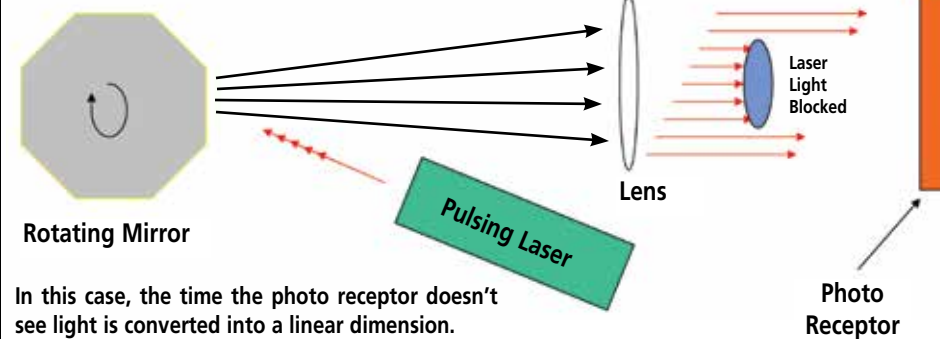

A laser scan micrometer (LSM) uses time to derive a linear dimension. Depending on the type of measurement required, the LSM uses the time it sees light, or doesn't see light, to derive a linear dimension. In the case of a round rod, the LSM is set to derive a dimension based on the time it doesn't see light. In the case of the width of a slot, the LSM uses the time it sees light to derive a dimension.

Typical LSM Applications

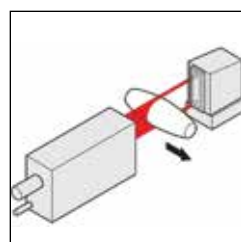
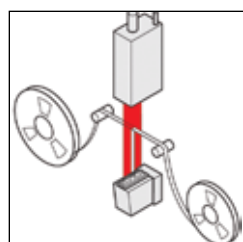
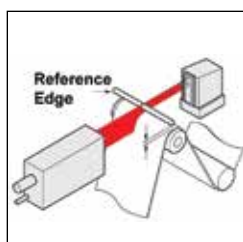
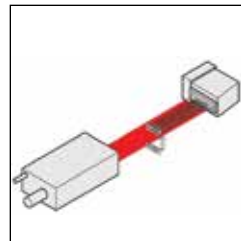
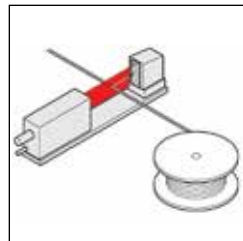
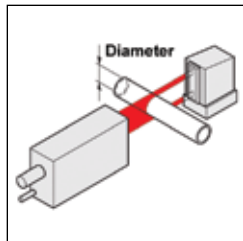

Why use a LSM?

Using a high-speed scanning laser beam, the laser scan micrometer can accurately measure workpieces which are difficult for conventional instruments, such as brittle or elastic parts, hot parts, and delicate parts that are susceptible to damage or distortion due to contact measurement methods. Transparent part measurement also is possible.

Product uses for the LSM

- Wire
- Glass rods
- Micro shaft
- Printer rolls
- Optical fiber
- Cutting tools
- Nuclear fuel rods
- Photocopier drums
- Film sheet thickness
- Sensitized material drum
- Fluid dynamic bearing shaft

Profile projectors, also called optical comparators, come in two basic types with many variations of each type. The first and most widely used in industry is the horizontal model. The second is the vertical model. Each type has advantages and disadvantages. Profile projectors are available from small bench-top models to units large enough to make a good-sized kid's clubhouse.

Stage Travel

Stage travel (which translates into feature size) is measured by either micrometer heads or a digital readout system. If a digital readout system is used, the display can be a simple point-to-point counter, or a microprocessor capable of displaying geometric calculations, such as angles, hole or radius size and feature distances.

Projector Screen

Projector screens are available with or without a screen protractor. Protractor screens have either a mechanical vernier protractor or a digital readout to show angular displacement. Screens normally have a straight or staggered crosshair to help align and measure a part.

Lenses

Profile Projectors use lens systems that will magnify the image from 5X to 100X.

Screen Overlay Charts

Overlay charts are available to compare features, such as thread form or a radius. "Homemade" overlays can also be drawn to compare complex part features.

Horizontal Profile Projectors

The biggest advantage of a horizontal projector is the ability to measure larger/heavier parts than could be measured on a vertical comparator.



**PJ-A3000
Vertical Profile Projector**

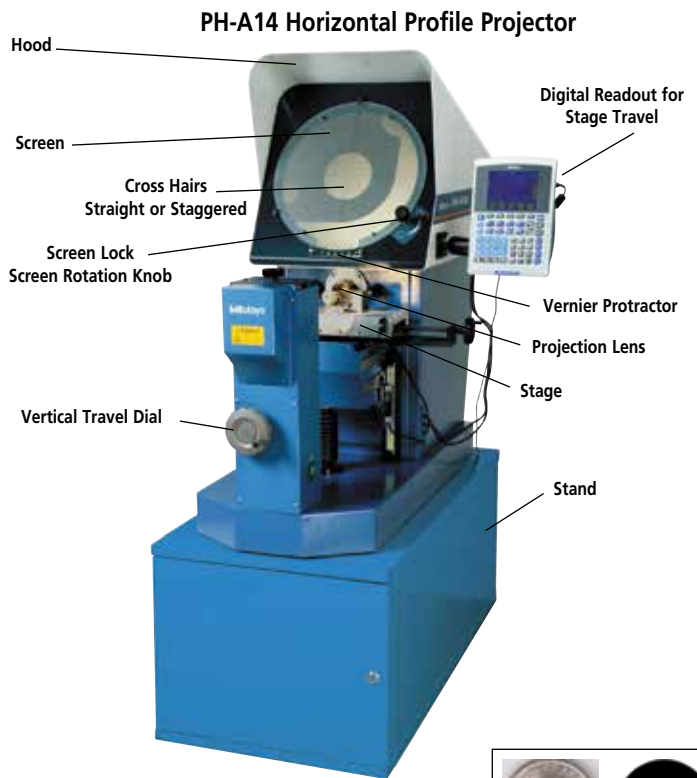

Projector Views

Profile projectors can "look" at a feature profile or by using a half-reflecting mirror (mounted either internal or external to the lens) to "see" the surface of the workpiece.

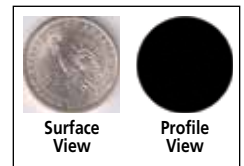

Vertical Profile Projectors

The optics in a vertical profile projector have a vertical axis. Vertical profile projectors are generally used for small parts because the stage has a glass surface and is normally small in size compared to a horizontal profile projector. The main advantage of a vertical profile projector is the ability to place flexible parts, such as gaskets, directly on the stage glass allowing gravity to hold the part in place. Another advantage of the vertical profile projector is the ability to see the entire profile/surface of a small part because holding devices are not required, as would be the case for a horizontal comparator.

Surface finish measurement has advanced considerably since the days of analog display devices measuring RMS (today called Rq) and visual comparison patches. Generally, today's surface finish measurement equipment digitizes the signal from the stylus and digitally manipulates the surface information to provide an easily understood digital display result.

Because the surface information is in a digital format, it is easily manipulated by a microprocessor or computer to provide a vast array of information about a part's surface finish, waviness, or even part contour, depending on the type of machine.

Part prints today normally have a surface finish spec on the drawing. Start here when deciding what surface finish tester to purchase. Stating the obvious, if the print has an Ra finish spec, the surface finish tester must be able to test for Ra values. The next question to answer is whether you need or can use a portable unit, or if you require a benchtop unit due to the surface finish parameter, part staging requirements or feature measurement constraints. The third question is whether you need a paper record, whether the surface parameter needs only a numerical digit or if it requires graphic output.

Portable testers will handle the lion's share of surface finish testing requirements. Due to the complexity of surface finish, we will only look at portable surface testers and some of their components.

Stylus Types



Styli can be broadly categorized into skidded or skidless. Most portable testers use a skidded stylus. The diamond stylus tip normally has a 2µm or 5µm radius and a point angle of 60° or 90°.

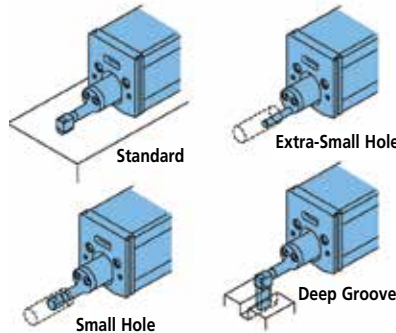

Styli are available in different configurations to fit the application, such as small bores and deep grooves. Styli also are available with a 90-degree bend to allow measurements of the bearing surfaces of a crankshaft.

Staging Accessories

Staging accessories are available for many portable testers that allow the stylus to be carefully or accurately positioned on the workpiece. These include accessories to allow the tester (drive unit) to be mounted on a height gage or mag base or nose guards that allow the tester to measure along the axis of a diameter. The availability of accessories to stage the part or tester may be a determining factor in selecting a portable tester.

Printer Types



Printers provide hard copy results for archival use and spec compliance verification. Printers can be built-in or a stand-alone accessory. An important distinction between printers is whether they will print graphics necessary for some surface finish parameters. Some printers are designed to give SPC information.

Portable Surface Tester Parts

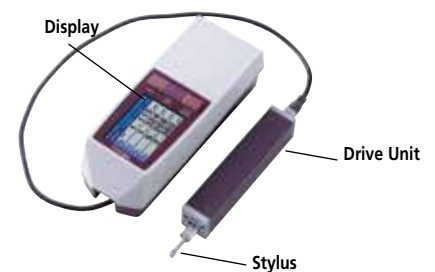

Surface Finish Parameters

Surface finish parameters seem to have grown geometrically since the introduction of digital equipment. Ideally, a parameter gives the manufacturer some insight into how a part will perform during real-world service.

Some parameters are easily understood, such as peak count, which gives an indication of how well paint will adhere to a surface. Other parameters seem to be the invention of someone working on their Ph.D. thesis.

From the point of view of selecting a portable surface finish tester, it is necessary to ensure your selection will provide the results required by the print specs.

Common surface finish parameters include: Ra, Ry, Rz, Rq, R3z and Rt.

Statistical Process Control (SPC) is a quality control system designed to provide product/process quality information during a product/process run. SPC is also used post-process to provide an in-depth analysis of product/process quality capability. The term SPC is generally used as an umbrella concept to cover quality systems that rely on statistical analysis and charting using only a portion of the available data, such as part feature measurements, to predict the overall quality of the products/process. This contrasts with the old method of making a batch of parts, sending them to the quality control room for inspection, and then repairing or throwing out the reject parts. In the early days of SPC, charting and statistical calculations were done by hand using a pencil and paper. Today, a large assortment of electronic tools are available to reduce the cost of gathering data.

Data Types. Data used in SPC can be divided into two broad categories: variable and attribute. Variable data is normally a dimensional or quantitative measurement, such as the thickness of a part or the diameter of a hole. Variable data are easily collected using industry standard measuring tools, such as micrometers, calipers, bore gages and CMMs. Attribute data is a yes/no or go/no-go form of data. An example of yes/no attribute data is a refrigerator inspection looking for dents or scratches (or how many dents or scratches). The refrigerator either has a dent or scratch, or it doesn't. An example of go/no-go attribute data is the use of a go/no-go gage to check the diameter of a hole. The hole is either within tolerance, or it isn't. Using variable data is preferred over attribute data since it gives more information about the product/process. In the case of the hole diameter, knowing the hole size a machine/process is producing gives the operator a marker for tool wear. The operator can then replace or adjust the tool before the hole diameter goes out of specification.

Collecting and Using SPC Data Electronically



Using measuring tools with output is the easiest and most accurate way to collect variable data. Hand tools such as micrometers and calipers, or capital equipment such as CMMs and vision systems, are available with electronic data output or SPC capability.

Wireless data collection provides a convenient solution when measurements must be made that could allow the connecting cables to become entangled in machinery, the workpiece or stretched across a factory floor.

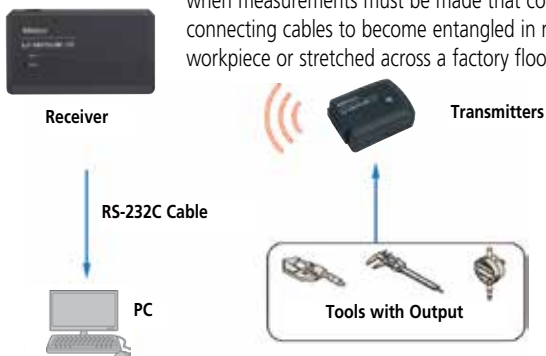

Multiple gage inputs can be accommodated using a multiplexer. The multiplexer allows several gages to be used and read (data transferred) at one time, such as a gage fixture with multiple indicators. A multiplexer also allows a gaging station to be set up with several different tools, such as calipers, micrometers or bore gages, to measure different dimensions on a part.

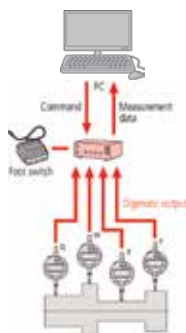

SPC software is available to collect and analyze your data. Programs are available as stand-alone SPC programs or as an integrated solution for quality data management. Integrated SPC software can include modules that provide real-time data analysis for operators, statistical analysis for QC/engineering teams, gage R&R, and gage inventory and control. Integrated solutions software allow system networking to provide the QC/production manager with a systemwide overview.



Portable SPC processors/data collectors/data printers are available and provide low-cost data collection capability.



Portable data collectors (loggers) permit data to be gathered at a remote location and stored for later upload to a system for long-term storage and/or data analysis.

Portable systems may also have the ability to analyze data and provide graphic and text output on a small screen or on a printed tape.

Laptop systems use a standard laptop and software and may use an interface to convert the tool output to a usable input for the laptop. USB or RS-232C inputs are normally used for the laptop. Software can be a SPC program or an off-the-shelf spreadsheet program.



DRO System Components

Digital Readout Systems for machine tools have three basic component parts.

- 1. Scale(s)** to measure the linear distance traveled by a machine element, such as the table on a milling machine.
- 2. Display** to interpret the information from the scale(s), provide a visual display for the operator and additional machine tool specific functions to make the operator's job easier. Displays can either be a simple point-to-point counter or a multi-feature counter capable of calculating hole locations on a bolt hole circle and lathe tool offset data storage. Displays are available in single- or multiple-axis configurations.
- 3. Mounting hardware** to attach the scales and display to the machine tool.

DRO scales use several different methods to determine machine tool travel: glass scales, electromagnetic induction, reflective, magnetic tape, rotary encoder and laser scale systems. Without respect to the type of reading scale used, DRO scales can be divided into two broad categories, incremental and absolute reading. The absolute reading scale is encoded so the display understands the absolute position of the reader head to the scale, even after the system has been turned off and back on. Another important distinction between scales is whether or not the scales are water- or coolant-proof. DRO scales are generally available up to 120", but longer scales of up to 64 feet are manufactured.



DRO displays interpret the information from the scales and provide the operator with a visual display of the machine tool travel. In addition, the travel information may be routed to an external control or PC. The simplest display is a point-to-point counter. This type of counter can be zeroed or preset with a known value. The display then adds or subtracts machine tool displacement to the original zero or preset number. Multi-feature displays not only show machine tool travel, but can guide the operator to the next machine tool position.



Mounting hardware is used to mount the scales to a machine tool. Common machine tools such as bridgeport-style mills normally have bracket kits that are designed for the machines. Other machine tools will normally have general mounting bracket kits that require the mounting brackets to be custom fitted at the time of installation.

Common DRO Display Terms

Zero set: Allows the display to be set at zero.

Preset: Allows the operator to enter a numeric value.

Inch/mm: Allows the display to switch between English and Metric systems.

Counting direction: Allows the operator to choose which machine movement (up/down, in/out, left/right) is considered more positive.

ABS/INC: This stands for **absolute** and **incremental** measuring modes. This gives the operator two reference positions to use. ABS is generally set once as a part datum. INC can be set any number of times.

Diameter display: When used on a lathe, cross slide shows the turned workpiece size (diameter) rather than the radius movement of the cutting tool. The same as some lathe cross slides are graduated to show how much will be removed on the part diameter rather than the radius.

1/2 calculation: Divides the display number by two.

Bolt hole circle: Displays the hole position movement necessary to machine multiple holes on a bolt circle after inputting center location, circle diameter and the number of holes to be machined.

Linear error compensation: Allows the operator to reduce machining errors caused by worn or poorly adjusted machine tables.

Zero approach machining: Allows the operator to make table movements to a zero point rather than a fixed dimension, thereby reducing errors.

What is Calibration?

Before precision measuring tools are placed in service, and periodically thereafter, they need to be calibrated. Calibration is a process to ensure that the measurements obtained by a measuring tool are within allowable specifications/tolerances.

Precision small hand tools (mics, calipers, indicators, etc.) are calibrated by measuring a reference standard, such as a gage block. The measurement of the reference standard is recorded and compared to the actual size of the reference standard. Multiple points throughout the tools range are checked for calibration. If the recorded measurements are within the tools allowable deviation from the actual standard size, the tool is within calibration.

Ideally, the size of the reference standard is known to a precision of ten times or more than the smallest graduation of the tool being checked. For example, when calibrating a dial caliper with .001" graduations, a reference standard with a known size to a precision of at least .0001" should be used. Gage block sizes are generally known to be within a few "millionth" of an inch, and are ideal for most small hand-tool calibration reference standards.

While a precision reference standard is critical to calibration, temperature is also a major consideration when calibrating a precision measuring tool. As temperature increases, the reference standard grows. Gage blocks get longer and holes in ring gages increase in diameter.

Traceability

A cornerstone in the calibration process is traceability. Traceability allows the reference standard used to calibrate a precision measuring tool to be directly traced back to the international definition of length. National measurement institutes, such as NIST in the United States, maintain and transfer the highest level reference standards. Traceability ensures that all measurements use the same international standard.

Accreditation

A lab's accreditation by an independent outside source provides assurances that the practices used by the lab conform to recognized standard practices. Not only are the actual measuring techniques used by the lab, but the important paper trail are required to conform to international requirements for calibration labs. Accredited labs must demonstrate their calibrations are traceable. The American Association for Laboratory Accreditation (A2LA) is a well-recognized accrediting body in the United States.

Certificate of Calibration

A Certificate of Calibration (Cert) provides evidence that a tool has been calibrated and is, or is not, within allowable error specifications.

A Cert should list:

1. Tool manufacturer/name/model number, measuring range, tool graduation/resolution and serial number.
2. Standards used, temperature.
3. Traceability information/specifications used.
4. Calibrating company and person responsible for the calibration.
5. Actual measurements/deviation, permissible error and uncertainty of measurements.
6. Whether the tool passed or failed calibration requirements.

Reference Standards

A reference standard can be a physical object such as a gage block, a ring gage or a caliper checker. A reference standard also can be a measuring instrument designed for calibration purposes like a calibration tester for indicators. All reference standards must be traceable back to the international definition of length, which in the United States is normally done at NIST. The use of accredited labs for calibration purposes ensures traceability.



Calibration Tester for Indicators



Caliper Tester



Gage Blocks

ASME (American Society of Mechanical Engineers) Deviations and Tolerance on Length for Metric and inch Gage Blocks: ASME B89.1.9-2002 (USA)

Nominal Length Range In in inches	Calibration Grade K		Grade 00		Grade 0		Grade AS-1		Grade AS-2	
	Limit Deviations of Length at any Point From Nominal Length $\pm t_e \mu\text{in.}$	Tolerance for the Variation In Length $t_v \mu\text{in.}$	Limit Deviations of Length at any Point From Nominal Length $\pm t_e \mu\text{in.}$	Tolerance for the Variation In Length $t_v \mu\text{in.}$	Limit Deviations of Length at any Point From Nominal Length $\pm t_e \mu\text{in.}$	Tolerance for the Variation In Length $t_v \mu\text{in.}$	Limit Deviations of Length at any Point From Nominal Length $\pm t_e \mu\text{in.}$	Tolerance for the Variation In Length $t_v \mu\text{in.}$	Limit Deviations of Length at any Point From Nominal Length $\pm t_e \mu\text{in.}$	Tolerance for the Variation In Length $t_v \mu\text{in.}$
$l_n \leq .05$	12	2	4	2	6	4	12	6	24	12
$.05 l_n \leq .4$	10	2	3	2	5	4	8	6	18	12
$.45 l_n \leq 1$	12	2	3	2	6	4	12	6	24	12
$1 l_n \leq 2$	16	2	4	2	8	4	16	6	32	12
$2 l_n \leq 3$	20	2	5	3	10	4	20	6	40	14
$3 l_n \leq 4$	24	3	6	3	12	5	24	8	48	14
$4 l_n \leq 5$	32	3	8	3	16	5	32	8	64	16
$5 l_n \leq 6$	32	3	8	3	16	5	32	8	64	16
$6 l_n \leq 7$	40	4	10	4	20	6	40	10	80	16
$7 l_n \leq 8$	40	4	10	4	20	6	40	10	80	16
$8 l_n \leq 10$	48	4	12	4	24	6	48	10	104	18
$10 l_n \leq 12$	56	4	14	4	28	7	56	10	112	20
$12 l_n \leq 16$	72	5	18	5	36	8	72	12	144	20
$16 l_n \leq 20$	88	6	20	6	44	10	88	14	176	24
$20 l_n \leq 24$	104	6	25	6	52	10	104	16	200	28
$24 l_n \leq 28$	120	7	30	7	60	12	120	18	240	28
$28 l_n \leq 32$	136	8	34	8	68	12	136	20	260	32
$32 l_n \leq 36$	152	8	38	8	76	14	152	20	300	36
$36 l_n \leq 40$	160	10	40	10	80	16	168	24	320	40

The Advantages of Ceramic Gage Blocks

- Abrasion resistance**
 Ceramic gage blocks have ten times the abrasion resistance of steel gage blocks.
- Corrosion-resistance**
 Ceramic gage blocks will not corrode unless subjected to the most corrosive chemicals. Anti-corrosion treatment is not required when handled normally (i.e. with fingers), resulting in simple maintenance and storage.
- Dimensional stability**
 Ceramic gage blocks are virtually free from dimensional change over time.
- Thermal expansion**
 The coefficient of thermal expansion of ceramic gage blocks is very close to steel.
- Marking**
 The black characters, indicating the nominal size and serial number, are inscribed by laser and are clearly visible against the white surface of the block.
- Wringing Ability**
 Ceramic gage blocks wring easily to ceramic and steel gage blocks.
- Mushroomed Corners**
 Ceramic gage block corners don't mushroom like steel gage blocks when dropped.

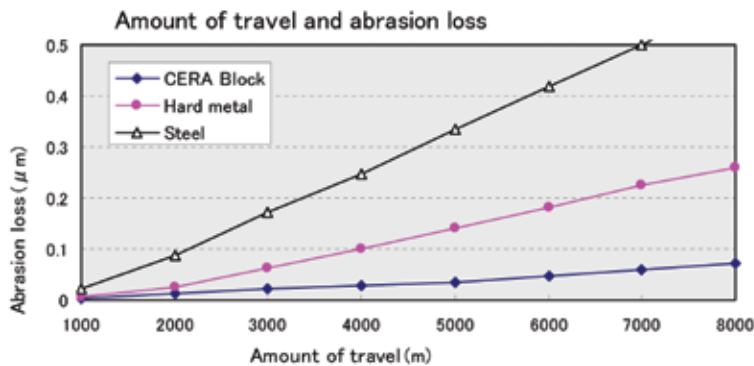

International Protection

IP standards are a good way to compare the dust and water protection levels of different tools. “IP” stands for Ingress Protection (an enclosure spec.) or International Protection. The IP codes are normally two digit codes, such as IP65 or IP43. The first digit in the code tells the size of a foreign object (or dust) that can enter the enclosure. The second digit in the code tells how watertight the enclosure is. As you can see from the testing method below, the water protection spec. is a good gage of how a tool will hold up against coolant spray on a machine tool.

Protection Level	Protection against human touch and foreign matter		Protection against water	
	Type	Description	Type	Description
0	-	No special protection	-	No protection
1	Large foreign matter	Protection against the penetration of solid-state foreign matter exceeding 50mm in diameter	Drip-proof type I	Has no harmful effects from water drops falling in parallel with the plumb line*1
2	Foreign matter of normal shape	Protection against the penetration of solid-state foreign matter exceeding 12mm in diameter	Drip-proof type II	Has no harmful effect from water drops falling at an angle of 15 degrees from the plumb line*1
3	Small foreign matter	Protection against the penetration of solid-state foreign matter exceeding 2.5mm in diameter	Rain-proof type	Has no harmful effect from rain drops falling at an angle of 60 degrees from the plumb line*2
4	Granular foreign matter	Protection against the penetration of solid-state foreign matter exceeding 1mm in diameter	Splash-proof type	Has no harmful effect from water splashes coming from any direction
5	Protection against dust	Protection against harmful dust (penetration of dust not affecting the function is considered OK.)	Jet-proof type	Has no harmful effect from direct water jets coming from any direction*3
6	Dust sealing	Protection against the penetration of dust and perfect protection against human touch	Water-resistant type	No water allowed in from direct water jets coming from any direction*4
7	-	-	Watertight type	No water allowed in under specified conditions if submerged*5
8	-	-	Submarine type	Capable of being used constantly in water with a specified pressure
-	-	-	Moisture-proof type	Capable of being used in moisture with a relative humidity of 90% or more

Outline of Protection Level (IEC 60529)

Compatible with the related IEC standard (IEC 60529), this is a standard regarding the protection level against the penetration of both foreign matter and water. [IEC: International Electrotechnical Commission]

Testing Method

- *1. Using a special device, let raindrops fall at a rate of 3 to 5mm/min for 10 minutes from a height of 8” (200mm).
- *2. Using the spout of a watering can, sprinkle rainwater at a rate of approximately 10L/min from a height of 11.8” (300mm) to 19.7” (500mm) for a period of five minutes or more (for one minute with each outward surface area of 1m²).
- *3. Using a nozzle with an inside diameter of .25” (6.3mm), pour water at a pressure of 0.3kgf/cm² {30kPa} from a distance of approximately 3m at a rate of approximately 12.5L/min for a period of three minutes or more (for one minute with each outward surface area of 1m²).
- *4. Using a nozzle with an inside diameter of .49”(12.5mm), pour water at a pressure of 1kgf/cm² {100kPa} from a distance of approximately 3m at a rate of approximately 100L/min for a period of three minutes or more (for one minute with each outward surface area of 1m²).
- *5. Keep the test piece submerged for 30 minutes with its bottom end placed 1m below the water surface.

Waterproof/Coolant Protection

Scales with an IP67 waterproof rating eliminate machine downtime due to periodic scale cleaning. They also allow the operator to use flood coolant without having to worry about damaging the scales. IP standards are a good way to compare the dust and water protection levels of different scales.

Protection Level	Protection against human touch and foreign matter	Protection against water
IP67	Protection against the penetration of dust and perfect protection against human touch.	No water infiltration under specified conditions if submerged. *

Testing Method

* Keep the test piece submerged for 30 minutes with its bottom end placed 1m below the water surface.

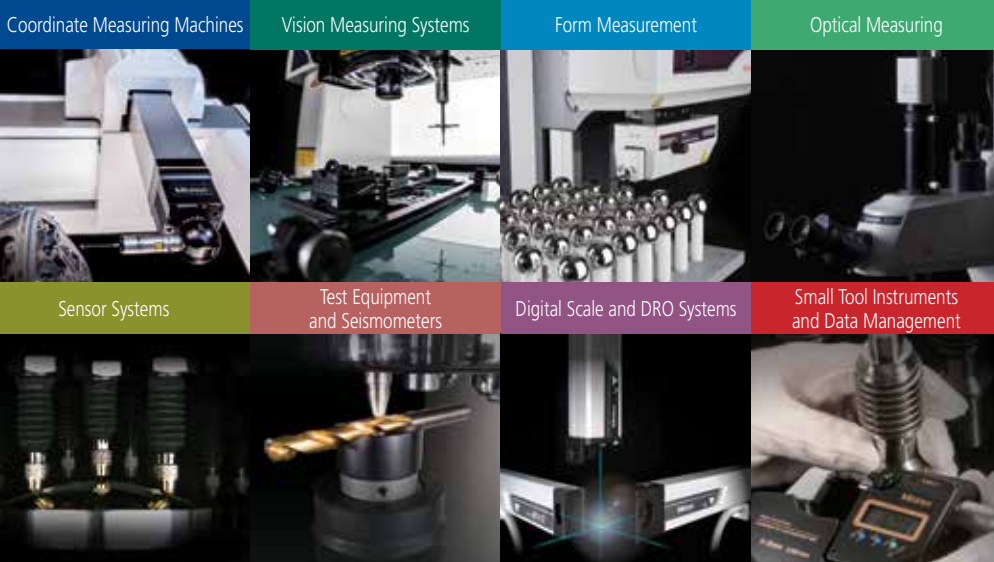

**Whatever your challenges are,
Mitutoyo supports you from start to finish.**

Mitutoyo is not only a manufacturer of top-quality measuring products but one that also offers qualified support for the lifetime of the equipment, backed by comprehensive services that ensure your staff can make the very best use of the investment.

Apart from the basics of calibration and repair, Mitutoyo offers product and metrology training, as well as IT support for the sophisticated software used in modern measuring technology. We can also design, build, test and deliver measuring solutions and even, if deemed cost-effective, take your critical measurement challenges in-house on a sub-contract basis.



**Find additional product literature
and our product catalog**

www.mitutoyo.com

Note: All information regarding our products, and in particular the illustrations, drawings, dimensional and performance data contained in this printed matter as well as other technical data are to be regarded as approximate average values. We therefore reserve the right to make changes to the corresponding designs. The stated standards, similar technical regulations, descriptions and illustrations of the products were valid at the time of printing. In addition, the latest applicable version of our General Trading Conditions will apply. Only quotations submitted by ourselves may be regarded as definitive. Specifications are subject to change without notice.

Mitutoyo products are subject to US Export Administration Regulations (EAR). Re-export or relocation of our products may require prior approval by an appropriate governing authority.

Trademarks and Registrations

Designations used by companies to distinguish their products are often claimed as trademarks. In all instances where Mitutoyo America Corporation is aware of a claim, the product names appear in initial capital or all capital letters. The appropriate companies should be contacted for more complete trademark and registration information.

Mitutoyo

Mitutoyo America Corporation

www.mitutoyo.com

One Number to Serve You Better

1-888-MITUTOYO (1-888-648-8869)

Mi³ Solution Centers:

Aurora, Illinois (Headquarters)

Boston, Massachusetts

Huntersville, North Carolina

Mason, Ohio

Plymouth, Michigan

City of Industry, California

Birmingham, Alabama

Renton, Washington

Houston, Texas