

# PROFILE PROJECTORS

## PJ-H30 Series

Catalog No. E4310- 303



**New series features higher accuracy and wider choice of measuring range**

**Mitutoyo**

# PROFILE PROJECTORS



## User-friendly Projector

Mitutoyo profile projectors have evolved into versatile measuring machines that can inspect a workpiece profile with great accuracy.

Nowadays, profile projectors are used to perform, for example, routine inspection tasks in electronic and electrical parts processing, plastics molding, tool grinding, and medical components manufacture. It can safely be said that a profile projector is a universal tool, always in demand as a basic machine for inspection and measurement.

# PJ-H30 Series



A JIS-B-7184-compatible profile projector is easy to use in production and inspection. In conformance with the JIS standard, the PJ-H30 series profile projectors are user- and environment-friendly, providing a good balance between optical performance, measuring accuracy, operability, and affordability. The projectors in this series incorporate ergonomic design to enable extended periods of use while providing much better measuring accuracy than the JIS standard, quicker measuring time, long bulb life and lower running costs due to higher energy efficiency, etc.



## MORE DETAILS

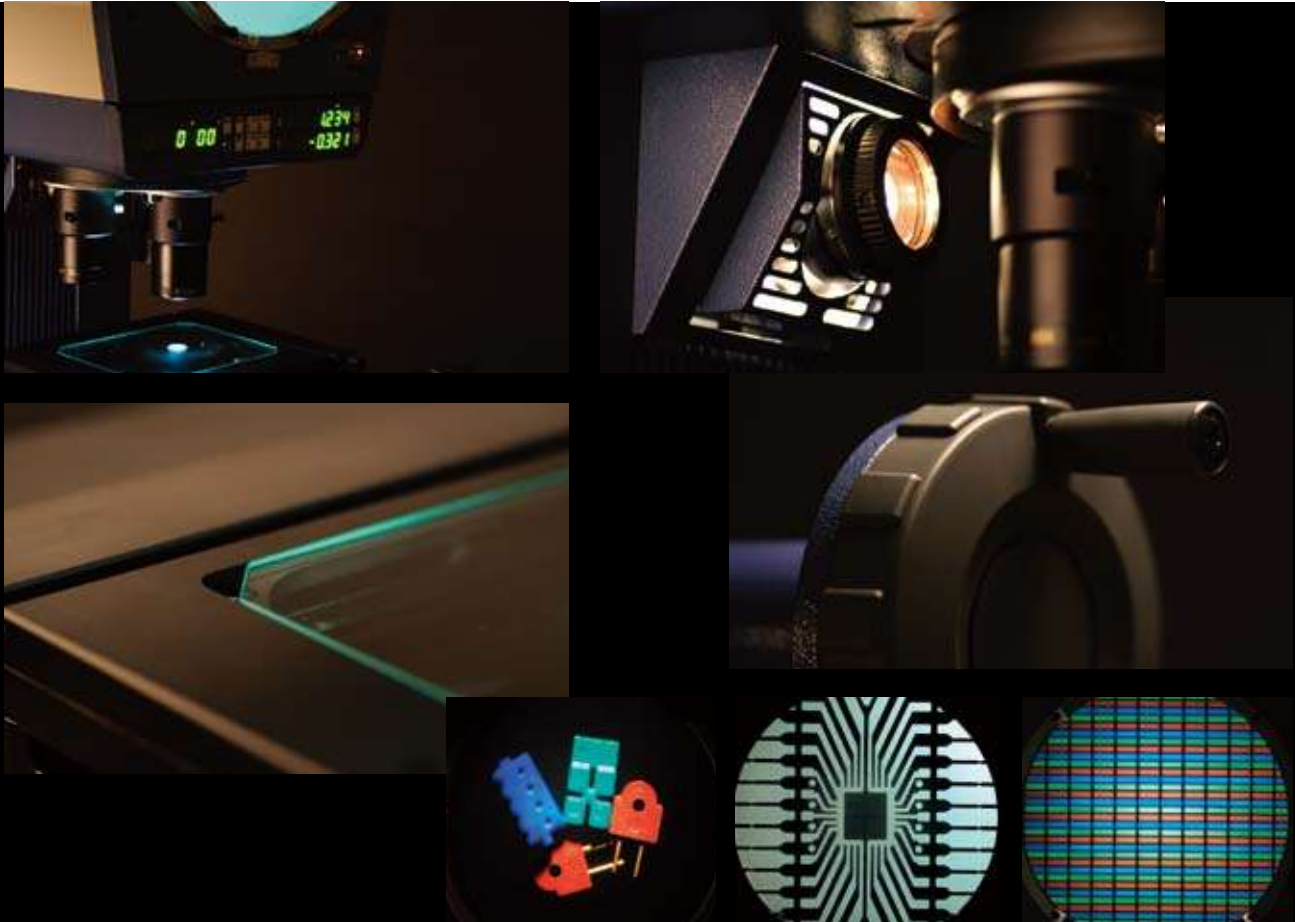

### Stage with a Measurement Area 1.7 Times\* Larger Than the Conventional

\* In the case of model 3017B compared with the conventional 300x100mm stage

Workpieces to be inspected under magnification on a profile projector vary greatly in size due to the needs of different industries. Therefore we decided that our customers should be offered a wide choice of measuring range in this type of instrument.

The PJ-H30 series ensures a maximum measuring stroke of 300x170mm by extending the stroke backward and forward (on the Y axis) as well as left and right (on the X axis). Also, this series is provided as standard (for all stage sizes) with a swivel mechanism convenient for aligning a workpiece with the table movement direction.

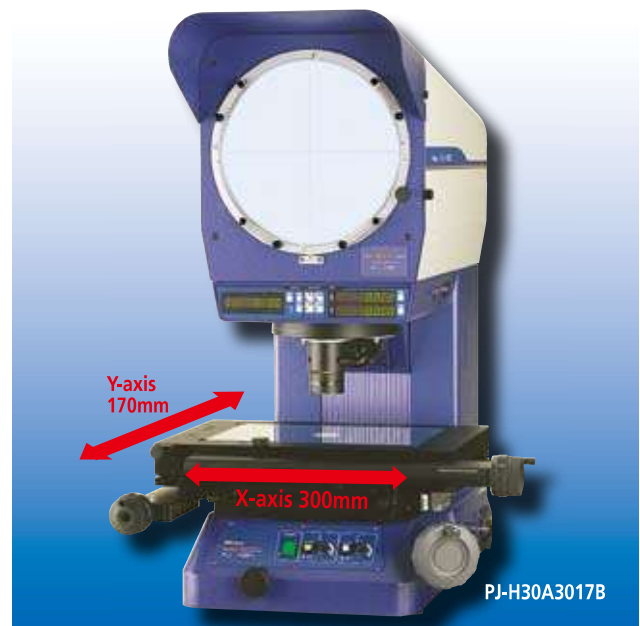

**Mitutoyo**

# PROFILE PROJECTORS

## Dramatic Increase in Brightness with New Contour Illumination System

Projection screen brightness is a decisive factor in how easy it is to use a profile projector. In the new contour illumination system of the PJ-H30 series the brightness is 60% higher, on average, over the entire projection area compared with conventional models. Brightness obtained with the standard, often used, 10X lens has improved by 2 times at least. This allows the user to perform contour inspection and measurement without laboring under insufficient illumination conditions.

## Standard-equipped Turret on All Models



The turret in the PJ-H30 series uses a bearing in the rotary and positioning units to change the projection lens with a gentle and quick sliding action. The turret unit employs a bayonet mount that makes it easy to attach or detach a lens.

## Continuously Variable Brightness Control



The PJ-H30 series uses continuously variable brightness control so that a workpiece can be illuminated at the appropriate level according to its surface texture and color. This illumination system generates illumination from low to high intensity, and can be effective in lengthening the halogen bulb life. Also, the illumination does not start suddenly but increases gradually to the set level.

## Compact Design Makes Operation Easy

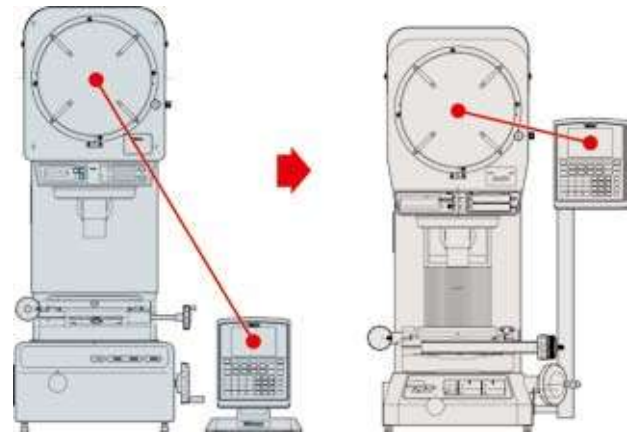

Conventional model PJ-H3010FT1

PJ-H30A1010B

The PJ-H30 series with its slim, compact design significantly decreases the distance between the focusing wheel and projection screen, compared with conventional models. In addition, measurement efficiency is improved because the 2D data processor (QM-Data200) is connected to the main unit with its large LCD screen positioned close to eye level. The compact main body unit is common to every model in the series.

## Quick Release Mechanism Makes Long Distance Moves Easy

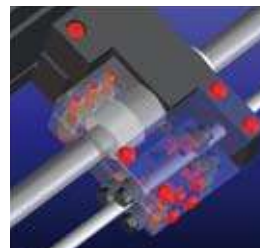

Twist roller method



Quick Release wheel

A quick release mechanism inside each X and Y wheel can switch the stage between Fine Feed and Unlocked. In the unlocked position the stage is completely free moving so it can be shifted very rapidly by hand to the next measuring point. This is very convenient and efficient when long-distance movements are needed, or for a quick return to the reference point. Thanks to the twist roller method used in the mechanism the fine feed is smooth with minimum shock during switch over.

## MORE DETAILS

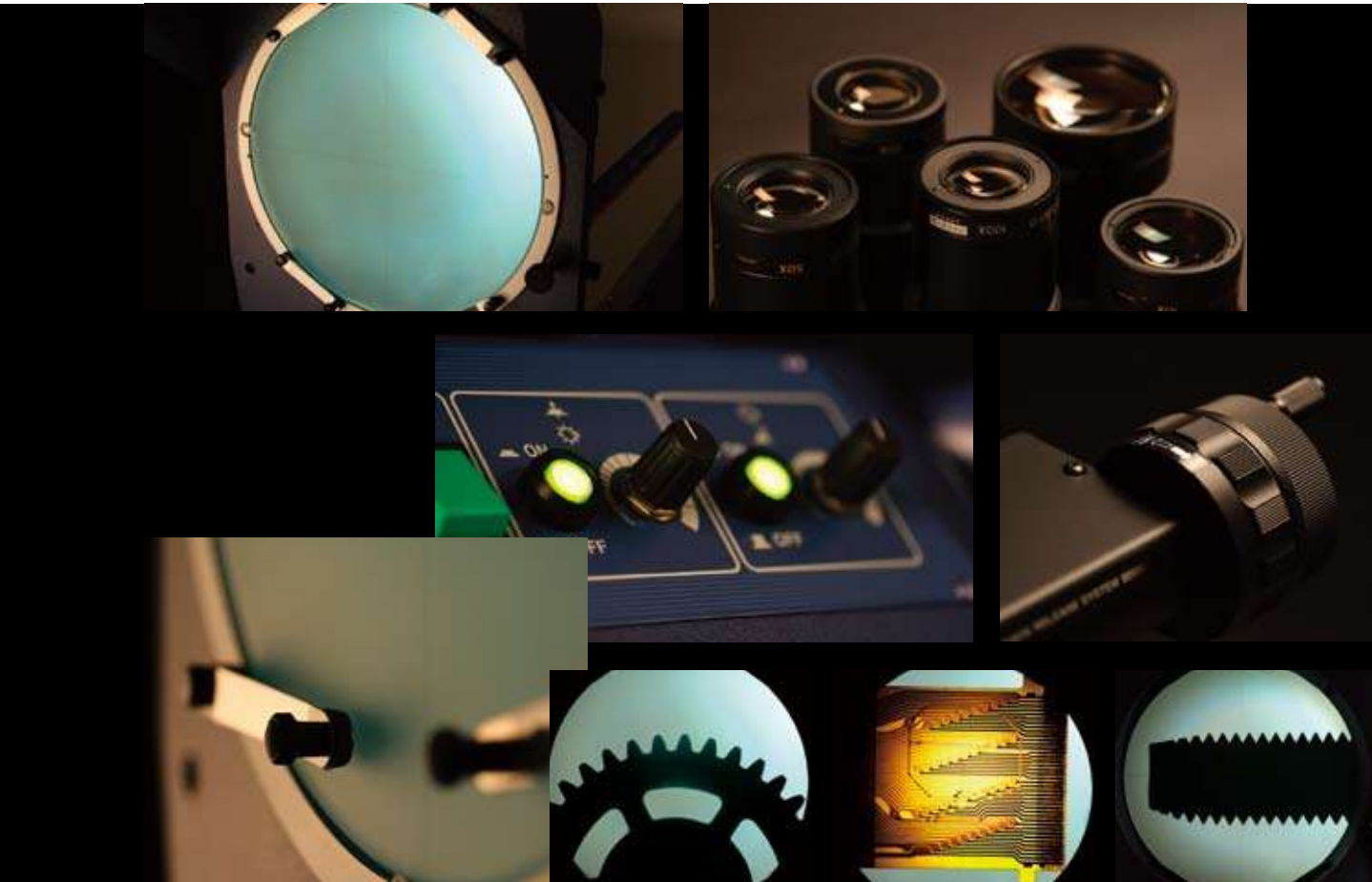

### Quest for Higher Accuracy

**X/Y axis:(3.0+0.02L) $\mu$ m**

Reference: JIS B 7184 20°C  
 Measuring accuracy on each axis: (6+0.04L) $\mu$ m or less  
 L=Measuring length (mm)

A profile projector requires not only appropriate optical performance but also a high level of accuracy. The PJ-H30 series projectors, designed for two-dimensional measurement with high accuracy in addition to contour observation and comparative inspection, have attained the above-mentioned measuring accuracy in all stage sizes.\*

This PJ-H30 series has achieved long-stroke measurement and high-accuracy measurement simultaneously, and thus are suitable for practically every industry.

\* Conforms to each X- and Y-axis measuring method prescribed in JIS B 7184.

### High-visibility Digital Display



All models in this series feature a built-in 2-axis digital counter that uses high-brightness LEDs for high visibility irrespective of the level of ambient illumination. Also, the display uses large, easy-to-read characters (approx. 3.6 times larger than the conventional model in area terms). The counter employs the highly versatile RS-232C interface for data output as well as Zero-set/Direction switching, thereby supporting data output to a general-purpose printer and a personal computer. Also, via the Mitutoyo PC Transfer program (option), the counter display values can be output to spreadsheet software.

Resolution: 0.001mm

**Mitutoyo**

# PROFILE PROJECTORS

## Built-in Auto Edge Detection Function \*Only for PJ-H30B/30D



The model PJ-H30B/30D incorporates the Opto-eye sensor that outputs a signal upon automatic sensing of a low or high intensity at an edge (under the contour illumination). The sensor allows auto edge-detection measurement while performing chart comparison inspection on the projection screen. Additionally, because calibration can be set up according to each low or high intensity level on the projection screen, a high accuracy of edge detection has been achieved.

\* The performance of this function is equivalent to that of Opto-eye 200.

## High-operability Focusing



Manual focusing wheel of PJ-H30E/A/B



Front panel of PJ-H30C/D (motor-driven focusing)

An easy-to-grip wheel shape and a convenient location are key factors for quick focusing on a workpiece placed on the stage. The manual focusing wheel in the PJ-H30 series is mounted at an angle so it can be operated from a natural pose without feeling uncomfortable even in a standing or sitting position. The motor-driven focusing spec model with a high-operability jog shuttle that moves smoothly is also available, allowing observation and measurement with minimum feeling of fatigue.

\* PJ-H30C/D (motor-driven focusing spec) is not provided with the manual focusing wheel.

## Maximizing Bulb Life

Conventional model PJ-H3000 (20A/div)

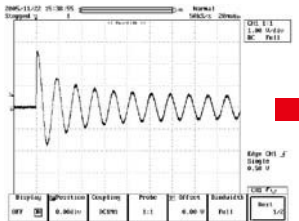

PJ-H30 (10A/div)

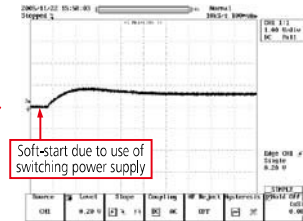

Soft-start due to use of switching power supply

Halogen bulb life is greatly dependent on the characteristics of its power supply. Specifically, inrush current at switch-on with conventional AC supplies is a big factor in shortening the rated life of a halogen bulb. To overcome this effect, the PJ-H30 series uses a regulated switching power supply that delivers DC with a soft-start characteristic to help ensure the rated bulb life and light intensity is achieved. It also allows operation in any country without the need for adjustment to local mains power.

## Highly Dust Resistant for Use in Any Location

Profile projectors are used in widely varying locations, from machine shop to inspection room, with all the associated variations in atmospheric cleanliness. The PJ-H30 series has been designed for continuous use under these conditions by increasing the dust resistance of the contour illumination unit beneath the stage glass.

Additionally, the protection glass is mounted on this illumination unit to avoid damage to the condenser lens and make cleaning much easier.

Note: The illumination unit is not fully resistant to dust and water.

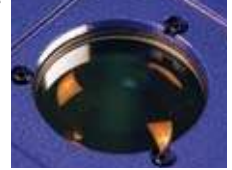

## Dual-mode Surface Illumination Unit



Vertical illumination



Oblique illumination

Surface illumination is provided by a swiveling lighting unit that can direct light onto the side window in a projection lens for reflection vertically downwards through the lens itself, or that can illuminate the surface directly. This illumination system is useful to increase the color reproducibility of a workpiece and perform three-dimensional observation.

## Bulb Housings Designed for Ease of Replacement



The bulb housings of the PJ-H30 series are designed to allow quick and safe bulb replacement, particularly for the contour illumination bulb which is mounted on a sliding tray to provide easy, external access. This ensures that contour inspection can be continued as soon as the bulb has cooled to a safe temperature after failure. Bulb replacement is very simple because the housing can be released just by loosening one screw. Current to the bulb is shut off while the housing is pulled out.

# Profile Projectors PJ-H30 Series



Motor-driven focusing specification

## Features

- Dramatic increase in the light intensity of a projected image thanks to the new contour illumination optical system (2 times higher than the conventional model in the average intensity of all lenses)\*
- High-accuracy measurement above JIS standard
- Choice of measuring range in line with market demands
- Quick release mechanism on each axis that enables smooth switching between fast positioning and Fine feed
- Regulated power supply with a soft-start characteristic for maximizing halogen bulb life
- Bulb slide switching mechanism that allows quick and safe changing of a blown bulb
- High-visibility digital counter with a large character display (approx. 3.6 times larger than the conventional type in area terms)
- A model with a high-accuracy edge detector (Opto-eye) is available for effective, manual measurement.
- Fixed-screen spec models with a performance/cost ratio are available in separate series.

\* According to Mitutoyo's investigation



Fixed screen

**Mitutoyo**



# PROFILE PROJECTORS

## Dimensions

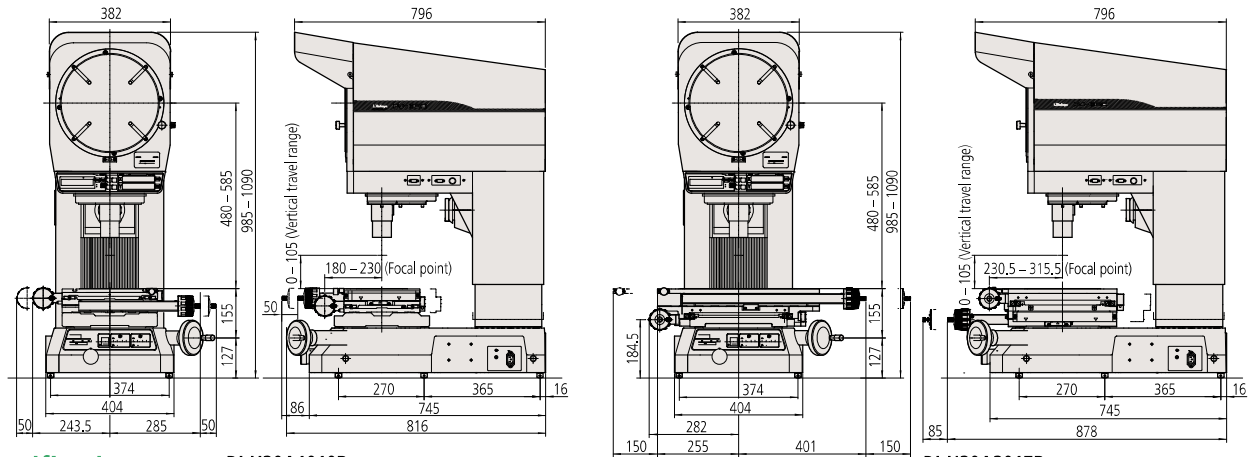

## Specifications

PJ-H30A1010B

PJ-H30A3017B

Fixed screen series	Model	PJ-H30E505B	PJ-H30E1010B	PJ-H30E2010B	PJ-H30E2017B	PJ-H30E3017B
	Order No.	303-701	303-702	303-703	303-704	303-705
Protractor screen series	Model	PJ-H30A505B	PJ-H30A1010B	PJ-H30A2010B	PJ-H30A2017B	PJ-H30A3017B
	Order No.	303-711	303-712	303-713	303-714	303-715
Protractor screen/OPTOEYE built-in series	Model	PJ-H30B505B	PJ-H30B1010B	PJ-H30B2010B	PJ-H30B2017B	PJ-H30B3017B
	Order No.	303-721	303-722	303-723	303-724	303-725
Protractor screen/motor-driven focusing series	Model	PJ-H30C505B	PJ-H30C1010B	PJ-H30C2010B	PJ-H30C2017B	PJ-H30C3017B
	Order No.	303-741	303-742	303-743	303-744	303-745
Protractor screen/OPTOEYE built-in/motor-driven focusing series	Model	PJ-H30D505B	PJ-H30D1010B	PJ-H30D2010B	PJ-H30D2017B	PJ-H30D3017B
	Order No.	303-731	303-732	303-733	303-734	303-735
Protractor screen Note: The screen on model PJ-H30E will not rotate.		Effective diameter: $\phi 306\text{mm}$ , $90^\circ$ solid cross line width: $0.1\text{mm}$ Rotating angle: $\pm 360^\circ$ (counter display: $\pm 370^\circ$ ), angle display: selectable between digital, zero-set, and ABS/INC, reading: $1^\circ$ or $0.01^\circ$ (selectable)				
Image type		Erect-unreversed (the image orientation and moving direction are identical.)				
Projection lens (option)		5X, 10X (standard accessory), 20X, 50X, 100X: parfocal design, half mirror built-in movable type for vertical surface illumination				
Mount		3-turret bayonet mount				
Magnification accuracy		Contour: $\pm 0.1\%$ or better, surface: $\pm 0.15\%$ or better				
Focusing unit	Maximum height of workpiece	$105\text{mm}^*1$				
	Drive/feed mechanism (Model PJ-H30E/A/B)	Projection screen head vertical drive (Fixed stage unit), manual wheel (1mm/full turn)				
	Drive/feed mechanism (Model PJ-H30C/D)	Projection screen head vertical drive (fixed stage unit), motor-driven (jog shuttle coarse/fine feed: approx. $4\mu\text{m}/\text{step}$ for fine feed, variable speed: max $5\text{mm}/\text{s}$ )				
Illumination	Contour illumination	Light source: 24V/150W/50h halogen bulb, zoom-type telecentric illumination, built-in heat absorbing filter, built-in cooling fan, non-stepped light control, smooth light-up (inrush current reduction), bulb slide switching mechanism				
	Surface illumination	Light source: 24V/150W/50h halogen bulb, vertical/oblique surface illumination angle variable mechanism (light condensing adjustable), built-in heat absorbing filter, built-in cooling fan, non-stepped light control, smooth light-up (inrush current reduction)				
	Filter (option)	Green filter (for contour illumination)				
Stage	Measuring range	50x50mm	100x100mm	200x100mm	200x170mm	300x170mm
	Top surface dimensions	300x240mm	300x240mm	350x280mm	410x342mm	510x342mm
	Effective dimensions of stage glass	180x150mm	180x150mm	250x150mm	270x240mm	370x240mm
	Swiveling angle		$\pm 3^\circ$ (right)			$\pm 5^\circ$ (left)
	Maximum loading (on top of the stage glass) Note: Mechanical assurance		10kg			20kg
	Quick release mechanism	Operates on X and Y axes				
Length measuring system		High-accuracy digital scale*2				
Digital counter	Resolution	0.001mm mm/inch selectable				
	Axes displayed	X and Y				
	Functions	Zero-setting, direction switching, Opto-eye input, external load output, RS-232C output				
Measuring accuracy*3	Note: At no load on XY axis	$(3+0.02L)\mu\text{m}$ L: measuring length (mm)				
Edge detection	Model PJ-H30E/A/C	Enabled by installing Opto-eye 200. Edge detection allows setting/holding of the counter value on each axis.				
	Model PJ-H30B/D	Detection sensor: Incorporated in the screen center, non-directional Illumination: contour*4 Minimum detection circle: $\phi 2\text{mm}$ (projected image size), minimum line width: 1mm (projected image size), repeatability: $\pm 1\mu\text{m}^*5$				
Maximum power consumption		Approx. 420W				
External dimensions of the main unit (W) and (D) indicate the dimensions when the stage is displaced at the maximum stroke. (H) indicates a height between the bottom-end and top-end positions of the projection screen head. (WxDxH)		600x816x985-1090mm	629x831x985-1090mm	835x836x985-1090mm	756x963x985-1090mm	956x963x985-1090mm
Main unit mass		176kg		178kg	205kg	212kg
Power supply		Switching type, AC power input: 100 to 240 V (no need for voltage selection), GND terminal				

\*1: When a rotary table is not mounted.

\*2: Registered patent (in Japan)

\*3: The measurement method conforms to JIS B 7184.

\*4: An edge may not be detected if the illumination is inadequate.

\*5: Accuracy achieved using Mitutoyo's test methods.

Replacement bulb (common to contour/surface illumination): 24V/150W halogen bulb No.515530  
A long-life spec bulb (No.512305) with a little lower light intensity is also available.

# Options Diagram

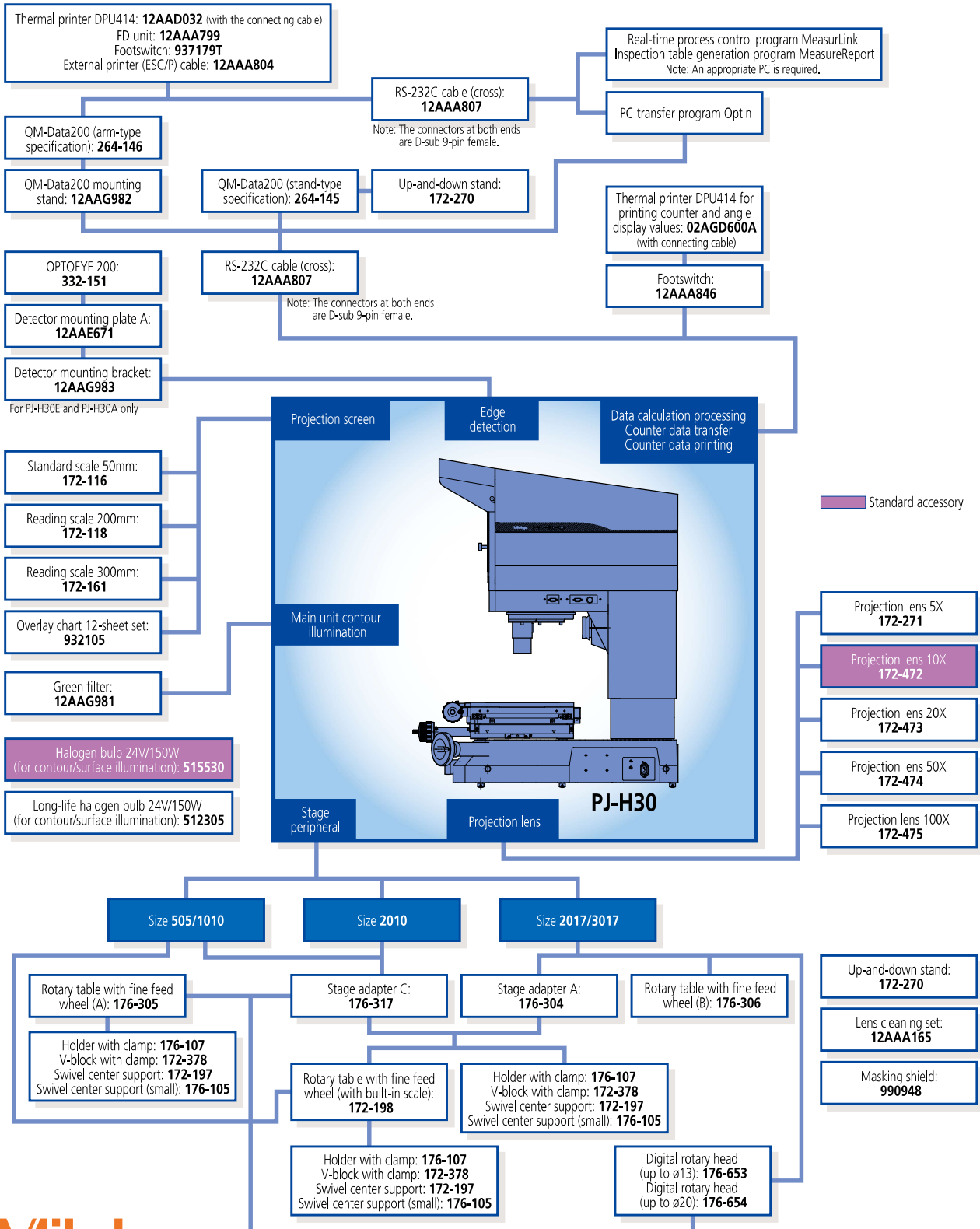

# Optional Accessories

## Projection lenses



## Specifications

Magnification	Order No.	N.A.	Working distance (mm)	Parfocal distance (mm)	Maximum height of focal point (mm)	Maximum diameter (mm) of a cylinder whose profile can be projected on the center line of the screen
5X	<b>172-271</b>	0.06	66	164.5	105	148
10X (standard accessory)	<b>172-472</b>	0.16	70.5			197
20X	<b>172-473</b>	0.20	56.5			137
50X	<b>172-474</b>	0.25	50			114
100X	<b>172-475</b>	0.25	50			114

## 2-D Data Processing unit QM-Data200

### Features

- With the help of a large LCD screen, various graphic display functions support measurement work.
- Single-key operation on the key pad allows combined measurements (distance between 2 circles, etc.) to be made rapidly.
- AI measuring function (automatic recognition function for measurement elements)
- Measurement procedure teaching function and measuring point navigation function in repeat mode
- User menu function that allows registration/storage of user specific measurement commands and part programs
- Measurement procedures and results can be saved on a USB-floppy disk with the FDD unit or USB-Memory Stick (option)
- Tolerance zone judgements of measurement/calculation results and statistical processing of each item are possible
- Output of measurement result to PC spreadsheet software MS-Excel\*
- Simple mounting on the PJ-H30 main unit using the specific stand (see Note)
- Measurement can be continued even during result printout

\* MS-Excel is a registered trademark of Microsoft Corporation.



Stand-type spec unit

### Specifications

Order No.	264-145 (stand-type spec)	264-146 (arm-type spec)
Display language	Supports ten national languages (Japanese/English/German/French/Italian/Spanish / Portuguese / Czech / Chinese / Korean: selectable)	
Unit of measurement values	Length: mm, angle: degree/degree-minute-second (selectable)	
Program function	Creation/execution/editing of measurement procedure	
Statistical processing	Measurement item, number of pieces of data, maximum value, minimum value, mean value, standard deviation, range, histogram	
Element call	Point, line, circle, distance, ellipse, square hole, slotted hole, intersection point and intersecting angle	
Display unit	5.7 type Monochrome graphic LCD (320x240 dots, with backlighting)	
Measurement result file output	RS-232C output (CSV format, MUX-10 format)	
Power supply/maximum power consumption	100VAC 50/60Hz (AC adapter used), 24W (excluding options)	
External Dimensions (approx.)	260(W)x242(D)x310(H)mm (including the stand)	318(W)x153(D)x275(H)mm (When arm is horizontal)
Mass (approx.)	2.2kg	2.1kg

Note: Select the arm-type spec QM-Data200 if mounted on the PJ-H30 main unit.

# Optional Accessories

## Rotary table with fine feed wheel A



<b>Order No.</b>	<b>176-305</b>
External dimensions	280(W)x280(D)x24(H)mm Table: ø240mm, 360° rotatable, without angle reading
Mass	5.5kg
Effective glass diameter	ø183mm
Applicable models	Size 505/1010/2010 (PJ-H30 series) Stage adapter C is required.

Note: This table allows the V-block with clamp, swivel center support, or holder with clamp to be fixed on it.

## Rotary table with fine feed wheel B



<b>Order No.</b>	<b>176-306</b>
External dimensions	342(W)x342(D)x23(H)mm Table: ø270mm, 360° rotatable, without angle reading
Mass	6.5kg
Effective glass diameter	ø235mm
Applicable models	Size 2017/3017 (PJ-H30 series)

Note: This table does not accept the V-block with clamp, swivel center support, or holder with clamp.

## V-block with clamp



<b>Order No.</b>	<b>172-378</b>
Maximum workpiece diameter to be clamped	ø25mm
Central height from a mounting surface	38 to 48mm
External dimensions	90(W)x45(D)x117(H)mm
Mass	0.8kg
Applicable models	PJ-H30 series Note: Stage adapter C is used for size 2010 and stage adapter A is used for sizes 2017 and 3017

## Swivel center support



<b>Order No.</b>	<b>172-197</b>
Maximum workpiece size to be supported *	ø80mm (ø65x140mm)
Inclination	±10°
Mass	2.5kg
Applicable models	PJ-H30 series Note: Stage adapter C is used for size 2010 and stage adapter A is used for sizes 2017 and 3017

\* The maximum possible size to be measured differs depending on the projection magnification selected. The size enclosed in parentheses ( ) indicates that for an inclination of 10°.

## Stage adapter A/C

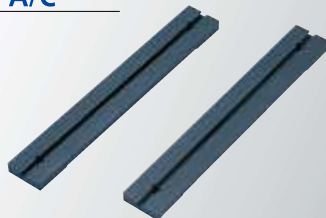

<b>Order No.</b>	<b>A: 176-304 / C: 176-317</b>
External dimensions (for one piece)	A: 50(W)x340(D)x15(H)mm C: 73(W)x278(D)x17(H)mm
Mass	A: 1.5kg / C: 1.2kg
Applicable models	PJ-H30 series

Note: A and C consist of 2 pieces of adapters, respectively, as a set.

## Digital rotary head



A unit that provides digital display of the angle of rotation of its spindle axis and is used for determining angles of circular features.

<b>Order No.</b>	<b>176-654</b>
Angular resolution	0.1° or 1° (selectable) The accuracy is not specified.
Rotary drive	Manual by hand wheel (head rotation 0.5 turn for one turn of the wheel)
Diameter range the collet chuck can hold	ø2.5 - ø20mm Note: The collet chuck is an optional accessory.
Power supply	100 - 120VAC, 220 - 240VAC, 50/60Hz
External dimensions	160(W)x220(D)x88(H)mm
Applicable models	PJ-H30 series Note: Stage adapter C is used for sizes 505, 1010, and 2010 and stage adapter A is used for sizes 2017 and 3017

## Rotary table with fine feed wheel (with built-in scale)

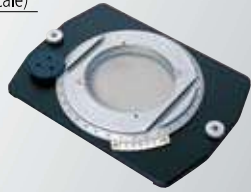

<b>Order No.</b>	<b>172-198</b>
External dimensions	240(W)x172(D)x19.7(H)mm T-groove pitch on the table top face: 120mm Tale top: ø146mm, 360° rotatable, with an minimum angle reading of 2'
Mass	2.5kg
Effective glass diameter	ø84mm
Applicable models	PJ-H30 series Note: Stage adapter C is used for size 2010 and stage adapter A is used for sizes 2017 and 3017, simultaneously.

Note: This table allows the V-block with clamp, swivel center support, or holder with clamp to be fixed on it.

## Holder with clamp



<b>Order No.</b>	<b>176-107</b>
Maximum width to be clamped	35mm
External dimensions	280(W)x280(D)x24(H)mm
Mass	0.4kg
Applicable models	PJ-H30 series Note: Stage adapter C is used for size 2010 and stage adapter A is used for sizes 2017 and 3017, simultaneously.

## Collet chuck



<b>Set A (No.12AAG241)</b>	Diameter range that can be damped: ø2.5 to ø5.0mm
<b>Set B (No.12AAG242)</b>	Diameter range that can be damped: ø5.5 to ø10.0mm
<b>Set C (No.12AAG243)</b>	Diameter range that can be damped: ø10.5 to ø15.0mm
<b>Set D (No.12AAG244)</b>	Diameter range that can be damped: ø15.5 to ø20.0mm
Applicable models	Digital rotary head

## Green filter

A green filter for adjusting the contrast and used by inserting in the contour illumination unit.



<b>Order No.</b>	<b>12AAG981</b>
------------------	-----------------

## Lens cleaning set

Cleaning set dedicated to maintenance of eyepieces and objectives, comprised of the cleaner, cloth, blower, cotton swab, etc.



<b>Order No.</b>	<b>12AAA165</b>
Applicable models	PJ-H30 series

## Thermal printer DPU-414



<b>Order No.</b>	Connected to QM-Data200.	<b>12AAD032</b>
	Counter/angle display value printout	<b>02AGD600A</b> Note: Footswitch <b>No.12AAA846</b> is used simultaneously.
Print method	Dot-matrix thermosensitive method	
Number of print digits	40 digits (normal character 9x7 dot-matrix)	
Printing speed	Maximum 52.5 characters/sec (normal character)	
External dimensions	160(W)x170(D)x65.5(H)mm (printer main unit)	
Standard accessory	Printer cable, printer paper (1 roll), AC adapter (for 100VAC)	
Spare parts	Printer paper	<b>No.908353</b> (5 rolls)
	ESC/P printer cable	<b>No.12AAA804</b> (2mm), 24 pins, color/monochrome compatible

# Optional Accessories

## Standard scale



Order No.	172-116
Scale length	50mm
Scale graduations	0.1mm
Scale accuracy (at 20°)	(3+0.005L) $\mu$ m L: measuring length (mm)
Glass scale for magnification check	

## Reading scale

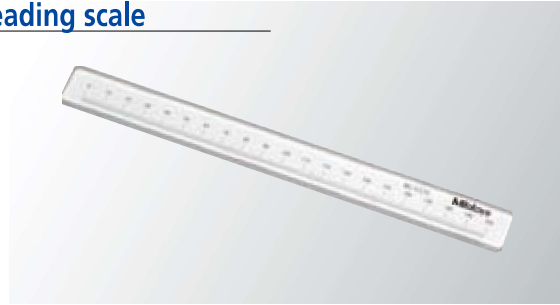

Order No.	172-118	172-161
Scale length	200mm	300mm
Minimum reading	0.5mm	
Scale accuracy (at 20°)	(15+0.015L) $\mu$ m L: measuring length (mm)	
Glass scale for direct measurement of a projected image, and for measuring the projected image of a standard scale for determining projection ratio accuracy		

## OPTOEYE 200 (OPT-200)



- > An edge detecting device for improving the measuring efficiency and reliability of a profile projector by removing the need to position the cross hairs on an edge manually. This has the effect of eliminating the operator variability factor from data entry and shortening the measurement time.
- > The detector uses an optical fiber that can be easily fixed on the screen with chart clips.
- > The device is provided with an error detection function that works if the screen light intensity changes.
- > This device can be retrofitted on QM-Data200 and does not need an AC adapter since power is supplied from QMData 200 through the connecting cable.

Order No.	332-151
Illumination	Contour/surface*
Detecting directivity	Non-directional
Minimum detectable circle	$\varnothing$ 2mm
Minimum detectable line width	1mm
Maximum response speed	1000mm/s
Repeatability (under contour illumination)	: 1 $\mu$ m**
Applicable model	Installable on PJ-H30E/30A/30C (detector mounting plate A No.12AAE671 is required). For PJ-H30B/30D, it has been incorporated in the main unit.

\*Mitutoyo's condition \*\*Mitutoyo test condition

## Up-and-down stand

For QM-Data200 (stand-type specification), receipt printer, etc.



Order No.	172-270
Platform position	Adjustable to a height of 720 to 1020mm.
Platform size	600x450mm

## Overlay charts

To quickly check an image projected on the screen, an appropriate chart is used. 12 types of overlay charts are available according to each purpose of use.

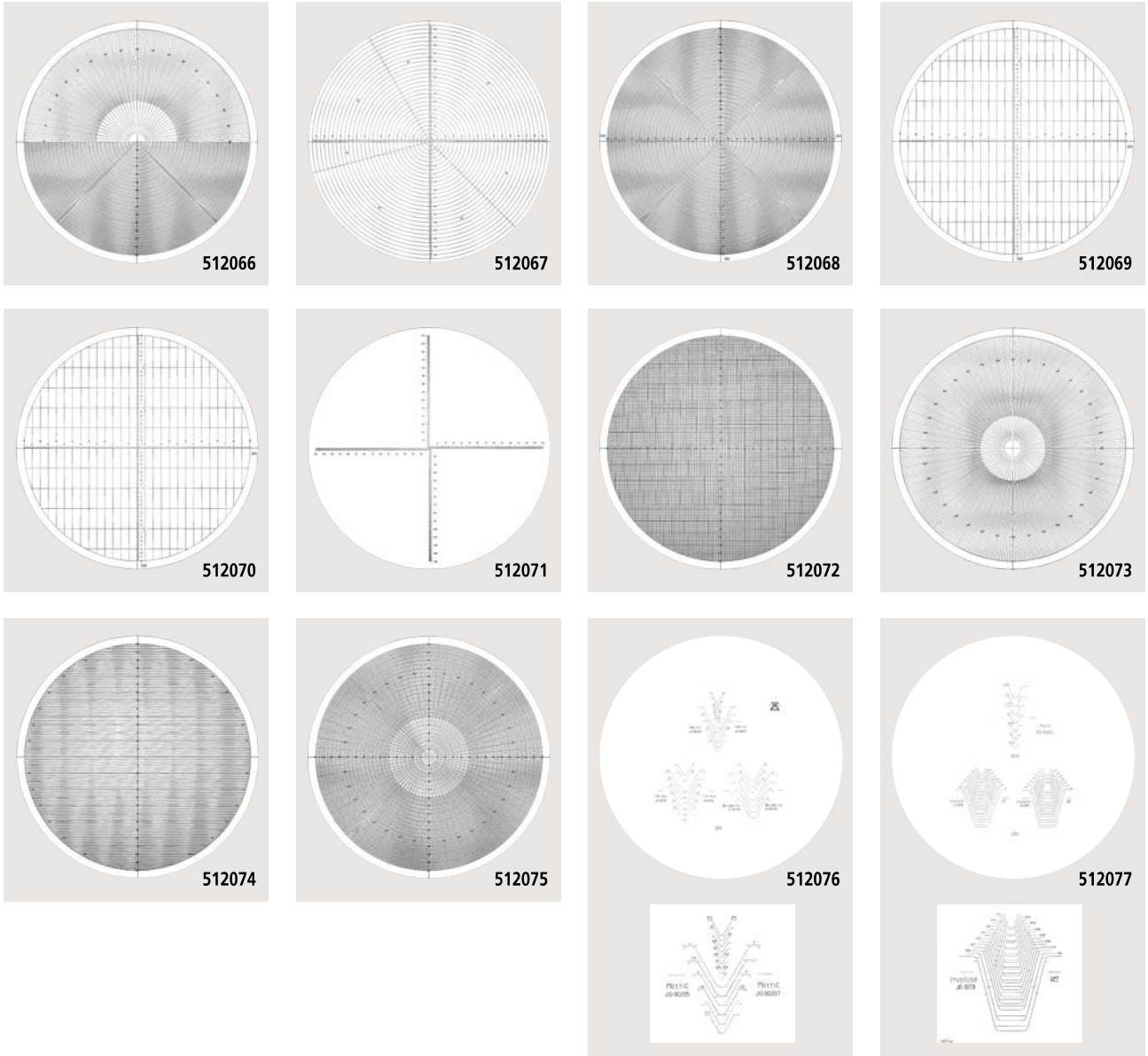

Order No.	Specification
<b>932105</b>	Set of 12 charts ( <b>512066</b> to <b>512077</b> )
<b>512066</b>	Upper side: radial lines (at intervals of 1°) Lower side: concentric circles (at intervals of 1mm)
<b>512067</b>	Concentric circles (at intervals of 5mm) with cross hairs (1mm graduation)
<b>512068</b>	Concentric circles (at intervals of 1mm) with cross hairs
<b>512069</b>	Horizontal: parallel lines at intervals of 50mm (50-times enlargement of 1mm) Vertical: parallel lines at intervals of 20mm (20-times enlargement of 1mm)
<b>512070</b>	10mm-interval grids
<b>512071</b>	Cross hairs (0.5mm graduation)
<b>512072</b>	1mm-interval grids

Order No.	Specification
<b>512073</b>	1°-interval radial lines
<b>512074</b>	Horizontal: 1mm-interval parallel lines
<b>512075</b>	1mm-interval concentric circles and 1°-interval radial lines
<b>512076</b>	Metric screw for 20X lens: P=0.2 to 2mm Unified screw: 28 to 12 threads/inch Whitworth screw: 20 to 10 threads/inch
<b>512077</b>	Metric screw for 100X lens: P=0.075mm to 0.225mm pitch Involute tooth profile for 20X lens (reference rack tooth profile) 20° pressure angle: 0.2 to 1 14.5° pressure angle: 0.2 to 1

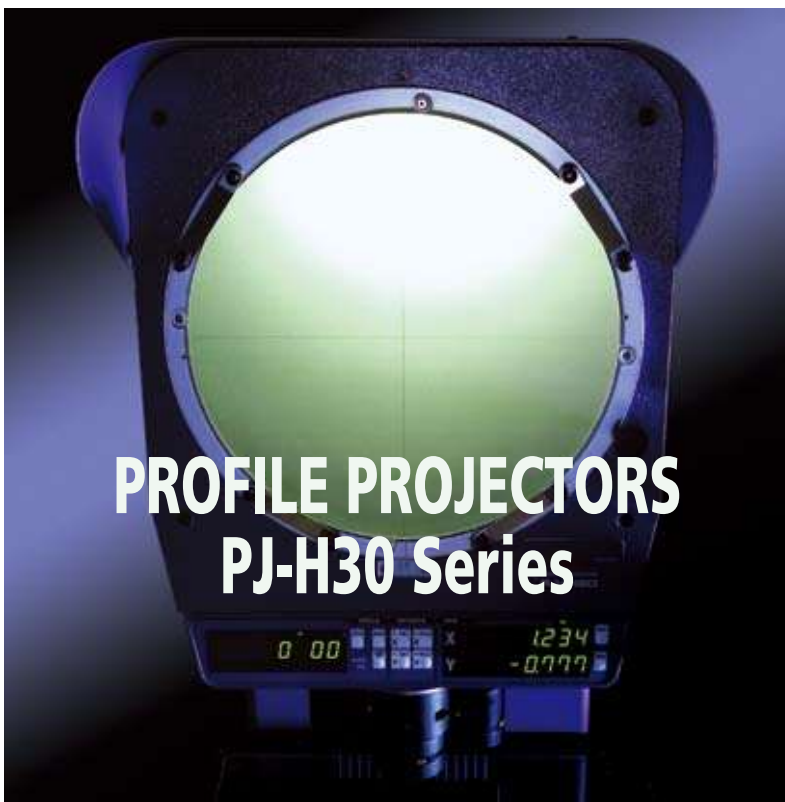

# PROFILE PROJECTORS PJ-H30 Series

Specifications are subject to change without notice.

Note: All information regarding our products, and in particular the illustrations, drawings, dimensional and performance data contained in this pamphlet, as well as other technical data are to be regarded as approximate average values. We therefore reserve the right to make changes to the corresponding designs, dimensions and weights. The stated standards, similar technical regulations, descriptions and illustrations of the products were valid at the time of printing. Only quotations submitted by ourselves may be regarded as definitive.

**Our products are classified as regulated items under Japanese Foreign Exchange and Foreign Trade Law. Please consult us in advance if you wish to export our products to any other country. If the purchased product is exported, even though it is not a regulated item (Catch-All controls item), the customer service available for that product may be affected. If you have any questions, please consult your local Mitutoyo sales office.**

Our products are classified as regulated items under Japanese Foreign Exchange and Foreign Trade Law. Please consult us in advance if you wish to export our products to any other country. If the purchased product is exported, even though it is not a regulated item (Catch-All controls item), the customer service available for that product may be affected. If you have any questions, please consult your local Mitutoyo sales office.

- Coordinate Measuring Machines
- Vision Measuring Systems
- Form Measurement
- Optical Measuring
- Sensor Systems
- Test Equipment and Seismometer
- Digital Scale and DRO Systems
- Small Tool Instruments and Data Management

## Mitutoyo Corporation

20-1, Sakado 1-Chome,  
Takatsu-ku, Kawasaki-shi,  
Kanagawa 213-8533, Japan  
T +81 (0) 44 813-8230  
F +81 (0) 44 813-8231  
<http://www.mitutoyo.co.jp>