

Mitutoyo

Mitutoyo Quality

Portable Surface Roughness Tester Surftest SJ-410 Series

Form Measurement



Bulletin No. 2306

Portable Surface Roughness Tester

Surftest SJ-410 Series

Analysis functions that surpass the rest



User benefit **1**

Easy and safe measurements that anyone can perform efficiently

User benefit **2**

Higher level of quality control



Touch screen for easier operations

The high-visibility color-graphic LCD touch screen clearly displays calculated results and assessed profiles. A backlight enables comfortable viewing even under poor lighting conditions.

User benefit 3

Doing double duty for space saving

SJ-412
Traverse range 50mm



SJ-411
Traverse range 25 mm

User benefit **1**
Easy and safe measurements that anyone can perform efficiently

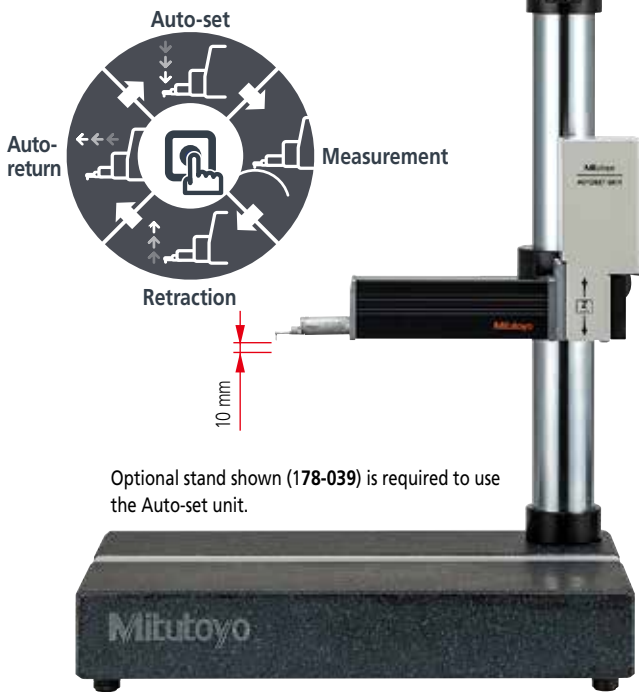

The auto-set unit* allows measurements to be made with the push of a single button, saving you time and increasing work efficiency.



The auto-set function safely controls descent of the detector, eliminating the possibility of operator error causing damage to the stylus.

Auto-set unit*
178-010

This unit automatically completes a full measurement cycle of stylus contact, measurement, stylus retraction and detector auto-return from the push of one button (stylus retraction and detector auto-return can be switched on and off by operating the drive unit).



Options for SJ-410 Series

X-axis adjustment unit*
178-020

This unit helps fine-tune the horizontal (X axis) direction.

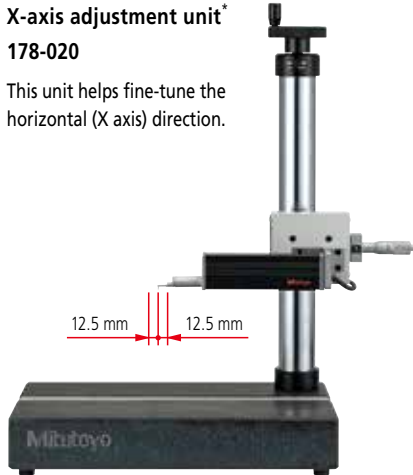

Tilting adjustment unit*
178-030

This unit is used for aligning the workpiece surface with the detector reference plane. It supports the DAT function to make the leveling of workpiece surfaces easier.



Complete set*

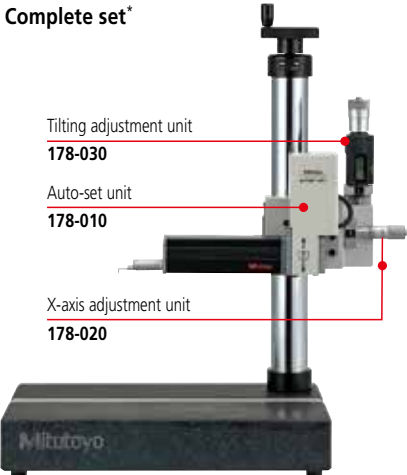

* This is an optional accessory for the **SJ-410** Series. It can only be used on the simple column stand (optional accessory, order No. **178-039**). When the units are used in combination, straightness for **SJ-411 / 412** drive unit will be degraded about 0.2μm. Cannot be used when the tester's main unit is an older model (**SJ-401 / 402**).

Assessing a single measurement result under two different evaluation conditions

A single measurement enables simultaneous analysis under two different evaluation conditions. A single measurement allows calculation of parameters and analysis of filtered profiles without the need for recalculation after saving data, which contributes to higher work efficiency.

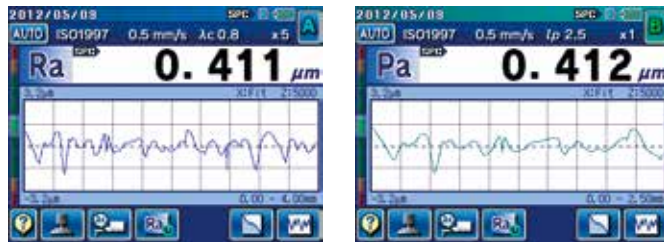

3-axis Adjustment Table <Option> 178-047

This table provides the alignment adjustments required when measuring cylindrical surfaces. The corrections for the pitch angle and the swivel angle are determined from a preliminary measurement and the Digimatic micrometers are adjusted accordingly. A flat-surfaced workpiece can also be leveled with this table.

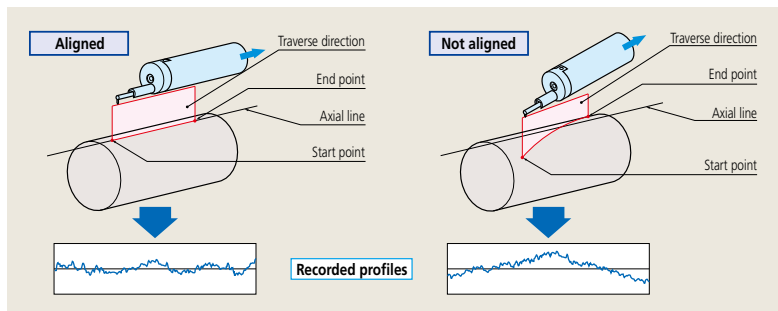

DAT Function for the leveling table <Option>

The leveling table can be used to align the surface to be tested with the detector reference plane. The operator is guided through the procedure by screen prompts.

178-048

Inclination adjustment angle: $\pm 1.5^\circ$
 Table dimensions: 130x100 mm
 Maximum load: 15 kg

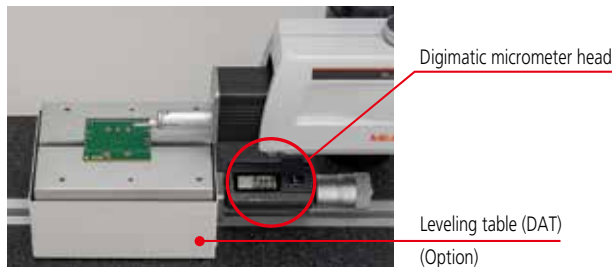

Powerful support for leveling

The height/tilt adjustment unit is included for leveling the drive unit prior to making skidless measurements and is supported by guidance from the unique DAT function making it easier to achieve highly accurate alignment.

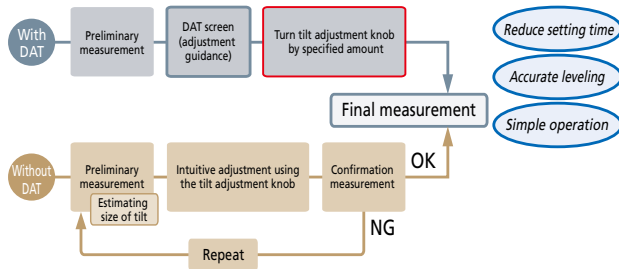

Simple column stand for SJ-410 Series <Option>

178-039

Vertical adjustment range: 250mm
 Dimensions: 400x250x578 mm
 Mass: 20 kg



Combining (adjustment guidance)

User benefit **2**
 Higher level of quality control
 Wireless communication and advanced analysis

Anyone can easily perform high-level data collection.

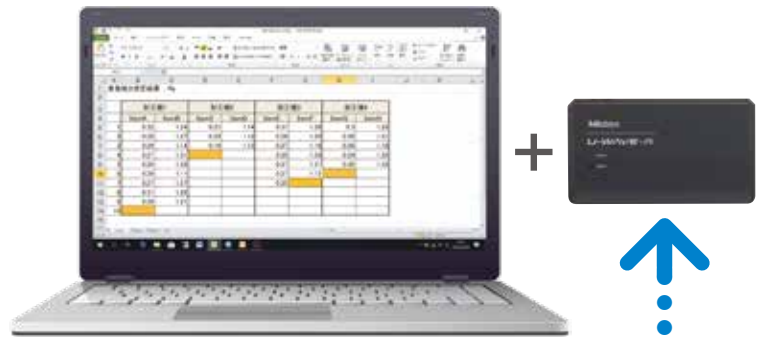

Wireless and quick capture of measurement results on a PC. No more handwriting, and also easy data input with a single touch <Option>

 Wireless Input Tool
U-WAVE

This unit allows you to remotely load Surftest **SJ-410** calculation results (SPC output) into commercial spreadsheet software on a PC. You can essentially use a one-touch operation to enter the calculation results (values) into the cells in the spreadsheet software.

 One-touch Input
USB Input Tool

This unit allows you to load Surftest **SJ-410** calculation results (SPC output) into commercial spreadsheet software on a PC via a USB connector. You can essentially use a one-touch operation to enter the calculation results (values) into the cells in the spreadsheet software.



U-WAVE-R (Connects to the PC)
02AZD810D



U-WAVE-T* (Connects to the **SJ-410**)
02AZD880G
 * Requires the optional Surftest **SJ-410** connection cable.
02AZD790D



USB Input Tool Direct
USB-ITN-D
06AFM380D



USB keyboard signal conversion type*
IT-016U
264-016-10
 * Requires the optional Surftest **SJ-410** connection cable.
 1 m: **936937**
 2 m: **965014**

More advanced analysis with optional software and easy creation of inspection record tables by transferring data to Excel

For SURFTEST SJ-410 Series

Simplified Communication Program (Free software)

The SurfTest SJ-410 Series has a USB interface, enabling setting up of measurement conditions and starting the measurement via PC. A program is also provided that lets you create inspection record tables using a Microsoft Excel® macro.

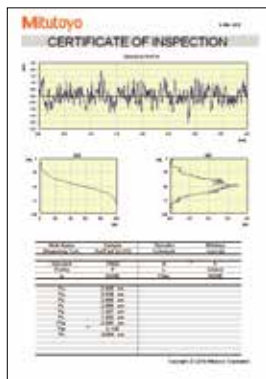

This program can be downloaded free of charge from the Mitutoyo website.
<https://www2.mitutoyo.co.jp/eng/contact/products/sj/index.html>

Required environment*

- OS: Windows 7
- Spreadsheet software: Microsoft Excel 2010
- Windows 8
- Microsoft Excel 2013
- Windows 10
- Microsoft Excel 2016

* Windows OS and Microsoft Excel are products of Microsoft Corporation.

The optional USB cable is also required.

USB cable for SJ-410 Series 12AAD510

Contour/Roughness analysis software

FORMTRACEPAK-AP

More advanced analysis can be performed by loading SJ-410 Series measurement data to software program FORMTRACEPAK-AP via a memory card (option) for processing back at base.

Higher accuracy measurements with selectable drive unit

A wide range, high-resolution detector

■ Detector

Measuring range/resolution:

800 μm/0.01 μm

80 μm/0.001 μm

8 μm/0.0001 μm

High straightness drive unit

■ Drive unit

Straightness/traverse length:

0.3 μm/25mm (SJ-411)

0.5 μm/50mm (SJ-412)



Extending measurement to narrow features

Surface roughness measurement requires a run-up distance before starting the measurement (or retrieving data). When the SJ-410 Series measures, its run-up distance is normally set to 0.5 mm. However, this distance can be shortened to 0.15 mm using the narrow-part measurement function. This function extends the measurement of narrow locations to features such as piston-ring grooves and O-ring grooves.

Typical applications

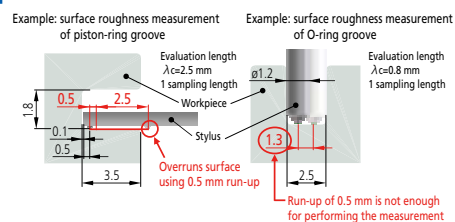

Easily measures R-surface roughness (skidless measurement)

Usually, a spherical or cylindrical surface (R-surface) cannot be evaluated but, by removing the radius with a filter, R-surface data is processed as if taken from a flat surface. Other curved surfaces can be processed such as parabolical and ellipsoidal.

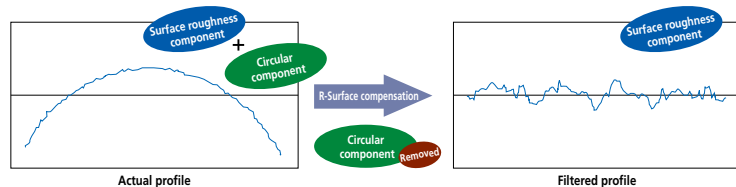

User benefit 3

Doing double duty for space saving

Surface Roughness/ Fine Contour

Supporting not only surface roughness measurement but also contour (fine contour) measurement



Simple contour analysis function

Point group data collected for surface roughness evaluation is used to perform simplified contour analysis (step, step height, area and coordinate difference). It assesses minute forms that cannot be assessed by a regular contour measuring machine.



Step



Coordinate difference



Area

Your choice of skidless or skidded measurement

Skidless measurement

Skidless measurement is where surface features are measured relative to the drive unit reference surface. This measures waviness and finely stepped features accurately, in addition to surface roughness, where range is limited to the stylus travel available.

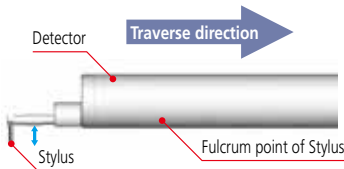

Measuring example of stepped features: Skidless



Measured profile



Skidded measurement

In skidded measurements, surface features are measured with reference to a skid following close behind the stylus. This cannot measure waviness and stepped features exactly, but the range of movement within the measurement made is greater because the skid tracks the workpiece surface contour.

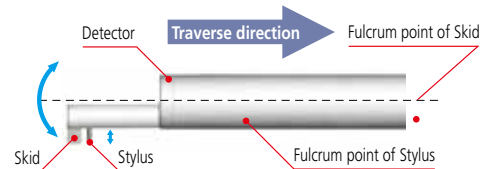

Measuring example of stepped features: Skidded



Measured profile



Easy to use and highly functional

This portable surface roughness tester is equipped with analysis functionality rivaling that of benchtop surface roughness testers.



Data compensation

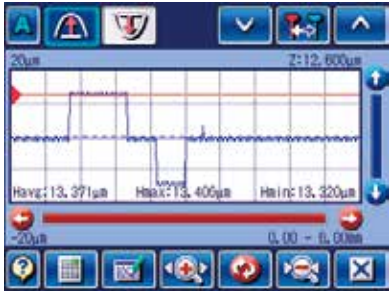

Simple contour analysis function

Equipped with externally controllable interfaces as standard

A variety of interfaces supplied as standard

The external device interfaces that come as standard include USB, RS-232C, SPC output and foot switch I/F.



Data storage

Memory card (optional) is supported

The measurement conditions and data can be stored in a memory card (optional) and recalled as required. This enables batch analysis and printout of data after on-site measurement.



- **Measurement condition**
Internal memory: 10 sets
Memory card: 500 sets
- **Measurement result**
Memory card: 10000 sets

High-speed thermal printer built in

High-speed printer prints out measurement results on site

A high-quality, high-speed thermal printer prints out measurement results.

It can also print a BAC curve or an ADC curve, as well as, calculated results and assessed profiles. These results and profiles are printed out in landscape format, just as they appear on the color-graphic LCD.

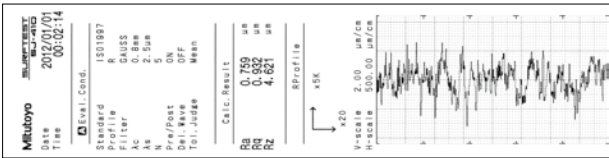

Equipped with convenient carrying case as standard

The unit is easily transported in a dedicated carrying case which includes the tester and holders for the accessories. (Standard accessory)



Other Optional Accessories

XY leveling tables

The tester includes X- and Y-axes micrometer heads. This makes axis alignment much easier because the tilt adjustment center is the same as the rotation center of the table.

(Order No. **178-042-1/178-043-1**)

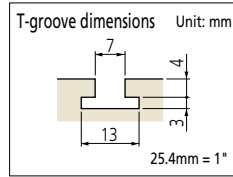

Movement is in X and Y axes only.

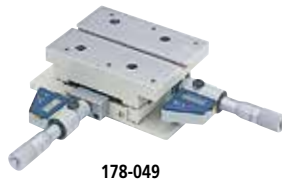

Order No.	178-042-1 (mm) 178-052-1 (inch) with digital heads	178-043-1 (mm) 178-053-1 (inch) with analog heads	178-049 (mm) 178-058 (inch/mm) with digital heads
Items			
Table dimensions	130×100 mm		
Maximum load	15 kg		
Inclination adjustment angle	±1.5°		—
Swiveling angle	±3°		—
X/Y-axis travel range	±12.5 mm	±12.5 mm	±12.5 mm
Resolution	0.001 mm	0.01 mm	0.001 mm
Dimensions (WxDxH)	262×233×83 mm	220×189×83 mm	262×233×55 mm
Mass	6.3 kg	6 kg	5 kg

Cylinder attachment

This block can be positioned on top of cylindrical objects to perform measurements.

12AAB358

Diameter: ø15 to 60 mm

Configuration

- Cylindrical measurement block
- Auxiliary block
- Clamp



Optional accessories, consumables, and others for SJ-410

- | | |
|--|----------------------------|
| • Printer paper (5 rolls) | 270732 |
| • Durable printer paper (5 rolls) | 12AAA876 |
| • Touch-screen protector sheet (10 sheets) | 12AAN040 |
| • Memory card * (2 GB / 8 GB) | 12AAW452 / 64PMI244 |
| • Connecting cable (for RS-232C) | 12AAA882 |
| • Foot switch | 12AAJ088 |

* micro SD card (with a conversion adapter to SD card)

Precision vise

Fits on the stand.

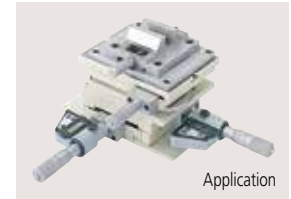

Order No.	178-019
Clamping method	Sliding jaws
Jaw opening	36 mm
Jaw width	44 mm
Jaw depth	16 mm
Height	38 mm

Roughness specimen W



Display: Ra = Approx. 3 μm,
Approx. 0.4 μm

178-604

Note: Ra = Approx. 0.4 μm can only be used for stylus tip checking.

Reference step specimen

Used to calibrate detector sensitivity.

178-611

Step nominal values: 2 μm / 10 μm



Vibration Isolator (Air cushion type)

Vibration isolator for simple column stand for SJ-410 Series (**178-039**).

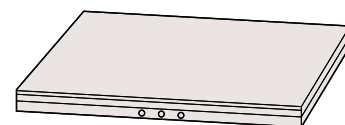

178-039-1

Note: No pump is supplied. An American-valve-compatible hand pump is required.

Enhanced standard functions

Sheet buttons

Single button measurements

A sturdy sheet-button panel with superior durability in any environment is provided. For repeat measurement of the same work, a simple press of the start switch can complete measurement, analysis and printout.



Recalculating

Previously measured data can be recalculated for use in other evaluations by changing the current standard, assessed profile and roughness parameters.

Note: Some conditions are limited.

GO/NG judgement function

An "GO/NG" judgment symbol is displayed when limits are set for the roughness parameter. In case of "NG," the calculated result is highlighted. The calculated result can also be printed out.



Calc. Result		
Ra	↑ 1.103	μm
Rq	OK 1.427	μm
Rz	↓ 7.259	μm

The "OK" symbol means the measurement is within the limits set; "NG" means it is not, in which case an arrow points to either the upper or lower limit in the printout.

Multilingual support

The display interface supports 16 languages.

(Japanese, English, German, French, Italian, Spanish, Portuguese, Korean, Chinese (simplified/traditional), Czech, Polish, Hungarian, Turkish, Swedish, Dutch)

Password protection

Access to functions can be restricted by a password

A pre-registered password can limit use of measurement conditions and other settings to the tester's administrator.

Arbitrary sampling length setting

This function allows a sampling length to be arbitrarily set in 0.01 mm increments (SJ-411: 0.1 mm to 25 mm, SJ-412: 0.1 mm to 50mm).

It also allows the SJ-410 Series to make both narrow and wide range measurements.

Applicable standards

Complies with many industry standards

The Surftest SJ-410 complies with the following standards:

JIS (JIS-B0601-2001, JIS-B0601-1994, JIS B0601-1982), VDA, ISO-1997, and ANSI.

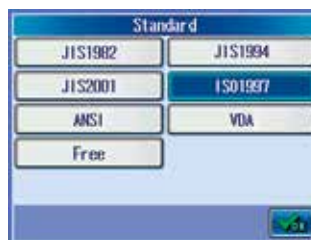

For deep groove (10 mm)

- 12AAC735 (2 μm)
- 12AAB409 (5 μm)^{*1}
- 12AAB421 (10 μm)^{*1}
- () : Tip radius

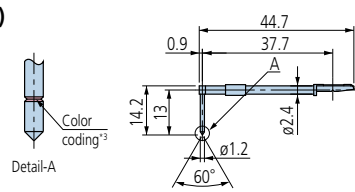

Nosepiece

- For deep groove 10
- 12AAB349

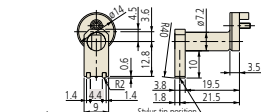

Remarks
Depth: 10 or less, Width: 9.5 or more

- For narrow groove
- 12AAB350

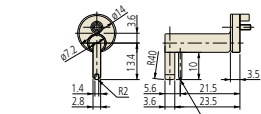

Remarks
Depth: 10 or less, Width: 3 or more

- For R-Surface
- 12AAB351

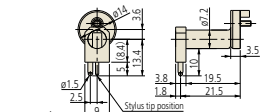

Remarks
Convex: R1.5 or more
Concave: R3 or more

- For vibration
- 12AAB352

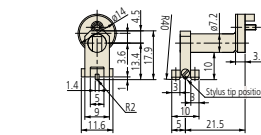

For deep groove^{*2} (20 mm)

- 12AAC736 (2 μm)
- 12AAB408 (5 μm)^{*1}
- 12AAB420 (10 μm)^{*1}
- () : Tip radius

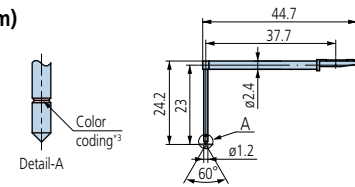

Nosepiece

- For deep groove 20
- 12AAB348

Remarks
Groove depth: 20 or less
Groove pitches: 9.5 or more

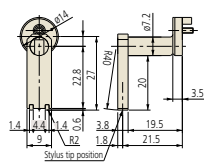

For deep groove^{*2} (30 mm)

- 12AAC737 (2 μm)
- 12AAB407 (5 μm)^{*1}
- 12AAB419 (10 μm)^{*1}
- () : Tip radius

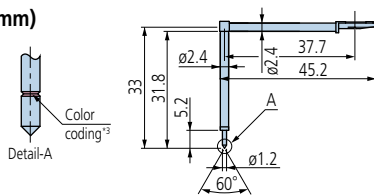

For gear tooth

- 12AAB339 (2 μm)
- 12AAB410 (5 μm)
- 12AAB422 (10 μm)
- () : Tip radius

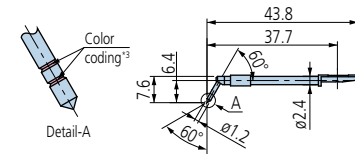

Nosepiece

- For corner
- 12AAB353

Remarks
Groove depth: 20 or less
Groove pitches: 9.5 or more

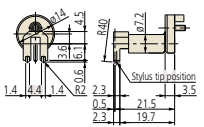

For rolling circle waviness surface^{*4}

- 12AAB338 (ø1.588)
- () : Tip radius

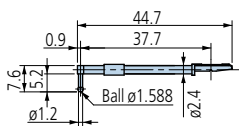

For knife-edge^{*4}

- 12AAC738 (2 μm)
- 12AAB411 (5 μm)^{*1}
- 12AAB423 (10 μm)^{*1}
- () : Tip radius

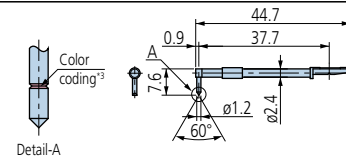

Nosepiece

- For knife-edge
- 12AAB354

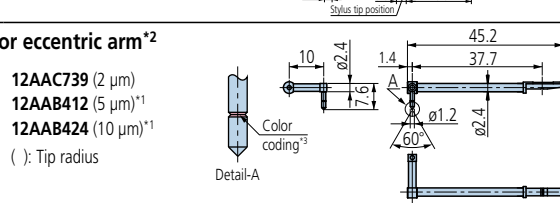

For eccentric arm^{*2}

- 12AAC739 (2 μm)
- 12AAB412 (5 μm)^{*1}
- 12AAB424 (10 μm)^{*1}
- () : Tip radius

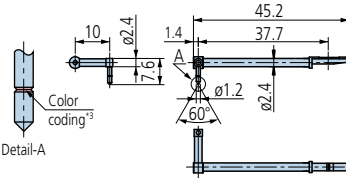

For deep groove^{*2} (20 mm)

- 12AAE893 (2 μm)^{*1}
- 12AAE909 (5 μm)
- () : Tip radius

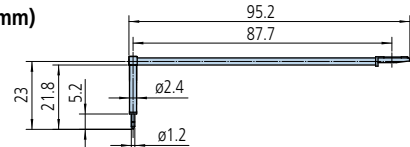

For deep groove^{*2} (40 mm)

- 12AAE895 (2 μm)^{*1}
- 12AAE911 (5 μm)
- () : Tip radius

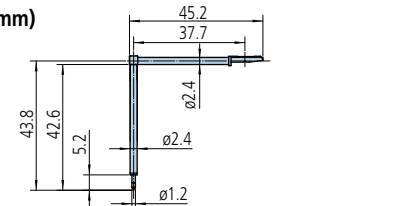

**For deep groove (30 mm)/
Double-length for deep hole^{*2}**

- 12AAE894 (2 μm)^{*1}
- 12AAE910 (5 μm)
- () : Tip radius

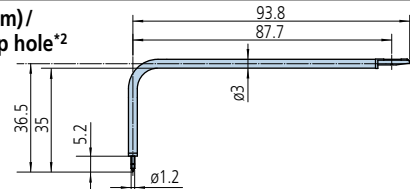

**For gear tooth/
Double-length for deep hole^{*2}**

- 12AAE896 (2 μm)^{*1}
- 12AAE912 (5 μm)^{*1}
- () : Tip radius

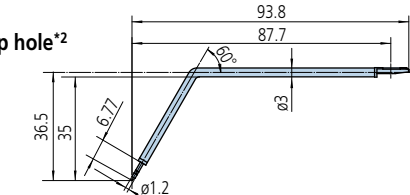

**For rolling circle waviness/
Double-length for deep hole^{*2*4}**

- 12AAE886 (250 μm)
- () : Tip radius

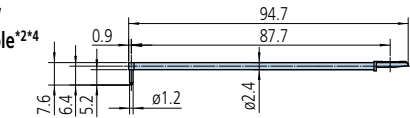

**For corner hole/
Double-length for deep hole^{*2}**

- 12AAM601 (2 μm)
- 12AAM603 (5 μm)
- () : Tip radius

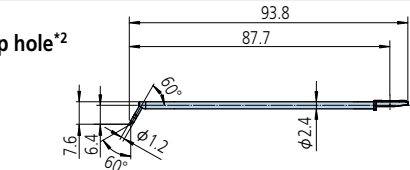

Hole-bottom cone stylus

- 12AAE899 (2 μm)
- 12AAE915 (5 μm)^{*1}
- () : Tip radius

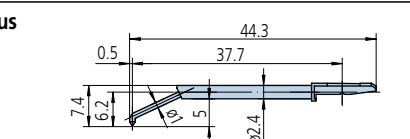

*1 Tip angle 90°

*2 For downward-facing measurement only.

*3

Tip radius	2 μm	5 μm	10 μm
Color coding	Black	No color	Yellow

*4 Used for calibration, a standard step gauge (178-611, option) is also required

Note: Customized special interchangeable styli are available on request. Please contact any Mitutoyo sales office for more information.

Specifications

Model No.	inch/mm	SJ-411		SJ-412	
		178-581-11A	178-581-12A	178-583-11A	178-583-12A
Measuring range	X axis	25mm (1")		50mm (2")	
	Z axis (detector)	800µm, 80µm, 8µm (32000µin, 3200µin, 320µin) Up to 2,400µm (96,000µin) when using an optional stylus.			
Detector	Detection method	Differential inductance			
	Resolution (Range)	0.01µm (800µm) / 0.001µm (80µm) / 0.0001µm (8µm) 0.4µin (32000µin) / 0.04µin (3200µin) / 0.004µin (320µin)			
	Stylus tip shape (Angle/Radius)	60°/2µm (80µin)	90°/5µm (200µin)	60°/2µm (80µin)	90°/5µm (200µin)
	Measuring force	0.75 mN	4 mN	0.75 mN	4 mN
	Radius of skid curvature	40mm (1.57")			
	Measuring methods	Skidless/Skidded (switchable)			
Drive unit (X axis)	Measuring speed	0.05, 0.1, 0.2, 0.5, 1.0mm/s (0.002, 0.004, 0.02, 0.04 inch/s)			
	Drive speed	0.5, 1, 2, 5mm/s (0.02, 0.04, 0.08, 0.2 inch/s)			
	Straightness	0.3µm / 25mm (12µin / 1")		0.5µm / 50mm (20µin / 2")	
Up/down inclination unit	Vertical travel	10mm (0.39")			
	Inclination adjustment angle	±1.5°			
Applicable standards	JIS 1982/JIS 1994/JIS 2001/ISO 1997/ANSI/VDA				
Parameter	Ra, Rq, Rz, Ry, Rp, Rv, Rt, R3z, Rsk, Rku, Rc, RPC, RSm, Rmax ^{*1} , Rz1max ^{*2} , S, HSC, RzJIS ^{*3} , Rppl, RΔa, RΔq, Rlr, Rmr, Rmr (c), Rσc, Rk, Rpk, Rvk, Mr1, Mr2, A1, A2, Vo, λa, λq, Lo, Rpm, tp ^{*4} , Htp ^{*4} , R, Rx, AR, W, AW, Wx, Wte Customizable				
Filtered profile	Primary profile, Roughness profile, DF profile, Waviness profile, Roughness motif profile, Waviness motif profile				
Analysis graph	Material ratio curve, Profile height amplitude distribution curve				
Data compensation functions	Parabola, Hyperbola, Ellipse, Circle, Tilt, No compensation				
Filter	2CR, PC75, Gaussian				
Cutoff value	λc	0.08, 0.25, 0.8, 2.5, 8 mm (.003, .01, .03, .1, .3")			
	λs ^{*5}	2.5, 8, 25µm (100, 320, 1000µin)			
Sampling length	0.08, 0.25, 0.8, 2.5, 8, 25 mm (.003, .01, .03, .1, .3, 1")				
Number of intervals	x1, x2, x3, x4, x5, x6, x7, x8, x9, x10, x11, x12, x13, x14, x15, x16, x17, x18, x19, x20				
Arbitrary length	0.1 to 25 mm (.0039 to 1")		0.1 to 50 mm (.0039 to 2")		
Calculation display unit	Customization	Selection of display/evaluation roughness parameter			
	Simplified contour analysis function	Step, Step quantity, Area, Coordinate difference			
	DAT (Digimatic Adjustment Table) function	Helps to level workpiece prior to skidless measurement			
	Real sampling function	Inputs the displacement of the detector while stopping the drive unit			
	statistical processing	Calculates the maximum value, minimum value, average value, standard deviation, pass rate and histogram for each parameter.			
	Judgment ^{*6}	Maximum value rule, 16 % rule, mean value rule, standard deviation (1σ, 2σ, 3σ)			
	Storing measurement condition	Max. 10 (calculation display unit)			
	Print function (Built-in thermal printer)	Measurement condition/Calculation result/Judgment result/Calculation result per segment/Tolerance value/Evaluation curve/Graphic curve/Material ratio curve/Profile height amplitude distribution curve/Environmental setting items/Statistical result (Histogram)			
	Display language	16 languages (Japanese, English, German, French, Italian, Spanish, Portuguese, Korean, Chinese (simplified/traditional), Czech, Polish, Hungarian, Turkish, Swedish, Dutch)			
	Storage function	Built-in memory: Measurement condition (Up to 10) Memory card (optional): 500 measurement conditions, 10000 measured profiles, 500 display images, 10000 text files, 500 statistical data, 1 backup file of device setting data, 10 data of Trace 10			
External I/O functions	USB I/F, Digimatic output, RS-232C I/F, Foot switch I/F				
Power supply	Battery	Built-in battery (rechargeable Ni-MH battery) / AC adapter			
	Charging time/Endurance	Charging time of the built-in battery: about 4 hours (may vary due to ambient temperature) Endurance: about 1000 measurements (differs slightly due to use conditions/environment)			
	Max. power consumption	50 W			
External dimensions (WxDxH)	Calculation display unit	275x198x109 mm (10.83x7.80x4.29")			
	Up/down inclination unit	131x63x99 mm (5.16x2.48x3.9")			
	Drive unit	128x35.8x46.6 mm (5.04x1.41x1.83")		154.5x35.8x46.6 mm (6.08x1.41x1.83")	
Mass	Calculation display unit	1.7 kg			
	Up/down inclination unit	0.4 kg			
	Drive unit	0.6 kg		0.64 kg	
Standard Accessories	Detector ^{*7} /Standard stylus ^{*8} 178-601 Roughness specimen (Ra3 µm) 270732 Receipt paper (Standard type: 5-roll set) 12BAL402 Protective sheet for the LCD (x1 sheet) 12BAG834 Touch pen 12AAN041 Carrying case		AC adapter, Power cable, Flat-blade screwdriver, Phillips screwdriver, Hex wrench, Strap for the touch pen, Operation manual, One-sheet manual, Warranty card		

*1 Calculation is available only when selecting the VDA, ANSI, or JIS 1982 standards.

*2 Calculation is available only when selecting the ISO 1997 standard.

*3 Calculation is available only when selecting the JIS 2001 standard.

*4 Calculation is available only when selecting the ANSI standard.

*5 Not available when selecting the JIS 1982 standard.

*6 Only the mean value rule is available for the ANSI standard. 16 % rule is not available when selecting the VDA standard.

*7 Depending on the Order No. of the SJ-410 Series main unit, **178-396** or **178-397** is provided as standard.

*8 Standard stylus (**12AAC731** or **12AAB403**) supporting the provided detector is provided as standard.

Note 1: Refer to pages 12 to 13 for details of Detector, Stylus and Nosepiece.

Note 2: To denote your AC line voltage add the following suffixes (e.g. **178-580-11A**). A for 120 V, C for 100 V, D for 230 V, E for 230 V (for UK), DC for 220 V (for China), K for 220 V (for Korea)

Dimensions

Unit: mm
25.4mm = 1"

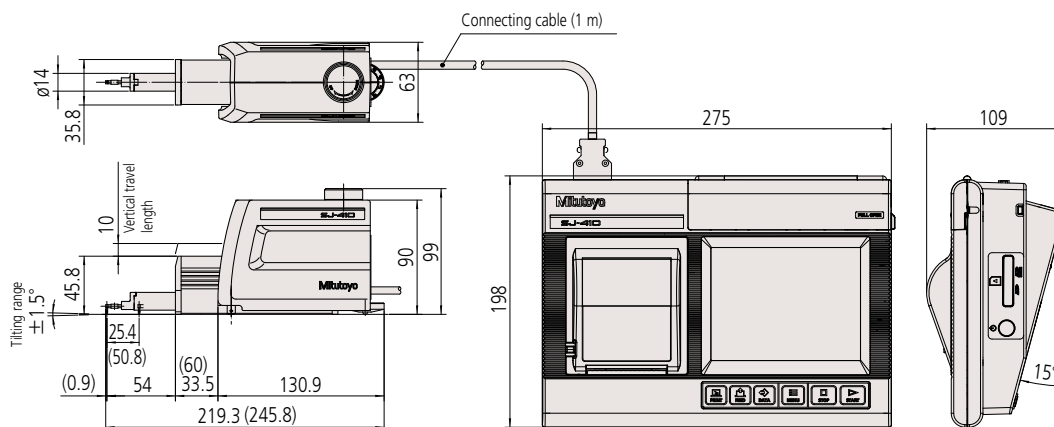

Note: Dimensions in parentheses indicate those of SJ-412 [equipped with a 50mm drive unit].

Example of mounting on simple column stand. (178-039)*1

Unit: mm
25.4mm = 1"

*1 For details see page 5.

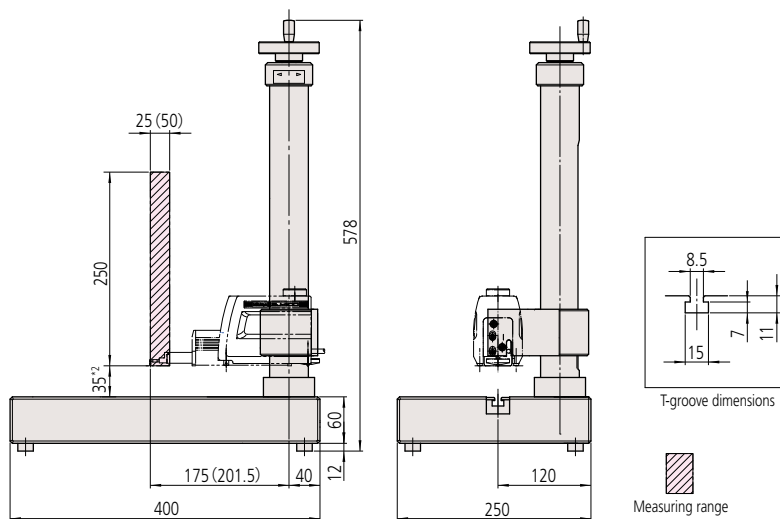

*2 This is the lowest position of the standard stylus mounted on the simple column stand. Since it is 35 mm from the base top, a block of suitable height is required for calibration with a roughness specimen. Use the stand in combination with optional accessories such as a leveling table (178-016) or an XY leveling table (178-024).
Note: The dimensions in parentheses indicate those for SJ-412



Whatever your challenges are, Mitutoyo supports you from start to finish.

Mitutoyo is not only a manufacturer of top quality measuring products but one that also offers qualified support for the lifetime of the equipment, backed by comprehensive services that ensure your staff can make the very best use of the investment.

Apart from the basics of calibration and repair, Mitutoyo offers product and metrology training, as well as IT support for the sophisticated software used in modern measuring technology. We can also design, build, test and deliver measuring solutions and even, if deemed cost-effective, take your critical measurement challenges in-house on a sub-contract basis.



Find additional product literature and our product catalog

www.mitutoyo.com

Note: All information regarding our products, and in particular the illustrations, drawings, dimensional and performance data contained in this printed matter as well as other technical data are to be regarded as approximate average values. We therefore reserve the right to make changes to the corresponding designs. The stated standards, similar technical regulations, descriptions and illustrations of the products were valid at the time of printing. In addition, the latest applicable version of our General Trading Conditions will apply. Only quotations submitted by ourselves may be regarded as definitive. Specifications are subject to change without notice.

Mitutoyo products are subject to US Export Administration Regulations (EAR). Re-export or relocation of our products may require prior approval by an appropriate governing authority.

Trademarks and Registrations

Designations used by companies to distinguish their products are often claimed as trademarks. In all instances where Mitutoyo America Corporation is aware of a claim, the product names appear in initial capital or all capital letters. The appropriate companies should be contacted for more complete trademark and registration information.



Mitutoyo America Corporation
www.mitutoyo.com
 One Number to Serve You Better
 1-888-MITUTOYO (1-888-648-8869)

M³ Solution Centers:

- Aurora, Illinois (Headquarters)
- Boston, Massachusetts
- Charlotte, North Carolina
- Cincinnati, Ohio
- Detroit, Michigan
- Los Angeles, California
- Seattle, Washington
- Houston, Texas