

## Portable Surface Roughness Tester Surftest SJ-210/310 Series

Form Measurement



## Portable Surface Roughness Tester

# Surftest SJ-210/310 Series

### Surftest SJ-210 Series

The Surftest SJ-210 is a user-friendly surface roughness measurement instrument designed as a handheld tool that can be carried with you and used on-site.



Refer to page 4 to 7 for details.

### Surftest SJ-310 Series

The Surftest SJ-310 is a compact, portable, easy-to-use surface roughness measurement instrument equipped with extensive measurement and analysis features.



Refer to page 8 to 11 for details.

## Enhanced power for making measurements on site

Charging is reduced approximately one quarter of the time compared with conventional models. The detector supports a variety of measurement orientations and can perform measurements up against a wall surface or while facing upward. When combined with optional accessories such as a height gage adapter, the detector can perform measurements in various orientations and settings.



# Surftest SJ-210 Series

## Color graphic LCD

Intuitive display that's clear, sharp, and legible.



## Battery

The battery charges in one quarter of the time of previous Mitutoyo products.

## Large, 2.4-inch LCD

The large LCD provides excellent readability.

## Backlight

The backlight improves visibility in dark environments.

## Operation keys

- The keys on the front of the unit and under the sliding cover are well-labeled and easy to use.
- The user-friendly screen layout and arrow keys provide intuitive operability.
- Displayed settings can be changed easily by using the left and right arrow keys.
- Infrequently used keys are hidden under the sliding cover to prevent unintended operations.

## Drive unit

The drive unit can be separated from the display unit by using a cable, allowing more flexible measurement.

The driver can be separated and reattached in one simple step.



There are many different kinds of drivers and detectors available.

(Refer to page 6, 13, 14 for details.)



## High-speed USB communication

Data can be transferred to and from a computer via the high-speed USB interface.

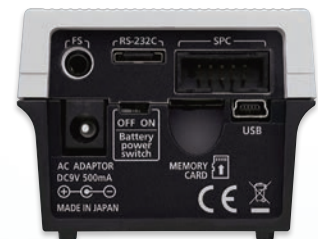

## Applicable standards

In addition to JIS and ISO, the Surftest SJ-210 also complies with ANSI and VDA standards.

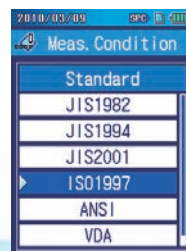

## Memory card support

The memory card slot lets you store large amounts of data onto a memory card.



## Multilingual support

The display interface supports 16 languages.



## Extensive display features that assist measurement

- The highly visible 2.4-inch color graphic LCD with backlight lets you view the screen easily even in dark environments.

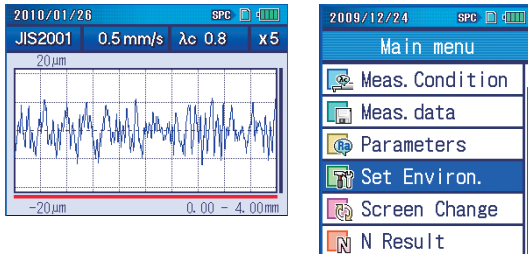

- Pass/fail results are displayed in color.

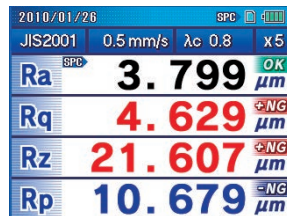

- Assessed profiles, load curves, and amplitude distribution curves can be displayed in addition to calculation results. Assessed profiles can also be zoomed up and down.

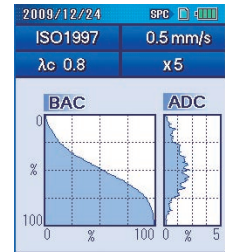

- The display mode can be easily switched between portrait and landscape.
- Calculation results are displayed in large characters.

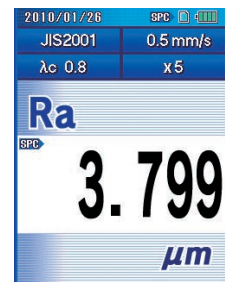
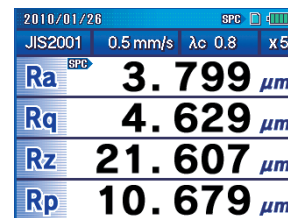

## Advanced data storage capabilities

- Up to 10 measurement conditions can be stored in the internal memory. Conditions can be quickly read according to the workpiece.
- An optional memory card can be used as an extended memory to store large quantities of measured profiles and conditions.

### Storage capacity of memory card (optional)

Data type	Storage capacity of memory card
Measured profiles	10000
Calculation result	500
Measurement condition	500
Display images	500



- Many interface options:
  - A USB interface is equipped as standard.
  - The SurfTest SJ-210 also provides an RS-232C output, Digimatic output, printer output, and foot switch input.



## Advanced features

- The multilingual display interface supports 16 languages, which can be freely switched.
- Access to features can be password-protected.
- A quick-charge, long-life battery is provided.

## Stylus alarm function

- An alarm warns you when the cumulative measurement distance exceeds a preset limit. This feature can be used to prevent problems that would be caused by worn out styli. Any value can be specified as the limit.

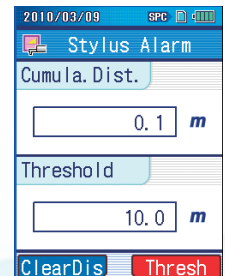

## Easy setting

- Displayed settings can be easily changed by pressing the left and right arrow keys under the sliding cover. For example, these keys can be used to switch the cut-off value ( $\lambda c$ ) and the number of sampling lengths (N) on the measurement screen.



(Example of the measurement screen)

## Setting parameters and recalculating results

- The required parameters can be selected from the screen. The sub-menu also lets you specify detailed settings such as the tolerance. After completing measurement, the parameters can be changed and calculation can be executed again\* using the new parameters.
  - \* May not be possible, depending on the measurement conditions.

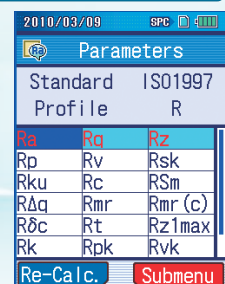

## SJ-210 Series

A wide variation in system setup is possible with the detector + drive unit + display unit combination

### Highly functional detectors and drive units

The driver can be separated from the display unit and reattached in one easy step.

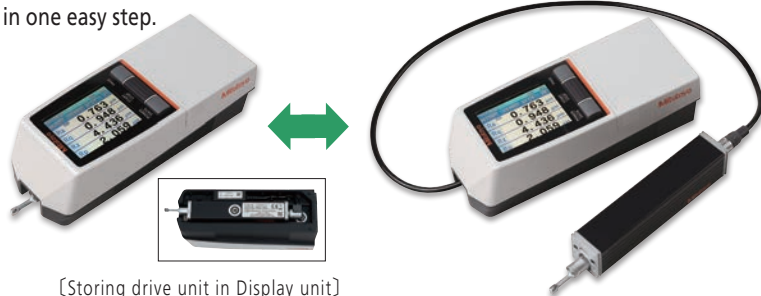

[Storing drive unit in Display unit]

[Detaching drive unit from Display unit]

A wide range of optional detectors is available, including detectors for small holes, extra small holes, gear tooth surfaces, and deep grooves.

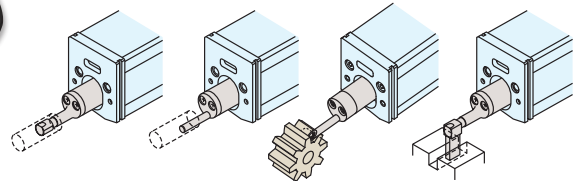

Refer to page 14 for details of detector.

### Detector supplied as standard



Selectable from the following two items.

- Measuring force: 0.75 mN  
Stylus tip: Tip radius 2  $\mu\text{m}$   
Tip angle 60°
- Measuring force: 4 mN  
Stylus tip: Tip radius 5  $\mu\text{m}$   
Tip angle 90°

### Drive units (selectable)

#### Standard drive unit

- Popular standard drive unit



#### Transverse tracing drive unit

- Best suited for measurement of narrow, shrouded workpiece features such as crankshaft, EDM parts, etc. (Patent Registered in Japan)



#### Retractable drive unit

- The detector is in the retracted position at rest so it is immune from damage when inserted into a feature whose profile cannot be easily seen, such as a blind hole, etc.



### Positive stylus contact indication

Stylus contact with the workpiece is indicated by color coding in the display. This is helpful when visibility of the surface to be measured is restricted (e.g. when measuring within a shrouded feature or groove).



No contact



Contact

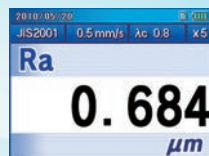

### Carrying case

A convenient carrying case is supplied as standard for protecting the instrument in the field.



# SJ-210 Series Specifications

Specifications						
Type of detector	Standard drive unit type		Retractable drive unit type		Transverse tracing drive unit type	
Model No.	SJ-210 (0.75 mN type)	SJ-210 (4 mN type)	SJ-210 (0.75 mN type)	SJ-210 (4 mN type)	SJ-210 (0.75 mN type)	SJ-210 (4 mN type)
	inch/mm		inch/mm		inch/mm	
X axis	.63" (16.0mm)				.22" (5.6mm)	
Measuring range	Range	14400 μin (-7900 μin to +6300 μin) [360 μm (-200 μm to +160 μm)]				
	Z axis (Detector) Range/Resolution	14400 μin / .8 μin (360 μm / 0.02 μm) 4000 μin / .2 μin (100 μm / 0.006 μm) 1000 μin / .08 μin (25 μm / 0.002 μm)				
Measuring speed	When measuring: 0.01, 0.02, 0.03 in/s (0.25mm/s, 0.5mm/s, 0.75mm/s) When returning: 0.4 in/s (1mm/s)					
Measuring force/Stylus tip	0.75 mN / 2 μmR 60°, 4 mN / 5 μmR 90°					
Skid force	Less than 400 mN					
Applicable standards	JIS '82/JIS '94/JIS '01/ISO '97/ANSI/VDA					
Assessed profiles	Primary profile, Roughness profile, DF profile, Roughness profile-Motif					
Parameters	Ra, Rc, Ry, Rz, Rq, Rt, Rmax <sup>1</sup> , Rp, Rv, R3z, Rsk, Rku, Rc, RPC, Rsm, Rz1max <sup>2</sup> , S, HSC, Rz1S <sup>3</sup> , Rppi, RΔ a, RΔ q, Rlr, Rmr, Rmr(c), RΔ c, Rk, Rpk, Rvk, Mr1, Mr2, A1, A2, Vo, Rpm, tp <sup>4</sup> , Htp <sup>4</sup> , R, Rx, AR, Possible Customize					
Graph analysis	Bearing area curve/Amplitude distribution curve					
Filters	Gaussian, 2CR75, PC75					
Cut off length	$\frac{\lambda c}{\lambda s^5}$	0.003, 0.01, 0.03, 0.1" (0.08, 0.25, 0.8, 2.5mm)				
Sampling length	0.003, 0.01, 0.03, .1" (0.08, 0.25, 0.8, 2.5mm)					
Number of sampling lengths (xn)	x1, x2, x3, x4, x5, x6, x7, x8, x9, x10, Arbitrary 0.01~.63" (.0001" interval) [(0.3~16.0mm: 0.01mm interval)]				x1, x2, x3, x4, x5, x6, x7, x8, x9, x10, Arbitrary .0118 ~ .22" (.0001" interval) [(0.3 ~ 5.6mm: 0.01mm Interval)]	
LCD dimensions	1.45 x 1.93" (36.7x48.9 mm)					
Display languages	Japanese, English, German, French, Italian, Spanish, Portuguese, Korean, Traditional Chinese, Simplified Chinese, Czech, Polish, Hungarian, Turkish, Swedish, Dutch					
Measurement result display	Vertical display: 1-parameter display/3-parameter display/Trace display Horizontal display: 1-parameter display/4-parameter display/Trace display (Horizontal display is invertable)					
Printing function <sup>*6</sup> (Dedicated printer is required separately.)	Measurement conditions/Calculation results/GO/NG judgement result/Calculation results for each sampling length/ Assessed profile/Bearing area curve/Amplitude distribution curve/Environment setting information					
External I/O	USB I/F, Digimatic Output, Printer Output, RS-232C I/F, Foot SW I/F					
Functions	Customization	Desired parameters can be selected for calculation and display				
	GO/NG judgment <sup>*7</sup>	By max value/16 %/Standard deviation				
	Storage of measurement condition	Save the conditions at power OFF				
Storage	Internal memory: Measurement condition (10 sets) Memory card (Option): 500 measurement conditions, 10000 measured profiles, 500 display images Text file (Measurement conditions/Measured profile/Assessed profile/ Bearing area curve/Amplitude distribution curve)					
	Calibration	Auto-calibration with the entry of numerical value/ Average calibration with multiple measurement (Max.5 times) is available				
Power-saving function	Auto-sleep off function (10-600 sec) <sup>*8</sup>					
Power supply	Two-way power supply: battery (rechargeable Ni-MH battery) and AC adaptor Note 1: Charging time: about 4 hours (may vary due to ambient temperature) Note 2: Endurance: about 1000 measurements (differs slightly due to use conditions/environment)					
Size (WxDxH)	Display unit	2.05 x 2.6" x 6.3" (52.1x65.8x160mm) (sliding cover closed, detector not mounted)				
	Drive unit	4.5 x .9 x 1.02" (115x23x26mm) (detector not mounted)				
Mass	About 1.1lbs (500g) (Display unit + Drive unit + Standard detector)					
Standard accessories	<b>12BAA303</b> Connecting cable <sup>*9</sup> <b>178-601</b> Roughness specimen Ra (3 μm) <b>12BAR344</b> Carrying case <b>12BAK700</b> Calibration stage Protective sheets for display, AC Adapter, Operation manual, Quick reference manual, Warranty				<b>12BAA303</b> Connecting cable <sup>*9</sup> <b>178-606</b> Roughness specimen Ra (1 μm) <b>12AAE643</b> Point-contact adapter <b>12AAE644</b> V-type adapter <b>12BAR344</b> Carrying case <b>12BAK700</b> Calibration stage Protective sheets for display AC Adapter, Operation manual Quick reference manual, Warranty	

\*1 Calculation is available only when selecting the VDA, ANSI, or JIS '82 standard.

\*2 Calculation is available only when selecting the ISO '97 standard.

\*3 Calculation is available only when selecting the JIS '01 standard.

\*4 Calculation is available only when selecting the ANSI standard.

\*5 Not available when selecting the JIS '82 standard.

\*6 Order the SJ-210 printer (178-421, optional accessory) separately. See page 19 for details about the SJ-210 printer.

\*7 Standard deviation only can be selected in ANSI. 16 % rule cannot be selected in VDA.

\*8 Auto-sleep function is invalid when AC adaptor is used.

\*9 For connecting the calculation display unit and drive unit.

Note: To denote your AC line voltage add the following suffixes (e.g. 178-560-11A).

A for 120 V, C for 100 V, D for 230 V, E for 230 V (for UK), DC for 220 V (for China), K for 220 V (for Korea)

# Surftest SJ-310 Series

## User friendly, high-functionality display unit with integrated high-speed printer

The large 5.7-inch color graphic touch-screen LCD provides excellent readability. Furthermore, selecting icons from the touch panel display\* provides intuitive and easy operation. The integrated high-speed printer offers the user the ability to perform the entire measuring and printing process with the push of a single button (START button). \* Text display can also be selected.

**High-speed printer**  
BAC and ADC curves can be printed in addition to calculation results (including pass/fail results) and assessed profiles. The printer offers an easy-to-understand layout and can also print horizontally to match the content displayed on the LCD. Furthermore, printing speed is approximately 50% faster than conventional models.

**5.7-inch color graphic LCD with touch screen**  
Measurement Result ↔ Measured profile  
One-touch switching ↔ BAC curve ADC curve

**Sheet buttons**  
Frequently used functions, such as the measurement start button, are provided as rugged sheet buttons with excellent durability.

**Built-in battery**  
With drastically enhanced power compared to conventional models, the Surftest SJ-310 can make 1,500 continuous measurements on a full charge achieved in 4 hours.

## Highly functional detectors and drive units

### Detector supplied as standard



One of two types may be selected:

- Measuring force: 0.75 mN  
Stylus tip: Tip radius 2 μm  
Tip angle 60°
- Measuring force: 4 mN  
Stylus tip: Tip radius 5 μm  
Tip angle 90°

A wide range of optional detectors is available, including detectors for small holes, extra small holes, gear tooth surfaces, and deep grooves.

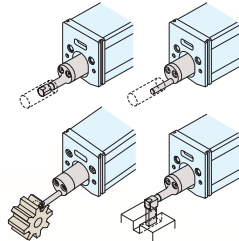

### Drive units

- Standard drive unit  
Popular standard drive unit



- Transverse tracing drive unit  
Best suited for measurement of narrow, shrouded workpiece features such as crankshaft bearings, EDM parts, etc. (Patent Registered in Japan)



- Retractable drive unit  
The detector is in the retracted position at rest so it is immune from damage when inserted into a feature whose shape cannot be easily seen, such as a blind hole, etc.



## Links to a wide variety of external instruments

You can save parameter recalculations and measurement results in text format on a memory card and import into commercial spreadsheet software on a PC. You can also connect to a PC using the USB connector and use a dedicated software application to perform everything from measurement control and condition modification to issuing inspection result reports.

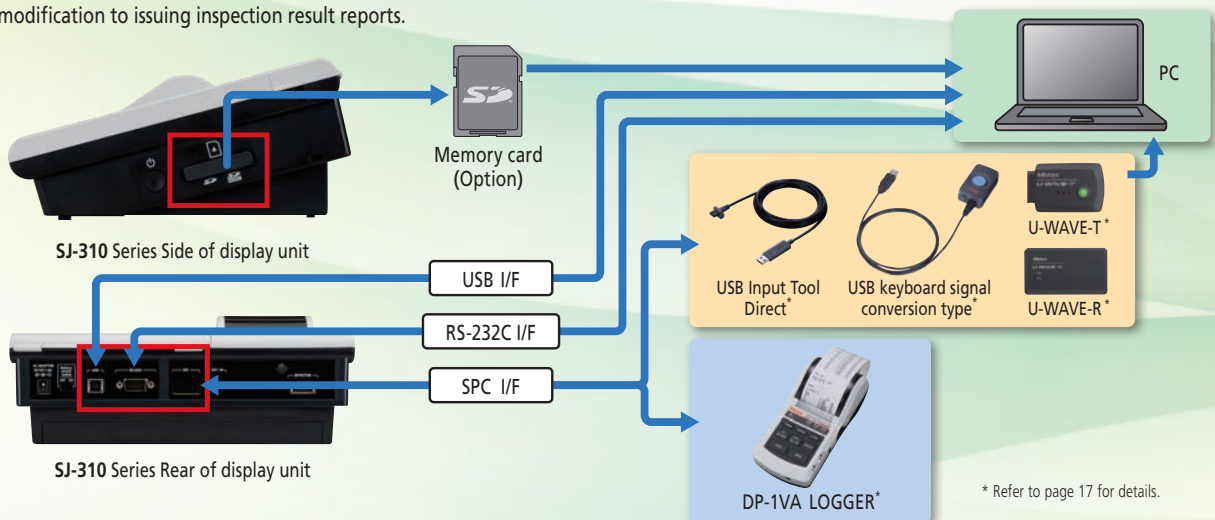

\* Refer to page 17 for details.



### Switches between icon and text display

The display can be switched between icon and text, providing easy, user-friendly operation. Additionally, the guidance feature provides detailed explanations of touch-screen buttons.



Icon

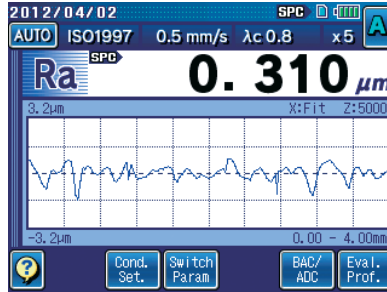

Text



### Easy specification of assessment conditions from a list

Setting assessment conditions is simple because you can select the desired condition from a displayed list (e.g., standard, parameter).

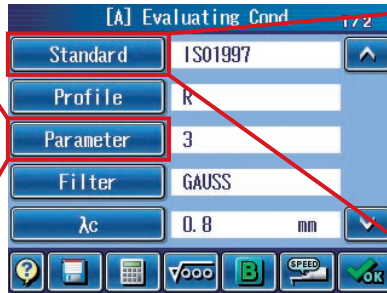

### Zooming waveforms and analyzing coordinate differences

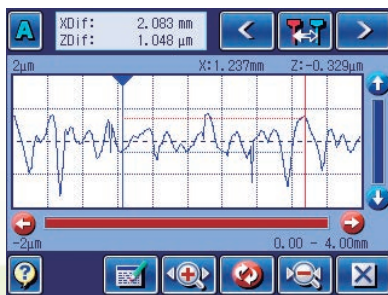

You can not only magnify or shrink waveforms, but also calculate the coordinate difference between two points using a ruler operation. You can quickly check the irregularity status without waiting for a printout.

### Deleting unnecessary data

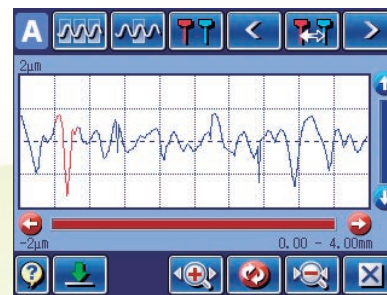

With the Surftest SJ-310, you can delete portions of measurement data. This feature allows you to make new calculations by deleting data that should not be included in parameter calculation, such as data on a scratch.

### Displaying GO/NG judgment results

By specifying a tolerance in advance, you can display pass/fail results in color.

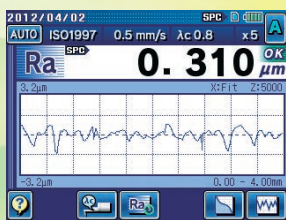

OK

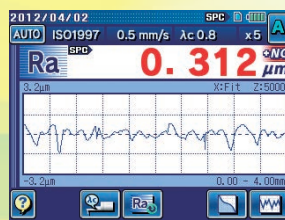

+NG

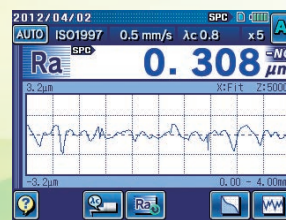

-NG

### Surface texture symbol entry

You can enter assessment conditions using ISO/JIS surface texture symbols. (Patent registered in Japan, U.S.A., Germany, UK, France) (Patent pending in China)

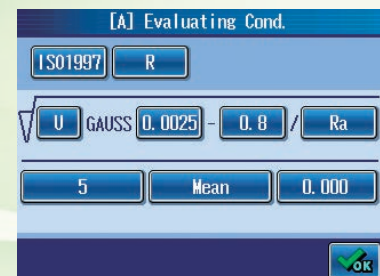

# SJ-310 Series

## Measurement results can be displayed in several ways

Measurement results can be presented in the form of a 1-parameter, profile, 4-parameter or trace display.



1-parameter display: one parameter measurement result

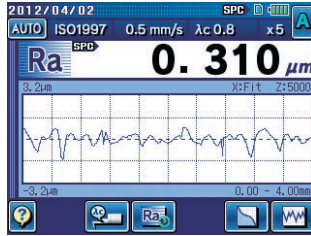

Profile display: one parameter measurement result and the measured profile

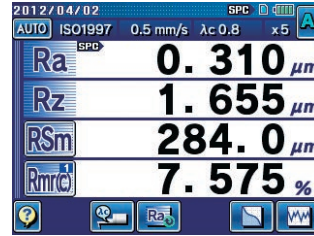

4-parameter display: multiple parameter measurement results

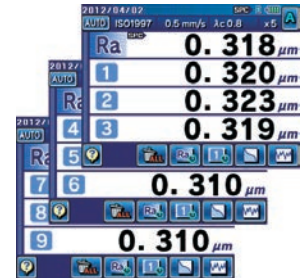

Trace display: the ten latest measurement results using the same parameter

## Recalculation function

After completing measurement, you can modify the assessment conditions (standard, profile, and parameter) and easily recalculate the results using the new condition.\* \* Not possible with all measurement conditions.

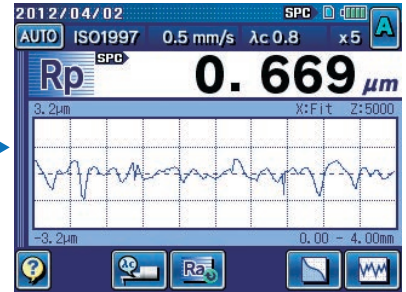
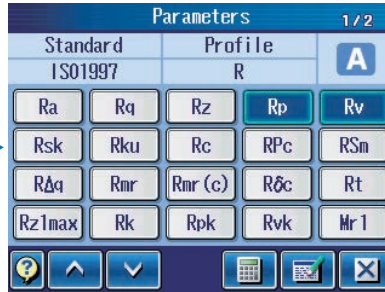
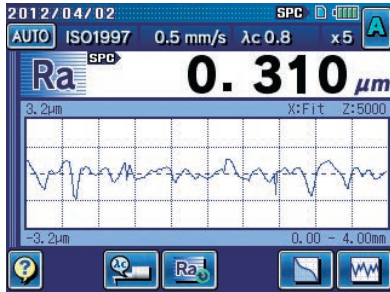

## Dual assessment of a single measurement

Using the result of a single measurement, you can make calculations or analyze assessment profiles under two different assessment conditions (standard, profile, filter, etc.) without using the recalculation feature.

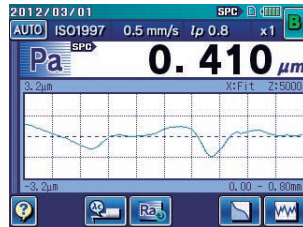
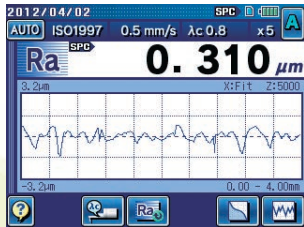

## Stylus alarm function

An alarm warns you when the cumulative measurement distance exceeds a preset limit. This feature can be used to prevent problems that would be caused by worn out styli. Any value can be specified as the limit.

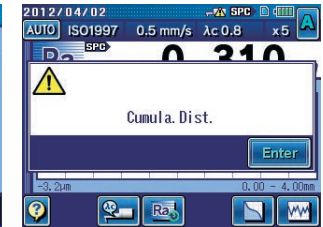

## Positive stylus contact indication

Stylus contact with the workpiece is indicated by color coding in the display. This is helpful when visibility of the surface to be measured is restricted (e.g. when measuring within a shrouded feature or groove).



No contact



Contact



## Extensive statistical processing features

You can make a maximum of 300 statistical measurements using up to three parameters to obtain averages, standard deviations, maximums, minimums, passing rates, and histograms (upper and lower limits can be displayed). This feature is ideal for day-to-day data management.

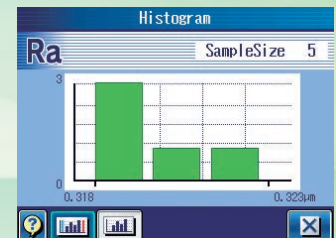
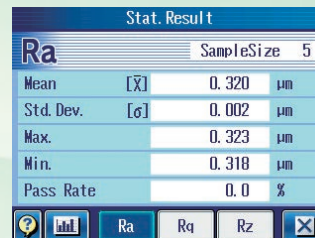

# SJ-310 Series Specifications

## Specifications

Type of detector	Standard drive unit type		Retractable drive unit type		Transverse tracing drive unit type	
Model No.	SJ-310 (0.75 mN type)	SJ-310 (4 mN type)	SJ-310 (0.75 mN type)	SJ-310 (4 mN type)	SJ-310 (0.75 mN type)	SJ-310 (4 mN type)
	inch/mm	178-571-11A	178-571-12A	178-573-11A	178-573-12A	178-575-11A 178-575-12A
X axis		.63" (16.0mm)			.22" (5.6 mm)	
Measuring range	Range	14400 μin (-7900 μin to +6300 μin) [360 μm (-200 μm to +160 μm)]				
	Range/resolution	14400 μin / .8 μin (360 μm / 0.02 μm) 4000 μin / .2 μin (100 μm / 0.006 μm) 1000 μin / .08 μin (25 μm / 0.002 μm)				
Measuring speed		When measuring: 0.01, 0.02, 0.03 in/s (0.25mm/s, 0.5mm/s, 0.75mm/s), When returning: .04 in/s (1mm/s)				
Measuring force/Stylus tip		0.75 mN/2 μmR 60°, 4 mN/5 μmR 90°				
Skid force		400 mN or less				
Applicable standards		JIS '82/JIS '94/JIS '01/ISO '97/ANSI/VDA				
Assessed profiles		Primary, Roughness, DF, R-Motif, W-Motif				
Parameters		Ra, Rc, Ry, Rz, Rq, Rt, Rmax <sup>*1</sup> , Rp, Rv, R3z, Rsk, Rku, Rc, Rpc, Rsm, Rz1max <sup>*2</sup> , S, HSC, RzJIS <sup>*3</sup> , Rppi, RΔa, RΔq, Rlr, Rmr, Rmr(c), Rδc, Rk, Rpk, Rvk, Mr1, Mr2, A1, A2, Vo, λa, λq, Lo, Rpm, tp <sup>*4</sup> , Htp <sup>*4</sup> , R, Rx, AR, W, AW, Wx, Wte, Possible Customize				
Graph analysis		Bearing area curve/Amplitude distribution curve				
Filters		Gaussian, 2CR75, PC75				
Cut-off length	$\lambda c$	.003, .01, .03, .1, .3" (0.08, 0.25, 0.8, 2.5, 8 mm)				
	$\lambda S^{*5}$	100, 320 μin (2.5, 8 μm)				
Sampling length		.003, .01, .03, .1, .3" (0.08, 0.25, 0.8, 2.5, 8 mm)				
Number of sampling lengths		x1, x2, x3, x4, x5, x6, x7, x8, x9, x10, Arbitrary 0.01~.63" (.0001" interval) [(0.3~16.0mm: 0.01mm interval)]			x1, x2, x3, x4, x5, x6, x7, x8, x9, x10, Arbitrary .0118 ~ .22" (.0001" Interval) [(0.3 ~ 5.6mm: 0.01mm Interval)]	
LCD dimensions		4.64" x 3.47" (117.8 x 88.2 mm)				
Display languages		Japanese, English, German, French, Italian, Spanish, Portuguese, Korean, Traditional Chinese, Simplified Chinese, Czech, Polish, Hungarian, Turkish, Swedish, Dutch				
Measurement result display		1-parameter display: one parameter measurement result 4-parameter display: four parameter measurement results Profile display: one parameter measurement result and the measured profile Trace display: The ten latest measurement results using the same parameter				
Printing function		Measurement conditions/Calculation results/GO/NG judgement result/Calculation results for each sampling length/ Tolerance value/Assessed profile/Graphic curve/Bearing area curve/Amplitude distribution curve/Environmental setting information				
External I/O		USB I/F, Digimatic output, RS-232C I/F, External SW I/F				
Functions	Customization	Desired parameters can be selected for calculation and display				
	GONG judgement <sup>*6</sup>	Max rule/16 % rule/Average rule/Standard deviation (1σ, 2σ, 3σ)				
	Storage of measurement condition	Save the condition at power OFF				
	Storage	Internal memory: Measurement condition (10 sets) Memory card (option): 500 measurement conditions, 10000 measuring data, 10000 text data, 500 statistic data, 1 backup of machine setting, the last ten traces (Trace 10)				
Calibration	Auto-calibration with the entry of numerical value/Average calibration with multiple measurement (MAX.12 times) is available					
Power-saving function		Auto-sleep function (30-600 sec) <sup>*7</sup>				
Power supply		Two-way power supply: battery (rechargeable Ni-MH battery) and AC adapter Note 1: Charging time: about 4 hours (may vary due to ambient temperature) Note 2: Endurance: about 1500 measurements (differs slightly due to use conditions/environment)				
Size (WxDxH)	Display unit	10.8" x 4.3" x 7.8" (275 x 109 x 198 mm)				
	Drive unit	4.5" x 0.9" x 8.9" (115 x 23 x 26.7 mm)				
Mass		About 3.9 lbs. (1.8 kg) (Display unit + Drive unit + Standard detector)				
Standard accessories		<b>12AAW066</b> Connecting cable <sup>*8</sup> <b>178-601</b> Roughness reference specimen (Ra3 μm) <b>357651</b> AC adapter <b>12AAA217</b> Nosepiece for plane surface <b>12AAA218</b> Nosepiece for cylinder <b>12AAA216</b> Supporting leg <b>12BAK700</b> Calibration stage <b>12BAG834</b> Stylus pen <b>12BAL402</b> Protection sheet <b>270732</b> Printer paper (5 pieces) <b>12BAL400</b> Carrying case Philips screwdriver, Strap for stylus pen, Operation manual, Quick reference manual, Warranty		<b>12AAW066</b> Connecting cable <sup>*8</sup> <b>178-606</b> Roughness reference specimen (Ra1 μm) <b>357651</b> AC adapter <b>12AAE643</b> Point-contact adapter <b>12AAE644</b> V-type adapter <b>12BAK700</b> Calibration stage <b>12BAG834</b> Stylus pen <b>12BAL402</b> Protection sheet <b>270732</b> Printer paper (5 pieces) <b>12BAL400</b> Carrying case Philips screwdriver, Strap for stylus pen, Operation manual, Quick reference manual, Warranty		

\*1 Only for VDA/ANSI/JIS '82 standards. \*2 Only for ISO '97 standard. \*3 Only for JIS '01 standard. \*4 Only for ANSI standard. \*5 Not available for JIS '82 standard.

\*6 Standard deviation only can be selected in ANSI. 16% rule cannot be selected in VDA. \*7 Auto-sleep function is invalid when AC adapter is used.

\*8 For connecting the calculation display unit and drive unit.

Note: To denote your AC line voltage add the following suffixes (e.g. **178-570-11A**). A for 120 V, C for 100 V, D for 230 V, E for 230 V (for UK), DC for 220 V (for China), K for 220 V (for Korea)

# Dimensions

## SJ-210 Series Display unit

Unit: mm

- Drive unit stored inside display unit (Standard detector installed in drive unit)

25.4mm = 1"

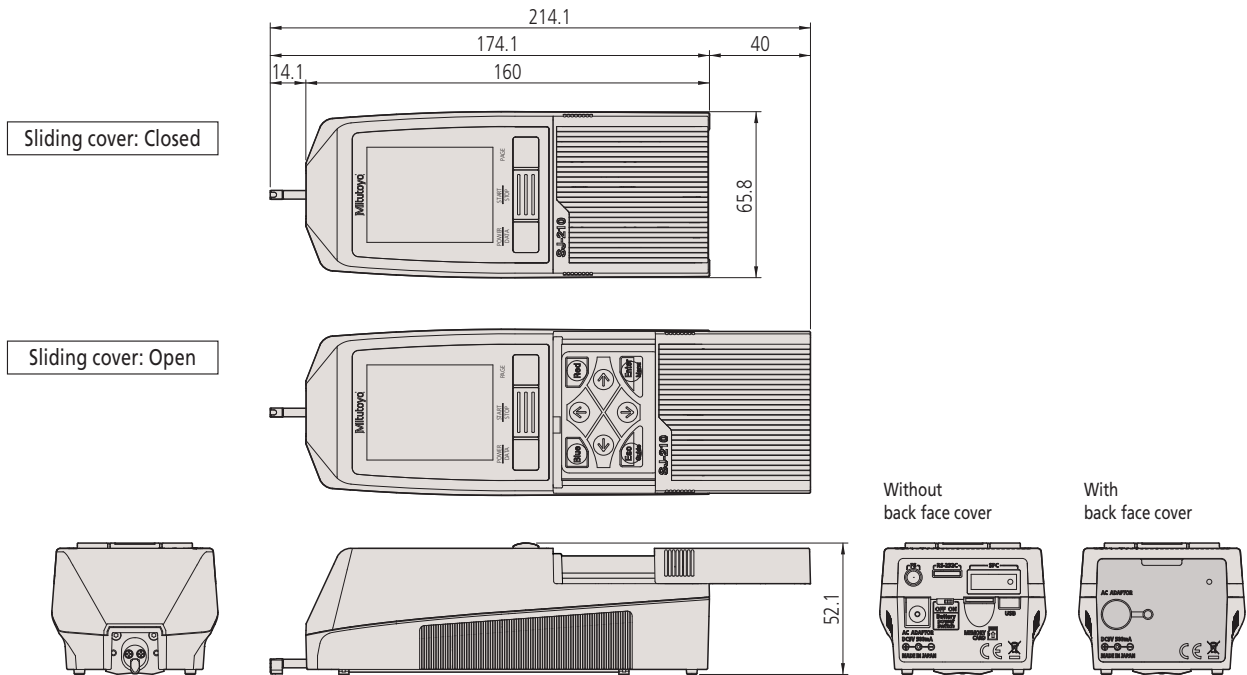

- Drive unit not stored inside display unit (Standard detector installed in drive unit)

### Standard drive unit

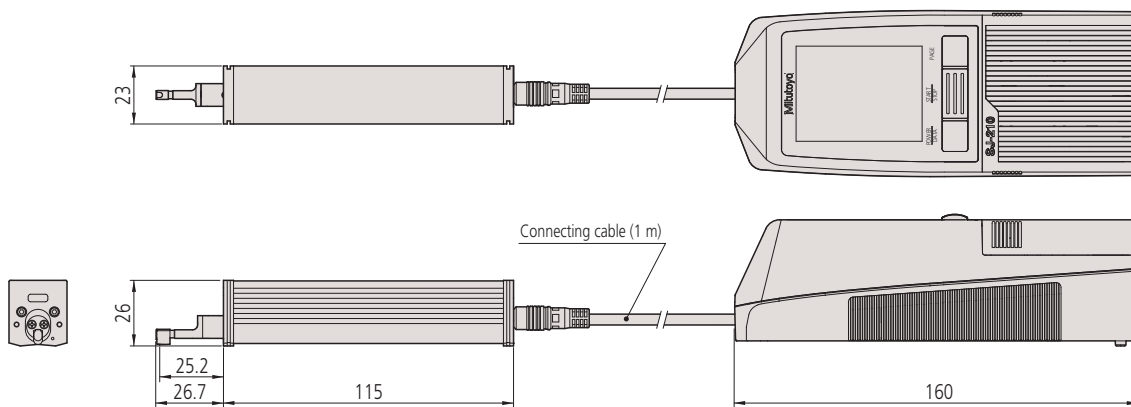

SJ-310 Series Display unit

Unit: mm

25.4mm = 1"

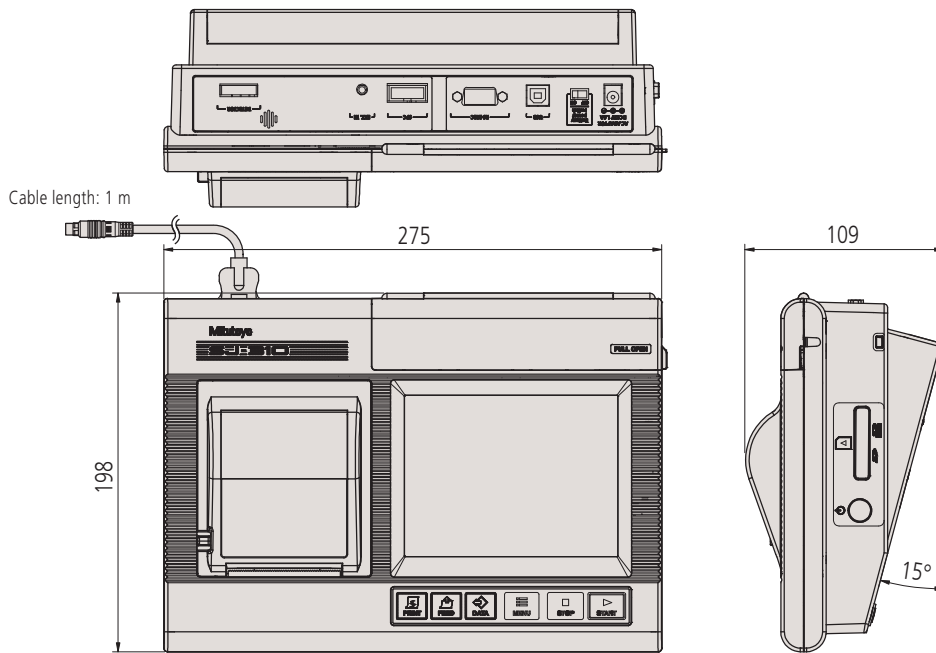

Drive unit

Unit: mm

25.4mm = 1"

Drive unit type	Drive unit external view*
Standard drive unit	<p>External view of the standard drive unit. Dimensions shown: 23.0 mm (top thickness), 26.0 mm (bottom thickness), 25.2 mm (width of the top section), 26.7 mm (width of the bottom section), and 115.0 mm (total length).</p>
Retractable drive unit	<p>External view of the retractable drive unit. Dimensions shown: 23.0 mm (top thickness), 26.0 mm (bottom thickness), 2.0 mm (width of the top section), 23.2 mm (width of the bottom section), 26.7 mm (width of the bottom section), and 115.0 mm (total length).</p>
Transverse tracing drive unit	<p>External view of the transverse tracing drive unit. Dimensions shown: 23.0 mm (top thickness), 26.0 mm (bottom thickness), 3.0 mm (width of the top section), 6.6 mm (width of the bottom section), 45.5 mm (width of the bottom section), 47 mm (width of the bottom section), and 115.0 mm (total length).</p>

\* External dimension for the models with standard detector conforms to each drive unit.

# Dimensions

**Detectors** Unit: mm

25.4mm = 1"

**Standard detectors**

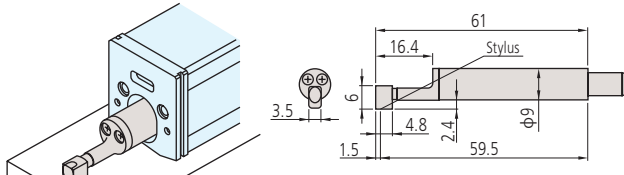

Order No.	Measuring force	Stylus form*	Remarks
<b>178-296</b>	0.75 mN	2 μmR/60°	Dedicated to the standard/retractable drive unit
<b>178-390</b>	4 mN	5 μmR/90°	Dedicated to the standard/retractable drive unit
<b>178-387</b>	0.75 mN	2 μmR/60°	Dedicated to the transverse tracing drive unit
<b>178-386</b>	4 mN	5 μmR/90°	Dedicated to the transverse tracing drive unit
<b>178-391</b>	4 mN	10 μmR/90°	Dedicated to the standard/retractable drive unit

\* Tip radius/Tip angle

**Gear-tooth surface detectors**

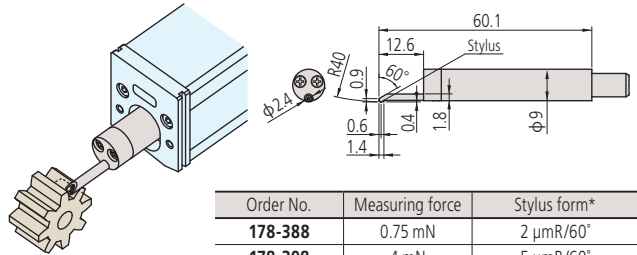

Order No.	Measuring force	Stylus form*
<b>178-388</b>	0.75 mN	2 μmR/60°
<b>178-398</b>	4 mN	5 μmR/60°

\* Tip radius/Tip angle

**Small hole detectors**

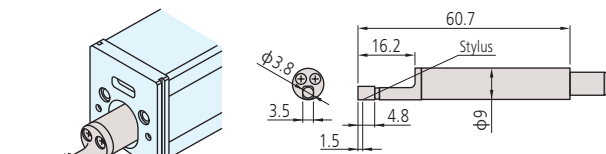

Order No.	Measuring force	Stylus form*	Remarks
<b>178-383</b>	0.75 mN	2 μmR/60°	Minimum measurable hole diameter: ø4.5 mm
<b>178-392</b>	4 mN	5 μmR/90°	Minimum measurable hole diameter: ø4.5 mm

\* Tip radius/Tip angle

**Deep groove detectors**

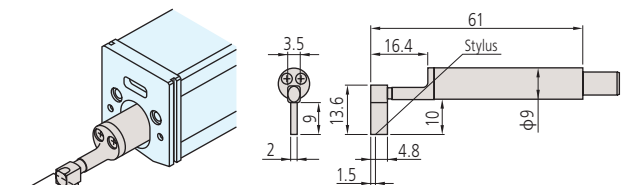

Order No.	Measuring force	Stylus form*	Remarks
<b>178-385</b>	0.75 mN	2 μmR/60°	Not available for the transverse tracing drive unit
<b>178-394</b>	4 mN	5 μmR/90°	Not available for the transverse tracing drive unit

\* Tip radius/Tip angle

**Extra small hole detectors**

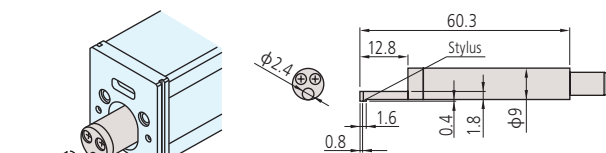

Order No.	Measuring force	Stylus form*	Remarks
<b>178-384</b>	0.75 mN	2 μmR/60°	Minimum measurable hole diameter: ø2.8 mm
<b>178-393</b>	4 mN	5 μmR/90°	Minimum measurable hole diameter: ø2.8 mm

\* Tip radius/Tip angle

• How to identify the stylus tip radius

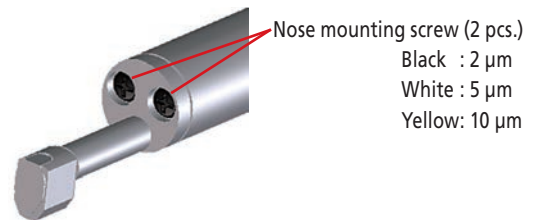

• Custom-made for special order

Any specified detector other than above listed can be custom-made for special order. Please consult your local Mitutoyo sales office.

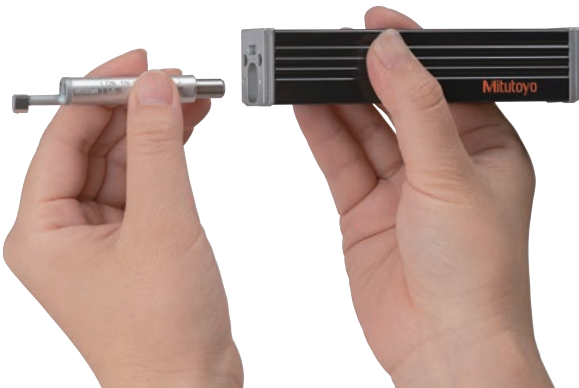

# Optional accessories for SJ-210/310 Series

## Drive unit accessories

### Nosepiece for flat surfaces

12AAA217

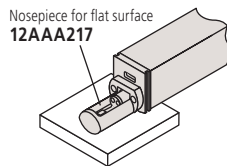

Note 1: Standard accessory for the standard/ retractable drive unit of the SJ-310 Series  
 Note 2: Not available for the transverse tracing drive unit.

### Nosepiece for cylindrical surfaces

12AAA218

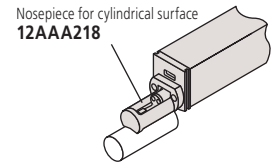

Note 1: Standard accessory for the standard/ retractable drive unit of the SJ-310 Series  
 Note 2: Not available for the transverse tracing drive unit.

### V-type adapter

12AAE644

Note 1: Transverse tracing type standard accessory.  
 Note 2: Dedicated to the transverse tracing drive unit.

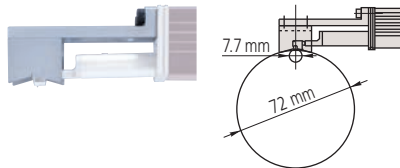

### Point-contact adapter

12AAE643

Note 1: Transverse tracing type standard accessory.  
 Note 2: Dedicated to the transverse tracing drive unit.

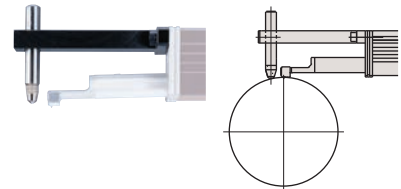

### Extension rod (50 mm)

Note: Only one rod can be used.

12AAA210

Note: Not available for the transverse tracing drive unit.

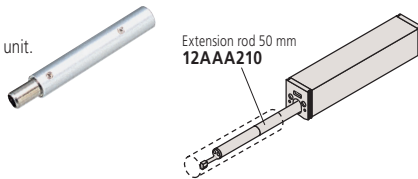

### Extension cable (1 m)

Note: Only one rod can be used.

12BAA303

Note: For connecting calculation display unit and drive unit.

### Support feet set

12AAA216

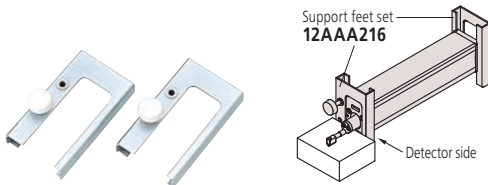

Note 1: Standard accessory for the standard/ retractable drive unit of the SJ-310 Series  
 Note 2: Not attachable to the detector side of the transverse tracing drive unit.

### Vertical positioning adapter

12AAA219

Note: Not available for the transverse tracing drive unit.

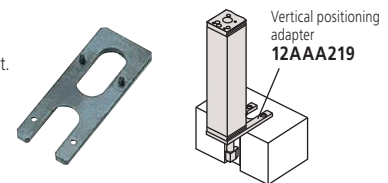

### Magnetic stand adapter

12AAA221

(Mounting spigot diameter is 8 mm)

12AAA220

(Mounting spigot diameter is 9.5 mm)

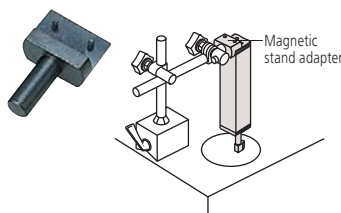

### Height gage adapter

12AAA222 (9 x 9mm)

12AAA233 (1/4 x 1/2")

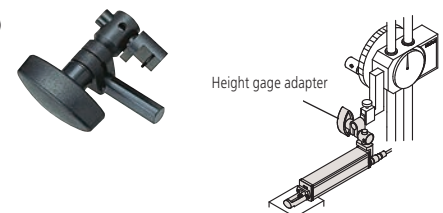

# Optional accessories for SJ-210/310 Series

## Setting attachments

Note: Not available for the transverse tracing drive unit

Enhances measurement efficiency by facilitating the measurement setup of multiple workpieces of the same type and of the hard-to-access sections of a workpiece.

### Setting attachment: V type for measuring in the cylinder axis direction

The V-width is adjustable to the cylinder diameter facilitating axial measurement of a wide range of cylinder diameters.

- Adjustable range:  $\phi 5$  -  $\phi 150$  mm

178-033

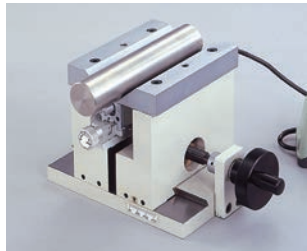

### Setting attachment: Slider type

This attachment is ideal for measuring a flat area of a workpiece that has an indentation or step that makes it difficult to attach the drive unit.

178-034

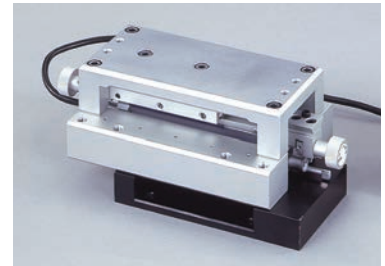

### Setting attachment: Inside diameter type

Greatly facilitates measurement of internal wall surfaces of, for example, a cylinder block.

- Applicable diameter:  $\phi 75$  -  $\phi 95$  mm
- Accessible depth: 30 - 135 mm

178-035



### • Custom-made for special order

Any specified attachment other than above listed can be custom-made for special order.  
Please consult your local Mitutoyo sales office.  
Example: measurements for crankshaft, cylinder-block bores



### Calculation results input unit INPUT TOOL

This unit allows you to load Surftest SJ-210/310 Series calculation results (SPC output) into commercial spreadsheet software on a PC via a USB connector. You can essentially use a one-touch operation to enter the calculation results (values) into the cells in the spreadsheet software.



USB Input Tool-Direct  
**USB-ITN-D**  
**06AFM380D**

USB Input Tool  
USB keyboard signal conversion type\*  
**IT-016U**  
**264-016-10**

\* Requires the optional connection cable.  
1 m: **936937**  
2 m: **965014**

### Digimatic mini processor DP-1VA LOGGER

By connecting this printer to the Surftest SJ-210/310 Series' digimatic output, you can print\* calculation results, perform a variety of statistical analysis, draw a histogram or D chart, and also perform complicated operations for X-R control charts.

\* The symbol 'µm' is not printable, but measurement results can still be printed out without setting the measurement unit.



**264-505A**

- SJ-210/310 Series → DP-1VA LOGGER Connecting cable  
1 m: **936937**  
2 m: **965014**

### Roughness specimen W



Display: Ra = Approx. 3 µm,  
Approx. 0.4 µm

**178-604**

Note: Ra = Approx. 0.4 µm can only be used for stylus tip checking.

### Measurement Data Wireless Communication System U-WAVE

This unit allows you to remotely load Surftest SJ-210/310 Series calculation results (SPC output) into commercial spreadsheet software on a PC.

You can essentially use a one-touch operation to enter the calculation results (values) into the cells in the spreadsheet software.



**U-WAVE-R**  
(Connects to the PC)  
**02AZD810D**



**U-WAVE-T\***  
(Connects to the SJ-210/310 Series)  
**02AZD880G**

\* Requires the optional connection cable.  
**02AZD790D**



Example of the connection with SJ-210

### Foot switch

A foot switch is used to trigger measurement. This tool is very useful in cases where you need to measure the same workpiece multiple times using jigs and other fixtures.



**12AAJ088**

### Memory card (2GB / 8GB)



**12AAW452 / 64PMI244**

Note 1: micro SD card (with a conversion adapter to SD card)

Note 2: Not all memory cards can be recognized. Please use the optional SD memory card.

# Optional accessories for SJ-210/310 Series

## Simplified communication program for SURFTTEST SJ-210/310 Series

The SurfTest SJ-210/310 Series has a USB interface, enabling setting up measurement conditions and starting the measurement via PC. We also provide a program that allows you to create inspection record tables using a Microsoft Excel\* macro.

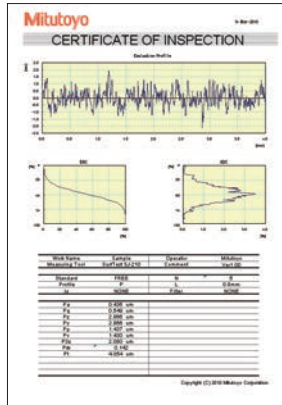
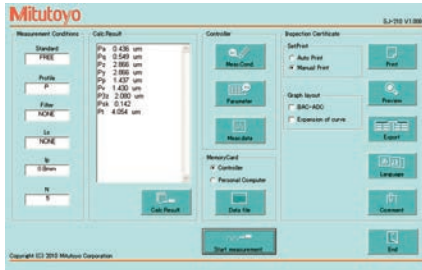

Required environment\*:

- OS: Windows 7  
Windows 8  
Windows 10
- Spreadsheet software:  
Microsoft Excel 2010  
Microsoft Excel 2013  
Microsoft Excel 2016

\* Windows OS and Microsoft Excel are products of Microsoft Corporation.

The optional USB cable is also required.

- USB cable for SJ-210 Series (2 m)  
**12AAL068**
- USB cable for SJ-310 Series  
**12AAD510**

Note: USB Communication cable (commercial item: Equivalent to A and mini-B type for device-host A)

This program can be downloaded free of charge from the Mitutoyo website.  
<https://www2.mitutoyo.co.jp/eng/contact/products/sj/index.html>

## Contour/Roughness analysis software FORMTRACEPAK-AP

More advanced analysis can be performed by loading SJ-210/310 Series measurement data to software program FORMTRACEPAK-AP via a memory card (option) for processing back at base.

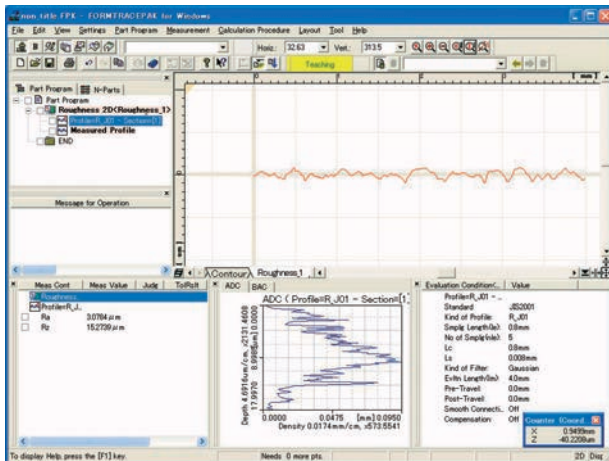

Refer to the FORMTRACEPAK Bulletin No. 2010(2) for more details.



# Optional Accessories

## For SJ-210 Series

### • Printer for SJ-210

Assessed profiles, calculation results and curves can be printed out by connecting the **SJ-210**-dedicated printer, which is palm sized (WxDxH: 93x125x70 mm) and can run on an internal battery.

- Power supply can be selected. (AC adapter or battery pack)
- Printable items: Measurement conditions, calculation results, assessed profile, bearing area curve (BAC), amplitude distribution curve (ADC), and environment settings.



178-421A

### • Optional accessories and consumables for SJ-210

- Protective sheet for the color LCD (5-sheet set) **12AAL066**
- Connecting cable (for SJ-210 Series) **12AAL067**

### Unit configuration:

- 1) Printer main unit 1 unit
- 2) Printer connecting cable (For the connection to the **SJ-210**)
- 3) Printing paper 6 rolls
- 4) Battery pack 1 piece
- 5) Exclusive use AC adaptor (with AC power cord) 1 piece

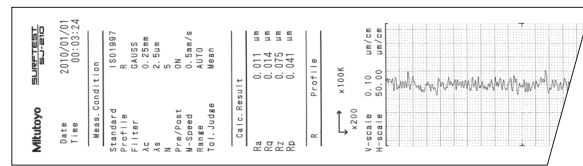

Example of the output by the printer

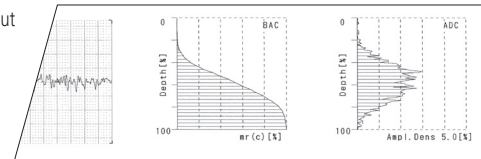

### Printer supplies:

- Printing paper standard type (5 rolls) **270732**
- Durable printer paper (5 rolls) **12AAA876**

## For SJ-310 Series

### • Optional accessories and consumables for SJ-310

- Printer paper standard type (5 rolls) **270732**
- Durable printer paper (5 rolls) **12AAA876**
- Touch-screen protector sheet (10 sheets) **12AAN040**
- Connecting cable (for SJ-310 Series) **12AAA882**



**Whatever your challenges are, Mitutoyo supports you from start to finish.**

Mitutoyo is not only a manufacturer of top quality measuring products but one that also offers qualified support for the lifetime of the equipment, backed by comprehensive services that ensure your staff can make the very best use of the investment.

Apart from the basics of calibration and repair, Mitutoyo offers product and metrology training, as well as IT support for the sophisticated software used in modern measuring technology. We can also design, build, test and deliver measuring solutions and even, if deemed cost-effective, take your critical measurement challenges in-house on a sub-contract basis.



**Find additional product literature and our product catalog**

[www.mitutoyo.com](http://www.mitutoyo.com)

**Note:** All information regarding our products, and in particular the illustrations, drawings, dimensional and performance data contained in this printed matter as well as other technical data are to be regarded as approximate average values. We therefore reserve the right to make changes to the corresponding designs. The stated standards, similar technical regulations, descriptions and illustrations of the products were valid at the time of printing. In addition, the latest applicable version of our General Trading Conditions will apply. Only quotations submitted by ourselves may be regarded as definitive. Specifications are subject to change without notice.

Mitutoyo products are subject to US Export Administration Regulations (EAR). Re-export or relocation of our products may require prior approval by an appropriate governing authority.

**Trademarks and Registrations**

Designations used by companies to distinguish their products are often claimed as trademarks. In all instances where Mitutoyo America Corporation is aware of a claim, the product names appear in initial capital or all capital letters. The appropriate companies should be contacted for more complete trademark and registration information.



**Mitutoyo America Corporation**

[www.mitutoyo.com](http://www.mitutoyo.com)  
 One Number to Serve You Better  
 1-888-MITUTOYO (1-888-648-8869)

**M<sup>3</sup> Solution Centers:**

- Aurora, Illinois (Headquarters)
- Boston, Massachusetts
- Charlotte, North Carolina
- Cincinnati, Ohio
- Detroit, Michigan
- Los Angeles, California
- Seattle, Washington
- Houston, Texas