

Specifications

- **264-002**
- Model: **MUX-10F**
- Data input port: 4 channels for Digimatic gages
- Output: (RS-232C)
Data output Via RS-232C interface:
Data transmission method: Half-duplex
Data transmission code: ASCII/JIS
Data length: 8 bits
Parity check: None
Stop bit: 1
Data transmission speed: 300/600/1200/2400/9600/
19200 bps
- Connector specification:

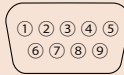

Pin No.	Signal	Function	in/out
1	CD		out
2	RD	Received data	out
3	TD	Communication data	in
4			
5	GND	Ground	
6	DR		out
7			
8	CS		out
9			

Note: For connection with a PC, use a commercially available RS-232C straight cable.

- Data format
- 1) When data output

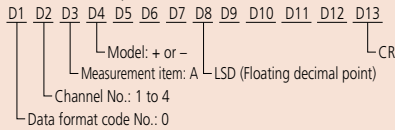

- 2) Example of format

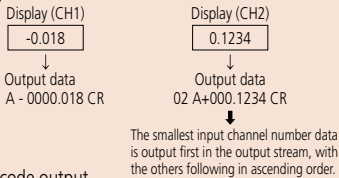

- 3) Error code output

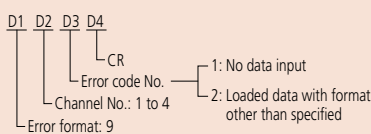

- Power supply: AC adapter (9 V, 500 mA)
- External dimensions: 91.4 (W) x92.5 (D) x50.4 (H) mm
- Note 1: Communication software is not included.
- Note 2: Separately purchase the cables. Refer to pages A-21 and A-22 for cable types.

Digimatic/RS-232C Interface Unit Multiplexer MUX-10F

- Multiplexer **MUX-10F** is a measurement data transfer device that converts incoming Digimatic output measurement data to RS-232C and outputs it to other devices such as a PC and sequencer.
- Up to four measuring instruments with Digimatic output can be connected.



264-002
MUX-10F

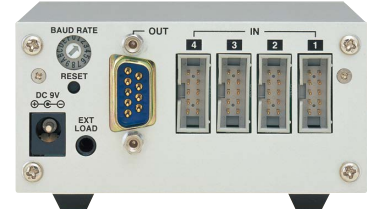

Typical Application

Data input using the data button on the Digimatic gage

- If the Digimatic gage has a data button, data is sent to the **MUX-10F** from the gage, converted to RS-232C and sent out.

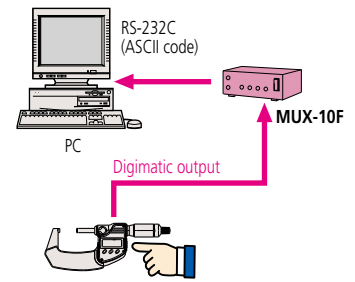

Press the data button on the measuring gage.

Data input using the load switch

- If the Digimatic gage does not have a data button, or when simultaneous measurements are performed, the **MUX-10F** load switch is used to poll data from the measuring gage (s)selected by the tool selection switch (es), converted to RS-232C, and sent out.
- If multiple measuring gages are selected by the tool selection switch, data is input in the order of channels 1 through 4.
- Optional foot switch (**937179T**) is available for quick data entry.

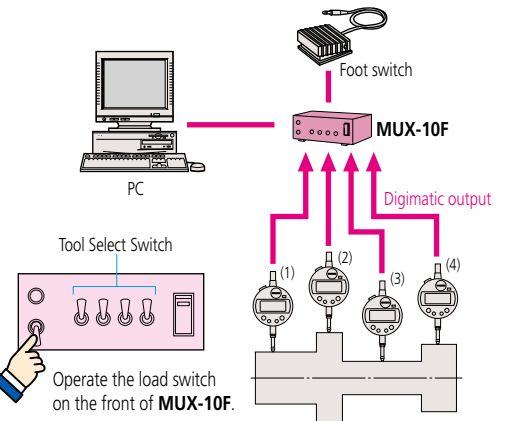

Data input using the external commands

- Data from a specified measuring gage connected to **MUX-10F** can be polled (ch 1 to 4) by inputting a command from the PC.

Commands (ASCII)	Transfer channels
1 (ASCII code31) CR	1
2 (ASCII code32) CR	2
3 (ASCII code33) CR	3
4 (ASCII code34) CR	4
*A (ASCII code41) CR	1, 2, 3, 4
*B (ASCII code42) CR	1, 2, 4
*C (ASCII code43) CR	1, 3, 4
*D (ASCII code44) CR	2, 3, 4
E (ASCII code45) CR	1, 2, 3
F (ASCII code46) CR	1, 2
G (ASCII code47) CR	1, 3
H (ASCII code48) CR	1, 4
I (ASCII code49) CR	2, 3
J (ASCII code50) CR	2, 4
K (ASCII code51) CR	3, 4

* Command will operate the same as previous **MUX-10** when 4-channel mode is turned off.

