

# Mitutoyo

Catalog No. US-1005



## Measuring Instruments Catalog



## Notes on Use

### **Export Compliance**

All products in this catalog are subject to the Foreign Exchange and Foreign Trade Control laws of Japan, US Export Administration Regulations (EAR) or the Canadian Export and Import Permits Act. Re-export or relocation of any of these products may require prior approval by an appropriate governing authority. If a purchased product is exported or re-exported, even if it is not considered a regulated item by a governing authority, Mitutoyo would like to be made aware, as the customer service available for that product may be affected. If you have any questions, please consult your local Mitutoyo sales office.

### **Safety Caution**

Carefully read the specifications and functions in this catalog before selecting products. Safety may be compromised if you use products for purposes other than those stated here.

Feel free to contact your nearest Mitutoyo sales center if you wish to use a product for other purposes or in a special environment.

### **Appearance and Specifications**

Appearance and specifications are subject to change without prior notice for product improvement. The product names in this catalog are registered trademarks or trademarks of Mitutoyo or their respective companies.

# Mitutoyo Precision Measuring Machines Trusted Throughout the World

## Table of Contents

	Pages			Pages	
<b>A</b> Measurement Data Management	A-1 – 20		<b>G</b> Linear Gages	G-1 – 29	
<b>B</b> Micrometers	B-1 – 54		Mu-checker	G-30 – 33	
Micrometer Heads	B-55 – 76		Laser Scan Micrometers	G-34 – 50	
<b>C</b> Holtests	C-1 – 10		<b>H</b> Digimatic Scale Units	H-1 – 8	
Inside Micrometers	C-11 – 19		Linear Scales	H-9 – 35	
Bore Gages	C-20 – 30		<b>I</b> Profile Projectors	I-1 – 15	
<b>D</b> Calipers	D-1 – 35		Microscopes	I-16 – 41	
Height Gages	D-36 – 49		<b>J</b> Surftest	J-1 – 13	
Depth Gages	D-50 – 58		Formtracer	J-14 – 27	
<b>E</b> Gage Blocks	E-1 – 24		Contracer	J-28 – 38	
Height Master	E-25 – 31		Roundtest	J-39 – 54	
Reference Gages	E-32 – 43		<b>K</b> Hardness Testing Machines	K-1 – 8	
Granite Surface Plates	E-44 – 45		Rockwell Hardness Testing Machines	K-9 – 12	
<b>F</b> Digimatic Indicators	F-1 – 14		Portable Hardness Testing Machines	K-13 – 17	
Dial Indicators	F-15 – 38		<b>L</b> Coordinate Measuring Machines	L-1 – 15	
Dial Test Indicators	F-39 – 49		Software and Probes	L-16 – 27	
Thickness Gages	F-50 – 52		Accessories	L-28 – 29	
Other Gages	F-53 – 59		<b>M</b> Vision Measuring Systems	M-1 – 19	
Stands	F-60 – 65		<b>N</b> INDEX	N-1 – 14	

# Mitutoyo North America Operations



**Mitutoyo America Corporation**  
**Corporate Headquarters**  
Aurora, Illinois USA

**Aurora**  
965 Corporate Blvd  
Aurora, IL 60502  
**M<sup>3</sup> Solution Center**  
**Calibration Lab**  
**Mitutoyo Institute of Metrology**  
**CT Lab**  
**Repair and Field Service**



## Mitutoyo America Corporation

Established in 1963, Mitutoyo America Corporation has locations all across the United States and Canada, including corporate offices, sales offices, M<sup>3</sup> Solution Centers, calibration and repair laboratories, and research and development facilities. Mitutoyo America offers a full product line of precision measuring tools, instruments and equipment. Mitutoyo provides a comprehensive metrology organization, with dependable product and technical support, state-of-the-art calibration and repair services, unmatched education and training programs and cutting-edge research and development.

As the leading metrology company in the world, Mitutoyo is committed to future product development that applies breakthrough technologies to its full range of dimensional measurement tools, instruments and systems. With the belief that providing high-quality metrology goods and services to its customers will in turn, allow its customers to provide high-quality product to theirs, Mitutoyo continues to develop the most advanced and sophisticated metrology equipment available. **"Precision is our profession"** is not just the company motto, but also the principle by which every Mitutoyo employee stands when serving our customers.

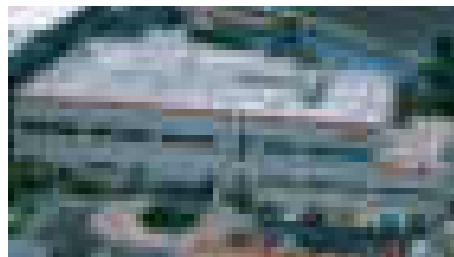

**Mitutoyo Mexico**  
**Corporate Headquarters**  
Estado de Mexico, Mexico  
(0155) 5312-5612



One number to serve you better:  
Toll Free: 1-888-MITUTOYO (1-888-648-8869) (U.S. Inquiries Only)

## M<sup>3</sup> Solution Centers

Mitutoyo Tools and instruments can be seen and demonstrated conveniently at any one of nine Mitutoyo M<sup>3</sup> Centers nationwide. These centers are fully equipped featuring operational models of the latest Mitutoyo tools and instruments. By appointment or walk-in basis, product demonstrations at M<sup>3</sup> Solution Centers are carried out by our experienced, highly trained staff. Contact your Mitutoyo distributor or the Mitutoyo regional office near you for more information.



\*M<sup>3</sup> = Mitutoyo, Measurement, Metrology

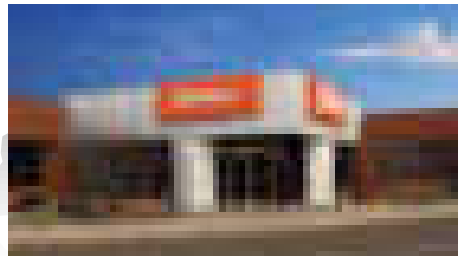

**Mitutoyo Canada Inc.**  
**Corporate Headquarters**  
Mississauga, Ontario Canada  
(905) 821-1261

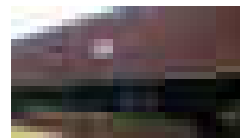

**Birmingham**  
2100 Riverchase Ctr, Suite 106  
Birmingham, AL 35244  
**M<sup>3</sup> Solution Center**

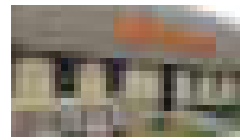

**Boston**  
753 Forest Street, Suite 110  
Marlborough, MA 01752  
**M<sup>3</sup> Solution Center**



**Charlotte**  
11515 Vanstory Drive, Suite 140  
Huntersville, NC 28078  
**M<sup>3</sup> Solution Center**



**Cincinnati**  
6220 Hi-Tek Court  
Mason, OH 45040  
**M<sup>3</sup> Solution Center**



**Detroit**  
46850 Magellan Dr., Suite 100  
Novi, Michigan 48377  
**M<sup>3</sup> Solution Center**



**Houston**  
4560 Kendrick Plaza Dr., Suite 120  
Houston, TX 77032  
**M<sup>3</sup> Solution Center**



**Los Angeles**  
16925 East Gale Ave.  
City of Industry, CA 91745  
**M<sup>3</sup> Solution Center**  
**CT Lab**  
**Repair and Field Service**



**Seattle**  
1000 SW 34th Street, Suite G  
Renton, WA 98057  
**M<sup>3</sup> Solution Center**  
**CT Lab**



**Toronto**  
2121 Meadowvale Blvd.  
Mississauga, Ontario Canada  
L5N 5N1  
**M<sup>3</sup> Solution Center**  
**Calibration Laboratory**  
**Repair and Field Service**



**Montréal**  
7075 Place, Robert-Joncas, Suite 129  
Montreal, Quebec Canada  
H4M 2Z2  
**M<sup>3</sup> Solution Center**  
**Repair and Field Service**

# Company Profile



## **Product Demonstration / Application Support (M<sup>3</sup> Solutions Centers)**

With several locations across North America, Mitutoyo's M<sup>3</sup> Solutions Centers provide hands-on access to the full range of Mitutoyo precision tools and instruments, including the latest technologies Mitutoyo has to offer. Available to walk-ins or by appointment, highly trained and industry-experienced applications engineers will provide product demonstrations, answer questions and assist in the development of application-specific solutions. Contact your Mitutoyo distributor or the M<sup>3</sup> Solutions Center in your area for additional information.

## **Sales Support / Customer Service**

To ensure fast, dependable responses to all product-related questions and needs, Mitutoyo America Corporation's Sales Support group is available to assist with information on all Mitutoyo precision tools and instruments. Friendly, knowledgeable customer service representatives can provide product specifications, availability, and pricing, as well as recommend a local authorized Mitutoyo distributor.

## **Technical Support Services**

Fast technical support for all Mitutoyo precision tools, instruments and software applications is available to distributors and customers through Mitutoyo's technical support services and is only a phone call away. Highly skilled engineers and technicians with knowledge of all Mitutoyo products can provide product information, answer technical questions, and offer application guidance. Contract programming and inspection services utilizing our most advanced technologies are also available.

## **Software Application Training**

To maximize the value of Mitutoyo precision instrument purchases, Mitutoyo America Corporation provides customized training for all CMM, Vision, Form, and data management (MeasurLink) software applications it provides. Highly trained software instructors provide hands-on, one-on-one or group training with content appropriate for all customer needs. Training classes can be arranged at locations throughout North America.

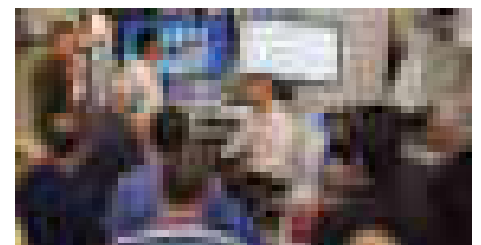

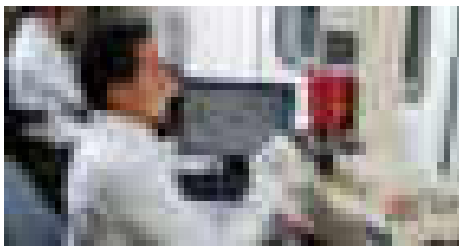

### Calibration Services



Mitutoyo America Corporation's calibration laboratory utilizes state-of-the-art technology to calibrate virtually any metrology tool. A2LA accredited (Certificate 0750.01) to ISO/IEC 17025 for testing and calibration labs, this facility employs professional calibration technicians to provide NIST-traceable accuracy certification, as well as calibration services for Mitutoyo and other manufacturer's gages and gage blocks. Canadian calibration laboratory is CLAS accredited to ISO/IEC 17025.

### Field Service

Committed to ensuring value and longevity in its products, Mitutoyo America Corporation provides field service for all of its major measuring instrument products. A fully staffed field service department arranges the installation, repair, and A2LA-accredited calibration (Certificate 0750.01) of Mitutoyo metrology instruments. Capable of certifying calibration on any service visit, Mitutoyo's accredited field service technicians get equipment back into production quickly. Service agreements are available at the time of equipment purchase. Canadian field service laboratory is CLAS accredited to ISO/IEC 17025.

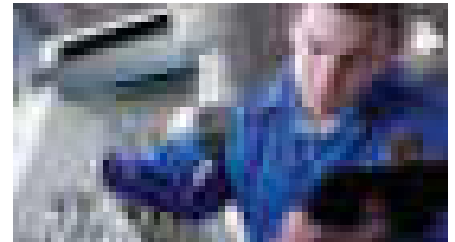

### Repair Services

Mitutoyo America Corporation's in-house repair facilities are capable of repairing the full range of Mitutoyo precision tools. Skilled technicians provide quality repairs backed by a full 90-day warranty on parts and labor. Repairs are done in either the Aurora, IL, facility or the City of Industry, CA, facility. Repair service is also available in Canada.

### Parts Center

Mitutoyo America Corporation's parts center stocks more than 10,000 individual parts for Mitutoyo products. Same day and 24-hour shipping is available for most part requests. For CMM parts, a specialized group is available to provide additional CMM support services. A Mitutoyo product parts catalog is available on CD-ROM through the Parts Center or through a local Mitutoyo distributor.

# Company Profile



## Mitutoyo Institute of Metrology

The Mitutoyo Institute of Metrology provides educational courses and on-demand resources across a wide variety of measurement related topics including basic inspection techniques, principles of dimensional metrology, calibration methods and GD&T. Through the Mitutoyo worldwide operations, we are the premier educational provider within the quality field. Our seminars are led by experienced professionals at locations across the U.S. For seminars outside the U.S., please visit the Mitutoyo Worldwide site. All courses are approved for Continuing Education Units (CEU) and include a Certificate of Attendance.

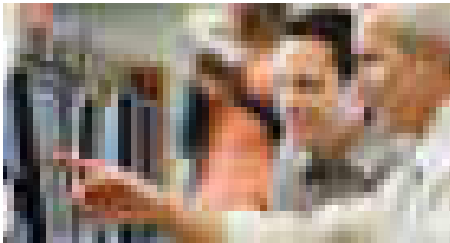
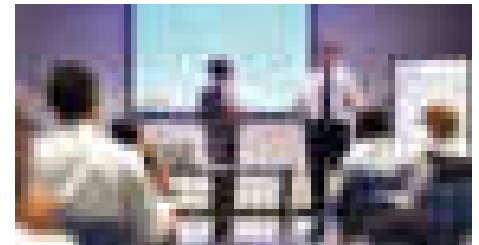

## CT Lab / MEI (R&D and Software Development)

Mitutoyo America's CT Labs and Micro Encoder Inc. are part of an international network of Mitutoyo research and development facilities charged with developing breakthrough technologies for the company's range of dimensional measurement tools, instruments and systems and for the advancement of the field of metrology. Highly skilled developers and engineers utilize cutting-edge development tools to produce the most advanced and sophisticated metrology software and equipment available. Mitutoyo America Corporation is a Microsoft® Gold Certified Partner, providing the entire organization access to a host of Microsoft® development tools and support, and ensuring that Mitutoyo software applications work reliably in Microsoft® OS and network environments.

## Mitutoyo Custom Solutions

Standard products alone cannot always solve our customers' measuring challenges. That is why we established an engineering group to integrate our equipment into application-engineered custom solutions. Called Sales Solutions, this group can create a solution as simple as fixturing. Other times, the answer may require integration of the latest metrology equipment, process control software and robotics to create an automated metrology cell. Whatever the level of complexity, for application and integration of measurement technologies simple or complex – proven or newly emerging – you can count on Sales Solutions to develop a plan to improve your process capability, productivity and bottom line.

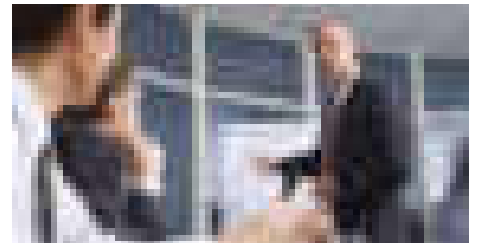



# Global Network

Following the establishment of MTI Corporation (U.S.) in 1963, Mitutoyo has been expanding its market throughout the world. Currently, the company has R&D, manufacturing, sales, and engineering service bases in 30 countries, as well as network of distributors in some 80 countries. Mitutoyo maintains its rock-solid status as a leading global manufacturer providing services tailored to each regional society.



- Global Headquarters
- Sales
- Service Center
- Calibration Center
- M<sup>3</sup> Solution Center
- Mitutoyo Institute of Metrology
- Research and Development Facility
- Manufacturing Facility

**Headquarters**  
TEL (044) 813-8201 FAX (044) 813-8210

**Sales**  
**Sendai Sales Office**  
TEL (022) 231-6881 FAX (022) 231-6884  
Kooriyama Resident Office TEL (024) 931-4331

**Utsunomiya Sales Office**  
TEL (028) 660-6240 FAX (028) 660-6248  
Tsukuba Resident Office TEL (029) 839-9139

**Isesaki Sales Office**  
TEL (0270) 21-5471 FAX (0270) 21-5613  
Niigata Resident Office TEL (025) 281-4360  
Saitama Resident Office TEL (048) 667-1431

**Kawasaki Sales Office**  
TEL (044) 813-1611 FAX (044) 813-1610  
Tokyo Resident Office TEL (03) 3452-0481

**Atsugi Sales Office**  
TEL (046) 226-1020 FAX (046) 229-5450  
Fuji Resident Office TEL (0545) 55-1677

**Suwa Sales Office**  
TEL (0266) 53-6414 FAX (0266) 58-1830  
Ueda Resident Office TEL (0268) 26-4531

**Hamamatsu Sales Office**  
TEL (053) 464-1451 FAX (053) 464-1683

**Anjo Sales Office**  
TEL (0566) 98-7070 FAX (0566) 98-6761

**Nagoya Sales Office**  
TEL (052) 741-0382 FAX (052) 733-0921

**Kanazawa Sales Office**  
TEL (076) 222-1160 FAX (076) 222-1161

**Osaka Sales Office**  
TEL (06) 6613-8801 FAX (06) 6613-8817  
Kobe Resident Office TEL (078) 924-4560

**Keiji Sales Office**  
TEL (077) 569-4171 FAX (077) 569-4172

**Okayama Sales Office**  
TEL (086) 242-5625 FAX (086) 242-5653

**Hiroshima Sales Office**  
TEL (082) 427-1161 FAX (082) 427-1163

**Fukuoka Sales Office**  
TEL (092) 411-2911 FAX (092) 473-1470

**Service Centers**  
**Techno-Service Business Division**  
TEL (044) 813-8213 FAX (044) 822-4136

**Utsunomiya Service Center**  
TEL (028) 660-6280 FAX (028) 660-6257

**Yokohama Service Center**  
TEL (045) 938-5718 FAX (045) 938-5721

**Suwa Service Center**  
TEL (0266) 53-5495 FAX (0266) 58-1830

**Nagoya Service Center**  
TEL (052) 731-7100 FAX (052) 731-6110

**Anjo Service Center**  
TEL (0566) 96-0745 FAX (0566) 96-0747

**Osaka Service Center**  
TEL (06) 6613-8813 FAX (06) 6613-8818

**Hiroshima Service Center**  
TEL (082) 427-1164 FAX (082) 427-1163

**Fukuoka Service Center**  
TEL (092) 411-2909 FAX (092) 482-7894

**Seismic monitoring system  
Service Section  
Testing machine Service Section**  
TEL (045) 938-5718 FAX (045) 938-5721

**Overseas Service Support Section**  
TEL (044) 813-8247 FAX (044) 822-4136

**Calibration Centers**  
**Utsunomiya Measurement  
Standards Calibration Center**  
TEL (028) 656-1432 FAX (028) 656-8443

**Kawasaki Calibration Center**  
TEL (044) 813-8214 FAX (044) 813-8223

**Hiroshima Calibration Center**  
TEL (0823) 70-3820 FAX (0823) 70-3833

**M<sup>3</sup> Solution Centers**  
**UTSUNOMIYA**  
TEL (028) 660-6240 FAX (028) 660-6248

**TOKYO**  
TEL (044) 813-1611 FAX (044) 813-1610

**SUWA**  
TEL (0266) 53-6414 FAX (0266) 58-1830

**ANJO**  
TEL (0566) 98-7070 FAX (0566) 98-6761

**OSAKA**  
TEL (06) 6613-8801 FAX (06) 6613-8817

**HIROSHIMA**  
Please contact to M<sup>3</sup> Solution Center  
FUKUOKA.  
Or Please contact to Hiroshima Sales Office.

**FUKUOKA**  
TEL (092) 411-2911 FAX (092) 473-1470

**Mitutoyo Metrology Institute  
Mitutoyo Metrology Institute  
(Tokyo)**  
TEL (044) 822-4124 FAX (044) 822-4000

**Mitutoyo Metrology  
Institute (Osaka)**  
TEL (06) 6613-8810 FAX (06) 6613-8821

## Research and Development Facilities

**Tsukuba Laboratory**  
TEL (029) 839-1022 FAX (029) 839-1023

**Research & Development Division**  
TEL (044) 822-4137 FAX (044) 822-4127

## Manufacturing Facilities

**Kawasaki Plant  
Production Department**  
TEL (044) 822-4132 FAX (044) 844-9835

**Utsunomiya Operations  
Production Department 1**  
TEL (028) 656-1117 FAX (028) 656-2164

**Utsunomiya Operations  
Production Department 2**  
TEL (028) 656-1309 FAX (028) 656-2164

**Utsunomiya Operations  
Kiyohara Production Department**  
TEL (028) 667-4811 FAX (028) 667-4810

**Nakatsugawa Plant  
Production Department**  
TEL (0573) 68-8201 FAX (0573) 68-8210

**Hiroshima Operations  
Kure Production Department**  
TEL (0823) 71-6111 FAX (0823) 73-2193

**Hiroshima Operations  
Shiwa Production Department**  
TEL (082) 433-2077 FAX (082) 433-2695

**Hiroshima Operations  
Gohara Production Department**  
TEL (0823) 77-1721 FAX (0823) 77-1724

**Miyazaki Plant**  
TEL (0985) 86-2591 FAX (0985) 86-0827

**Onomi Plant**  
TEL (0889) 57-2036 FAX (0889) 57-2178





# Meaning of Symbols

**ABSOLUTE™**

ABSOLUTE is a trademark of Mitutoyo Corporation.

## ABSOLUTE Linear Encoder

This is an electronic measuring scale that provides a direct readout of absolute linear position when switched on, without needing to be zeroed or reset. Electrostatic, electromagnetic and a combination of electrostatic and optical methods are used in implementing this capability but the key feature is Mitutoyo's patented technology of building absolute positional information into the scale so it can be read at start up. These linear encoders are widely used in Mitutoyo's measuring instruments as the in-built length standard and their use greatly contributes to the generation of highly reliable measurement data, particularly in harsh environments where contamination by cutting fluids, coolants and dust must not affect performance.

### Advantages:

1. No count error occurs even if you move the slider or spindle extremely rapidly.
2. You do not have to reset the system to zero when turning on the system after turning it off\*1.
3. As this type of encoder can drive with less power than the incremental encoder, the battery life is prolonged to about 3.5 years (continuous operation of 20,000 hours)\*2 under normal use.

\*1: Unless the battery is removed.

\*2: In the case of the ABSOLUTE Digimatic caliper (electrostatic capacitance model).

**IP65**

**IP66**

**IP67**

IP is a trademark of Mitutoyo Corporation.

## IP Codes

These codes indicate the degree of protection provided (by an enclosure) for the electrical function of a product against the ingress of foreign bodies, dust and water as defined in IEC standards (IEC 60529: 2001) and JIS C 0920: 2003. [IEC: International Electrotechnical Commission]

First characteristic numeral	Degrees of protection against solid foreign objects	
	Brief description	Definition
0	Unprotected	—
1	Protected against solid foreign objects of $\text{S}\phi 50\text{mm}$ and greater	A $\text{S}\phi 50\text{mm}$ object probe shall not fully penetrate enclosure*
2	Protected against solid foreign objects of $\text{S}\phi 12.5\text{mm}$ and greater	A $\text{S}\phi 12.5\text{mm}$ object probe shall not fully penetrate enclosure*
3	Protected against solid foreign objects of $\text{S}\phi 2.5\text{mm}$ and greater	A $\text{S}\phi 2.5\text{mm}$ object probe shall not fully penetrate enclosure*
4	Protected against solid foreign objects of $\text{S}\phi 1.0\text{mm}$ and greater	A $\text{S}\phi 1.0\text{mm}$ object probe shall not fully penetrate enclosure*
5	Protected against dust	Ingress of dust is not totally prevented, but dust that does penetrate must not interfere with satisfactory operation of the apparatus or impair safety.
6	Dust-proof	No ingress of dust allowed.

\*: For details of the test conditions used in evaluating each degree of protection, please refer to the original standard.

Second characteristic numeral	Degrees of protection against water	
	Brief description	Definition
0	Unprotected	—
1	Protected against vertical water drops	Vertically falling water drops shall have no harmful effects.
2	Protected against vertical water drops within a tilt angle of 15 degrees	Vertically falling water drops shall have no harmful effects when the enclosure is tilted at any angle up to 15° on either side of the vertical.
3	Protected against spraying water	Water sprayed at an angle up to 60° either side of the vertical shall have no harmful effects.
4	Protected against splashing water	Water splashed against the enclosure from any direction shall have no harmful effects.
5	Protected against water jets	Water projected in jets against the enclosure from any direction shall have no harmful effects.
6	Protected against powerful water jets	Water projected in powerful jets against the enclosure from any direction shall have no harmful effects.
7	Protection against water penetration	Ingress of water in quantities causing harmful effects shall not be possible when the enclosure is temporarily immersed in water under standardized conditions of pressure and time.
8	Protected against the effects of continuous immersion in water	Ingress of water in quantities causing harmful effects shall not be possible when the enclosure is continuously immersed in water under conditions which shall be agreed between manufacturer and user but which are more severe than for IPX7.

## About the TÜV Rheinland certification marks

All products with the marks shown on the left have passed the IP test carried out by the German accreditation organization, TÜV Rheinland.



## Measuring Instruments Shipped with Inspection Certificate

Mitutoyo guarantees product quality as a leading precision measuring instrument manufacturer and ships measuring instruments with an inspection certificate that includes inspection data so that customers can use them with confidence.

\*For the meaning of inspection marks shown at the left, refer to the detailed description of each product.



## MeasurLink ENABLED marks

Products equipped with the measurement data output function can be connected to the measurement data network system MeasurLink. MeasurLink® is a registered trademark of Mitutoyo Corporation in Japan and Mitutoyo America Corporation in the United States.



## Installation of Main Unit Startup System

As a part of the enhancement of our export control system, the large CNC measuring machines (all the CNC Coordinate Measuring Machines, Vision Measuring Systems, and Form Measuring Machines) are now equipped with a Main Unit Startup System (relocation detecting system) before export.

This system is designed to take a machine out of operation upon detecting the mechanical shock that accompanies relocation. If you intend to relocate a measuring machine fitted with this system, please contact us beforehand so that our service engineers can assist you.

On the other hand, the system may be triggered in the event of a natural event such as a powerful earthquake. In this case, our service engineers will deal with the situation at the earliest opportunity.

**Main Unit Startup System**

# Traceability Mitutoyo North America

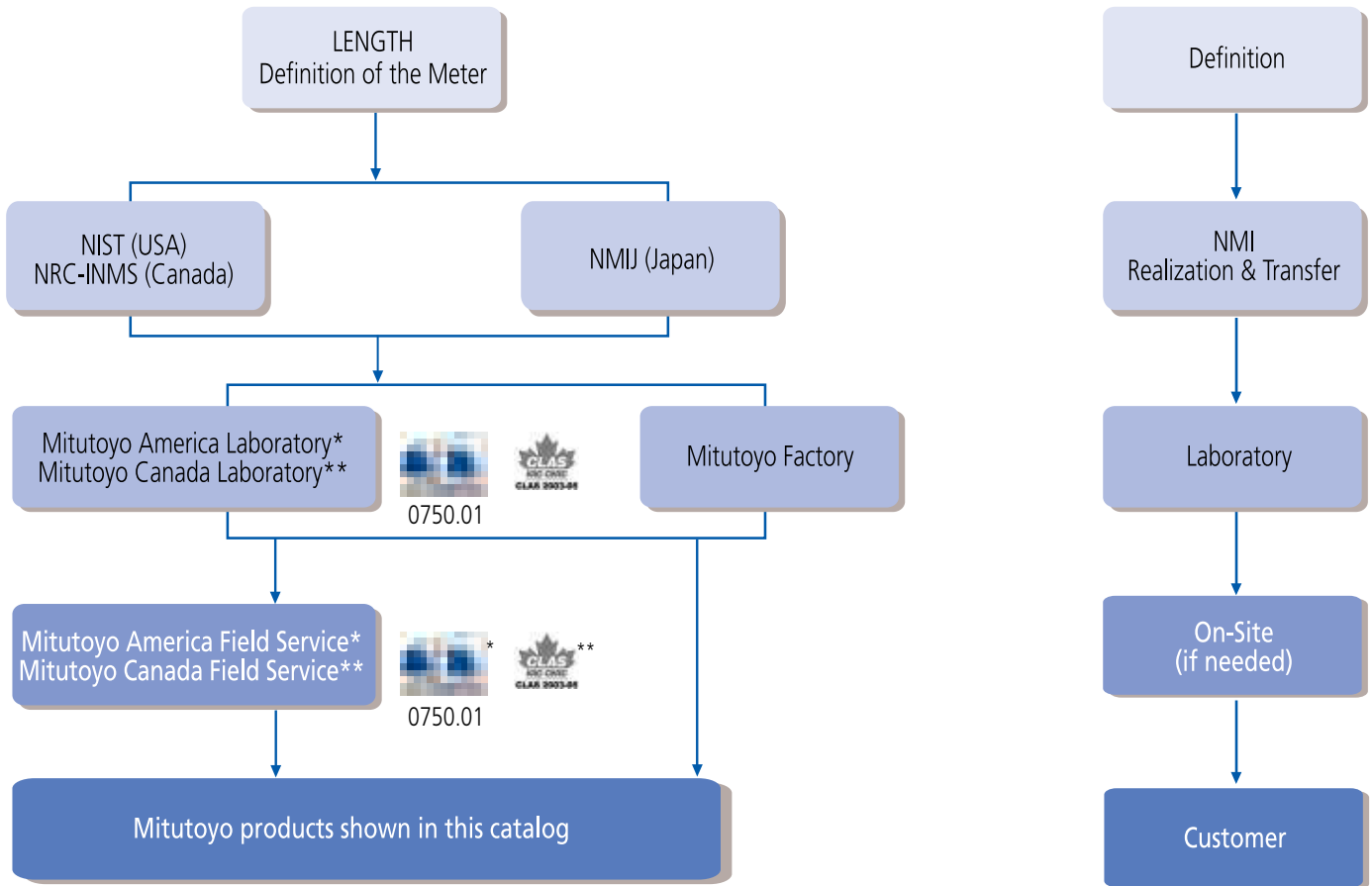

Traceability is an essential requirement for all measurements. At Mitutoyo, we consider providing traceability to our customers to be a critical part of our business. Traceability is often referred to as a “chain of comparisons,” and that chain always starts with a precise definition. For length measurements, the meter is defined by how far light moves in a vacuum in a defined amount of time. The job of reducing that definition into a practical measurement belongs to the world’s National Metrology Institutes (NMI). The NMI in the United States is the National Institute of Standards and Technology (NIST), where they realize and transfer the definition of length to physical measurements of gage blocks, line scales, and other primary standards. From there, traceable measurements at other laboratories and factories are possible. Mitutoyo factories and calibration labs regularly send their standards to NIST; however, traceability can also be established through other recognized NMIs, such as the National Metrology Institute of Japan (NMIJ). The world’s leading NMIs, such as NIST and NMIJ, routinely participate in intercomparisons to ensure global traceability to the same unit of length.

The requirements for demonstrating traceability vary from industry to industry. In the past, some industries required NIST test numbers, but that practice is now obsolete and has been replaced in many industries by the much more demanding requirement of ISO 17025 accreditation. To meet these needs, Mitutoyo America offers our customers A2LA-accredited calibrations either in our labs (Certificate 0750.01), or at your facility (Certificate 0750.01). None of our competitors can match the range and accuracy of accredited calibration services offered by Mitutoyo. Not every quality system requires accreditation, and for the less demanding needs, our standard factory issued certificates can still be used to ensure the required traceability.

Whatever the measurement, whatever the requirements for traceability, Mitutoyo has the most technically advanced metrology products and calibration services to meet your specific needs.

# Offering High-level Calibration Services

## Calibration Laboratories

Mitutoyo has built a network for comprehensive support of calibration of precision measuring products in the global market. To provide calibration services on a global scale, Mitutoyo has calibration laboratories that have received ISO/IEC 17025 certification, an international standard, from accredited organizations in each of the countries in which Mitutoyo operates in Japan and abroad.

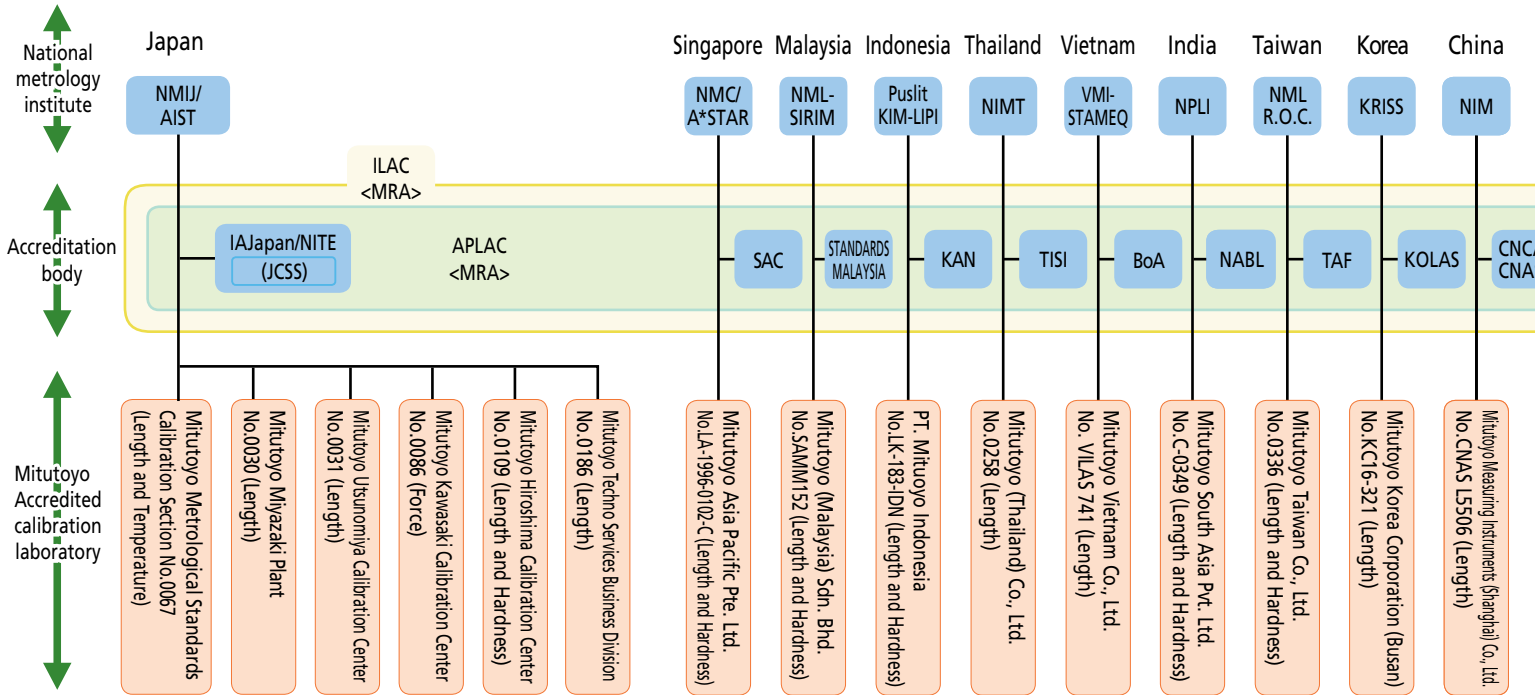

- Japan
  - AIST : National Institute of Advanced Industrial Science and Technology
  - NMIJ : National Metrology Institute of Japan
  - IAJapan : International Accreditation Japan
  - NITE : National Institute of Technology and Evaluation
  - JCSS : Japan Calibration Service System
- Singapore
  - NMC/A\*STAR : National Metrology Centre/ Agency for Science, Technology and Research
  - SAC : Singapore Accreditation Council
- Malaysia
  - NML-SIRIM : National Metrology Laboratory-Standards and Industrial Research Institute of Malaysia
  - STANDARDS : STANDARDS MALAYSIA
  - MALAYSIA
- Indonesia
  - Puslit KIM-LIPI : Research Center for Calibration, Instrumentation and Metrology- Indonesian Institute of Science
  - KAN : Komite Akreditasi Nasional
- Thailand
  - NIMT : National Institute of Metrology (Thailand)
  - TISI : Thai Industrial Standard Institute
- Vietnam
  - VMI-STAMEQ : Vietnam Metrology Institute, Directorate for Standards and Quality
  - BoA : BUREAU OF ACCREDITATION
- India
  - NPLI : National Physical Laboratory of India
  - NABL : National Accreditation Board for Testing and Calibration Laboratories
- Taiwan
  - NML R.O.C. : National Measurement Laboratory R.O.C.
  - TAF : Taiwan Accreditation Foundation
- Korea
  - KRISS : Korea Research Institute of Standards and Science
  - KOLAS : Korea Laboratory Accreditation Scheme
- China
  - NIM : National Institute of Metrology
  - CNCA : Certification and Accreditation Administration of the people's republic of China
  - CNAS : China National Accreditation Service for Conformity Assessment
- U.S.A.
  - NIST : National Institute of Standards and Technology
  - A2LA : American Association for Laboratory Accreditation
- Canada
  - NRC-INMS : National Research Council Canada / Institute for National Measurement Standards
  - CLAS/SCC : Calibration Laboratory Assessment Service / Standards Council of Canada
- Mexico
  - CENAM : Centro Nacional de Metrologia
  - EMA : Entidad Mexicana de Acreditación, a.c.
- Germany
  - PTB : Physikalisch-Technische Bundesanstalt
  - DAkKS : Deutsche Akkreditierungsstelle GmbH
- UK
  - NPL : National Physical Laboratory
  - UKAS : United Kingdom Accreditation Service

Note: The above are domestic and international locations where Mitutoyo provides ISO/IEC 17025 accredited calibration services.  
(As of September, 2018)

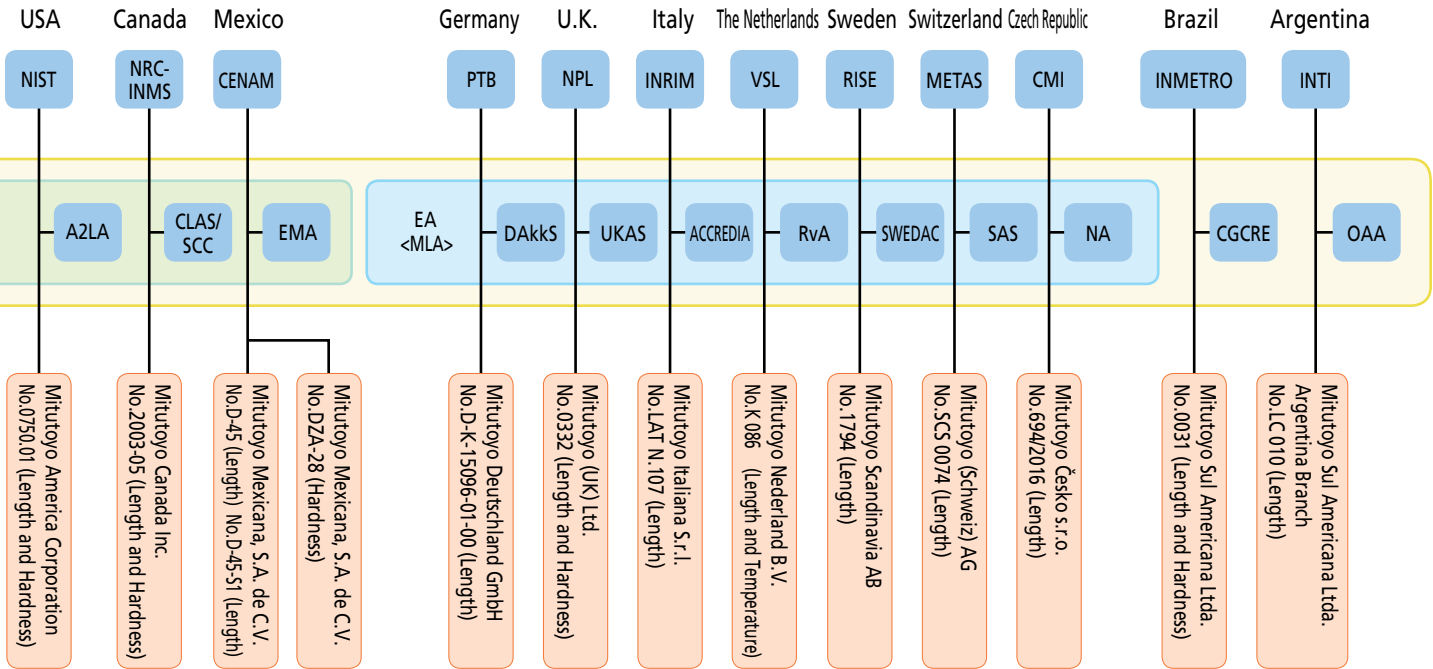

- Italy  
 INRIM : Istituto Nazionale di Ricerca Metrologica  
 ACCREDIA : L'ENTE ITALIANO DI ACCREDITAMENTO

- The Netherlands  
 VSL : Van Swinden Laboratorium  
 RvA : Raad voor Accreditatie

- Sweden  
 RISE : RISE Research Institutes of Sweden AB  
 SWEDAC : Swedish Board for Accreditation and Conformity Assessment

- Switzerland  
 METAS : The Federal Institute of Metrology  
 SAS : Swiss Accreditation Service

- Czech Republic  
 CMI : Český Metrologický Institut  
 NA : Národní Akreditační Organ

- Brazil  
 INMETRO : Instituto Nacional de Metrologia Qualidade e Tecnologia  
 CGCRE : Coordenação Geral de Acreditação do INMETRO

- Argentina  
 INTI : Instituto Nacional de Tecnología Industrial  
 OAA : Organismo Argentino de Acreditación

- ILAC : International Laboratory Accreditation Cooperation
- APLAC : Asia-Pacific Laboratory Accreditation Cooperation
- MLA : Multilateral Agreement
- MRA : Mutual Recognition Arrangement
- EA : European co-operation for Accreditation

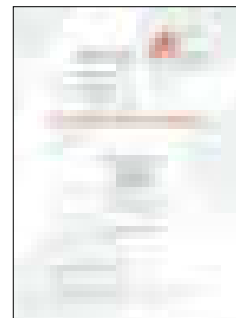
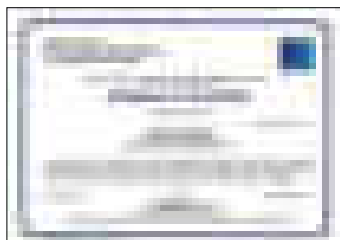

# Offering Reliable Traceability

## Mitutoyo's Traceability System

Mitutoyo's length standards are directly traceable to Japan's national standards. Mitutoyo performs calibration of standards used for calibrating measuring instruments. In this way, the establishment and maintenance of traceability for various measuring instruments used by customers is achieved. Furthermore, Mitutoyo executes the temperature calibrations that are essential for high-accuracy length measurement. In addition, the establishment and maintenance of traceability for test equipment such as hardness and vibration are achieved as well.



Certificate of JCSS accredited laboratory (Mitutoyo Metrological Standards Calibration Section)

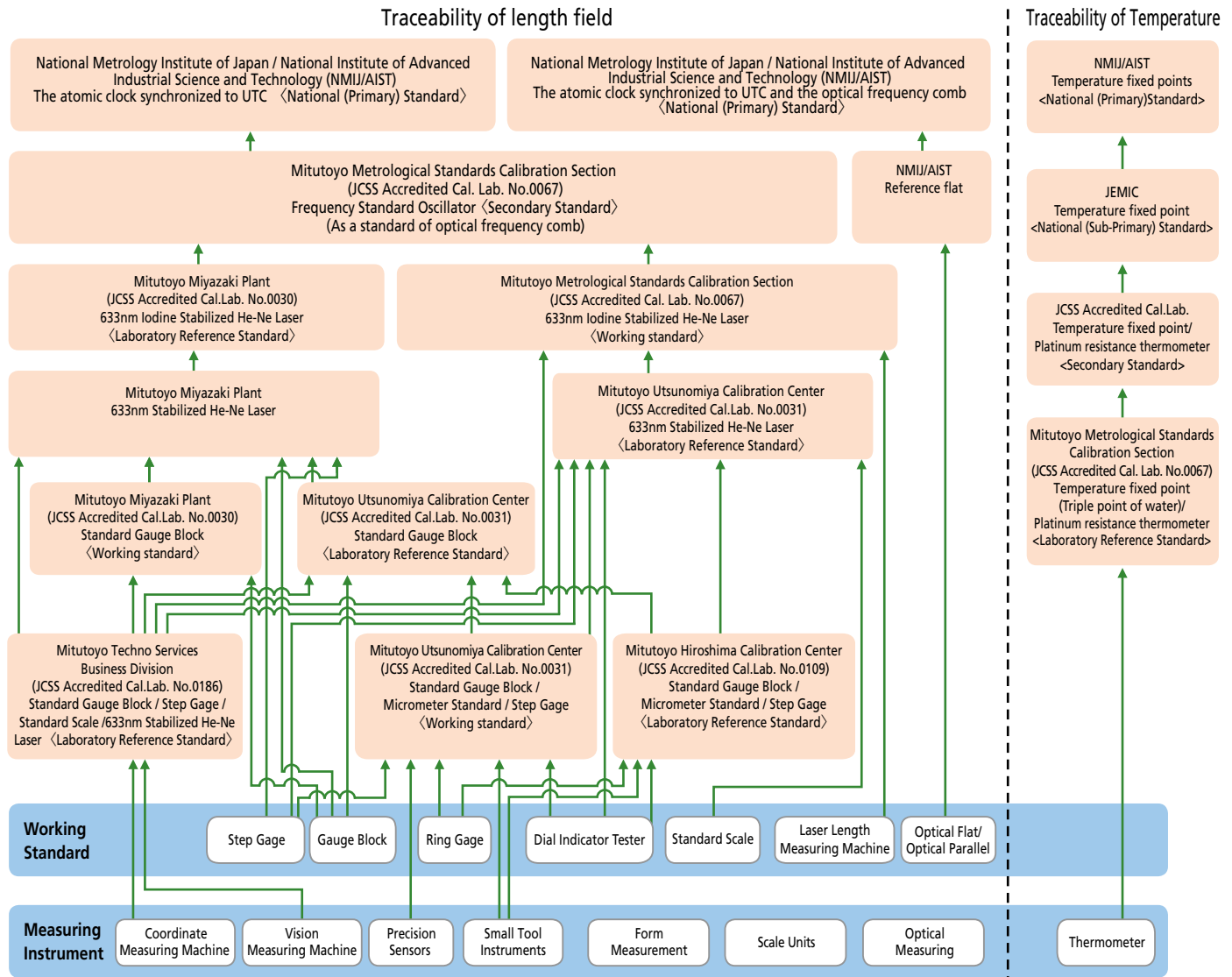

Note: This chart shows a simplified traceability system of Mitutoyo. Detailed traceability charts are published for each product.



## Traceability of Test Equipment

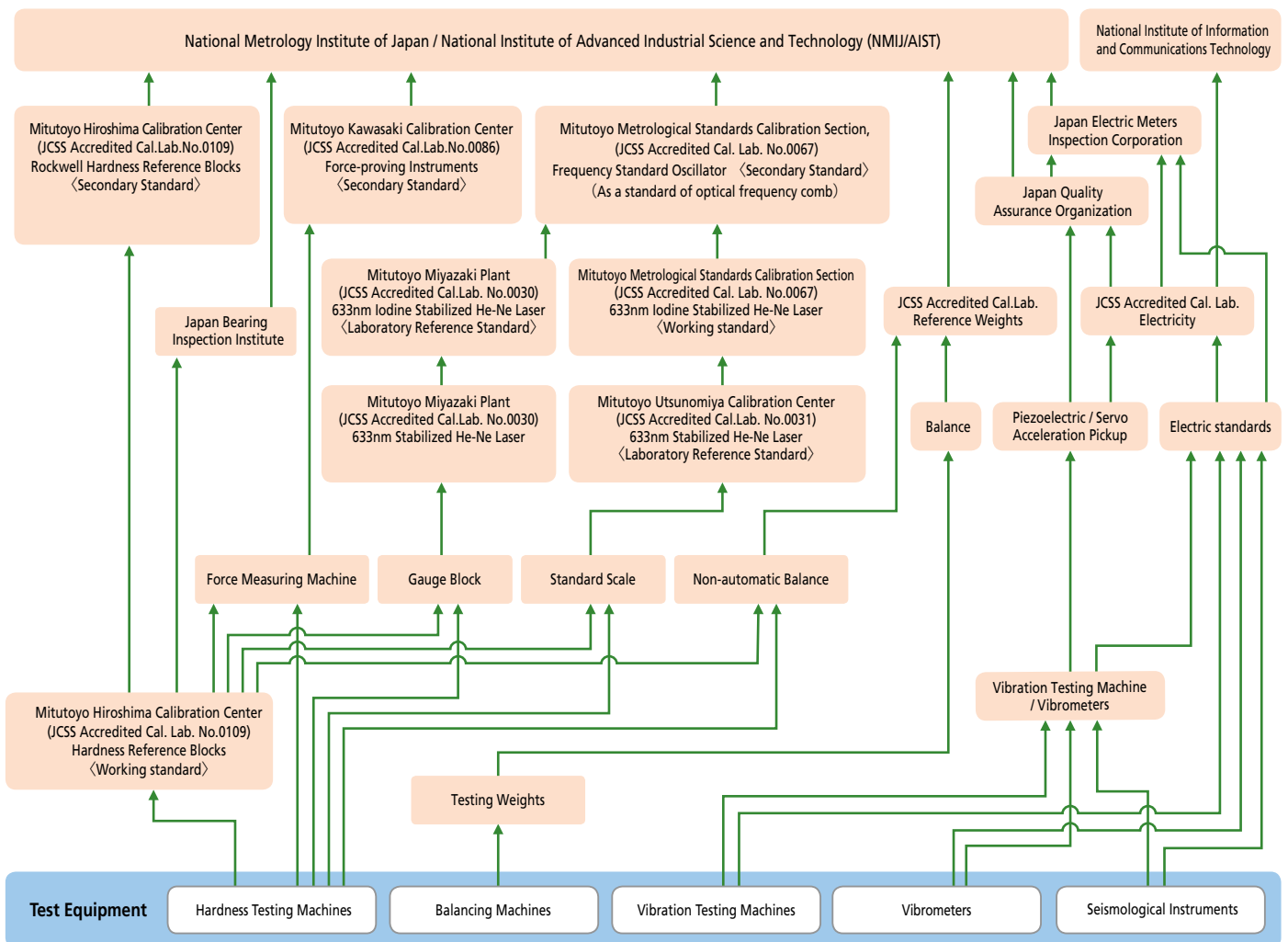

Note: This chart shows a simplified traceability system of Mitutoyo. Detailed traceability charts are published for each product.  
(As of September, 2018)

# Conformance to CE Marking

## Conformance to CE Marking

In order to improve safety, each plant has programs to comply with the Machinery Directive, the EMC Directive, and the Low Voltage Directive. Compliance to CE marking is also met. CE stands for "Conformité Européenne". CE marking indicates that a product complies with the essential requirements of the relevant European health, safety and environmental protection legislation.



Conformity evaluation for CE marking (EMC Directives)

## Major EU Directives relating to Mitutoyo products

Name of EU Directive	Applicable range
Machinery Directive	At least one part of a machine that may cause injury to the human body if it moves due to movement of an actuator such as a motor.
EMC Directive (Electromagnetic Compatibility Directive)	A product that may produce electromagnetic radiation or which is influenced by electromagnetic radiation from outside.
Low Voltage Directive	Equipment (device) that uses AC voltage of 50 to 1000V or DC voltage of 75 to 1500V.
Radio Equipment Directive	All electrical and electronic equipment that intentionally transmits and receives radio waves at frequencies below 3000 GHz.
RoHS Directive	Restriction of the use of certain hazardous substances in electrical and electronic equipment. Restricted substances and maximum concentration values tolerated by weight: <ul style="list-style-type: none"> <li>· Lead (0.1 %)</li> <li>· Cadmium (0.01 %)</li> <li>· Hexavalent chromium (0.1 %)</li> <li>· Polybrominated biphenyls (PBB) (0.1 %)</li> <li>· Polybrominated diphenyl ethers (PBDE) (0.1 %)</li> </ul>

## Response to WEEE Directive

The WEEE Directive\*<sup>1</sup> is a directive that mandates appropriate collection and recycling of electrical and electronic equipment waste.

The purpose of this directive is to increase the reuse and recycling of these products, and seeks eco-friendly product design. To differentiate between equipment waste and household waste, a crossed-out wheeled-bin symbol  is marked on a product. We will promote eco-friendly design for our products.

\*1 WEEE Directive: Directive 2012/96/EC of the European Parliament and of the Council on waste electrical and electronic equipment.

## Response to REACH Regulation

REACH Regulation\*<sup>2</sup> is a regulation governing registration, evaluation, authorization and restriction of chemical substances in Europe, and all products such as substances, mixtures and molded products (including accessories and packaging materials) are regulated. Chemical substances scientifically proven to be substances that are hazardous to human health and the global environment (a substance of very high concern (SVHC)) are prohibited to be sold or information concerning them disclosed is mandated in Europe. We will actively disclose information about our products and provide replacement if we find our products contain any of the listed substances.

\*2 REACH Regulation: Regulation (EC) No1907/2006 of the European Parliament and of the Council concerning the Registration, Evaluation, Authorization and Restriction of Chemicals

## Response to Management Methods for Controlling Pollution by Electronic Information Products (China RoHS)

We set the environmental protection use period regulated by China RoHS per product and label with the marks shown on the right, together with a list of the contained substances.

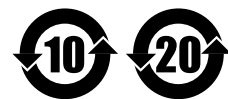

"Environmental Protection Use Period" mark\*<sup>3</sup>

\*3 The environmental protection use period does not indicate the product warranty period.

## Regarding the use of Silver Oxide batteries, please follow these precautions:

### Warning

- Do not heat, disassemble nor dispose of in fire.  
Doing so damages the insulation materials and may cause fire, heat generation, leakage or bursting.
- Do not short circuit.  
If the (+) and (-) terminals are connected together through a very low resistance path, such as a metal casing, a short circuit occurs.  
As a result, fire, heat generation, leakage or bursting may occur.
- Keep batteries out of children's reach.  
A young child may swallow a battery and risk danger to health.

When you design mechanical hardware around a battery, ensure that the battery is securely contained in order to prevent children from removing it.  
When you store batteries, keep the batteries out of children's reach.  
If a battery is swallowed, consult a physician immediately.

- If leaked liquid contacts the eyes, do not rub them but immediately, wash them with clean water and consult a physician as soon as possible.
- If leaked liquid contacts clothing, to protect against irritation, wash them with clean water immediately.

### Caution

- Do not install in reverse polarity. Take care to identify the (+) and (-) terminals correctly.
- Do not solder directly to a battery.
- Do not use new and used batteries together. Do not use different types of batteries together.
- Do not charge.
- Do not use nor leave batteries in direct sunlight nor in high-temperature areas.
- Keep batteries away from direct sunlight, high temperature and humidity.

- Avoid letting batteries contact water.
- Ensure batteries are inserted without coming into contact with metal parts of equipment.
- Read the equipment instruction manual and precautions carefully before using.
- Remove batteries from equipment that will not be used for a prolonged period.
- In case of disposal, insulate (+) and (-) terminals of a battery by applying an insulating material.

# A

## Small Tool Instruments and Data Management



### Measurement Data Management

#### INDEX

##### Data Management (SPC)

MeasurLink	A-2-10
Input Tools	A-11
USB Input Tool Direct: USB-ITN	A-12,13
U-WAVE	A-14,15
U-WAVE Fit	A-16
Multiplexers – MIG-8USB, MIG-4USB	A-17
Gage Selector 3	A-18
EC Counter	A-18
DP-1VA	A-19
SPC Connecting Cables	A-20

# MeasurLink®

An Integrated Solution for Quality Data Management

MeasurLink® meets the challenge of centralizing your quality data with the most versatile tool and instrument interface options available. This high-end statistical platform delivers real-time data—when you need it most—with instant message capabilities and comprehensive quality reporting. MeasurLink® provides part inspection visualizations that are second to none, ensuring a clear view of your inspection process and your measurement results.

Whether used as an enterprisewide quality data solution or as a stand-alone quality data station, MeasurLink® provides the complete situational awareness that you need to successfully manage your process improvement and defect prevention efforts.

MeasurLink® is backed by Mitutoyo, the global leader in metrology, combining a full product line of precision measuring tools, instruments and equipment with a worldwide information network that understands the unique precision measurement and quality management needs of every industry that it serves.

Most of Mitutoyo's electronic instruments can output data via optional connecting cables or wireless transmitters and receivers in the form of the Digimatic code. The Digimatic code can also be converted into RS-232C format with several available gage multiplexers. In this way, digital data can be sent to PCs for data acquisition and advanced statistical analysis.

As a client/server application, MeasurLink gives you the performance you need through distributed processing. Combined with a multi-user relational database, MeasurLink® delivers a safe and organized data warehousing system, making quality data available for viewing and analysis by any member of the production, engineering and managerial staff throughout your company. Inspection in the factory produces data for analysis, corrective action and various reporting needs. As the backbone of your quality efforts, MeasurLink® is guaranteed to reduce your production costs and increase your bottom line.

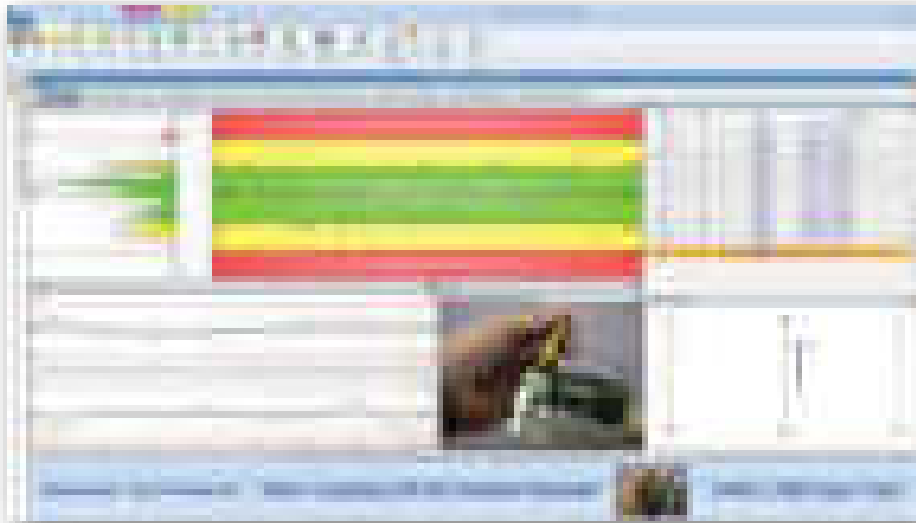

## MeasurLink Suite of Software

MeasurLink is an easy-to-use, Windows-based family of quality data management software applications. MeasurLink combines real-time data acquisition, on-line statistical analysis, integrated networking and quality information sharing into a comprehensive data management solution.

- **Real-Time**  
Real-time data collection
- **Process Analyzer**  
Analysis of all data
- **Process Manager**  
Network monitoring dashboard
- **Gage R&R**  
Gage repeatability and reproducibility
- **Gage Management**  
Gage inventory and calibration control
- **Report Scheduler**  
Automated report distribution



## MeasurLink 8 System Requirements

### Database Management System (DBMS) Requirements

MeasurLink 8 ships with a copy of Microsoft® SQL Server 2014 SP1, which can be for a standalone or a workgroup installation. MeasurLink 8 also supports:

- Microsoft® SQL Server 2014
- Microsoft® SQL Server 2012
- Microsoft® SQL Server 2008

### Operating System Requirements

All MeasurLink 8 products are supported on the following Microsoft® Windows Operating System versions:

- All Windows® 10 versions
- All Windows® 8 versions
- All Windows® 7 versions
- 32-bit and 64-bit supported

[www.measurlink.com](http://www.measurlink.com)

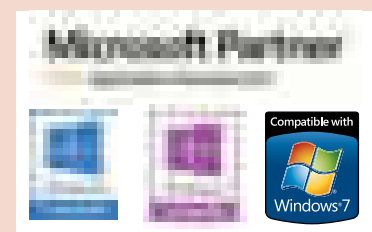

# MeasurLink®

An Integrated Solution for Quality Data Management



**Easy-to-use** MeasurLink® provides you the most intuitive interface with complete SPC functionality to help monitor and manage your manufacturing processes. With MeasurLink®, you can easily manage the quality levels of your parts, identify problem areas and apply corrective action to areas in need of attention.

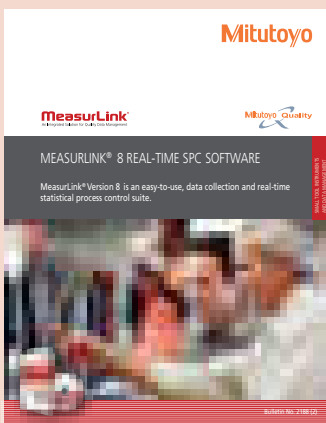

Refer to Bulletin No. (2188) for more details.

[www.measurlink.com](http://www.measurlink.com)

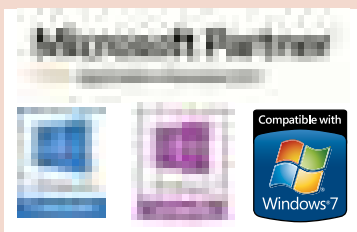

## User-friendly

Click a gage button and watch the charts update in real-time. This helps the operator stay on top of the process. Begin collecting data in minutes with Inspection Wizard.

## Data acquisition

Collects data from digital micrometers, calipers, indicators, bore gages, etc. Keyboard entry is a snap. Collect data for one or a million parts.

## Comprehensive SPC

Easy-to-use control charts, histograms, capability, detailed statistics, assignable causes, corrective actions and traceability make this software best in class.

## Variable data

Collect dimensional data (length, width, height, outside diameter, inside diameter weight, etc.). Supports derived features (calculations for run out, volume, true position, etc.) .

## Attribute data

Collect data from visual inspections (burrs, cracks, dents, missing holes, etc.) to determine the fitness of a part. Track failures using a go/no-go style or count the defects on a characteristic to determine if a part is defective. There is complete flexibility to study the individual characteristics and as a group.

## Engineering specifications

Attach drawings to parts, routines or individual characteristics for viewing. Most file formats are supported as an attachment (e.g. Word, PDF, CAD).

## Multimedia aids

Attach movies (AVI, MOV, MPG), sound (WAV) and images (BMP, JPG, TIF) to parts, routines or individual characteristics as instructional aids for an operator.

## Revision history

Track specification adjustments and preserve historical data.

## Mathematically derived characteristics

Full functioning real-time calculator with standard math functions including square root, exponential, trigonometric, sum, average, max, min, calculations.

## Variable collection frequency

Allows characteristics of the same routine to be measured at different intervals while maintaining appropriate prompted guided sequencing.

## Part pictures

View scanned blueprints and digital photographs at a glance. On-screen guided sequencing keeps the operator moving to the right feature.

## Data tests

Full support of Western Electric and Nelson Tests for pattern recognition in control charts (e.g. extreme point, trend, stratification, oscillation, etc.) along with various alerts for each failed test.

## Forced assignable cause

Force assignable cause tags on inspector during collection if process is out of control. Empower operator to build on existing pick list.

## Corrective action plans

Operators choose corrective action as applied to the part or process. Multiple corrective actions can be applied to any subgroup. Empower operator to build on existing corrective action list.

## Sequenced and random gage input

Flexible data input. Collect data by feature, by part or randomly. Guided sequencing minimizes inspection errors.

## Time-stamped data

All observation data is marked with the data and time from the computer clock.

## Flexible reporting

Build report templates with company logos and free form text. Select and position chart types to customer specification.

## Mixed variable/attribute data

Mix your dimensions and non-conformances in the same inspection routine. Track defects and defectives along with your dimensional data.

## Crystal Reports

Create your own customized Crystal Reports for use with part or run data.

## FDA 21CFR Part11 support

Provides support for medical and pharmaceutical manufacturers electronic records, including audit trails, e-signatures (Process Analyzer Professional only) and advanced security.

## Inspection wizard

Begin collecting data in 60 seconds with a "Quick Run" by defining features, tolerances and input method.

# MeasurLink® Real-Time

## On-line Real-Time Data Collection

### FEATURES

MeasurLink Real-Time performs as a data acquisition clearinghouse by enabling you to connect and acquire data from virtually any measuring device. It supports the full range of metrology technology, including calipers, micrometers, indicators, CMMs, vision systems and more. Select the edition to fit the device and the needs.

### Real-Time Standard Edition

Designed for customers who want to acquire and analyze data in real-time and check variable and attribute inspection to maximize production and minimize defects. It has views to allow the user to create parts, characteristics with nominal and tolerance, and traceability lists. The data collection interface provides real-time graphics for Run charts, Control charts, Histograms and Statistics. Standard views include Datasheet (observations and charts), Classic View (chart windows), and 2D view (part images with callouts that include charts and statistical data) along with a customizable Info View and additional Manager views. Full reporting template functionality is provided.

**Supported data sources:** keyboard, RS232 and USB devices.

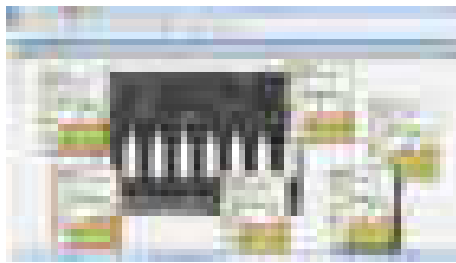

### SPECIFICATIONS

Order No.	Description
64AAB470	MeasurLink 8 Real-Time Standard Edition

### Real-Time Professional Edition

Enables customers to connect and acquire data from Mitutoyo coordinate measuring machines, vision and form measuring systems via native integration (DDE). ASCII and QMD (xml-based) file import are also supported. In addition to all of the features supported by **MeasurLink 8 Real-Time Standard Edition**, this application also supports data filters. Full reporting functionality with templates is also provided.

**Supported data sources:** keyboard, RS232 and USB devices, native Mitutoyo integration (DDE), ASCII and QMD (xml-based) file import.



### Import templates

Easily create an import template that maps data in a text file to MeasurLink information. Templates are saved to the database for everyone to use and can be added as data sources to data collection stations. An import template can be verified against the source file without adding data to the system.

### SPECIFICATIONS

Order No.	Description
64AAB471	MeasurLink 8 Real-Time Professional Edition

### Direct data transfer

Collect data into MeasurLink from MeasurLink enabled Mitutoyo capital equipment. This provides a tighter and more robust interface than importing data from files.

### Filter data

All data collected within a Real-Time run is related. Often, especially for runs containing a large volume of subgroups, requests are made for subsets of data that are further related from the entire run's population. MeasurLink provides robust filtering capabilities to comply with these requests.

### Import data

When set up as a data source, import templates are readily available to the operator, or periodic imports can be executed.

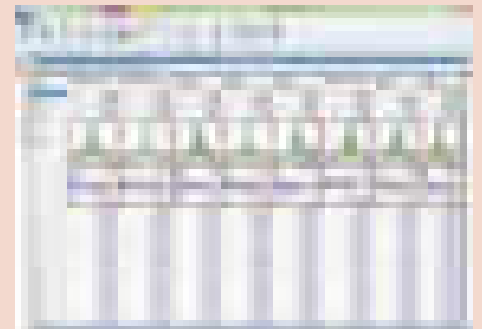

MeasurLink is designed to detect and display patterns and provide additional statistical information. Many patterns can be seen appearing on SPC charts, including:

- Cycles
- Trends
- Freaks
- Mixtures
- Grouping or "bunching" of measurements
- Gradual change in level
- Sudden shift in level
- Instability (abnormally large fluctuations)
- Stratification (abnormally small fluctuations)
- Interactions (two or more variables acting together)
- Systematic variation
- Tendency of one chart to follow another
- Attribute data tests

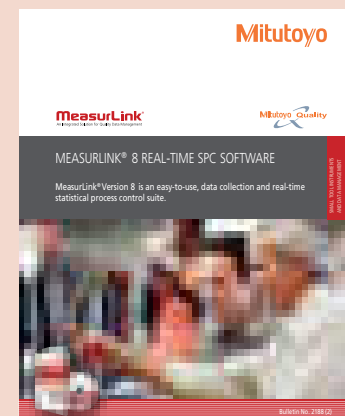

Refer to Bulletin No. (2188) for more details.

[www.measurlink.com](http://www.measurlink.com)

## Real-Time Professional 3D Edition

Designed for customers who wish to collect data using the Hoops 3D graphics view, in addition to all features offered by MeasurLink 8 Real-Time Professional Edition. Hoops 3D files can be exported from most CAD systems and provides the operator with a real view of the part. Camera angle and position can be saved for each characteristic providing for an intuitive prompted guided sequencing for the inspector.

**Supported data sources:** keyboard, RS232, and USB devices, native Mitutoyo integration (DDE), ASCII and QMD (xml-based) file import.

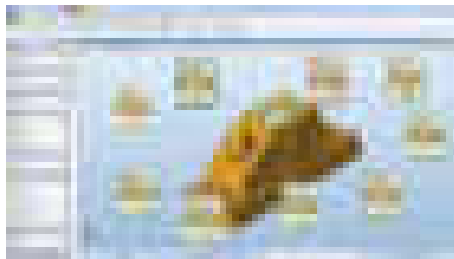
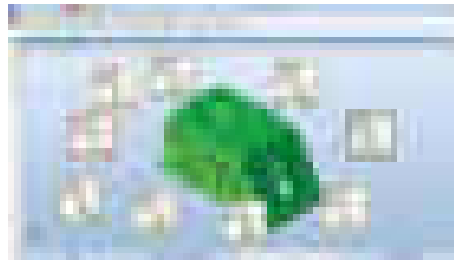

### 3D view

True three-dimensional model support with Hoops streaming files (\*.HSF). Export your part's model from Catia, Solidworks or other CAD software and place callouts in the 3D space.

### Flexible callout design

Callouts provide part acceptability at a glance. You can design them the same way as for the two-dimensional view to include charts or statistical information with the ability to size any element inside the callout.

### Guided sequence

The display can automatically change during data collection to show the next or last observation point, providing a simple guided sequence for the inspection procedure. By saving a different view for each characteristic to be inspected, you can have the model rotate, pan or zoom to show the operator details of the part.

## SPECIFICATIONS

Order No.	Description
64AAB472	MeasurLink 8 Real-Time Professional 3D Edition

## Edition Definitions

Function	Real-Time Standard	Real-Time Professional	Real-Time Professional	Process Analyzer Lite	Process Analyzer Professional
	Edition	Edition	3D Edition	Edition	Edition
Classic SPC views	x	x	x	x	x
Datasheet	x	x	x	x	x
2D View	x	x	x	x	x
Manager Views	x	x	x		
Hoops 3D View			x		
Filter		x	x		x
CMM/Vision/Form connectivity		x	x		
Import (ASCII)		x	x		
Audit Trails	x	x	x	x	x
Merge, Copy and Edit Data					x
Scatter Chart					x
Archive Data					x
Electronic Signatures					x
Summary Analysis					x
Test for Normality					x

[www.measurlink.com](http://www.measurlink.com)

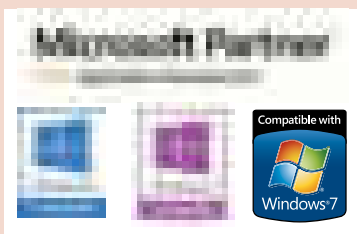

# MeasurLink® Process Analyzer

## Data Analysis Software for Windows

### FEATURES

Process Analyzer is an invaluable tool for your quality team. It gives you the flexibility to analyze your processes, identify problem areas and take corrective action to improve your product's quality. Inspection runs can be sorted by inspection station, routine or part, and are displayed with the look and feel of the Windows Explorer. Inspection data can be merged, filtered, grouped, charted and printed to the user's preferences.

### Process Analyzer Lite Edition

Designed for offline viewing of real-time data in a networked environment. All views that are available in Real-Time Standard Edition are supported, with the exception of the Manager Views. Full reporting template functionality is also provided.

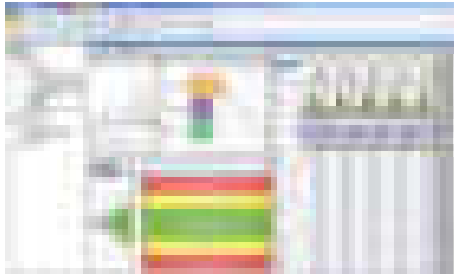

#### Review inspection data

Analyze inspection data, view notes and traceability. Open data from different runs to compare the data and process behavior.

#### Switch between databases

For larger installations that use different databases, the ability to switch the connection allows an engineer to analyze data from all sources.

#### Tree control navigation

Self-organized inspection data provided in an easy to use navigation tree. Sort data by station or inspection routine, part, year, month or day.

#### Reporting

Reporting is made easy through the use of a "what you see is what you get" style of template creation that allows you to pick chart and data through drag and drop with resizing. Several standard report templates are provided out of the box.

### SPECIFICATIONS

Order No.	Description
64AAB474	MeasurLink 8 Process Analyzer Lite Edition



Refer to Bulletin No. (2188) for more details.

### Process Analyzer Professional Edition

Designed for more robust manipulation of real-time data in a networked environment using advanced features not available in MeasurLink Process Analyzer Lite Edition. It enables quality engineering to slice and dice data in meaningful ways that contribute to quality control initiatives.

For larger installations that use different databases, the ability to switch the connection allows an engineer to analyze data from all sources.

#### Group, Search and Sort data

View data by part, routine, station, year, month, day. Apply saved filters to data and search for specific traceability or serial number criteria.

#### Merge Data

Combine lot based or just in time collected data to get a bigger picture of process variation and production quality.

#### Scatter Plots

Perform correlation studies to identify process interactions.

#### Summary Analysis

Use wizard to view and print a grid with capability and statistical information.

#### Electronic Signatures

The e-signatures can be applied to runs only in Process Analyzer Professional. When combined with audit trails available in Real-Time, and security is implemented, then MeasurLink provides support for FDA requirements for the medical and pharmaceutical manufacturers.

#### Filter Data

Robust filtering capabilities are provided. Often, for runs containing a large volume of data, requests are made for subsets of data.

#### Compare Capability to Traceability

Easily view charts showing the capability of a characteristic based on the traceability, subgroup or time. Compare the capability of machines, for example. The Cpk shows green for exceeding requirements and red for failing.

Process Analyzer Professional is known as the quality manager's favorite tool. Analyze and report on data collected across all machines. For example, merge three months of data together and easily compare operators, suppliers or machines.

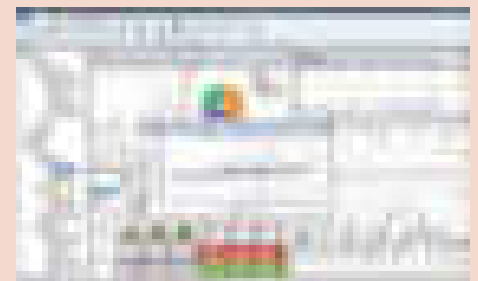

### SPECIFICATIONS

Order No.	Description
64AAB475	MeasurLink 8 Process Analyzer Professional Edition



# MeasurLink® Process Manager

## Network Monitoring Software for Windows

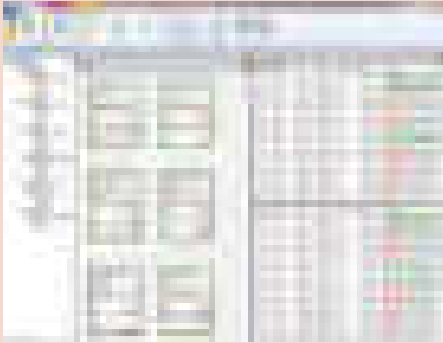

### FEATURES

Real-time monitoring of data as it is collected. Provides the QC/production manager with the perfect tool to organize and maintain a shop-wide quality program at a glance.

#### Process Manager Standard Edition

Process Manager provides a method to audit the entire shop floor inspection activity from a single PC. Easily see process information without walking from one inspection area to another by viewing current production across all machines. Show clients your quality operation for the entire facility.

#### Log View

Designed to display information from multiple stations in a tabular view format. The user can select the type of events to be monitored.

#### Group, Search and Sort Data

View data by part, routine, or station. Apply saved filters to data so you monitor only the data that you are responsible for.

#### Manager View

Display a snapshot window of characteristics that are currently being collected in MeasurLink Real-Time. The data can be sorted by station, capability or timestamp.

#### Global Variable View

Display process capability across all operations in your plant.

#### Remote viewing

See what the operators see and what your customers will see before product is delivered. Drill down through data to see detailed information. View traceability, assignable causes, corrective action, notes and raw data for current production across all machines.

#### Ticker View

Display capability values that continuously scroll on the screen.

### SPECIFICATIONS

Order No.	Description
64AAB476	MeasurLink 8 Process Manager Standard Edition



**Plant View** allows users the highest level view of their shop floor processes. Callouts have a meaningful border color related to tests for capability that have been enabled in each routine's properties.

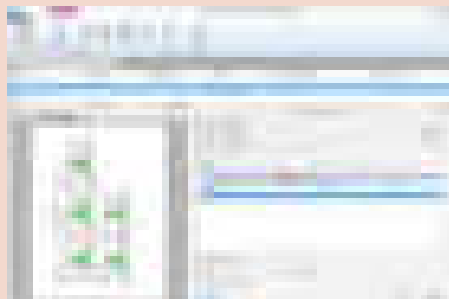

**MeasurLink Report Scheduler** allows users to schedule Crystal Reports and MeasurLink Reports. Can be used to promote a paperless environment.

[www.measurlink.com](http://www.measurlink.com)

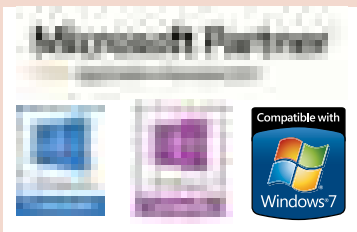

# MeasurLink® Report Scheduler

## Automated Report Distribution

### FEATURES

Report Scheduler Standard Edition is a tool that provides automated report distribution from a Windows service environment. Create reporting tasks that will run on a given schedule.

#### Report Scheduler Standard Edition

##### Reporting Task Type

**Crystal Reports** – Select a Crystal Reports template file and database connection to report on. Set values for parameters defined in template.

**MeasurLink Reports** – Select a database connection, MeasurLink report template, run or feature run data to report on, and optionally select a filter to be applied to the data.

##### Destinations

The reports can be printed, emailed, and exported in formats such as PDF. Multiple destinations can be assigned to a reporting task.

##### Assign Schedule

Schedules can be defined on hourly, daily, weekly, monthly, and yearly intervals. Define a schedule and assign it to a report task.

##### View Reports

Previewing the report allows validation of the output before scheduling the report task.

### SPECIFICATIONS

Order No.	Description
64AAB538	MeasurLink 8 Report Scheduler Standard Edition

# MeasurLink® Gage R&R

## Measurement Systems Analysis

### FEATURES

Determines the repeatability and reproducibility, linearity, bias and stability of inspection systems, allowing you to isolate gaging problems.

### Gage R&R

Measure the capability of a measurement system for a measurement task. These techniques provide information about a measurement system's reproducibility, repeatability, location or stability. Graphical tools allow for isolation of gaging problems including inconsistencies in technique between operators or inspectors.

#### Study Wizard

User-guided study setup helps the user define the study that needs to be performed in order to determine the measurement system's capabilities. All elements required for the selected study are captured before the study is created, and the user is warned to provide any missing information before beginning the study.

#### Data Input

The data for the study can be collected directly from a gage connected to the system or transferred from Mitutoyo coordinate measuring machines, vision and form measuring systems via native integration (DDE). Users can also key in data.

#### Group Studies

All studies in the database are visible and can be organized using different criteria.

#### Randomized Collection Sequence

As recommended by the academic community, the collection sequence can be automatically randomized.

#### Study Types

MeasurLink Gage R&R uses calculation methods based on AIAG's Measurement Systems Analysis, Fourth Edition (commonly known as MSA 4). The following study types are supported:

##### Location

- Bias
- Linearity

##### Reproducibility

- Type I
- Variable Range Method

##### Repeatability & Reproducibility

- Crossed ANOVA
- Crossed Average & Range
- Nested ANOVA
- Nested Average & Range

##### Stability

- Stability

##### Attribute Studies

- Attribute MSA 4
- Attribute Short Method

# MeasurLink®

An Integrated Solution for Quality Data Management

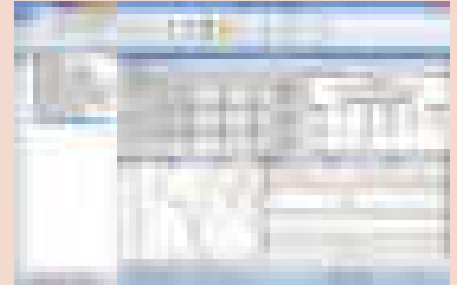

In addition to the standard calculations this software also provides graphical tools for analysis of the measurement system. The Xbar and R chart can show whether there is adequate gage discrimination to record part-to-part variation in production and operator consistency. The Part-by-Appraiser plot can show a lack of consistency between operator inspection techniques.

### SPECIFICATIONS

Order No.	Description
64AAB477	MeasurLink 8 Gage R&R



- Gage inventory management
- Gage calibration recall system
- Gage calibration procedure
- Assessment and reporting
- Gage vendor management
- Gage location management
- Gage R&R history

### SPECIFICATIONS

Order No.	Description
64AAB478	MeasurLink 8 Gage Management

# MeasurLink® Gage Management

## Gage Inventory and Calibration Control

### FEATURES

Gage Management is essential for monitoring the calibration history of a gage. Periodic adjustments may be required to bring a gage into specification.

### Gage Management Standard Edition

#### Gage Inventory Management

Easily enter and view details on all gages in a grid that can be grouped, filtered and sorted.

#### Email List of Gages Due or Overdue

Once the gage calibrations are scheduled, the list of gages due or overdue for calibration can be viewed as a report, and those lists are available for scheduled email notifications. Also available for gages due for Gage R&R studies (requires purchase of Gage R&R).

#### Gage Calibration

Perform and track calibrations using customizable gage calibration procedures. Also track outside calibration results. A "smart" calendar allows definition of working days.

#### Gage Tracking and History

Track gage movement as gages are transferred to various activities, locations and users. Supports vendor contact and user lists.

#### Print Gage Labels

Interface with a Brother's P-touch printer for printing labels for gages.

## MeasurLink® Workgroup and Site License Packages

### Packages and Bundles

#### MeasurLink Group Licensing

##### SPECIFICATIONS

Order No.	Description
64AAB479	MeasurLink 8 Site License

MeasurLink 8 Site License is a bundle package that provides the customer with the ability to install up to and including 30 copies (any combination) of any application in the MeasurLink 8 suite.

Order No.	Description
64AAB480	MeasurLink 8 Workgroup License

MeasurLink 8 Workgroup License is a bundle package that provides the customer with the ability to install up to and including 15 copies (any combination) of any application in the MeasurLink 8 suite.

Order No.	Description
64AAB482	MeasurLink 8 Workgroup License – 10 Pack

MeasurLink 8 Workgroup License – 10 Pack is a bundle package that provides the customer with the ability to install up to and including 10 copies (any combination) of any application in the MeasurLink 8 suite.

Order No.	Description
64AAB483	MeasurLink 8 Workgroup License – 5 Pack

MeasurLink 8 Workgroup License – 5 Pack is a bundle package that provides the customer with the ability to install up to and including 5 copies (any combination) of any application in the MeasurLink 8 suite.

Order No.	Description
64AAB484	MeasurLink 8 Academic License

MeasurLink 8 Academic License a bundle package that provides universities and technical colleges with the ability to install up to and including 20 copies (any combination) of any application in the MeasurLink 8 suite for educational purposes.

Note: Upgrade packages are also available. Please contact our sales department for details.

The MeasurLink suite is best acquired as a Workgroup or Site License. These packages are a mix and match bundle of any module. Workgroups are 5, 10 and 15 licenses. A site license is 30 or more licenses of MeasurLink. The package can be any combination of Real-Time\*, Process Analyzer, Process Manager, Gage R&R, Gage Management and/or Report Scheduler modules. All of the stations in the installation store their data in an SQL database located on the user's network.

\*Real-Time Professional 3D Edition has an additional surcharge per license.

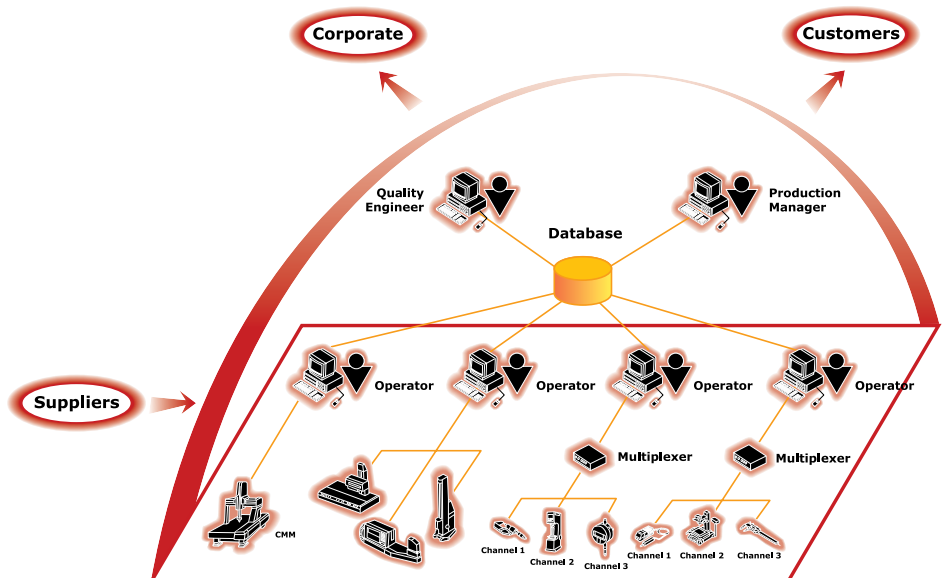

The Manufacturing Process with **MeasurLink®**

#### Benefits include:

- Better unit cost.
- Mix and match desired modules.
- Site licenses can be shared among multiple facilities.
- Security center can manage users access with each module.
- Support Center allows users to manage the suite through the network, eliminating interruption in data collection.

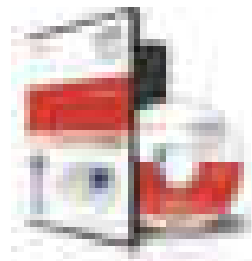

[www.measurlink.com](http://www.measurlink.com)

# MeasurLink® Floating License

## Floating License Upgrade Option

Users who want to use MeasurLink in a terminal server environment or want to have a number of concurrent users should consider the Floating License add-on. This upgrade is available in packs of 5, 10, 15 and 30. This upgrade includes a licensing server that manages the number of licenses available.



This type of installation is common in modern IT infrastructure. Thin-Client hardware or traditional PCs can utilize this option. A user could choose to upgrade a portion of or their entire number of licenses to the Floating License upgrade option.

### Benefits include:

- Easier maintenance of installations.
- Most flexible use of modules.
- Cost-effective way to include more users without purchasing additional licenses.
- Can be added to an existing installation or integrated during the initial installation.

Microsoft Partner



## MeasurLink Floating Option

### SPECIFICATIONS

Order No.	Description
<b>64AAB479F</b>	MeasurLink 8 Floating License Option 30

MeasurLink 8 Floating License Option 30 adds the Floating Option to a new or an existing installation. Must already have a minimum of 30 licenses to add this option.

Order No.	Description
<b>64AAB480F</b>	MeasurLink 8 Floating License Option 15

MeasurLink 8 Floating License Option 15 adds the Floating Option to a new or an existing installation. Must already have a minimum of 15 licenses to add this option.

Order No.	Description
<b>64AAB482F</b>	MeasurLink 8 Floating License Option 10

MeasurLink 8 Floating License Option 10 adds the Floating Option to a new or an existing installation. Must already have a minimum of 10 licenses to add this option.

Order No.	Description
<b>64AAB483F</b>	MeasurLink 8 Floating License Option 5

MeasurLink 8 Floating License Option 5 adds the Floating Option to a new or an existing installation. Must already have a minimum of 5 licenses to add this option.

*Note: Upgrade packages are also available. Please contact our sales department for details.*

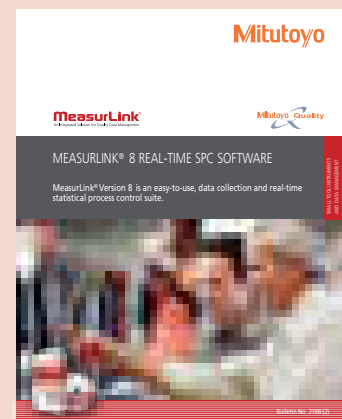

Refer to Bulletin No. (2188) for more details.

# Input Tools

## SERIES 264 — Digimatic Gage/PC Data Input Device

### FEATURES

- The input tool allows you to connect any Mitutoyo gage, with SPC output, directly to your PC.
- An USB keyboard signal conversion input tool, IT-016U converts measurement data to keyboard signals and directly inputs them to cells in off-the-shelf spreadsheet software such as Excel.
- An RS-232C communication input tool, IT-007R is also available to input data through RS-232C communication.
- More accurate measurement is possible using an optional foot switch.

### SPECIFICATIONS

Product Code No.	Input Tool for RS-232C <b>264-007</b>	Input Tool for USB <b>264-016-10</b>
Measuring Tools Required*1	Mitutoyo Digimatic measuring tools with SPC output	
PC Requirement	PC Compatible, (including laptops) with RS-232C Interface Connects to RS-232C port on CPU (D-sub 9-pin connector)	PC Compatible, (including laptops) with USB 2.0 or 1.1 port
Outside Dimensions HxWxD	2.8" x 1.7" x .9" (72 x 44 x 23.5 mm)	2.5" x 1.5" x .83" (64 x 38 x 21 mm)
Mass	3.2oz. (91g)(including cable and connector)	2.0oz (56g)

\*1: Connecting cable (optional accessory) is required for a connection to a digimatic measuring tool.



264-016-10



264-007

### Optional Accessories

- 937179T:** Foot switch  
**939039:** Gage selector

SPC connecting cables refer to page A-20.

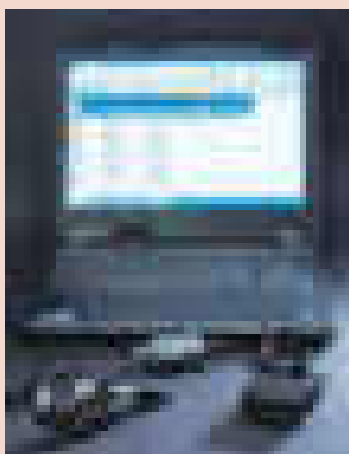

"d2" is the name for Mitutoyo Digimatic output compatible with up to 8 digits of I/O data.

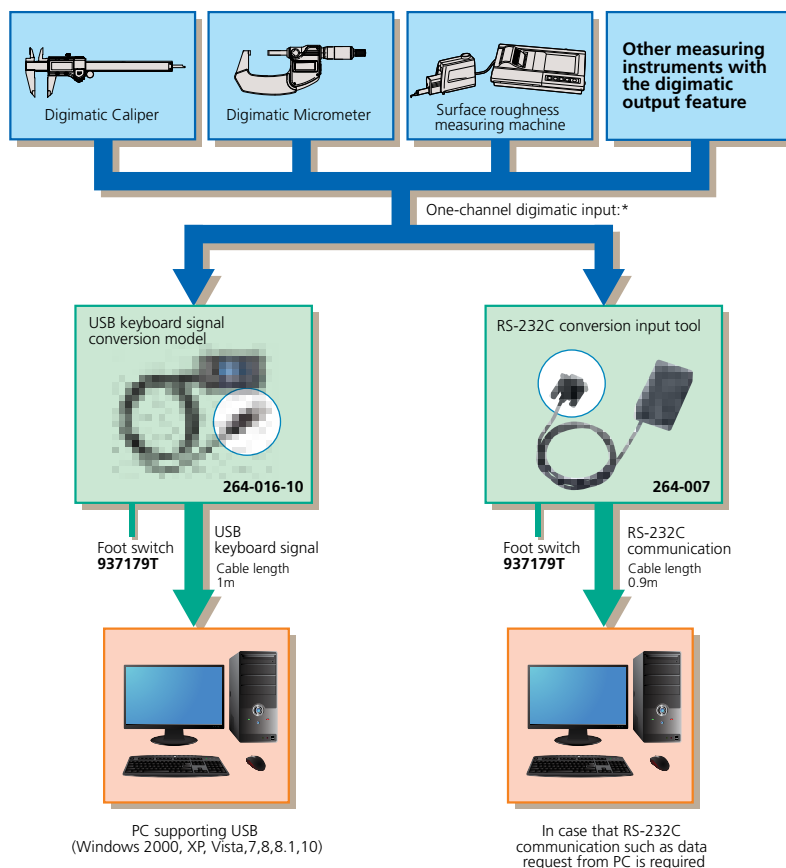

\* When you use an optional gage selector 3, you can connect up to three measuring gages and select an input by switching them. When using **264-016-10**, you can connect multiple input tools at the same time with an off-the-shelf USB hub. Simultaneous input, however, is not supported. For cables used to connect each measuring gage and input tool, refer to page A-15.

# USB Input Tool Direct: USB-ITN

Our USB Input Tool Direct has been streamlined into a range of dedicated models for each type of measuring instrument.

**MeasurLink**® **ENABLED**

Data Management Software by Mitutoyo

Data collection can start immediately after connecting the measuring instrument to a computer.

Because the input tool is automatically recognized as an \*HID keyboard device (a standard Windows driver) just by connecting it to a USB port, no special software is required.  
Patent pending (Japan)  
\*HID (Human Interface Device)

The input tool directly connects the measuring instrument to a USB port on a computer.

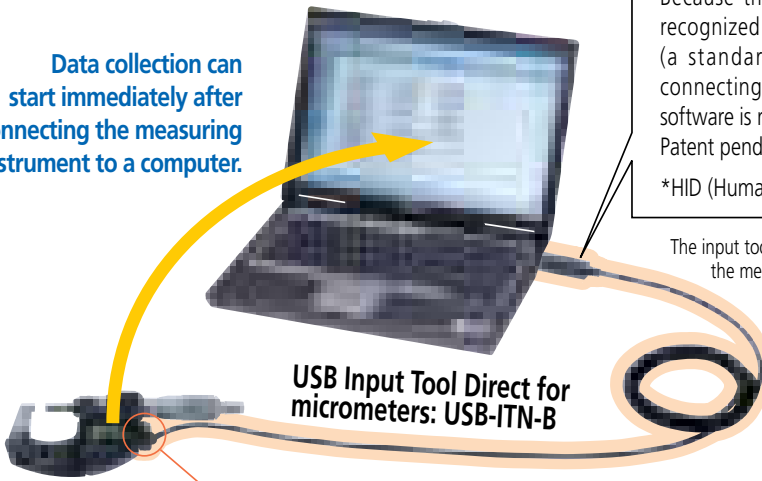

USB Input Tool Direct for micrometers: USB-ITN-B

The values displayed on the measuring instrument can be sent to the computer just by pressing the data switch.



This is the same result as that of typing numbers using the keyboard and then pressing Enter.

## Note on using a foot switch with USB-ITN

The USB-ITPAK and USB-FSW options are required (see below).

If not using optional software the IT-016U input tool can be used with a foot switch.

Although measurement data can be simply loaded directly into an Excel spreadsheet by connecting the instrument and input tool to a computer, using the optional USB-ITPAK software enables time-saving operations and procedures that significantly improve reliability and efficiency.



\*d2\* is the name for Mitutoyo Digimatic output compatible with up to 8 digits of I/O data.

## Measurement data collection software: USB-ITPAK 2.101 Order No. 06AFM387

This setup and data collection software is used to input data from one or more measuring instruments (connected by way of USB-ITN) to any Excel sheet. Supports U-Wave. (This software package cannot be used with IT-016U.)

### USB-ITN 2.1



### USB dongle



Software use requires USB dongle.

### Major features

- Excel input settings: The input destination (a workbook, sheet, or cell), cell-fill direction (right or down), cell-fill interval, and other settings can be specified.
- Measurement method selection: Any of the following three methods can be selected: Sequential measurement, batch measurement, or individual measurement.
- Data input control: Data can be requested, canceled, or skipped by using mouse buttons, function keys, or foot switch.
- Character string input by the USB foot switch adapter, USB-FSW: Any previously specified character string can be input using the foot switch. Examples: *pass* or *fail*
- Number of units that can be connected (total number for both USB-ITN and USB-FSW): Up to 20 units for Windows Vista, Windows 7 and Windows 8/8.1, and up to 100 units for Windows 2000 or Windows XP. However, the above numbers might be less depending on the system configuration.
- Data importation time: About 0.2 to 0.3 seconds per unit. However, this value differs depending on the connected measuring instruments and measurement environment.
- Driver software: The VCP (virtual COM port) drivers for USB-ITN and USB-FSW are individually recognized using a built-in COM number. • Patent pending (Japan)

Optional:  
USB-FSW  
06ADV384

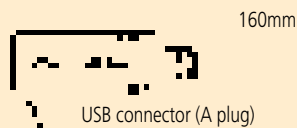

## Major specifications of USB Input Tool Direct

- Output specifications: USB 2.0 or 1.1
- Communication speed: 12 Mbps (full speed)
- Power supply: USB bus power
- Mass: 59 g
- USB 2.0 certification obtained
- Complies with the EMC Directive

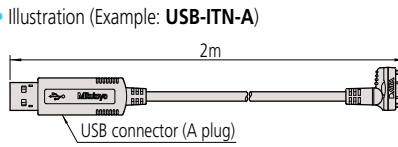

Note: It is recommended to use a commercially available USB hub that has USB certification.

## USB-ITPAK usage environment

Supported operating systems	Windows 2000 SP4, Windows XP SP2 or later, Windows Vista, Windows 7, 8 and 10
Supported Excel versions	Excel 2000, 2002, 2003, 2007 and 2013
Hard disk	At least 20 MB of free space (required for installation)
CD-ROM drive	Required for installation
USB ports	At least two ports (for the USB dongle and USB-ITN)
Resolution	At least 800 x 600 pixels, and at least 256 displayable colors

- The natural language selected in USB-ITPAK must be the same as that used in the operating system.

## Codes for the main measuring instruments classified according to the USB Input Tool Direct code, part number, and plug type

Determine the plug type suitable for your measuring instrument (one of the seven types from **A** to **G**) in the following table, and then select the corresponding USB Input Tool Direct.

Model	USB-ITN-A	USB-ITN-B	USB-ITN-C	USB-ITN-D	USB-ITN-E	USB-ITN-F	USB-ITN-G								
Order No.	06AFM380A	06AFM380B	06AFM380C	06AFM380D	06AFM380E	06AFM380F	06AFM380G								
Whether the existence of a data switch affects usability	Incorporates a data switch, so the tool is usable regardless of whether or not the measuring instrument has a switch.			Does not incorporate a data switch, so an instrument fitted with a switch is required in order to use the instrument alone. (However, the tool can be used with USB-ITPAK.)											
Cable type	<b>A</b> Water-proof with switch	<b>B</b> Water-proof with switch	<b>C</b> With switch	<b>D</b> 10-pin plain	<b>E</b> 6-pin round	<b>F</b> Straight type	<b>G</b> Water-proof straight type								
Illustration of the plug that connects to the measuring instrument															
Socket type on the measuring instrument															
Codes of major compatible measuring instruments	[Digimatic Caliper /Super Caliper] <b>-500 series</b> CD67-S_PM CD-PMX/PM/GM <b>-550/551 series</b> CDC-P_PMX CDN-P_PMX [Digimatic Carbon Fiber Caliper] <b>-552 series</b> CFC-G/GL/GC/GU [Digimatic Depth Gage] <b>-571 series</b> VDS-PMX [Digimatic Scale Unit] <b>-572 series</b> SD-G [Digimatic Exclusive Caliper] <b>-573 series</b> NTD-PMX/PM			[Digimatic Micrometer, QuantuMike] <b>-293 series</b> MDC-MJ/MJB/MJT MDE-MJ [Tubular Inside Micrometer] <b>-337 series</b> IMZ-MJ <b>-339 series</b> IMJ-MJ [Digimatic Micrometer Head] <b>-350 series</b> MHN-MB/MJB/MJNB [Digimatic Exclusive Micrometer] (The end of the mark is -MJ/MJB/M/MB/PM/PMB) [Digimatic Holtest] <b>-468 series</b> HTD-R			[Digimatic Micrometer Head] <b>-164 series</b> MHD-MB [Digimatic Caliper] <b>-500 series</b> CD-CX/C/S_C <b>-550/551</b> CDC-C/CX, CDN-C/CX [Digimatic Depth Gage] <b>-571 series</b> VDS-DCX/DC [Digimatic Scale Unit] <b>-572 series</b> SD-D/SDV-D [Digimatic Exclusive Caliper] <b>-573 series</b> The end of the mark is -CX/C			Measuring instrument models that incorporate a data switch					
	[Surface Roughness Tester] <b>-178 series</b> SJ-201/210/301/ 400/500 [Coating Thickness Gage] <b>-179 series</b> DGE-745/755 [Linear Height] <b>-518 series</b> QMH-S [Reference Gage] <b>-515 series</b> HMD-C [Digimatic Indicator] <b>-543 series</b> ID-H [Laser Scan Micrometer] <b>-544 series</b> LSM-9506/6100/ 6200/6900 [μ-checker] Digital μ-checker (Using the foot switch)				[Digimatic Micrometer] <b>-121 series</b> BD <b>-164 series</b> MHD-M <b>-227 series</b> CLM <b>-293 series</b> MDQ-M MDC-M [Tubular Inside Micrometer] <b>-337 series</b> IMZ-M [Tubular Inside Micrometer] <b>-339 series</b> IMJ-M [Digimatic Holtest] <b>-468 series</b> HTD [Reference Gage] <b>-515 series</b> HME-DM [Borematic] <b>-568 series</b> SBM-C [Hardness Testing Machines] <b>-810 series</b> HM-100/200 HV-100/HH-411 HR-500				[Digimatic Height Gage] <b>-192/570/574 series</b> HDM-A/AX, HD-A/AX HDS-H_C/C HDF-N [Digimatic Caliper] <b>-500/550/551 series</b> CD/CDC/CDN [Digimatic Bore Gage] <b>-511 series</b> CG-D [Digimatic Indicator] <b>-543 series</b> ID-C_X/_RB/_GB [Digimatic Depth Gage/ Digimatic Thickness Gage] <b>-547 series</b> Digimatic model (ID-CX) [Digimatic Carbon Fiber Caliper] <b>-552 series</b> CFC-P/_L/_C/_U [Digimatic Scale Unit] <b>-572 series</b> SD-E, SDV-E SD-F, SDV-F [Portable Hardness Testing Instruments] <b>-811 series</b> HH-300				[Digimatic Indicator] <b>-543 series</b> ID-N ID-B		
				Measuring instrument models that do not have a data switch											
[Digimatic Indicator] <b>-543 series</b> ID-F [Linear Gage/Counter] <b>-542 series</b> EF-PRH/ZR, EH-P/Z/S/D EB-P/Z/D EC-D [Litematic] <b>-318 series</b> VL-A/AS/AH				No corresponding models		[Digimatic Indicator] <b>-543 series</b> ID-C/S/C_A [Digimatic Depth Gage/ Digimatic Thickness Gage] <b>-547 series</b> Digimatic model (ID-C) <b>-575 series</b> ID-U		No corresponding models							

# U-WAVE

## Measurement Data Wireless Communication System

**MeasurLink**® ENABLED  
Data Management Software by Mitutoyo

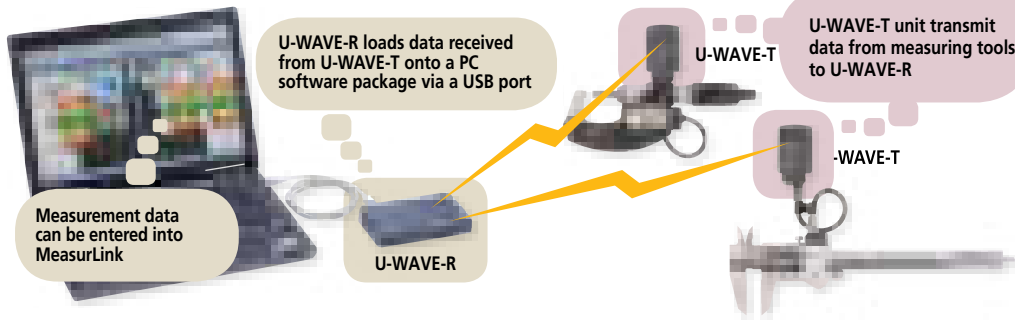

The **U-WAVE** system enables easy wireless data communication from a measuring tool to a PC using the digimatic protocol. Measurement efficiency is improved by eliminating the long and cumbersome data cables. The user-friendly interface allows data to be loaded into any software product that accepts keyboard input, such as Excel\* or Notepad.

### 1 U-WAVE-R · Registered Design (Japan)

#### Major Specifications of U-WAVE-R

Model Order No.	U-WAVE-R 02AZD810D*
Power supply	USB bus power system
Number of <b>U-WAVE-R</b> units that can be connected to one PC	Up to 15
Number of <b>U-WAVE-T</b> units that can be connected	Up to 100
External dimensions	5.51" x 3.15" x 1.24" (140 x 80 x 31.6mm)
Mass	.29 lbs (130g)



\*Detailed information on conformity standards of wireless communication specification is given below.

### 2 U-WAVE-T · Registered Design (Japan)

#### U-WAVE-T sends measurement data to U-WAVE-R.

#### Actual size



Standard accessory: screwdriver

#### Major specifications of U-WAVE-T

Model Order No.	U-WAVE-T (IP67 model) 02AZD730G*	U-WAVE-T (Buzzer) 02AZD880G*
Protection Rating	IP67	-
Data reception indication	LEDs	LEDs and Buzzer
Power supply	Lithium battery CR2032★1	
Battery life	Approx. 400,000 transmissions	
External dimensions	1.73" x 1.17" x .73" (44 x 29.6 x 18.5 mm)	
Mass	.05 lbs (23g)	

\*Detailed information on conformity standards of wireless communication specification is given below.

### ■ Installation Bracket Kit Order No. 02AZE200



\*"d2" is the name for Mitutoyo Digimatic output compatible with up to 8 digits of I/O data.



500 Series  
Caliper



293 Series  
Micrometer



543 Series  
Indicator

### Specifications of wireless communication

Conformity standards	European conformity standards* EN 50371:2002 EN 300 440-1 V1.3.1 EN 300 440-2 V1.1.2 EN 301 489-01 V1.6.1 EN 301 489-03 V1.4.1	Wireless standards	Conform to IEEE802.15.4
	U.S.A. conformity standards 47 CFR Part 15.247:(Subpart :C) 47 CFR Part 15,(Subpart :B)	Wireless communication distance	Approx. 60ft (within visible range)
	Canada conformity standards RSS-210 (Issue 7) RSS-Gen (Issue 2) ICES 003 (Issue 4)	Wireless communication speed	250 kbps
		Transmission output	1 mW (0 dBm) or less
		Modulation method	DS-SS (direct sequence spread spectrum) Resistant to interfering signal or noise.
		Communication frequency	2.4 GHz band (ISM band: universal frequency)
		Used band	15 channels (2.405 to 2.475GHz at intervals of 5MHz) The noise search function can avoid interference with other communication devices.

Note: In accordance with wireless regulations the use of this product is permitted in Japan, Europe (a total of 32 countries including 27 EU members, 4 EFTA members and Turkey), U.S.A. and Canada. This product must not be used in other countries or areas.  
\* This product is not compatible with the conventional Mu-WAVE, for which communication specifications are different.  
\* Japan conformity standards: ARIB STD-T66

### ■ Dimensions of Each Part

Unit: mm

#### U-WAVE-T

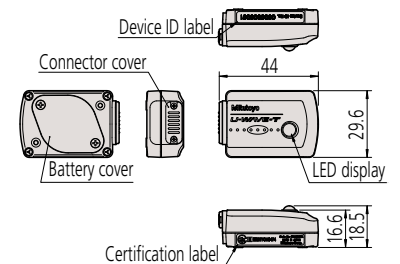

#### U-WAVE-R

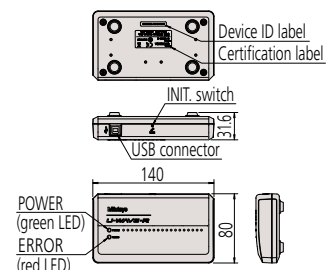



# U-WAVE

## Measurement Data Wireless Communication System

### List of U-WAVE-T Connecting Cables

Select one from cables **A** to **G**, referring to the part number of connecting cable for wired connection in your measuring tool catalog or manual. If you are unsure which cable is appropriate, check the cable connectors, the shapes of terminal on the measuring tool side, or the codes of compatible measuring tool for cables **A** to **G** below.

It is not possible to connect to EF and EH counters.

**When connected with U-WAVE-T** Select one of the USB input tool direct from table below to fit the connector (A to G) and also select either standard type (fig.1) or foot switch type (fig.2) dependent on usage.

Note: Not connectable to these Mitutoyo products: Litematic VL, Linear Gage Counter EF/EH, Surftest SJ-500.

From seven types of cables (**A** to **G**), select one compatible with your measuring tool.

#### Measuring tool

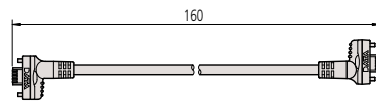

#### U-WAVE-T

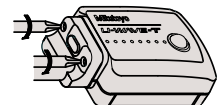

Fasten the connector to **U-WAVE-T** with two screws.



Fig.1 Standard type connecting cable

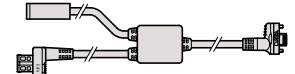

Fig.2 Connecting cable for foot switch

Reference Order No. of connecting cable	1m	<b>05CZA624</b>	<b>05CZA662</b>	<b>959149</b>	<b>936937</b>	<b>937387</b>	<b>905338</b>	<b>21EAA194</b>
	2m	<b>05CZA625</b>	<b>05CZA663</b>	<b>959150</b>	<b>965014</b>	<b>965013</b>	<b>905409</b>	<b>21EAA190</b>

For standard	Order No.	<b>02AZD790A</b>	<b>02AZD790B</b>	<b>02AZD790C</b>	<b>02AZD790D</b>	<b>02AZD790E</b>	<b>02AZD790F</b>	<b>02AZD790G</b>
For foot switch	Order No.	<b>02AZE140A</b>	<b>02AZE140B</b>	<b>02AZE140C</b>	<b>02AZE140D</b>	<b>02AZE140E</b>	<b>02AZE140F</b>	<b>02AZE140G</b>



Cable type	<b>A</b> Water-proof model with output button	<b>B</b> Water-proof model with output button	<b>C</b> With data-out button type	<b>D</b> 10-pin plain type	<b>E</b> 6-pin round	<b>F</b> Plain type straight	<b>G</b> Plain type straight water-proof model
Connector shape on the measuring tool side							
Socket shape on the measuring tool							
Codes of major compatible measuring tools and instruments	[Digimatic Caliper] <b>CD67-S_PM</b> <b>CD-PMX</b> <b>CD-PM/GM</b> <b>CDC-P_PMX</b> <b>CDN-P_PMX</b> <b>CFC-G/GL/GC/GU</b> [Digimatic Caliper] <b>NTD-PMX</b> [Digimatic Depth Gage] <b>VDS-PMX</b> [Digital Scale and DRO Systems] <b>SD-G</b>	[Digimatic Micrometer] <b>MDE-MJ</b> <b>MDC-MJ/MJT</b> [Digimatic Micrometer] The code suffix is -MJ. <b>BLM-M</b> <b>OMV-M</b> <b>OMP-M</b> <b>PDM-M</b> <b>IMP-M</b> <b>VM-M</b> [Digimatic Micrometer Heads] <b>MHN-M/MJ/MJN</b> [Digimatic Holtest] <b>HTD-R</b> [Digimatic Depth Gage] <b>DMC-M</b>	[Digimatic Caliper] <b>CD-CX/-C</b> <b>CD-S_C</b> <b>CDC-CX/C</b> <b>CDN-CX/C</b> [Digimatic Caliper] <b>NTD-CX/C</b> [Digimatic Depth Gage] <b>VDS-DCX</b> [Digital Scale and DRO Systems] <b>SD-D, SDV-D</b>	[Digimatic Indicator] <b>ID-H/F</b> [Linear Height] <b>QMH-S</b> [Linear Gage/Counter] <b>EB, EC-D</b> [μ-checker] <b>Digital μ-checker</b> [Laser Scan Micrometer] <b>LSM-9506</b> [Reference Gage] <b>HDM-C</b> [Coating Thickness Gage] <b>DGE-745/755</b> [Form Measurement] <b>SJ-201/301/401</b>	[Digimatic Micrometer] <b>MDQ-M</b> <b>MDC-M</b> <b>CLM1-QM/DK</b> <b>PDM-QM</b> <b>PMU-DM</b> <b>BD-M</b> [Digimatic Holtest] <b>HTD</b> [Reference Gage] <b>HDM-DM</b> [Hardness Testing Machines] <b>HM-100/200</b> <b>HV-100</b> <b>HR-500</b> <b>HH-411</b>	[Digimatic Caliper] <b>CD, CFC-P/-L/-C/-U</b> [Digimatic Height Gages] <b>HD-AX, HDM-AX</b> <b>HDS-H_C/-C</b> <b>HDM-A</b> <b>HDF-N</b> [Digimatic Indicator] <b>ID-C/_RB/_A/_GB</b> <b>ID-S/U</b> [Digimatic Depth Gage] Digimatic model (ID-C) [Digital Scale and DRO Systems] <b>SD-E, SDV-E</b> <b>SD-F, SDV-F</b> [Portable Hardness Testing Instruments] <b>HH-300</b>	[Digimatic Indicator] <b>ID-N</b> <b>ID-B</b>

### Note on Wireless Communication Environment

Although the communication range for **U-WAVE** is approximately 60 ft. line-of-sight, performance may be affected by obstacles or environmental factors.

#### Cautions

- Safety caution:** Do not use this device near medical equipment that might malfunction due to radio interference.
- Caution on radio law:** This device is certified as a 2.4 GHz band wide-band low-power data communication system based on the radio regulations in Japan, Europe, U.S.A. and Canada. It is prohibited by law to disassemble or modify this device or peel off the certification label from it.

Item	Contents
Concrete wall	Communication is not possible in a completely enclosed room.
Metal partition	Communication speed may drop or communication may be interrupted.
Wireless LAN, communication device such as ZigBee Bluetooth, and microwave oven	Communication speed may drop or communication may be interrupted. Maintain the set frequency and installation distance if at all possible.
Medical instrument	Do not use this product near a medical instrument such as a laser knife or electronic scale.

\*d2\* is the name for Mitutoyo Digimatic output compatible with up to 8 digits of I/O data.



# U-Wave Fit

## SERIES 264 — Wireless Data Transmitter

### FEATURES

- The transmitter is designed to fit in the space behind the display, and the connecting cable has been replaced by a rigid connector
- Approx. 20 m transmission range (within visible range)
- 2.4GHz wireless system for reliable and secure data transmission
- Easy data export to Microsoft® Excel® or SPC software applications
- Transmitter confirms data transfer by an LED signal and optional buzzer
- An IP67 transmitter is available to ensure a coolant-proof gaging system
- Low power consumption: 400,000 data transmissions with a single battery

### SPECIFICATIONS

Wireless communication protocol	IEEE 802. 15. 4
Modulation method	DS-SS (Direct Sequence Spread Spectrum)
Communication distance	Approx. 20 m (within visible range)
Communication speed	250 kbps
Communication frequency	2.4 GHz (ISM: universal frequency band)
User band	15 channels (2.405 to 2.475GHz at intervals of 5 MHz)
OS compatibility	Windows® 2000 Professional (≥SP4), Windows® XP Professional (≥SP2), Windows® XP Home Edition (≥SP2), Windows Vista®, Windows® 7 (32bit, 64bit), Windows® 8, 8.1, 10 (32bit, 64bit)



### U-WAVE-T (Transmitter)

Order No.	Model	Measuring Instrument	Remarks	Data reception indication
264-620	U-WAVE-TC	4", 6", 8", 12", IP67 caliper/standard caliper	IP67 type	LED
264-621	U-WAVE-TC	4", 6", 8", 12", IP67 caliper/standard caliper	Buzzer type	Buzzer/LED
264-622	U-WAVE-TM	COOLANT-PROOF (IP65) micrometer	IP67 type	LED
264-623	U-WAVE-TM	COOLANT-PROOF (IP65) micrometer	Buzzer type	Buzzer/LED
02AZF310*	Connection unit	IP67 caliper/COOLANT-PROOF (IP65) micrometer	Waterproof type	—
02AZF300*	Connection unit	Standard caliper	Standard type	—

\*A connection unit is required when ordering a transmitter



02AZD810D

### U-WAVE-R (Receiver)

Order No.	Remarks	Software	Number of U-WAVE-R units that can be connected to PC	Number of U-WAVE-T units that can be connected	USB cable length [m]	Dimensions (WxDxH) [mm]	Mass [g]
02AZD810D	U-WAVE-R + software	U-WAVE PAK	Up to 16	Up to 100	1	140 x 80 x 31.6	130

**MeasurLink® ENABLED**  
Data Management Software by Mitutoyo

## U-WAVE fit

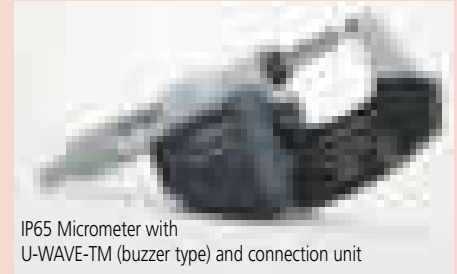

IP65 Micrometer with U-WAVE-TM (buzzer type) and connection unit



For micrometers

**U-WAVE-TM**



Standard caliper with U-WAVE-TC (buzzer type) and connection unit



For calipers

**U-WAVE-TC**



"d2" is the name for Mitutoyo Digimatic output compatible with up to 8 digits of I/O data.

# Multiplexers – MIG-8USB, MIG-4USB

## SERIES 982 — Digimatic/RS-232C Interface Unit

### Technical Data

Data output: Via RS-232C interface / USB

### Default Configuration

Data length: 8 bits  
Start bit: 1 bit  
Stop bit: 1 bit  
Parity check: None  
Baud rate: 9600

### Standard Accessory

**06AEG302JA:** AC Adapter  
RS232C: Cable (1.5m / 5ft)  
USB Cable

### Optional Accessories

**937179T:** Foot switch

### FEATURES

- A measurement data transfer device, multiplexer MIG-8USB and MIG-4USB converts digimatic output measurement data to RS-232C or USB-HID and outputs it to an external device such as PC.
- Up to eight/four measuring instruments with the digimatic output feature can be connected.
- Units can be daisy-chained to meet any size needs.
- MIG-4USB includes toggle switch for each input.

### MIG-8USB

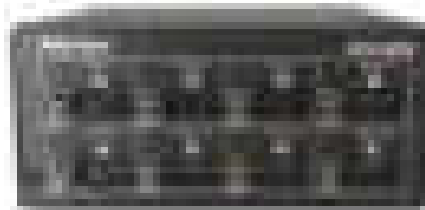

64AAB386  
Front view



64AAB386  
Back view

### SPECIFICATIONS

Model No.	MIG-8USB	MIG-4USB
Order No.	64AAB386	64AAB387
Gage Capacity	8	4
Dimension (mm) W x D x H	146 x 150 x 70	146 x 150 x 45
Mass (g)	710	540

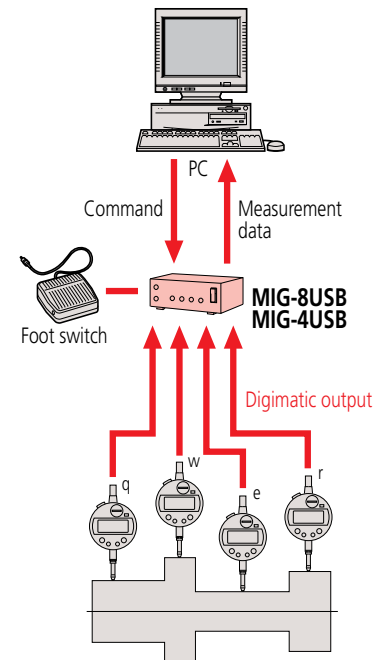
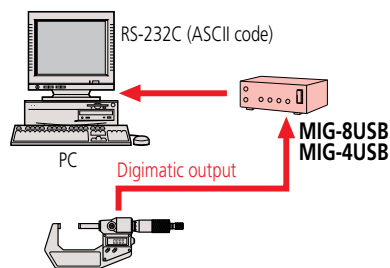

# Gage Selector 3

## 3-channel Switching Box for Data Transmission

### FEATURES

- Three digimatic gages can be connected.
- You can specify the gage which outputs the data with the channel switch.

### SPECIFICATIONS

Order No.	Description
939039	Gage Selector 3

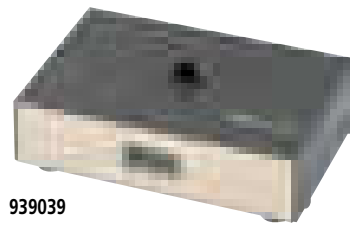

939039

### Examples of Connections

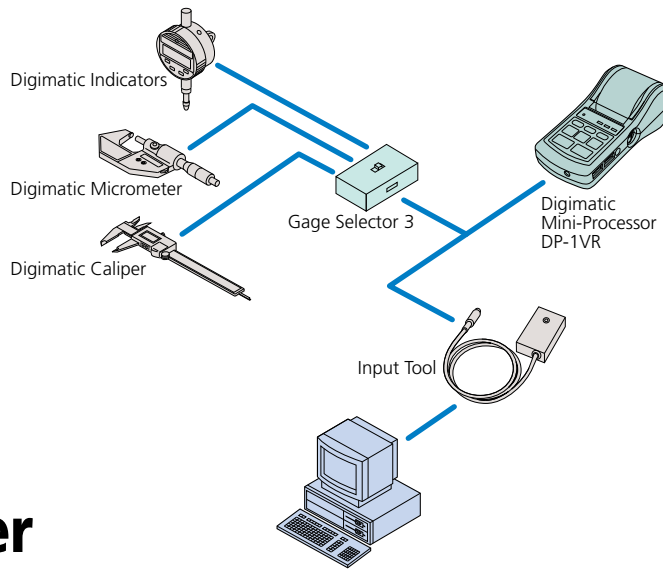

# EC Counter

## SERIES 542 — Assembly-type Display Unit

### FEATURES

- Compact panel mounting type and DIN size. It can be easily incorporated into each system.

### SPECIFICATIONS

Order No.	Description
542-007A	EC Counter



542-007A

### DIMENSIONS

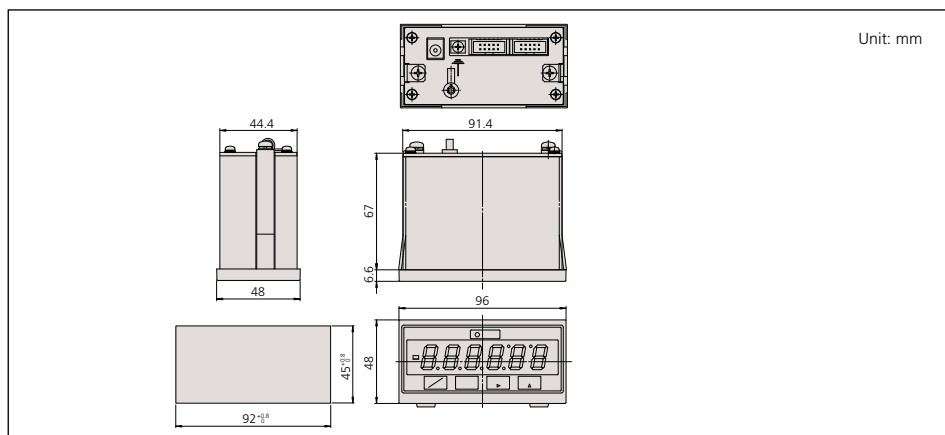

Unit: mm

### Technical Data

Connection: Up to three gages  
 Signal: Digimatic code format  
 Connection: Bidirectional  
 External dimensions (W x D x H): 100 x 70 x 33mm

### Technical Data

Applicable gage: LGD, LGS, All SPC output gages  
 Resolution: .00005"/.0001"/0.001mm,  
 .0005"/.001"/0.01mm  
 No. of gage input: 1  
 Display: 6-digit LED and a negative [-] sign  
 Function: Preset  
 Go-no-go judgment  
 Output (open-collector): 3-step limit signal, Normal signal  
 External control: Preset, Data hold  
 Power supply: Via AC adaptor  
 Dimensions (W x D x H): 96 x 48 x 84.6mm  
 Mass: 50g

### Standard Accessory

06AEG302JA: AC Adapter

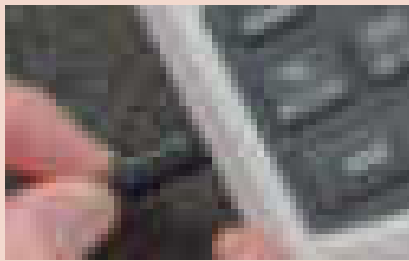

USB connection allows collected data to be easily transferred from the DP-1VA to the PC. The output is HID or VCP so data can be sent directly to Excel or data collection software such as IT-Pak or MeasurLink.

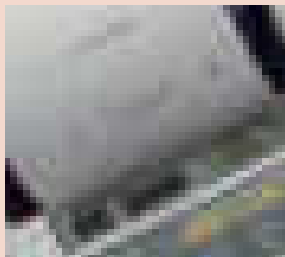

Digimatic 2 function allows the high resolution of the gage to be output in its entirety in metric or inch.

### Standard Accessory

**06AEG302JA:** AC Adapter

### Optional Accessories

**09EAA084\*:** RS-232C changing cable (1m, 9pin)

**965516\*:** GO/±NG judgment cable

**937179T:** Foot switch

**09EAA082:** (10 rolls)

\*It is impossible to use the both RS-232C cable and GO/±NG judgment cable at the same time.

- USB cable (A-microB) (optional)  
06AFZ050



- Foot switch (optional)  
937179T



**d2**

"d2" is the name for Mitutoyo Digimatic output compatible with up to 8 digits of I/O data.

# DP-1VA

## SERIES 264 — Digimatic Mini-Processor

### DP-1VA Data Collection

- A gage with SPC output is connected to the DP-1VA with an SPC cable.
- The data for each part measured is printed or sent directly to a PC through a USB cable.
- This data can be triggered by the button on the gage, cable or the DP-1VA. The footswitch can also be used.

### Data Logger:

- Data can be stored internally, printed and/or sent to a PC as it is measured or after all data has been collected
- Up to 1,000 measurements can be stored.

### Timer:

- Data collection can be triggered by a timer function. The DP-1VA can collect data unattended to measure changes over time.

### Tolerance and SPC:

- Tolerances can be set in the unit and statistics can be calculated and printed directly from the DP-1VA.
- No additional software is required.

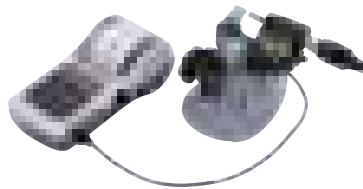

264-505A

## SPECIFICATIONS

Order No.	264-505A
Data input	Digimatic, Digimatic 2, RS-232C input (for KA Counter Only)
Printing method	Thermal Line Printer
Character specifications	Total dot number: 384 dots/line Dot size: 8 dots/mm Normal font: 24 x 16 dots Large font: 36 x 24 dots
Print speed	0.8 s/line when using AC adapter
Print capacity	7,000 lines/roll with Large font 10,000 lines/roll with Normal font
Print data	Measuring data, go/±no go, number of data, maximum minimum value, range, average, standard deviation, number of defective, function defective, process capability index, histogram, D-chart, control chart generation for X-bar and central limit data, data and time
Printer paper	High durability thermal paper. (one roll included) Width: 58mm. Roll length: 48m
Power supply	100 V 50/60 Hz AC adapter (6 V, 2 A) AA alkaline batteries x4 (not included)
Battery life	About 10,000 lines at 20 C
Data processing capability	Mode 0: 100,000 data entries Mode 1: 9,999 data entries Mode 3: sample size 10 x subgroup 9,999 = Total number of data entries: 99,990
Tolerance judgement	5 sets
Logging of measurement data	Max 1,000 points
Timer input	0.25 s, 1 s, 5 s, 30 s, 1 min, 30 min, 60 min
Data Output	USB Output RS-232C output at TTL level Tolerance judgment result output (-NG, GO, +NG)
Clock precision	+/-2 min max/month
Internal battery life	10 years
Operating temperature range	0 C to 45 C with AC adapter 10 C to 45 C with batteries
External Dimensions	94mm x 201mm x 75mm

# SPC Connecting Cables

- These cables are used to output measurement data from the digimatic gage with the output feature to the digimatic mini processor, digimatic display unit, multiplexer or other device.
- Cables of one or two meters are available.
- Note that the shape of connector differs depending on the model.

Input plug to Data Processor		
Order No.		Applicable gages
Straight type <b>905338:</b> 1m (40") <b>905409:</b> 2m (80")		<b>All CALIPERS WITHOUT ABSOLUTE ENCODER</b> Height Gage <b>570-2XX, 192-6XX, 192-67X</b> Indicators <b>575-XXX, 543-6XX, 543-2XX, 543-4XX</b> Depth Gages <b>547-21X, 547-25X, 571-2XX</b> Scale Unit <b>572-XXX</b> Thickness Gages <b>547-3XX, 547-4XX</b>
Back type <b>905689:</b> 1m (40") <b>905690:</b> 2m (80")		
Right type <b>905691:</b> 1m (40") <b>905692:</b> 2m (80")		
Left type <b>905693:</b> 1m (40") <b>905694:</b> 2m (80")		
With data out switch type <b>959149:</b> 1m (40") <b>959150:</b> 2m (80") <b>04AZB512:</b> 1m (40") L-Type <b>04AZB513:</b> 2m (80") L-Type		<b>ALL DIGIMATIC CALIPERS WITH ABSOLUTE ENCODER</b> Height Gage <b>570-2XX</b> Depth Gages <b>571-2XX</b> Scale Unit <b>572-XXX</b> Micrometers over 12"/300mm
With data out switch type <b>05CZA624:</b> 1m (40") <b>05CZA625:</b> 2m (80")		Coolant-Proof Caliper <b>500-68X, 500-76X, 500-78X.</b> Coolant-Proof Digimatic scale units <b>572-61X.</b>
With data out switch type <b>05CZA662:</b> 1m (40") <b>05CZA663:</b> 2m (80")		<b>Digimatic Micrometer IP65</b>
6 pins type <b>937387:</b> 1m (40") <b>965013:</b> 2m (80")		<b>ALL MICROMETERS (not for IP65 mics)</b> Indicators <b>543-11X, 543-13X, 543-14X, 543-18X, 543-17X</b> Holtest <b>468-2XX, 468-9XX</b> Micrometer Head <b>164-162, 164-172, 350-71X, 329-71X</b> Boremetrics <b>568-XXX</b> Others Mikematic, Quickmike Bench Mike <b>121-XXX</b>
10 pins type <b>936937:</b> 1m (40") <b>965014:</b> 2m (80")		Indicators <b>543-5XX</b> MU-Checkers <b>519-4XX, 519-621A</b> MU-Gages <b>179-204, 179-205, 179-206</b> Display <b>542-022-5A, 542-032-5A, 542-036-5A</b> Display <b>572-011A, 572-031A</b> Linear Height <b>518-3XX</b> Litematic <b>318-2XX</b> Heightmatic <b>57X SERIES.</b> Digi Derm <b>179-7XX</b> Hardness Tester ( <b>Micro Hardness Type</b> )
Flat straight type <b>21EAA194:</b> SPC cable (40" / 1m) <b>21EAA190:</b> SPC cable (80" / 2m)		ID-NVID-B coolant proof digimatic Indicators

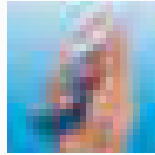

### Micrometers



### Micrometer Heads



MDC Micrometer



MDH Micrometer



QuantuMike



Digimatic Outside  
Micrometer

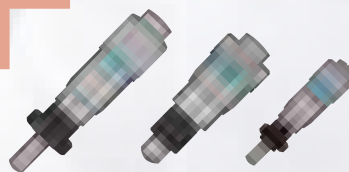

Micrometer Heads  
fine spindle feed

### INDEX

<b>Micrometers</b>	
Coolant-Proof Micrometer	B-2,3
Digimatic Micrometer	B-4
Digimatic Micrometer- MDC- Lite	B-4
MDH Micrometer	B-5
QuantuMike	B-6
ABSOLUTE Digimatic Micrometers	B-7
Quickmike	B-8
Outside Micrometers	B-9, 11-19
Ratchet-Thimble Micrometer	B-10
Spline Micrometers	B-20
Point Micrometers	B-21
Crimp Height Micrometers	B-22
V-Anvil Micrometers	B-23,24
Limit Micrometers	B-25
Pana Micrometers	B-26
Spherical Face Micrometers	B-27
Tube Micrometers	B-28
Uni-Mike	B-29
Uni-Mike	B-29
Sheet Metal Micrometers	B-30
Blade Micrometers	B-31
Disk Micrometers	B-32,34-35
Paper Thickness Micrometers	B-33
Gear-Tooth Micrometers	B-36
Screw Thread Micrometers	B-37,38
3-Wire Thread Measuring System	B-39
Can Seam Micrometers	B-40
Hub Micrometers	B-41
Wire Micrometers	B-41
Digital Outside Micrometers	B-42
Indicating Micrometers	B-43
Snap Meters	B-43
Dial Snap Meters	B-44
Caliper-Type Micrometers	B-45
Groove Micrometers	B-46
Small-Hole Gage Set	B-47
Telescoping Gage Set	B-47
Micrometer Stands	B-48
Color Ratchet & Color Speeder	B-49
Spindle Attachment Tip	B-49
Micrometer Oil	B-49
Optical Parallels	B-50
Optical Flats	B-50
Micrometer Standards	B-51
Standards for Screw Thread Micrometers	B-52
Standards for V-Anvil Micrometers	B-52
Tool Kits	B-53,54
<b>Micrometer Heads</b>	
Micrometer Head Selection Guide	B-55
Digimatic Micrometer Heads	B-56,57
Micrometer Heads	B-58-72
Micro Jack	B-72
Precision Lead Screw	B-73
Fixtures for Micrometer Heads and Linear Gages	B-74,75
Quick Guide to Precision Measuring Instruments	B-76
Micro Jack	B-72
Precision Lead Screw	B-73
Fixtures for Micrometer Heads	B-74,75

# Coolant-proof Micrometer

**SERIES 293 — with Dust/Water Protection Conforming to IP65 Level**

## FEATURES

- IP65 protection level, enabling use in environments exposed to cutting oil, etc\*.  
\*Anti-corrosion treatment is required after use.
- Measurement data output function is available with a water-resistant connection cable.
- Auto power ON/OFF function.
- A nonslip surface is employed for the frame cover and surface panel to achieve stable handheld measurement.

- Certificate of inspection\* is included. (2" /50mm or less range models)\*\*  
\*It is not the type used to obtain calibration certificates.  
\*\* except 293-349-30
- With a standard bar except for 0-1" /0-25mm model.
- Supplied in fitted case. Plastic case up to 6" /150mm, wooden box over 6" /150mm.



293-330-30



293-252-30

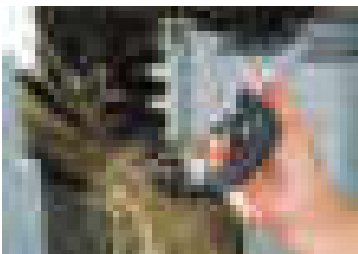

Oil-resistant materials are used in all plastic components.

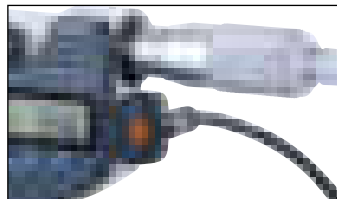

Measurement data output function is available with a water-resistant connection cable.

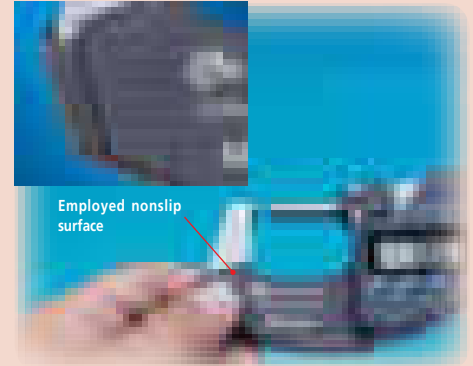

Employed nonslip surface

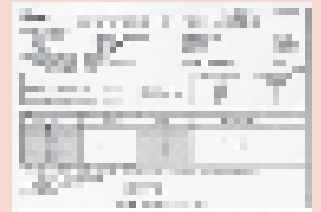

Certificate of inspection

## Technical Data

Accuracy: Refer to the list of specifications.  
Resolution: .00005"/0.001mm or 0.001mm (up to 4" models)  
.0001" / 0.001mm (over 4" models)  
Flatness: .000012"/0.3μm  
Parallelism: .00004"/1μm for models up to 2"/50mm  
.00008"/2μm for models up to 4"/100mm  
.00012"/3μm for models up to 7"/175mm  
.00016"/4μm for models up to 11"/275mm  
.0002"/5μm for models over 12"/300mm  
Measuring faces: Carbide tipped  
Display: LCD  
Battery: SR44 (1 pc.), **938882**  
Battery life: Approx. 2.4 years under normal use  
Dust/Water protection level: IP65

## Function

Origin-set, Zero / ABS, Hold, Auto power on/off,  
Data output (output models),  
inch/mm conversion (on inch/metric models only)  
Alarm: Low voltage, Counting value composition error

## Optional Accessories

- 05CZA662:** SPC cable with data switch (40"/1m)
- 05CZA663:** SPC cable with data switch (80"/2m)



SPC cable with data switch



## SPECIFICATIONS

**Metric** With ratchet stop

Range	Resolution	Order No.	Accuracy
0 - 25mm	0.001mm	<b>293-230-30 / 293-240-30*</b>	±1µm
25 - 50mm	0.001mm	<b>293-231-30 / 293-241-30*</b>	±1µm
50 - 75mm	0.001mm	<b>293-232-30 / 293-242-30*</b>	±1µm
75 - 100mm	0.001mm	<b>293-233-30 / 293-243-30*</b>	±2µm
100 - 125mm	0.001mm	<b>293-250-30</b>	±2µm
125 - 150mm	0.001mm	<b>293-251-30</b>	±2µm
150 - 175mm	0.001mm	<b>293-252-30</b>	±3µm
175 - 200mm	0.001mm	<b>293-253-30</b>	±3µm
200 - 225mm	0.001mm	<b>293-254-30</b>	±3µm
225 - 250mm	0.001mm	<b>293-255-30</b>	±4µm
250 - 275mm	0.001mm	<b>293-256-30</b>	±4µm
275 - 300mm	0.001mm	<b>293-257-30</b>	±4µm

\*without SPC data output

**Metric** With ratchet thimble

Range	Resolution	Order No.	Accuracy
0 - 25mm	0.001mm	<b>293-234-30 / 293-244-30*</b>	±1µm
25 - 50mm	0.001mm	<b>293-235-30 / 293-245-30*</b>	±1µm
50 - 75mm	0.001mm	<b>293-236-30 / 293-246-30*</b>	±1µm
75 - 100mm	0.001mm	<b>293-237-30 / 293-247-30*</b>	±2µm

\*without SPC data output

**Metric** Micrometer Set

Range	Order No.	Included in set
0-50mm (2pcs. Set)	<b>293-966-30</b>	293-230-30, 293-231-30, 25mm CERA block, plastic case
0-75mm (3pcs. Set)	<b>293-962-30</b>	293-230-30, 293-231-30, 293-232-30, 2 standard bars, plastic case
0-100mm (4pcs. Set)	<b>293-963-30</b>	293-230-30, 293-231-30, 293-232-30, 293-233-30, 3 standard bars, wooden box

**Inch/Metric** With ratchet stop

Range	Resolution	Order No.	Accuracy
0 - 1" / 0 - 25.4mm	.00005" / 0.001mm	<b>293-330-30 / 293-340-30*</b>	±.00005"
1" - 2" / 25.4 - 50.8mm	.00005" / 0.001mm	<b>293-331-30 / 293-341-30*</b>	±.00005"
2" - 3" / 50.8 - 76.2mm	.00005" / 0.001mm	<b>293-332-30 / 293-342-30*</b>	±.00005"
3" - 4" / 76.2 - 101.6mm	.00005" / 0.001mm	<b>293-333-30 / 293-343-30*</b>	±.0001"
4" - 5" / 101.6 - 127.0mm	.0001" / 0.001mm	<b>293-350-30</b>	±.0001"
5" - 6" / 127.0 - 152.4mm	.0001" / 0.001mm	<b>293-351-30</b>	±.0001"
6" - 7" / 152.4 - 177.8mm	.0001" / 0.001mm	<b>293-352-30</b>	±.00015"
7" - 8" / 177.8 - 203.2mm	.0001" / 0.001mm	<b>293-353-30</b>	±.00015"
8" - 9" / 203.2 - 228.6mm	.0001" / 0.001mm	<b>293-354-30</b>	±.00015"
9" - 10" / 228.6 - 254.0mm	.0001" / 0.001mm	<b>293-355-30</b>	±.0002"
10" - 11" / 254.0 - 279.4mm	.0001" / 0.001mm	<b>293-356-30</b>	±.0002"
11" - 12" / 279.4 - 304.8mm	.0001" / 0.001mm	<b>293-357-30</b>	±.0002"

\*without SPC data output

**Inch/Metric** With ratchet thimble

Range	Resolution	Order No.	Accuracy
0 - 1" / 0 - 25.4mm	.00005" / 0.001mm	<b>293-334-30 / 293-344-30*</b>	±.00005"
0 - 1" / 0 - 25.4mm	.0001" / 0.001mm	<b>293-349-30*</b>	±.0001"
1" - 2" / 25.4 - 50.8mm	.00005" / 0.001mm	<b>293-345-30*</b>	±.00005"
2" - 3" / 50.8 - 76.2mm	.00005" / 0.001mm	<b>293-346-30*</b>	±.00005"
3" - 4" / 76.2 - 101.6mm	.00005" / 0.001mm	<b>293-347-30*</b>	±.0001"

\*without SPC data output

**Inch/Metric** With friction thimble

Range	Resolution	Order No.	Accuracy
0 - 1" / 0 - 25.4mm	.00005" / 0.001mm	<b>293-335-30 / 293-348-30*</b>	±.00005"
1" - 2" / 25.4 - 50.8mm	.00005" / 0.001mm	<b>293-336-30</b>	±.00005"

\*without SPC data output

**Inch/Metric** Micrometer Set .00005" / 0.001mm graduation model

Range	Order No.	Included in set
0 - 3" / 0 - 76.2mm (3 pcs. set)	<b>293-960-30</b>	293-330-30, 293-331-30, 293-332-30, 2 standard bars, plastic case
0 - 4" / 0 - 101.6mm (4 pcs. set)	<b>293-961-30</b>	293-330-30, 293-331-30, 293-332-30, 293-333-30, 3 standard bars, wooden box

## DIMENSIONS AND MASS

Ratchet-stop type (up to 100mm/4")

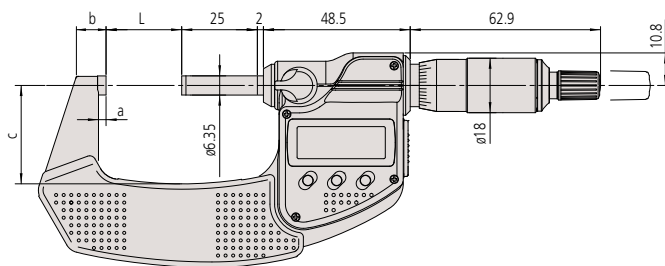

Ratchet-thimble type and friction-thimble type

Unit: mm

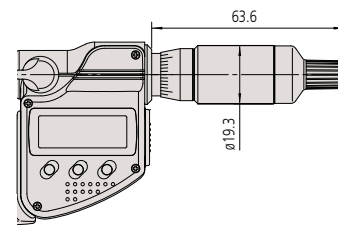

Ratchet stop type (over 100mm/4" to 300mm/12")

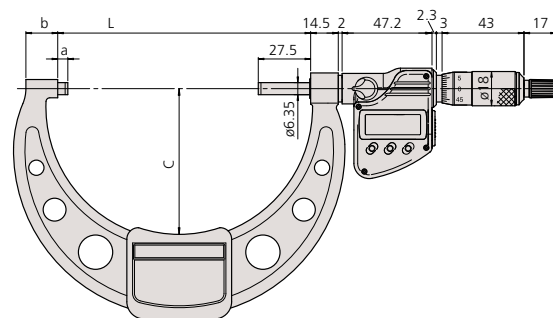

Range (Metric / Inch)	L	a	b	c	Mass (g)
0 - 25mm / 0-1"	0	2.5	9	(25)	270
25 - 50mm / 1-2"	25	2.5	9.8	(32.5)	330
50 - 75mm / 2-3"	50	2.5	12.6	(47)	470
75 - 100mm / 3-4"	75	2.5	14	(60)	625
100 - 125mm / 4-5"	132.8	5.3	16.7	(76.5)	600
125 - 150mm / 5-6"	158.2	5.7	18.8	(91)	740
150 - 175mm / 6-7"	183.6	6.1	19.1	(103.1)	800
175 - 200mm / 7-8"	208.8	6.3	18.2	(115.3)	970
200 - 225mm / 8-9"	234.2	6.7	16.8	(126.8)	1100
225 - 250mm / 9-10"	258	5.5	18	(139.8)	1270
250 - 275mm / 10-11"	284	18	28	(152.3)	1340
275 - 300mm / 11-12"	309	18	28	(166)	1540

# Digimatic Micrometer

**SERIES 293**



293-582

## DIMENSIONS

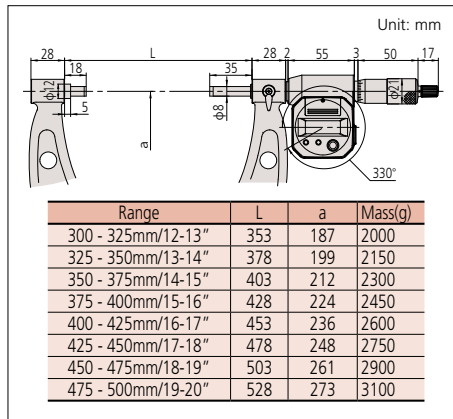

## SPECIFICATIONS

Metric  With ratchet stop			
Range	Resolution	Order No.	Accuracy
300 - 325mm	0.001mm	<b>293-582</b>	±6μm
325 - 350mm	0.001mm	<b>293-583</b>	±6μm
350 - 375mm	0.001mm	<b>293-584</b>	±6μm
375 - 400mm	0.001mm	<b>293-585</b>	±7μm
400 - 425mm	0.001mm	<b>293-586</b>	±7μm
425 - 450mm	0.001mm	<b>293-587</b>	±7μm
450 - 475mm	0.001mm	<b>293-588</b>	±8μm
475 - 500mm	0.001mm	<b>293-589</b>	±8μm

Inch/Metric  With ratchet stop			
Range	Resolution	Order No.	Accuracy
12" - 13" / 304.8 - 330.2mm	.0001" / 0.001mm	<b>293-782</b>	±.0003"
13" - 14" / 330.2 - 355.6mm	.0001" / 0.001mm	<b>293-783</b>	±.0003"
14" - 15" / 355.6 - 381.0mm	.0001" / 0.001mm	<b>293-784</b>	±.0003"
15" - 16" / 381.0 - 406.4mm	.0001" / 0.001mm	<b>293-785</b>	±.00035"
16" - 17" / 406.4 - 431.8mm	.0001" / 0.001mm	<b>293-786</b>	±.00035"
17" - 18" / 431.8 - 457.2mm	.0001" / 0.001mm	<b>293-787</b>	±.00035"
18" - 19" / 457.2 - 482.6mm	.0001" / 0.001mm	<b>293-788</b>	±.0004"
19" - 20" / 482.6 - 508.0mm	.0001" / 0.001mm	<b>293-789</b>	±.0004"

## Technical Data

Accuracy: Refer to the list of specifications.  
 Resolution: .0001"/0.001mm or 0.001mm  
 Flatness: .000024" / 0.6μm  
 Parallelism: .0002"/5μm for models up to 15"/375mm  
 .00024"/6μm for models up to 19"/475mm  
 .00028"/7μm for models over 20"/500mm  
 Measuring faces: Carbide tipped  
 Display: LCD  
 Battery: SR44 (2 pcs.), **938882**  
 Battery life: Approx. 1.8 years under normal use

## Function

Preset, Zero-setting, Power ON/OFF, Data hold, Data output, inch/mm conversion (on inch/metric models only)  
 Alarm: Low voltage, Counting value composition error

## Optional Accessories

**959149:** SPC cable (40"/1m) Straight type  
**959150:** SPC cable (80"/2m) Straight type  
**04AZB512:** SPC cable L-type (40"/1m)  
**04AZB513:** SPC cable L-type (80"/2m)



# Digimatic Micrometer

**SERIES 293 MDC-Lite**

## FEATURES

- Provided only with zero set and in/mm (inch/metric models only) keys.
- A ratchet stop or friction thimble for a constant measuring force.
- Measurement readout with large characters on the LCD.
- No spindle clamp. No data output.
- Supplied in fitted plastic case.



293-831-30



## SPECIFICATIONS

Metric  With ratchet stop			
Range	Resolution	Order No.	Accuracy
0 - 25mm	0.001mm	<b>293-821-30</b>	±2μm

Inch/Metric  With ratchet stop			
Range	Resolution	Order No.	Accuracy
0 - 1" / 0 - 25.4mm	.00005" / 0.001mm	<b>293-831-30</b>	±.0001"

Inch/Metric  With friction thimble			
Range	Resolution	Order No.	Accuracy
0 - 1" / 0 - 25.4mm	.00005" / 0.001mm	<b>293-832-30</b>	±.0001"

## Technical Data

Accuracy: Refer to the list of specifications  
 Resolution: .00005"/0.001mm or 0.001mm  
 Flatness: .000012" / 0.3μm  
 Parallelism: .00008" / 2μm  
 Measuring faces: Carbide tipped  
 Display: LCD  
 Battery: SR44 (1 pc.), **938882**  
 Battery life: Approx. 2.4 years under normal use

## Function

Origin-set, Automatic power on/off, inch/mm conversion (on inch/metric models only)  
 Alarm: Low voltage, Counting value composition error

## DIMENSIONS AND MASS

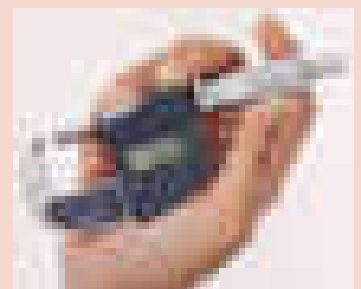
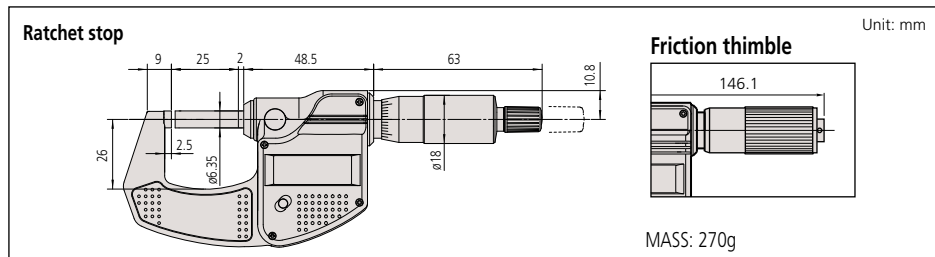

# MDH Micrometer

## SERIES 293 — High-Accuracy Sub-Micron Digimatic Micrometer

### Technical Data

Flatness: 0.3µm/0.00012"  
 Parallelism: 0.6µm/0.00024"  
 Measuring force: 7 to 9N

### Functions

Preset (ABS measurement system)  
 Zero-setting (INC measurement system)  
 Hold, Resolution switching, Function lock, On/off, Auto power off, Measurement data output, Error alarm

### Optional Accessories

**05CZA662:** SPC cable with data switch (1m/40")  
**05CZA663:** SPC cable with data switch (2m/80")

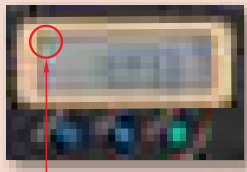

Function lock

Heat shield

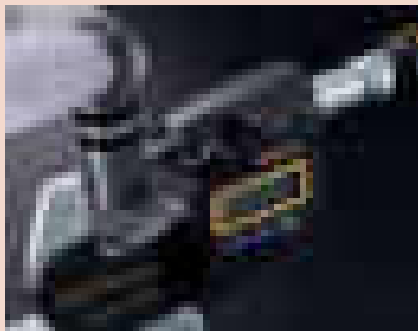

### FEATURES

- Enabling .000005"/0.1µm resolution measurement, this micrometer is ideal for customers who need to make highly accurate measurements with a handheld tool.
- A highly rigid frame and high-performance constant-force mechanism\* enable more stable measurements, while the clicks emitted while the workpiece is being measured assure the operator that measurement is proceeding normally.

\* Patent pending in Japan, the United States of America, the European Union and China.

- Body heat transferred to the instrument is reduced by a (removable) heat shield, minimizing the error caused by thermal expansion of the frame when performing handheld measurements.
- The ABS (absolute) rotary sensor also eliminates the need to perform origin setting each time the power is turned on, letting you start measuring right away. With no possibility of overspeed errors, the High-Accuracy Digimatic Micrometer also delivers a high level of reliability.



293-130-10



"d2" is the name for Mitutoyo Digimatic output compatible with up to 8 digits of I/O data.

### SPECIFICATIONS

#### Metric

Order No.	Range	Resolution	Accuracy	Measuring surface	Mass
293-100-10	0 - 25mm	0.0001mm/ 0.0005mm (switchable)	±0.5µm	ø3.2mm	400g (440g w/Heat shield)

#### Inch/Metric

Order No.	Range	Resolution	Accuracy	Measuring surface	Mass
293-130-10	0 - 1" / 0 - 25.4mm	.000005"/.00002" / 0.0001mm/0.0005mm (switchable)	±.00002"	ø3.2mm	400g (440g w/Heat shield)

### DIMENSIONS

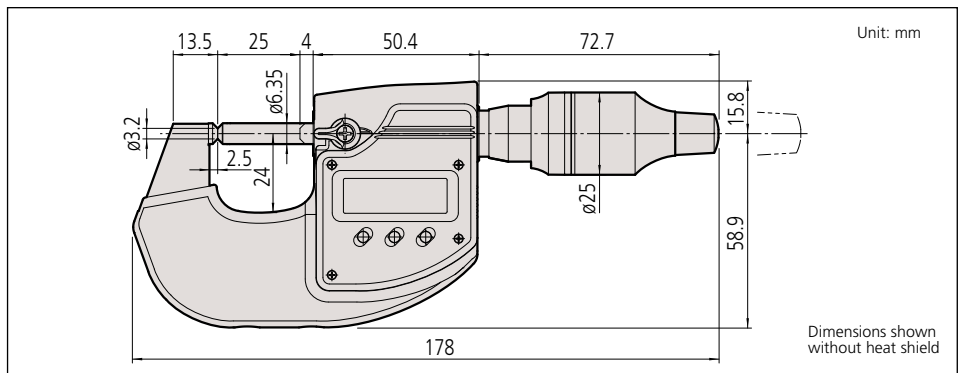

# QuantuMike

## SERIES 293 — Coolant-proof Micrometer

### FEATURES

- Faster measurement with 2mm per revolution instead of the standard 0.5mm.
- A patented ratchet thimble mechanism helps ensure repeatability.
- A function lock helps prevent error.
- IP-65 protection level.
- Certificate of inspection provided.
- With a standard bar except for 0-25mm/0-1" model.
- Supplied in fitted plastic case.



### SPECIFICATIONS

Metric			
Range	Resolution	Order No.	Accuracy
0-25mm	0.001mm	<b>293-140-30</b>	1µm
0-25mm	0.001mm	<b>293-145-30*</b>	1µm
25-50mm	0.001mm	<b>293-141-30</b>	1µm
25-50mm	0.001mm	<b>293-146-30*</b>	1µm
50-75mm	0.001mm	<b>293-142-30</b>	2µm
50-75mm	0.001mm	<b>293-147-30*</b>	2µm
75-100mm	0.001mm	<b>293-143-30</b>	2µm
75-100mm	0.001mm	<b>293-148-30*</b>	2µm

\* without SPC data output

Inch/Metric			
Range	Resolution	Order No.	Accuracy
0-1"/0 - 25.4mm	.00005"/0.001mm	<b>293-180-30</b>	.00005"
0-1"/0 - 25.4mm	.00005"/0.001mm	<b>293-185-30*</b>	.00005"
1-2"/25.4 - 50.8mm	.00005"/0.001mm	<b>293-181-30</b>	.00005"
1-2"/25.4 - 50.8mm	.00005"/0.001mm	<b>293-186-30*</b>	.00005"
2-3"/50.8 - 76.2mm	.00005"/0.001mm	<b>293-182-30</b>	.0001"
2-3"/50.8 - 76.2mm	.00005"/0.001mm	<b>293-187-30*</b>	.0001"
3-4"/76.2 - 101.6mm	.00005"/0.001mm	<b>293-183-30</b>	.0001"
3-4"/76.2 - 101.6mm	.00005"/0.001mm	<b>293-188-30*</b>	.0001"

\* without SPC data output

### DIMENSIONS AND MASS

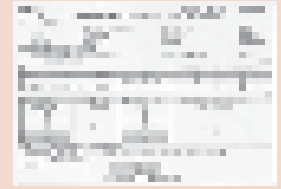
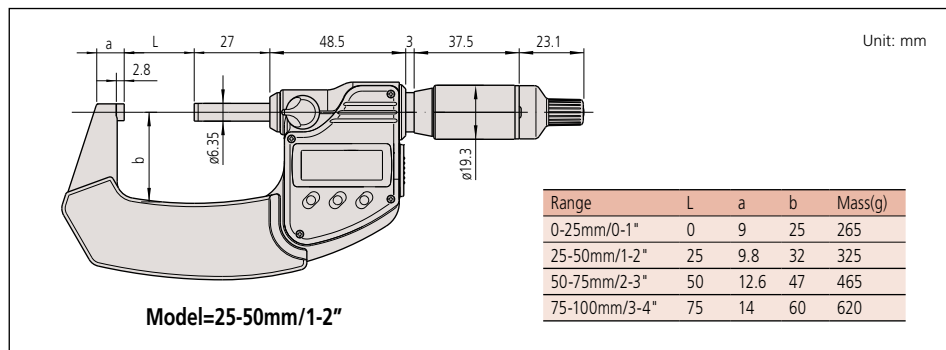

Certificate of inspection provided for 0-1" and 1-2" models only.

### Technical Data

Accuracy: Refer to the list of specifications  
 Resolution: 0.001mm or .00005"/0.001mm  
 Flatness: 0.3µm/.000012"  
 Parallelism: 1µm/.00004" for models up to 50mm/2"  
 2µm/.00008" for models up to 100mm/4"  
 Measuring force: 7-12N  
 Measuring faces: Carbide tipped  
 Display: LCD  
 Battery: SR44 (1 pc.), **938882**  
 Battery life: Approx. 2.4 years under normal use  
 Dust/Water protection level: IP65

### Function

Origin-set, Zero / ABS, Hold, Function lock, Auto power on/off, Data output (output models), inch/mm conversion (on inch/metric models only)  
 Alarm: Low voltage, Counting value composition error

### Optional Accessories

- 05CZA662:** SPC cable with data switch (1m/40")
- 05CZA663:** SPC cable with data switch (2m/80")



**516-529-26** Inspection Gage Block Set  
 Rectangular Steel Gage Block  
 10 pc. blocks and 1 pc. optical parallel

**516-319-26** Inspection Gage Block Set  
 Rectangular Cera Gage Block  
 10 pc. blocks and 1 pc. optical parallel

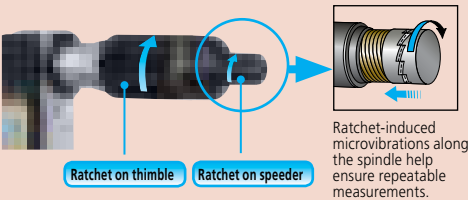

### Significant reduction in positioning time

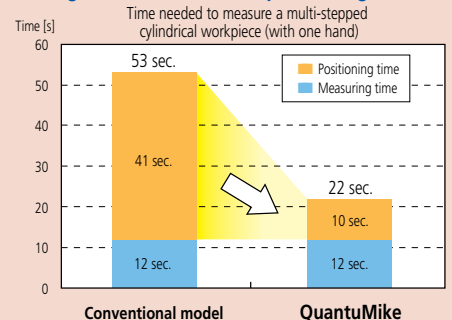



# ABSOLUTE Digimatic Micrometers

## SERIES 227 — with Adjustable Measuring Force

### Technical Data

Accuracy: Refer to the list of specifications  
 Resolution: .00005"/0.001mm or 0.001mm  
 Flatness: .000012" / 0.3µm  
 Parallelism: .00008" / 2µm  
 Accuracy of selected measuring force:  
 ± (0.1+selected measuring force/10)N  
 for 0.5-2.5N models  
 ± (0.4+selected measuring force/10)N  
 for 2-10N models

Measuring faces: Carbide tipped  
 Display: LCD  
 Battery: SR44 (1 pc.), **938882**  
 Battery life: Approx. 3 years under normal use  
 (1 year for .6 - 1.2" / 15-30mm, .4 - .8" /  
 10-20mm, .8-1.2" / 20-30mm range model)

### Function

Origin, Hold / Data, ON/OFF, Zero / ABS,  
 inch/mm conversion (on inch/metric models only)  
 Alarm: Low voltage, Counting value composition error

### Optional Accessories

**937387:** SPC cable (40" / 1m)  
**965013:** SPC cable (80" / 2m)

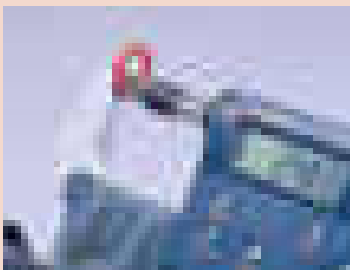
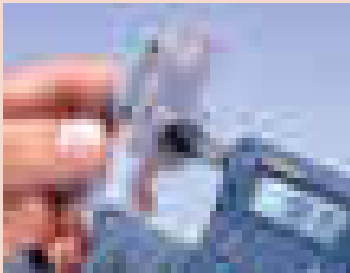

### FEATURES

- Constant and low measuring force mechanism in the thimble.
- Adjustable measuring force\* accommodates various types of work materials.  
 \*0.5-2.5N or 2-10N
- The measurement-value hold function automatically retains the data at a specified measuring force, ensuring accuracy.
- Non-rotating spindle and the new ratchet friction thimble.
- Speedy spindle feed by .4"/rev and 10mm/rev for inch/metric model.
- With absolute linear scale.
- With SPC data output.
- With a standard bar to set the origin point (except for 0-15mm, 0-10mm, 0-.6", and 0-.4" models).
- Supplied in fitted plastic case.



227-201

### SPECIFICATIONS

#### Metric

Order No.	Range	Resolution	Accuracy	Measuring Force	Mass(g)
<b>227-201</b>	0-15mm	0.001mm	±2µm	0.5-2.5 (0.5, 1.0, 1.5, 2, 2.5) N	300
<b>227-203</b>	15-30mm	0.001mm	±2µm	0.5-2.5 (0.5, 1.0, 1.5, 2, 2.5) N	380
<b>227-205</b>	0-10mm	0.001mm	±2µm	2-10 (2, 4, 6, 8, 10) N	340
<b>227-206</b>	10-20mm	0.001mm	±2µm	2-10 (2, 4, 6, 8, 10) N	425
<b>227-207</b>	20-30mm	0.001mm	±2µm	2-10 (2, 4, 6, 8, 10) N	415

#### Inch/Metric

Order No.	Range	Resolution	Accuracy	Measuring Force	Mass(g)
<b>227-211</b>	0-.6"	.00005"/0.001mm	±.0001"	0.5-2.5 (0.5, 1.0, 1.5, 2, 2.5) N	300
<b>227-213</b>	.6-1.2"	.00005"/0.001mm	±.0001"	0.5-2.5 (0.5, 1.0, 1.5, 2, 2.5) N	380
<b>227-215</b>	0-.4"	.00005"/0.001mm	±.0001"	2-10 (2, 4, 6, 8, 10) N	340
<b>227-216</b>	.4-.8"	.00005"/0.001mm	±.0001"	2-10 (2, 4, 6, 8, 10) N	425
<b>227-217</b>	.8-1.2"	.00005"/0.001mm	±.0001"	2-10 (2, 4, 6, 8, 10) N	415

### DIMENSIONS AND MASS

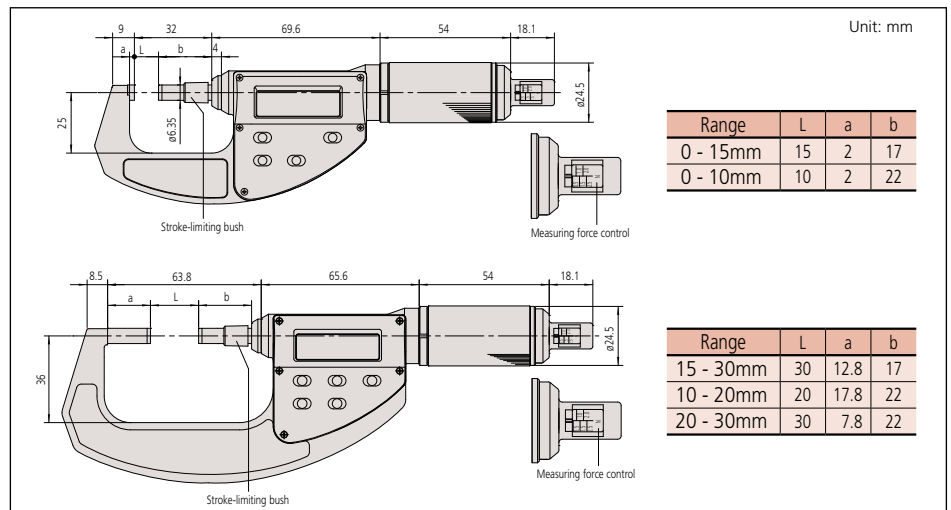

# Quickmike

## SERIES 293 — IP-54 ABSOLUTE Digimatic Micrometers

The Quickmike provides a speedy spindle feed of 10mm / .4" per thimble rotation as compared to the conventional micrometer with 0.5mm / .025" per rotation. Its wide 30mm / 1.2" measuring range allows various workpieces with different shapes to be measured quickly.

### FEATURES

- Non-rotating spindle and the new ratchet friction thimble.
- Speedy spindle feed by 10mm/rev and .4"/rev for inch/metric models.
- With absolute linear scale.
- IP54 dust/water protection (when not connected with data output cable).
- With SPC data output.
- With a standard bar to set the origin point (for models with a range over 30mm / 1.2").
- Supplied in fitted plastic case.



293-676



293-677



293-678



293-679

### SPECIFICATIONS

Metric			
Range	Resolution	Order No.	Accuracy
0 - 30mm	0.001mm	293-666	±2μm
25 - 55mm	0.001mm	293-667	±2μm
50 - 80mm	0.001mm	293-668	±3μm
75 - 105mm	0.001mm	293-669	±3μm

Inch/Metric			
Range	Resolution	Order No.	Accuracy
0 - 1.2" / 0 - 30.48mm	.00005" / 0.001mm	293-676	±.0001"
1" - 2.2" / 25.4 - 55.88mm	.00005" / 0.001mm	293-677	±.0001"
2" - 3.2" / 50.8 - 81.28mm	.00005" / 0.001mm	293-678	±.00015"
3" - 4.2" / 76.2 - 106.68mm	.00005" / 0.001mm	293-679	±.00015"

### DIMENSIONS AND MASS

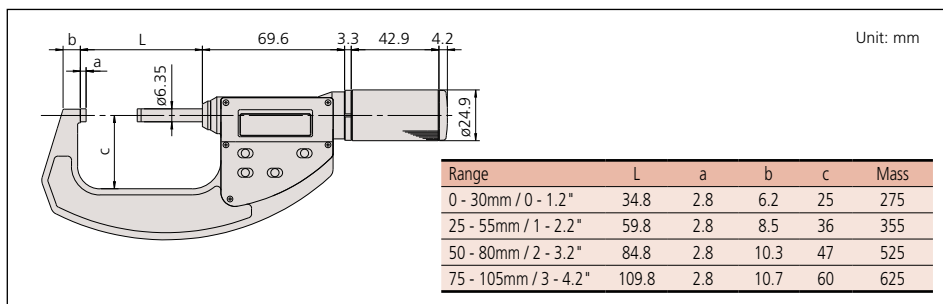

### Technical Data

Accuracy: Refer to the list of specifications  
 Resolution: 0.001mm or .00005"/0.001mm  
 Flatness: 0.3μm / .000012"  
 Parallelism: 2μm / .00008" for models up to 80mm / 3.2"  
 3μm / .00012" for models up to 105mm / 4.2"  
 Measuring force: 5-10N  
 Measuring faces: Carbide tipped  
 Display: LCD  
 Battery: SR44 (1 pc.), 938882  
 Battery life: Approx. 3 years under normal use  
 (1 year for models over 30mm / 1.2")  
 Dust/Water protection level: IP54

### Function

Origin, Hold / Data, ON/OFF, Zero / ABS,  
 inch/mm conversion (on inch/metric models only)  
 Alarm: Low voltage, Counting value composition error

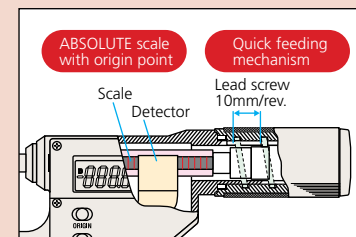

### Optional Accessories

- 937387: SPC cable (1m / 40")
- 965013: SPC cable (2m / 80")

# Outside Micrometers

## SERIES 101

### Technical Data

Graduation: .0001"  
 Flatness: .000024"  
 Parallelism: .00008" for models up to 3"  
 .00012" for models over 3"  
 Measuring faces: Carbide tipped

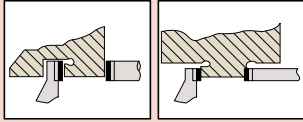

### FEATURES

- Satin chrome-finished frame, tapered (on the anvil side) for hard-to-reach places.
- With a standard bar except for 0 - 1" models.
- Supplied in fitted plastic case.

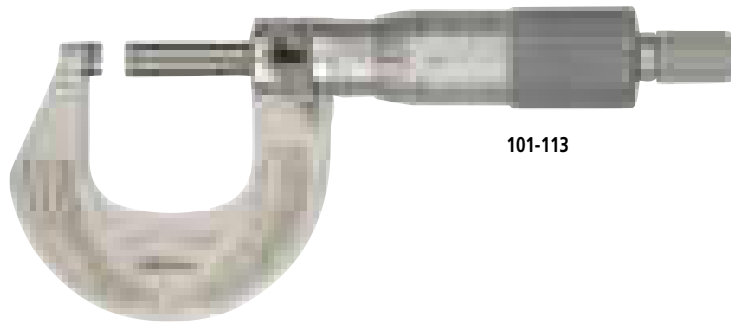

101-113

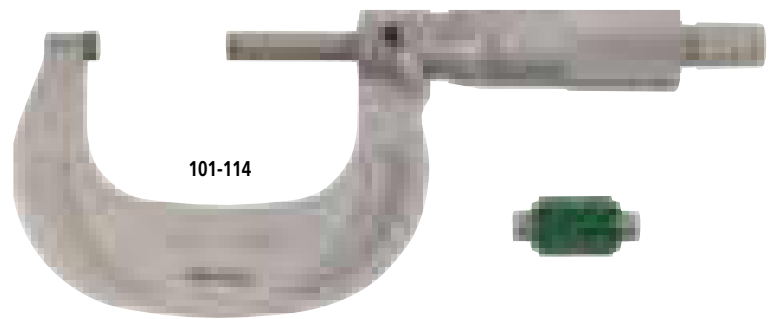

101-114

### SPECIFICATIONS

Inch		With friction thimble		
Range	Graduation	Order No.	Accuracy	Mass (g)
0 - 1"	.0001"	<b>101-117*</b>	±.0001"	180
1 - 2"	.0001"	<b>101-118*</b>	±.0001"	245

\*.0001" reading is obtained with vernier.

Inch		With ratchet stop		
Range	Graduation	Order No.	Accuracy	Mass (g)
0 - 1"	.0001"	<b>101-113*</b>	±.0001"	180
1 - 2"	.0001"	<b>101-114*</b>	±.0001"	245
2 - 3"	.0001"	<b>101-119*</b>	±.0001"	410
3 - 4"	.0001"	<b>101-120*</b>	±.00015"	550

\*.0001" reading is obtained with vernier.

### DIMENSIONS

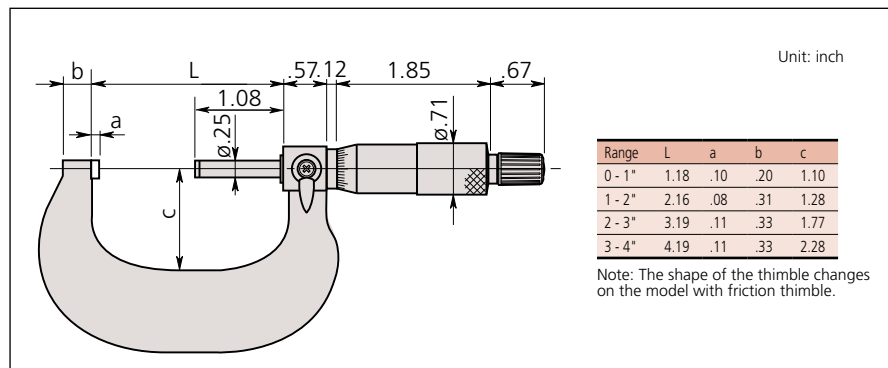

# Ratchet Thimble Micrometer

**SERIES 102 — New smoother action ratchet thimble**

## FEATURES

- Ratchet function works both from the thimble and the speeder, allowing easy one-handed operation.
- Clearly audible ratchet operation for reassurance that measurement is being performed at constant, preset force.
- Heat insulating frame minimizes thermal expansion.
- Provided with a Certificate of Inspection.
- With a standard bar except for 0 - 25mm and 0 - 1" models.
- Supplied in fitted plastic case.

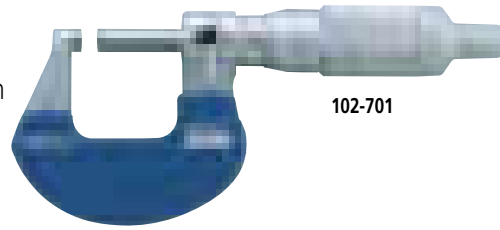

## Technical Data

Graduation: 0.01mm, 0.001mm, .001" or .0001"  
 Flatness: 0.6µm / .000024"  
 Parallelism: 2µm / .00008"  
 Measuring faces: Carbide tipped  
 Measuring force: 5-10N

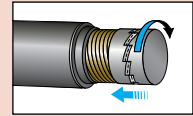

Rotating the thimble/speeder when the workpiece is between the anvil and spindle causes the ratchet mechanism to tap the spindle and apply a constant measuring force to the workpiece.

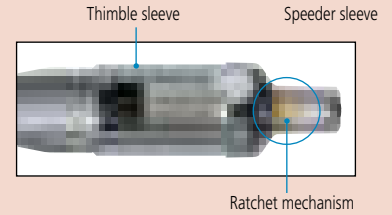

## SPECIFICATIONS

Metric			
Range	Graduation	Order No.	Accuracy
0 - 25mm	0.01mm	<b>102-701</b>	±2µm
0 - 25mm	0.001mm	<b>102-707*</b>	±2µm
25 - 50mm	0.01mm	<b>102-702</b>	±2µm
25 - 50mm	0.001mm	<b>102-708*</b>	±2µm

Inch			
Range	Graduation	Order No.	Accuracy
0 - 1"	.0001"	<b>102-717*</b>	±.0001"
1 - 2"	.0001"	<b>102-718*</b>	±.0001"

\*.0001" reading is obtained with vernier.

\*0.001mm reading is obtained with vernier.

## DIMENSIONS AND MASS

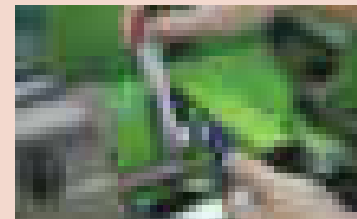
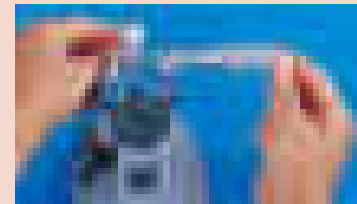
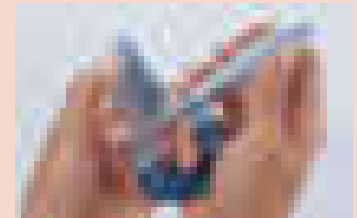
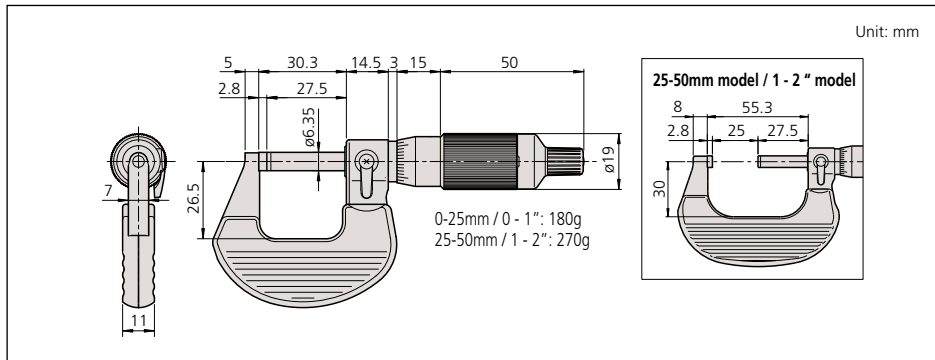





# Outside Micrometers

## SERIES 102

### FEATURES

- Heat-insulated frame, tapered (on the anvil side) for hard-to-reach places.
- With a standard bar except for 0 - 25mm model.
- A ratchet stop for a constant measuring force.
- Supplied in a fitted plastic case.

### Technical Data

Graduation: 0.01mm  
 Flatness: 0.3 $\mu$ m  
 Parallelism: 1 $\mu$ m for 25mm model  
                   3 $\mu$ m for models up to 100mm  
 Measuring faces: Carbide tipped

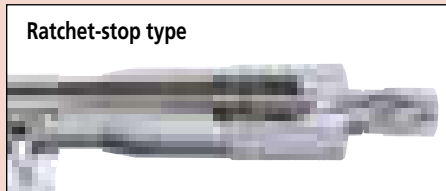

102-301

### SPECIFICATIONS

Metric — With ratchet stop			
Range	Graduation	Order No.	Accuracy
0 - 25mm	0.01mm	<b>102-301</b>	$\pm 2\mu$ m
25 - 50mm	0.01mm	<b>102-302</b>	$\pm 2\mu$ m
50 - 75mm	0.01mm	<b>102-303</b>	$\pm 2\mu$ m
75 - 100mm	0.01mm	<b>102-304</b>	$\pm 3\mu$ m

Metric — Micrometer set 0.01mm Graduation model		
Range	Order No.	Included in set
0 - 100mm (4 pcs/set)	<b>102-911-40</b>	<ul style="list-style-type: none"> <li>• <b>102-301</b></li> <li>• <b>102-302</b></li> <li>• <b>102-303</b></li> <li>• <b>102-304</b></li> <li>• 3 micrometer standards</li> </ul>

### DIMENSIONS AND MASS

Unit: mm

Range	L	a	b	c	d	Mass (g)
0 - 25mm	30.3	2.8	5	26	6.35	180
25 - 50mm	55.3	2.8	8	32	6.35	270
50 - 75mm	80.3	2.8	9	45	6.35	375
75 - 100mm	105.3	2.8	10	58	6.35	490

# Outside Micrometers

## SERIES 103



### FEATURES

- Hammertone, baked-enamel-finished frame.
- Ratchet stop for exact repetitive readings.
- With a standard bar except for 0-25mm model.

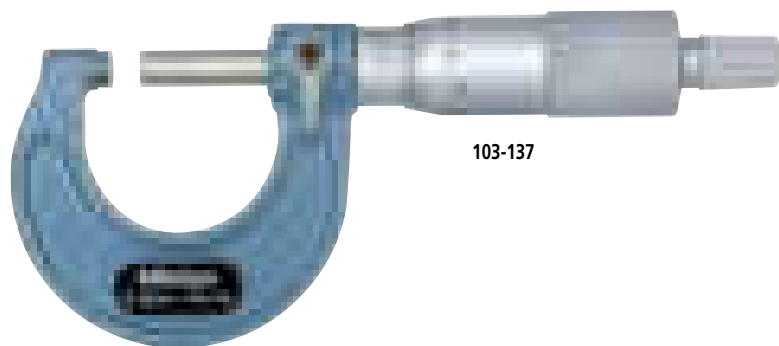

103-137

### Technical Data

Graduation: 0.01mm, 0.001mm  
 Flatness: 0.6 μm for models up to 300mm/12"  
 1 μm for models over 300mm/12"  
 Parallelism: (2+R/100)μm, R=max. range (mm)  
 Measuring faces: Carbide tipped

### SPECIFICATIONS

**Metric** With ratchet stop

Range	Order No.	Accuracy	Mass (g)
0 - 25mm	103-137	±2μm	175
	103-129*	±2μm	175
25 - 50mm	103-138	±2μm	215
	103-130*	±2μm	215
50 - 75mm	103-139-10	±2μm	315
75 - 100mm	103-140-10	±3μm	375
100 - 125mm	103-141-10	±3μm	515
125 - 150mm	103-142-10	±3μm	665
150 - 175mm	103-143-10	±4μm	720
175 - 200mm	103-144-10	±4μm	920
200 - 225mm	103-145-10	±4μm	1080
225 - 250mm	103-146-10	±5μm	1255
250 - 275mm	103-147-10	±5μm	1405
275 - 300mm	103-148-10	±5μm	1565
300 - 325mm	103-149	±6μm	1985
325 - 350mm	103-150	±6μm	2155
350 - 375mm	103-151	±6μm	2305
375 - 400mm	103-152	±7μm	2455
400 - 425mm	103-153	±7μm	2715
425 - 450mm	103-154	±7μm	2965
450 - 475mm	103-155	±8μm	3215
475 - 500mm	103-156	±8μm	3450

(Models with a range up to 1000mm are available.)

\*0.001mm reading is obtained with vernier.

### DIMENSIONS AND MASS

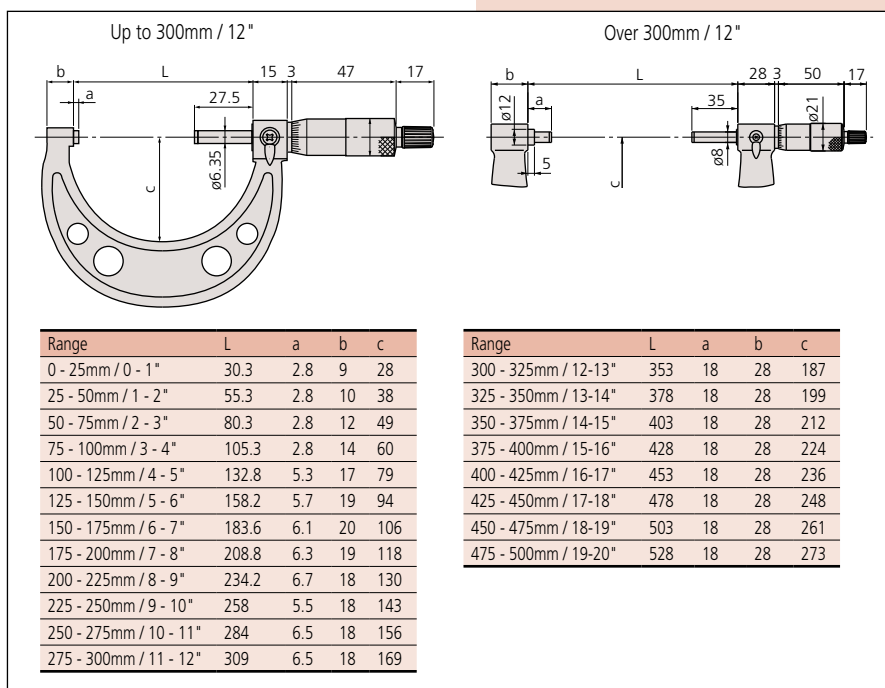

**Metric** Micrometer set

Range	Order No.	Included in set	Mass (g)
0 - 75mm (3 pc. set)	103-927-10	103-137, 103-138, 103-139-10, 2 micrometer standards	750
0 - 150mm (6 pc. set)	103-913-50	103-137, 103-138, 103-139-10, 103-140-10, 103-141-10, 103-142-10, 5 micrometer standards	2260
150 - 300mm (6 pc. set)	103-915-10	103-143-10, 103-144-10, 103-145-10, 103-146-10, 103-147-10, 103-148-10, 6 micrometer standards	7695
0 - 300mm (12 pc. set)	103-914-50	All micrometers of 103-913-50 and 103-915-10 in one set, 11 micrometer standards	9300



# Outside Micrometers

## SERIES 103— Inch Models

### FEATURES

- Hammertone, baked-enamel-finished frame.
- Ratchet stop or friction thimble for exact repetitive readings.
- With a standard bar except for 0-1" model.



103-177



103-260

### Technical Data (Inch Model)

Accuracy: Refer to the list of specifications

Graduation: .001" or .0001"

Flatness: .000024" for models up to 12"  
.00004" for models over 12"

Parallelism: [.00008 + .00004 (L/4)]" L= max range (inch)

Measuring faces: Carbide tipped

### SPECIFICATIONS

**Inch** \_\_\_\_\_ With ratchet stop

Range	Graduation	Order No.	Accuracy	Mass (g)
0 - 1"	.001"	<b>103-177</b>	±.0001"	175
1 - 2"	.001"	<b>103-178</b>	±.0001"	215
2 - 3"	.001"	<b>103-179</b>	±.0001"	315
3 - 4"	.001"	<b>103-180</b>	±.00015"	375
4 - 5"	.001"	<b>103-181</b>	±.00015"	515
5 - 6"	.001"	<b>103-182</b>	±.00015"	665
6 - 7"	.001"	<b>103-183</b>	±.0002"	720
7 - 8"	.001"	<b>103-184</b>	±.0002"	920
8 - 9"	.001"	<b>103-185</b>	±.0002"	1080
9 - 10"	.001"	<b>103-186</b>	±.00025"	1255
10 - 11"	.001"	<b>103-187</b>	±.00025"	1405
11 - 12"	.001"	<b>103-188</b>	±.00025"	1565
12 - 13"	.001"	<b>103-189</b>	±.0003"	1985
13 - 14"	.001"	<b>103-190</b>	±.0003"	2155
14 - 15"	.001"	<b>103-191</b>	±.0003"	2305
15 - 16"	.001"	<b>103-192</b>	±.00035"	2455
16 - 17"	.001"	<b>103-193</b>	±.00035"	2715
17 - 18"	.001"	<b>103-194</b>	±.00035"	2965
18 - 19"	.001"	<b>103-195</b>	±.0004"	3215
19 - 20"	.001"	<b>103-196</b>	±.0004"	3450
20 - 21"	.001"	<b>103-197</b>	±.0004"	4060
21 - 22"	.001"	<b>103-198</b>	±.00045"	4080
22 - 23"	.001"	<b>103-199</b>	±.00045"	4500
23 - 24"	.001"	<b>103-200</b>	±.00045"	4525
24 - 25"	.001"	<b>103-201</b>	±.0005"	4915
25 - 26"	.001"	<b>103-202</b>	±.0005"	4930
26 - 27"	.001"	<b>103-203</b>	±.0005"	5200
27 - 28"	.001"	<b>103-204</b>	±.00055"	5215
28 - 29"	.001"	<b>103-205</b>	±.00055"	5835
29 - 30"	.001"	<b>103-206</b>	±.00055"	5860
30 - 31"	.001"	<b>103-207</b>	±.0006"	6385
31 - 32"	.001"	<b>103-208</b>	±.0006"	6410
32 - 33"	.001"	<b>103-209</b>	±.0006"	6925
33 - 34"	.001"	<b>103-210</b>	±.00065"	6940
34 - 35"	.001"	<b>103-211</b>	±.00065"	7565
35 - 36"	.001"	<b>103-212</b>	±.00065"	7590
36 - 37"	.001"	<b>103-213</b>	±.0007"	8215
37 - 38"	.001"	<b>103-214</b>	±.0007"	8240
38 - 39"	.001"	<b>103-215</b>	±.0007"	8860
39 - 40"	.001"	<b>103-216</b>	±.00075"	8880

**Inch** \_\_\_\_\_ With friction thimble

Range	Graduation	Order No.	Accuracy	Mass (g)
0 - 1"	.0001"	<b>103-135*</b>	±.0001"	175
1 - 2"	.0001"	<b>103-136*</b>	±.0001"	215

\* .0001" Reading is obtained with vernier

**Inch** \_\_\_\_\_ With ratchet stop

Range	Graduation	Order No.	Accuracy	Mass (g)
0 - 1"	.0001"	<b>103-131*</b>	±.0001"	175
1 - 2"	.0001"	<b>103-132*</b>	±.0001"	215
2 - 3"	.0001"	<b>103-217*</b>	±.0001"	315
3 - 4"	.0001"	<b>103-218*</b>	±.00015"	375
4 - 5"	.0001"	<b>103-219*</b>	±.00015"	515
5 - 6"	.0001"	<b>103-220*</b>	±.00015"	665
6 - 7"	.0001"	<b>103-221*</b>	±.0002"	720
7 - 8"	.0001"	<b>103-222*</b>	±.0002"	920
8 - 9"	.0001"	<b>103-223*</b>	±.0002"	1080
9 - 10"	.0001"	<b>103-224*</b>	±.00025"	1255
10 - 11"	.0001"	<b>103-225*</b>	±.00025"	1405
11 - 12"	.0001"	<b>103-226*</b>	±.00025"	1565

\* .0001" Reading is obtained with vernier

**Inch** \_\_\_\_\_ With Tapered Frame and Ratchet Stop

Range	Graduation	Order No.	Accuracy	Mass (g)
0-1"	.001"	<b>103-259</b>	±.0001"	175
0-1"	.0001"	<b>103-260*</b>	±.0001"	175
1-2"	.0001"	<b>103-262*</b>	±.0001"	215

\* .0001" Reading is obtained with vernier

# Outside Micrometers

## SERIES 103 — Inch model set

Inch		Micrometer Set .001" Graduation Model	
Range	Order No.	Included in set	Mass (g)
0 - 3" (3pcs./set)	<b>103-929</b>	103-177, 103-178, 103-179, 2 Micrometer Standards	750
0 - 4" (4pcs./set)	<b>103-930</b>	103-177, 103-178, 103-179, 103-180, 3 Micrometer Standards	1600
0 - 6" (6pcs./set)	<b>103-904-10</b>	103-177, 103-178, 103-179, 103-180, 103-181, 103-182, 5 Micrometer Standards	2200
0 - 12" (12pcs./set)	<b>103-905-10</b>	103-177, 103-178, 103-179, 103-180, 103-181, 103-182, 103-183, 103-184, 103-185, 103-186, 103-187, 103-188, 11 Micrometer Standards	9000
6 - 12" (6pcs./set)	<b>103-906</b>	103-183, 103-184, 103-185, 103-186, 103-187, 103-188, 6 Micrometer Standards	7695



103-905-10

Inch		Micrometer Set .0001" Graduation Model	
Range	Order No.	Included in set	Mass (g)
0 - 3" (3pcs./set)	<b>103-922</b>	103-135, 103-136, 103-217, 2pcs. Micrometer Standards	705
0 - 4" (4pcs./set)	<b>103-931</b>	103-135, 103-136, 103-217, 103-218, 3pcs. Micrometer Standards	1600
0 - 6" (6pcs./set)	<b>103-907-40</b>	103-135, 103-136, 103-217, 103-218, 103-219, 103-220, 5 Micrometer Standards	2200
0 - 12" (12pcs./set)	<b>103-908-40</b>	103-135, 103-136, 103-217, 103-218, 103-219, 103-220, 103-221, 103-222, 103-223, 103-224, 103-225, 103-226, 11pcs. Micrometer Standards	9000
6 - 12" (6pcs./set)	<b>103-909</b>	103-221, 103-222, 103-223, 103-224, 103-225, 103-226, 6pcs. Micrometer Standards	6945



103-904-10



# Outside Micrometers

## SERIES 340, 104 — with Interchangeable Anvils, Inch model

### FEATURES

- IP65 water/dust protection (Series 340\*).  
\*Models with a range up to 12" / 300mm.
- Wide measuring range with interchangeable anvils.
- With a ratchet stop for constant force.
- Supplied with zero-setting standards bar for each range.
- With SPC output (Series 340).
- Supplied in fitted wooden case.

### Technical Data

Accuracy:  $\pm[.00016" + .00004 (L/3)"]$  L = Max Range (Inch)  
 Resolution\*: .0001"/0.001mm  
 (340-351-30: .00005"/0.001mm)  
 Graduation\*\*: .001" (104-165: is .0001")  
 Flatness: .000024" for models up to 12"  
 .00004" for models over 12"  
 Parallelism: .00008" for models up to 3"  
 .00012" for models up to 6"  
 $\pm[.00008" + .00004 (L/4)"]$  L= Max range (inch)  
 Measuring faces: Carbide tipped (spindle only)  
 Display\*: LCD  
 Battery\*: SR44 (1 pc.), **938882**  
 Battery life\*: Approx. 2.4 years (1.8 years for models over 300mm) years under normal use  
 Dust/Water protection level\*: IP65 (up to 12" / 300mm)  
 \*Digital models \*\*Analog models

### Function of Digital Model

Zero / ABS, Data hold, Preset, Data output, inch/mm conversion (on inch/metric models only)  
 Function Lock, 2 Presets  
 Alarm: Low voltage, Counting value composition error

### Optional Accessories for Digital Model

- 05CZA662**: SPC cable with data switch (40" / 1m)
  - 05CZA663**: SPC cable with data switch (80" / 2m)
  - 959149**: SPC cable Straight type (40"/1m)\*
  - 959150**: SPC cable Straight type (80"/2m)\*
  - 04AZB512**: SPC cable L-type (40"/1m)\*
  - 04AZB513**: SPC cable L-type (80"/2m)\*
- \* models over 300mm

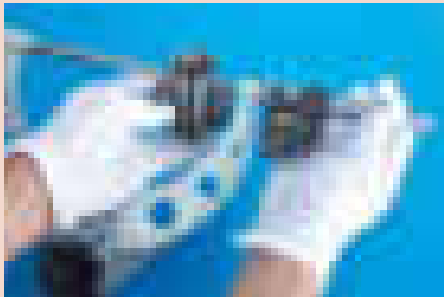

340-352-30

### SPECIFICATIONS

Inch/Metric		Digital model		
Range	Resolution	Order No.	Mass (kg)	Remarks
0-6" / 0-152.4mm	.00005" / 0.001mm	<b>340-351-30</b>	0.96	with 6 anvils & 5 standards
6-12" / 152.4 - 304.8mm	.0001" / 0.001mm	<b>340-352-30</b>	1.88	with 6 anvils & 6 standards
12-18" / 304.8 - 457.2mm	.0001" / 0.001mm	<b>340-720</b>	4.75	with 6 anvils & 6 standards
18-24" / 457.2 - 609.6mm	.0001" / 0.001mm	<b>340-721</b>	6.62	with 6 anvils & 6 standards
24-30" / 609.6 - 762.0mm	.0001" / 0.001mm	<b>340-722</b>	10.06	with 6 anvils & 6 standards
30-36" / 762.0 - 914.4mm	.0001" / 0.001mm	<b>340-723</b>	11.98	with 6 anvils & 6 standards

Inch				
Range	Graduation	Order No.	Mass(kg)	Remarks
0-2"	.0001"	<b>104-165*</b>	0.32	with 1" anvil & 1 standard
0-6"	.001"	<b>104-137</b>	1.35	with 6 anvils & 5 standards
6-12"	.001"	<b>104-138</b>	2.65	with 6 anvils & 6 standards
12-16"	.001"	<b>104-152</b>	3.31	with 4 anvils & 4 standards
12-18"	.001"	<b>104-201</b>	4.69	with 6 anvils & 6 standards
16-20"	.001"	<b>104-153</b>	4.81	with 4 anvils & 4 standards
18-24"	.001"	<b>104-202</b>	6.51	with 6 anvils & 6 standards
20-24"	.001"	<b>104-154</b>	6.35	with 4 anvils & 4 standards
24-28"	.001"	<b>104-155</b>	7.72	with 4 anvils & 4 standards
24-30"	.001"	<b>104-203</b>	9.95	with 6 anvils & 6 standards
28-32"	.001"	<b>104-156</b>	9.08	with 4 anvils & 4 standards
30-36"	.001"	<b>104-204</b>	11.87	with 6 anvils & 6 standards
32-36"	.001"	<b>104-157</b>	10.41	with 4 anvils & 4 standards
36-40"	.001"	<b>104-158</b>	11.78	with 4 anvils & 4 standards
36-42"	.001"	<b>104-205</b>	13.68	with 6 anvils & 6 standards

\*.0001" reading is obtained with vernier.

# Outside Micrometers

**SERIES 340, 104 — with Interchangeable Anvils, Metric Model**



## FEATURES

- IP65 water/dust protection (Series 340\*).  
\*Models with a range up to 300mm.
- Wide measuring range with interchangeable anvils.
- With a ratchet stop for constant force.
- Supplied with zero-setting standards bar for each range.
- With SPC output (Series 340).
- Supplied in fitted wooden case.

## Digital model



340-251-30

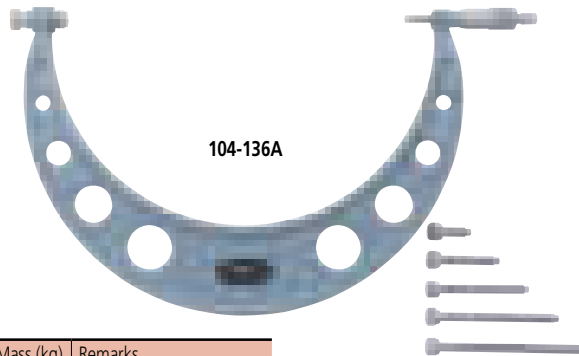

104-136A

## SPECIFICATIONS

**Metric** Digital model

Range	Resolution	Order No.	Mass (kg)	Remarks
0 - 150mm	0.001mm	340-251-30	0.96	with 6 anvils & 5 standards
150 - 300mm	0.001mm	340-252-30	1.88	with 6 anvils & 6 standards
300 - 400mm	0.001mm	340-520	3.31	with 4 anvils & 4 standards
400 - 500mm	0.001mm	340-521	4.81	with 4 anvils & 4 standards
500 - 600mm	0.001mm	340-522	6.35	with 4 anvils & 4 standards
600 - 700mm	0.001mm	340-523	7.72	with 4 anvils & 4 standards
700 - 800mm	0.001mm	340-524	9.08	with 4 anvils & 4 standards
800 - 900mm	0.001mm	340-525	10.41	with 4 anvils & 4 standards
900 - 1000mm	0.001mm	340-526	11.78	with 4 anvils & 4 standards

**Metric**

Range	Graduation	Order No.	Mass (kg)	Remarks
0 - 50mm	0.01mm	104-171*	0.32	with 2 anvils & 1 standard
0 - 100mm	0.01mm	104-139A	0.79	with 4 anvils & 3 standards
0 - 150mm	0.01mm	104-135A	1.35	with 6 anvils & 5 standards
50 - 150mm	0.01mm	104-161A	1.35	with 4 anvils & 4 standards
100 - 200mm	0.01mm	104-140A	1.38	with 4 anvils & 4 standards
150 - 300mm	0.01mm	104-136A	2.65	with 6 anvils & 6 standards
200 - 300mm	0.01mm	104-141A	2.22	with 4 anvils & 4 standards
300 - 400mm	0.01mm	104-142A	3.31	with 4 anvils & 4 standards
400 - 500mm	0.01mm	104-143A	4.81	with 4 anvils & 4 standards
500 - 600mm	0.01mm	104-144A	6.35	with 4 anvils & 4 standards
600 - 700mm	0.01mm	104-145A	7.72	with 4 anvils & 4 standards
700 - 800mm	0.01mm	104-146A	9.08	with 4 anvils & 4 standards
800 - 900mm	0.01mm	104-147A	10.41	with 4 anvils & 4 standards
900 - 1000mm	0.01mm	104-148A	11.78	with 4 anvils & 4 standards

\*The frame is in a heat-insulated cover.

## DIMENSIONS

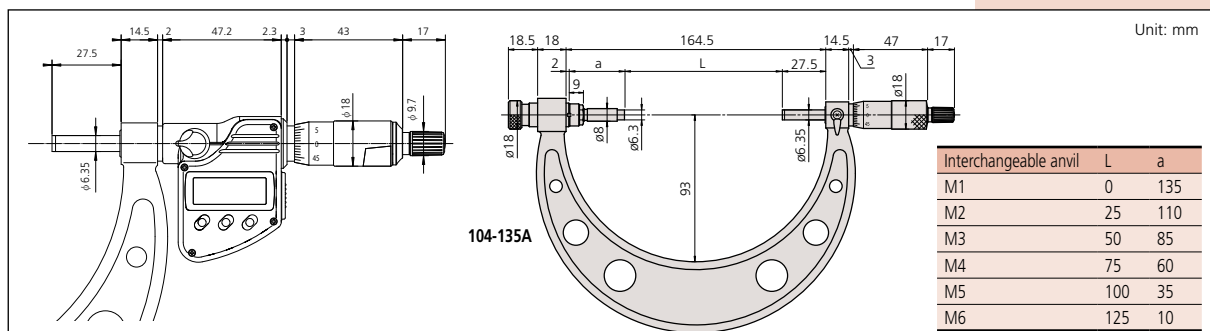

## Technical Data

Accuracy:  $\pm(4+R/75)\mu\text{m}$ , R=max. range (mm)  
 Resolution\*: 0.001mm  
 Graduation\*\*: 0.01mm  
 Flatness: 0.6 $\mu\text{m}$  for models up to 300mm  
 1 $\mu\text{m}$  for models over 300mm  
 Parallelism: 2 $\mu\text{m}$  for models up to 75mm  
 3 $\mu\text{m}$  for models up to 150mm  
 (2+R/100) $\mu\text{m}$  for models over 150mm, R=max. range (mm)

Measuring faces: Carbide tipped (spindle only)  
 Display\*: LCD  
 Battery\*: SR44 (1 pc.), **938882**  
 Battery life\*: Approx. 2.4 years (1.8 years for models over 300mm) years under normal use  
 Dust/Water protection level\*: IP65 (up to 300mm)  
 \*Digital models \*\*Analog models

## Function of Digital Model

Zero / ABS, Data hold, Preset, Data output, inch/mm conversion (on inch/metric models only)  
 Function Lock, 2 Presets  
 Alarm: Low voltage, Counting value composition error

## Optional Accessories for Digital Model

**05CZA662**: SPC cable with data switch (40" / 1m)  
**05CZA663**: SPC cable with data switch (80" / 2m)  
**959149**: SPC cable Straight type (40" / 1m)\*  
**959150**: SPC cable Straight type (80" / 2m)\*  
**04AZB512**: SPC cable L-type (40" / 1m)\*  
**04AZB513**: SPC cable L-type (80" / 2m)\*  
 \* models over 300mm

# Outside Micrometers

## SERIES 105 — with Extension Anvil Collars

### Technical Data

Accuracy:  $\pm(6+R/75)\mu\text{m}$ , R=max. range (mm)  
 Graduation: .001" / 0.01mm  
 Flatness: .000052" / 1.3 $\mu\text{m}$   
 Parallelism: [.00016" + .00004 (L/4)"] L=max. range (inch)  
 (2+R/100) $\mu\text{m}$ , R=max. range (mm)  
 Measuring faces: Carbide tipped

### Extension anvil collar

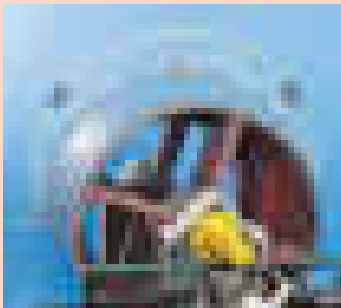
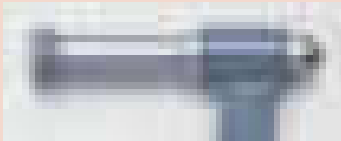
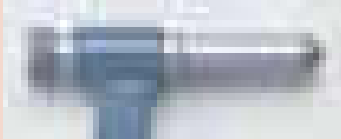

### FEATURES

- Wide measuring range with extension anvil collars.
- 50mm spindle stroke.
- With ratchet stop for constant force.
- Supplied with zero-setting standards bar for each range.
- Square and round pipes are combined for light weight and rigid frame (for models over 1000mm range).
- Workpiece stopper (for models over 1000mm range).
- Supplied in a fitted wooden case.

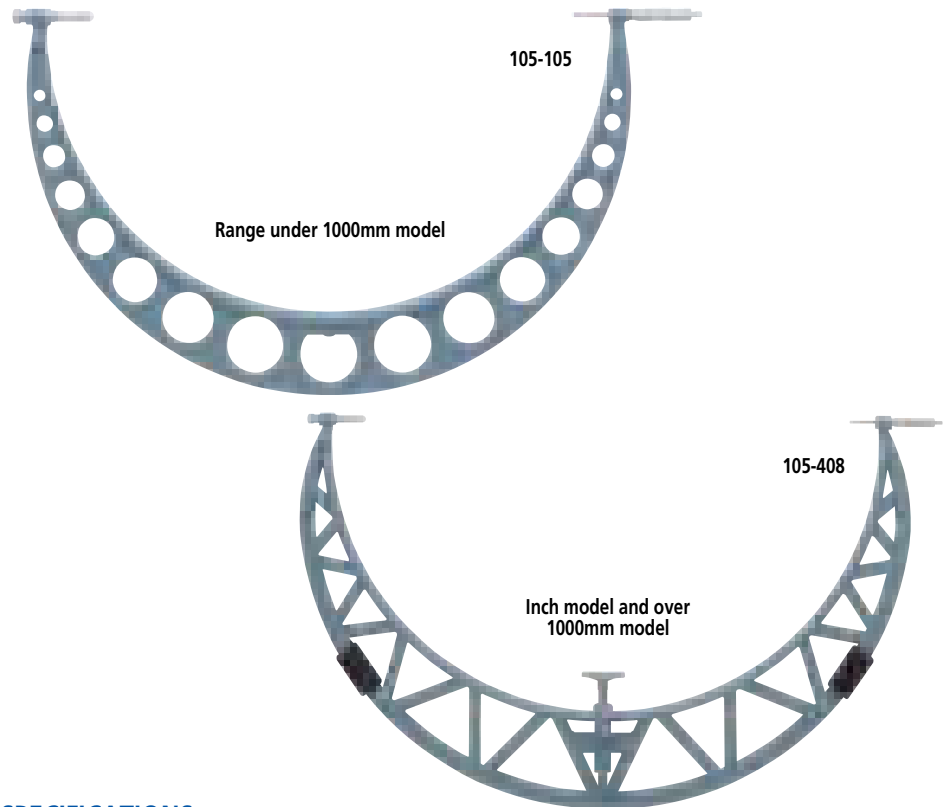

### SPECIFICATIONS

Metric			
Range	Order No.	Extension collars	Mass (kg)
500 - 600mm	<b>105-103</b>	50mm	5.53
600 - 700mm	<b>105-104</b>	50mm	6.35
700 - 800mm	<b>105-105</b>	50mm	7.17
800 - 900mm	<b>105-106</b>	50mm	7.99
900 - 1000mm	<b>105-107</b>	50mm	8.81
1000 - 1100mm	<b>105-408</b>	50mm	6.37
1100 - 1200mm	<b>105-409</b>	50mm	7.08
1000 - 1200mm	<b>105-418</b>	50mm, 100mm	13.77
1200 - 1300mm	<b>105-410</b>	50mm	7.79
1300 - 1400mm	<b>105-411</b>	50mm	8.50
1200 - 1400mm	<b>105-419</b>	50mm, 100mm	15.77
1400 - 1500mm	<b>105-412</b>	50mm	9.21
1500 - 1600mm	<b>105-413</b>	50mm	10.17
1400 - 1600mm	<b>105-420</b>	50mm, 100mm	17.91
1600 - 1700mm	<b>105-414</b>	50mm	11.13
1700 - 1800mm	<b>105-415</b>	50mm	12.09
1600 - 1800mm	<b>105-421</b>	50mm, 100mm	20.80
1800 - 1900mm	<b>105-416</b>	50mm	13.05
1900 - 2000mm	<b>105-417</b>	50mm	14.01
1800 - 2000mm	<b>105-422</b>	50mm, 100mm	22.76

Inch			
Range	Order No.	Extension collars	Mass (kg)
40 - 44"	<b>105-428</b>	2"	10.0
44 - 48"	<b>105-429</b>	2"	10.9
48 - 52"	<b>105-430</b>	2"	11.4
52 - 56"	<b>105-431</b>	2"	11.9
56 - 60"	<b>105-432</b>	2"	12.6
60 - 64"	<b>105-433</b>	2"	13.2
64 - 68"	<b>105-434</b>	2"	14.1
68 - 72"	<b>105-435</b>	2"	14.9
72 - 76"	<b>105-436</b>	2"	15.8
76 - 80"	<b>105-437</b>	2"	16.7

# Outside Micrometers

## SERIES 406 — Non-Rotating Spindle Type



### FEATURES

- With a standard bar except for 0 - 1" / 0 - 25mm model.
- With SPC output.
- Supplied in a fitted plastic case.
- Non-slip grip finish

### Technical Data

Accuracy: Refer to the list of specifications  
 Resolution: .00005"/0.001mm or 0.001mm  
 Flatness: 0.3µm / .000012"  
 Parallelism: .00012"/3µm for models up to 3"/75mm  
 .00016"/4µm for 4"/100mm models  
 Measuring faces: Carbide tipped  
 Display: LCD  
 Battery: SR44 (1 pc.), **938882**  
 Battery life: Approx. 2.4 years under normal use

### Function of Digital Model

Origin-set, Zero / ABS, Data hold, Data output, inch/mm conversion (on inch/metric models only)  
 Function lock  
 Alarm: Low voltage, Counting value composition error

### Optional Accessories for Digital Model

- 05CZA662:** SPC cable with data switch (40" / 1m)
- 05CZA663:** SPC cable with data switch (80" / 2m)



406-350-30

### SPECIFICATIONS

Metric		Digital model with ratchet stop	
Range	Resolution	Order No.	Accuracy
0 - 25mm	0.001mm	<b>406-250-30</b>	±3µm
25 - 50mm	0.001mm	<b>406-251-30</b>	±3µm
50 - 75mm	0.001mm	<b>406-252-30</b>	±3µm
75 - 100mm	0.001mm	<b>406-253-30</b>	±4µm

Inch/Metric		Digital model with ratchet stop	
Range	Resolution	Order No.	Accuracy
0 - 1"/0 - 25.4mm	.00005"/0.001mm	<b>406-350-30</b>	±.00015"
1 - 2"/25.4 - 50.8mm	.00005"/0.001mm	<b>406-351-30</b>	±.00015"
2 - 3"/50.8 - 72.6mm	.00005"/0.001mm	<b>406-352-30</b>	±.00015"
3 - 4"/76.2 - 101.6mm	.00005"/0.001mm	<b>406-353-30</b>	±.0002"

### DIMENSIONS AND MASS

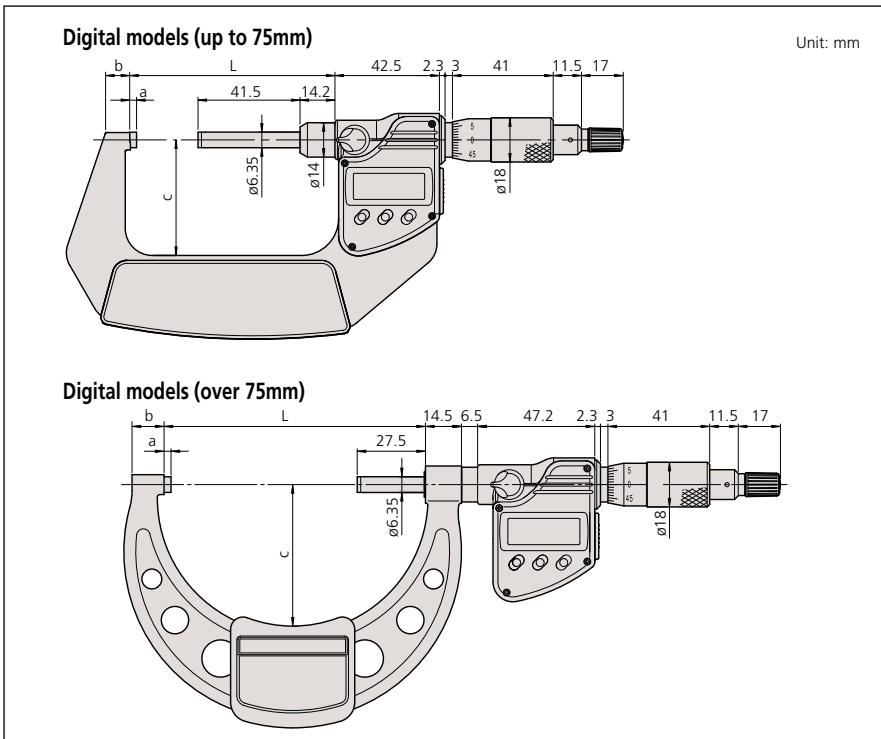



# Outside Micrometers

## SERIES 107

### FEATURES

- Uses dial indicator for direct go/no-go judgment for mass-produced parts.
- Anvil retracting trigger for quick measurement.
- With a standard bar except for 0 - 25mm models.
- Supplied in fitted plastic case.

### Technical Data

Graduation: 0.01mm (thimble)  
 Flatness: 0.6 $\mu$ m  
 Parallelism: (2+R/100) $\mu$ m, R=max. range (mm)  
 Measuring faces: Carbide tipped

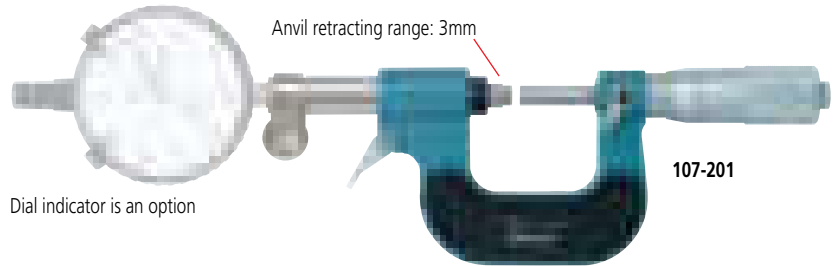
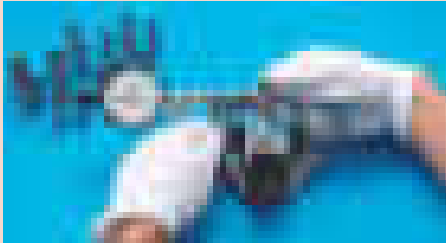

Dial indicator is an option

### SPECIFICATIONS

#### Metric

Range	Graduation	Order No.	Accuracy
0 - 25mm	0.01mm	<b>107-201</b>	$\pm 2\mu$ m
25 - 50mm	0.01mm	<b>107-202</b>	$\pm 2\mu$ m
50 - 75mm	0.01mm	<b>107-203</b>	$\pm 2\mu$ m
75 - 100mm	0.01mm	<b>107-204</b>	$\pm 3\mu$ m
100 - 125mm	0.01mm	<b>107-205</b>	$\pm 3\mu$ m
125 - 150mm	0.01mm	<b>107-206</b>	$\pm 3\mu$ m
150 - 175mm	0.01mm	<b>107-207</b>	$\pm 4\mu$ m
175 - 200mm	0.01mm	<b>107-208</b>	$\pm 4\mu$ m

### DIMENSIONS AND MASS

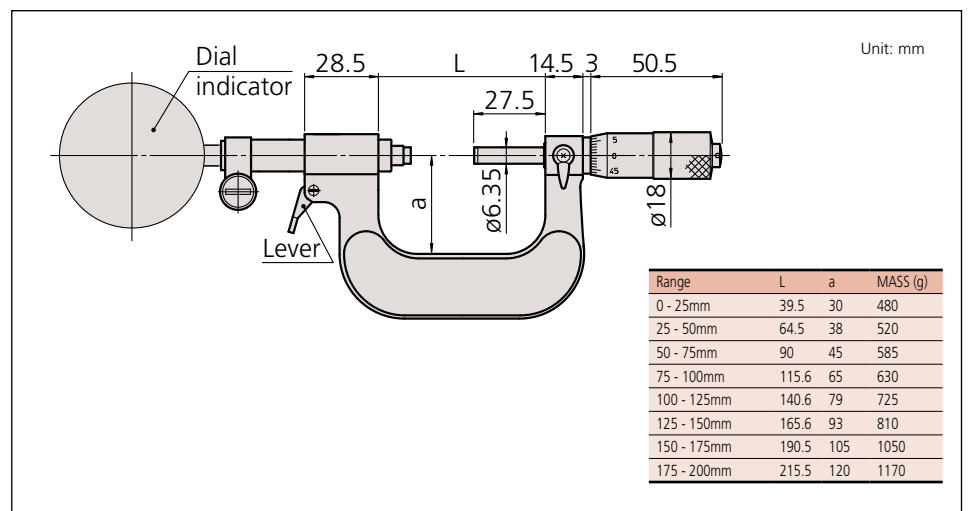

# Spline Micrometers

**SERIES 331, 111**



## FEATURES

- IP65 water/dust protection (Series 331).
- The anvil and spindle have a small diameter for measuring splined shafts, slots, and keyways.
- Non-slip grip finish (digital models)
- With ratchet stop for constant force.
- With SPC output (Series 331).
- With a standard bar except 0-1" and 0-25mm model.
- Supplied in fitted plastic case.

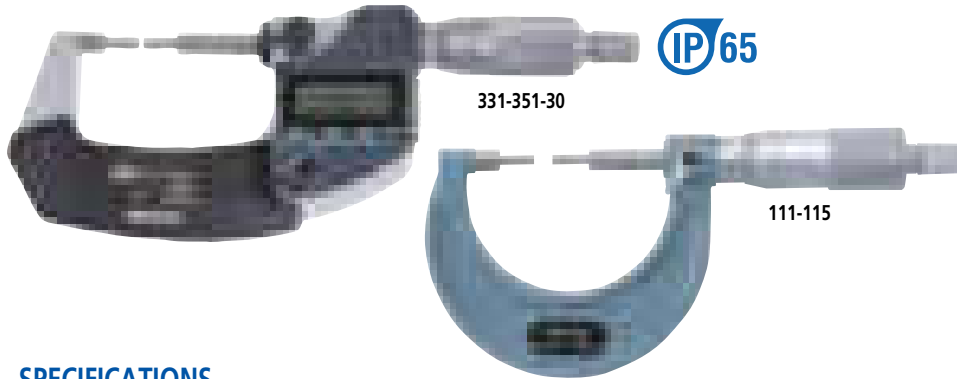

## SPECIFICATIONS

Metric		Digital model			
Range	Resolution	Order No.	Accuracy	Remarks	Mass (g)
0 - 25mm	0.001mm	331-251-30	±2µm	Type A	330
		331-261-30	±2µm	Type B	330
25 - 50mm	0.001mm	331-252-30	±2µm	Type A	470
		331-262-30	±2µm	Type B	470
50 - 75mm	0.001mm	331-253-30	±2µm	Type A	625
		331-263-30	±2µm	Type B	625
75 - 100mm	0.001mm	331-254-30	±3µm	Type A	565
		331-264-30	±3µm	Type B	565

Metric		Digital model			
Range	Graduation	Order No.	Accuracy	Remarks	Mass (g)
0 - 25mm	0.01mm	111-115	±3µm	Type A	205
		111-215	±3µm	Type B	205
25 - 50mm	0.01mm	111-116	±3µm	Type A	305
		111-117	±3µm	Type A	370
50 - 75mm	0.01mm	111-118	±4µm	Type A	500
		111-119	±4µm	Type A	655
75 - 100mm	0.01mm	111-120	±4µm	Type A	710
		111-121	±5µm	Type A	900
175 - 200mm	0.01mm	111-122	±5µm	Type A	1040

Inch/Metric		Digital model			
Range	Resolution	Order No.	Accuracy	Remarks	Mass (g)
0 - 1" / 0 - 25.4mm	.00005" / 0.001mm	331-351-30	±.0001"	Type A	330
		331-361-30	±.0001"	Type B	330
1 - 2" / 25.4-50.8mm	.00005" / 0.001mm	331-352-30	±.0001"	Type A	470
		331-362-30	±.0001"	Type B	470
2 - 3" / 50.8-76.2mm	.00005" / 0.001mm	331-353-30	±.0001"	Type A	625
		331-363-30	±.0001"	Type B	625
3 - 4" / 76.2-101.6mm	.00005" / 0.001mm	331-354-30	±.00015"	Type A	565
		331-364-30	±.00015"	Type B	565

Inch		Digital model			
Range	Graduation	Order No.	Accuracy	Remarks	Mass (g)
0 - 1"	.0001"	111-166*	±.00015"	Type A	205

\*.0001" reading is obtained with vernier.

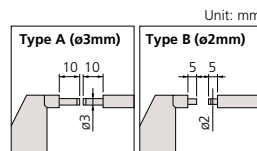

## Technical Data

Accuracy: Refer to the list of specifications  
 Resolution\*: .00005"/0.001mm or 0.001mm  
 Graduation\*: .0001" or 0.01mm, .001"  
 Flatness: .000012" / 0.3µm  
 Parallelism: (2+R/100)µm, R=max. range (mm) [0.0008" + .00004" (L/4")]  
 L = max. range (inch)  
 Measuring faces: Carbide tipped  
 Display\*: LCD  
 Battery\*: SR44 (1 pc.), **938882**  
 Battery life\*: Approx. 2.4 years under normal use  
 Dust/Water protection level\*: IP65  
 \*Digital models \*\*Analog models

## Function of Digital Model

Origin-set, Zero-setting, Data hold, Data output, inch/mm conversion (on inch/metric models only)  
 Function lock  
 Alarm: Low voltage, Counting value composition error

## Optional Accessories for Digital Model

**05CZA662**: SPC cable with data switch (40" / 1m)  
**05CZA663**: SPC cable with data switch (80" / 2m)

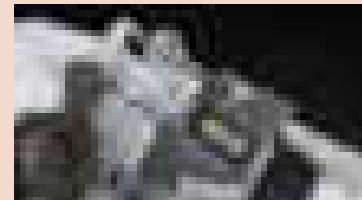
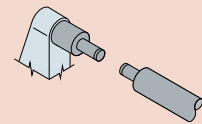

## DIMENSIONS

**Models up to 75mm**

**Digital model**

**Models over 75mm**

**Digital model**

Unit: mm

Range	L	a	b	c
0 - 25mm	58.2 (55.3)	17.5 (17.8)	7.3 (10)	32 (38)
25 - 50mm	83.2 (80.3)	17.5 (17.8)	10.1 (12)	47 (49)
50 - 75mm	108.2 (105.3)	20.3 (17.8)	11.5 (14)	60 (60)
75 - 100mm	132.8 (132.8)	20.3 (20.3)	16.7 (17)	76.5 (79)



# Point Micrometers

**SERIES 342, 142, 112**

## Technical Data

Accuracy: Refer to the list of specifications.  
 Resolution\*: .00005" / 0.001mm or 0.001mm  
 Graduation\*\*\*: .001" or 0.01mm  
 Display\*: LCD  
 Battery\*: SR44 (1 pc.), **938882**  
 Battery life\*: Approx. 2.4 years under normal use  
 Dust/Water protection level\*: IP65  
 \*Digital models \*\*Analog models

## Function of Digital Model

Origin-set, Zero / ABS, Data hold,  
 inch/mm conversion (on inch/metric models only)  
 Function lock  
 Alarm: Low voltage, Counting value composition error

## Optional Accessories for Digital Model

**05CZA662:** SPC cable with data switch (40" / 1m)  
**05CZA663:** SPC cable with data switch (80" / 2m)

## FEATURES

- IP65 water/dust protection (Series 342).
- Pointed spindle and anvil for measuring the web thickness of drills, small grooves, keyways, and other hard-to-reach dimensions.
- 15 degree and 30 degree measuring points are available.
- Non-slip grip finish (digital models).
- The measuring points have approximately 0.3mm / .012" radius.
- With ratchet stop for constant force.
- With SPC output (Series 342).
- With digit counter (Series 142).
- With a standard bar except 0 - 1" and 0 - 25mm model.
- Supplied in fitted plastic case.



342-351-30

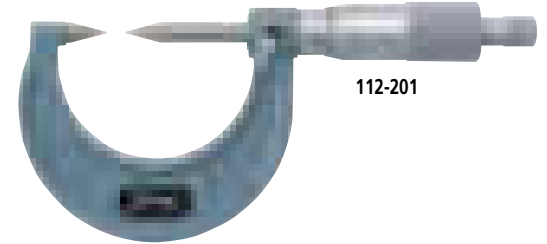

112-201

## SPECIFICATIONS

Metric		Digital model (with carbide tip)				
Range	Resolution	Order No.	Accuracy	Point	Mass (g)	
0 - 25mm	0.001mm	<b>342-251-30</b>	±2µm	15°	330	
		<b>342-261-30</b>	±2µm	30°	330	
25 - 50mm	0.001mm	<b>342-252-30</b>	±2µm	15°	470	
		<b>342-262-30</b>	±2µm	30°	470	
50 - 75mm	0.001mm	<b>342-253-30</b>	±2µm	15°	625	
		<b>342-263-30</b>	±2µm	30°	625	
75 - 100mm	0.001mm	<b>342-254-30</b>	±3µm	15°	565	
		<b>342-264-30</b>	±3µm	30°	565	

Inch/Metric		Digital model (with carbide tip)				
Range	Resolution	Order No.	Accuracy	Point	Mass (g)	
0 - 1" / 0 - 25.4mm	.00005" / 0.001mm	<b>342-351-30</b>	±.0001"	15°	330	
		<b>342-361-30</b>	±.0001"	30°	330	
1" - 2" / 25.4 - 50.8mm	.00005" / 0.001mm	<b>342-352-30</b>	±.0001"	15°	470	
		<b>342-362-30</b>	±.0001"	30°	470	
2" - 3" / 50.8 - 76.2mm	.00005" / 0.001mm	<b>342-353-30</b>	±.0001"	15°	625	
		<b>342-363-30</b>	±.0001"	30°	625	
3" - 4" / 76.2 - 101.6mm	.00005" / 0.001mm	<b>342-354-30</b>	±.00015"	15°	565	
		<b>342-364-30</b>	±.00015"	30°	565	

Metric		Mechanical Counter Model				
Range	Graduation	Order No.	Accuracy	Point	Mass (g)	
0 - 25mm	0.01mm	<b>142-153*</b>	±3µm	15°	260	
		<b>142-201*</b>	±3µm	30°	260	

Inch		Mechanical Counter Model				
Range	Graduation	Order No.	Accuracy	Point	Mass (g)	
0 - 1"	.001"	<b>142-177*</b>	±.00015"	15°	260	
		<b>142-225*</b>	±.00015"	30°	260	

\*The points don't have carbide tips.

\*The points don't have carbide tips.

Metric		Mechanical Counter Model				
Range	Graduation	Order No.	Accuracy	Point	Mass (g)	
0 - 25mm	0.01mm	<b>112-165</b>	±3µm	15°	205	
		<b>112-153*</b>	±3µm	15°	205	
		<b>112-213</b>	±3µm	30°	205	
		<b>112-201*</b>	±3µm	30°	205	
25 - 50mm	0.01mm	<b>112-166</b>	±3µm	15°	305	
		<b>112-154*</b>	±3µm	15°	305	
		<b>112-214</b>	±3µm	30°	305	
		<b>112-202*</b>	±3µm	30°	305	
50 - 75mm	0.01mm	<b>112-167</b>	±3µm	15°	370	
		<b>112-155*</b>	±3µm	15°	370	
		<b>112-215</b>	±3µm	30°	370	
		<b>112-203*</b>	±3µm	30°	370	
75 - 100mm	0.01mm	<b>112-168</b>	±4µm	15°	500	
		<b>112-156*</b>	±4µm	15°	500	
		<b>112-216</b>	±4µm	30°	500	
		<b>112-204*</b>	±4µm	30°	500	

Inch		Mechanical Counter Model				
Range	Graduation	Order No.	Accuracy	Point	Mass (g)	
0 - 1"	.001"	<b>112-189</b>	±.00015"	15°	205	
		<b>112-177*</b>	±.00015"	15°	205	
		<b>112-237</b>	±.00015"	30°	205	
		<b>112-225*</b>	±.00015"	30°	205	
1 - 2"	.001"	<b>112-190</b>	±.00015"	15°	305	
		<b>112-178*</b>	±.00015"	15°	305	
		<b>112-238</b>	±.00015"	30°	305	
		<b>112-226*</b>	±.00015"	30°	305	
2 - 3"	.001"	<b>112-191</b>	±.00015"	15°	370	

\*The points don't have carbide tips.

\*The points don't have carbide tips.

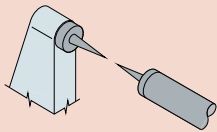

Tip angle: 15° (R0.3mm)



Tip angle: 30° (R0.3mm)



## DIMENSIONS

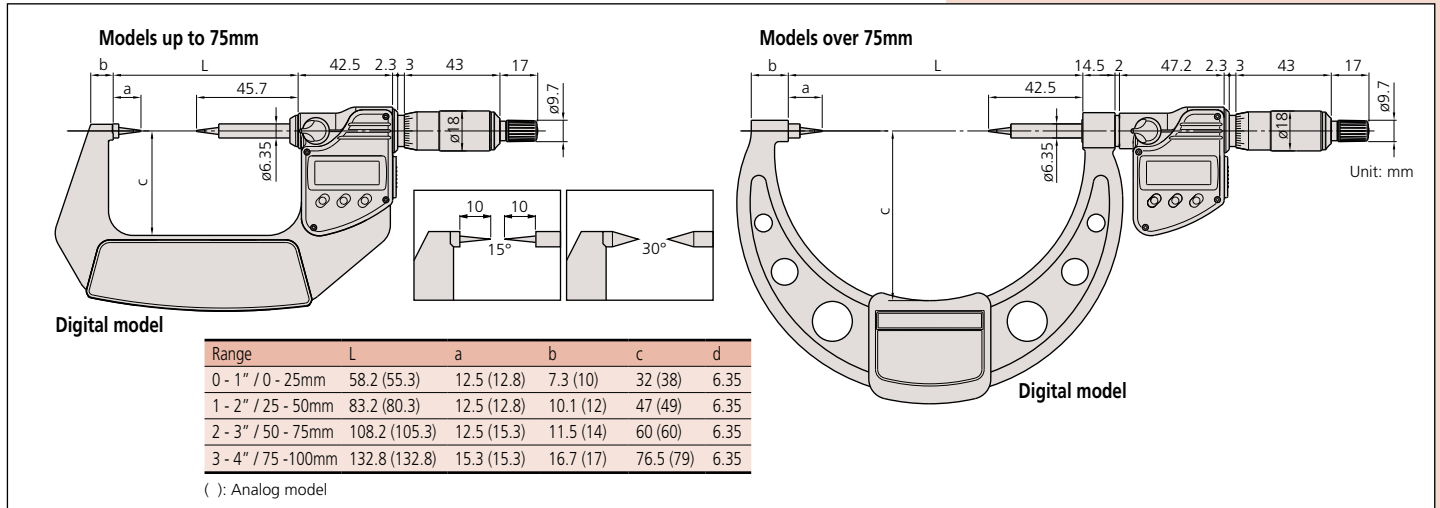

# Crimp Height Micrometers

**SERIES 342, 142, 112 — Point Spindle and Blade Anvil**

## FEATURES

- IP54/65 water/dust protection (Series 342).
- Measures the height of crimp contacts.
- With ratchet stop for constant force.
- Non-slip grip finish (digital models)
- With SPC output (Series 342).
- With digit counter (Series 142).
- Supplied in fitted plastic case.



## SPECIFICATIONS

Metric Digital model					
Range	Resolution	Order No.	Accuracy	Mass (g)	
0 - 20mm	0.001mm	<b>342-271-30</b>	±3µm	270	

Metric Quickmike type					
Range	Resolution	Order No.	Accuracy	Mass (g)	
0 - 15mm	0.001mm	<b>342-451</b>	±3µm	275	

Metric Mechanical counter model					
Range	Graduation	Order No.	Accuracy	Mass (g)	
0 - 25mm	0.01mm	<b>142-402</b>	±3µm	200	
0 - 25mm	0.001mm	<b>142-403*</b>	±3µm	200	

Inch/Metric Digital model					
Range	Resolution	Order No.	Accuracy	Mass (g)	
0 - 0.8" / 0 - 20mm	.00005" / 0.001mm	<b>342-371-30</b>	±.00015"	270	

Metric					
Range	Graduation	Order No.	Accuracy	Mass (g)	
0 - 25mm	0.01mm	<b>112-401</b>	±3µm	165	

\* 0.001mm reading is obtained with vernier.



## Technical Data

Accuracy: Refer to the list of specifications  
 Resolution\*: .00005" / 0.001mm or 0.001mm  
 Graduation\*\*: 0.01mm  
 Display\*: LCD  
 Battery\*: SR44 (1 pc.), **938882**  
 Battery life\*: Approx. 2.4 years under normal use  
 (3 years: Quickmike type)  
 Dust/Water protection level\*: IP65 / IP54  
 \*Digital models \*\*Analog models

## Function of Digital Model

Origin-set, Zero / ABS (342-271-30, 342-371-30),  
 Data hold, Data output, inch/mm conversion  
 (on inch/metric models only)  
 Function lock  
 Alarm: Low voltage, Counting value composition error

## Optional Accessories for Digital Model

- 05CZA662**: SPC cable with data switch (40" / 1m)
- 05CZA663**: SPC cable with data switch (80" / 2m)
- 937387**: SPC cable for Quickmike type (40" / 1m)
- 965013**: SPC cable for Quickmike type (80" / 2m)

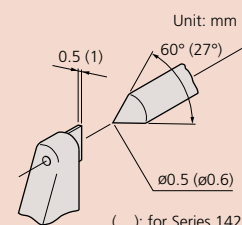

( ) : for Series 142



# V-Anvil Micrometers

**SERIES 314, 114 — 3 Flutes and 5 Flutes**

## Technical Data

Accuracy: Refer to the list of specifications  
 Resolution\*: .00005" / 0.001mm or 0.001mm  
 Graduation\*\*: .001" or .0001", 0.01mm  
 Flatness (spindle/anvil):  
 Analog model: .000024" / 0.6µm, .00005" / 1.3µm  
 Digital Model: .000012" / 0.3µm, .00004" / 1µm  
 Spindle face: Carbide tipped  
 Display\*: LCD  
 Battery\*: SR44 (1 pc.), **938882**  
 Battery life\*: Approx. 2.4 years under normal use  
 \*Digital models \*\*Analog models

## Function of Digital Model

Zero / ABS, Data hold, Data output, Preset,  
 inch/mm conversion (on inch/metric models only)  
 Function lock, 2 Presets  
 Alarm: Low voltage, Counting value composition error

## Optional Accessories for Digital Model

**05CZA662**: SPC cable with data switch (40" / 1m)  
**05CZA663**: SPC cable with data switch (80" / 2m)



## Pitch Diameter Measurement of Tap by Single-wire Method Inch/Metric

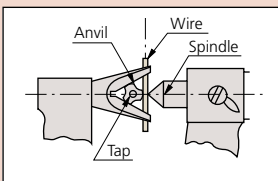

## FEATURES

- Measures the outside diameter of cutting tools (such as taps, reamers, end mills) with an odd number of flutes.
- With ratchet stop for constant force.
- Supplied with setting standard.
- Non-slip grip finish (digital models).
- V-anvils with a centerline groove are available. They are useful for measuring pitch diameters of taps which have a small diameter by using single-wire method.
- With SPC output (Series 314).
- Supplied in fitted plastic case.



## SPECIFICATIONS

**Metric** Digital model for 3 flutes cutting head

Range	Resolution	Order No.	Accuracy	Remarks	Setting Standard	Mass (g)
1 - 15mm	0.001mm	<b>314-251-30</b>	±4µm	w/Groove	ø5mm	275
		<b>314-261-30</b>	±4µm	—	ø5mm	275
10 - 25mm	0.001mm	<b>314-252-30</b>	±4µm	w/Groove	ø10mm	410
		<b>314-262-30</b>	±4µm	—	ø10mm	410
25 - 40mm	0.001mm	<b>314-253-30</b>	±5µm	—	ø25mm	465

**Inch/Metric** Digital model for 3 flutes cutting head

Range	Resolution	Order No.	Accuracy	Remarks	Setting Standard	Mass (g)
.05 - .6" / 1.27 - 15.24mm	.00005" / 0.001mm	<b>314-351-30</b>	±.0002"	w/Groove	ø.2"	275
		<b>314-361-30</b>	±.0002"	—	ø.2"	275
.4" - 1" / 10.16 - 25.4mm	.00005" / 0.001mm	<b>314-352-30</b>	±.0002"	w/Groove	ø.4"	410
		<b>314-362-30</b>	±.0002"	—	ø.4"	410
1" - 1.6" / 25.4 - 40.64mm	.00005" / 0.001mm	<b>314-353-30</b>	±.00025"	—	ø 1"	465

## SPECIFICATIONS

### Metric For 3 flutes cutting head

Range	Graduation	Order No.	Accuracy	Setting Standard	Remarks	Mass (g)
1 - 15mm	0.01mm	<b>114-101</b>	±4μm	ø5mm	w/Groove	120
		<b>114-161</b>	±4μm	ø5mm	—	120
10 - 25mm	0.01mm	<b>114-102</b>	±4μm	ø10mm	w/Groove	280
		<b>114-162</b>	±4μm	ø10mm	—	280
2.3 - 25mm	0.01mm	<b>114-204*</b>	±4μm	ø5mm	—	290
25 - 40mm	0.01mm	<b>114-103</b>	±5μm	ø25mm	—	400
40 - 55mm	0.01mm	<b>114-104</b>	±6μm	ø40mm	—	465
55 - 70mm	0.01mm	<b>114-105</b>	±6μm	ø55mm	—	675
70 - 85mm	0.01mm	<b>114-106</b>	±7μm	ø70mm	—	910

\*Carbide-tipped anvil

### Metric For 5 flutes cutting head

Range	Graduation	Order No.	Accuracy	Setting Standard	Remarks	Mass (g)
5 - 25mm	0.01mm	<b>114-121</b>	±4μm	ø5mm	w/Groove	255
		<b>114-165</b>	±4μm	ø5mm	—	255
2.3 - 25mm	0.01mm	<b>114-137*</b>	±4μm	ø5mm	—	220
25 - 45mm	0.01mm	<b>114-122</b>	±5μm	ø25mm	—	400
45 - 65mm	0.01mm	<b>114-123</b>	±6μm	ø55mm	—	540
65 - 85mm	0.01mm	<b>114-124</b>	±7μm	ø70mm	—	760

\*Carbide-tipped anvil

### Inch For 3 flutes cutting head

Range	Graduation	Order No.	Accuracy	Setting Standard	Mass (g)
.05 - .6"	.001"	<b>114-163</b>	±.0002"	ø.2"	120
.09 - 1"	.0001"	<b>114-202*</b>	±.0002"	ø.2"	280
1 - 1.6"	.001"	<b>114-113</b>	±.00025"	ø1"	400
1.6 - 2.2"	.001"	<b>114-114</b>	±.0003"	ø1.6"	465

\*Carbide-tipped anvil and .0001" reading is obtained with vernier.

### Inch For 5 flutes cutting head

Range	Graduation	Order No.	Accuracy	Setting Standard	Mass (g)
.09 - 1"	.0001"	<b>114-135</b>	±.0002"	ø.2"	255

## DIMENSIONS

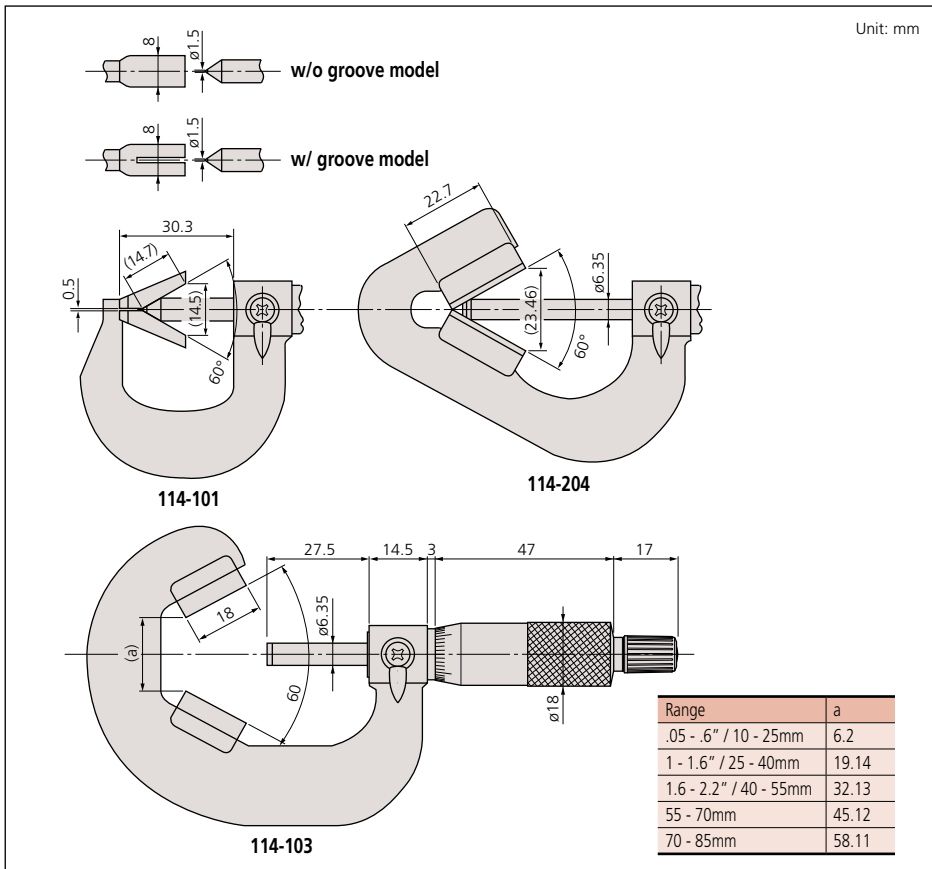

# Limit Micrometers

## SERIES 113

### FEATURES

- Can be used as a go/no-go gage by setting the upper and lower limits.
- Provided with a standard bar for 25mm - 50mm model.
- Supplied in fitted plastic case.



### Technical Data

Graduation: 0.01mm  
 Flatness: 0.6µm  
 Parallelism: (3+R/100)µm, R=max. range (mm)  
 Measuring faces: Carbide tipped

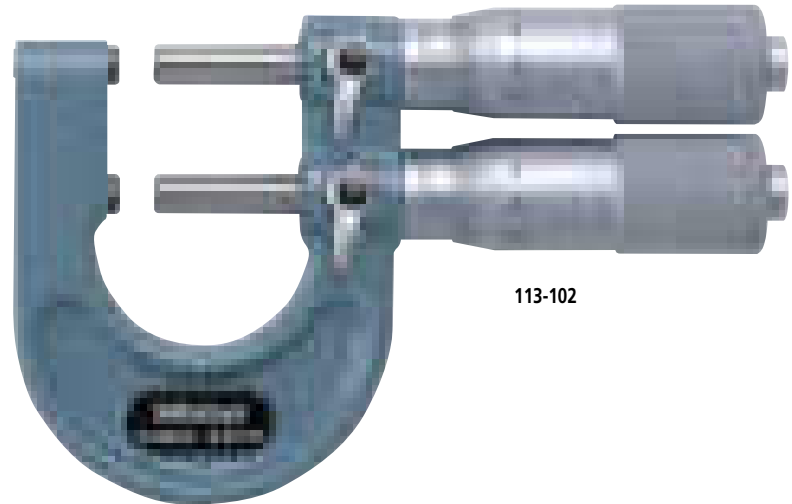

113-102

### SPECIFICATIONS

Metric

Range	Graduation	Order No.	Accuracy
0 - 25mm	0.01mm	<b>113-102</b>	±3µm
25 - 50mm	0.01mm	<b>113-103</b>	±3µm

### DIMENSIONS AND MASS

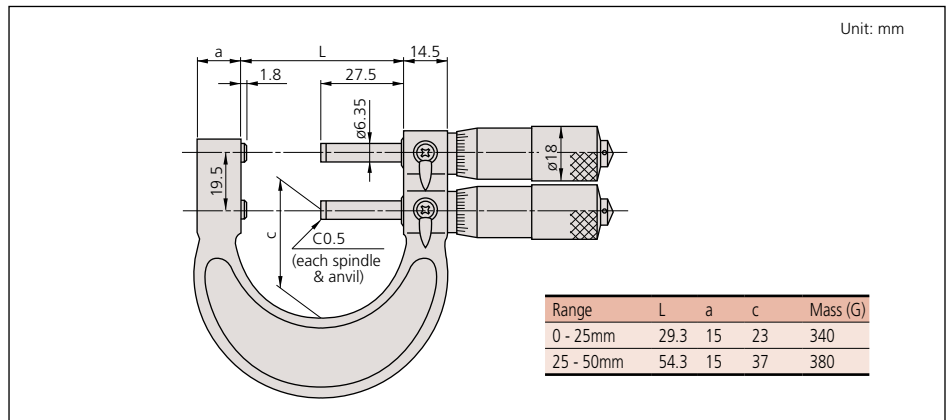

# Pana Micrometers

## SERIES 116 — Interchangeable Anvil Type

### FEATURES

- Non-rotating spindle with optional seven interchangeable anvils (flat, spline, spherical, point, knife-edge, disk and blade) for a wide range of applications.
- Interchangeable anvils (pair) are optional.
- With a standard bar except 0-1" and 0 - 25 mm model.
- V-anvils and conical spindle tips (matching pair) for screw thread measurement are also available.
- With ratchet stop for constant force.

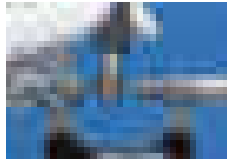

116-101

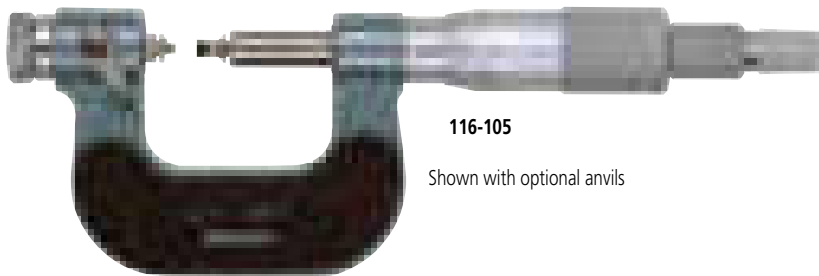

116-105

Shown with optional anvils

### SPECIFICATIONS

Metric			
Range	Graduation	Order No.	Accuracy
0 - 25mm	0.01mm	116-101	±4µm
25 - 50mm	0.01mm	116-102	±4µm

Inch			
Range	Graduation	Order No.	Accuracy
0 - 1"	.001"	116-105	±.0002"
1" - 2"	.001"	116-106	±.0002"

### Technical Data

Graduation: .001" or 0.01mm  
Spindle feed error: .00012" / 3µm

### Optional Accessories

Interchangeable V-anvil and conical spindle tip set:  
For Metric/Unified screw

Order No.	Assortment of anvils and tips
116-830	0.4 - 0.5mm/64 - 48TPI (116-831) 0.6 - 0.9mm/44 - 28TPI (116-832) 1 - 1.75mm/24 - 14TPI (116-833) 2 - 3mm/13 - 9TPI (116-834) 3.5 - 5mm/8 - 5TPI (116-835) 5.5 - 7mm/4.5 - 3.5TPI (116-836)

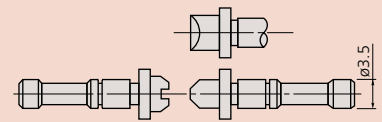

116-830

### Interchangeable anvils set

Order No.	Assortment of anvils
116-800	Flat anvils (116-801) Spline anvils (116-802) Spherical anvils (116-803) Point anvils (116-804) Knife-edge anvils (116-805) Disk anvils (116-806) Blade anvils (116-807)

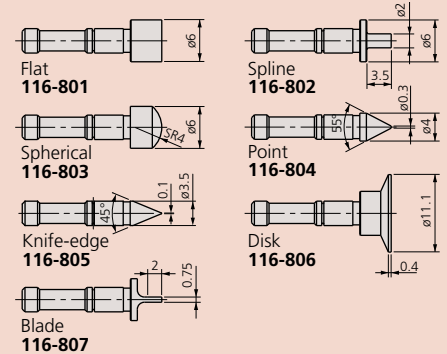





# Spherical Face Micrometers

**SERIES 395, 295, 115**

## Technical Data

Accuracy: Refer to the list of specifications  
 Flatness: .000024" / 0.6µm  
 Display\*: LCD  
 Battery\*: SR44 (1 pc.), **938882**  
 Battery life\*: Approx. 2.4 years under normal use  
 Dust/Water protection level\*: IP65  
 \*Digital models \*\*Analog models

## Function of Digital Model

Origin-set, Zero / ABS, Data hold, Data output,  
 inch/mm conversion (on inch/metric models only)  
 Function lock  
 Alarm: Low voltage, Counting value composition error

## Optional Accessories for Digital Model

**05CZA662**: SPC cable with data switch (40" / 1m)  
**05CZA663**: SPC cable with data switch (80" / 2m)

Spherical anvil-spindle type



## FEATURES

- IP65 water/dust protection (Series 395).
- Designed to measure the wall thickness of various tubing.
- With ratchet stop for constant force.
- With SPC output (Series 395).
- Non-slip grip finish (digital models).
- With digit counter (Series 295).
- With a standard bar except 0 -1" and 0 - 25mm model.
- Supplied in fitted plastic case.



115-153



395-371-30

## SPECIFICATIONS

Metric		Digital model with spherical anvil				
Range	Resolution	Order No.	Accuracy	Remarks	Mass (g)	
0 - 25mm	0.001mm	395-251-30 <sup>S-F</sup>	±2µm	D: 15mm	270	
		395-271-30 <sup>S-S</sup>	±2µm	D: 15mm	270	
25 - 50mm	0.001mm	395-252-30 <sup>S-F</sup>	±2µm	D: 15mm	330	
		395-272-30 <sup>S-S</sup>	±2µm	D: 15mm	330	
50 - 75mm	0.001mm	395-253-30 <sup>S-F</sup>	±2µm	D: 19mm	470	
		395-273-30 <sup>S-S</sup>	±2µm	D: 19mm	470	
75 - 100mm	0.001mm	395-254-30 <sup>S-F</sup>	±3µm	D: 20mm	625	
		395-274-30 <sup>S-S</sup>	±3µm	D: 20mm	625	

S-F: Spherical anvil and flat spindle  
 S-S: Spherical anvil and spherical spindle

Inch/Metric		Digital model with spherical anvil				
Range	Resolution	Order No.	Accuracy	Remarks	Mass (g)	
0 - 1" / 0 - 25.4mm	.00005" / 0.001mm	395-351-30 <sup>S-F</sup>	±.0001"	D: .59"	270	
		395-371-30 <sup>S-S</sup>	±.0001"	D: .59"	270	
1" - 2" / 25.4 - 50.8mm	.00005" / 0.001mm	395-352-30 <sup>S-F</sup>	±.0001"	D: .59"	330	
		395-372-30 <sup>S-S</sup>	±.0001"	D: .59"	330	
2" - 3" / 50.8 - 76.2mm	.00005" / 0.001mm	395-353-30 <sup>S-F</sup>	±.0001"	D: .75"	470	
		395-373-30 <sup>S-S</sup>	±.0001"	D: .75"	470	
3" - 4" / 76.2 - 101.6mm	.00005" / 0.001mm	395-354-30 <sup>S-F</sup>	±.00015"	D: .79"	625	
		395-374-30 <sup>S-S</sup>	±.00015"	D: .79"	625	

S-F: Spherical anvil and flat spindle  
 S-S: Spherical anvil and spherical spindle

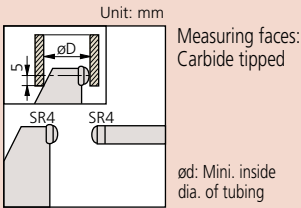

Metric		Mechanical counter model with spherical anvil				
Range	Graduation	Order No.	Accuracy	Remarks	Mass (g)	
0 - 25mm	0.01mm	295-115 <sup>S-F</sup>	±3µm	D: 10mm	220	
		295-215 <sup>S-S</sup>	±3µm	D: 10mm	220	

S-F: Spherical anvil and flat spindle  
 S-S: Spherical anvil and spherical spindle

Inch		Mechanical counter model with spherical anvil				
Range	Graduation	Order No.	Accuracy	Remarks	Mass (g)	
0 - 1"	.0001"	295-153 <sup>S-F*</sup>	±.00015"	D: .40"	220	
		295-253 <sup>S-S*</sup>	±.00015"	D: .40"	220	

S-F: Spherical anvil and flat spindle  
 S-S: Spherical anvil and spherical spindle  
 \*.0001" reading is obtained with vernier.

Metric		With spherical anvil				
Range	Graduation	Order No.	Accuracy	Remarks	Mass (g)	
0 - 25mm	0.01mm	115-115 <sup>S-F</sup>	±3µm	D: 10mm	180	
		115-215 <sup>S-S</sup>	±3µm	D: 10mm	180	
25 - 50mm	0.01mm	115-116 <sup>S-F</sup>	±3µm	D: 11mm	240	
		115-216 <sup>S-S</sup>	±3µm	D: 11mm	240	
50 - 75mm	0.01mm	115-117 <sup>S-F</sup>	±3µm	D: 17mm	315	
		115-217 <sup>S-S</sup>	±3µm	D: 17mm	315	
75 - 100mm	0.01mm	115-118 <sup>S-F</sup>	±4µm	D: 18mm	375	
		115-218 <sup>S-S</sup>	±4µm	D: 18mm	375	

S-F: Spherical anvil and flat spindle  
 S-S: Spherical anvil and spherical spindle

Inch		With spherical anvil				
Range	Graduation	Order No.	Accuracy	Remarks	Mass (g)	
0 - 1"	.0001"	115-153 <sup>S-F*</sup>	±.00015"	D: .40"	180	
0 - 1"	.0001"	115-253 <sup>S-S*</sup>	±.00015"	D: .40"	180	
1 - 2"	.001"	115-242 <sup>S-S</sup>	±.00015"	D: .44"	240	
2 - 3"	.001"	115-243 <sup>S-S</sup>	±.00015"	D: .67"	315	

S-F: Spherical anvil and flat spindle  
 S-S: Spherical anvil and spherical spindle  
 \*.0001" reading is obtained with vernier.

# Tube Micrometers

**SERIES 395, 295, 115— Spherical and Cylindrical Anvils**



## FEATURES

- IP65 water/dust protection (Series 395).
- Designed to measure the wall thickness of various tubing.
- The Tube Micrometers have two combinations of measuring faces (carbide-tipped): spherical-flat type.
- With ratchet stop for constant force.
- With SPC output (Series 395).
- With digit counter (Series 295).
- With a standard bar except 0 -1" and 0 - 25mm model.
- Supplied in fitted plastic case.
- Non-slip grip finish (digital models).

### Pin Anvil Type



## SPECIFICATIONS

Metric — Digital model with cylindrical anvil					
Range	Resolution	Order No.	Accuracy	Remarks	Mass (g)
0 - 25mm	0.001mm	395-261-30	±3µm	Type A	270
		395-262-30	±3µm	Type B	270
		395-263-30	±3µm	Type C	310
		395-264-30	±3µm	Type D	310

Metric — Mechanical counter model					
Range	Graduation	Order No.	Accuracy	Remarks	Mass (g)
0 - 25mm	0.01mm	295-302	±3µm	Type A	210

Metric — With cylindrical anvil					
Range	Graduation	Order No.	Accuracy	Remarks	Mass (g)
0 - 25mm	0.01mm	115-302	±3µm	Type A	180
		115-308	±3µm	Type B	180
		115-315	±3µm	Type C	180
		115-316	±3µm	Type D	180
25 - 50mm	0.01mm	115-303	±3µm	Type A	240
		115-309	±3µm	Type B	240

Inch/Metric — Digital model with cylindrical anvil					
Range	Resolution	Order No.	Accuracy	Remarks	Mass (g)
0 - 1" / 0 - 25.4mm	.00005" / 0.001mm	395-362-30	±.00015"	Type B	270
		395-363-30	±.00015"	Type C	310
		395-364-30	±.00015"	Type D	310

Inch — Mechanical counter model					
Range	Graduation	Order No.	Accuracy	Remarks	Mass (g)
0 - 1"	.0001"	295-313	±.00015"	Type C	210
		295-314	±.00015"	Type D	210

Inch — With cylindrical anvil					
Range	Graduation	Order No.	Accuracy	Remarks	Mass (g)
0 - 1"	.0001"	115-305	±.00015"	Type A	180
		115-313*	±.00015"	Type C	180
		115-314*	±.00015"	Type D	180

\*.0001" reading is obtained with vernier.

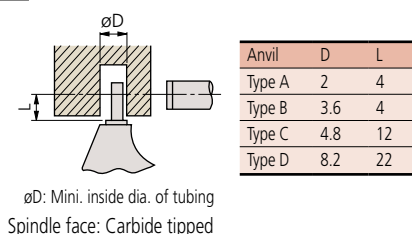
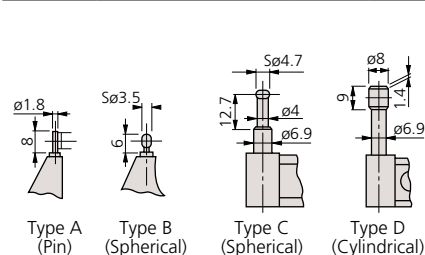

## Technical Data

Accuracy: Refer to the list of specifications.  
 Flatness: .000024" / 0.6µm  
 Display\*: LCD  
 Battery\*: SR44 (1 pc.), **938882**  
 Battery life\*: Approx. 2.4 years under normal use  
 Dust/Water protection level\*: IP65  
 \*Digital models

## Function of Digital Model

Origin-set, Zero / ABS, Data hold, Data output, inch/mm conversion (on inch/metric models only)  
 Function lock  
 Alarm: Low voltage, Counting value composition error

## Optional Accessories for Digital Model

**05CZA662:** SPC cable with data switch (40" / 1m)  
**05CZA663:** SPC cable with data switch (80" / 2m)





www.tuv.com  
ID: 000046191

### Technical Data

Accuracy: Refer to the list of specifications.  
Resolution\*: .00005"/0.001mm or 0.001mm  
Graduation\*\*\*: .0001" or 0.01mm  
Spindle face: Carbide tipped  
Display\*: LCD  
Battery\*: SR44 (1 pc.), **938882**  
Battery life\*: Approx. 2.4 years under normal use  
Dust/Water protection level\*: IP65  
\*Digital models \*\*Analog models

### Function of Digital Model

Origin-set, Zero / ABS, Data hold, Data output,  
inch/mm conversion (on inch/metric models only)  
Function Lock  
Alarm: Low voltage, Counting value composition error

### Optional Accessories

**05CZA662**: SPC cable with data switch (40" / 1m)\*  
**05CZA663**: SPC cable with data switch (80" / 2m)\*  
**201218**: V-anvil  
**950758**: Disc. anvil for 1" / 25m models

\*Only for digital models.

### Applications

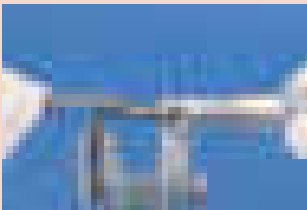

Using flat anvil (201216)

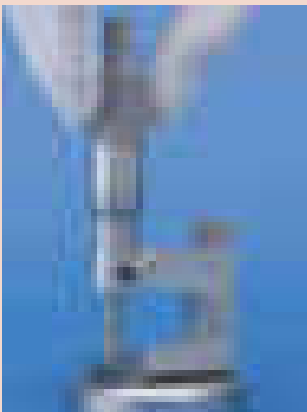

With the disc. anvil (950758) Shown above, the Uni-Mike is used as a height micrometer.

# "Uni-Mike"

## SERIES 317, 117 — Interchangeable Anvil Type

### FEATURES

- IP65 water/dust protection (Series 317).
- Measures tubing thickness, shoulder-edge distance, rivet head height, etc. with interchangeable anvils (flat anvil, rod anvil, V-anvil).
- Supplied with Flat Anvil (**201216**) and Rod Anvil: .118"/ø3mm dia. rod anvil (**201217**) for 0-1"/0-25mm models, .197"/ø5mm (**201379**) for 1-2" / 25-50mm model.
- With special Disk Anvils. The Uni-Mike is used as a height micrometer. The disks have a lapped, mirror surface.
- With a standard bar except 0-1" and 0-25mm model.
- Supplied in fitted plastic case.
- Non-slip grip finish (digital models)



317-351-30

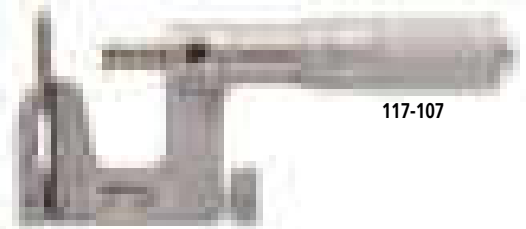

117-107

### SPECIFICATIONS

**Metric** Digital model with ratchet stop

Range	Resolution	Order No.	Accuracy	Mass (g)
0 - 25mm	0.001mm	<b>317-251-30</b>	±4µm	335
25 - 50mm	0.001mm	<b>317-252-30</b>	±4µm	360

Excluding quantizing error

**Inch/Metric** Digital model with friction thimble

Range	Resolution	Order No.	Accuracy	Mass (g)
0 - 1" / 0 - 25.4mm	.00005" / 0.001mm	<b>317-351-30</b>	±.0002"	340
1 - 2" / 25.4 - 50.8mm	.00005" / 0.001mm	<b>317-352-30</b>	±.0002"	365

Excluding quantizing error

**Metric** With ratchet stop

Range	Graduation	Order No.	Accuracy	Mass (g)
0 - 25mm	0.01mm	<b>117-101</b>	±4µm	255
25 - 50mm	0.01mm	<b>117-102</b>	±4µm	320

**Inch** With friction thimble

Range	Graduation	Order No.	Accuracy	Mass (g)
0 - 1"	.0001"	<b>117-107*</b>	±.0002"	255
1 - 2"	.0001"	<b>117-108*</b>	±.0002"	320

\*.0001" reading is obtained with vernier.

### DIMENSIONS

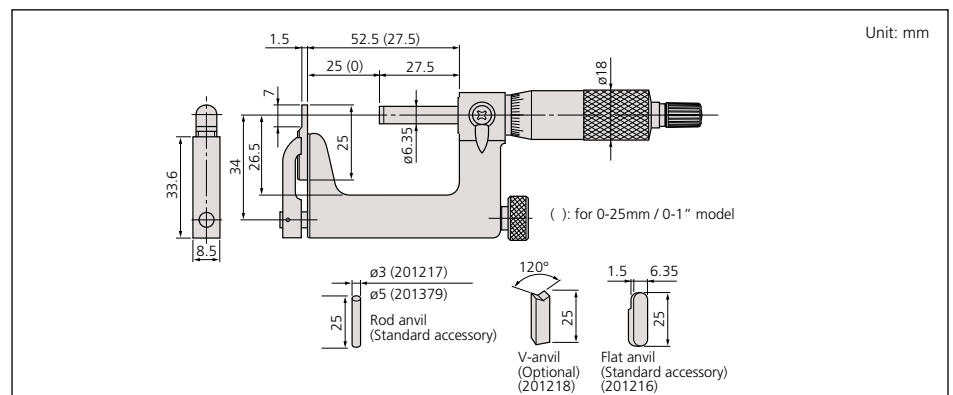

# Sheet Metal Micrometers

**SERIES 389, 119, 118**



## FEATURES

- Measures thickness of sheet metal, paper, plastic and rubber parts.
- With ratchet stop for constant force.
- With a standard bar except for 0 - 1" / 0 - 25mm model.
- IP65 water/dust protection (Series 389\*).
- Supplied in fitted plastic case.
- Non-slip grip finish (digital models).



## DIMENSIONS

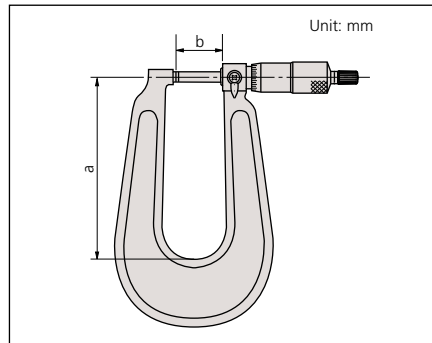

## Technical Data

Accuracy: Refer to the list of specifications  
 Resolution\*: .00005"/0.001mm or 0.001mm  
 Graduation\*\*\*: 0.01mm, .001" or .0001"  
 Flatness: .000024" / 0.6µm for models with 6" / 150mm throat  
 .00004" / 1µm for models with 12" / 300mm throat  
 Parallelism: .00012" / 3µm  
 Measuring faces: Carbide tipped  
 Display\*: LCD  
 Battery\*: SR44 [1 pc. (2 pcs.: 389-514 and 389-714)], 938882  
 Battery life\*: Approx. 2.4 years under normal use (1.8 years: 389-514 and 389-714)  
 Dust/Water protection level\*: IP65  
 \*Digital models \*\*Analog models

## Function of Digital Model

Origin-set, Zero-setting, Data hold, Data output, inch/mm conversion (on inch/metric models only)  
 Function lock  
 Alarm: Low voltage, Counting value composition error

## Optional Accessories for Digital Model

- 05CZA662:** SPC cable with data switch (40" / 1m)
- 05CZA663:** SPC cable with data switch (80" / 2m)
- 04AZB512:** SPC cable for 389-514/389-714 (40" / 1m)
- 04AZB513:** SPC cable for 389-514/389-714 (80" / 2m)

## SPECIFICATIONS

Metric		Digital model			
Range	Resolution	Order No.	Accuracy	a/b	
0 - 25mm	0.001mm	389-251-30	±4µm	160/27.5mm	
0 - 25mm	0.001mm	389-261-30 <sup>S-F</sup>	±4µm	160/27.5mm	
0 - 25mm	0.001mm	389-271-30 <sup>S-S</sup>	±4µm	160/27.5mm	
0 - 25mm	0.001mm	389-514	±5µm	330/35mm	
25 - 50mm	0.001mm	389-252-30	±4µm	165/27.5mm	
25 - 50mm	0.001mm	389-262-30 <sup>S-F</sup>	±4µm	165/27.5mm	
25 - 50mm	0.001mm	389-272-30 <sup>S-S</sup>	±4µm	165/27.5mm	

S-F: Spherical anvil and flat spindle  
 S-S: Spherical anvil and spherical spindle

Inch/Metric		Digital model			
Range	Resolution	Order No.	Accuracy	a/b	
0 - 1" / 0 - 25.4mm	.00005" / 0.001mm	389-351-30	±.0002"	6.3"/1.08"	
		389-361-30 <sup>S-F</sup>	±.0002"	6.3"/1.08"	
		389-371-30 <sup>S-S</sup>	±.0002"	6.3"/1.08"	
		389-714	±.00025"	13"/1.38"	
1 - 2" / 25.4 - 50.8mm	.00005" / 0.001mm	389-352-30	±.0002"	6.5"/1.08"	
		389-362-30 <sup>S-F</sup>	±.0002"	6.5"/1.08"	
		389-372-30 <sup>S-S</sup>	±.0002"	6.5"/1.08"	

S-F: Spherical anvil and flat spindle  
 S-S: Spherical anvil and spherical spindle

Metric		Dial reading model			
Range	Graduation	Order No.	Accuracy	a/b	
0 - 25mm	0.01mm	118-101	±4µm	110/27.5mm	
0 - 25mm	0.01mm	118-102	±4µm	160/27.5mm	
0 - 25mm	0.01mm	118-114 <sup>S-F</sup>	±4µm	160/27.5mm	
0 - 25mm	0.01mm	118-118 <sup>S-S</sup>	±4µm	160/27.5mm	
0 - 25mm	0.01mm	118-103	±5µm	330/35mm	
25 - 50mm	0.01mm	118-110	±4µm	165/27.5mm	

S-F: Spherical anvil and flat spindle  
 S-S: Spherical anvil and spherical spindle

Inch		Dial reading model			
Range	Graduation	Order No.	Accuracy	a/b	
0 - 1"	.0001"	118-129	±.0002"	6.3"/1.08"	
		118-116 <sup>S-F</sup>	±.0002"	6.3"/1.08"	
		118-120 <sup>S-S</sup>	±.0002"	6.3"/1.08"	
1" - 2"	.001"	118-107	±.00025"	13"/1.38"	
		118-112	±.0002"	6.5"/1.08"	

S-F: Spherical anvil and flat spindle  
 S-S: Spherical anvil and spherical spindle  
 \*.0001" reading is obtained with vernier.

## DIMENSIONS AND MASS

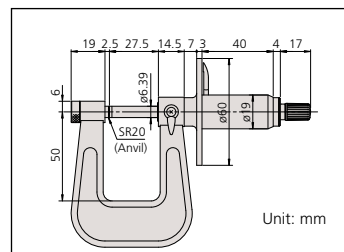

## Anvil-Spindle Combinations



Standard, Flat-Flat



Spherical-Flat (S-F)



Spherical-Spherical (S-S)

The Series 119 is provided with a dial for making easy and quick readings.

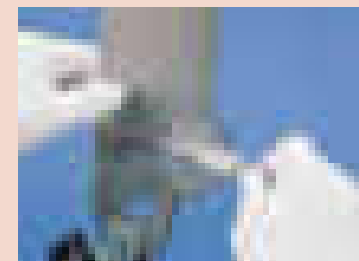

## Technical Data

Accuracy: Refer to the list of specifications  
 Resolution\*: .00005" / 0.001mm or 0.001mm  
 Graduation\*\*: .0001" or 0.01mm  
 Parallelism: .00012" / 3µm for models up to 3" / 75mm  
 (3+R/100)µm for models over 75mm,  
 R=max. range (mm) .00016" for 4" models  
 Display\*: LCD  
 Battery\*: SR44 (1 pc.), **938882**  
 Battery life\*: Approx. 2.4 years under normal use  
 \*Digital models \*\*Analog models

## Function of Digital Model

Origin-set, Zero / ABS, Data hold, Data output,  
 inch/mm conversion (on inch/metric models only)  
 Function lock  
 Alarm: Low voltage, Counting value composition error

## Optional Accessories for Digital Model

**05CZA662**: SPC cable with data switch (1m / 40")  
**05CZA663**: SPC cable with data switch (2m / 80")  
**937387**: SPC cable for Quickmike type (1m / 40")  
**965013**: SPC cable for Quickmike type (2m / 80")

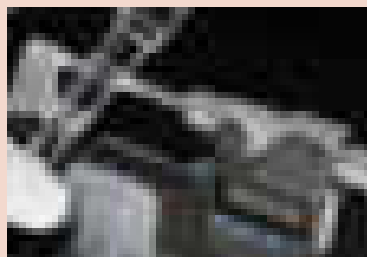

# Blade Micrometers

## SERIES 422,122 — Non-Rotating Spindle Type

### FEATURES

- The anvil and the spindle have a blade for measuring the groove diameter of shafts, keyways and other hard-to-reach areas.
- With ratchet stop for constant force.
- Non-slip grip finish (digital models).
- Speedy spindle feed of .4"/10mm /rev. (Quickmike type).
- With a standard bar except 0 - 1" and 0 - 25mm model.
- Supplied in fitted plastic case.

### Quickmike type



422-421



422-330-30



122-125



**ABSOLUTE**  
 Analog System Powered by MITSUBISHI

## SPECIFICATIONS

### Metric Digital model

Range	Resolution	Order No.	Accuracy	Remarks	Mass (g)
0 - 25mm	0.001mm	422-230-30	±3µm	Type A	365
		422-260-30	±3µm	Type B	365
		422-270-30	±3µm	Type C	365
		422-271-30	±3µm	Type D	365
25 - 50mm	0.001mm	422-231-30	±3µm	Type A	565
		422-261-30	±3µm	Type B	565
50 - 75mm	0.001mm	422-232-30	±3µm	Type A	465
75 - 100mm	0.001mm	422-233-30	±4µm	Type A	580

### Metric Quickmike type

Range	Resolution	Order No.	Accuracy	Mass (g)
0 - 30mm	0.001mm	422-411	±3µm	350
25 - 55mm	0.001mm	422-412	±3µm	490

### Metric

Range	Graduation	Order No.	Accuracy	Remarks	Mass (g)
0 - 25mm	0.01mm	122-101	±3µm	Type A	260
		122-111	±3µm	Type B	260
		122-161	±3µm	Type C	275
		122-141	±3µm	Type D	275
25 - 50mm	0.01mm	122-102	±3µm	Type A	300
		122-112	±3µm	Type B	300
		122-162	±3µm	Type C	315
		122-142	±3µm	Type D	315
50 - 75mm	0.01mm	122-103	±3µm	Type A	360
75 - 100mm	0.01mm	122-104	±4µm	Type A	525
100 - 125mm	0.01mm	122-105	±4µm	Type A	670
125 - 150mm	0.01mm	122-106	±4µm	Type A	775
150 - 175mm	0.01mm	122-107	±5µm	Type A	950
175 - 200mm	0.01mm	122-108	±5µm	Type A	1140

### Inch/Metric Digital model

Range	Resolution	Order No.	Accuracy	Remarks	Mass (g)
0 - 1" / 0 - 25.4mm	.00005" / 0.001mm	422-330-30	±.00015"	Type A	365
		422-360-30	±.00015"	Type B	365
		422-370-30	±.00015"	Type C	365
		422-371-30	±.00015"	Type D	365
1 - 2" / 25.4 - 50.8mm	.00005" / 0.001mm	422-331-30	±.00015"	Type A	565
		422-361-30	±.00015"	Type B	565
2 - 3" / 50.8 - 76.2mm	.00005" / 0.001mm	422-332-30	±.00015"	Type A	465
3 - 4" / 76.2 - 101.6mm	.00005" / 0.001mm	422-333-30	±.0002"	Type A	580

### Inch/Metric Quickmike type

Range	Resolution	Order No.	Accuracy	Remarks	Mass (g)
0 - 1.2" / 0 - 30.48mm	.00005" / 0.001mm	422-421	±.00015"	Type A	350
1 - 2.2" / 25.4 - 55.88mm	.00005" / 0.001mm	422-422	±.00015"	Type A	490

### Inch

Range	Graduation	Order No.	Accuracy	Remarks	Mass (g)
0 - 1"	.0001"	122-125	±.00015"	Type A	260
		122-135	±.00015"	Type B	260
		122-151	±.00015"	Type D	275
1 - 2"	.0001"	122-126	±.00015"	Type A	300
2 - 3"	.0001"	122-127	±.00015"	Type A	360
3 - 4"	.0001"	122-128	±.0002"	Type A	525

## TYPE AND DIMENSIONS

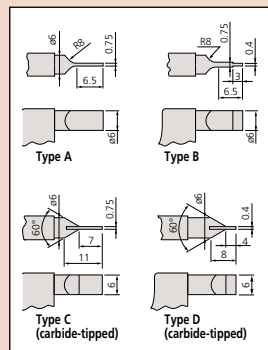

# Disk Micrometers

## SERIES 323, 223, 123 - Rotating Spindle



### FEATURES

- Diameter of measuring disk: .787" / 20mm.
- .028" / 0.7mm (1mm: models over 100mm) edge thickness to enter narrow recesses.
- With ratchet stop for constant force.
- Non-slip grip finish (digital models).
- With a standard bar except for 0 - 1" / 0 - 25mm model.
- With SPC output (Series 323).
- The Series 223 is provided with a mechanical digit counter for quick reading of measurements.
- Supplied in fitted plastic case. (Over 100mm models supplied wooden cases).



123-125



323-350-30

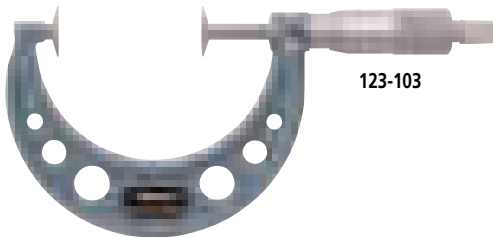

123-103



223-125

### Technical Data

Accuracy: Refer to the list of specifications  
 Resolution\*: .00005"/0.001mm or 0.001mm  
 Graduation\*\*: .001" or 0.01mm  
 Flatness: .00004" / 1µm for models up to 4"/100mm  
 .000063" / 1.6µm for models over 4" / 100mm  
 Parallelism: .00016" / 4µm for models up to 2"/50mm  
 .00024" for models up to 4"  
 (4+R/50)µm for models up to 100mm  
 (5+R/75)µm for models over 100mm, R=max. range (mm)  
 Measurable module: 0.5-6 (0.7-11: models over 100mm)  
 Display\*: LCD  
 Battery\*: SR44 (1 pc.), 938882  
 Battery life\*: Approx. 2.4 years under normal use  
 \*Digital models \*\*Analog models

### Function of Digital Model

Origin-set, Zero / ABS, Data hold, Data output, inch/mm conversion (on inch/metric models only)  
 Function lock  
 Alarm: Low voltage, Counting value composition error

### Optional Accessories for Digital Model

- 05CZA662:** SPC cable with data switch (40" / 1m)
- 05CZA663:** SPC cable with data switch (80" / 2m)

### SPECIFICATIONS

Metric		Digital model			
Range	Resolution	Order No.	Accuracy	Mass (g)	
0 - 25mm	0.001mm	323-250-30	±4µm	290	
25 - 50mm	0.001mm	323-251-30	±4µm	355	
50 - 75mm	0.001mm	323-252-30	±6µm	555	
75 - 100mm	0.001mm	323-253-30	±6µm	610	

Inch/Metric		Digital model			
Range	Resolution	Order No.	Accuracy	Mass (g)	
0 - 1" / 0 - 25.4mm	.00005" / 0.001mm	323-350-30	±.0002"	290	
1 - 2" / 25.4 - 50.8mm	.00005" / 0.001mm	323-351-30	±.0002"	355	
2 - 3" / 50 - 76.2mm	.00005" / 0.001mm	323-352-30	±.0003"	555	
3 - 4" / 76.2 - 101.6mm	.00005" / 0.001mm	323-353-30	±.0003"	610	

Metric		Mechanical counter model			
Range	Graduation	Order No.	Accuracy	Mass (g)	
0 - 25mm	0.01mm	223-101	±4µm	260	
25 - 50mm	0.01mm	223-102	±4µm	290	

Inch		Mechanical counter model			
Range	Graduation	Order No.	Accuracy	Mass (g)	
0 - 1"	.001"	223-125	±.0002"	260	

Metric					
Range	Graduation	Order No.	Accuracy	Mass (g)	
0 - 25mm	0.01mm	123-101	±4µm	200	
		123-113*	±4µm	230	
		123-102	±4µm	250	
25 - 50mm	0.01mm	123-114*	±4µm	270	
		123-103	±6µm	300	
50 - 75mm	0.01mm	123-115*	±6µm	320	
		123-104	±6µm	375	
75 - 100mm	0.01mm	123-116*	±6µm	390	
		123-105	±7µm	520	
125 - 150mm	0.01mm	123-106	±7µm	570	
150 - 175mm	0.01mm	123-107	±8µm	730	
175 - 200mm	0.01mm	123-108	±8µm	890	
200 - 225mm	0.01mm	123-109	±8µm	1000	
225 - 250mm	0.01mm	123-110	±9µm	1200	
250 - 275mm	0.01mm	123-111	±9µm	1410	
275 - 300mm	0.01mm	123-112	±9µm	1680	

Inch					
Range	Graduation	Order No.	Accuracy	Mass (g)	
0 - 1"	.001"	123-125	±.0002"	200	
1 - 2"	.001"	123-126	±.0002"	250	
2 - 3"	.001"	123-127	±.0003"	300	
3 - 4"	.001"	123-128	±.0003"	375	

### Root tangent length of gear (En)

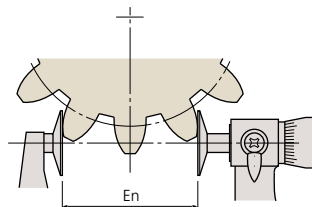

Note: Root tangent length measurement is not available for some types of gears.



\*The measuring disks have carbide tips.  
 Note: The disk diameter of models over 100mm is 30mm.

# DIMENSIONS

Unit: mm

## Digital models up to 75mm

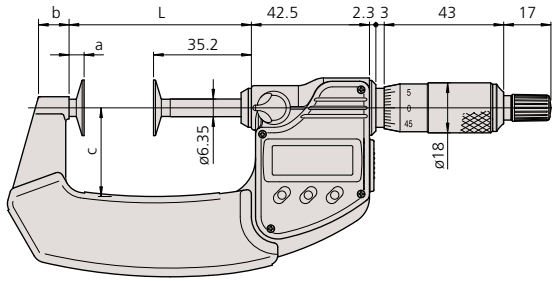

## Analog models up to 50mm

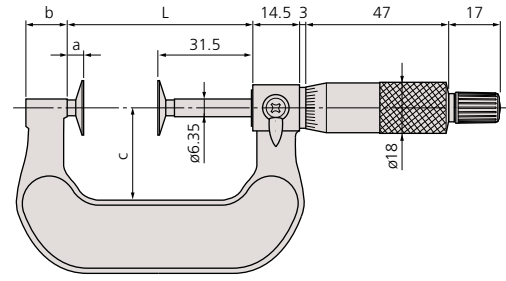

## Digital models up to 75mm

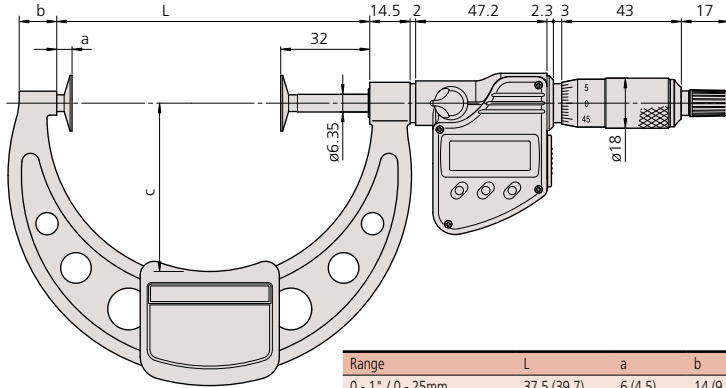

## Analog over 50mm

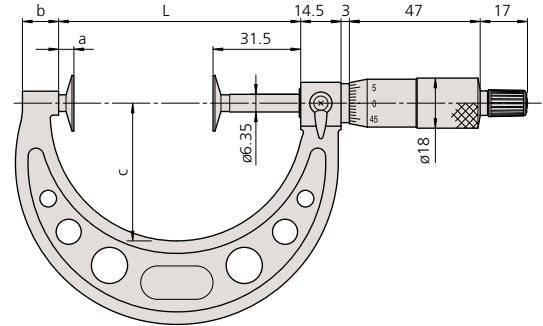

Range	L	a	b	c	ød	øe	t
0 - 1" / 0 - 25mm	37.5 (39.7)	6 (4.5)	14 (9.2)	25 (25.4)	20	8 (9.8)	0.7
1 - 2" / 25 - 50mm	62.5 (65.6)	6 (5.4)	14 (11)	32 (31.9)	20	8 (9.8)	0.7
2 - 3" / 50 - 75mm	87 (90.7)	5.5 (5.5)	11 (12.2)	49 (50)	20	8 (9.8)	0.7
3 - 4" / 75 - 100mm	112 (112.5)	5.5 (5.5)	11 (13.5)	63 (60.5)	20	8 (9.8)	0.7
4 - 5" / 100 - 125mm	137.5	6	12	79	30	12	1
5 - 6" / 125 - 150mm	162.5	6	15	94	30	12	1
6 - 7" / 150 - 175mm	187.5	6	16	106	30	12	1
7 - 8" / 175 - 200mm	212.5	6	15	118	30	12	1
8 - 9" / 200 - 225mm	237.5	6	14	130	30	12	1
9 - 10" / 225 - 250mm	262.5	6	14	143	30	12	1
10 - 11" / 250 - 275mm	287.5	6	15	156	30	12	1
11 - 12" / 275 - 300mm	312.5	6	15	169	30	12	1

Data in ( ) applies to those with carbide tipped disks.

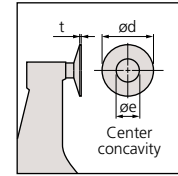

## Technical Data

Graduation: .001" or 0.01mm  
 Flatness: .00004" / 1µm  
 Parallelism: .00012" / 3µm  
 Measuring Force: 8.02 ±0.8N  
 53.9KPa ±4.9 KPa

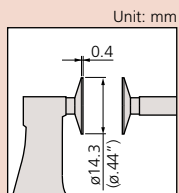
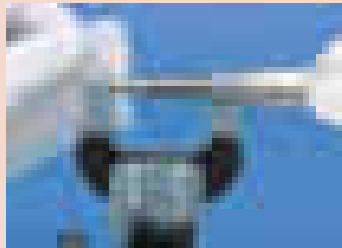

( ) : Inch model

# Paper Thickness Micrometers

## SERIES 169 — Non-Rotating Spindle Type Designed for Paper Thickness Measurement

### FEATURES

- Non-rotating spindle.
- With ratchet stop for constant force.
- Supplied in fitted plastic case.



169-101

### SPECIFICATIONS

Metric				
Range	Graduation	Order No.	Accuracy	Mass (g)
0 - 25mm	0.01mm	169-101	±4µm	230g

### DIMENSIONS

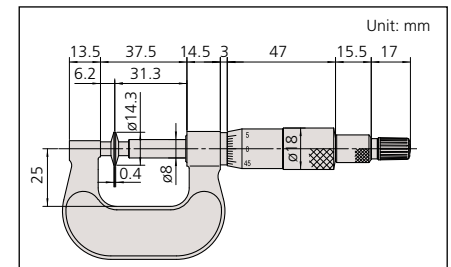

Inch				
Range	Graduation	Order No.	Accuracy	Mass (g)
0 - 1"	.001"	169-103	±.0002"	230g

# Disk Micrometers

## SERIES 369, 227, 169 — Non-Rotating Spindle Type



### FEATURES

- The Disk Micrometer is designed to easily measure root tangent length of spur gears and helical gears.
- Non-rotating spindle eliminates torque on workpiece.
- With standard bar except 0 - 15mm, 0 - .6" 0 - 25mm, 0 - 1", 0 - 30mm & 0 - 1.2" model.
- Speedy spindle feed of 10mm/rev. (Quickmike type).
- Diameter of measuring disk: .787" / 20mm
- With ratchet stop for constant force.
- With SPC output (Series 369).
- Supplied in fitted plastic case.
- Non-slip grip finish (digital models).

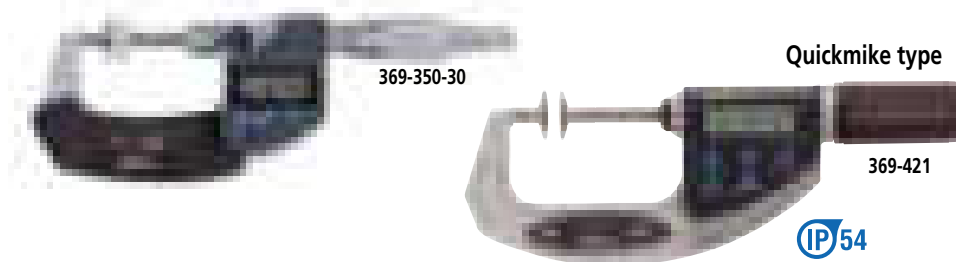

Quickmike type with adjustable measuring force



### Technical Data

Accuracy: Refer to the list of specifications  
 Resolution\*: .00005"/0.001mm or 0.001mm  
 Graduation\*\*: .001" or 0.01mm  
 Flatness: .00004" / 1µm  
 Parallelism: 4µm / .00016" for models up to 2" / 50mm  
 6µm / .00024" for models over 2" / 50mm  
 Measurable module: 0.5-6  
 Display\*: LCD  
 Battery\*: SR44 (1 pc.), **938882**  
 Battery life\*: Approx. 2.4 years under normal use  
 (1 year: Quickmike type, 3 years: Quickmike type with fine-loading)  
 Series 227: Refer to page B-6 for more information.  
 \*Digital models \*\*Analog models

### Function of Digital Model

Origin-set, Zero / ABS, Data hold, Data output, inch/mm conversion (on inch/metric models only)  
 Function lock  
 Alarm: Low voltage, Counting value composition error

### Optional Accessories for Digital Model

- 05CZA662**: SPC cable with data switch (40" / 1m)
- 05CZA663**: SPC cable with data switch (80" / 2m)
- 937387**: SPC cable for Quickmike type (40" / 1m)
- 965013**: SPC cable for Quickmike type (80" / 2m)

### SPECIFICATIONS

Metric		Digital model	
Range	Resolution	Order No.	Accuracy
0 - 25mm	0.001mm	<b>369-250-30</b>	±4µm
25 - 50mm	0.001mm	<b>369-251-30</b>	±4µm
50 - 75mm	0.001mm	<b>369-252-30</b>	±6µm
75 - 100mm	0.001mm	<b>369-253-30</b>	±6µm

Inch/Metric		Digital model	
Range	Resolution	Order No.	Accuracy
0 - 1" / 0 - 25.4mm	.00005" / 0.001mm	<b>369-350-30</b>	±.0002"
1 - 2" / 25.4 - 50.8mm	.00005" / 0.001mm	<b>369-351-30</b>	±.0002"
2 - 3" / 50.8 - 76.2mm	.00005" / 0.001mm	<b>369-352-30</b>	±.0003"
3 - 4" / 76.2 - 101.6mm	.00005" / 0.001mm	<b>369-353-30</b>	±.0003"

Metric		Quickmike type	
Range	Resolution	Order No.	Accuracy
0 - 30mm	0.001mm	<b>369-411</b>	±4µm
25 - 55mm	0.001mm	<b>369-412</b>	±4µm

Inch/Metric		Quickmike type	
Range	Resolution	Order No.	Accuracy
0 - 1.2" / 0 - 30.48mm	.00005" / 0.001mm	<b>369-421</b>	±.0002"
1 - 2.2" / 25.4 - 55.88mm	.00005" / 0.001mm	<b>369-422</b>	±.0002"

Metric		Quickmike type with adjustable measuring force		
Range	Resolution	Order No.	Accuracy	Measuring force
0 - 10mm	0.001mm	<b>227-223</b>	±4µm	2N - 10N
0 - 15mm	0.001mm	<b>227-221</b>	±4µm	0.5N - 2.5N

Metric			
Range	Graduation	Order No.	Accuracy
0 - 25mm	0.01mm	<b>169-201</b>	±4µm
25 - 50mm	0.01mm	<b>169-202</b>	±4µm
50 - 75mm	0.01mm	<b>169-205</b>	±6µm
75 - 100mm	0.01mm	<b>169-207</b>	±6µm

Inch			
Range	Graduation	Order No.	Accuracy
0 - 1"	.001"	<b>169-203</b>	±.0002"
1 - 2"	.001"	<b>169-204</b>	±.0002"
2 - 3"	.001"	<b>169-206</b>	±.0003"
3 - 4"	.001"	<b>169-208</b>	±.0003"



## DIMENSIONS AND MASS

Unit: mm

### Digital models up to 75mm

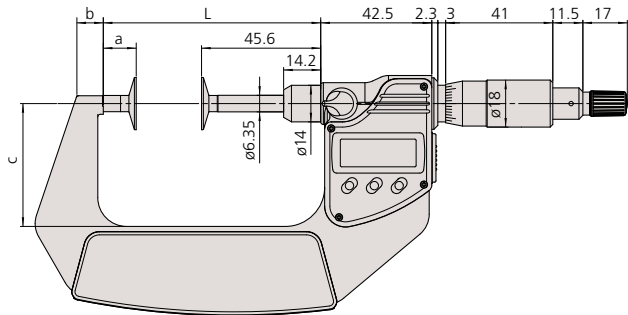

### Adjustable measuring force type

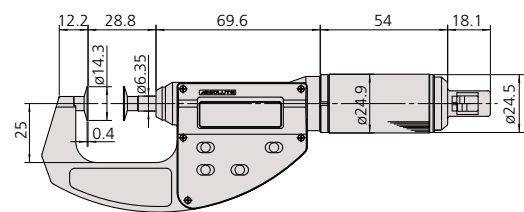

### Digital models over 75mm

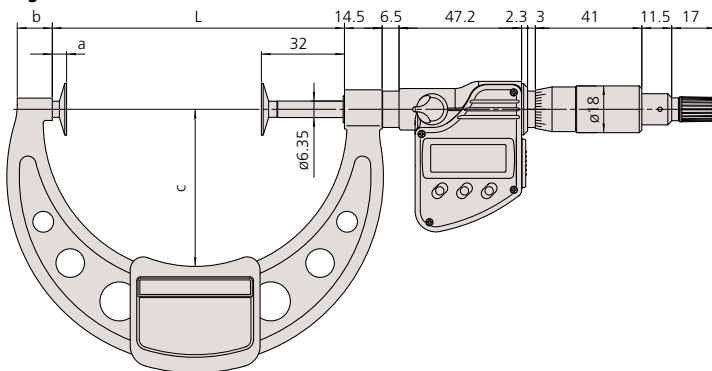

### Analog models up to 50mm

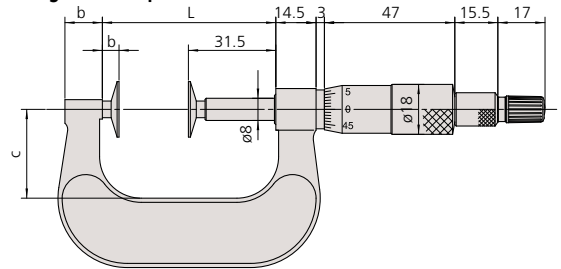

### Quickmike type

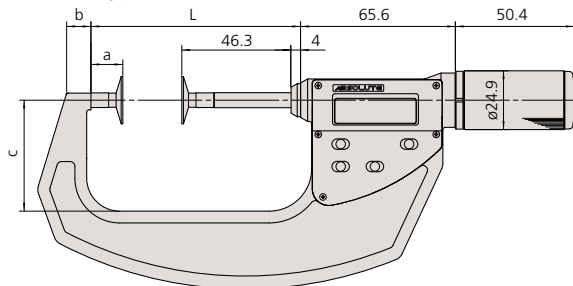

### Analog models over 50mm

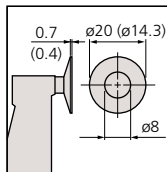
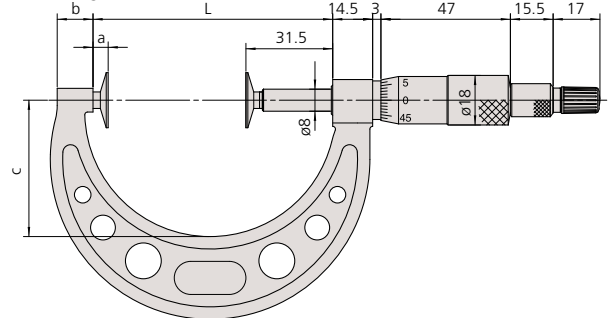

( ): Adjustable measuring force type

### Digital model

Range	L	a	b	c	Mass (g)
0 - 25mm / 0 - 1"	58.5	12.9	7	32	340
25 - 50mm / 1 - 2"	83.5	12.9	9.8	47	480
50 - 75mm / 2 - 3"	108.5	12.9	11.2	60	635
75 - 100mm / 3 - 4"	112.5	5.5	13.5	60.5	475
0 - 30mm* / 0 - 1.2"	63.8	13.5	8.5	36	360
25 - 55mm* / 1 - 2.2"	88.8	13.5	10.3	47	490

\*Quickmike type

### Analog model

Range	L	a	b	c	Mass (g)
0 - 25mm / 0 - 1"	37.5	6	13.5	25	230
25 - 50mm / 1 - 2"	62.5	6	13.5	32	280
50 - 75mm / 2 - 3"	87	5.5	13	49.5	315
75 - 100mm / 3 - 4"	112	5.5	13	63.5	400

# Gear Tooth Micrometers

## SERIES 324, 124 — Interchangeable Ball Anvil-Spindle Type



### FEATURES

- IP65 water/dust protection (Series 324).
- Measures over-pin diameter of gears with precision steel (carbide) ball-tipped measuring faces.
- With a standard bar except 0 - 25mm and 0 - 1" model
- Non-slip grip finish (digital models)
- Interchangeable ball anvil-spindle tips for various gear modules (0.5 - 5.25) are optional.
- With Ratchet Stop for constant force.
- With SPC output (Series 324).
- Supplied in fitted plastic case (Models over 150mm have wooden case).

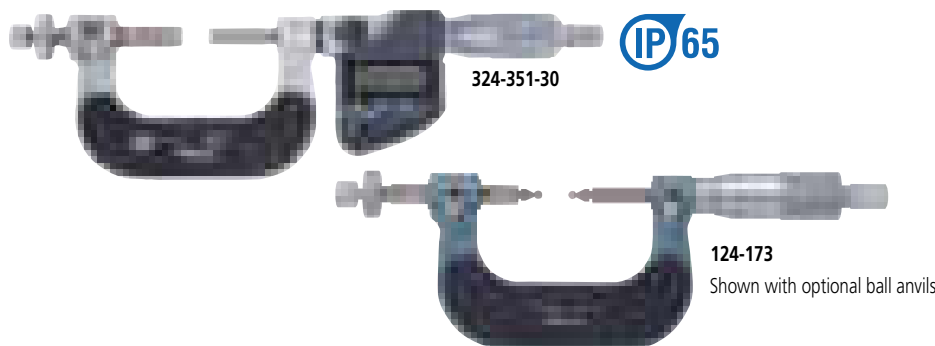

### SPECIFICATIONS

Metric		Digital model		
Range	Resolution	Order No.	Accuracy	Mass (g)
0 - 25mm	0.001mm	<b>324-251-30</b>	±4µm	400
25 - 50mm	0.001mm	<b>324-252-30</b>	±4µm	490
50 - 75mm	0.001mm	<b>324-253-30</b>	±4µm	530
75 - 100mm	0.001mm	<b>324-254-30</b>	±5µm	600

Inch/Metric		Digital model		
Range	Resolution	Order No.	Accuracy	Mass (g)
0 - 1" / 0 - 25mm	.00005" / 0.001mm	<b>324-351-30</b>	±.0002"	400
1 - 2" / 25 - 50mm	.00005" / 0.001mm	<b>324-352-30</b>	±.0002"	490
2 - 3" / 50 - 75mm	.00005" / 0.001mm	<b>324-353-30</b>	±.0002"	530
3 - 4" / 75 - 100mm	.00005" / 0.001mm	<b>324-354-30</b>	±.00025"	600

Metric				
Range	Graduation	Order No.	Accuracy	Mass (g)
0 - 25mm	0.01mm	<b>124-173</b>	±4µm	295
25 - 50mm	0.01mm	<b>124-174</b>	±4µm	400
50 - 75mm	0.01mm	<b>124-175</b>	±4µm	460
75 - 100mm	0.01mm	<b>124-176</b>	±5µm	540
100 - 125mm	0.01mm	<b>124-177</b>	±5µm	640
125 - 150mm	0.01mm	<b>124-178</b>	±5µm	760
150 - 175mm	0.01mm	<b>124-179</b>	±6µm	900
175 - 200mm	0.01mm	<b>124-180</b>	±6µm	1060
200 - 225mm	0.01mm	<b>124-181</b>	±6µm	1230
225 - 250mm	0.01mm	<b>124-182</b>	±7µm	1430
250 - 275mm	0.01mm	<b>124-183</b>	±7µm	1620
275 - 300mm	0.01mm	<b>124-195</b>	±7µm	2070



### DIMENSIONS AND MASS

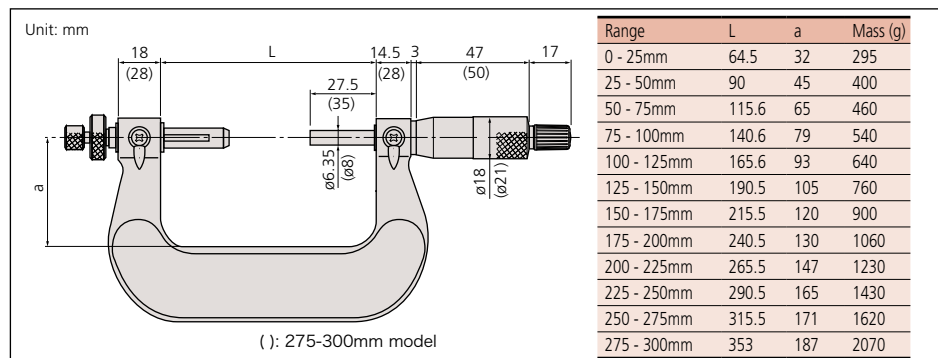

### Technical Data

Accuracy: Refer to the list of specifications  
 Resolution\*: 0.001mm or .00005"/0.001mm  
 Graduation\*\*: 0.01mm  
 Display\*: LCD  
 Battery\*: SR44 (1 pc.), **938882**  
 Battery life\*: Approx. 2.4 years under normal use  
 Dust/Water protection level\*: IP65  
 \*Digital models \*\*Analog models

### Function of Digital Model

Zero / ABS, Data hold, Data output, Preset, inch/mm conversion (on inch/metric models only)  
 Function Lock, 2 Presets  
 Alarm: Low voltage, Counting value composition error

### Optional Accessories

**05CZA662**: SPC cable with data switch (1m / 40")\*  
**05CZA663**: SPC cable with data switch (2m / 80")\*  
 \*Only for digital models

### Interchangeable ball anvil-spindle tip set:

Diameter of ball anvil	Order No.	Gear module	Diametral pitch
0.8mm	<b>124-801*</b>	0.5 - 0.55	50
1mm	<b>124-802*</b>	0.6 - 0.65	45
1.191mm (3/64")	<b>124-803*</b>	0.7 - 0.8	35 - 30
1.5mm	<b>124-821*</b>	0.9 - 1	28 - 26
1.588mm (1/16")	<b>124-804*</b>	0.9 - 1	28 - 26
2mm	<b>124-805*</b>	1.25	22
2.381mm (3/32")	<b>124-806</b>	1.5	17
2.5mm	<b>124-822</b>	1.5	17
3mm	<b>124-807</b>	1.75	15
3.175mm (1/8")	<b>124-808</b>	—	14
3.5mm	<b>124-823</b>	2	13
3.969mm (5/32")	<b>124-809</b>	2	13
4mm	<b>124-810</b>	2.25	11
4.5mm	<b>124-824</b>	2.5	10
4.763mm (3/16")	<b>124-811</b>	2.5	10
5mm	<b>124-812</b>	2.75	9
5.556mm (7/32")	<b>124-813</b>	3.0 - 3.25	8
6mm	<b>124-814</b>	3.5	7
6.35mm (1/4")	<b>124-815</b>	3.75	7
7mm	<b>124-816</b>	4.0	6.5
7.144mm (9/32")	<b>124-817</b>	4.25	6
7.938mm (5/16")	<b>124-818</b>	4.5	5.5
8mm	<b>124-819</b>	4.75	5.5
8.731mm (11/32")	<b>124-820</b>	5.0 - 5.25	5

\*Carbide-tipped type

# Screw Thread Micrometers

## SERIES 125

### FEATURES

- Provided with a 60 degree V-anvil and conical spindle for easily measuring pitch diameters of metric or unified screw threads.
- With ratchet stop for constant force.
- With a standard bar for zero point adjustment except 0 - 25mm model.
- Supplied in fitted plastic case.



125-103

### Technical Data

Accuracy:  $\pm(2+R/75)\mu\text{m}$ , R=max. range (mm)  
 Graduation: 0.01mm  
 Spindle feed error: 3 $\mu\text{m}$

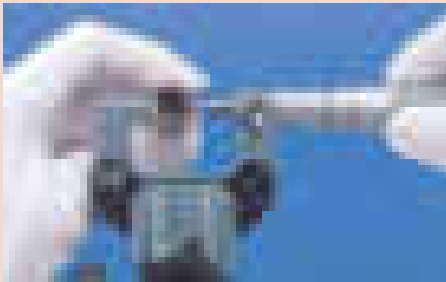

### SPECIFICATIONS

Metric			
Range	Graduation	Order No.	Screw to be measured (Metric/Unified)
0 - 25mm	0.01mm	125-101	0.4 - 0.5mm/64 - 48TPI
		125-102	0.6 - 0.9mm/44 - 28TPI
		125-103	1 - 1.75mm/24 - 14TPI
		125-104	2 - 3mm/13 - 9TPI
		125-105	3.5 - 5mm/8 - 5TPI
25 - 50mm	0.01mm	125-106	0.4 - 0.5mm/64 - 48TPI
		125-107	0.6 - 0.9mm/44 - 28TPI
		125-108	1 - 1.75mm/24 - 14TPI
		125-109	2 - 3mm/13 - 9TPI
		125-110	3.5 - 5mm/8 - 5TPI
50 - 75mm	0.01mm	125-111	0.6 - 0.9mm/44 - 28TPI
		125-112	1 - 1.75mm/24 - 14TPI
		125-113	2 - 3mm/13 - 9TPI
		125-114	3.5 - 5mm/8 - 5TPI
		125-115	5.5 - 7mm/4.5 - 3.5TPI
75 - 100mm	0.01mm	125-116	0.6 - 0.9mm/44 - 28TPI
		125-117	1 - 1.75mm/24 - 14TPI
		125-118	2 - 3mm/13 - 9TPI
		125-119	3.5 - 5mm/8 - 5TPI
		125-120	5.5 - 7mm/4.5 - 3.5TPI

### DIMENSIONS AND MASS

Unit: mm

Range	L	a	Mass (g)
0 - 25mm	37.2	25	200
25 - 50mm	62.2	32	250
50 - 75mm	87	49.5	260
75 - 100mm	112	63.5	330

# Screw Thread Micrometers

**SERIES 326, 126 — Interchangeable Anvil-Spindle Tip Type**



## FEATURES

- IP65 water/dust protection (Series 326).
- 60 degree or 55 degree V-anvil and conical spindle (interchangeable) are optional, which are made of high-grade steel, hardened and precision ground.
- With ratchet stop for constant force.
- With SPC output (Series 326).
- With a standard bar except 0 - 25mm and 0 - 1" model.
- Supplied in fitted plastic case.
- Non-slip grip finish (digital models).



**126-125**  
Shown with optional anvils



## SPECIFICATIONS

Metric		Digital model		
Range	Resolution	Order No.	Accuracy	Mass (g)
0 - 25mm	0.001mm	<b>326-251-30</b>	±4µm	350
25 - 50mm	0.001mm	<b>326-252-30</b>	±4µm	380
50 - 75mm	0.001mm	<b>326-253-30</b>	±4µm	470
75 - 100mm	0.001mm	<b>326-254-30</b>	±5µm	510

Inch/Metric		Digital model		
Range	Resolution	Order No.	Accuracy	Mass (g)
0 - 1" / 0 - 25.4mm	.00005" / 0.001mm	<b>326-351-30</b>	±.0002"	350
1 - 2" / 25.4 - 50.8mm	.00005" / 0.001mm	<b>326-352-30</b>	±.0002"	380
2 - 3" / 50.8 - 76.2mm	.00005" / 0.001mm	<b>326-353-30</b>	±.0002"	470
3 - 4" / 76.2 - 101.6mm	.00005" / 0.001mm	<b>326-354-30</b>	±.00025"	510

Metric				
Range	Graduation	Order No.	Accuracy	Mass (g)
0 - 25mm	0.01mm	<b>126-125</b>	±4µm	240
25 - 50mm	0.01mm	<b>126-126</b>	±4µm	290
50 - 75mm	0.01mm	<b>126-127</b>	±4µm	390
75 - 100mm	0.01mm	<b>126-128</b>	±5µm	450
100 - 125mm	0.01mm	<b>126-129</b>	±5µm	530
125 - 150mm	0.01mm	<b>126-130</b>	±5µm	620
150 - 175mm	0.01mm	<b>126-131</b>	±6µm	730
175 - 200mm	0.01mm	<b>126-132</b>	±6µm	860
200 - 225mm	0.01mm	<b>126-133</b>	±6µm	1,030
225 - 250mm	0.01mm	<b>126-134</b>	±7µm	1,200
250 - 275mm	0.01mm	<b>126-135</b>	±7µm	1,370
275 - 300mm	0.01mm	<b>126-136</b>	±7µm	1,540

Inch				
Range	Graduation	Order No.	Accuracy	Mass (g)
0 - 1"	.001"	<b>126-137</b>	±.0002"	240
1 - 2"	.001"	<b>126-138</b>	±.0002"	290
2 - 3"	.001"	<b>126-139</b>	±.0002"	390
3 - 4"	.001"	<b>126-140</b>	±.00025"	450
4 - 5"	.001"	<b>126-141</b>	±.00025"	530
5 - 6"	.001"	<b>126-142</b>	±.00025"	620
6 - 7"	.001"	<b>126-143</b>	±.0003"	730

Inch With anvil set (126 - 800)				
Range	Graduation	Order No.	Accuracy	Mass (g)
0 - 1"	.001"	<b>126-901</b>	±.0002"	240
1 - 2"	.001"	<b>126-902</b>	±.0002"	290
2 - 3"	.001"	<b>126-903</b>	±.0002"	390
3 - 4"	.001"	<b>126-904</b>	±.00025"	450
4 - 5"	.001"	<b>126-905</b>	±.00025"	530
5 - 6"	.001"	<b>126-906</b>	±.00025"	620

## DIMENSIONS

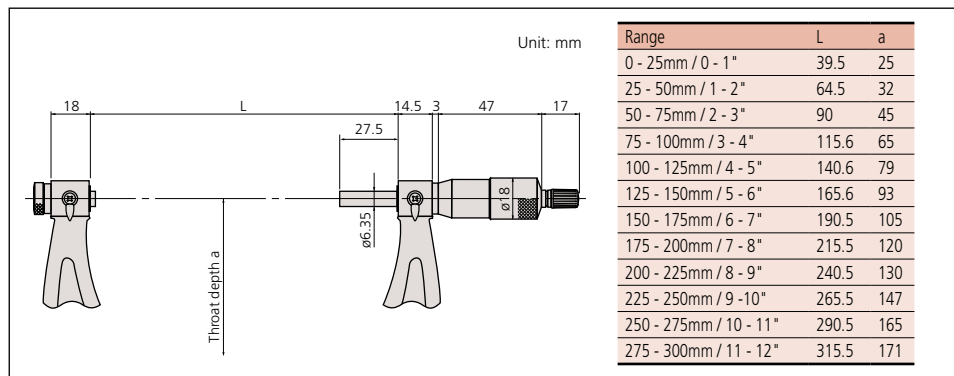

## Technical Data

Resolution\*: 0.001mm or .00005"/0.001mm  
 Graduation\*\*: 0.01mm or .001"  
 Spindle feed error: 3µm / .00012"  
 Display\*: LCD  
 Battery\*: SR44 (1 pc.), **938882**  
 Battery life\*: Approx. 2.4 years under normal use  
 Dust/Water protection level\*: IP65  
 \*Digital models \*\*Analog models

## Function of Digital Model

Zero / ABS, Data hold, Data output, 2 Presets, Function Lock.  
 inch/mm conversion (on inch/metric models only)  
 Alarm: Low voltage, Counting value composition error

## Optional Accessories

**05CZA662**: SPC cable with data switch (1m / 40")\*  
**05CZA663**: SPC cable with data switch (2m / 80")\*  
 \*Only for digital models  
 (See page B-51.): Standard for screw thread micrometer

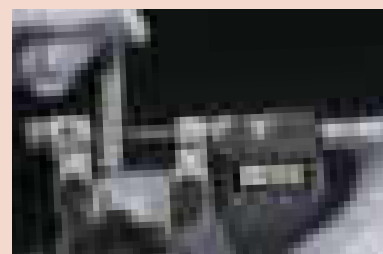

Anvil-spindle tip set:

Applications	Set Order No.	Tip Information		
		Threads Per Inch	Pitch (mm)	Individual Order No.
Metric Screw, Unified screw (60° threads)	<b>126-800</b>	64-48 (M1)	0.4-0.5	<b>126-801</b>
		44-28 (M2)	0.6-0.9	<b>126-802</b>
		24-14 (M3)	1-1.75	<b>126-803</b>
		13-9 (M4)	2-3	<b>126-804</b>
		8-5 (M5)	3.5-5	<b>126-805</b>
		4.5-3.5 (M6)	5.5-7	<b>126-806</b>
Whitworth Screw (55° threads)	<b>126-810</b>	60-48	-	<b>126-811</b>
		48-40	-	<b>126-812</b>
		40-32	-	<b>126-813</b>
		32-24	-	<b>126-814</b>
		24-18	-	<b>126-815</b>
		18-14	-	<b>126-816</b>
		14-10	-	<b>126-817</b>
		10-7	-	<b>126-818</b>
		7-4.5	-	<b>126-819</b>
		4.5-3.5	-	<b>126-820</b>

Features: 60 degree or 55 degree V-anvil and conical spindle (interchangeable) are optional, which are made of high-grade special steel, hardened and precision ground.  
 Storage box included.

# 3-Wire Thread Measuring System

Individual Holder and Wire Set

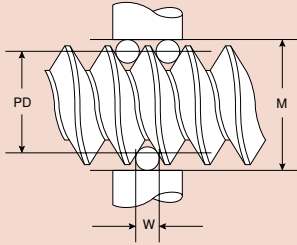

- PD = Pitch Diameter
- M = Measurement over wires
- W = Wire diameter
- C = Constant
- C = .86603 x Pitch (inches) -3W
- P.D. = M-C
- W = .57735 x P

## Applications

- Measure set of thread plug gages and working thread plug gages.
- Monitor the wear on working thread plug gages.
- Monitor and control pitch diameter variation during thread fabrication.
- Reduce measurement time to a fraction of the time normally taken using the traditional three wire method.
- Use in conjunction with go/no-go thread ring gages to control thread size to the most demanding specifications.
- Determine out of roundness and taper that may exist in threaded parts.
- Applications for preplating and post plating thread measurement.

## Tolerance of Wires:

- Diameter +/- .000010"
- Roundness +/- .000010"
- Surface finish 2 micro inches AA, lapped.
- Hardness HRC 59-64
- Certification of accuracy included.
- Traceable to NIST.
- Meets or exceeds all ANSI and ISO specs.

## FEATURES

- Fast and accurate method of thread measuring available for use with micrometer

Wire holders and 3 thread measuring wires assembled for each thread pitch.

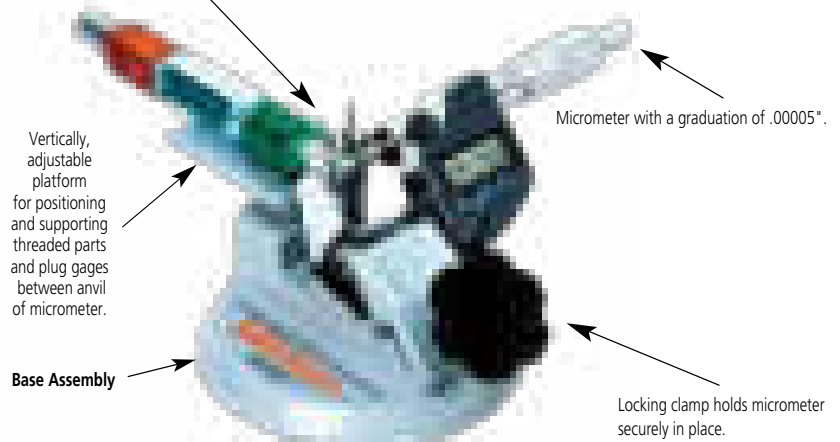

## INCH STANDARD HOLDERS AND WIRES SETS

Order No. <sup>1,2</sup>	Threads Per Inch	Thread Measuring Wire Diameter
64AAA201	120	.00481
64AAA202	100	.00577
64AAA203	95	.00601
64AAA204	90	.00642
64AAA205	80	.00722
64AAA206	72	.00802
64AAA207	64	.00902
64AAA208	56	.01031
64AAA209	50	.01155
64AAA210	48	.01203
64AAA211	44	.01312
64AAA212	40	.01443
64AAA213	36	.01604
64AAA214	32	.01804
64AAA215	30	.01925
64AAA216	28	.02062
64AAA217	27	.02138
64AAA218	26	.02221
64AAA219	24	.02406
64AAA220	22	.02624
64AAA221	20	.02887
64AAA222	18	.03208
64AAA223	16	.03608
64AAA224	14	.04124
64AAA225	13	.04441
64AAA226	12	.04811
64AAA227	11.5	.05020
64AAA228	11	.05249
64AAA229	10	.05774
64AAA230	9	.06415
64AAA231	8	.07217
64AAA232	7.5	.07698
64AAA233	7	.08248
64AAA234	6	.09623
64AAA235	5.5	.10497
64AAA236	5	.11547

<sup>1</sup> For 6.35mm Spindle Diameter holder only, add "H" suffix to Order No. (i.e. 64AAA201H)

<sup>2</sup> For 8mm Spindle Diameter holder only, add "H8" suffix to Order No. (i.e. 64AAA201H8)

Compatible with micrometers with 0.25" anvils & spindles.

Stand Assembly  
Order No. 156-106

## METRIC HOLDERS AND WIRES SETS

Order No. <sup>1</sup>	Pitch	mm Diameter	Inch Diameter
64AAA251	.2mm	.1155	.00455
64AAA252	.225mm	.1299	.00511
64AAA253	.25mm	.1443	.00568
64AAA254	.30mm	.1732	.00682
64AAA255	.35mm	.2021	.00796
64AAA256	.40mm	.2309	.00909
64AAA257	.45mm	.2598	.01023
64AAA258	.50mm	.2887	.01137
64AAA259	.55mm	.3175	.01250
64AAA260	.60mm	.3464	.01364
64AAA261	.70mm	.4041	.01591
64AAA262	.75mm	.4330	.01705
64AAA263	.80mm	.4619	.01818
64AAA264	.85mm	.4907	.01932
64AAA265	.90mm	.5196	.02046
64AAA266	1.00mm	.5774	.02273
64AAA267	1.25mm	.7217	.02841
64AAA268	1.50mm	.8660	.03410
64AAA269	1.75mm	1.0104	.03978
64AAA270	2.00mm	1.1547	.04546
64AAA271	2.50mm	1.4434	.05683
64AAA272	3.00mm	1.7321	.06819
64AAA273	3.50mm	2.0207	.07956
64AAA274	4.00mm	2.3094	.09092

<sup>1</sup> For 6.35mm Spindle Diameter holder only, add "H" suffix to Order No. (i.e. 64AAA201H)

# Can Seam Micrometers

## SERIES 147

### FEATURES

- Measures the width, height, and depth of can seams.
- Three types of micrometers are available for: steel cans, aluminum cans and sprayer cans.
- Supplied in fitted carton.



147-103

### SPECIFICATIONS

Metric			
Range	Graduation	Order No.	Remarks
0 - 13mm	0.01mm	147-103	for steel cans
		147-105	for aluminum cans
		147-202	for sprayer cans

Inch			
Range	Graduation	Order No.	Remarks
0 - .5"	.001"	147-104	for steel cans
		147-106	for aluminum cans
		147-201	for sprayer cans

### Technical Data

Accuracy:  $\pm 0.00012'' / \pm 3\mu\text{m}$   
 Graduation:  $.001'' / 0.01\text{mm}$

### DIMENSIONS AND MASS

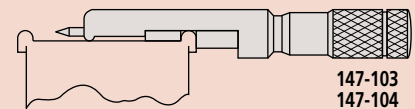
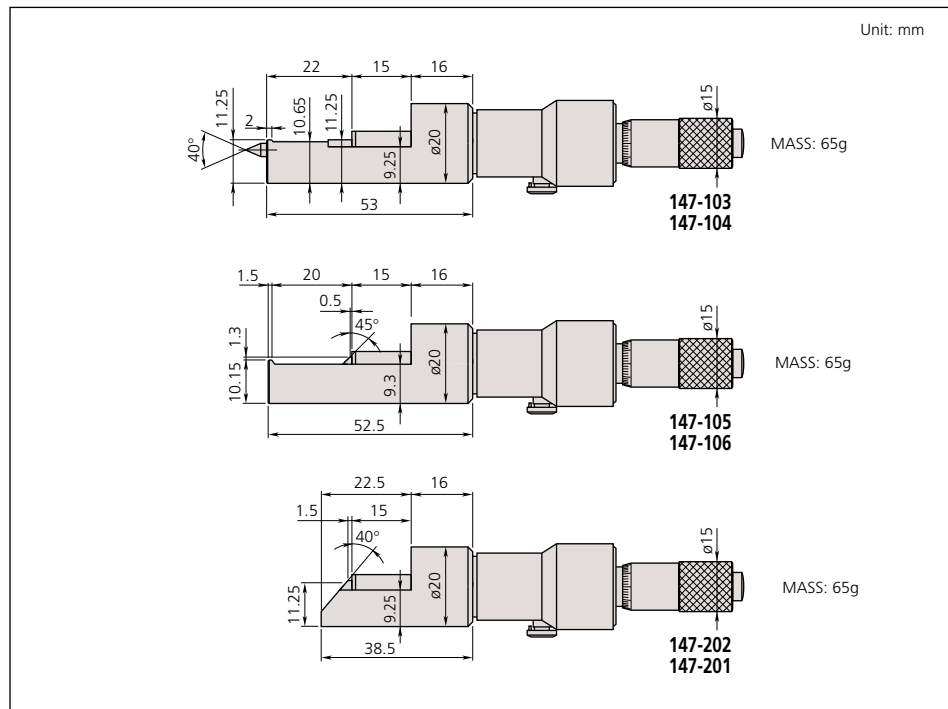

for cans  
(for depth measurements up to 5mm)

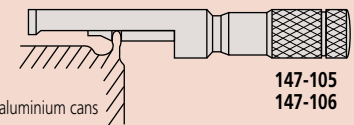

for aluminium cans

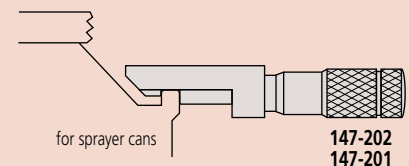

for sprayer cans

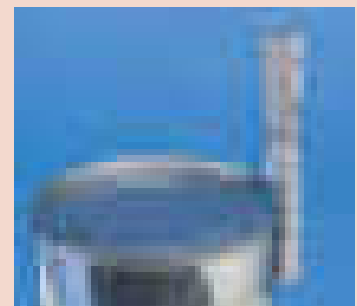

# Hub Micrometers

## SERIES 147

### Technical Data

Accuracy: Refer to the list of specifications  
 Graduation: 0.01mm / .001"  
 Flatness: 0.6µm / .000024"  
 Parallelism: (2+R/100)µm, R=max. range (mm)  
 [.00008" + .00004" (L/4)]", L = Max. range (inch)  
 Measuring faces: Carbide tipped

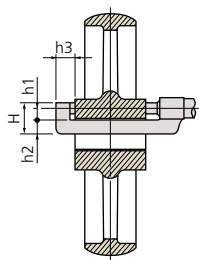
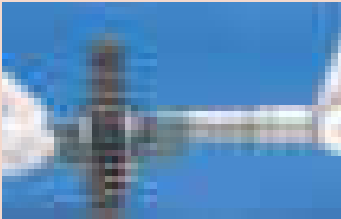

Unit: mm

Range	h1	h2	h3	H	Mass (g)
0 - 1" / 0 - 25mm	6	8.5	13.5	17.5	135
1 - 2" / 25 - 50mm	6.5	11	14	20.5	150
3 - 4" / 50 - 75mm	6.5	11	13	20.5	170
4 - 5" / 75 - 100mm	6.5	11	13	20.5	185

### FEATURES

- Measures hub thickness and shoulders inside a bore.
- With ratchet stop for constant force.
- With a standard bar except for 0 - 1" / 0 - 25mm model.
- Supplied in fitted plastic case.

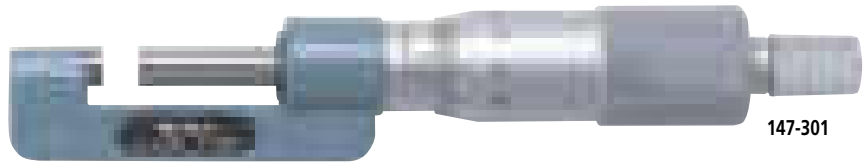

147-301



147-351

### SPECIFICATIONS

Metric			
Range	Graduation	Order No.	Accuracy
0 - 25mm	0.01mm	147-301	±2µm
25 - 50mm	0.01mm	147-302	±2µm
50 - 75mm	0.01mm	147-303	±2µm
75 - 100mm	0.01mm	147-304	±3µm

Inch			
Range	Graduation	Order No.	Accuracy
0 - 1"	.001"	147-351	±.0001"
1 - 2"	.001"	147-352	±.0001"
2 - 3"	.001"	147-353	±.0001"
3 - 4"	.001"	147-354	±.00015"

# Wire Micrometers

## SERIES 147

### FEATURES

- Designed for measuring wire thickness.
- Also used to measure the diameter of a small ball.
- Supplied in fitted plastic case.



147-402



147-401

### SPECIFICATIONS

Metric				
Range	Graduation	Order No.	Accuracy	Mass (g)
0 - 10mm	0.01mm	147-401	±3µm	65

Inch				
Range	Graduation	Order No.	Accuracy	Mass (g)
0 - .4"	.0001"	147-402*	±.00015"	65

\*.0001" reading is obtained with vernier.

### Technical Data

Graduation: .0001" or 0.01mm  
 Flatness: .000024" / 0.6µm  
 Parallelism: .00005" / 1.3µm  
 Measuring faces: Carbide tipped

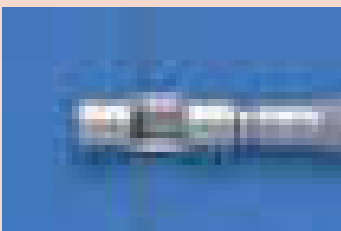

### DIMENSIONS AND MASS

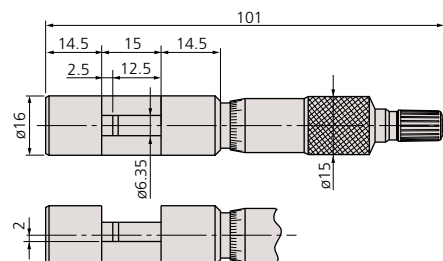

Unit: mm  
 MASS = 65g

# Digital Outside Micrometers

## SERIES 193

### FEATURES

- Mechanical digit counter with 0.01mm or .001" reading for quick and error-free reading.
- With a standard bar except for 0-25mm / 0 - 1" model.
- Supplied in fitted plastic case.



193-211

### SPECIFICATIONS

**Metric** \_\_\_\_\_ With ratchet stop

Range	Graduation	Order No.	Accuracy
0 - 25mm	0.01mm	<b>193-101</b>	±2μm
	0.001mm	<b>193-111*</b>	±2μm
25 - 50mm	0.01mm	<b>193-102</b>	±2μm
	0.001mm	<b>193-112*</b>	±2μm
50 - 75mm	0.01mm	<b>193-103</b>	±2μm
	0.001mm	<b>193-113*</b>	±2μm
75 - 100mm	0.01mm	<b>193-104</b>	±3μm
	0.001mm	<b>193-114*</b>	±3μm

\*0.001mm reading is obtained with vernier.

**Metric** \_\_\_\_\_ Micrometer sets

Range	Order No.	Included in set
0 - 75mm (3 pcs./set)	<b>193-901</b>	• <b>193-101, 193-102, 193-103</b> • 2 micrometer standards
0 - 75mm (3 pcs./set)	<b>193-915</b>	• <b>193-111, 193-112, 193-113,</b> • 2 micrometer standards
0 - 100mm (4 pcs./set)	<b>193-902</b>	• <b>193-101, 193-102, 193-103,</b> <b>193-104</b> • 3 micrometer standards
0 - 100mm (4 pcs./set)	<b>193-916</b>	• <b>193-111, 193-112, 193-113,</b> <b>193-114</b> • 3 micrometer standards

**Inch** \_\_\_\_\_ With friction thimble

Range	Graduation	Order No.	Accuracy
0 - 1"	.0001"	<b>193-211*</b>	±.0001"
1 - 2"	.0001"	<b>193-212*</b>	±.0001"

\*.0001" reading is obtained with vernier.

**Inch** \_\_\_\_\_ With ratchet stop

Range	Graduation	Order No.	Accuracy
2 - 3"	.0001"	<b>193-213*</b>	±.0001"
3 - 4"	.0001"	<b>193-214*</b>	±.00015"

\*.0001" reading is obtained with vernier.

**Inch** \_\_\_\_\_ Micrometer sets

Range	Order No.	Included in set
0 - 3" (3 pcs./set)	<b>193-923</b>	• <b>193-211, 193-212, 193-213</b> • 2 micrometer standards

### Technical Data

Counter reading: 0.01mm or .001"  
 Graduation: 0.01mm, 0.001mm, .001" or .0001"  
 Flatness: 0.6μm / .000024"  
 Parallelism: (2+R/100)μm, R=max. range (mm)  
 [.00008" + .00004" (L/4)]", L= max. range (inch)  
 Measuring faces: Carbide tipped



193-916

### DIMENSIONS AND MASS

Models up to 100mm / 4" Unit: mm

Range	L	a	b	c	Mass (g)
0 - 25mm / 0 - 1"	30	2.5	5	26	224
25 - 50mm / 1 - 2"	55	2.5	8	32	275
50 - 75mm / 2 - 3"	80	2.5	9	45	379
75 - 100mm / 3 - 4"	105	2.5	9	57	489

Note: The shape of the thimble changes on the model with friction thimble.



# Indicating Micrometers

## SERIES 510

### Technical Data

Spindle feed error:  $3\mu\text{m} / .00012''$   
 Dial indication accuracy:  $1\mu\text{m} / .00004''$   
 Dispersion of indication:  $0.4\mu\text{m} / .00002''$   
 Graduation:  $0.001\text{mm}$  or  $.0001''$   
 Dial reading:  $0.001\text{mm}$  or  $.00005''$   
 Flatness:  $0.3\mu\text{m} / .000012''$   
 Parallelism:  $0.6\mu\text{m} / .000024''$  for models up to  $50\text{mm} / 2''$   
 $1\mu\text{m} / .00004''$  for models over  $50\text{mm} / 2''$   
 Measuring force: 5 - 10N (500 - 1000gf)  
 Measuring faces: Carbide tipped

### Optional Accessories

- 04AZA124:**  $\phi 16\text{mm} / \phi .63''$  workpiece stopper (not available for  $25\text{mm} / 1''$  model)
- 04AZA125:**  $\phi 14\text{mm} / \phi .55''$  workpiece stopper
- 04AZA126:**  $\phi 14\text{mm} / \phi .55''$  workpiece stopper

Unit: mm

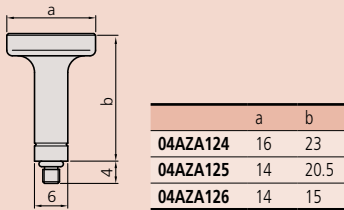

### DIMENSIONS AND MASS

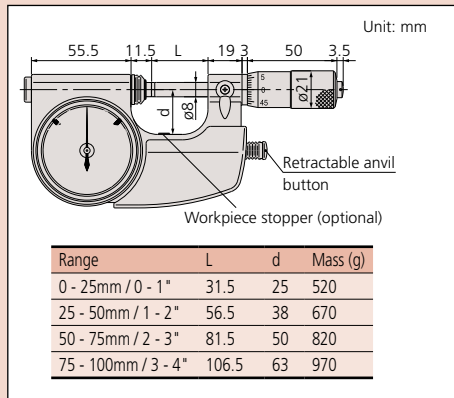

### Technical Data

Flatness:  $0.3\mu\text{m} / .000012''$   
 Parallelism:  $0.6\mu\text{m} / .000024''$  for models up to  $50\text{mm} / 2''$   
 $1\mu\text{m} / .00004''$  for models over  $50\text{mm} / 2''$   
 Measuring force: 5 - 10N (500 - 1000gf)  
 Measuring faces: Carbide tipped

### DIMENSIONS AND MASS

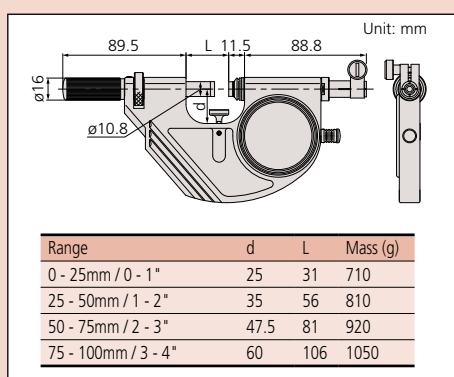

### FEATURES

- Retractable anvil with indicator for three-wire measurements of pitch diameter of precision screws and parallelism measurements.
- With a standard bar except for 0 - 25mm / 0 - 1" model.
- IP protection level: 54
- Supplied in fitted plastic case.

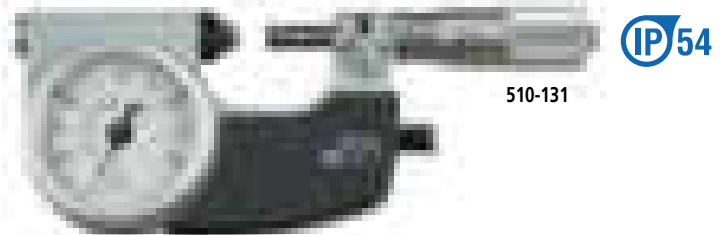

510-131

### SPECIFICATIONS

Metric			
Range	Graduation	Order No.	Indicating range
0 - 25mm	0.001mm	<b>510-121*</b> <b>510-141</b>	$\pm 0.060\text{mm}$
25 - 50mm	0.001mm	<b>510-122</b>	$\pm 0.060\text{mm}$
50 - 75mm	0.001mm	<b>510-123</b>	$\pm 0.060\text{mm}$
75 - 100mm	0.001mm	<b>510-124</b>	$\pm 0.060\text{mm}$

\*Retractable anvil button on the right side.

Inch			
Range	Graduation	Order No.	Indicating range
0 - 1"	.00005"	<b>510-131*</b> <b>510-151</b>	$\pm .0023''$
1 - 2"	.00005"	<b>510-132</b>	$\pm .0023''$
2 - 3"	.00005"	<b>510-133</b>	$\pm .0023''$
3 - 4"	.00005"	<b>510-134</b>	$\pm .0023''$

\*Retractable anvil button on the right side.

# Snap Meters

## SERIES 523

### FEATURES

- Various types of indicators, LVDTs and linear gages can be selected according to the measurement applications.
- Supplied in fitted plastic case.

Indicator is optional.

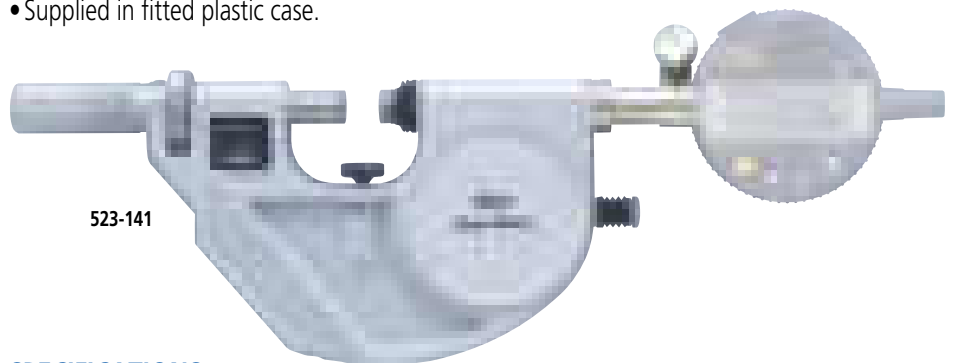

523-141

### SPECIFICATIONS

Metric			Gage stem dia 8mm
Range	Order No.	Anvil movement	
0 - 25mm	<b>523-141</b>	2mm	
25 - 50mm	<b>523-142</b>	2mm	
50 - 75mm	<b>523-143</b>	2mm	
75 - 100mm	<b>523-144</b>	2mm	

Inch			Gage stem dia 3/8"
Range	Order No.	Anvil movement	
0 - 1"	<b>523-151</b>	.078"	
1 - 2"	<b>523-152</b>	.078"	
2 - 3"	<b>523-153</b>	.078"	
3 - 4"	<b>523-154</b>	.078"	

# Dial Snap Meters

## SERIES 523

### FEATURES

- Direct go/no-go judgment for mass-produced parts.
- Spindle diameter: .425" / 10.8mm
- IP protection level: 54
- Supplied in fitted plastic case.



523-131

### SPECIFICATIONS

#### Metric

Range	Graduation	Order No.	Indicating range
0 - 25mm	0.001mm	<b>523-121</b>	±0.060mm
25 - 50mm	0.001mm	<b>523-122</b>	±0.060mm
50 - 75mm	0.001mm	<b>523-123</b>	±0.060mm
75 - 100mm	0.001mm	<b>523-124</b>	±0.060mm

#### Inch

Range	Graduation	Order No.	Indicating range
0 - 1"	.00005"	<b>523-131</b>	±.0023"
1 - 2"	.00005"	<b>523-132</b>	±.0023"
2 - 3"	.00005"	<b>523-133</b>	±.0023"
3 - 4"	.00005"	<b>523-134</b>	±.0023"

### DIMENSIONS AND MASS

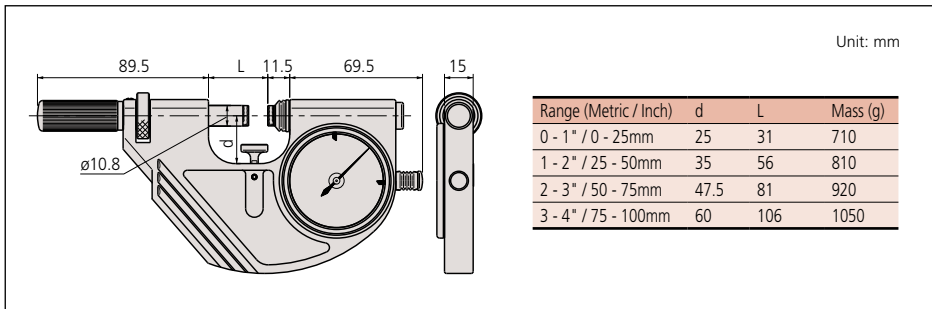

### Technical Data

Dial indication accuracy: .00005" / 1µm

Indication repeatability: .00002" / 0.4µm

Dial reading: .00005" or 0.001mm

Flatness: .000012" / 0.3µm

Parallelism: .000024" / 0.6µm for models up to 2" / 50mm

.00004" / 1µm for models over 2" / 50mm

Measuring force: 5 - 10N (500 - 1000gf)

Measuring faces: Carbide tipped

# Caliper-type Micrometers

## SERIES 343, 143

### Technical Data

Accuracy: Refer to the list of specifications.  
 Resolution\*: 0.001mm or .00005"/0.001mm  
 Graduation\*\*: 0.01mm / .001"  
 Flatness: 0.3μm / .000012"  
 Parallelism: (3+R/75)μm, R=max. range (mm)  
 [.00012" + .00004" (L/8)]"  
 L = Max. range (inch)  
 Measuring faces: Carbide tipped  
 Display\*: LCD  
 Battery\*: SR44 (1 pc.), **938882**  
 Battery life\*: Approx. 2.4 years under normal use  
 \*Digital models \*\*Analog models

### Function of Digital Model

Origin-set, Zero-setting, Data hold, Data output,  
 inch/mm conversion (on inch/metric models only)  
 Function lock  
 Alarm: Low voltage, Counting value composition error

### Optional Accessories for Digital Model

**05CZA662**: SPC cable with data switch (1m / 40")  
**05CZA663**: SPC cable with data switch (2m / 80")

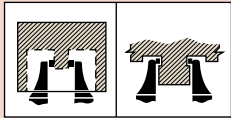
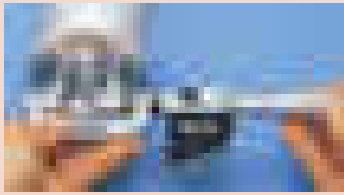

### FEATURES

- With ratchet stop for constant force.
- With SPC output (Series 343).
- With a standard bar except 0 - 25mm and 0 - 1" model.
- Supplied in fitted plastic case.
- Non-slip grip finish (digital models).

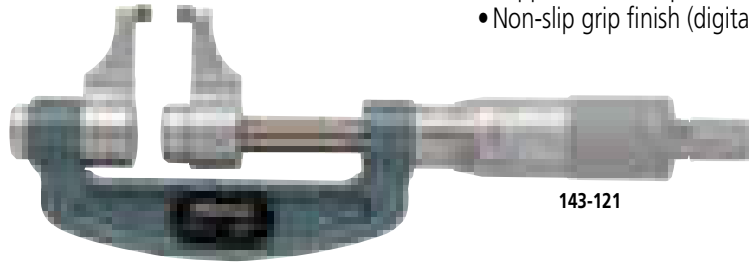

143-121



343-250-30

### SPECIFICATIONS

Metric		Digital model		
Range	Resolution	Order No.	Accuracy	Mass (g)
0 - 25mm	0.001mm	<b>343-250-30</b>	±5μm	630
25 - 50mm	0.001mm	<b>343-251-30</b>	±6μm	650
50 - 75mm	0.001mm	<b>343-252-30</b>	±7μm	1040
75 - 100mm	0.001mm	<b>343-253-30</b>	±8μm	1090

Inch / Metric		Digital model		
Range	Resolution	Order No.	Accuracy	Mass (g)
0 - 1" / 0 - 25.4mm	.00005" / 0.001mm	<b>343-350-30</b>	±.00025"	630
1 - 2" / 25.4 - 50.8mm	.00005" / 0.001mm	<b>343-351-30</b>	±.0003"	650
2 - 3" / 50.8 - 76.2mm	.00005" / 0.001mm	<b>343-352-30</b>	±.00035"	1040
3 - 4" / 76.2 - 101.6mm	.00005" / 0.001mm	<b>343-353-30</b>	±.0004"	1090

Metric				
Range	Graduation	Order No.	Accuracy	Mass (g)
0 - 25mm	0.01mm	<b>143-101</b>	±5μm	210
25 - 50mm	0.01mm	<b>143-102</b>	±6μm	230
50 - 75mm	0.01mm	<b>143-103</b>	±7μm	280
75 - 100mm	0.01mm	<b>143-104</b>	±8μm	330

Models with a range up to 300mm are available.

Inch				
Range	Graduation	Order No.	Accuracy	Mass (g)
0 - 1"	.001"	<b>143-121</b>	±.00025"	210
1 - 2"	.001"	<b>143-122</b>	±.0003"	230
2 - 3"	.001"	<b>143-123</b>	±.00035"	280

### DIMENSIONS

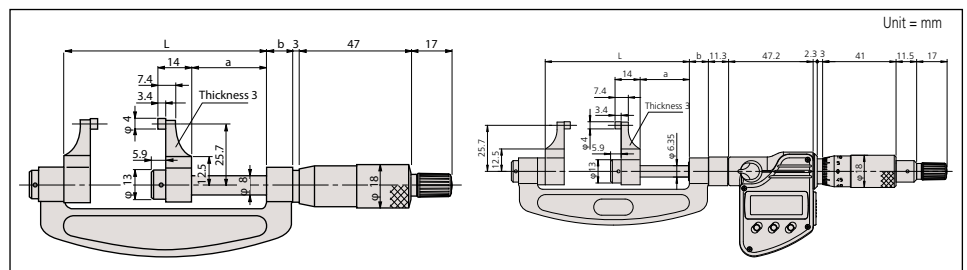

# Groove Micrometers

## SERIES 146

### FEATURES

- Flanged spindle for measuring width, depth and location of grooves inside/outside bores, and tubes.
- Provided with two types of graduations for inside and outside measurements.
- Non-rotating spindle type has two-directional ratchet stop. (Measuring force: 0.7 - 1.2N)



### SPECIFICATIONS

Metric Rotating spindle type					
Range Outside	Range Inside	Graduation	Order No.	Flange	Mass (g)
0 - 25mm	1.6 - 26.5mm	0.01mm	146-121	ø6.35mm	135
			146-122	ø12.7mm	185
25 - 50mm	26.5 - 51.5mm	0.01mm	146-123	ø12.7mm	175
50 - 75mm	51.5 - 76.5mm	0.01mm	146-124	ø12.7mm	165
75 - 100mm	76.5 - 101.5mm	0.01mm	146-125	ø12.7mm	160

Inch Rotating spindle type					
Range Outside	Range Inside	Graduation	Order No.	Flange	Mass (g)
0 - 1"	.055" - 1.05"	.001"	146-131	ø.25"	135
			146-132	ø.5"	185
1" - 2"	1.05" - 2.05"	.001"	146-133	ø.5"	175
2" - 3"	2.05" - 3.05"	.001"	146-134	ø.5"	165
3" - 4"	3.05" - 4.05"	.001"	146-135	ø.5"	160

Metric Non-rotating spindle type					
Range Outside	Range Inside	Graduation	Order No.	Flange	Mass (g)
0 - 25mm	1.6 - 26.5mm	0.01mm	146-221	ø6.35mm	135
			146-222	ø12.7mm	185
25 - 50mm	26.5 - 51.5mm	0.01mm	146-223	ø12.7mm	175
50 - 75mm	51.5 - 76.5mm	0.01mm	146-224	ø12.7mm	165
75 - 100mm	76.5 - 101.5mm	0.01mm	146-225	ø12.7mm	160

Inch Non-rotating spindle type					
Range Outside	Range Inside	Graduation	Order No.	Flange	Mass (g)
0 - 1"	.055" - 1.05"	.001"	146-231	ø.25"	135
			146-232	ø.5"	185
1" - 2"	1.05" - 2.05"	.001"	146-233	ø.5"	175
2" - 3"	2.05" - 3.05"	.001"	146-234	ø.5"	165
3" - 4"	3.05" - 4.05"	.001"	146-235	ø.5"	160

### DIMENSIONS

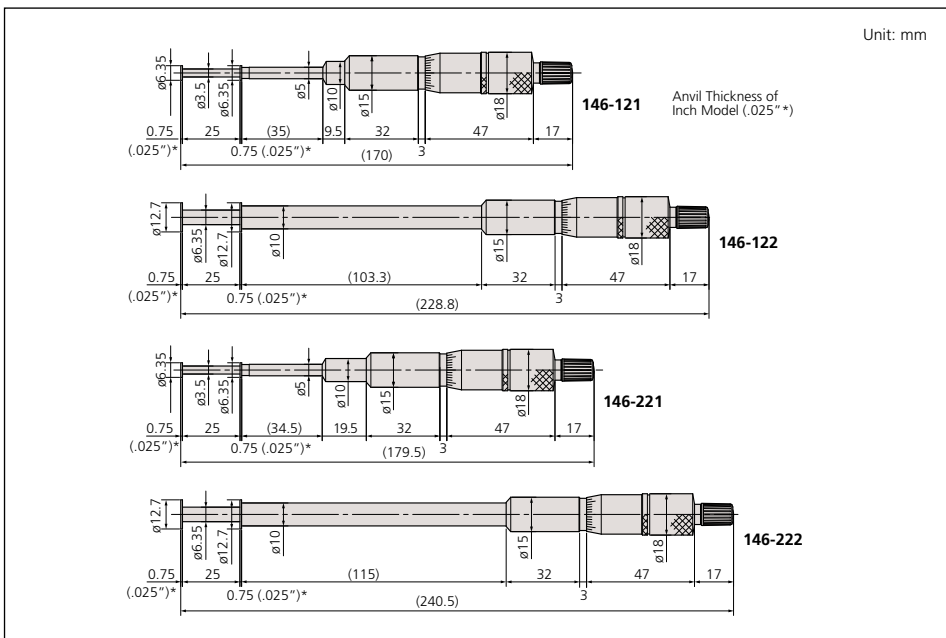

### Technical Data

Accuracy:  $\pm .0004"$  /  $\pm 10\mu\text{m}$   
 Parallelism:  $.0004"$  /  $10\mu\text{m}$

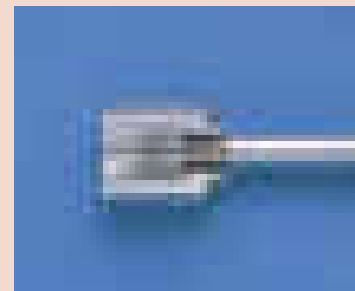
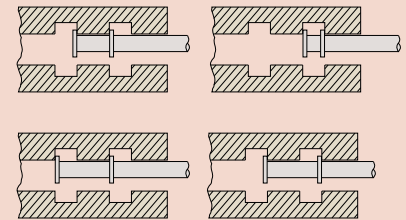

# Small Hole Gage Set

## SERIES 154

### FEATURES

- Used with an outside micrometer for measuring inside diameter of bores.
- 4 sizes of gages are supplied in a fitted pouch.
- Extra long for gaging deep and shallow holes, slots and similar workpieces.
- Gaging surface is fully hardened to ensure long tool life.



154-901

### DIMENSIONS

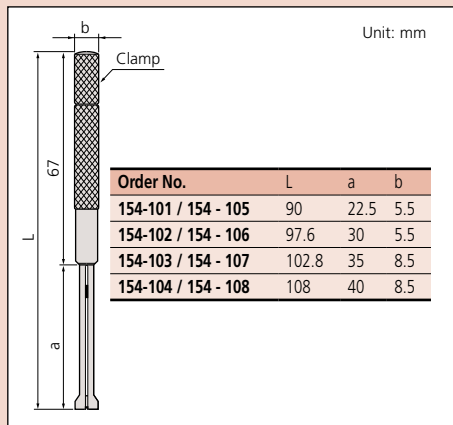

### SPECIFICATIONS

Metric		
Total range	Set Order No.	Assortment of gages
ø3 - 13mm (4-gage set)	154-902	ø3 - 5mm gage (154-101)
		ø5 - 7.5mm gage (154-102)
		ø7.5 - 10mm gage (154-103)
		ø10 - 13mm gage (154-104)

Inch		
Total range	Set Order No.	Assortment of gages
.125 - .5" DIA. (4-gage set)	154-901	.125" - .2" DIA. gage (154-105)
		.2" - .3" DIA. gage (154-106)
		.3" - .4" DIA. gage (154-107)
		.4" - .5" DIA. gage (154-108)

# Telescoping Gage Set

## SERIES 155

### FEATURES

- Spring-loaded plunger expands within the bore (or groove), allowing determination of the internal diameter (or groove width).
- With a knurled clamp.
- Supplied in a fitted pouch.



155-903

### DIMENSIONS

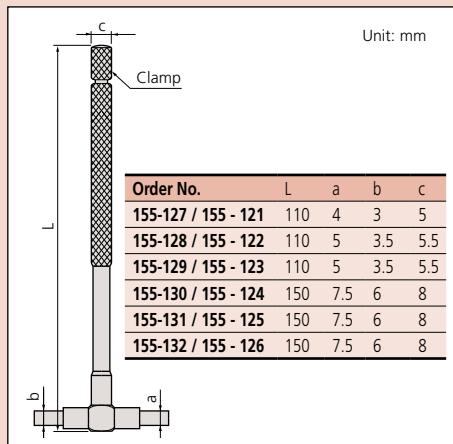

### SPECIFICATIONS

Metric		
Total range	Set Order No.	Included in set
8 - 150mm (6-gage set)	155-905	8 - 12.7mm gage (155-127)
		12.7 - 19mm gage (155-128)
		19 - 32mm gage (155-129)
		32 - 54mm gage (155-130)
		54 - 90mm gage (155-131)
		90 - 150mm gage (155-132)

Inch		
Total range	Set Order No.	Included in set
.313 - 6" (6-gage set)	155-903	.313" - .5" gage (155-121)
		.5" - .75" gage (155-122)
		.75" - 1.25" gage (155-123)
		1.25" - 2.125" gage (155-124)
		2.125" - 3.5" gage (155-125)
		3.5" - 6" gage (155-126)
.50 - 6" (5-gage set)	155-904	155-122, 155-123, 155-124, 155-125, 155-126
.315 - 2.125" (4-gage set)	155-907	155-121, 155-122, 155-123, 155-124

# Micrometer Stands

## SERIES 156

These stands are designed to allow bench-top use with hand micrometers or other gages.

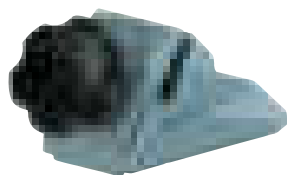

156-105-10



156-106



156-101-10



156-102

### SPECIFICATIONS

Micrometer ranges	Order No.	Remarks
0-1" / 0-25mm, 1-2" / 25-50mm	156-105-10	Fixed angle type
Up to 4" / 100mm	156-101-10	Adjustable angle type
5-12" / 125-300mm	156-102	Vertical type
12-40" / 300-1000mm	156-103	Vertical type
0-1" / 0-25mm 1-2" / 25-50mm	156-106	Fixed angle with platform

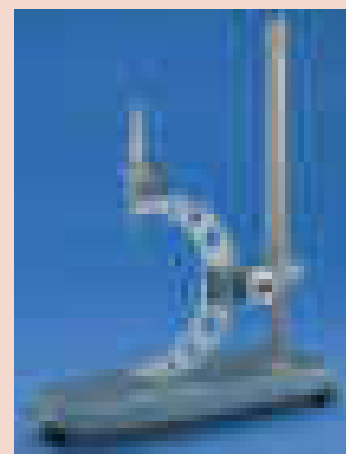

### DIMENSIONS

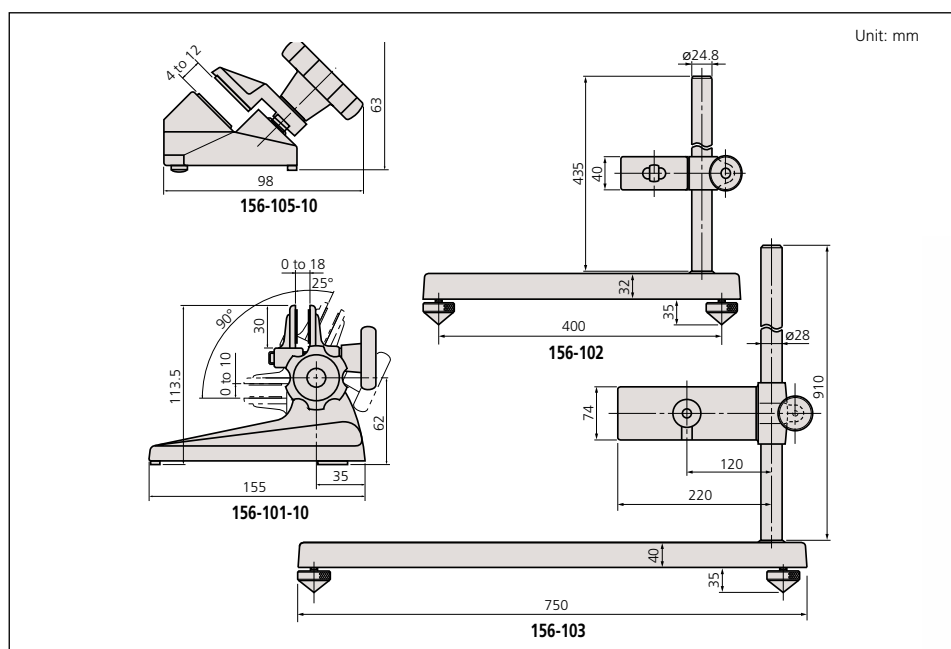

# Color Ratchet & Color Speeder

## Color ratchet



### SPECIFICATIONS

Order No.	Color
985056	Black
985061	Red
985081	Blue
985071	Yellow
985076	Green
985066	Brown
04GZA241*	Gray
04GZA239**	Gray
04GZA243***	Gray

\*for Series 293 digital model

\*\* up to 300mm / 12"

\*\*\* over 300mm / 12"

## Color Speeder for Ratchet Thimble Micrometer



### SPECIFICATIONS

Order No.	Color
04GAA899	Black
04GAA900	Red
04GAA901	Yellow
04GAA902	Green
04GAA903	Blue
04AAB208	Gray

### Technical Data

Tip length: metric type: 10mm  $\pm 5\mu\text{m}$   
inch type: .5"  $\pm .0002$ "

Spindle Dia: \*1 .250" / 6.35mm  
\*1 Spindle diameter for 101469  
(.250" ball) is .315" / 8mm

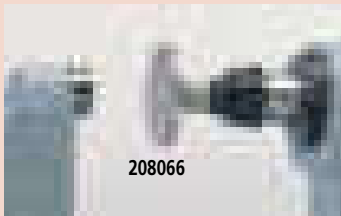

To measure odd workpieces, several convenient anvil attachments are prepared by Mitutoyo. Among them the most often used one is the ball attachment.

The ball attachments are hardened steel balls with .200" and .250" diameters which are placed on the .250" and .315" diameter anvils, respectively, by rubber caps. With these attachments, regular micrometers can measure cylindrical wall thickness, but, .200" or .250" must be subtracted from the readings.

Other attachments shown here are either .500" or 10mm in length. The added amount must be subtracted from the reading.

## Spindle Attachment Tip

Ball	Spline	Comparator	Blade	Knife-edge	Disk
					
101468 (.200" ball dia.) 101469 (.250" ball dia.)	208062* 208098	208063* 208099	208064* 208100	208065* 208101	208066* 208102

### DIMENSIONS

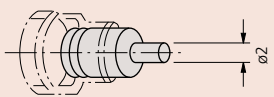
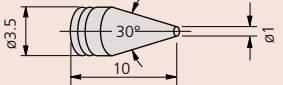
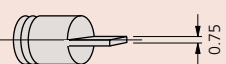
Order No.	Dimension
208098 208062*	
208099 208063*	
208100 208064*	

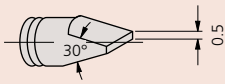
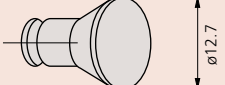
Order No.	Dimension
208101 208065*	
208102 208066*	

\* metric type

## Micrometer Oil

207000 (30ml)



Mitutoyo

# Optical Parallels

## SERIES 157

### FEATURES

- Designed to inspect parallelism and flatness of measuring faces of micrometers.
- Each set consists of 4 thicknesses.
- Supplied in fitted wooden case.



### SPECIFICATIONS

Metric		
Range of micrometer to be checked	Order No.	Assortment of parallels (Thickness of parallel)
0-25mm	<b>157-903</b>	12.00mm (157-101)
		12.12mm (157-102)
		12.25mm (157-103)
		12.37mm (157-104)
25-50mm	<b>157-904</b>	25.00mm (157-105)
		25.12mm (157-106)
		25.25mm (157-107)
		25.37mm (157-108)

Inch		
Range of micrometer to be checked	Order No.	Assortment of parallels (Thickness of parallel)
0-1"	<b>157-901</b>	.5000" (157-109)
		.5062" (157-110)
		.5125" (157-111)
		.5187" (157-112)
1-2"	<b>157-902</b>	1.0000" (157-113)
		1.0062" (157-114)
		1.0125" (157-115)
		1.0187" (157-116)

# Optical Flats

## SERIES 158

### FEATURES

- Used for inspecting the flatness of micrometer's or gage block's measuring faces with high accuracy.
- Supplied in fitted wooden case.



### SPECIFICATIONS

Metric		
Flatness	Order No.	Diameter/Thickness
0.2µm	<b>158-117</b>	45mm/12mm
	<b>158-119</b>	60mm/15mm
0.1µm	<b>158-118</b>	45mm/12mm
	<b>158-120</b>	60mm/15mm

Inch		
Flatness	Order No.	Diameter/Thickness
.000004"	<b>158-122</b>	1.8"/.5"
	<b>158-124</b>	2.4"/.6"

### Technical Data

Flatness: .000004" / 0.1µm  
 Parallelism: .000008" / 0.2µm  
 Diameter: 1.18" / 30mm

### Parallelism check between measuring faces by means of interference fringe produced by an optical parallel.

The parallelism between the measuring faces can be determined as follows—place the optical parallel to the anvil and observe the number of interference fringes produced on the spindle side under the measuring force of the micrometers.  
 The parallelism is about 1µm (0.32µm x 3 = 0.96µm).  
 Fringe on the anvil side must not be more than one.

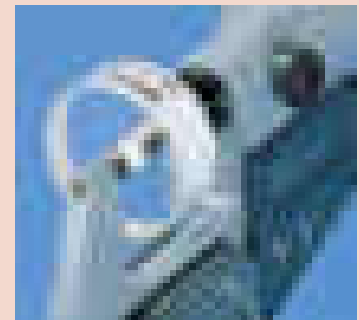
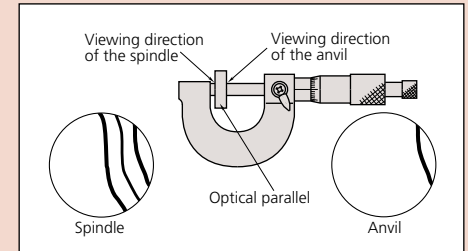

### Flatness check of measuring faces using interference fringe pattern produced by an optical flat.

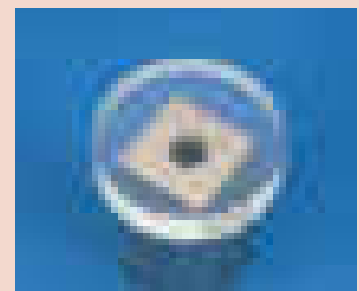
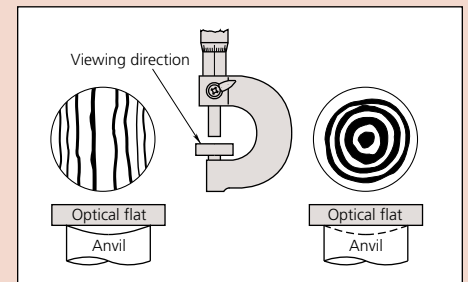



## Technical Data

Flatness: 0.3µm / .000012"  
 Parallelism: 2µm / .00008"

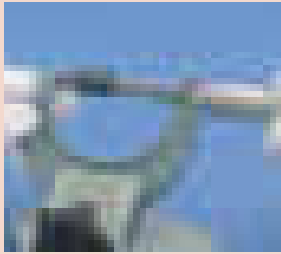

# Micrometer Standards

## SERIES 167

### FEATURES

- Used for the zero point setting of outside micrometers.
- Flat and lapped measuring faces.
- Heat insulating handle to prevent expansion due to body temperature.
- Supplied in fitted carton up to 500mm / 20" and wooden case for over 525mm / 21" length.



### DIMENSION

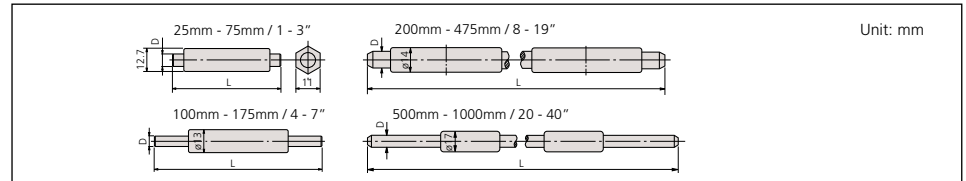

### SPECIFICATIONS

Metric			
Length (L)	Order No.	Diameter (D)	Accuracy
25mm	167-101	6.35mm	±1.5µm
50mm	167-102	6.35mm	±2.0µm
75mm	167-103	6.35mm	±2.5µm
100mm	167-104	7.9mm	±3µm
125mm	167-105	7.9mm	±3.5µm
150mm	167-106	7.9mm	±4µm
175mm	167-107	7.9mm	±4.5µm
200mm	167-108	9.4mm	±5.0µm
225mm	167-109	9.4mm	±5.5µm
250mm	167-110	9.4mm	±6.0µm
275mm	167-111	9.4mm	±6.5µm
300mm	167-112	9.4mm	±7µm
325mm	167-113	9.4mm	±7.5µm
350mm	167-114	9.4mm	±8µm
375mm	167-115	9.4mm	±8.5µm
400mm	167-116	9.4mm	±9µm
425mm	167-117	9.4mm	±9.5µm
450mm	167-118	9.4mm	±1.0µm
475mm	167-119	9.4mm	±10.5µm
500mm	167-120	11.9mm	±11µm
525mm	167-121	11.9mm	±11.5µm
550mm	167-122	11.9mm	±12µm
575mm	167-123	11.9mm	±12.5µm
600mm	167-124	11.9mm	±13µm
625mm	167-125	11.9mm	±13.5µm
650mm	167-126	11.9mm	±14µm
675mm	167-127	11.9mm	±14.5µm
700mm	167-128	11.9mm	±15µm
725mm	167-129	11.9mm	±15.5µm
750mm	167-130	11.9mm	±16µm
775mm	167-131	11.9mm	±16.5µm
800mm	167-132	11.9mm	±17µm
825mm	167-133	11.9mm	±17.5µm
850mm	167-134	11.9mm	±18µm
875mm	167-135	11.9mm	±18.5µm
900mm	167-136	11.9mm	±19µm
925mm	167-137	11.9mm	±19.5µm
950mm	167-138	11.9mm	±20µm
975mm	167-139	11.9mm	±20.5µm
1000mm	167-140	11.9mm	±21µm

Inch			
Length (L)	Order No.	Diameter (D)	Accuracy
1"	167-141	.25"	±.00005"
2"	167-142	.25"	±.0001"
3"	167-143	.25"	±.0001"
4"	167-144	.31"	±.0001"
5"	167-145	.31"	±.00015"
6"	167-146	.31"	±.00015"
7"	167-147	.31"	±.00015"
8"	167-148	.37"	±.00015"
9"	167-149	.37"	±.0002"
10"	167-150	.37"	±.0002"
11"	167-151	.37"	±.0002"
12"	167-152	.37"	±.00025"
13"	167-153	.37"	±.00025"
14"	167-154	.37"	±.00025"
15"	167-155	.37"	±.00025"
16"	167-156	.37"	±.00025"
17"	167-157	.37"	±.00025"
18"	167-158	.37"	±.00025"
19"	167-159	.37"	±.0003"
20"	167-160	.47"	±.0003"
21"	167-161	.47"	±.0003"
22"	167-162	.47"	±.0003"
23"	167-163	.47"	±.0003"
24"	167-164	.47"	±.0003"
25"	167-165	.47"	±.00035"
26"	167-166	.47"	±.00035"
27"	167-167	.47"	±.00035"
28"	167-168	.47"	±.00035"
29"	167-169	.47"	±.00035"
30"	167-170	.47"	±.00035"
31"	167-171	.47"	±.00035"
32"	167-172	.47"	±.00035"
33"	167-173	.47"	±.00035"
34"	167-174	.47"	±.00035"
35"	167-175	.47"	±.00035"
36"	167-176	.47"	±.00035"
37"	167-177	.47"	±.0004"
38"	167-178	.47"	±.0004"
39"	167-179	.47"	±.0004"
40"	167-180	.47"	±.0004"

Inch			
Length (L)	Order No.	Diameter (D)	Accuracy
41"	167-405	.47"	.0004"
42"	167-406	.47"	.0004"
43"	167-407	.47"	.0004"
44"	167-408	.47"	.0004"
45"	167-409	.47"	.0004"
46"	167-410	.47"	.0004"
47"	167-411	.47"	.0004"
48"	167-412	.47"	.0004"
49"	167-413	.47"	.0004"
50"	167-414	.47"	.0004"
51"	167-415	.47"	.0004"
52"	167-416	.47"	.0004"
53"	167-417	.47"	.0004"
54"	167-418	.47"	.0004"
55"	167-419	.47"	.0004"
56"	167-420	.47"	.0004"
57"	167-421	.47"	.0004"
58"	167-422	.47"	.0004"
59"	167-423	.47"	.0004"
60"	167-424	.47"	.0004"
61"	167-425	.47"	.0004"
62"	167-426	.47"	.0004"
63"	167-427	.47"	.0004"
64"	167-428	.47"	.0004"
65"	167-429	.47"	.0004"
66"	167-430	.47"	.0004"
67"	167-431	.47"	.0004"
68"	167-432	.47"	.0004"
69"	167-433	.47"	.0004"
70"	167-434	.47"	.0004"
71"	167-435	.47"	.0004"
72"	167-436	.47"	.0004"
73"	167-437	.47"	.0004"
74"	167-438	.47"	.0004"
75"	167-439	.47"	.0004"
76"	167-440	.47"	.0004"
77"	167-441	.47"	.0004"
78"	167-442	.47"	.0004"
79"	167-443	.47"	.0004"

### Micrometer Standards Set

Inch		
Order No.	Size	Remarks
167-912*	1"-5"	5 pcs. Set (167-141, 142, 143, 144, 145)
167-913*	1"-11"	11 pcs. Set (167-141, 142, 143, 144, 145, 146, 147, 148, 149, 150, 151)

Metric		
Order No.	Size	Remarks
167-902*	25-125mm	5 pcs. Set (167-101, 102, 103, 104, 105)
167-903*	25-275mm	11 pcs. Set (167-101, 102, 103, 104, 105, 106, 107, 108, 109, 110, 111)

\*Supplied with fitted carrying case

# Standards for Screw Thread Micrometers

## SERIES 167 — 60 degree and 55 degree

### FEATURES

- Specially designed for the zero point setting of screw thread micrometers.
- Supplied in fitted carton.



167-264 (60°)



167-262 (60°)

### SPECIFICATIONS

Metric			
Length	Order No.	Thread angle	Accuracy
25mm	167-261	60°	±4µm
	167-272	55°	±4µm
50mm	167-262	60°	±5µm
	167-273	55°	±5µm
75mm	167-263	60°	±6µm
	167-274	55°	±6µm
100mm	167-264	60°	±7µm
	167-275	55°	±7µm
125mm	167-265	60°	±8µm
	167-276		±8µm
150mm	167-266	60°	±9µm
	167-277		±9µm
175mm	167-267	60°	±10µm
	167-278		±10µm
200mm	167-268	60°	±11µm
	167-279		±11µm
225mm	167-269	60°	±12µm
	167-280		±12µm
250mm	167-270	60°	±13µm
	167-281		±13µm
275mm	167-271	60°	±14µm
	167-282		±14µm

Inch			
Length	Order No.	Thread angle	Accuracy
1"	167-294	60°	±.00015"
	167-283	55°	±.00015"
2"	167-295	60°	±.0002"
	167-284	55°	±.0002"
3"	167-296	60°	±.00025"
	167-285	55°	±.00025"
4"	167-297	60°	±.0003"
	167-286	55°	±.0003"
5"	167-298	60°	±.00035"
	167-287	55°	±.00035"
6"	167-299	60°	±.0004"
	167-288	55°	±.0004"

### Technical Data

Thread angle: 55° or 60°  
Angle Accuracy: ±2°

# Standards for V-Anvil Micrometers

## SERIES 167

### FEATURES

- Specially designed for the zero point setting of V-anvil micrometers.
- Supplied in fitted carton.



167-329

### SPECIFICATIONS

Metric			
Diameter	Order No.	Type	Accuracy
5mm	167-327	Plug	±2µm
10mm	167-328	Plug	±2µm
25mm	167-329	Plug	±2µm
40mm	167-330	Ring	±3µm
55mm	167-331	Ring	±3µm
70mm	167-332	Ring	±3µm
85mm	167-333	Ring	±3µm

Inch			
Diameter	Order No.	Type	Accuracy
.2"	167-337	Plug	±.0001"
.4"	167-338	Plug	±.0001"
1"	167-339	Plug	±.0001"
1.6"	167-340	Ring	±.00015"
2.2"	167-341	Ring	±.00015"
2.8"	167-342	Ring	±.00015"
3.4"	167-343	Ring	±.00015"

# Tool Kits

The Digimatic Tool Kits include Mitutoyo's highly popular 0-1" / 0-25mm Digimatic Micrometer (choose ratchet or friction type) and 0-6" / 0-150mm Digimatic Caliper with Absolute Encoder. The case is made of handsome, solid mahogany and has space for gage batteries. The micrometer spanner is a supplied accessory.

Order No. 64PKA068A (Inch Tool Kit)	
Item No.	Description
103-135	Outside Micrometer (Friction Thimble Type) (Range: 0-1", Graduation: .0001")
505-742	Dial Caliper (Range: 0-6", Dial Graduation: .001")
182-204	6" Full-Flexible Rule (3R)
64PPP932	Mahogany Case

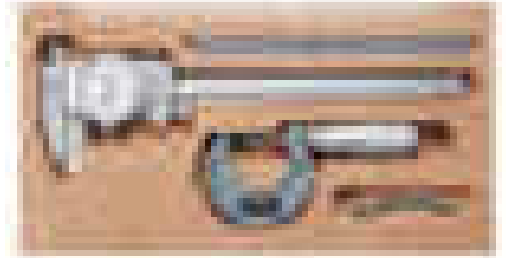

64PKA068A

Order No. 64PKA069A (Inch Tool Kit)	
Item No.	Description
103-135	Outside Micrometer (Friction Thimble Type) (Range: 0-1", Graduation: .0001")
182-202	6" Full-Flexible Rule (16R)
513-518T	Test Indicator Set (Range: .04", Graduation: .001")
505-742	675 Dial Caliper (Range: 0-6", Dial Graduation: .001")
050501	Mahogany Case



64PKA069A

The basic measuring instruments recommended for vocational students and machinist apprentices are supplied in this kit.

Order No. 64PKA070A (Inch Tool Kit)	
Item No.	Description
101-117	Outside Micrometer (Friction Thimble Type) (Range: 0-1", Graduation: .0001")
129-132	Depth Micrometer (with 6 pcs rods) (Range: 0-6", Graduation: .001")
182-202	Full-Flexible Rule (16R)
505-742	Dial Caliper (Range: 0-6", Graduation: .001")
050503	Mahogany Case



64PKA070A

For operations where depth measurements are a primary concern, this kit is ideal for measuring depths to 6", in addition to providing the tools for regular precision measurements.

Order No. 64PKA071B (Inch Tool Kit)	
Item No.	Description
103-922	Outside Micrometer Set (3 pcs) (Range: 0-3", Graduation: .0001")
141-208	Inside Micrometer (with 6 pcs rods)
182-202	Full-Flexible Rule (16R)
513-518T	Test Indicator Set (Range: .04", Graduation: .001")
505-742	Dial Caliper (Range: 0-6", Dial Graduation: .001")
2416S	Dial Indicator (Range: 1.0", Graduation: .001")
7010S	Magnetic Stand
050504	Mahogany Case

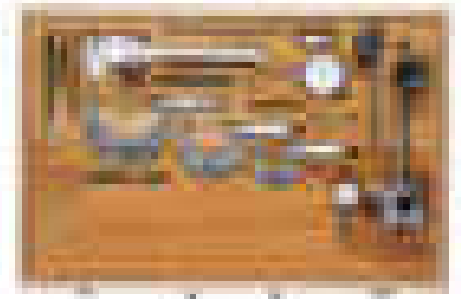

64PKA071B

Most every routine inspection assignment can be completed with the eight high-quality Mitutoyo precision measuring instruments provided in this deluxe kit.

Note: 050504 Mahogany Case is being reconfigured (not as pictured).

**Mitutoyo**

# Tool Kits



64PKA080B

Order No. 64PKA080B (Inch Tool Kit)	
Item No.	Description
182-102	6" Steel Rule (16R)
103-177	Micrometer (Ratchet Thimble) (Range 0-1", Graduation .001")
505-740	Dial Caliper (Range: 0-6", Dial Graduation: .001")
64PPP932	Mahogany Case

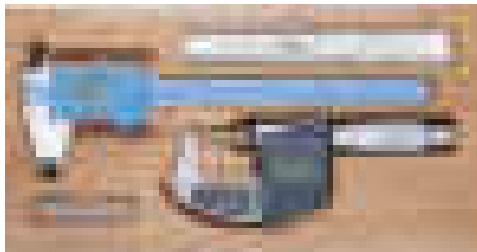

64PKA073B

Order No. 64PKA073B (Tool Kit Lite)	
Item No.	Description
182-102	6" Steel Rule (16R)
700-113-10	0 - 6" / 0 - 150mm MyCal Lite (Resolution: .001" / 0.1mm)
293-831-30	0 - 1" / 0 - 25.4mm MDC Lite (Ratchet Stop) (Resolution: .00005" / 0.001mm)
64PPP932	Mahogany Case



64PKA076B

Order No. 64PKA076B (Digimatic Tool Kit)	
Item No.	Description
293-340-30	Digimatic Micrometer (Ratchet Stop Type) (Range: 0 - 1" / 0 - 25.4mm, LCD Resolution: .00005" / 0.001mm)
500-196-30	Digimatic Caliper with Absolute Encoder (Range: 0 - 6" / 0 - 150mm, LCD Resolution: .0005" / 0.001mm)
64PPP932	Mahogany Case



64PKA077B

Order No. 64PKA077B (Digimatic Tool Kit)	
Item No.	Description
293-348-30	Digimatic Micrometer (Friction Thimble Type) (Range: 0 - 1" / 0 - 25.4mm, LCD Resolution: .00005" / 0.001mm)
500-196-30	Digimatic Caliper with Absolute Encoder (Range: 0 - 6" / 0 - 150mm, LCD Resolution: .0005" / 0.001mm)
64PPP932	Mahogany Case

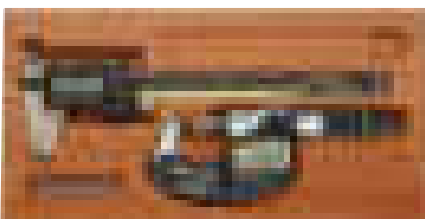

64PKA152

Order No. 64PKA152 (Digimatic Tool Kit)	
Item No.	Description
293-185-30	Digimatic Micrometer (Friction Thimble Type) (Range: 0 - 1" / 0 - 25.4mm, LCD Resolution: .00005" / 0.001mm)
500-196-30	Digimatic Caliper with Absolute Encoder (Range: 0 - 6" / 0 - 150mm, LCD Resolution: .0005" / 0.001mm)
64PPP932	Mahogany Case

# Micrometer Head Selection Guide

## Variety of Specifications

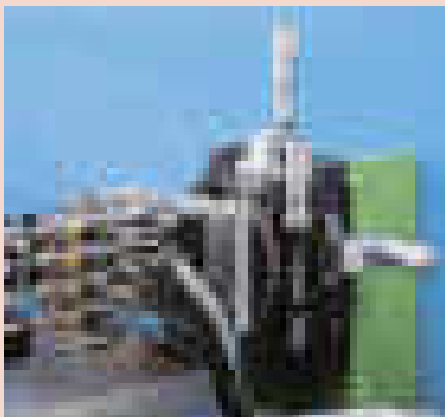
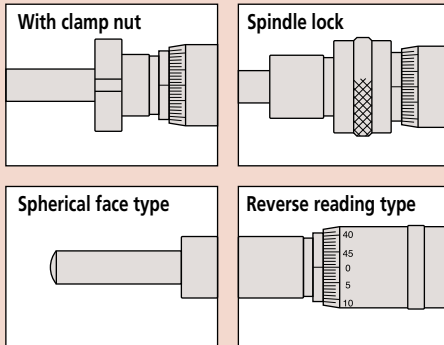

The table below provides an outline of Mitutoyo micrometer heads for each series so you can locate the pages to refer to select the micrometer head most appropriate to your specific application. When selecting consider the following points:

- Dimensions
- Graduation/resolution and accuracy
- With or without spindle lock
- With or without clamping nut
- Normal or reverse reading
- With or without ratchet stop

## SELECTION TABLE

Range	Series	Remarks	Page
0 - 1mm	110	Differential screw translator (extra-fine feeding) type	B-69
0 - 2.5mm	110	Differential screw translator (extra-fine feeding) type	B-69
0 - 5mm	148	Ultra-small type	B-60
0 - 6.5mm	148	Fine spindle feeding of 0.1mm/rev.	B-58
	148	Fine spindle feeding of 0.25mm/rev.	B-59
	148	Small type	B-60
	148	Large thimble diameter for easy reading	B-61
0 - 10mm	152	Fine-feeding type	B-68
0 - 13mm	148	Common type in small size	B-62
	148	Spindle feeding of 0.25mm/rev.	B-59
	148	Zero-adjustable thimble type	B-63
	148	Large thimble diameter for easy reading	B-61
	110	Differential screw translator (extra-fine feeding) type	B-69
0 - 15mm	149	with carbide-tipped spindle type	B-64
	153	Non-rotating spindle type	B-67
	152	Quick spindle feeding of 1mm/rev.	B-68
0 - 25mm	350	Compact digital type	B-57
	150	Common type in middle size	B-65
	153	Non-rotating spindle type	B-67
	153	Fine graduation type	B-71
	151	Heavy-duty type (ø8mm spindle)	B-66
	152	Quick spindle feeding of 1mm/rev.	B-68
	152	Fine feeding type	B-68
	152	for XY-stage	B-70
	250	with digit counter type	B-73
0 - 50mm	164	Digital type	B-56
	151	Heavy-duty type (ø8mm spindle)	B-66
	152	Quick spindle feeding of 1mm/rev.	B-68
	152	Fine-feeding type	B-68
	197	Non-rotating spindle and large thimble	B-71

# Digimatic Micrometer Heads

## SERIES 164

### FEATURES

- The display can be rotated up to 330° for easy reading in any position.
- Non-rotating spindle imparts no torque on the workpiece.



164-164

### SPECIFICATIONS

Metric				Inch/Metric			
Range	Order No.	Accuracy	Mass (g)	Range	Order No.	Accuracy	Mass (g)
0 - 50mm	164-163	±3µm	490	0 - 2" / 0 - 50.8mm	164-164	±.00015"	490

### Technical Data

Accuracy: Refer to the list of specifications.

Resolution: 0.001mm or .00005"/0.001mm

Display: LCD

Battery: SR44 (2 pcs.), **938882**

Battery life: 1.8 years

### Function

Zero-setting, Data hold, Data output, Preset, inch/mm conversion (on inch/metric models only)

Alarm: Low voltage, Counting value composition error

### Optional Accessories

**959149:** SPC cable (1m / 40")

**959150:** SPC cable (2m / 80")

### DIMENSIONS

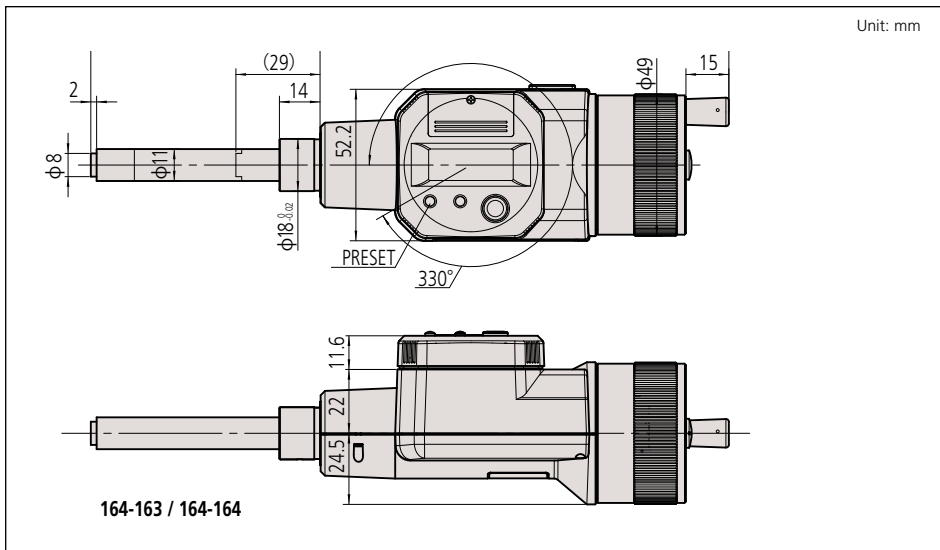



# Digimatic Micrometer Heads

## SERIES 350

### FEATURES

- Equipped with digital display and output.
- 350 series IP65 models: the Digimatic output port enables inclusion in a statistical process control or networked measurement system.

Measuring force: 5 - 10N

### Non-rotating device

350-261-30, 350-361-30

The non-rotating device provides no radial torsion on the workpiece surface so that workpiece wear and deformation are minimized.

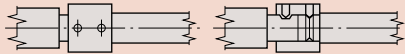

### Technical Data

Accuracy\*  $\pm 2\mu\text{m}$  Metric model  
 $\pm .0001$ " Inch / Metric model

Resolution: 0.001mm or .00005"/0.001mm

Display: LCD

Battery: SR44 (1 pc) 938882

Battery life: Approx. 2.4 years under normal use

Dust/Water protection level: IP65

350-281-30, 350-282-30, 350-283-30, 350-284-30, 350-261-30  
 350-381-30, 350-382-30, 350-383-30, 350-384-30, 350-361-30

### Function

Preset, inch/mm conversion (on inch/metric models only)

Function Lock, 2 Presets

Alarm: Low voltage, Counting value composition error

### Optional Accessories

05CZA662: SPC cable with data switch (1m / 40")

05CZA663: SPC cable with data switch (2m / 80")



### SPECIFICATIONS

#### Metric

Range	Order No.	Stem	Spindle face	Stem dia.	Remarks
0 - 25mm	350-251-30	Plain	Flat (carbide tip)	10mm	
0 - 25mm	350-252-30	w/ clamp nut	Flat (carbide tip)	10mm	
0 - 25mm	350-253-30	Plain	Spherical (SR4)	10mm	
0 - 25mm	350-254-30	w/ clamp nut	Spherical (SR4)	10mm	
0 - 25mm	350-281-30	Plain	Flat (carbide tip)	12mm	IP65
0 - 25mm	350-282-30	w/ clamp nut	Flat (carbide tip)	12mm	IP65
0 - 25mm	350-283-30	Plain	Spherical (SR4)	12mm	IP65
0 - 25mm	350-284-30	w/ clamp nut	Spherical (SR4)	12mm	IP65
0 - 25mm	350-261-30*	Plain	Flat	12mm	IP65

\*with non-rotating device and 18mm stem bushing.

#### Inch/Metric

Range	Order No.	Stem	Spindle face	Stem dia.	Remarks
0 - 1" / 0-25.4mm	350-351-30	Plain	Flat (carbide tip)	.375"	
0 - 1" / 0-25.4mm	350-352-30	w/ clamp nut	Flat (carbide tip)	.375"	
0 - 1" / 0-25.4mm	350-353-30	Plain	Spherical (SR4)	.375"	
0 - 1" / 0-25.4mm	350-354-30	w/ clamp nut	Spherical (SR4)	.375"	
0 - 1" / 0-25.4mm	350-381-30	Plain	Flat (carbide tip)	.5"	IP65
0 - 1" / 0-25.4mm	350-382-30	w/ clamp nut	Flat (carbide tip)	.5"	IP65
0 - 1" / 0-25.4mm	350-383-30	Plain	Spherical (SR4)	.5"	IP65
0 - 1" / 0-25.4mm	350-384-30	w/ clamp nut	Spherical (SR4)	.5"	IP65
0 - 1" / 0-25.4mm	350-361-30*	Plain	Flat	.5"	IP65

\*with non-rotating device and 18mm stem bushing.

### DIMENSIONS AND MASS

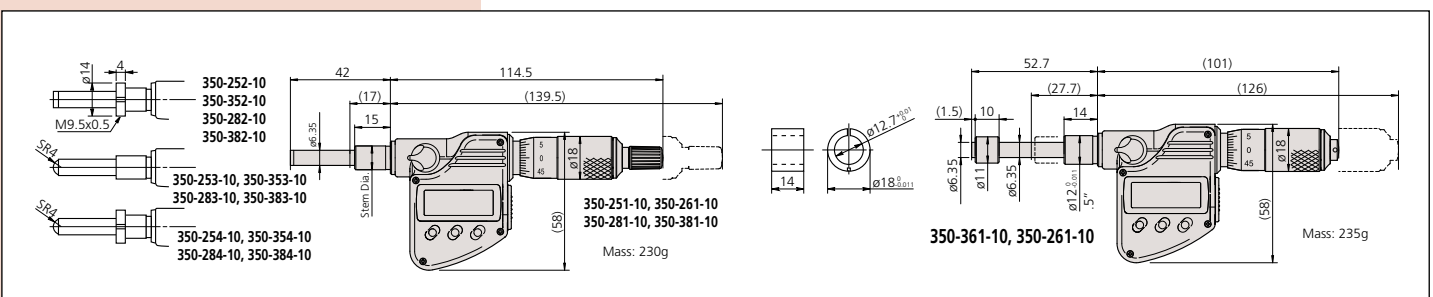

# Micrometer Heads

## SERIES 148 — Fine Spindle Feeding of 0.1mm/rev

### FEATURES

- Fine spindle feeding of just 0.1mm/rev for extra-fine adjustment and positioning.
- External dimensions are compatible with conventional 0.5mm pitch heads.

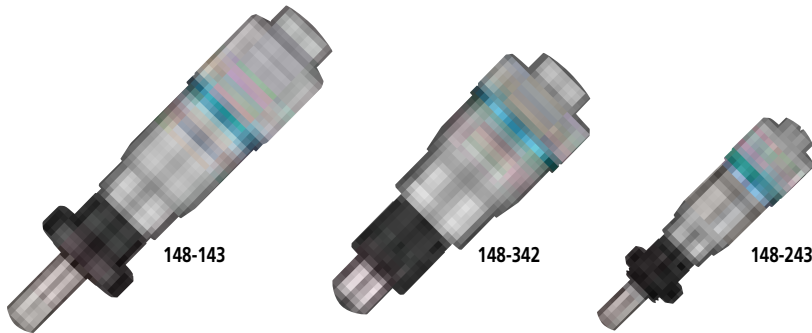

### SPECIFICATIONS

Metric						
Range	Order No.	Accuracy	Stem dia.	Stem	Spindle face	Remarks
0 - 6.5mm	148-142	±2μm	9.5mm	Plain	Spherical (SR4)	—
0 - 6.5mm	148-143	±2μm	9.5mm	w/clamp nut	Spherical (SR4)	—
0 - 6.5mm	148-342	±2μm	9.5mm	Plain	Spherical (SR4)	Thicker & shorter thimble
0 - 6.5mm	148-343	±2μm	9.5mm	w/clamp nut	Spherical (SR4)	Thicker & shorter thimble
0 - 6.5mm	148-242	±5μm	6mm	Plain	Spherical (SR3)	Small thimble diameter
0 - 6.5mm	148-243	±5μm	6mm	w/clamp nut	Spherical (SR3)	Small thimble diameter

### DIMENSIONS AND MASS

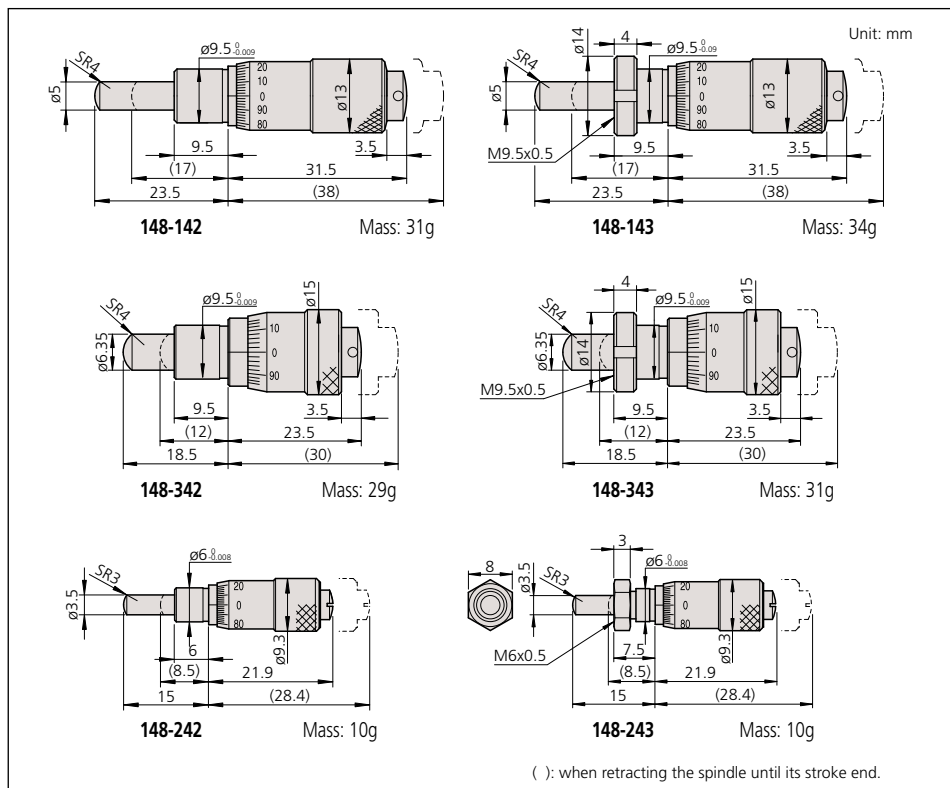

### Technical Data

Graduations: 0.002mm  
 Spindle pitch: 0.1mm  
 Spindle face: Spherical of SKS3 (more than HRC60), lapped surface  
 Scale surface: Hard-chrome plating  
 Fixture thickness for clamp nut: 6mm (148-243: 4mm)

### Spindle pitch

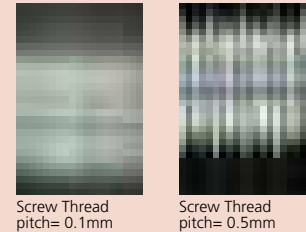

### Applications

Semiconductor wafer positioning machinery and optical component alignment units, etc.

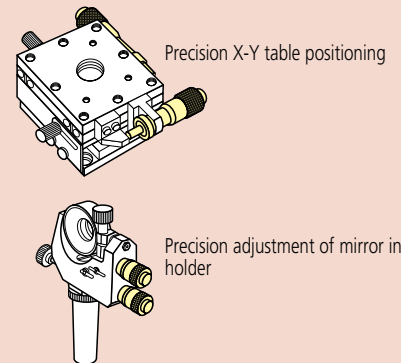

Comparison of mounting dimensions between a standard fine-pitch head and a standard conventional pitch head at the mid-range travel position.

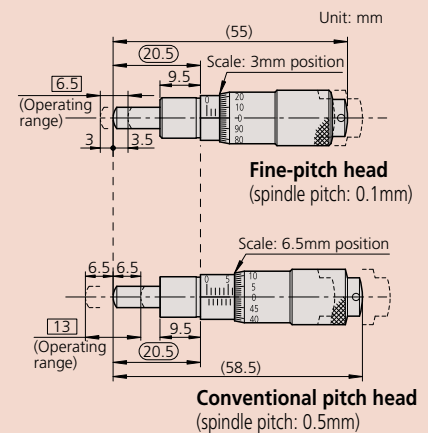

While the fine-pitch micrometer head has a measuring range of 6.5mm, the conventional head has a larger range of 13mm. When replacing a conventional head, the fine-pitch type can use the common range in the middle of the spindle travel. The standard and compact types of fine-pitch head are completely interchangeable.



# Micrometer Heads

**SERIES 148 — Fine Spindle Feeding of 0.25 mm / rev**

## Technical Data

Graduations: 0.01mm  
 Spindle pitch: 0.25mm  
 Spindle face: Spherical of SKS3 (more than HRC60), lapped surface  
 Scale surface: Hard-chrome plating  
 Fixture thickness for clamp nut: 6mm

## FEATURES

- Fine spindle feeding of just 0.25mm/rev for fine adjustment and positioning.



148-132

## SPECIFICATIONS

Metric

Range	Order No.	Accuracy	Stem dia.	Stem	Spindle face
0 - 13mm	<b>148-132</b>	2μm	9.5mm	Plain	Spherical (SR4)
0 - 13mm	<b>148-133</b>	2μm	9.5mm	w/clamp nut	Spherical (SR4)
0 - 6.5mm	<b>148-322</b>	2μm	9.5mm	Plain	Spherical (SR4)
0 - 6.5mm	<b>148-323</b>	2μm	9.5mm	w/ clamp nut	Spherical (SR4)

## DIMENSIONS AND MASS

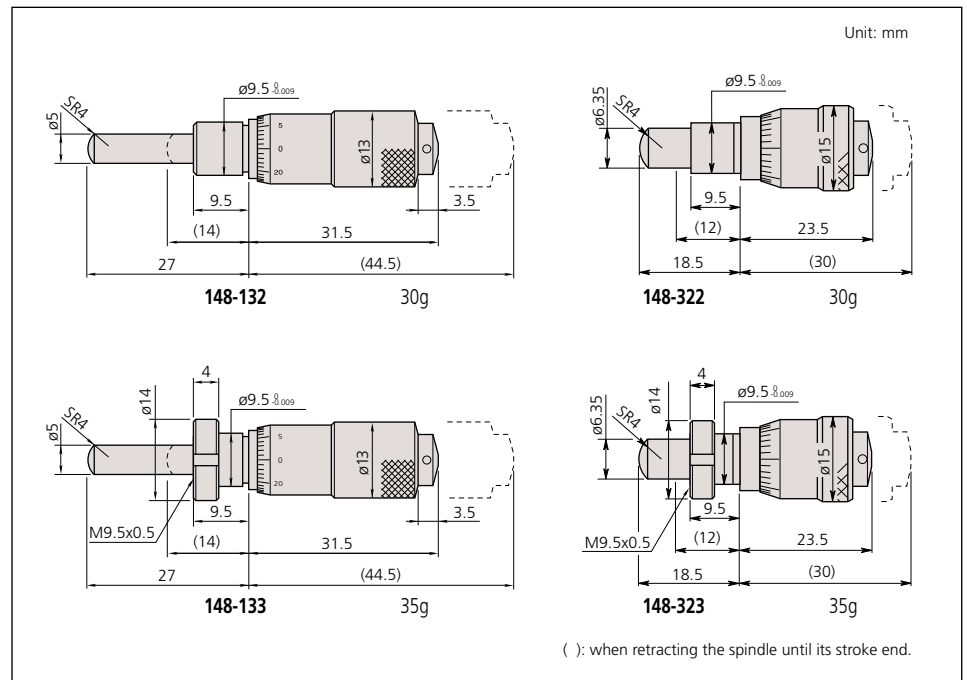

# Micrometer Heads

## SERIES 148 — Ultra-Small/Small Type

### FEATURES

- Miniature micrometer heads for ease of incorporating into machines.



### Technical Data

Graduations: 0.02mm (148-215, 148-216), 0.01mm or .001"  
 Spindle pitch: 0.5mm  
 Spindle face: Flat or spherical of SKS3 (more than HRC60), lapped surface  
 Scale surface: Hard-chrome plating  
 Fixture thickness for clamp nut: 3mm (148-216, 148-218), 4mm

### SPECIFICATIONS

Metric						
Range	Order No.	Accuracy	Stem dia.	Stem	Spindle face	Remarks
0 - 5mm	148-215	±5μm	3.5mm	Plain	Spherical (SR1.5)	—
0 - 5mm	148-216	±5μm	3.5mm	w/clamp nut	Spherical (SR1.5)	—
0 - 6.5mm	148-201	±5μm	6mm	Plain	Flat	—
0 - 6.5mm	148-203	±5μm	6mm	w/clamp nut	Flat	—
0 - 6.5mm	148-205	±5μm	6mm	Plain	Spherical (SR3)	—
0 - 6.5mm	148-207	±5μm	6mm	w/clamp nut	Spherical (SR3)	—
6.5 - 0 mm	148-209	±5μm	6mm	Plain	Flat	Reverse reading
6.5 - 0 mm	148-211	±5μm	6mm	w/ clamp nut	Flat	Reverse reading

Inch						
Range	Order No.	Accuracy	Stem dia.	Stem	Spindle face	Remarks
0 - .2"	148-217	±5μm	.156"	Plain	Spherical (SR1.5)	—
0 - .2"	148-218	±5μm	.156"	w/clamp nut	Spherical (SR1.5)	—
0 - .25"	148-202	±5μm	.25"	Plain	Flat	—
0 - .25"	148-204	±5μm	.25"	w/clamp nut	Flat	—
0 - .25"	148-206	±5μm	.25"	Plain	Spherical (SR3)	—
0 - .25"	148-208	±5μm	.25"	w/clamp nut	Spherical (SR3)	—
.25 - 0"	148-210	±5μm	.25"	Plain	Flat	Reverse reading
.25 - 0"	148-212	±5μm	.25"	w/ clamp nut	Flat	Reverse reading

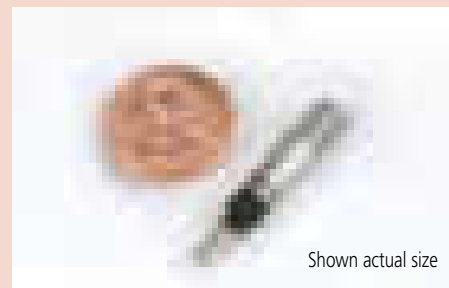

### DIMENSIONS AND MASS

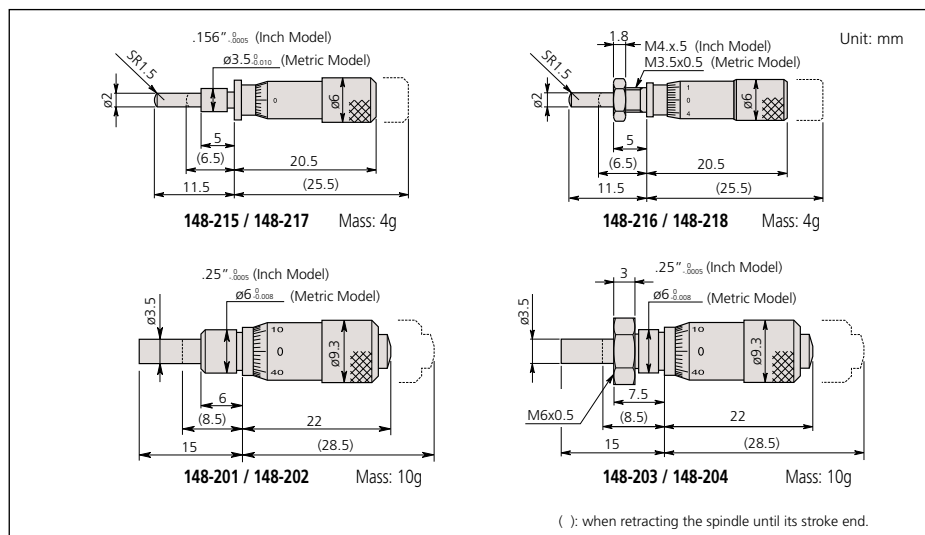

# Micrometer Heads

## SERIES 148 — Large Thimble Diameter for Easy Reading

### FEATURES

- Easy reading due to the large thimble diameter. (Three types of thimble diameters can be selected.)

### SPECIFICATIONS

#### Metric

Range	Order No.	Accuracy	Stem dia.	Stem	Spindle face	Thimble Dia.
0 - 6.5mm	<b>148-301</b>	±2μm	9.5mm	Plain	Flat	15mm
0 - 6.5mm	<b>148-302</b>	±2μm	9.5mm	w/clamp nut	Flat	15mm
0 - 6.5mm	<b>148-303</b>	±2μm	9.5mm	Plain	Flat	20mm
0 - 6.5mm	<b>148-304</b>	±2μm	9.5mm	w/clamp nut	Flat	20mm
0 - 6.5mm	<b>148-305</b>	±2μm	9.5mm	Plain	Flat	29mm
0 - 6.5mm	<b>148-306</b>	±2μm	9.5mm	w/clamp nut	Flat	29mm
0 - 13mm	<b>148-307</b>	±2μm	9.5mm	Plain	Flat	15mm
0 - 13mm	<b>148-308</b>	±2μm	9.5mm	w/clamp nut	Flat	15mm
0 - 13mm	<b>148-309</b>	±2μm	9.5mm	Plain	Flat	20mm
0 - 13mm	<b>148-310</b>	±2μm	9.5mm	w/clamp nut	Flat	20mm
0 - 13mm	<b>148-311</b>	±2μm	9.5mm	Plain	Flat	29mm
0 - 13mm	<b>148-312</b>	±2μm	9.5mm	w/ clamp nut	Flat	29mm

#### Inch

Range	Order No.	Accuracy	Stem dia.	Stem	Spindle face	Thimble Dia.
0 - .25"	<b>148-351</b>	±.0001"	.375"	Plain	Flat	.59"
0 - .25"	<b>148-352</b>	±.0001"	.375"	w/clamp nut	Flat	.59"
0 - .25"	<b>148-353</b>	±.0001"	.375"	Plain	Flat	.79"
0 - .25"	<b>148-354</b>	±.0001"	.375"	w/clamp nut	Flat	.79"
0 - .25"	<b>148-355</b>	±.0001"	.375"	Plain	Flat	1.14"
0 - .25"	<b>148-356</b>	±.0001"	.375"	w/clamp nut	Flat	1.14"
0 - .5"	<b>148-357</b>	±.0001"	.375"	Plain	Flat	.59"
0 - .5"	<b>148-358</b>	±.0001"	.375"	w/clamp nut	Flat	.59"
0 - .5"	<b>148-359</b>	±.0001"	.375"	Plain	Flat	.79"
0 - .5"	<b>148-360</b>	±.0001"	.375"	w/clamp nut	Flat	.79"
0 - .5"	<b>148-361</b>	±.0001"	.375"	Plain	Flat	1.14"
0 - .5"	<b>148-362</b>	±.0001"	.375"	w/ clamp nut	Flat	1.14"



148-301



148-303



148-305

### Technical Data

Graduations: 0.01mm or .001"  
 Spindle pitch: 0.5mm or .025"  
 Spindle face: Flat of SKS3 (more than HRC60),  
 lapped surface  
 Scale surface: Hard-chrome plating  
 Fixture thickness for clamp nut: 6mm

### DIMENSIONS AND MASS

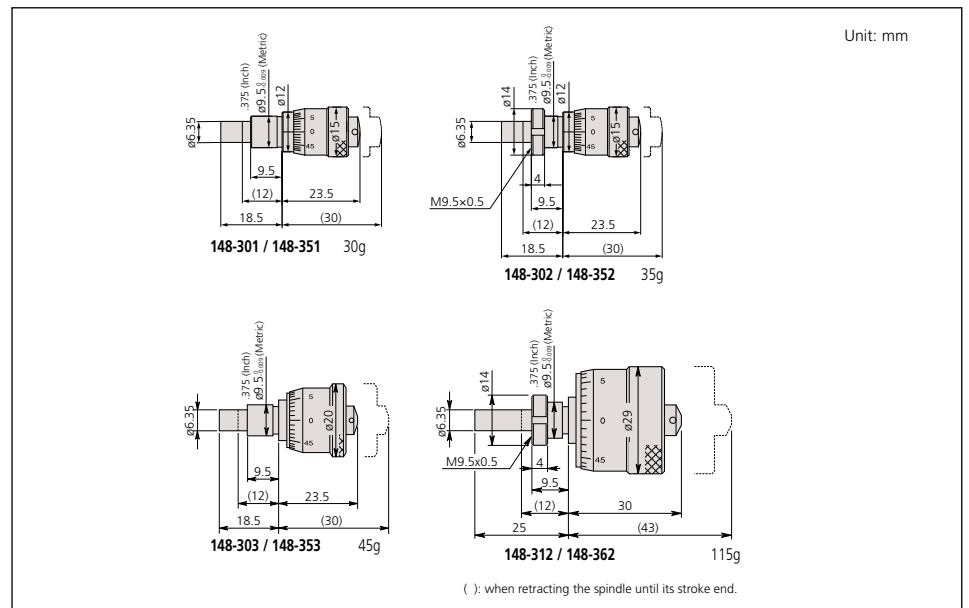

# Micrometer Heads

## SERIES 148 — Common Type in Small Size

### SPECIFICATIONS

Metric						
Range	Order No.	Accuracy	Stem dia.	Stem	Spindle face	Remarks
0 - 13mm	<b>148-104</b>	±2μm	9.5mm	Plain	Flat	—
0 - 13mm	<b>148-103</b>	±2μm	9.5mm	w/clamp nut	Flat	—
0 - 13mm	<b>148-121</b>	±2μm	9.5mm	Plain*	Flat	—
0 - 13mm	<b>148-120</b>	±2μm	9.5mm	w/clamp nut*	Flat	—
0 - 13mm	<b>148-801</b>	±2μm	9.5mm	Plain	Spherical (SR4)	—
0 - 13mm	<b>148-802</b>	±2μm	9.5mm	w/clamp nut	Spherical (SR4)	—
0 - 13mm	<b>148-803</b>	±2μm	9.5mm	Plain*	Spherical (SR4)	—
0 - 13mm	<b>148-804</b>	±2μm	9.5mm	w/clamp nut*	Spherical (SR4)	—
13mm - 0	<b>148-821</b>	±2μm	9.5mm	Plain	Flat	Reverse reading
13mm - 0	<b>148-822</b>	±2μm	9.5mm	w/clamp nut	Flat	Reverse reading
13mm - 0	<b>148-823</b>	±2μm	9.5mm	Plain*	Flat	Reverse reading
13mm - 0	<b>148-824</b>	±2μm	9.5mm	w/ clamp nut*	Flat	Reverse reading

\*with spindle lock

Inch						
Range	Order No.	Accuracy	Stem dia.	Stem	Spindle face	Remarks
0 - .5"	<b>148-112</b>	±.0001"	.375"	Plain	Flat	—
0 - .5"	<b>148-111</b>	±.0001"	.375"	w/clamp nut	Flat	—
0 - .5"	<b>148-123</b>	±.0001"	.375"	Plain*	Flat	—
0 - .5"	<b>148-122</b>	±.0001"	.375"	w/clamp nut*	Flat	—
0 - .5"	<b>148-811</b>	±.0001"	.375"	Plain	Spherical (SR4)	—
0 - .5"	<b>148-812</b>	±.0001"	.375"	w/clamp nut	Spherical (SR4)	—
0 - .5"	<b>148-813</b>	±.0001"	.375"	Plain*	Spherical (SR4)	—
0 - .5"	<b>148-814</b>	±.0001"	.375"	w/clamp nut*	Spherical (SR4)	—
.5" - 0	<b>148-831</b>	±.0001"	.375"	Plain	Flat	Reverse reading
.5" - 0	<b>148-832</b>	±.0001"	.375"	w/clamp nut	Flat	Reverse reading
.5" - 0	<b>148-833</b>	±.0001"	.375"	Plain*	Flat	Reverse reading
.5" - 0	<b>148-834</b>	±.0001"	.375"	w/ clamp nut*	Flat	Reverse reading

\*with spindle lock

### DIMENSIONS AND MASS

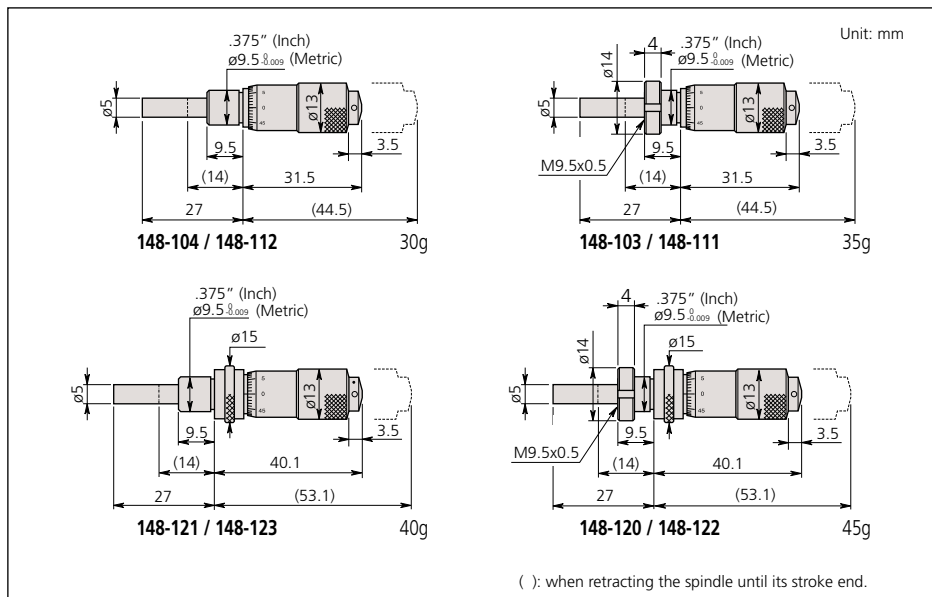

148-103

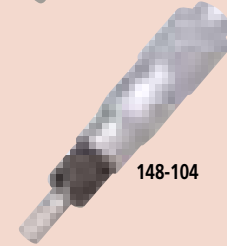

148-104



148-121



148-120

### Technical Data

Graduations: 0.01mm or .001"

Spindle pitch: 0.5mm

Spindle face: Flat or spherical of SKS3 (more than HR60), lapped surface

Scale surface: Hard-chrome plating

Fixture thickness for clamp nut: 6mm

# Micrometer Heads

## SERIES 148 — Common Type in Small Size with Zero-Adjustable Thimble

### FEATURES

- The thimble can be set to zero at any position by loosening the set screw.

### SPECIFICATIONS

#### Metric

Range	Order No.	Accuracy	Stem dia.	Stem	Spindle face	Remarks
0 - 13mm	<b>148-503</b>	±2μm	9.5mm	Plain	Flat	—
0 - 13mm	<b>148-513</b>	±2μm	9.5mm	Plain	Flat	Stainless steel throughout
0 - 13mm	<b>148-508</b>	±2μm	9.5mm	w/clamp nut	Flat	—
0 - 13mm	<b>148-506</b>	±2μm	9.5mm	Plain*	Flat	—
0 - 13mm	<b>148-504</b>	±2μm	9.5mm	w/clamp nut*	Flat	—
0 - 13mm	<b>148-853</b>	±2μm	9.5mm	Plain	Spherical (SR4)	—
0 - 13mm	<b>148-854</b>	±2μm	9.5mm	w/clamp nut*	Spherical (SR4)	—
13mm - 0	<b>148-863</b>	±2μm	9.5mm	Plain	Flat	Reverse reading
13mm - 0	<b>148-864</b>	±2μm	9.5mm	w/ clamp nut*	Flat	Reverse reading

\*with spindle lock

#### Inch

Range	Order No.	Accuracy	Stem dia.	Stem	Spindle face	Remarks
0 - .5"	<b>148-501</b>	±.0001"	.375"	Plain	Flat	—
0 - .5"	<b>148-511</b>	±.0001"	.375"	Plain	Flat	Stainless steel throughout
0 - .5"	<b>148-507</b>	±.0001"	.375"	w/clamp nut	Flat	—
0 - .5"	<b>148-505</b>	±.0001"	.375"	Plain*	Flat	—
0 - .5"	<b>148-502</b>	±.0001"	.375"	w/clamp nut*	Flat	—
0 - .5"	<b>148-851</b>	±.0001"	.375"	Plain	Spherical (SR4)	—
0 - .5"	<b>148-852</b>	±.0001"	.375"	w/clamp nut*	Spherical (SR4)	—
.5" - 0	<b>148-861</b>	±.0001"	.375"	Plain	Flat	Reverse reading
.5" - 0	<b>148-862</b>	±.0001"	.375"	w/ clamp nut*	Flat	Reverse reading

\*with spindle lock



### Technical Data

Graduations: 0.01mm or .001"

Spindle pitch: 0.5mm

Spindle face: Flat or spherical of SKS3 (more than HRC60), lapped surface

Scale surface: Hard-chrome plating

Fixture thickness for clamp nut: 6mm

### DIMENSIONS AND MASS

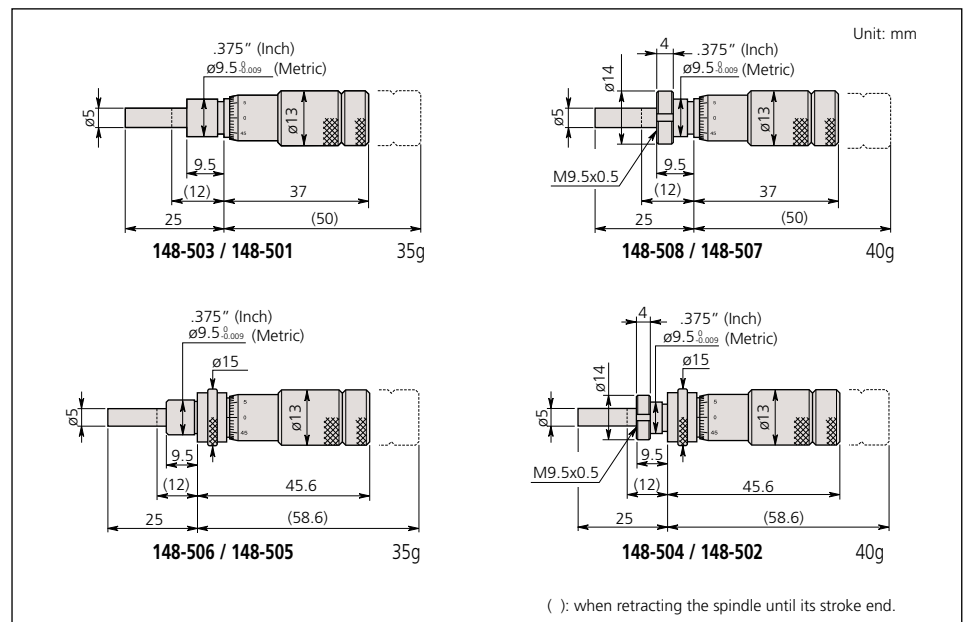

# Micrometer Heads

## SERIES 149 — Common Type in Small Size with Carbide-tipped Spindle

### FEATURES

- Carbide-tipped measuring face.

### SPECIFICATIONS

#### Metric

Range	Order No.	Accuracy	Stem dia.	Stem	Spindle face	Remarks
0 - 15mm	<b>149-132</b>	±2µm	9.5mm	Plain	Flat (carbide tip)	—
0 - 15mm	<b>149-131</b>	±2µm	9.5mm	w/clamp nut	Flat (carbide tip)	—
0 - 15mm	<b>149-183</b>	±2µm	9.5mm	Plain*	Flat (carbide tip)	With spindle lock
0 - 15mm	<b>149-184</b>	±2µm	9.5mm	w/clamp nut*	Flat (carbide tip)	With spindle lock
0 - 15mm	<b>149-801</b>	±2µm	9.5mm	Plain	Spherical (SR4)	—
0 - 15mm	<b>149-802</b>	±2µm	9.5mm	w/clamp nut	Spherical (SR4)	—
15mm - 0	<b>149-821</b>	±2µm	9.5mm	Plain	Flat (carbide tip)	Reverse reading
15mm - 0	<b>149-822</b>	±2µm	9.5mm	w/ clamp nut	Flat (carbide tip)	Reverse reading

\*with spindle lock.

#### Inch

Range	Order No.	Accuracy	Stem dia.	Stem	Spindle face	Remarks
0 - .5"	<b>149-148</b>	±.0001"	.375"	Plain	Flat (carbide tip)	—
0 - .5"	<b>149-147</b>	±.0001"	.375"	w/clamp nut	Flat (carbide tip)	—
0 - .5"	<b>149-185</b>	±.0001"	.375"	Plain*	Flat (carbide tip)	With spindle lock
0 - .5"	<b>149-182</b>	±.0001"	.375"	w/clamp nut*	Flat (carbide tip)	With spindle lock
0 - .5"	<b>149-811</b>	±.0001"	.375"	Plain	Spherical (SR4)	—
0 - .5"	<b>149-812</b>	±.0001"	.375"	w/clamp nut	Spherical (SR4)	—
.5" - 0	<b>149-831</b>	±.0001"	.375"	Plain	Flat (carbide tip)	Reverse reading
.5" - 0	<b>149-832</b>	±.0001"	.375"	w/ clamp nut	Flat (carbide tip)	Reverse reading

\*with spindle lock.

### DIMENSIONS AND MASS

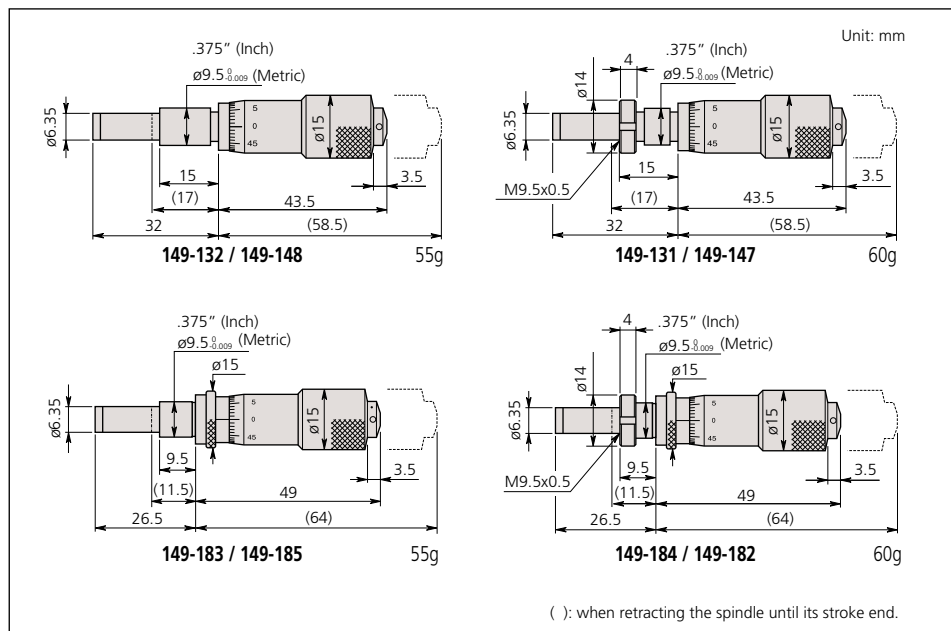

### Technical Data

Graduations: 0.01mm or .001"

Spindle pitch: 0.5mm

Spindle face: Flat with carbide tip (more than HRA90) or spherical, lapped surface

Scale surface: Hard-chrome plating

Fixture thickness for clamp nut: 6mm

(149-131, 149-147: 11.5mm)

# Micrometer Heads

## SERIES 150 — Common Type in Middle Size

### FEATURES

- Ratchet stop for constant force.
- Long spindle type is available for a variety of applications.
- Carbide-tipped measuring face.

### SPECIFICATIONS

#### Metric

Range	Order No.	Accuracy	Stem dia.	Stem	Spindle face	Remarks
0 - 25mm	<b>150-192</b>	±2μm	10mm	Plain	Flat (carbide tip)	—
0 - 25mm	<b>150-191</b>	±2μm	10mm	w/clamp nut	Flat (carbide tip)	—
0 - 25mm	<b>150-209</b>	±2μm	10mm	Plain*	Flat (carbide tip)	—
0 - 25mm	<b>150-210</b>	±2μm	10mm	w/clamp nut*	Flat (carbide tip)	—
0 - 25mm	<b>150-801</b>	±2μm	10mm	Plain	Spherical (SR4)	—
0 - 25mm	<b>150-802</b>	±2μm	10mm	w/clamp nut	Spherical (SR4)	—
0 - 25mm	<b>150-821</b>	±2μm	10mm	Plain	Flat (carbide tip)	Reverse reading
0 - 25mm	<b>150-822</b>	±2μm	10mm	w/clamp nut	Flat (carbide tip)	Reverse reading
0 - 25mm	<b>150-190</b>	±2μm	10mm	Plain	Flat (carbide tip)	w/ vernier (0.001mm)
0 - 25mm	<b>150-189</b>	±2μm	10mm	w/clamp nut	Flat (carbide tip)	w/ vernier (0.001mm)
0 - 25mm	<b>150-196</b>	±2μm	10mm	Plain*	Flat (carbide tip)	w/ vernier (.0001mm)
0 - 25mm	<b>150-195</b>	±2μm	10mm	w/clamp nut*	Flat (carbide tip)	w/ vernier (.0001mm)
0 - 25mm	<b>150-211</b>	±2μm	10mm	Plain*	Flat (carbide tip)	w/o ratchet stop
0 - 25mm	<b>150-212</b>	±2μm	10mm	w/clamp nut*	Flat (carbide tip)	w/o ratchet stop
0 - 25mm	<b>150-219</b>	±2μm	10mm	Plain	Flat	Long spindle
0 - 25mm	<b>150-220</b>	±2μm	10mm	w/ clamp nut	Flat	Long spindle

\*with spindle lock

#### Inch

Range	Order No.	Accuracy	Stem dia.	Stem	Spindle face	Remarks
0 - 1"	<b>150-208</b>	±.0001"	.375"	Plain	Flat (carbide tip)	—
0 - 1"	<b>150-198</b>	±.0001"	.375"	Plain	Flat (carbide tip)	w/o ratchet stop
0 - 1"	<b>150-207</b>	±.0001"	.375"	w/clamp nut	Flat (carbide tip)	—
0 - 1"	<b>150-197</b>	±.0001"	.375"	w/clamp nut	Flat (carbide tip)	w/o ratchet stop
0 - 1"	<b>150-213</b>	±.0001"	.375"	Plain*	Flat (carbide tip)	—
0 - 1"	<b>150-214</b>	±.0001"	.375"	w/clamp nut*	Flat (carbide tip)	—
0 - 1"	<b>150-811</b>	±.0001"	.375"	Plain	Spherical (SR4)	—
0 - 1"	<b>150-812</b>	±.0001"	.375"	w/clamp nut	Spherical (SR4)	—
0 - 1"	<b>150-831</b>	±.0001"	.375"	Plain	Flat (carbide tip)	Reverse reading
0 - 1"	<b>150-832</b>	±.0001"	.375"	w/clamp nut	Flat (carbide tip)	Reverse reading
0 - 1"	<b>150-206</b>	±.0001"	.375"	Plain	Flat (carbide tip)	w/ vernier (.0001")
0 - 1"	<b>150-205</b>	±.0001"	.375"	w/clamp nut	Flat (carbide tip)	w/ vernier (.0001")
0 - 1"	<b>150-215</b>	±.0001"	.375"	Plain*	Flat (carbide tip)	w/ vernier (.0001")
0 - 1"	<b>150-216</b>	±.0001"	.375"	w/clamp nut*	Flat (carbide tip)	w/ vernier (.0001")
0 - 1"	<b>150-217</b>	±.0001"	.375"	Plain*	Flat (carbide tip)	w/o ratchet stop
0 - 1"	<b>150-218</b>	±.0001"	.375"	w/clamp nut*	Flat (carbide tip)	w/o ratchet stop
0 - 1"	<b>150-221</b>	±.0001"	.375"	Plain	Flat	Long spindle
0 - 1"	<b>150-222</b>	±.0001"	.375"	w/ clamp nut	Flat	Long spindle

\*with spindle lock

### DIMENSIONS AND MASS

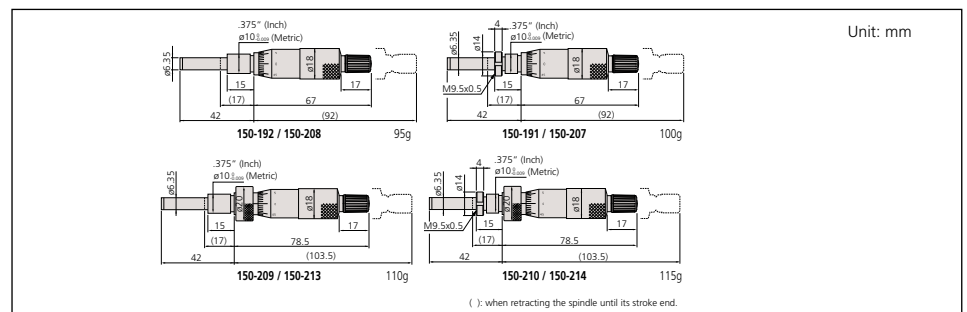

### Technical Data

Graduations: 0.01mm, 0.001mm, .001" or .0001"  
 Spindle pitch: 0.5mm  
 Spindle face: Flat with carbide tip\* (more than HRA90) or spherical, lapped surface  
 \*Long spindle type: SKS3 (more than HRC60)  
 Scale surface: Hard-chrome plating  
 Fixture thickness for clamp nut: 11.5mm

# Micrometer Heads

## SERIES 151 — Common Type in Middle Size with 8mm Diameter Spindle

### FEATURES

- 8mm diameter spindle for heavy-duty use.
- Ratchet stop for constant force.
- Carbide-tipped measuring face.

### SPECIFICATIONS

Metric						
Range	Order No.	Accuracy	Stem dia.	Stem	Spindle face	Remarks
0 - 25mm	151-224	±2µm	12mm	Plain	Flat (carbide tip)	—
0 - 25mm	151-223	±2µm	12mm	w/clamp nut	Flat (carbide tip)	—
0 - 25mm	151-214	±2µm	12mm	Plain*	Flat (carbide tip)	—
0 - 25mm	151-213	±2µm	12mm	w/clamp nut*	Flat (carbide tip)	—
0 - 25mm	151-222	±2µm	12mm	Plain	Flat (carbide tip)	w/ vernier (0.001mm)
0 - 25mm	151-221	±2µm	12mm	w/clamp nut	Flat (carbide tip)	w/ vernier (0.001mm)
0 - 25mm	151-212	±2µm	12mm	Plain*	Flat (carbide tip)	w/ vernier (0.001mm)
0 - 25mm	151-211	±2µm	12mm	w/clamp nut*	Flat (carbide tip)	w/ vernier (0.001mm)
0 - 25mm	151-227	±2µm	12mm	Plain	Flat (carbide tip)	w/o ratchet stop
0 - 25mm	151-228	±2µm	12mm	w/clamp nut	Flat (carbide tip)	w/o ratchet stop
0 - 25mm	151-225	±2µm	12mm	Plain*	Flat (carbide tip)	w/o ratchet stop
0 - 25mm	151-226	±2µm	12mm	w/clamp nut*	Flat (carbide tip)	w/o ratchet stop
0 - 50mm	151-256	±4µm	12mm	Plain	Flat (carbide tip)	—
0 - 50mm	151-255	±4µm	12mm	w/clamp nut	Flat (carbide tip)	—
0 - 50mm	151-260	±4µm	12mm	Plain	Flat (carbide tip)	w/o ratchet stop
0 - 50mm	151-259	±4µm	12mm	w/ clamp nut	Flat (carbide tip)	w/o ratchet stop

\*with spindle lock

Inch						
Range	Order No.	Accuracy	Stem dia.	Stem	Spindle face	Remarks
0 - 1"	151-240	±.0001"	.5"	Plain	Flat (carbide tip)	—
0 - 1"	151-239	±.0001"	.5"	w/clamp nut	Flat (carbide tip)	—
0 - 1"	151-238	±.0001"	.5"	Plain	Flat (carbide tip)	w/ vernier (.0001")
0 - 1"	151-237	±.0001"	.5"	w/clamp nut	Flat (carbide tip)	w/ vernier (.0001")
0 - 1"	151-243**	±.0001"	.5"	Plain*	Flat (carbide tip)	w/ vernier (.0001")
0 - 1"	151-244**	±.0001"	.5"	w/clamp nut*	Flat (carbide tip)	w/ vernier (.0001")
0 - 1"	151-241	±.0001"	.5"	Plain*	Flat (carbide tip)	w/o ratchet stop
0 - 1"	151-242	±.0001"	.5"	w/clamp nut*	Flat (carbide tip)	w/o ratchet stop
0 - 2"	151-272	±.0002"	.5"	Plain	Flat (carbide tip)	—
0 - 2"	151-271	±.0002"	.5"	w/clamp nut	Flat (carbide tip)	—

\*with spindle lock \*\*with ratchet stop

### DIMENSIONS AND MASS

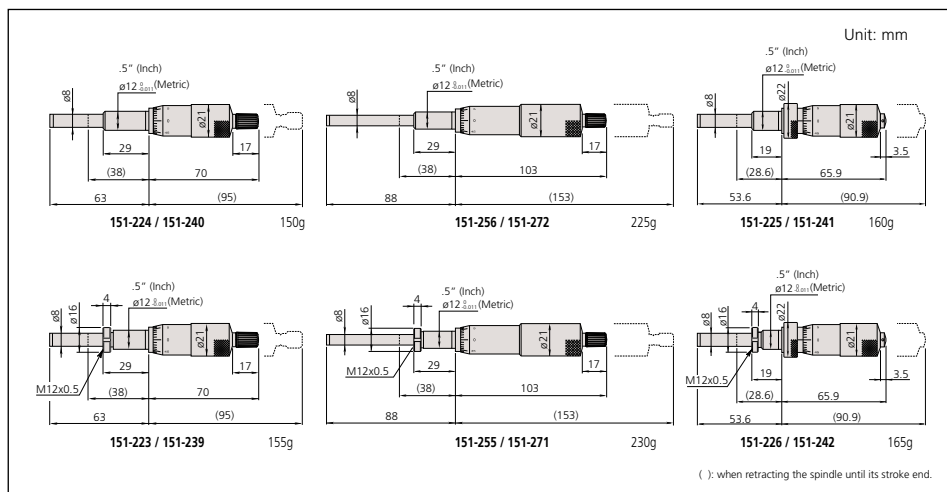

### Technical Data

Graduations: 0.01mm, 0.001mm, .001" or .0001"  
 Spindle pitch: 0.5mm  
 Spindle face: Flat with carbide tip (more than HRA90), lapped surface  
 Scale surface: Hard-chrome plating  
 Fixture thickness for clamp nut: 25.5mm



# Micrometer Heads

## SERIES 153 — Non-rotating Spindle Type

### FEATURES

- Carbide-tipped measuring face.
- Non-rotating spindle.

### SPECIFICATIONS

#### Metric

Range	Order No.	Accuracy	Stem dia.	Stem	Spindle face	Remarks
0 - 15mm	<b>153-101</b>	±3μm	9.5mm	Plain	Flat (carbide tip)	—
0 - 25mm	<b>153-201*</b>	±3μm	12mm	Plain	Flat (carbide tip)	—
0 - 25mm	<b>153-202*</b>	±3μm	12mm	Plain	Flat (carbide tip)	w/ vernier (0.001mm)
0 - 25mm	<b>153-203</b>	±3μm	12mm	Plain	Flat (carbide tip)	—
0 - 25mm	<b>153-204</b>	±3μm	12mm	Plain	Flat (carbide tip)	w/ vernier (0.001mm)

\*with ratchet stop

#### Inch

Range	Order No.	Accuracy	Stem dia.	Stem	Spindle face	Remarks
0 - .5"	<b>153-108</b>	±.00015"	.375"	Plain	Flat (carbide tip)	—
0 - 1"	<b>153-205*</b>	±.00015"	.5"	Plain	Flat (carbide tip)	—
0 - 1"	<b>153-206*</b>	±.00015"	.5"	Plain	Flat (carbide tip)	w/ vernier (.0001")
0 - 1"	<b>153-207</b>	±.00015"	.5"	Plain	Flat (carbide tip)	—
0 - 1"	<b>153-208</b>	±.00015"	.5"	Plain	Flat (carbide tip)	w/ vernier (.0001")

\*with ratchet stop

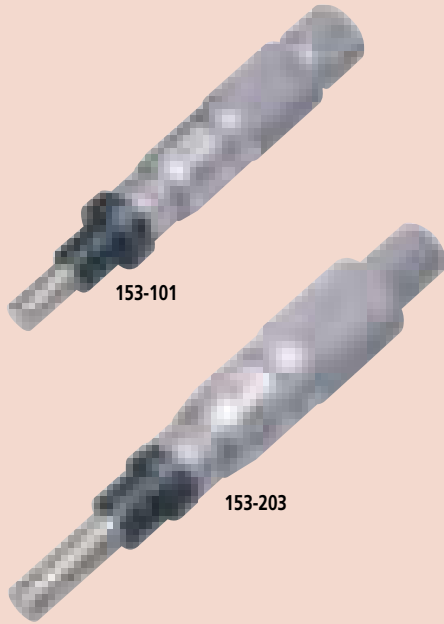

### Technical Data

Graduations: 0.01mm, 0.001mm, .001" or .0001"

Spindle pitch: 0.5mm

Spindle face: Flat with carbide tip (more than HRA90), lapped surface

Scale surface: Hard-chrome plating

### DIMENSIONS AND MASS

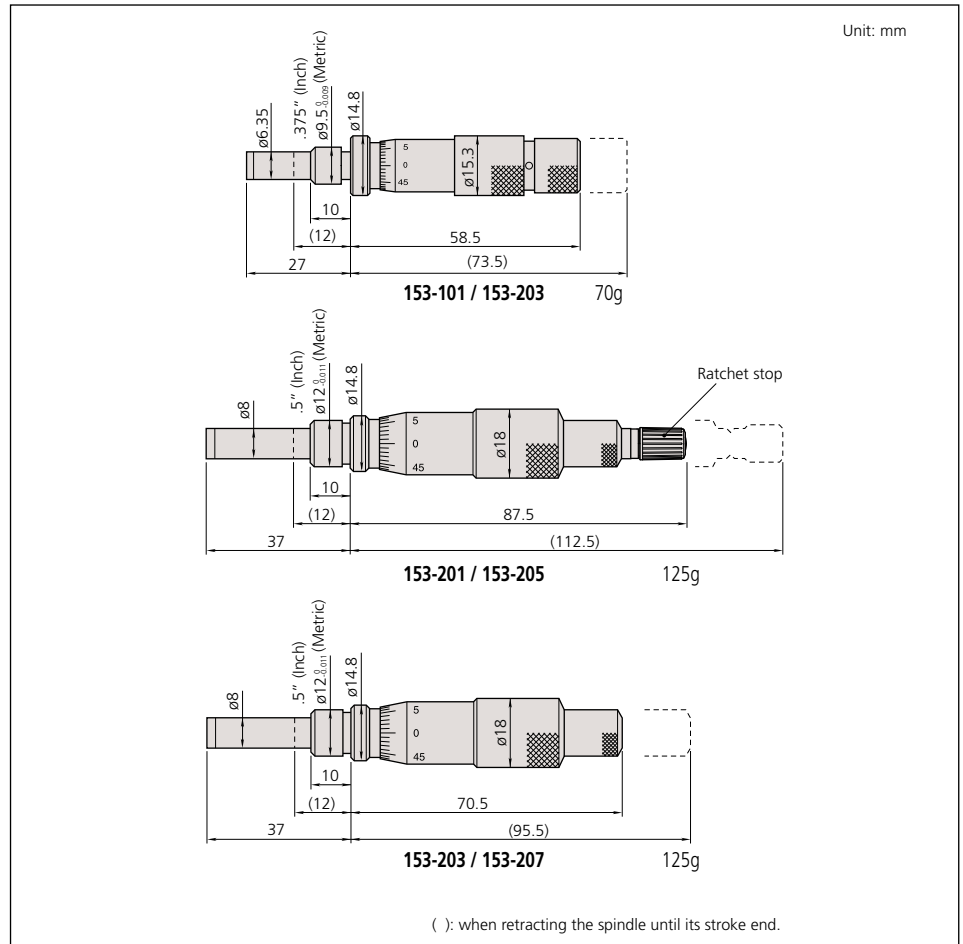

# Micrometer Heads

## SERIES 152 — Quick Spindle Feeding of 1mm/rev.

### FEATURES

- Quick spindle feeding of 1mm/rev.
- Carbide-tipped measuring face.



152-102

### SPECIFICATIONS

#### Metric

Range	Order No.	Accuracy	Stem dia.	Stem	Spindle face	Remarks
0 - 15mm	152-101	±2μm	12mm	Plain	Flat (carbide tip)	—
0 - 25mm	152-102	±2μm	12mm	Plain	Flat (carbide tip)	—
0 - 50mm	152-103	±4μm	12mm	Plain	Flat (carbide tip)	—

### DIMENSIONS AND MASS

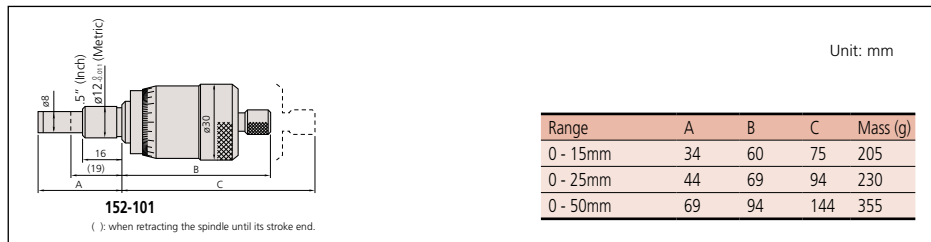

# Micrometer Heads

## SERIES 152 — Large Thimble Type for Fine Feeding

### FEATURES

- The large diameter thimble for fine adjustment and positioning.
- Carbide-tipped measuring face.

### SPECIFICATIONS

#### Metric

Range	Order No.	Accuracy	Stem dia.	Stem	Spindle face	Remarks
0 - 10mm	152-283	±2μm	12mm	w/clamp nut	Flat (carbide tip)	—
0 - 25mm	152-332	±2μm	12mm	Plain	Flat (carbide tip)	—
0 - 25mm	152-348	±2μm	12mm	Plain	Flat (carbide tip)	Bidirectional graduation
0 - 50mm	152-380	±4μm	12mm	Plain	Flat (carbide tip)	Bidirectional graduation

#### Inch

Range	Order No.	Accuracy	Stem dia.	Stem	Spindle face	Remarks
0 - 1"	152-372	±.0001"	.5"	Plain	Flat (carbide tip)	Bidirectional graduation
0 - 2"	152-388	±.0002"	.5"	Plain	Flat (carbide tip)	Bidirectional graduation

### DIMENSIONS AND MASS

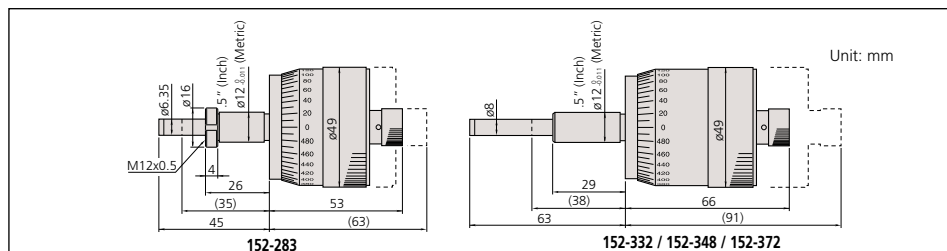

### Technical Data

Graduations: 0.01mm

Spindle pitch: 1mm

Spindle face: Flat with carbide tip (more than HRA90), lapped surface

Scale surface: Hard-chrome plating



152-283

### Technical Data

Graduations: 0.002mm or .0001"

Spindle pitch: 1mm

Spindle face: Flat with carbide tip (more than HRA90), lapped surface

Scale surface: White anodized aluminum

Fixture thickness for clamp nut: 22.5mm

# Micrometer Heads

## SERIES 110 — Differential Screw Translator (Extra-Fine Feeding) Type

### FEATURES

- Differential movements of spindle threads and units allow fine spindle feeding (0.05mm/rev\*), resulting in high-resolution measurements.

\*110-502, 110-504: 0.025mm/rev / .001"/rev (fine feeding)

- Carbide-tipped measuring face.
- Non-rotating spindle.

### SPECIFICATIONS

#### Metric

Range	Order No.	Graduation	Accuracy*	Stem dia.	Stem	Spindle face
0 - 1mm	<b>110-105</b>	0.001mm	±3 / ±1.5µm	12mm	w/clamp nut	Flat (carbide tip)
0 - 1mm	<b>110-106</b>	0.0001mm	±3 / ±1.5µm	12mm	w/clamp nut	Flat (carbide tip)
0 - 1mm	<b>110-107</b>	0.001mm	±3 / ±1.5µm	12mm	w/clamp nut	Flat (carbide tip)
0 - 1mm	<b>110-108</b>	0.0001mm	±3 / ±1.5µm	12mm	w/clamp nut	Flat (carbide tip)
0 - 2.5mm	<b>110-101</b>	0.001mm	±3 / ±1.5µm	12mm	w/clamp nut	Spherical (SR8)
0 - 2.5mm	<b>110-102</b>	0.0001mm	±3 / ±1.5µm	12mm	w/clamp nut	Spherical (SR8)
0 - 13mm	<b>110-502*</b>	0.0005mm 0.01mm	±3 / ±1.5µm	9.5mm	w/clamp nut	Spherical (SR3)

\* Narrow range (within 1 rev.): 0.2mm

#### Inch

Range	Order No.	Graduation	Accuracy*	Stem dia.	Stem	Spindle face
0 - .02"	<b>110-115</b>	.00005"	±.00015" / ±.00006"	.5"	w/clamp nut	Flat (carbide tip)
0 - .02"	<b>110-116</b>	.000005"	±.00015" / ±.00006"	.5"	w/clamp nut	Flat (carbide tip)
0 - .02"	<b>110-117</b>	.00005"	±.00015" / ±.00006"	.5"	w/clamp nut	Flat (carbide tip)
0 - .02"	<b>110-118</b>	.000005"	±.00015" / ±.00006"	.5"	w/clamp nut	Flat (carbide tip)
0 - .05"	<b>110-111</b>	.00005"	±.0002" / ±.00006"	.5"	w/clamp nut	Spherical (SR8)
0 - .05"	<b>110-112</b>	.000005"	±.0002" / ±.00006"	.5"	w/clamp nut	Spherical (SR8)
0 - .5"	<b>110-504*</b>	.00002" .001"	±.00015" / ±.00006"	.375"	w/clamp nut	Spherical (SR3)

\* Narrow range (within 1 rev.): .006"

### Technical Data

Graduations: 0.001mm, 0.0005mm, 0.0001mm, .00005" or .00002", .000005"

Spindle pitch: 0.05mm or 0.025mm

Spindle face: Flat with carbide tip (more than HRA90) or spherical, lapped surface

Scale surface: Hard-chrome plating

Fixture thickness for clamp nut: 9.5mm (11.5mm\*)

\*110-502, 110-504

### DIMENSIONS AND MASS

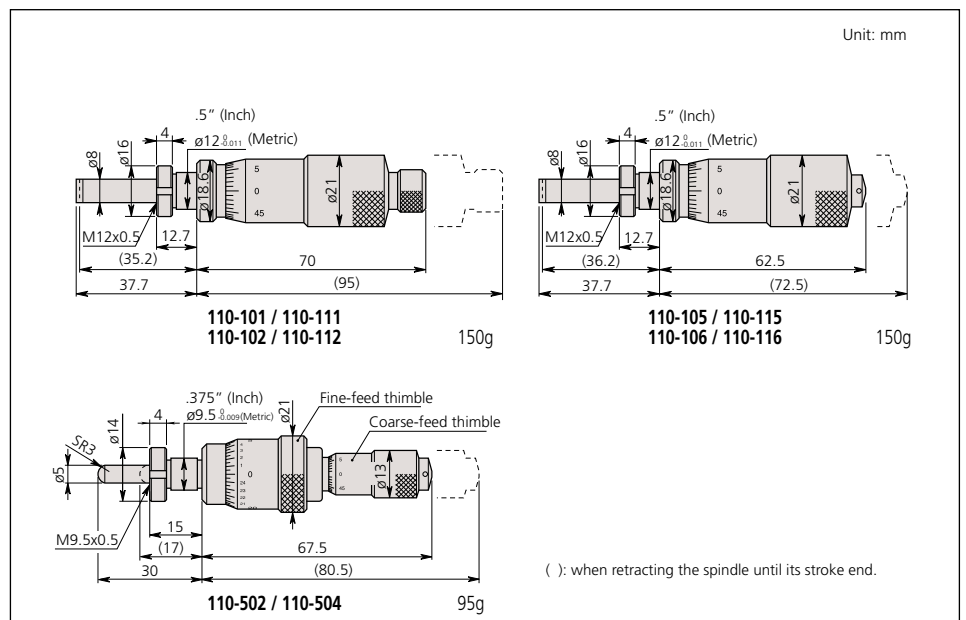

# Micrometer Heads

## SERIES 152 — for XY-Stage

### FEATURES

#### 152-390, 152-389, 152-391, 152-392

- Non-rotating device is attached to the spindle tip.
- Floating thimble allows easy zero setting at any spindle position.
- Bidirectional graduation for easy reading in both directions.

#### 152-401, 152-402

- Adjustable spindle can be moved with the thimble and held at any position, allowing easy zero-setting.

### SPECIFICATIONS

Metric						
Range	Order No.	Accuracy	Stem dia.	Stem	Spindle face	Remarks
0 - 25mm	<b>152-390</b>	$\pm 2\mu\text{m}$	18mm	Plain	Flat (hardened) with non-rotating device	for X-axis, bidirectional grad.
0 - 25mm	<b>152-389</b>	$\pm 2\mu\text{m}$	18mm	Plain		for Y-axis, bidirectional grad.
0 - 25mm	<b>152-402*</b>	$\pm 2\mu\text{m}$	18mm	Plain	Spherical with carbide tip (SR10)	for X-axis, with vernier
0 - 25mm	<b>152-401*</b>	$\pm 2\mu\text{m}$	118mm	Plain		for Y-axis, with vernier

\*0.001mm reading is obtained with vernier

### Inch

Range	Order No.	Accuracy	Stem dia.	Stem	Spindle face	Remarks
0 - 1"	<b>152-392</b>	$\pm .0001"$	.709"	Plain	Flat (hardened) with non-rotating device	for X-axis, Bidirectional grad.
0 - 1"	<b>152-391</b>	$\pm .0001"$	.709"	Plain		for Y-axis, Bidirectional grad.



152-390

### Technical Data

Graduations: 0.005mm, 0.001mm\*  
\*vernier reading

Spindle pitch: 1mm

Spindle face: Flat (hardened) or spherical with carbide tip (more than HRA90), lapped surface  
Scale surface: White anodized aluminum

### DIMENSIONS AND MASS

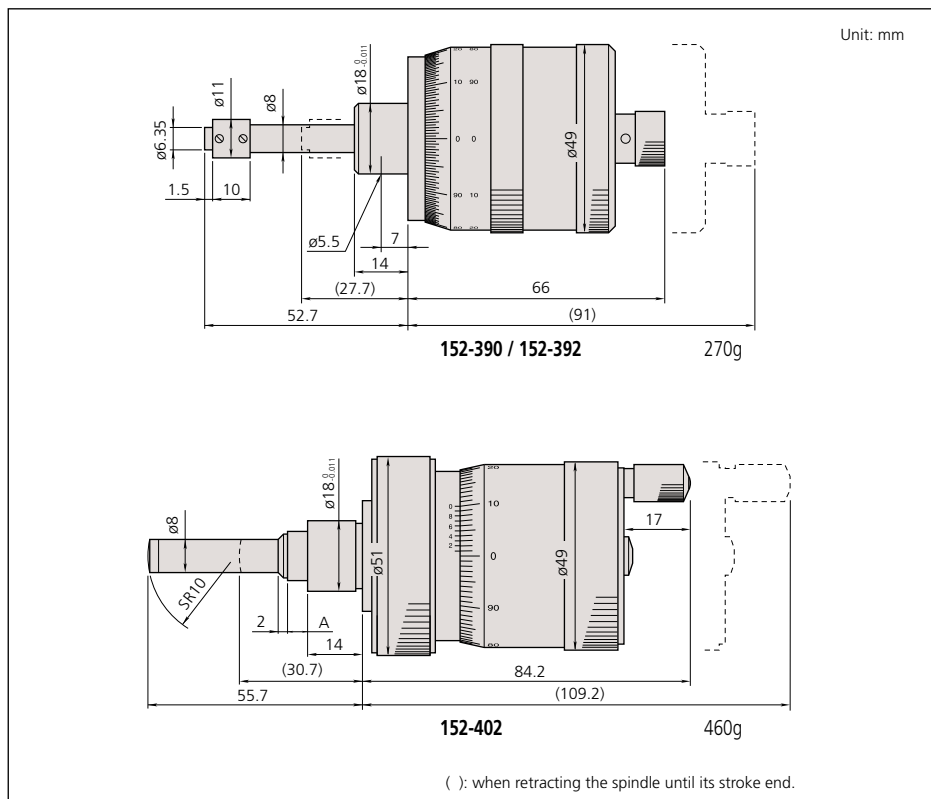

# Micrometer Heads

## SERIES 197 — Non-rotating Spindle and Large Thimble



197-101

### Technical Data

Graduations: 0.005mm or .0002"  
 Spindle pitch: 1mm  
 Spindle face: Flat with carbide tip (more than HRA90), lapped surface  
 Scale surface: White anodized aluminum

### FEATURES

- Large thimble micrometer head with non-rotating spindle.
- Floating thimble allows easy zero setting at any spindle position.
- Bidirectional graduation for easy reading in both directions.
- Dual-spindle mechanism for quick feeding of 1mm/rev.
- Carbide-tipped measuring face.

### SPECIFICATIONS

Metric						
Range	Order No.	Accuracy	Stem dia.	Stem	Spindle face	Remarks
0 - 50mm	197-101	±5µm	18mm	Plain	Flat (carbide tip)	Bidirectional graduation

Inch						
Range	Order No.	Accuracy	Stem dia.	Stem	Spindle face	Remarks
0 - 2"	197-201	±.0002"	.709"	Plain	Flat (carbide tip)	Bidirectional graduation

### DIMENSION AND MASS

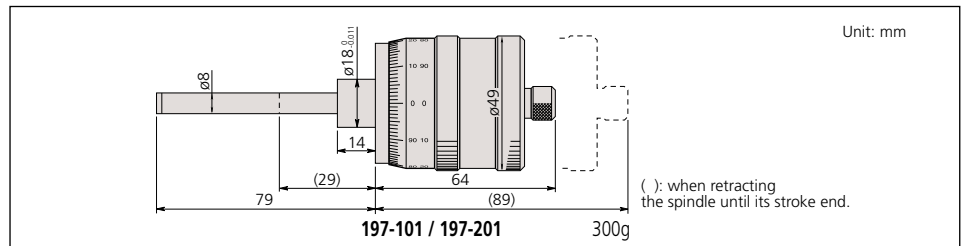

# Micrometer Heads

## SERIES 153 — Fine Graduation and High Accuracy



153-301

### Technical Data

Graduations: 0.0005mm or .00001"  
 Spindle pitch: 0.5mm  
 Spindle face: Flat with carbide tip (more than HRA90), lapped surface  
 Scale surface: White anodized aluminum

### FEATURES

- Fine graduation and high-resolution model.
- Large thimble micrometer head with non-rotating spindle.
- Bidirectional graduation for easy reading in both directions.
- Carbide-tipped measuring face.

### SPECIFICATIONS

Metric						
Range	Order No.	Accuracy*	Stem dia.	Stem	Spindle face	Remarks
0 - 25mm	153-301	±1 / ±0.5µm	18mm	Plain	Flat (carbide tip)	Bidirectional graduation

\*Wide range / narrow range

Inch						
Range	Order No.	Accuracy*	Stem dia.	Stem	Spindle face	Remarks
0 - 1"	153-302	±.00004" / ±.00002"	.709"	Plain	Flat (carbide tip)	Bidirectional graduation

\*Wide range / narrow range

### DIMENSIONS AND MASS

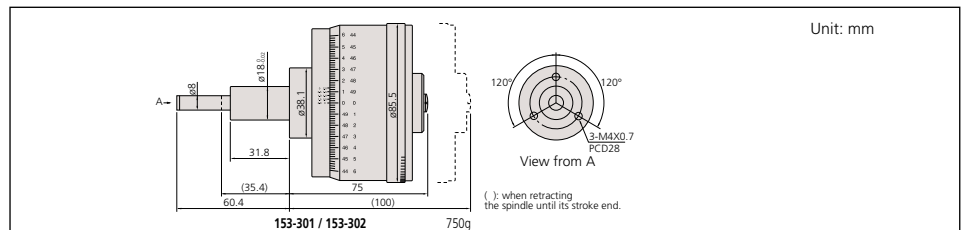

# Micrometer Heads

## SERIES 250 — with Digit Counter

### FEATURES

- Digit counter for easy reading of spindle movement.
- Carbide-tipped measuring face.
- Ratchet stop for constant force.

### SPECIFICATIONS

Metric						
Range	Order No.	Accuracy	Stem dia.	Stem	Spindle face	Remarks
0 - 25mm	<b>250-301</b>	±2µm	10mm	Plain	Flat (carbide tip)	—

Inch						
Range	Order No.	Accuracy	Stem dia.	Stem	Spindle face	Remarks
0 - 1"	<b>250-312</b>	±.0001"	.375"	Plain	Flat (carbide tip)	w / vernier (.0001")

### DIMENSIONS AND MASS

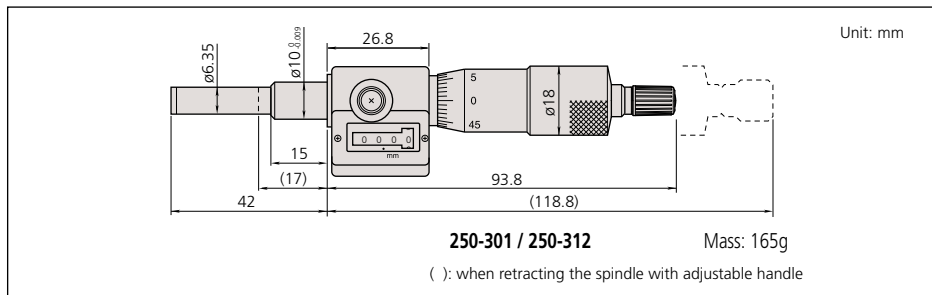

250-301

### Technical Data

Graduations: 0.01mm or .0001"  
 Spindle pitch: 0.5mm  
 Spindle face: Flat with carbide tip (more than HRA90), lapped surface  
 Scale surface: Hard-chrome plating

# Micro Jack

## SERIES 7

### FEATURES

- Used for accurate leveling of machines, surface plates and other precision instruments.
- Easy adjustment under heavy load.



7850

### SPECIFICATIONS

Metric				
Range	Order No.	Graduation	Max. Load	Remarks
60 - 75mm	<b>7850</b>	0.01mm	400kg	adjustable handle

### DIMENSIONS AND MASS

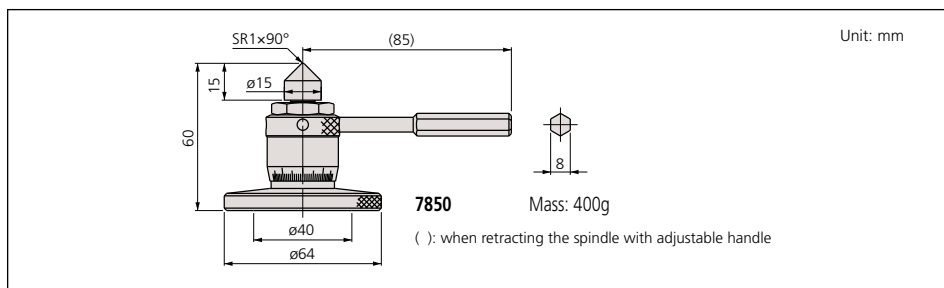

### Technical Data

Graduations: 0.01mm



# Precision Lead Screw

## Technical Data

- Durability: 100,000 cycles are guaranteed (use condition: 4 kg load; 2 kg for AS-6.5 and BS-6.5)
- Main applications
  - Precision feed stages
  - Fine adjustment of optical elements (mirrors, prisms)
  - Fiber optic centering devices
  - Various assembly and adjustment jigs

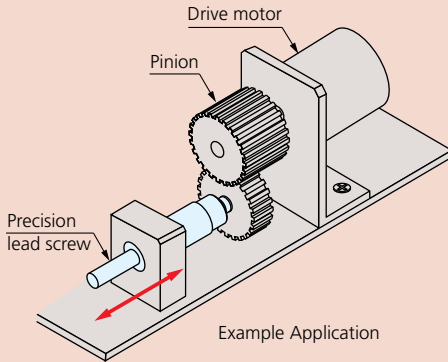

## FEATURES

- Mitutoyo manufactures simple and economical precision lead screws for precise positioning mechanisms and fine-feed mechanisms, in addition to the conventional micrometer heads.
- Mitutoyo also manufactures screws with special specifications, such as 0.25 mm pitch, as well as those with the standard 0.5 mm feed pitch and with dimensions and forms that meet customer's requirements.

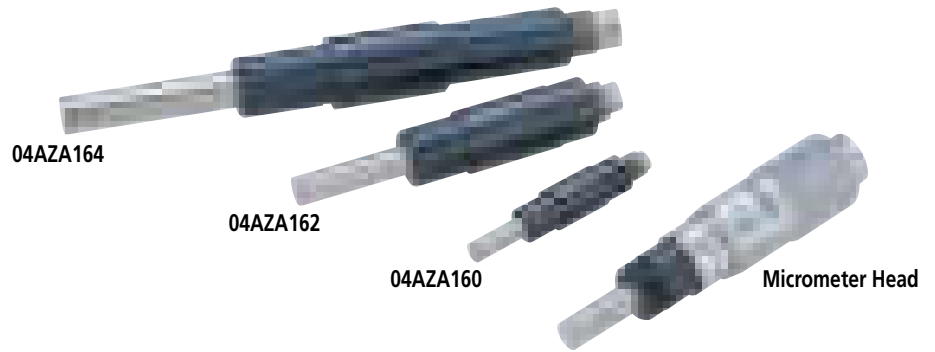

## SPECIFICATIONS

Order No.	Model	Stroke (mm)	Feed pitch (mm)	Feed accuracy (μm)	Stem diameter (mm)	Tip diameter (mm)	Tail diameter (mm)	Screw nominal diameter	Sleeve diameter (mm)	Measuring face	Mass	Others
04AZA160	AS-6.5	6.5	0.5	±5	ø6 <sup>0</sup> <sub>-0.008</sub>	ø3.5	ø3 <sup>0</sup> <sub>-0.01</sub>	M4.5 x 0.5	ø7	Hardened	10g	<ul style="list-style-type: none"> <li>• AS type: Flat spindle tip without nut</li> <li>• BS type: Spherical spindle tip with nut</li> </ul>
04AZA161	BS-6.5										11g	
04AZA162	AS-13	13	±2	ø9.5 <sup>0</sup> <sub>-0.009</sub>	ø5	ø5 <sup>0</sup> <sub>-0.012</sub>	M7.35 x 0.5	ø10.5	Carbide	27g		
04AZA163	BS-13									30g		
04AZA164	AS-25	25	±2	ø10 <sup>0</sup> <sub>-0.009</sub>	ø6.35	ø6 <sup>0</sup> <sub>-0.015</sub>	M7.35 x 0.5	ø12	Carbide	61g		
04AZA165	BS-25									64g		

## DIMENSIONS

Unit: mm

**Type A: Straight type**

**Type B: Stem with nut**

Order No.	L	L1	L2	L3	L4	L5
04AZA160	39	15	14.5	9	6	—
04AZA161	39	15	14.5	7.5	6	3
04AZA162	57.5	25	21.5	15.5	8	—
04AZA163	57.5	25	21.5	15.5	8	4
04AZA164	98.5	42	39.5	27	10	—
04AZA165	98.5	42	39.5	27	10	4

# Fixtures for Micrometer Heads and Linear Gages

## FEATURES

- The act of fabricating brackets to mount micrometer heads for each particular application can be laborious and costly. Mitutoyo offers various types of fixtures for micrometer heads to meet a range of applications. These fixtures are made of nickel-plated cast iron.
- There are two types of fixtures for micrometer heads--with or without clamping nut on the stem.

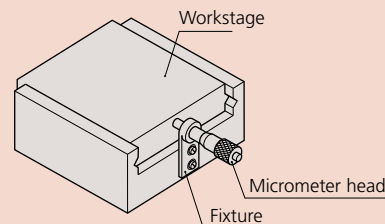

## DIMENSIONS: Fixtures for plain-stem type micrometer heads

Unit: mm

Order No.	303560	303569	303579
A	ø9.5	ø9.5	ø10
B	9	14.5	14.5
C	14.5	19.5	19.5
D	20	30	30
E	23	35	35
F	5	7	7
G	11	16	16
H	8	12	12
I	1.5	3.25	3.25
J	32.5	42.5	42.5
K	4.5	7.25	7.25
L	ø3.4	ø4.5	ø4.5
M	M3x0.5	M3x0.5	M3x0.5

Order No.	303564	303573	303583
A	ø9.5	ø9.5	ø10
B	9	14.5	14.5
C	30	40	40
D	42.5	52.5	52.5
E	4	6	6
F	15	18	18
G	10	15	15
H	15	20	20
I	4.5	7.25	7.25
J	ø3.4	ø4.5	ø4.5
K	M3x0.5	M3x0.5	M3x0.5

**Note:** Supplied with a socket head screw (M3x0.5x12mm) for the fixtures to be used with a micrometer head without clamp nut (plain stem type micrometer head).

Order No.	303562	303571	303581
A	ø9.5	ø9.5	ø10
B	9	14.5	14.5
C	15	15	15
D	20	22.5	22.5
E	40	60	60
F	3	5	5
G	30	40	40
H	15	20	20
I	ø3.4	ø4.5	ø4.5
J	M3x0.5	M3x0.5	M3x0.5

Order No.	303566	303575	303585
A	ø9.5	ø9.5	ø10
B	9	14.5	14.5
C	15	15	15
D	15	20	20
E	25	40	40
F	8.5	8.5	8.5
G	7.5	10	10
H	10	20	20
I	10	15	15
J	32.5	40	40
K	4.5	7.25	7.25
L	ø3.4	ø4.5	ø4.5
M	M3x0.5	M3x0.5	M3x0.5



# Fixtures for Micrometer Heads and Linear Gages



## DIMENSIONS: Fixtures for micrometer heads with clamp nut

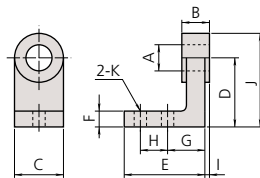

Order No.	303559	303568	303578
A	ø9.5	ø9.5	ø10
B	6	11.5	11.5
C	14.5	19.5	19.5
D	20	30	30
E	24	35	35
F	5	7	7
G	11	16	16
H	8	12	12
I	0.5	1.75	1.75
J	27.5	40	40
K	ø3.4	ø4.5	ø4.5

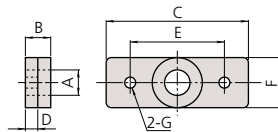

Order No.	303561	303570	303580
A	ø9.5	ø9.5	ø10
B	6	11.5	11.5
C	40	60	60
D	3.5	5.5	5.5
E	30	40	40
F	15	20	20
G	ø3.4	ø4.5	ø4.5

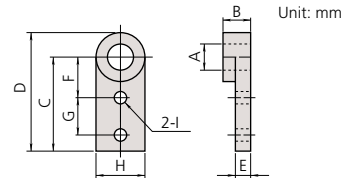

Order No.	303563	303572	303582
A	ø9.5	ø9.5	ø10
B	6	11.5	11.5
C	30	40	40
D	37.5	50	50
E	4.5	6.5	6.5
F	15	18	18
G	10	15	15
H	15	20	20
I	ø3.4	ø4.5	ø4.5

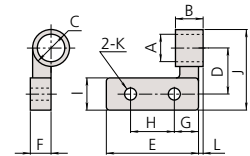

Order No.	303565	303574	303584
A	ø9.5	ø9.5	ø10
B	6	11.5	11.5
C	ø15	ø15	ø15
D	15	20	20
E	25	40	40
F	8.5	8.5	8.5
G	7.5	10	10
H	10	20	20
I	10	15	15
J	27.5	35	35
K	ø3.4	ø4.5	ø4.5
L	0.75	1.25	1.25

# Quick Guide to Precision Measuring Instruments

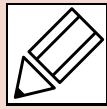

## Micrometer Heads

### Key Factors in Selection

Key factors in selecting a micrometer head are the measuring range, spindle face, stem, graduations, thimble diameter, etc.

#### Stem

Plain stem

Stem locknut type

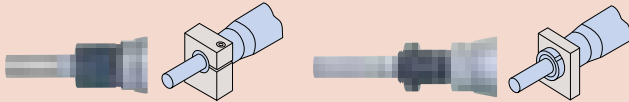

- The stem used to mount a micrometer head is classified as a "plain type" or "clamp nut type" as illustrated above. The stem diameter is manufactured to a nominal Metric or Imperial size with an h6 tolerance.
- The clamp nut stem allows fast and secure clamping of the micrometer head. The plain stem has the advantage of wider application and slight positional adjustment in the axial direction on final installation, although it does require a split-fixture clamping arrangement or adhesive fixing.
- General-purpose mounting fixtures are available as optional accessories.

#### Measuring Face



Flat face



Spherical face



Anti-rotation device

- A flat measuring face is often specified where a micrometer head is used in measurement applications.
- When a micrometer head is used as a feed device, a spherical face can minimize errors due to misalignment (Figure A). Alternatively, a flat face on the spindle can bear against a sphere, such as a carbide ball (Figure B).
- A non-rotating spindle type micrometer head or one fitted with an anti-rotation device on the spindle (Figure C) can be used if a twisting action on the workpiece must be avoided.
- If a micrometer head is used as a stop then a flat face both on the spindle and the face it contacts provides durability.

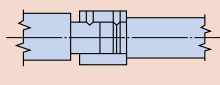
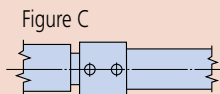
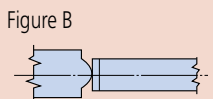
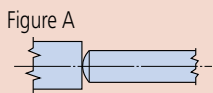

#### Non-Rotating Spindle

- A non-rotating spindle type head does not exert a twisting action on a workpiece, which may be an important factor in some applications.

#### Spindle Thread Pitch

- The standard type head has 0.5mm pitch.
- 1mm-pitch type: quicker to set than standard type and avoids the possibility of a 0.5mm reading error. Excellent load-bearing characteristics due to larger screw thread.
- 0.25mm or 0.1mm-pitch type  
This type is the best for fine-feed or fine-positioning applications.

#### Constant-force Device

- A micrometer head fitted with a constant-force device (ratchet or friction thimble) is recommended for measurement applications.
- If using a micrometer head as a stop, or where saving space is a priority, a head without a ratchet is probably the best choice.

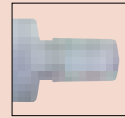

Micrometer head with constant-force device

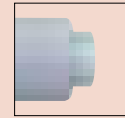

Micrometer head without constant-force device (no ratchet)

#### Spindle Lock

- If a micrometer head is used as a stop it is desirable to use a head fitted with a spindle lock so that the setting will not change even under repeated shock loading.



#### Measuring Range (Stroke)

- When choosing a measuring range for a micrometer head, allow an adequate margin in consideration of the expected measurement stroke. Six stroke ranges, 5 to 50mm, are available for standard micrometer heads.
- Even if an expected stroke is small, such as 2mm to 3mm, it will be cost effective to choose a 25mm-stroke model as long as there is enough space for installation.
- If a long stroke of over 50mm is required, the concurrent use of a gauge block can extend the effective measuring range. (Figure D)

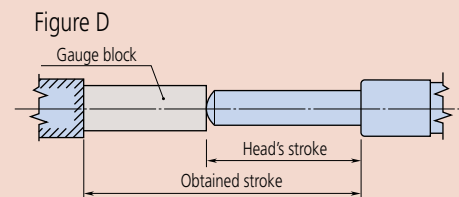

- In this guide, the range (or stroke end) of the thimble is indicated by a dashed line. For stroke ends, consider the thimble as moving to the position indicated by the line when designing the jig.

#### Ultra-fine Feed Applications

- Dedicated micrometer heads are available for manipulator applications, etc., which require ultra-fine feed or adjustment of spindle.

# C

## Small Tool Instruments Inside Measurement



**Holtest ABSOLUTE Borematic**



**Inside Micrometers**

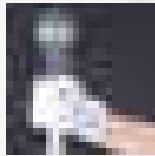

**Bore Gages**

### INDEX

<b>Holtest</b>	
Digimatic Holtest	C-2,3
Holtest	C-4,5
Holtest (Type II)	C-6,7
Borematic	C-8,9
Holtest/Digimatic Holtest/Borematic	C-10
<b>Inside Micrometers</b>	
Tubular Inside Micrometers	C-11-12,15-17
Inside Micrometers	C-13,18
Digimatic Tubular Inside Micrometers	C-14
Inside Micro Checker	C-19
<b>Bore Gages</b>	
Bore Gages	C-20-26,28
<b>ABSOLUTE Digimatic Bore Gage</b>	<b>C-27</b>
Bore Gage Zero Checker	C-29
Setting Rings	C-29,30
Bore Gages	C-28
Bore Gage Zero Checker	C-29
Setting Rings	C-29,30

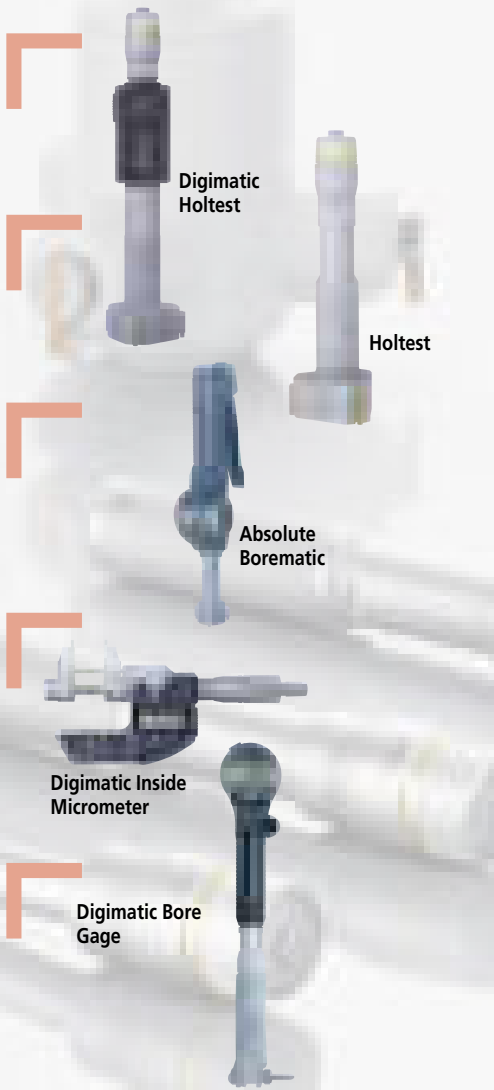

Digimatic Holtest

Holtest

Absolute Borematic

Digimatic Inside Micrometer

Digimatic Bore Gage

# Digimatic Holtest

## SERIES 468 — Three-Point Internal Micrometers

### FEATURES

- TiN-coated measuring contact points provide excellent durability and impact resistance and allow the instrument to measure to the bottom of a blind hole (up to 100mm / 4" models).
- Large LCD readout.
- Functions available: Presetting, Zero/ABS, Auto power On/Off, Data hold, Data output, Error alarm, Battery replacement alarm.
- With Ratchet Stop for constant force.
- Measure deep holes by attaching an extension rod (optional).
- Setting rings for origin point setting are optional.
- Supplied in fitted plastic case up to 100mm / 4". Over 100mm / 4" supplied in wooden case.



### Technical Data

Accuracy: Refer to the list of specifications.  
 Resolution: 0.001mm or .00005"/0.001mm (over 4 - 5" models: .0001"/0.001mm)  
 Contact point: TiN coating  
 Measuring method: Three-point method  
 Display: LCD  
 Battery: SR44 (2 pcs.), **938882**  
 Battery life: Approx. 1.2 years under normal use

### Function

Zero/ABS, Auto Power On/Off, Data hold, Data output, Preset, inch/mm conversion (on inch/metric models only)  
 Alarm: Low voltage, Counting value composition error

### Optional Accessories

- 05CZA662:** SPC cable (1m / 40")
- 05CZA663:** SPC cable (2m / 80")
- 04AZB157:** Mounting plate for stand
- 156-101-10:** Stand
- 952322:** Extension rod 100mm / 3.94"  
For range 6-12mm / .275 - .5" models
- 952621:** Extension rod 150mm / 5.9"  
For range 12-20mm / .5" - .8" models
- 952622:** Extension rod 150mm / 5.9"  
For range 20-50mm / .8" - 2" models
- 952623:** Extension rod 150mm / 5.9"  
For range 50-300mm / 2" - 12" models



468-261



468-263



468-274

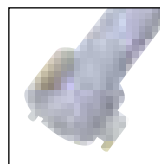

TiN-coated contact points (" -10" suffix models only)

### DIMENSIONS AND MASS

Unit: mm

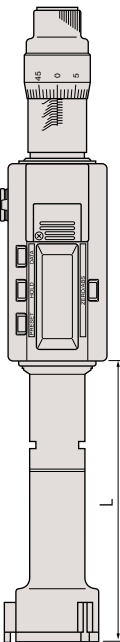

Range	L	Mass (g)
6 - 8mm / .275 - .35"	59	400
8 - 10mm / .35 - .425"	59	400
10 - 12mm / .425 - .5"	59	400
12 - 16mm / .5 - .65"	84	430
16 - 20mm / .65 - .8"	84	430
20 - 25mm / .8 - 1"	93	500
25 - 30mm / 1 - 1.2"	93	510
30 - 40mm / 1.2 - 1.6"	103.8	510
40 - 50mm / 1.6 - 2"	103.8	530
50 - 63mm / 2 - 2.5"	105.4	650
62 - 75mm / 2.5 - 3.0"	105.4	660
75 - 88mm / 3.0 - 3.5"	105.4	990
87 - 100mm / 3.5 - 4.0"	105.4	1000
100 - 125mm / 4 - 5"	151.4	970
125 - 150mm / 5 - 6"	151.4	1060
150 - 175mm / 6 - 7"	151.4	1150
175 - 200mm / 7 - 8"	151.4	1240
200 - 225mm / 8 - 9"	151.4	1330
225 - 250mm / 9 - 10"	151.4	1420
250 - 275mm / 10 - 11"	151.4	1510
275 - 300mm / 11 - 12"	151.4	1600

#### Measuring a Blind Hole

The measuring contact points held in the jaws permit measuring the diameter of a blind hole to the bottom.  
 ( up to 100mm / 4" models)

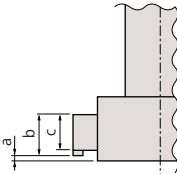

Range	a	b	c
6 - 12mm / .275 - .5"	2	—	2.5
12 - 20mm / .5 - .8"	0.3	5.6	3.5
20 - 30mm / .8 - 1.2"	0.3	8.3	5.2
30 - 50mm / 1.2 - 2"	0.3	13	10
50 - 100mm / 2 - 4"	0.3	17	14
100 - 300mm / 4 - 12"	12.4	21	13.8



04AZB157

## SPECIFICATIONS

Metric				Inch/Metric			
			<input type="checkbox"/> with TiN-coated contact points				<input type="checkbox"/> with TiN-coated contact points
Range	Accuracy	Order Code		Range	Accuracy	Order Code	
		Individual	Main Body Assembly			Individual	Main Body Assembly
6-8	±2μm	<b>468-161</b>	04AZB106	.275-.35" / 6.925-8.89mm	±.0001"	<b>468-261</b>	04AZB111
8-10		<b>468-162</b>		.35-.425" / 8.89-10.795mm		<b>468-262</b>	
10-12		<b>468-163</b>		.425-.5" / 10.795-12.7mm		<b>468-263</b>	
12-16		<b>468-164</b>		.5-.65" / 12.7-16.51mm		<b>468-264</b>	
16-20		<b>468-165</b>		.65-.8" / 16.51-20.32mm		<b>468-265</b>	
20-25	±3μm	<b>468-166</b>	04AZB107	.8-1" / 20.32-25.4mm	±.00015"	<b>468-266</b>	04AZB112
25-30		<b>468-167</b>		1-1.2" / 25.4-30.48mm		<b>468-267</b>	
30-40		<b>468-168</b>		1.2-1.6" / 30.48-40.64mm		<b>468-268</b>	
40-50		<b>468-169</b>		1.6-2" / 40.64-50.8mm		<b>468-269</b>	
50-63		<b>468-170</b>		2-2.5" / 50.8-63.5mm		<b>468-270</b>	
62-75	±5μm	<b>468-171</b>	04AZB108	2.5-3" / 63.5-76.2mm	±.00025"	<b>468-271</b>	04AZB113
75-88		<b>468-172</b>		3-3.5" / 76.2-88.9mm		<b>468-272</b>	
87-100		<b>468-173</b>		3.5-4" / 88.9-101.6mm		<b>468-273</b>	
100-125		<b>468-174</b>		4-5" / 101.6-127mm		<b>468-274</b>	
125-150		<b>468-175</b>		5-6" / 127-152.4mm		<b>468-275</b>	
150-175	±5μm	<b>468-176</b>	04AZB109	6-7" / 152.4-177.8mm	±.00025"	<b>468-276</b>	04AZB114
175-200		<b>468-177</b>		7-8" / 177.8-203.2mm		<b>468-277</b>	
200-225		<b>468-178</b>		8-9" / 203.2-228.6mm		<b>468-278</b>	
225-250		<b>468-179</b>		9-10" / 228.6-254mm		<b>468-279</b>	
250-275		<b>468-180</b>		10-11" / 254-279.4mm		<b>468-280</b>	
275-300	<b>468-181</b>	11-12" / 279.4-304.8mm	<b>468-281</b>				

### Complete Unit Set

Each set includes complete gages (display units and measuring heads for each size).

Metric				
				<input type="checkbox"/> with TiN-coated contact points
Range	Order No.	Individual range	Setting rings included	Remarks
6 - 12mm	<b>468-981</b>	6-8, 8-10, 10-12mm	ø8mm, ø10mm	—
12 - 25mm	<b>468-982</b>	12-16, 16-20, 20-25mm	ø16mm, ø20mm	—
25 - 50mm	<b>468-983</b>	25-30, 30-40, 40-50mm	ø30mm, ø40mm	—
50 - 75mm	<b>468-984</b>	50-63, 62-75mm	ø62mm	—
75 - 100mm	<b>468-985</b>	75-88, 87-100mm	ø87mm	—

Inch/Metric				
				<input type="checkbox"/> with TiN-coated contact points
Range	Order No.	Individual range	Setting rings included	Remarks
.275 - .5" / 6.925 - 12.7mm	<b>468-986</b>	.275-.35", .35-.425", .425-.5"	.35" DIA., .425" DIA.	—
.5 - 1" / 12.7 - 25.4mm	<b>468-987</b>	.5-.65", .65-.8", .8-1"	.65" DIA., .8" DIA.	—
1 - 2" / 25.4 - 50.8mm	<b>468-988</b>	1-1.2", 1.2-1.6", 1.6-2"	1.2" DIA., 1.6" DIA.	—
2 - 3" / 50.8 - 76.2mm	<b>468-989</b>	2-2.5", 2.5-3"	2.5" DIA.	—
3 - 4" / 76.2 - 101.6mm	<b>468-990</b>	3-3.5", 3.5-4"	3.5" DIA.	—

### Interchangeable Head Set

Each set includes one display unit with interchangeable measuring heads of the sizes specified.

Metric				
				<input type="checkbox"/> with TiN-coated contact points
Range	Order No.	Individual range	Setting rings included	Remarks
6 - 12mm	<b>468-971</b>	6-8, 8-10, 10-12mm	ø8mm, ø10mm	with extension rod
12 - 20mm	<b>468-972</b>	12-16, 16-20mm	ø16mm.	with extension rod
20 - 50mm	<b>468-973</b>	20-25, 25-30, 30-40, 40-50mm	ø25mm, ø40mm	with extension rod
50 - 100mm	<b>468-974</b>	50-63, 62-75, 75-88, 87-100mm	ø62mm, ø87mm	with extension rod
100 - 200mm	<b>468-975</b>	100-125, 125-150, 150-175, 175-200mm	ø125mm, ø175mm	with extension rod

Inch/Metric				
				<input type="checkbox"/> with TiN-coated contact points
Range	Order No.	Individual range	Setting rings included	Remarks
.275 - .5" / 6.925 - 12.7mm	<b>468-976</b>	.275-.35", .35-.425", .425-.5"	.35" DIA., .425" DIA.	with extension rod
.5 - .8" / 12.7 - 20.32mm	<b>468-977</b>	.5-.65", .65-.8"	.65" DIA.	with extension rod
.8 - 2" / 20.32 - 50.8mm	<b>468-978</b>	.8-1", 1-1.2", 1.2-1.6", 1.6-2"	1" DIA., 1.6" DIA.	with extension rod
2 - 4" / 50.8 - 101.6mm	<b>468-979</b>	2-2.5", 2.5-3", 3-3.5", 3.5-4"	2.5" DIA., 3.5" DIA.	with extension rod
4 - 8" / 101.6 - 203.2mm	<b>468-980</b>	4-5", 5-6", 6-7", 7-8"	5" DIA., 7" DIA.	with extension rod

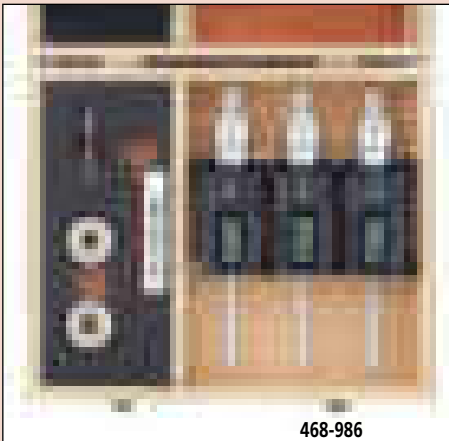

468-986



468-978

# Holtest

## SERIES 368 — Three-Point/Two-Point Internal Micrometers

These Holtests are versatile, self-centering three-point internal micrometers for the accurate and efficient direct-measurement of internal diameters. Three anvils, evenly spaced at 120° apart, contact the internal wall surfaces and find true alignment with the axis of the bore for accurate ID measurement.



### FEATURES

- TiN-coated measuring contact points (over 6mm / .275" range models) provide excellent durability and impact resistance and allow the instrument to measure to the bottom of a blind hole (up to 100mm / 4" models).
- Highly durable because of carbide-tipped contact points (anvils up to 12mm / .5" models).
- Measure deep holes using an extension rod (optional) which is available on models over 6mm (.275") measuring range.
- With Ratchet Stop for constant force.
- Setting rings for zero point adjustment are optional.
- Supplied in fitted plastic case up to 100mm / 4". Over 100mm / 4" supplied in wooden case.

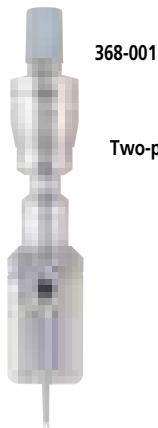

Two-point contact type

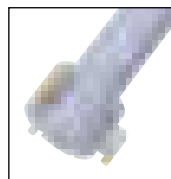

TiN-coated contact points (excluding models up to 12mm/.5")

### DIMENSIONS

#### Measuring a Blind Hole

The measuring contact points held in the jaws permit measuring the diameter of a blind hole right down to the bottom (up to 100mm / 4" models).

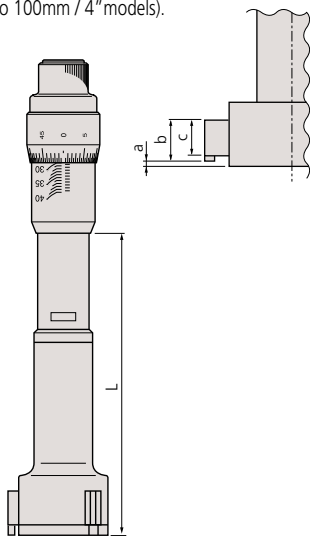

Range	L	Mass (g)	Range	L	Mass (g)
2 - 2.5mm / .08 - .1"	12	88	40 - 50mm / 1.6 - 2"	102	330
2.5 - 3mm / .1 - .12"	12	88	50 - 63mm / 2 - 2.5"	105	440
3 - 4mm / .12 - .16"	22	91	62 - 75mm / 2.5 - 3"	105	450
4 - 5mm / .16 - .2"	22	91	75 - 88mm / 3 - 3.5"	105	490
5 - 6mm / .2 - .24"	22	91	87 - 100mm / 3.5 - 4"	105	500
6 - 8mm / .275 - .35"	59	57	100 - 125mm / 4 - 5"	161	1050
8 - 10mm / .35 - .425"	59	58	125 - 150mm / 5 - 6"	161	1120
10 - 12mm / .425 - .5"	59	59	150 - 175mm / 6 - 7"	161	1190
12 - 16mm / .5 - .65"	82	140	175 - 200mm / 7 - 8"	161	1260
16 - 20mm / .65 - .8"	82	145	200 - 225mm / 8 - 9"	161	1420
20 - 25mm / .8 - 1"	94	250	225 - 250mm / 9 - 10"	161	1580
25 - 30mm / 1 - 1.2"	94	270	250 - 275mm / 10 - 11"	161	1600
30 - 40mm / 1.2 - 1.6"	102	290	275 - 300mm / 11 - 12"	161	1690

Range	a	b	c
2 - 6mm / .08 - .275"	—	—	2
6 - 12mm / .275 - .5"	2	—	2.5
12 - 20mm / .5 - .8"	0.3	5.6	3.5
20 - 30mm / .8 - 1.2"	0.3	8.3	5.2
30 - 50mm / 1.2 - 2"	0.3	13	10
50 - 100mm / 2 - 4"	0.3	17	14
100 - 300mm / 4 - 12"	12.4	21	13.8



### Technical Data

Graduation: 0.001mm, 0.005mm\*, .0001" or .0002"\*  
(\*over 12mm or .5" models)

Range	Measuring method	Contact-point material
2-6mm/.08-.28"	Two-point method	Carbide
6-300mm/.275-12"	Three-point method	TiN coating (1700-2000HV)

### Optional Accessories

- 952322:** Extension rod 100mm / 3.94"  
For range 6-12mm / .275-.5" models
- 952621:** Extension rod 150mm / 5.9"  
For range 12-20mm / .5" - .8" models
- 952622:** Extension rod 150mm / 5.9"  
For range 20-50mm / .8" - 2" models
- 952623:** Extension rod 150mm / 5.9"  
For range 50-300mm / 2"-12" models

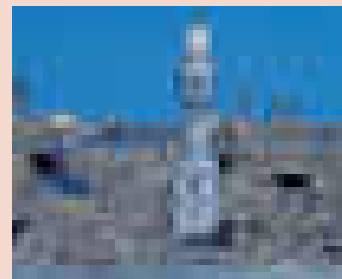
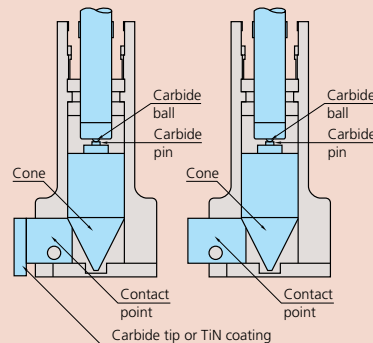

Using the optional extension rod



## SPECIFICATIONS

**Metric**  Individual  with TiN-coated contact points

Range	Order No.	Accuracy
2 - 2.5mm	<b>368-001</b>	±2μm
2.5 - 3mm	<b>368-002</b>	±2μm
3 - 4mm	<b>368-003</b>	±2μm
4 - 5mm	<b>368-004</b>	±2μm
5 - 6mm	<b>368-005</b>	±2μm
6 - 8mm	<b>368-161</b>	±2μm
8 - 10mm	<b>368-162</b>	±2μm
10 - 12mm	<b>368-163</b>	±2μm
12 - 16mm	<b>368-164</b>	±2μm
16 - 20mm	<b>368-165</b>	±2μm
20 - 25mm	<b>368-166</b>	±3μm
25 - 30mm	<b>368-167</b>	±3μm
30 - 40mm	<b>368-168</b>	±3μm
40 - 50mm	<b>368-169</b>	±3μm
50 - 63mm	<b>368-170</b>	±3μm
62 - 75mm	<b>368-171</b>	±3μm
75 - 88mm	<b>368-172</b>	±3μm
87 - 100mm	<b>368-173</b>	±3μm
100 - 125mm	<b>368-174</b>	±5μm
125 - 150mm	<b>368-175</b>	±5μm
150 - 175mm	<b>368-176</b>	±5μm
175 - 200mm	<b>368-177</b>	±5μm
200 - 225mm	<b>368-178</b>	±5μm
225 - 250mm	<b>368-179</b>	±5μm
250 - 275mm	<b>368-180</b>	±5μm
275 - 300mm	<b>368-181</b>	±5μm

**Inch**  Individual  with TiN-coated contact points

Range	Order No.	Accuracy
.08 - .1"	<b>368-021</b>	±.0001"
.1 - .12"	<b>368-022</b>	±.0001"
.12 - .16"	<b>368-023</b>	±.0001"
.16 - .2"	<b>368-024</b>	±.0001"
.2 - .24"	<b>368-025</b>	±.0001"
.24 - .28"	<b>368-026</b>	±.0001"
.275 - .35"	<b>368-261</b>	±.0001"
.35 - .425"	<b>368-262</b>	±.0001"
.425 - .5"	<b>368-263</b>	±.0001"
.5 - .65"	<b>368-264</b>	±.0001"
.65 - .8"	<b>368-265</b>	±.0001"
.8 - 1"	<b>368-266</b>	±.00015"
1 - 1.2"	<b>368-267</b>	±.00015"
1.2 - 1.6"	<b>368-268</b>	±.00015"
1.6 - 2"	<b>368-269</b>	±.00015"
2 - 2.5"	<b>368-270</b>	±.00015"
2.5 - 3"	<b>368-271</b>	±.00015"
3 - 3.5"	<b>368-272</b>	±.00015"
3.5 - 4"	<b>368-273</b>	±.00015"
4 - 5"	<b>368-274</b>	±.00025"
5 - 6"	<b>368-275</b>	±.00025"
6 - 7"	<b>368-276</b>	±.00025"
7 - 8"	<b>368-277</b>	±.00025"
8 - 9"	<b>368-278</b>	±.00025"
9 - 10"	<b>368-279</b>	±.00025"
10 - 11"	<b>368-280</b>	±.00025"
11 - 12"	<b>368-281</b>	±.00025"

### Complete Unit Set

Each set includes complete gages (micrometer head units and measuring heads for each size).

**Metric**  with TiN-coated contact points

Range	Order No.	Individual range	Setting rings included	Remarks
2 - 3mm	<b>368-906</b>	2-2.5, 2.5-3mm	ø2.5mm	—
3 - 6mm	<b>368-907</b>	3-4, 4-5, 5-6mm	ø4mm, ø5mm	—
6 - 12mm	<b>368-911</b>	6-8, 8-10, 10-12mm	ø8mm, ø10mm	with extension rod
12 - 20mm	<b>368-912</b>	12-16, 16-20mm	ø16mm	with extension rod
20 - 50mm	<b>368-913</b>	20-25, 25-30, 30-40, 40-50mm	ø25mm, ø40mm	with extension rod
50 - 100mm	<b>368-914</b>	50-63, 62-75, 75-88, 87-100mm	ø62mm, ø87mm	with extension rod
100 - 200mm	<b>368-915</b>	100-125, 125-150, 150-175, 175-200mm	ø125mm, ø175mm	with extension rod

**Inch**  with TiN-coated contact points

Range	Order No.	Individual range	Setting rings included	Remarks
.08" - .12"	<b>368-926</b>	.08-.1", .1-.12"	.1" DIA.	—
.12" - .28"	<b>368-927</b>	.12-.16", .16-.2", .2-.24", .24-.28"	.16" DIA., .24" DIA.	—
.275" - .5"	<b>368-916</b>	.275-.35", .35-.425", .425-.5"	.35" DIA., .5" DIA.	with extension rod
.5" - .8"	<b>368-917</b>	.5-.65", .65-.8"	.65" DIA.	with extension rod
.8" - 2"	<b>368-918</b>	.8-1", 1-1.2", 1.2-1.6", 1.6-2"	1" DIA., 1.6" DIA.	with extension rod
2" - 4"	<b>368-919</b>	2-2.5", 2.5-3", 3-3.5", 3.5-4"	2.5" DIA., 3.5" DIA.	with extension rod
4" - 8"	<b>368-920</b>	4-5", 5-6", 6-7", 7-8"	5" DIA., 7" DIA.	with extension rod

\*.0001" graduation

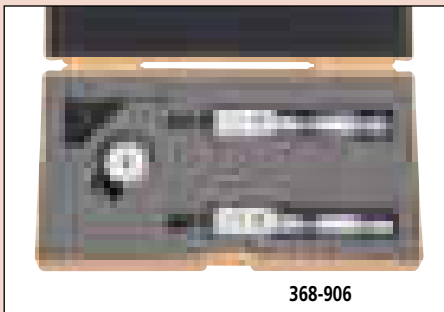

368-906

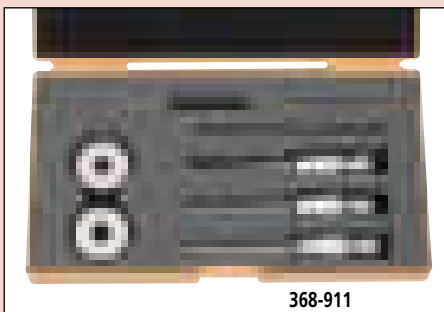

368-911

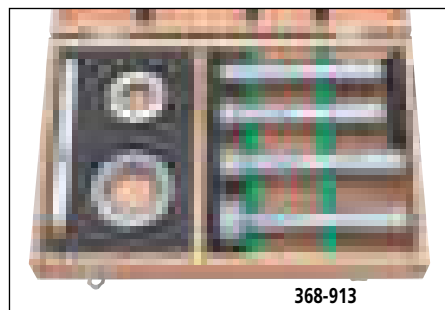

368-913



368-915

# Holtest (Type II)

## SERIES 368 — Three-Point Internal Micrometers

### FEATURES

- The Holtests (type II) have three contact points made of alloy steel.
- Measurement can be taken closer to the bottom of the blind bore (up to 100mm / 4" models).
- Measure deep holes using an extension rod (optional).
- With Ratchet Stop for constant force.
- Setting rings for origin point settings are optional.
- Supplied in fitted plastic case up to 100mm / 4". Over 100mm / 4" supplied in wooden case.

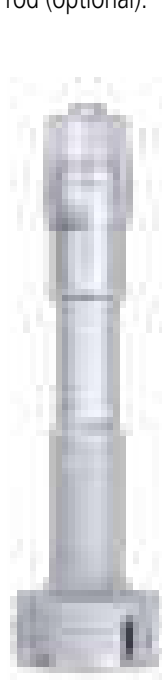

368-869



368-770



368-774

### DIMENSIONS AND MASS

Range	L	Mass (g)
12 - 16mm / .5 - .65"	82	150
16 - 20mm / .65 - .8"	82	150
20 - 25mm / .8 - 1"	94	260
25 - 30mm / 1 - 1.2"	94	280
30 - 40mm / 1.2 - 1.6"	102	290
40 - 50mm / 1.6 - 2"	102	330
50 - 63mm / 2 - 2.5"	105	440
62 - 75mm / 2.5 - 3"	105	450
75 - 88mm / 3 - 3.5"	105	560
87 - 100mm / 3.5 - 4"	105	570
100 - 125mm / 4 - 5"	161	1020
125 - 150mm / 5 - 6"	161	1110
150 - 175mm / 6 - 7"	161	1200
175 - 200mm / 7 - 8"	161	1300
200 - 225mm / 8 - 9"	161	1420
225 - 250mm / 9 - 10"	161	1540
250 - 275mm / 10 - 11"	161	1690
275 - 300mm / 11 - 12"	161	1860

Unit: mm

#### Measuring a Blind Hole

The measuring contact points held in the jaws permit measuring the diameter of a blind hole right down to the bottom (up to 100mm / 4" models).

Range	a	b
12 - 20mm / .5 - .8"	2.6	3.5
20 - 30mm / .8 - .12"	3.4	5.2
30 - 50mm / 1.2 - 2"	3.4	10
50 - 100mm / 2 - 4"	3.4	14
100 - 300mm / 4 - 12"	19.6	13.8



### Technical Data

Graduation: 0.005mm or .0002"  
 Measuring method: Three-point method  
 Contact point: Hardened steel (over HRC 60)

### Optional Accessories

- 952621:** Extension rod 150mm / 5.9"  
For range 12-20mm / .5 - .8" models
- 952622:** Extension rod 150mm / 5.9"  
For range 20-50mm / .8 - 2" models
- 952623:** Extension rod 150mm / 5.9"  
For range 50-300mm / 2 - 12" models



## SPECIFICATIONS

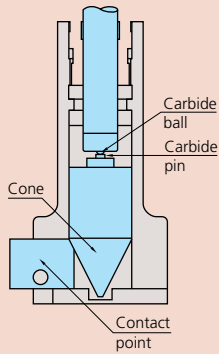

### HT (Type II)

Head Assy Order No.	Measuring Range	HT (type II) Order No.
04AZA839	12 - 16mm	368-764
04AZA840	16 - 20mm	368-765
04AZA848	20 - 25mm	368-766
04AZA849	25 - 30mm	368-767
04AZA857	30 - 40mm	368-768
04AZA858	40 - 50mm	368-769
04AZA870	50 - 63mm	368-770
04AZA871	62 - 75mm	368-771
04AZA872	75 - 88mm	368-772
04AZA873	87 - 100mm	368-773
04AZA895	100 - 125mm	368-774
04AZA896	125 - 150mm	368-775
04AZA897	150 - 175mm	368-776
04AZA898	175 - 200mm	368-777
04AZA899	200 - 225mm	368-778
04AZA900	225 - 250mm	368-779
04AZA901	250 - 275mm	368-780
04AZA902	275 - 300mm	368-781
04AZA841	.5 - .65"	368-864
04AZA842	.65 - .8"	368-865
04AZA850	.8 - 1"	368-866
04AZA851	1 - 1.2"	368-867
04AZA859	1.2 - 1.6"	368-868
04AZA860	1.6 - 2"	368-869
04AZA874	2 - 2.5"	368-870
04AZA875	2.5 - 3"	368-871
04AZA876	3 - 3.5"	368-872
04AZA877	3.5 - 4"	368-873
04AZA903	4 - 5"	368-874
04AZA904	5 - 6"	368-875
04AZA905	6 - 7"	368-876
04AZA906	7 - 8"	368-877
04AZA907	8 - 9"	368-878
04AZA908	9 - 10"	368-879
04AZA909	10 - 11"	368-880
04AZA910	11 - 12"	368-881

Metric Individual		
Range	Order No.	Accuracy
12 - 16mm	368-764	±2µm
16 - 20mm	368-765	±2µm
20 - 25mm	368-766	±3µm
25 - 30mm	368-767	±3µm
30 - 40mm	368-768	±3µm
40 - 50mm	368-769	±3µm
50 - 63mm	368-770	±3µm
62 - 75mm	368-771	±3µm
75 - 88mm	368-772	±3µm
87 - 100mm	368-773	±3µm
100 - 125mm	368-774	±5µm
125 - 150mm	368-775	±5µm
150 - 175mm	368-776	±5µm
175 - 200mm	368-777	±5µm
200 - 225mm	368-778	±5µm
225 - 250mm	368-779	±5µm
250 - 275mm	368-780	±5µm
275 - 300mm	368-781	±5µm

Inch Individual		
Range	Order No.	Accuracy
.5 - .65"	368-864	±.0001"
.65 - .8"	368-865	±.0001"
.8 - 1"	368-866	±.00015"
1 - 1.2"	368-867	±.00015"
1.2 - 1.6"	368-868	±.00015"
1.6 - 2"	368-869	±.00015"
2 - 2.5"	368-870	±.00015"
2.5 - 3"	368-871	±.00015"
3 - 3.5"	368-872	±.00015"
3.5 - 4"	368-873	±.00015"
4 - 5"	368-874	±.00025"
5 - 6"	368-875	±.00025"
6 - 7"	368-876	±.00025"
7 - 8"	368-877	±.00025"
8 - 9"	368-878	±.00025"
9 - 10"	368-879	±.00025"
10 - 11"	368-880	±.00025"
11 - 12"	368-881	±.00025"

### Complete Unit Set

Each set includes complete gages (micrometer head units and measuring heads for each size).

Metric				
Range	Order No.	Individual range	Setting rings included	Remarks
12 - 20mm	368-991	12-16, 16-20mm	ø16mm	with extension rod
20 - 50mm	368-992	20-25, 25-30, 30-40, 40-50mm	ø25mm, ø40mm	with extension rod
50 - 100mm	368-993	50-63, 62-75, 75-88, 87-100mm	ø62mm, ø87mm	with extension rod
100 - 200mm	368-994	100-125, 125-150, 150-175, 175-200mm	ø125mm, ø175mm	with extension rod

Inch				
Range	Order No.	Individual range	Setting rings included	Remarks
.5" - .8"	368-995	.5-.65", .65-.8"	.65" DIA.	with extension rod
.8" - 2"	368-996	.8-1", 1-1.2", 1.2-1.6", 1.6-2"	1" DIA., 1.6" DIA.	with extension rod
2" - 4"	368-997	2-2.5", 2.5-3", 3-3.5", 3.5-4"	2.5" DIA., 3.5" DIA.	with extension rod
4" - 8"	368-998	4-5", 5-6", 6-7", 7-8"	5" DIA., 7" DIA.	with extension rod

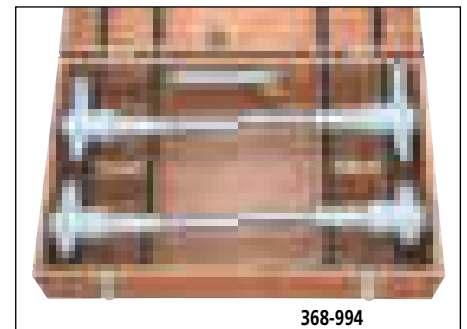
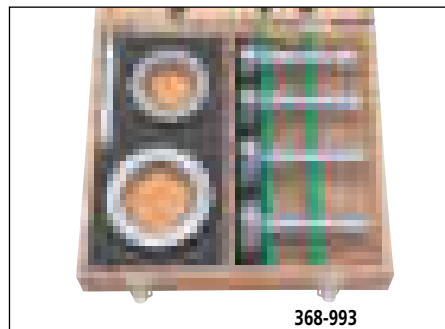
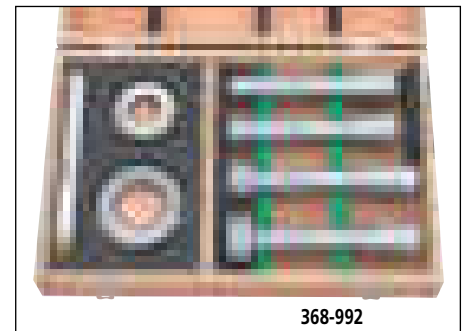
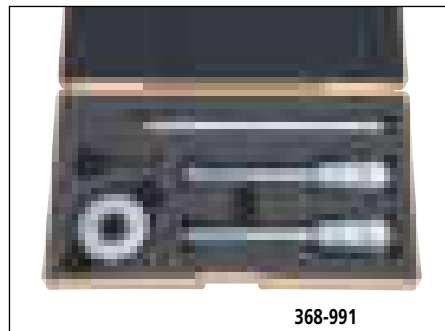

# Borematic

## SERIES 568 — ABSOLUTE Digimatic Snap Bore Gages

The Borematic enables the operator to take measurements more accurately and quicker than ever before. Once the origin point is set with the ORIGIN button, the Borematic retains the setting for the entire battery life, therefore, no longer repeated origin setting (presetting) is necessary.

### FEATURES

- TiN-coated measuring contact points provide excellent durability and impact resistance and allow the instrument to measure to the bottom of a blind hole.
- Large LCD digits of 8.5mm height for easy reading.
- 330-degree rotatable display unit for easy reading at any angle.
- Go/no-go judgment function.
- The ABSOLUTE linear encoder eliminates over-speed errors.
- With SPC data output.
- Setting rings for origin point setting are optional.
- Measure deep holes by attaching an optional extension rod.
- Measurement can be taken closer to the bottom of a blind bore.
- Supplied in fitted wooden case.

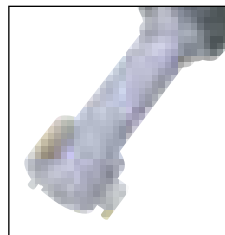

TiN-coated contact points (" -10" suffix models only)

### SPECIFICATIONS

Metric	Individual		
Range	Order No.	Accuracy	Mass (g)
6 - 8mm	<b>568-361</b>	±5µm	480
8 - 10mm	<b>568-362</b>	±5µm	485
10 - 12mm	<b>568-363</b>	±5µm	485
12 - 16mm	<b>568-364</b>	±5µm	475
16 - 20mm	<b>568-365</b>	±5µm	480
20 - 25mm	<b>568-366</b>	±6µm	540
25 - 30mm	<b>568-367</b>	±6µm	555
30 - 40mm	<b>568-368</b>	±6µm	565
40 - 50mm	<b>568-369</b>	±6µm	610
50 - 63mm	<b>568-370</b>	±6µm	730
62 - 75mm	<b>568-371</b>	±6µm	740
75 - 88mm	<b>568-372</b>	±6µm	790
87 - 100mm	<b>568-373</b>	±6µm	800
100 - 113mm	<b>568-374</b>	±6µm	900
112 - 125mm	<b>568-375</b>	±6µm	910

Inch/Metric			
Range	Order No.	Accuracy	Mass (g)
.275 - .350" / 6.985 - 8.89mm	<b>568-461</b>	±.00025"	480
.350 - .425" / 8.89 - 10.795mm	<b>568-462</b>	±.00025"	485
.425 - .5" / 10.795 - 12.7mm	<b>568-463</b>	±.00025"	485
.50 - .65" / 12.7 - 16.51mm	<b>568-464</b>	±.00025"	475
.65 - .80" / 16.51 - 20.32mm	<b>568-465</b>	±.00025"	480
.8 - 1.0" / 20.32 - 25.4mm	<b>568-466</b>	±.0003"	540
1.0 - 1.2" / 25.4 - 30.48mm	<b>568-467</b>	±.0003"	555
1.2 - 1.6" / 30.48 - 40.64mm	<b>568-468</b>	±.0003"	565
1.6 - 2.0" / 40.64 - 50.8mm	<b>568-469</b>	±.0003"	610
2.0 - 2.5" / 50.8 - 63.5mm	<b>568-470</b>	±.0003"	730
2.5 - 3.0" / 63.5 - 76.2mm	<b>568-471</b>	±.0003"	740
3.0 - 3.5" / 76.2 - 88.9mm	<b>568-472</b>	±.0003"	790
3.5 - 4.0" / 88.9 - 101.6mm	<b>568-473</b>	±.0003"	800
4.0 - 4.5" / 101.6 - 114.3mm	<b>568-474</b>	±.0003"	900
4.5 - 5.0" / 114.3 - 127mm	<b>568-475</b>	±.0003"	910



### Technical Data

Accuracy: Refer to the list of specifications.

Resolution: 0.001mm or .00005"/0.001mm

Contact point: Carbide or TiN coating\*  
(\*over 12mm/.5" models)

Measuring method: Three-point method

Display: LCD

Battery: SR44 (1 pc.) (938882)

Battery life: Approx. 7,000 hours

### Functions

Zero/ABS, presetting, go/no-go judgment, power on/off, inch/mm conversion (on inch/metric models only), SPC data output, data hold

### Optional Accessories

**905338:** SPC cable (1m / 40")

**905409:** SPC cable (2m / 80")

**952322:** Extension rod 100mm / 3.94"  
For range 6-12mm / .275-.5" models

**952621:** Extension rod 150mm / 5.9"  
For range 12-20mm / .5" - .8" models

**952622:** Extension rod 150mm / 5.9"  
For range 20-50mm / .8" - 2" models

**952623:** Extension rod 150mm / 5.9"  
For range 50-300mm / 2" - 12" models

---- : Setting ring (See page C-29.)

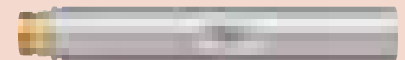

## Complete Unit Set

Each set includes complete gage display units and measuring heads for each size and extension rod.

### Metric

Range	Set Order No.	Individual Order No.	Setting rings included
6 - 12mm	568-955	568-361, 568-362 568-363	177-125 (ø8mm) 177-126 (ø10mm)
12 - 25mm	568-956	568-364, 568-365 568-366	177-177 (ø16mm) 177-286 (ø20mm)
25 - 50mm	568-957	568-367, 568-368 568-369	177-139 (ø25mm) 177-290 (ø40mm)
50 - 75mm	568-958	568-370 568-371	177-314 (ø62mm)
75 - 100mm	568-959	568-372 568-373	177-318 (ø87mm)

### Inch/Metric

Range	Set Order No.	Individual Order No.	Setting rings included
.275" - .5" / 6.985 - 12.7mm	568-965	568-461, 568-462 568-463	177-179 (.35" DIA.) 177-283 (.425" DIA.)
.5" - 1" / 12.7 - 25.4mm	568-966	568-464, 568-465 568-466	177-182 (.65" DIA.) 177-287 (.8" DIA.)
1" - 2" / 25.4 - 50.8mm	568-967	568-467, 568-468 568-469	177-289 (1.2" DIA.) 177-291 (1.6" DIA.)
2" - 3" / 50.8 - 76.2mm	568-968	568-470 568-471	177-315 (2.5" DIA.)
3" - 4" / 76.2 - 101.6mm	568-969	568-472 568-473	177-319 (3.5" DIA.)

## Interchangeable Head Set

Each set includes one display unit with interchangeable measuring heads of the sizes specified and extension rod.

### Metric

Range	Set Order No.	Display Unit	Adaptor Supplied	Individual Head No.	Setting rings included
6 - 12mm	568-924	568-014	954595	04AZB136 04AZB137 04AZB138	177-125 (ø8mm) 177-126 (ø10mm)
12 - 25mm	568-925	568-014	216556 216557	04AZA719 04AZA720 04AZA728	177-177 (ø16mm) 177-286 (ø20mm)
25 - 50mm	568-926	568-014	216557	04AZA729 04AZA737 04AZA738	177-288 (ø30mm) 177-290 (ø40mm)
50 - 100mm	568-927	568-014	216558	04AZA750, 04AZA751, 04AZA752 04AZA753	177-314 (ø62mm) 177-318 (ø87mm)

### Inch/Metric

Range	Set Order No.	Display Unit	Adaptor Supplied	Individual Head No.	Setting rings included
.275" - .5" / 6.985 - 12.7mm	568-928	568-015	954595	04AZB139 04AZB140 04AZB141	177-179 (.35" DIA.) 177-283 (.425" DIA.)
.5" - 1" / 12.7 - 25.4mm	568-929	568-015	216556 216557	04AZA721 04AZA722 04AZA730	177-182 (.65" DIA.) 177-287 (.8" DIA.)
1" - 2" / 25.4 - 50.8mm	568-930	568-015	216557	04AZA731 04AZA739 04AZA740	177-289 (1.2" DIA.) 177-291 (1.6" DIA.)
2" - 4" / 50.8 - 101.6mm	568-936	568-015	216558	04AZA754 04AZA755 04AZA756 04AZA757	177-315 (2.5" DIA.) 177-319 (3.5" DIA.)

## Interchangeable Contact Head Set

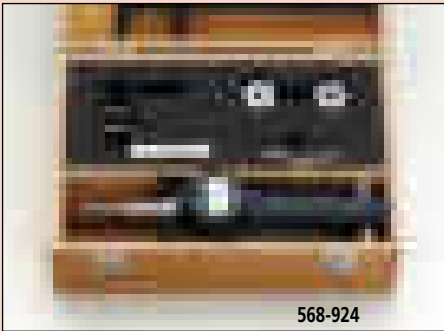

568-924

## Complete Unit Set



568-959

## DIMENSIONS

### Measuring a Blind Hole

The measuring pins held in the jaws permit measuring the diameter of a blind hole right down to the bottom.

Unit: mm

Range	L	a	b	c
6 - 12mm / .275 - .5"	83	2	—	2.5
12 - 20mm / .5 - .8"	53	0.3	5.6	3.5
20 - 30mm / .8 - 1.2"	59	0.3	8.3	5.2
30 - 50mm / 1.2 - 2"	67	0.3	13	10
50 - 125mm / 2 - 5"	75	0.3	17	14

( ) : 50-125mm model

# Holtest/Digimatic Holtest/Borematic

## SERIES 368, 468, 568 Replacement Head Assembly List

TiN-coated measuring contact head assembly

Head Assy Order No.	Measuring Range	HT(Type I)		HTD		SBM		Adaptor*
		Order No.	Model	Order No.	Model	Order No.	Model	
04AZB136	6 - 8mm	368-161	HT-8R	468-161	HTD-8R	568-361	SBM-8C	954595
04AZB137	8 - 10mm	368-162	HT-10R	468-162	HTD-10R	568-362	SBM-10C	
04AZB138	10 - 12mm	368-163	HT-12R	468-163	HTD-12R	568-363	SBM-12C	
04AZA719	12 - 16mm	368-164	HT-16R	468-164	HTD-16R	568-364	SBM-16C	216556
04AZA720	16 - 20mm	368-165	HT-20R	468-165	HTD-20R	568-365	SBM-20C	
04AZA728	20 - 25mm	368-166	HT-25R	468-166	HTD-25R	568-366	SBM-25C	216557
04AZA729	25 - 30mm	368-167	HT-30R	468-167	HTD-30R	568-367	SBM-30C	
04AZA737	30 - 40mm	368-168	HT-40R	468-168	HTD-40R	568-368	SBM-40C	
04AZA738	40 - 50mm	368-169	HT-50R	468-169	HTD-50R	568-369	SBM-50C	
04AZA750	50 - 63mm	368-170	HT-63R	468-170	HTD-63R	568-370	SBM-63C	
04AZA751	62 - 75mm	368-171	HT-75R	468-171	HTD-75R	568-371	SBM-75C	216558
04AZA752	75 - 88mm	368-172	HT-88R	468-172	HTD-88R	568-372	SBM-88C	
04AZA753	87 - 100mm	368-173	HT-100R	468-173	HTD-100R	568-373	SBM-100C	
04AZA775	100 - 125mm	368-174	HT-125R	468-174	HTD-125R	—	—	—
04AZA776	125 - 150mm	368-175	HT-150R	468-175	HTD-150R	—	—	—
04AZA777	150 - 175mm	368-176	HT-175R	468-176	HTD-175R	—	—	—
04AZA778	175 - 200mm	368-177	HT-200R	468-177	HTD-200R	—	—	—
04AZA779	200 - 225mm	368-178	HT-225R	468-178	HTD-225R	—	—	—
04AZA780	225 - 250mm	368-179	HT-250R	468-179	HTD-250R	—	—	—
04AZA781	250 - 275mm	368-180	HT-275R	468-180	HTD-275R	—	—	—
04AZA782	275 - 300mm	368-181	HT-300R	468-181	HTD-300R	—	—	—
04AZB139	.275 - .35"	368-261	HT-.35"R	468-261	HTD-.35"R	568-461	SBM-.35"C	954595
04AZB140	.35 - .425"	368-262	HT-.425"R	468-262	HTD-.425"R	568-462	SBM-.425"C	
04AZB141	.425 - .5"	368-263	HT-.5"R	468-263	HTD-.5"R	568-463	SBM-.5"C	
04AZA721	.5 - .65"	368-264	HT-.65"R	468-264	HTD-.65"R	568-464	SBM-.65"C	216556
04AZA722	.65 - .8"	368-265	HT-.8"R	468-265	HTD-.8"R	568-465	SBM-.8"C	
04AZA730	.8 - 1"	368-266	HT-1"R	468-266	HTD-1"R	568-466	SBM-1"C	216557
04AZA731	1 - 1.2"	368-267	HT-1.2"R	468-267	HTD-1.2"R	568-467	SBM-1.2"C	
04AZA739	1.2 - 1.6"	368-268	HT-1.6"R	468-268	HTD-1.6"R	568-468	SBM-1.6"C	
04AZA740	1.6 - 2"	368-269	HT-2"R	468-269	HTD-2"R	568-469	SBM-2"C	
04AZA754	2 - 2.5"	368-270	HT-2.5"R	468-270	HTD-2.5"R	568-470	SBM-2.5"C	
04AZA755	2.5 - 3"	368-271	HT-3"R	468-271	HTD-3"R	568-471	SBM-3"C	216558
04AZA756	3 - 3.5"	368-272	HT-3.5"R	468-272	HTD-3.5"R	568-472	SBM-3.5"C	
04AZA757	3.5 - 4"	368-273	HT-4"R	468-273	HTD-4"R	568-473	SBM-4"C	
04AZA783	4 - 5"	368-274	HT-5"R	468-274	HTD-5"R	—	—	—
04AZA784	5 - 6"	368-275	HT-6"R	468-275	HTD-6"R	—	—	—
04AZA785	6 - 7"	368-276	HT-7"R	468-276	HTD-7"R	—	—	—
04AZA786	7 - 8"	368-277	HT-8"R	468-277	HTD-8"R	—	—	—
04AZA787	8 - 9"	368-278	HT-9"R	468-278	HTD-9"R	—	—	—
04AZA788	9 - 10"	368-279	HT-10"R	468-279	HTD-10"R	—	—	—
04AZA789	10 - 11"	368-280	HT-11"R	468-280	HTD-11"R	—	—	—
04AZA790	11 - 12"	368-281	HT-12"R	468-281	HTD-12"R	—	—	—
04AZA941	100 - 113mm	—	—	—	—	568-374	SBM-113C	216558
04AZA942	112 - 125mm	—	—	—	—	568-375	SBM-125C	
04AZA943	4 - 4.5"	—	—	—	—	568-474	SBM-4.5"C	
04AZA944	4.5 - 5"	—	—	—	—	568-475	SBM-5"C	

\* Adaptors are required to connect borematic head assemblies and borematic main body units. Sets and complete units include the correct adaptors for the included heads, while individual heads (purchased separately) do not.

Adaptors are not required for Vernier/Digimatic Holtests.

Separately purchased head assemblies are not covered by the guaranteed accuracy for holtests (368/468 series).

# Tubular Inside Micrometers

## SERIES 133 — Single-Rod Type

### FEATURES

- With locking clamp.
- Zero point can be readjusted by rotating the micrometer head sleeve. A key wrench is supplied.
- Clear, crisp graduations on the satin-chrome finished micrometer head.
- Carbide-tipped measuring faces.
- Supplied in fitted plastic case. Over 200mm / 8" supplied in wooden case.

### Technical Data

Accuracy: Refer to the list of specifications.  
Graduation: 0.01mm or .001"

### Optional Accessories

---- : Setting ring (See page C-29.)

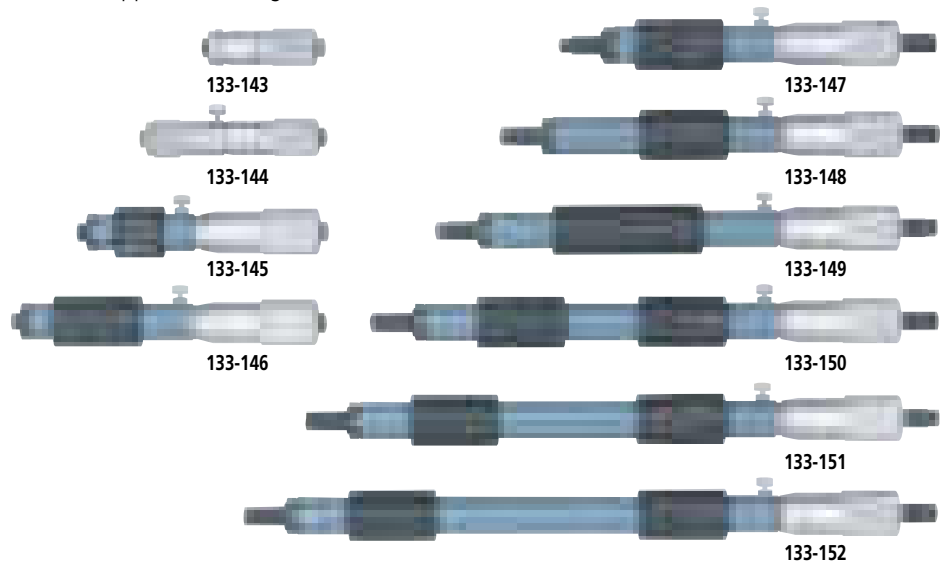

### SPECIFICATIONS

Metric			Individual
Range	Order No.	Accuracy	
50 - 75mm	<b>133-143</b>	±3µm	
75 - 100mm	<b>133-144</b>	±4µm	
100 - 125mm	<b>133-145</b>	±5µm	
125 - 150mm	<b>133-146</b>	±5µm	
150 - 175mm	<b>133-147</b>	±5µm	
175 - 200mm	<b>133-148</b>	±5µm	
200 - 225mm	<b>133-149</b>	±5µm	
225 - 250mm	<b>133-150</b>	±6µm	
250 - 275mm	<b>133-151</b>	±6µm	
275 - 300mm	<b>133-152</b>	±6µm	
300 - 325mm	<b>133-153</b>	±7µm	
325 - 350mm	<b>133-154</b>	±7µm	
350 - 375mm	<b>133-155</b>	±7µm	
375 - 400mm	<b>133-156</b>	±8µm	
400 - 425mm	<b>133-157</b>	±8µm	
425 - 450mm	<b>133-158</b>	±8µm	
450 - 475mm	<b>133-159</b>	±9µm	
475 - 500mm	<b>133-160</b>	±9µm	
500 - 525mm	<b>133-161</b>	±9µm	
525 - 550mm	<b>133-162</b>	±10µm	
550 - 575mm	<b>133-163</b>	±10µm	
575 - 600mm	<b>133-164</b>	±10µm	
600 - 625mm	<b>133-165</b>	±11µm	
625 - 650mm	<b>133-166</b>	±11µm	
650 - 675mm	<b>133-167</b>	±11µm	
675 - 700mm	<b>133-168</b>	±12µm	

Metric			Individual
Range	Order No.	Accuracy	
700 - 725mm	<b>133-169</b>	±12µm	
725 - 750mm	<b>133-170</b>	±12µm	
750 - 775mm	<b>133-171</b>	±13µm	
775 - 800mm	<b>133-172</b>	±13µm	
800 - 825mm	<b>133-173</b>	±13µm	
825 - 850mm	<b>133-174</b>	±14µm	
850 - 875mm	<b>133-175</b>	±14µm	
875 - 900mm	<b>133-176</b>	±14µm	
900 - 925mm	<b>133-177</b>	±15µm	
925 - 950mm	<b>133-178</b>	±15µm	
950 - 975mm	<b>133-179</b>	±15µm	
975 - 1000mm	<b>133-180</b>	±16µm	

Inch			Individual
Range	Order No.	Accuracy	
2" - 3"	<b>133-223</b>	±.00015"	
3" - 4"	<b>133-224</b>	±.0002"	
4" - 5"	<b>133-225</b>	±.00025"	
5" - 6"	<b>133-226</b>	±.00025"	
6" - 7"	<b>133-227</b>	±.00025"	
7" - 8"	<b>133-228</b>	±.00025"	
8" - 9"	<b>133-229</b>	±.00025"	
9" - 10"	<b>133-230</b>	±.0003"	
10" - 11"	<b>133-231</b>	±.0003"	
11" - 12"	<b>133-232</b>	±.0003"	

# Tubular Inside Micrometers

**SERIES 133**



133-902

Metric Micrometer set		
Range	Order No.	Included in set
50 - 150mm (4 pcs. set)	133-901	<ul style="list-style-type: none"> <li>• 133-143, 133-144, 133-145, 133-146</li> <li>• with fitted case</li> </ul>
50 - 300mm (10 pcs. set)	133-902	<ul style="list-style-type: none"> <li>• 133-143, 133-144, 133-145, 133-146, 133-147, 133-148, 133-149, 133-150, 133-151, 133-152</li> <li>• with fitted case</li> </ul>

Inch Micrometer set		
Range	Order No.	Included in set
2" - 6" (4 pcs. set)	133-903	<ul style="list-style-type: none"> <li>• 133-223, 133-224, 133-225, 133-226</li> <li>• with fitted case</li> </ul>
2" - 12" (10 pcs. set)	133-904	<ul style="list-style-type: none"> <li>• 133-223, 133-224, 133-225, 133-226, 133-227, 133-228, 133-229, 133-230, 133-231, 133-232</li> <li>• with fitted case</li> </ul>

## DIMENSIONS

Unit: mm

Order No.	L	a	b
133-145 / 133-225	100	5	3
133-146 / 133-226	125	5	3
133-147 / 133-227	150	18	15
133-148 / 133-228	175	18	15
133-149 / 133-229	200	18	15
133-180 / 133-232	975	18	15

# Inside Micrometers

## SERIES 141 — Interchangeable-Rod Type

### FEATURES

- Wide range of ID measurements with interchangeable rods.
- Each interchangeable rod is marked with its measuring range.
- The sizes of interchangeable rods can be adjusted with spacing collars.
- Both micrometer head and furnished rods are satin-chrome finished throughout.
- Supplied in fitted plastic case. Over 1000mm / 40" supplied in wooden case.

### Technical Data

Metric Model

Accuracy:  $\pm(6+L/50)\mu\text{m}$   
 L=Maximum measuring length (mm)  
 Fraction rounded up

Inch Model

Accuracy:  $\pm\{.00024 + (.00004 \times R/2)\}''$   
 R=Maximum measuring length (inch)  
 Fraction rounded up

Graduation: 0.01mm or .001"

### Optional Accessories

---- : Setting ring (See page C-29.)

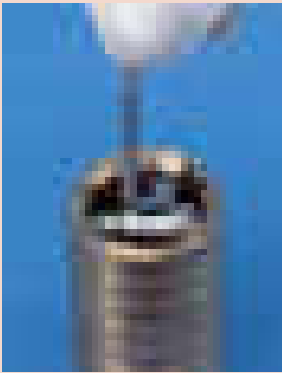

141-233

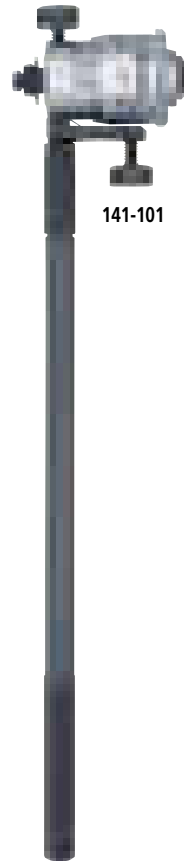
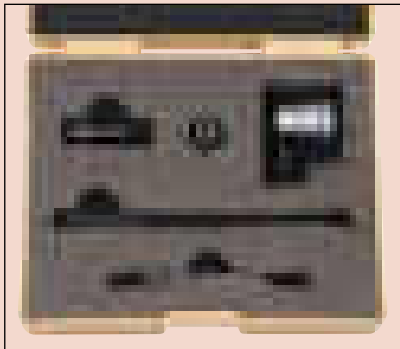

When using the extension rod

### DIMENSIONS

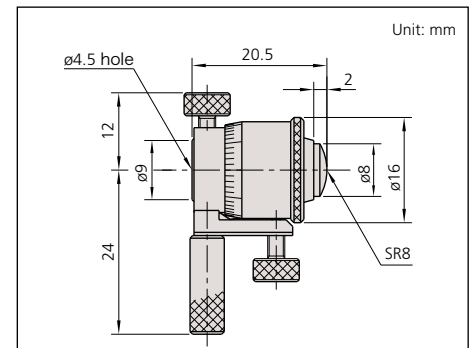

### SPECIFICATIONS

#### Metric

Range	Order No.	Travel of micrometer head	Remarks
25 - 32mm	141-001 / 141-003*	7mm	Micrometer Head only
25 - 50mm	141-101 / 141-103*	7mm	with 2 rods
50 - 63mm	141-025 / 141-027*	13mm	Micrometer Head only
50 - 200mm	141-205 / 141-211*	13mm	with 3 rods
50 - 300mm	141-206 / 141-212*	13mm	with 5 rods
200 - 225mm	141-009 / 141-011*	25mm	Micrometer Head only
200 - 500mm	141-117	25mm	with 3 rods
200 - 1000mm	141-118	25mm	with 8 rods

\*with carbide-tipped face

#### Inch

Range	Order No.	Travel of micrometer head	Remarks
1" - 1.25"	141-002 / 141-004*	.25"	Micrometer Head only
1" - 2"	141-102 / 141-104*	.25"	with 2 rods
2" - 2.5"	141-026 / 141-028*	.5"	Micrometer Head only
2" - 8"	141-208 / 141-214*	.5"	with 3 rods
2" - 12"	141-233 / 141-215*	.5"	with 5 rods
8" - 9"	141-010 / 141-012*	1"	Micrometer Head only
8" - 20"	141-121	1"	with 3 rods
8" - 40"	141-122	1"	with 8 rods

\*with carbide-tipped face

# Digimatic Tubular Inside Micrometers

**SERIES 337 — Extension-Rod Type / SERIES 339 — Extension-Pipe Type**



## FEATURES

- Wide range of ID measurements by combining extension rods (pipes) and anvils with the micrometer head.
- The 339 Series uses highly durable extension pipes.
- Carbide-tipped measuring faces.
- Supplied in wooden case.



337-303

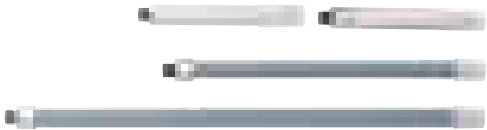

339-304



### Metric — Extension-rod type

Range	Order No.	Travel of micrometer head	Extension rods
200 - 225mm	337-101	25mm	Micrometer Head only
200 - 1000mm	337-301	25mm	25mm, 50mm, 100mm (2 pcs.), 200mm, 300mm
200 - 1500mm	337-302	25mm	25mm, 50mm, 100mm, 200mm, 300mm (3 pcs.)

### Inch/Metric — Extension-rod type

Range	Order No.	Travel of micrometer head	Extension rods
8 - 9" / 203.2 - 228.6mm	337-102	1"	Micrometer Head only
8 - 40" / 203.2 - 1016mm	337-303	1"	1", 2", 4" (2 pcs.), 8", 12"
8 - 60" / 203.2 - 1524mm	337-304	1"	1", 2", 4", 8", 12" (3 pcs.)

### Metric — Extension-pipe type

Range	Order No.	Travel of micrometer head	Extension pipes
200 - 225mm	339-101	25mm	Micrometer Head only
200 - 1000mm	339-301	25mm	25mm, 50mm, 100mm, 200mm, 400mm
200 - 2000mm	339-302	25mm	25mm, 50mm, 100mm, 200mm (2 pcs.), 400mm (3 pcs.)

### Inch/Metric — Extension-pipe type

Range	Order No.	Travel of micrometer head	Extension pipes
8 - 9" / 203.2 - 228.6mm	339-102	1"	Micrometer Head only
8 - 40" / 203.2 - 1016mm	339-303	1"	1", 2", 4", 8", 16"
8 - 80" / 203.2 - 2000mm	339-304	1"	1", 2", 4", 8" (2 pcs.), 16" (3 pcs.)

## DIMENSIONS

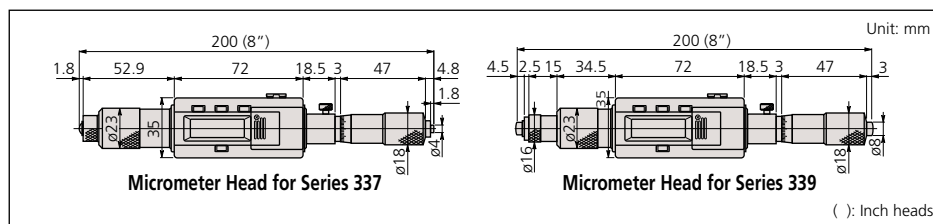

## Technical Data

Metric Model

Accuracy:  $\pm(3+n+L/50)\mu\text{m}$   
 L=Maximum measuring length (mm)  
 Fraction rounded up  
 n=Number of rods  
 Excluding quantizing error

Inch Model

Accuracy:  $\pm\{.00015+.00005n+.00005R\}^*$ "  
 R=Maximum measuring length (inch)  
 n=Number of rods  
 Fraction rounded up

Resolution: 0.001mm or .0001"/0.001mm

Display: LCD

Battery: SR44 (1 pcs.), 938882

Battery life: Approx. 8 months under normal use

## Function

Zero/ABS, Data hold, Data output, Preset, inch/mm conversion (inch/mm models)

Alarm: Low voltage, Counting value composition error

## Optional Accessories

05CZA662: SPC cable (1m)

05CZA663: SPC cable (2m)

-----: Setting ring (See page C-29.)

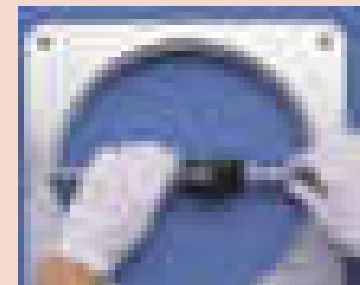



# Tubular Inside Micrometers

## SERIES 137 — Extension-Rod Type

### FEATURES

- Wide range of ID measurements by combining extension rods (pipes) and anvils with the micrometer head.
- Carbide-tipped measuring faces are available.
- Supplied in fitted plastic case except 1500 mm / 60" come in wooden case.



137-011

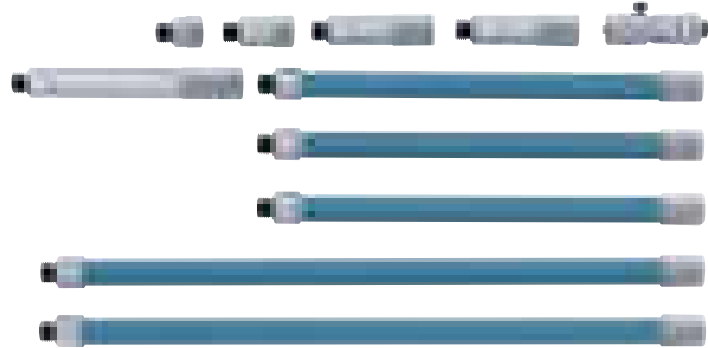

137-205

### Technical Data

Metric Model

Accuracy:  $\pm(3+n+L/50)\mu\text{m}$   
 L=Maximum measuring length (mm)  
 n=Number of rods  
 Fraction rounded up

Inch Model

Accuracy:  $\pm[.00015+.00005n+.00005R*/2]$ "  
 R=Maximum measuring length (inch)  
 n=Number of rods  
 Fraction rounded up

Graduation: 0.01mm or .001"

### Optional Accessories

---- : Setting ring (See page C-29.)

### SPECIFICATIONS

Metric		Extension-rod type	
Range	Order No.	Travel of micrometer head	Extension rods
50 - 63mm	137-011 / 137-013*	13mm	Micrometer Head only
50 - 150mm	137-201 / 137-206*	13mm	13mm, 25mm, 50mm
50 - 300mm	137-202 / 137-207*	13mm	13mm, 25mm, 50mm (2 pcs.), 100mm
50 - 500mm	137-203 / 137-208*	13mm	13mm, 25mm, 50mm (2 pcs.), 100mm, 200mm
50 - 1000mm	137-204 / 137-209*	13mm	13mm, 25mm, 50mm (2 pcs.), 100mm, 200mm (2 pcs.), 300mm
50 - 1500mm	137-205 / 137-210*	13mm	13mm, 25mm, 50mm (2 pcs.), 100mm, 200mm (3pcs.), 300mm (2 pcs.)

\*with carbide-tipped face

Inch		Extension-rod type	
Range	Order No.	Travel of micrometer head	Extension rods
2" - 2.5"	137-012 / 137-014*	.5"	Micrometer Head only
2" - 6"	137-211 / 137-216*	.5"	.5", 1", 2"
2" - 12"	137-212 / 137-217*	.5"	.5", 1", 2" (2 pcs.), 4"
2" - 20"	137-213 / 137-218*	.5"	.5", 1", 2" (2 pcs.), 4", 8"
2" - 40"	137-214 / 137-219*	.5"	.5", 1", 2" (2 pcs.), 4", 8" (2 pcs.), 12"
2" - 60"	137-215 / 137-220*	.5"	.5", 1", 2" (2 pcs.), 4", 8" (3 pcs.), 12" (2 pcs.)

\*with carbide-tipped face

### DIMENSIONS

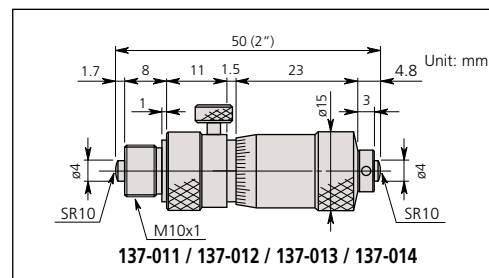

# Tubular Inside Micrometers

## SERIES 139 — Extension-Pipe Type

### FEATURES

- Wide range of ID measurements by combining extension pipes and anvils with the micrometer head.
- Supplied in fitted wooden case, except 500 mm / 20" which comes in plastic case.



#### Metric Extension-pipe type

Range	Order No.	Travel of micrometer head	Extension pipes
100 - 125mm	<b>139-001</b>	25mm	Micrometer Head only
100 - 500mm	<b>139-173</b>	25mm	25mm, 50mm, 100mm, 200mm
100 - 900mm	<b>139-174</b>	25mm	25mm, 50mm, 100mm, 200mm, 400mm
100 - 1300mm	<b>139-175</b>	25mm	25mm, 50mm, 100mm, 200mm, 400mm (2 pcs.)
100 - 1700mm	<b>139-176</b>	25mm	25mm, 50mm, 100mm, 200mm, 400mm (3 pcs.)
100 - 2100mm	<b>139-177</b>	25mm	25mm, 50mm, 100mm, 200mm, 400mm (4 pcs.)

#### Inch Extension-pipe type

Range	Order No.	Travel of micrometer head	Extension pipes
4" - 5"	<b>139-002</b>	1"	Micrometer Head only
4" - 20"	<b>139-178</b>	1"	1", 2", 4", 8"
4" - 36"	<b>139-179</b>	1"	1", 2", 4", 8", 16"
4" - 52"	<b>139-180</b>	1"	1", 2", 4", 8", 16" (2 pcs.)
4" - 68"	<b>139-181</b>	1"	1", 2", 4", 8", 16" (3 pcs.)
4" - 84"	<b>139-182</b>	1"	1", 2", 4", 8", 16" (4 pcs.)

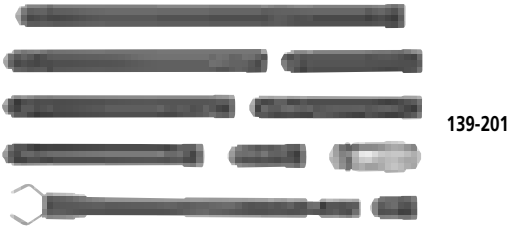

#### Inch Extension-pipe type

Range	Order No.	Travel of micrometer head	Extension pipes	Remarks
1.5 - 2"	<b>139-004</b>	.5"	Micrometer Head only	—
4 - 5"	<b>139-006</b>	1"	Micrometer Head only	—
1.5 - 12"	<b>139-201</b>	.5"	.5", 1", 2", 2.5", 3", 3.5", 4", 6"	Includes <b>139-004</b>
4 - 40"	<b>139-202</b>	1"	1", 2", 3", 6", 9", 12", 14", 16", 17", 19"	Includes <b>139-006</b>

### DIMENSIONS

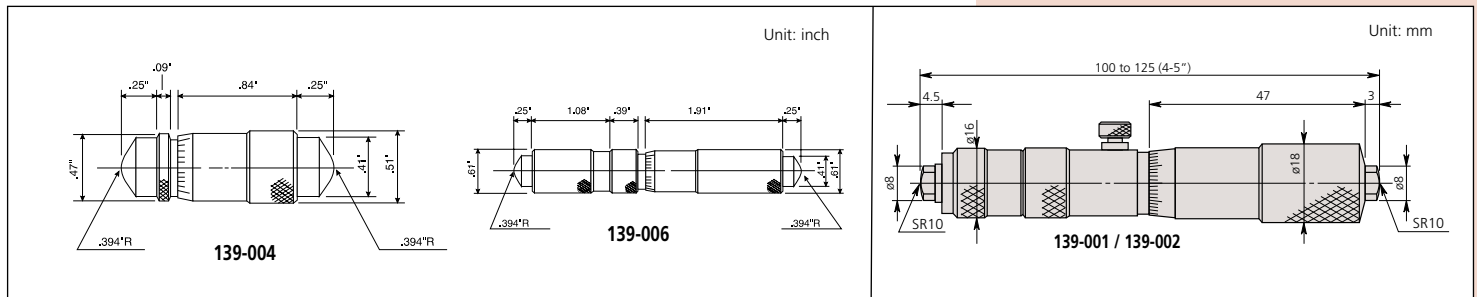

### Technical Data

Metric Model

Accuracy:

- Series 139:  $\pm(3+n+L/50)\mu\text{m}$   
L=Maximum measuring length (mm)  
n=number of rods  
Fraction rounded up

Inch Model

Accuracy:

- Series 139:  $\pm(.00015+.00005n+.00005R*/2)"$   
R=Maximum measuring length (inch)  
n=number of rods  
Fraction rounded up

Graduation: 0.01mm or .001"

Measurement error of micrometer head:  $\pm 3\mu\text{m}$

### Optional Accessories

-----: Setting ring (See page C-29.)

# Tubular Inside Micrometers

## SERIES 140 — Extension-Pipe Type

### Technical Data

Metric Model

Accuracy:  $\pm(3+n+L/50)\mu\text{m}$   
 n=Number of rod,  
 L=Maximum measuring length (mm),  
 Fraction rounded up

Inch Model

Accuracy:  $\pm(.00015+.00005n+.00005R*/2)''$   
 n=Number of rod  
 R=Maximum measuring length (inch)  
 Fraction rounded up

Graduation: 0.01mm or .001"

### Optional Accessories

----- : Setting ring (See page C-29.)

### FEATURES

- Wide range of ID measurements by combining extension rods (pipes) and anvils with the micrometer head.
- The Series 140 use highly durable/ large-diameter extension pipes.
- Supplied in fitted wooden case.

#### Metric — Extension-pipe type

Range	Order No.	Travel of micrometer head	Extension pipes
1000 - 2000mm	<b>140-157</b>	50mm	50mm, 100mm (2 pcs.), 200mm, 500mm
1000 - 3000mm	<b>140-158</b>	50mm	50mm, 100mm (2 pcs.), 200mm, 500mm, 1000mm
1000 - 4000mm	<b>140-159</b>	50mm	50mm, 100mm (2 pcs.), 200mm, 500mm, 1000mm (2 pcs.)
1000 - 5000mm	<b>140-160</b>	50mm	50mm, 100mm (2 pcs.), 200mm, 500mm, 1000mm (3 pcs.)

#### Inch — Extension-pipe type

Range	Order No.	Travel of micrometer head	Extension pipes
40" - 80"	<b>140-161</b>	2"	2", 4" (2 pcs.), 8", 20"
40" - 120"	<b>140-162</b>	2"	2", 4" (2 pcs.), 8", 20", 40"
40" - 160"	<b>140-163</b>	2"	2", 4" (2 pcs.), 8", 20", 40" (2 pcs.)
40" - 200"	<b>140-164</b>	2"	2", 4" (2 pcs.), 8", 20", 40" (3 pcs.)

### DIMENSIONS

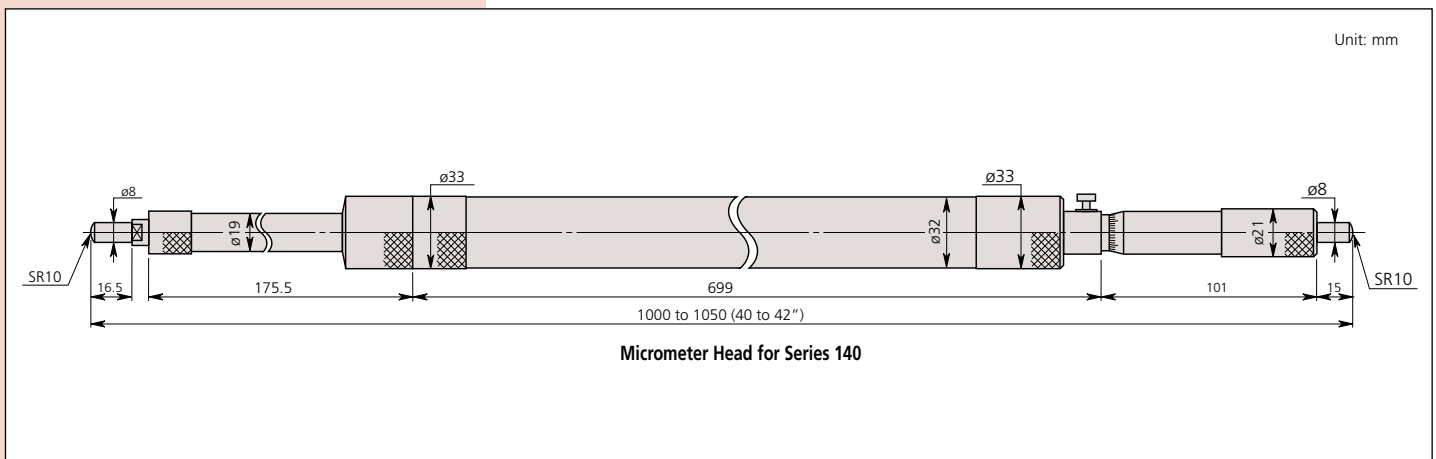

# Inside Micrometers

## SERIES 345, 145 — Caliper Type

### FEATURES

- Caliper-type jaws are made of high-grade, tool steel.
- Locking clamp for positive locking of spindle.
- Non-slip grip finish (digital models)
- Satin-chrome finished.
- A special holder is available to be used with Mitutoyo micrometer stand.
- Supplied in fitted plastic case. Over 175mm / 4" supplied in wooden case.

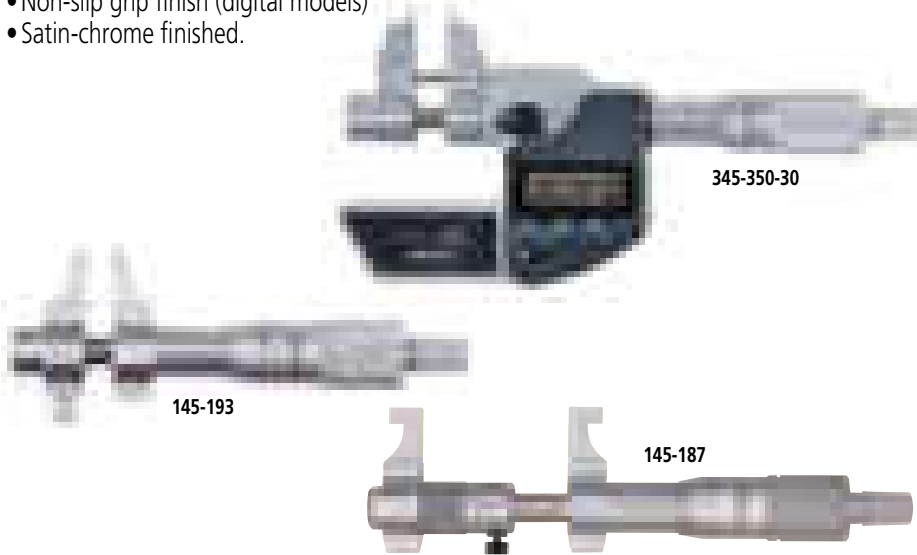

### SPECIFICATIONS

Metric		
Range	Order No.	Accuracy
5 - 30mm	345-250-30	±5µm
25 - 50mm	345-251-30	±6µm

Inch/Metric Digital model		
Range	Order No.	Accuracy
.2 - 1.2" / 5-30mm	345-350-30	±.00025"
1 - 2" / 25-50mm	345-351-30	±.0003"

Metric		
Range	Order No.	Accuracy
5 - 30mm	145-185	±5µm
25 - 50mm	145-186	±6µm
50 - 75mm	145-187	±7µm
75 - 100mm	145-188	±8µm
100 - 125mm	145-189	±9µm
125 - 150mm	145-190	±9µm
150 - 175mm	145-191	±10µm
175 - 200mm	145-192	±10µm
200 - 225mm	145-217	±11µm
225 - 250mm	145-218	±11µm
250 - 275mm	145-219	±12µm
275 - 300mm	145-220	±12µm

Inch		
Range	Order No.	Accuracy
.2 - 1.2"	145-193	±.00025"
1 - 2"	145-194	±.0003"
2 - 3"	145-195	±.00035"
3 - 4"	145-196	±.0004"

### DIMENSIONS

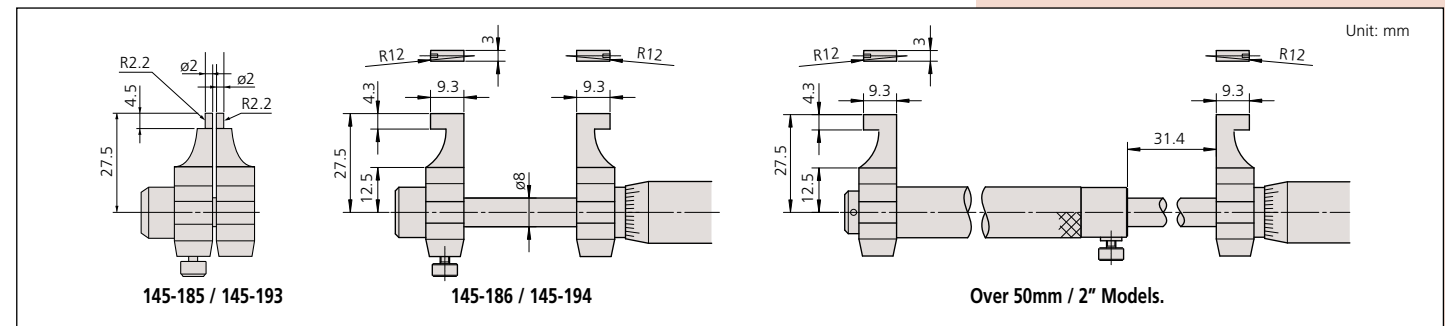

### Technical Data

Accuracy: Refer to the list of specifications.  
(excluding quantizing error for digital models)  
Resolution\*: 0.01mm or .00005"/0.001mm  
Graduation\*\*: 0.01mm or .001"  
Measuring faces: Carbide tipped  
Display\*: LCD  
Battery\*: SR44 (1 pc.), **938882**  
Battery life\*: Approx. 2.4 years under normal use  
\*Digital models \*\*Analog models

### Function of Digital Model

Origin-set, Zero-setting, Data hold, Data output, inch/mm conversion (inch/mm models)  
Function Lock, 2 Presets  
Alarm: Low voltage, Counting value composition error

### Optional Accessories

- 05CZA662**: SPC cable with data switch 1m / 40"
- 05CZA663**: SPC cable with data switch 2m / 80"
- : Setting ring (See page C-29.)
- 300401**: Cap for stand holder
- 300400**: Stand holder

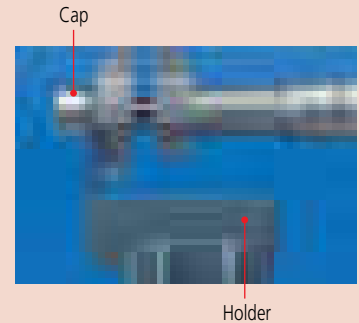
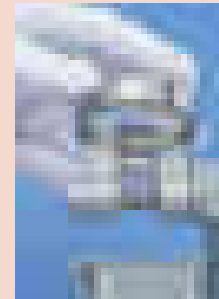



# Inside Micro Checker

## SERIES 515

### FEATURES

- The Inside Micro Checker is designed to efficiently check the zero point of a tubular inside micrometer.
- Each measuring block is made of zirconia-based ceramic and is free from deterioration and dimensional changes over time.

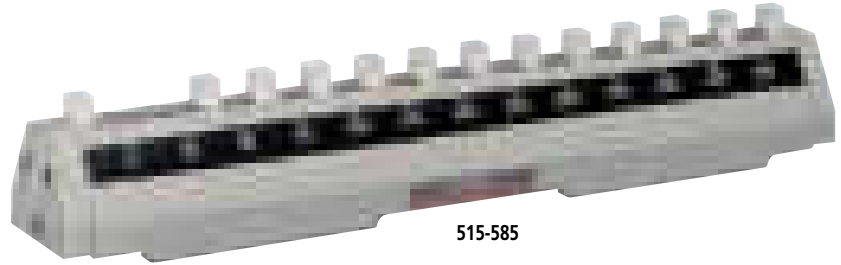

515-585

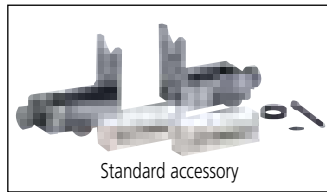

Standard accessory

### Technical Data

Block pitch accuracy:  $\pm(1+L/150)\mu\text{m}$   
 L= Length to check (mm)

### Standard Accessories

- 611671-02:** Auxiliary Block (10mm)
- 940286:** Clamping element with V-rest
- 602195:** Spacer (for  $\varnothing 8\text{mm}$  measuring anvil)

### Optional Accessories

- 602160:** Wooden case for 300mm Inside Micro Checker
- 602163:** Wooden case for 600mm Inside Micro Checker

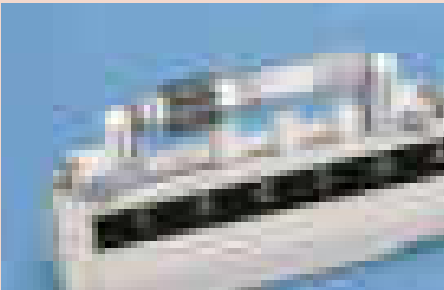

### SPECIFICATIONS

Range	Order No.	Length to check
300mm	<b>515-585</b>	25, 50, 75, 100, 125, 150, 175, 200, 225, 250, 275, 300mm
600mm	<b>515-586</b>	25, 50, 75, 100, 125, 150, 175, 200, 225, 250, 275, 300, 325, 350, 375, 400, 425, 450, 475, 500, 525, 550, 575, 600mm

### DIMENSIONS

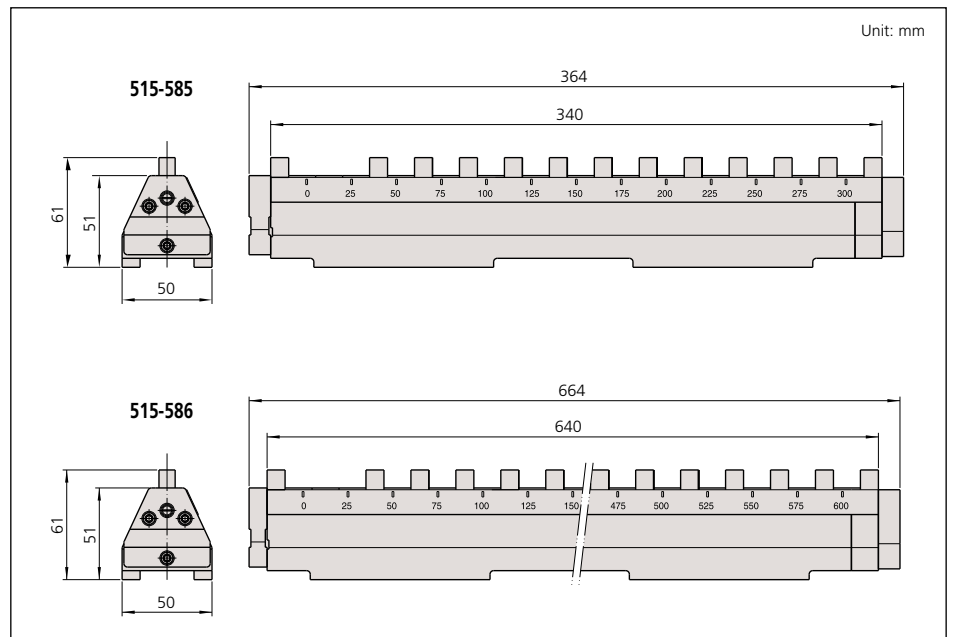

# Bore Gages

## SERIES 511 — for Small Holes

### FEATURES

- Interchangeable anvils are made of alloy steel.
- The dial indicator is fully protected by a rugged cover.

### SPECIFICATIONS

**Metric** Gage Stem  $\varnothing$  8mm

Measuring Range	Order No. Without Dial Gage	Order No. With 2046SB Graduation 0.01mm	Order No. With 2109SB-10 Graduation 0.001mm	Number of Anvils	Number of Spacers
6 - 10mm	511-209*	511-211	511-210	9	1
10 - 18.5mm	511-201*	511-204	511-203	9	1

\*Does not come with Dial Gage Protector Cover (21DZA000)

**Inch** Gage Stem Dia .375"

Measuring Range	Order No. Without Dial Gage	Order No. With 2922SB Graduation .0005"	Order No. With 2923SB-10 Graduation .0001"	Number of Anvils	Number of Spacers
.24 - .4"	511-214*	511-213	511-212	9	1
.4 - .74"	511-205*	511-207	511-206	9	1

\*Does not come with Dial Gage Protector Cover (21DZA000)



511-204

### DIMENSIONS

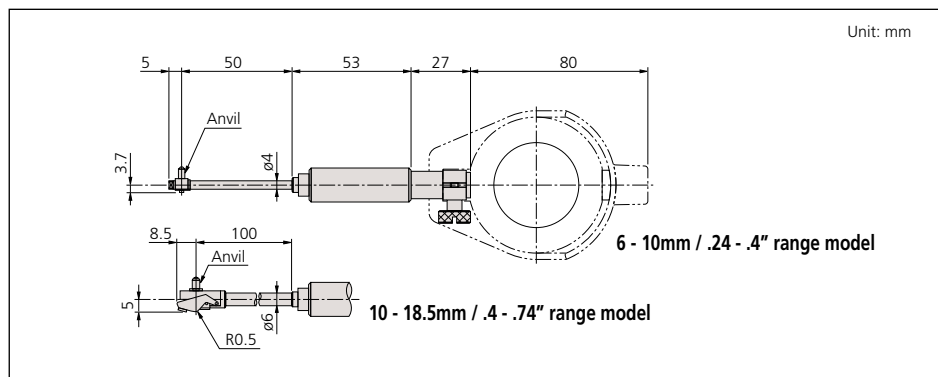

### Technical Data

Accuracy:  $5\mu\text{m}$  / .0002"  
 Indication stability:  $2\mu\text{m}$  / .00008"  
 Graduation: 0.01mm, 0.001mm, .0005" or .0001"

### Measuring Heads

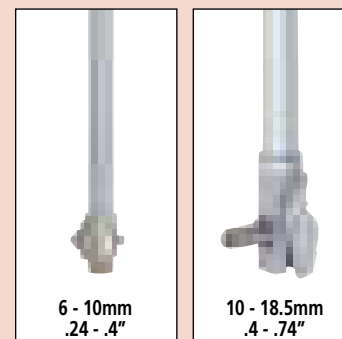

### Optional Accessories

21DZA000: Dial Gage Protector Cover  
 -----: Setting ring (See page C-29.)

# Bore Gages

## SERIES 511—Standard Type

Mitutoyo offers a complete selection of bore gages, all of them with interchangeable anvils and necessary accessories to perform close tolerance ID measurements.

### FEATURES

- Carbide-tipped contact points for durability.
- The dial indicator is fully protected by a rugged cover.
- Optional extension rods can be attached for measuring deep holes.



511-743

### SPECIFICATIONS

**Inch** — Gage Stem  $\varnothing$  3/8"

Measuring Range	Order No. Without Indicator	Order No. With 2922SB Graduation .0005"	Order No. With 2923SB-10 Graduation .0001"	Number of Anvils	Number of Spacers
.7 - 1.4"	511-731*	511-741	511-751	9	2
1.4 - 2.5"	511-732*	511-742	511-752	6	4
2.0 - 6.0"	511-733*	511-743	511-753	11 (2" sub anvil)	4
4.0 - 6.5"	511-734*	511-744	511-754	13	4
6.5 - 10"	511-735*	511-745	511-755	6	7
10 - 16"	511-736*	511-746	511-756	5 (3" sub anvil)	7
.7 - 6"	—	511-931	511-932	26 (2" sub anvil)	10

\*Does not come with Dial Gage Protector Cover (21DZA000)

**Metric** — Gage Stem  $\varnothing$  8mm

Measuring Range	Order No. Without Indicator	Order No. With 2046SB Graduation 0.01mm	Order No. With 2109SB-10 Graduation 0.001mm	Number of Anvils	Number of Spacers
18 - 35mm	511-701*	511-711	511-721	9	2
35 - 60mm	511-702*	511-712	511-722	6	4
50 - 150mm	511-703*	511-713	511-723	11 (50mm Sub Anvil)	4
100 - 160mm	511-704*	511-714	511-724	13	4
160 - 250mm	511-705*	511-715	511-725	6	7
250 - 400mm	511-706*	511-716	511-726	5 (75mm Sub Anvil)	7
18 - 150mm	—	511-921 (3 pc set)	511-922 (3 pc set)	26 (50mm Sub Anvil)	10

\*Does not come with Dial Gage Protector Cover (21DZA000)

### Technical Data

Accuracy:  $2\mu\text{m}$  / .00008"

Indication stability:  $1\mu\text{m}$  / .00004"

Graduation: 0.01mm, 0.001mm, .0005" or .0001"



511-712

## Contact Point

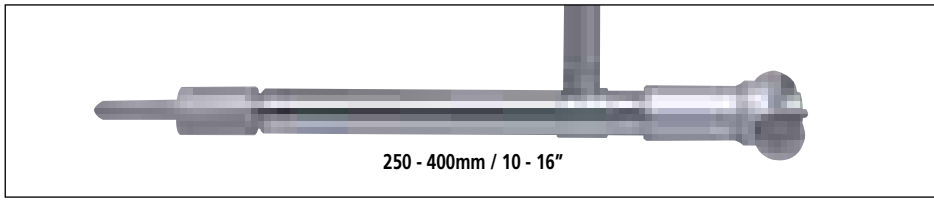
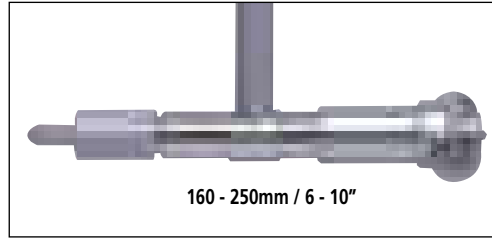
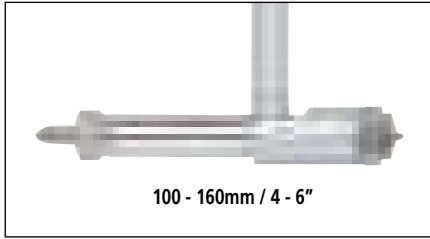
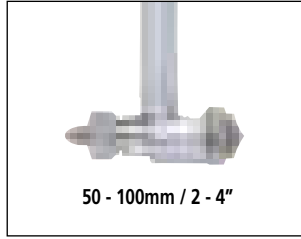
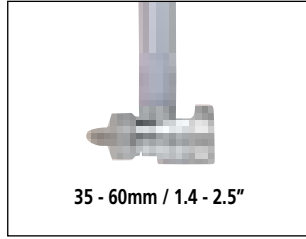
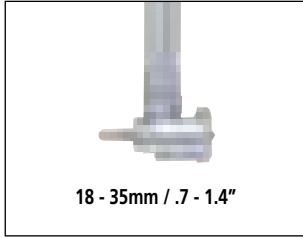

## DIMENSIONS

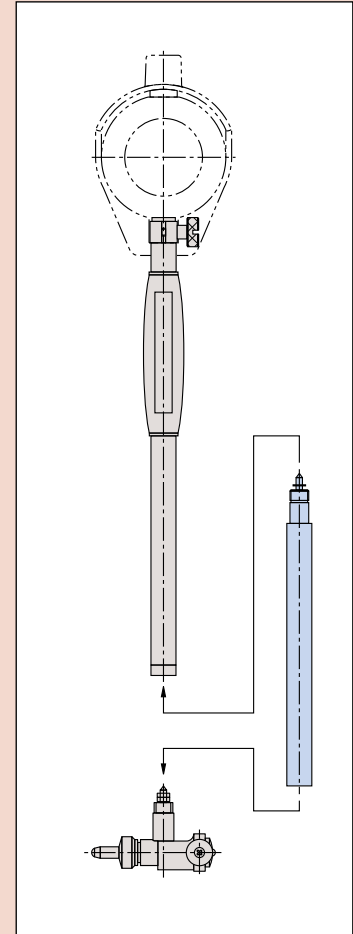
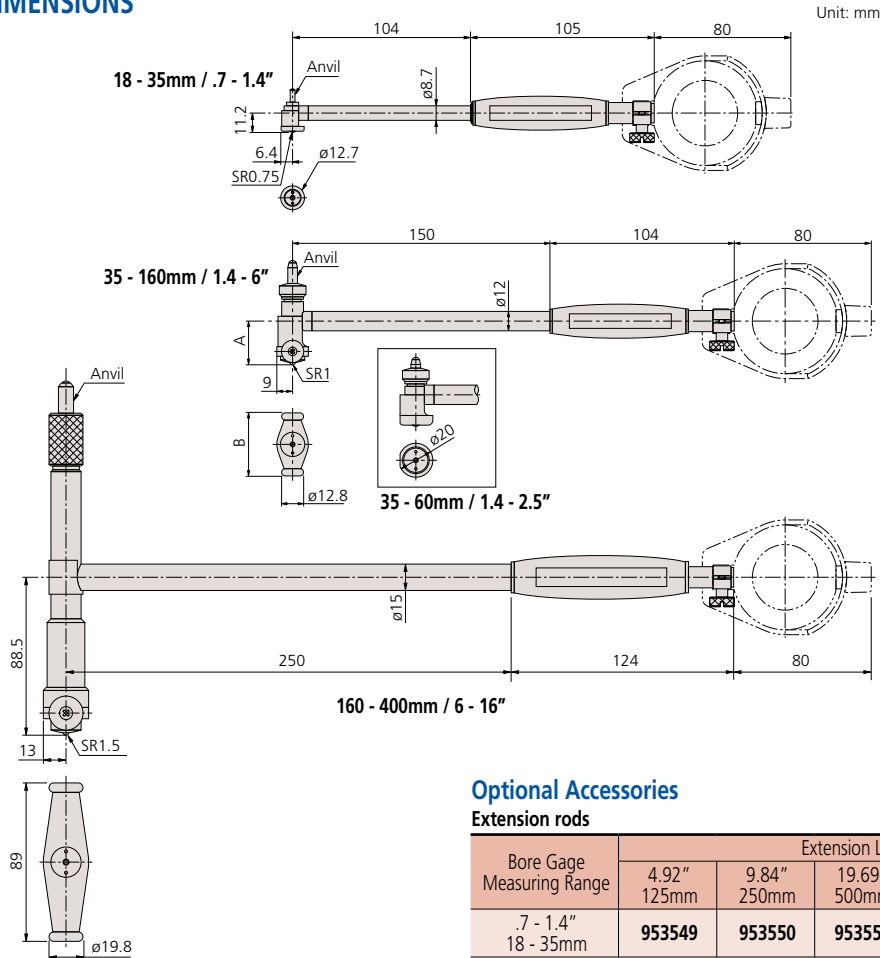

Setting ring (See page C-29.)

## Optional Accessories

### Extension rods

Bore Gage Measuring Range	Extension Length					Rod Diameter	Spanner
	4.92" / 125mm	9.84" / 250mm	19.69" / 500mm	29.53" / 750mm	39.37" / 1000mm		
.7 - 1.4" / 18 - 35mm	953549	953550	953551	-	-	.34" / 8.7mm	102148
1.4 - 6.5" / 35 - 160mm	953552	953553	953554	953555	953556	.47" / 12mm	212556
6.5 - 16" / 160 - 400mm	953557	952361	953558	953559	953560	.59" / 15mm	212556

Note: Above list is used for 511-1XX series; not available for 511-2XX Series.





511-786

### Technical Data

Accuracy:  $2\mu\text{m} / .00008''$   
 Indication stability:  $1\mu\text{m} / .00004''$   
 Graduation: 0.01mm, 0.001mm, .0005" or .0001"

### Contact Point

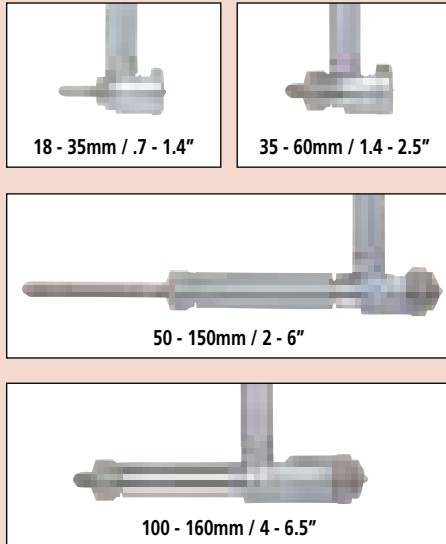

# Bore Gages

## SERIES 511 — Short-Leg Type

### FEATURES

- Compact and lightweight because of the short length below the grip.
- Carbide-tipped contact point for durability.

### SPECIFICATIONS

Inch		Gage Stem $\varnothing 3/8''$		
Measuring Range	Order No. With 2922SB Graduation .0005"	Order No. With 2923SB-10 Graduation .0001"	Number of Anvils	Number of Spacers
.7 - 1.4"	511-786	511-791	9	2
1.4 - 2.5"	511-787	511-792	6	4
2.0 - 6.0"	511-788	511-793	11 (2" sub anvil)	4
4.0 - 6.5"	511-789	511-794	13	4

Metric		Gage Stem $\varnothing 8\text{mm}$		
Measuring Range	Order No. With 2046SB Graduation 0.01mm	Order No. With 2109SB-10 Graduation 0.001mm	Number of Anvils	Number of Spacers
18 - 35mm	511-766	511-771	9	2
35 - 60mm	511-767	511-772	6	4
50 - 150mm	511-768	511-773	11 (50mm Sub Anvil)	4
100 - 160mm	511-769	511-774	13	4

### DIMENSIONS

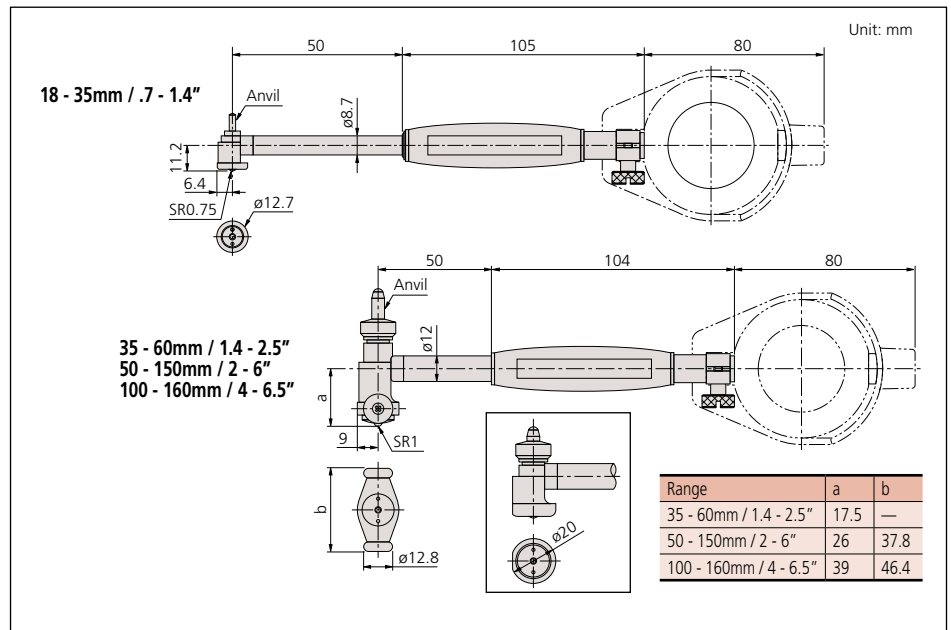

### Optional Accessories

---- : Setting ring (See page C-29.)

# Bore Gages

## SERIES 511 — for Blind Holes

### FEATURES

- Measure ID at position close to the bottom of blind holes.
- Carbide-contact point ensures high durability and wear resistance.
- Grip is large and hollow to reduce effect of body heat on high-accuracy measurements.

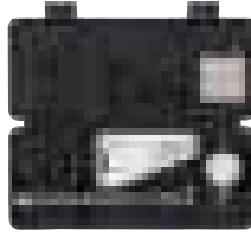

511-426

### SPECIFICATIONS

**Metric** Gage Stem  $\varnothing$  8mm

Measuring Range	Order No. Without Dial Gage	Order No. With 2046SB Graduation 0.01mm	Order No. With 2109SB-10 Graduation 0.001mm	Number of Anvils	Number of Spacers
15 - 35mm	511-415*	511-425	511-435	11 10mm Sub-Anvil	1
35 - 60mm	511-416*	511-426	511-436	6	4
50 - 150mm	511-417*	511-427	511-437	11 50mm Sub-Anvil	4

\*Does not come with Dial Gage Protector Cover (21DZA000)

**Inch** Gage Stem Dia. .375"

Measuring Range	Order No. Without Dial Gage	Order No. With 2922SB Graduation .0005"	Order No. With 2923SB-10 Graduation .0001"	Number of Anvils	Number of Spacers
.6 - 1.4"	511-418*	511-428	511-438	11 .4" Sub-Anvil	1
1.4 - 2.4"	511-419*	511-429	511-439	6	4
2 - 6"	511-420*	511-430	511-440	11 2" Sub-Anvil	4

\*Does not come with Dial Gage Protector Cover (21DZA000)

### Contact Points

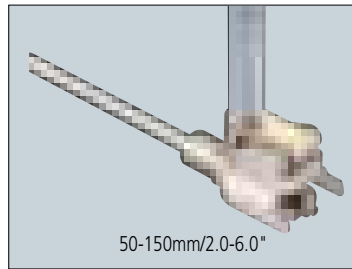
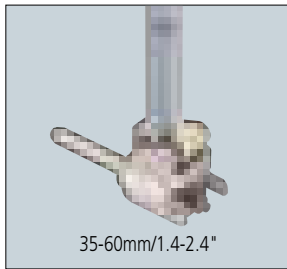
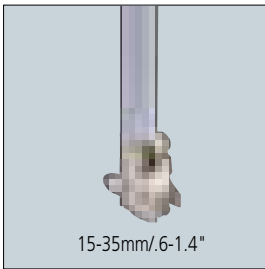

### DIMENSIONS

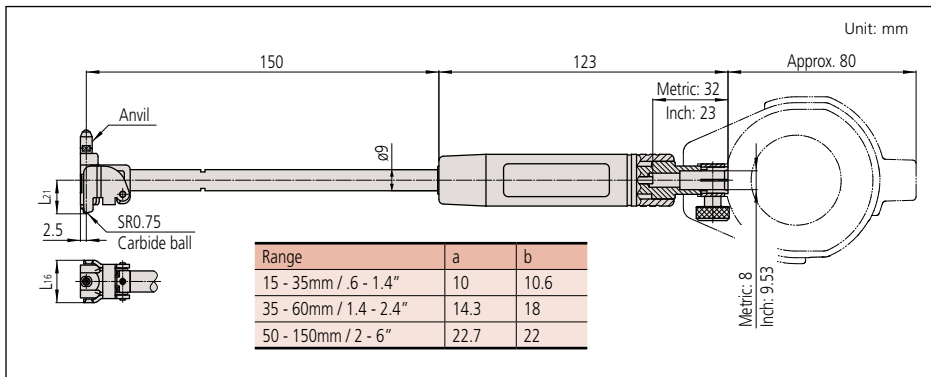

### Technical Data

Accuracy: 4 $\mu$ m/.00016"  
 Indication stability: 1 $\mu$ m/.0004"  
 Graduation: 0.01mm, 0.001mm, .0005" or .0001"

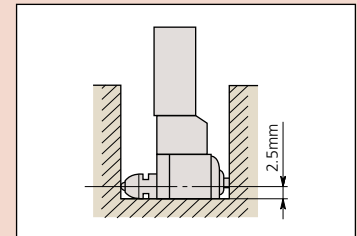

### Optional Accessories

-----: Setting ring (See page C-29.)



511-843

### Technical Data

Accuracy:  $2\mu\text{m} / .00008''$   
 Indication stability:  $1\mu\text{m} / .00004''$   
 Graduation: 0.01mm, 0.001mm, .0005" or .0001"

# Bore Gages

## SERIES 511 — with Micrometer Head

### FEATURES

- Interchangeable anvil is attached to a micrometer head for accurate dimensional setting.
- Wide measuring range with sub-anvils.
- Carbide ball contact point for durability.
- Extension rods (optional) can be attached for measuring deep holes.
- Optional setting rings offer the best method of zero-setting bore gages.

### SPECIFICATIONS

Inch		Gage Stem $\varnothing$ 3/8"			
Measuring Range	Order No. Without Indicator	Order No. With 2922SB Graduation .0005"	Order No. With 2923SB-10 Graduation .0001"	Mic Head Travel	Sub Anvil
2.4 - 4.0"	511-833*	511-843	511-853	.4"	.4", .8"
4.0 - 6.4"	511-834*	511-844	511-854	.5"	.4", .8", .8"
6.0 - 10"	511-835*	511-845	511-855	.5"	.4", .8", .8", 2"
10 - 16"	511-836*	511-846	511-856	1"	1", 2", 2"
16 - 24"	511-837*	511-847	511-857	2"	2", 4"
24 - 32"	511-838*	511-848	511-858	2"	2", 4"

\*Does not come with Dial Gage Protector Cover (21DZA000)

Metric		Gage Stem $\varnothing$ 8mm			
Measuring Range	Order No. Without Indicator	Order No. With 2046SB Graduation 0.01mm	Order No. With 2109SB-10 Graduation 0.001mm	Mic Head Travel	Sub Anvil
60 - 100mm	511-803*	511-813	511-823	10mm	10mm, 20mm
100 - 160mm	511-804*	511-814	511-824	13mm	10mm, 20mm, 20mm
150 - 250mm	511-805*	511-815	511-825	13mm	10mm, 20mm, 20mm, 50mm
250 - 400mm	511-806*	511-816	511-826	25mm	25mm, 50mm, 50mm
400 - 600mm	511-807*	511-817	511-827	50mm	50mm, 100mm
600 - 800mm	511-808*	511-818	511-828	50mm	50mm, 100mm

\*Does not come with Dial Gage Protector Cover (21DZA000)

### Optional Accessories

#### Extension rods

Bore Gage Measuring Range	Extension Length					Rod Diameter	Spanner
	4.92" 125mm	9.84" 250mm	19.69" 500mm	29.53" 750mm	39.37" 1000mm		
2.4-6.4" 60 - 160mm	953552	953553	953554	953555	953556	.47" 12mm	212556
6.0 - 32.0" 150-800mm	953557	952361	953558	953559	953560	.59" 15mm	212556

Note: Not available for 511-2XX Series.

## Contact Point

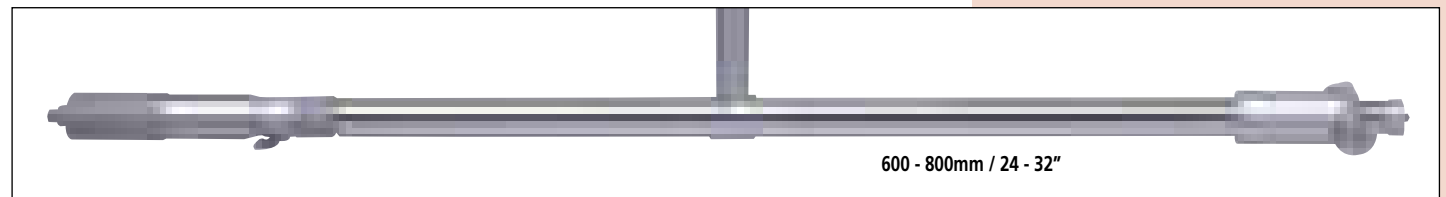
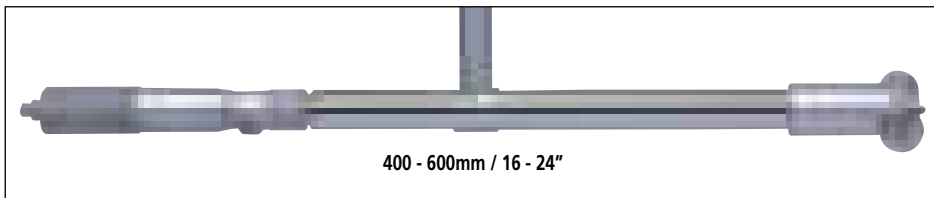
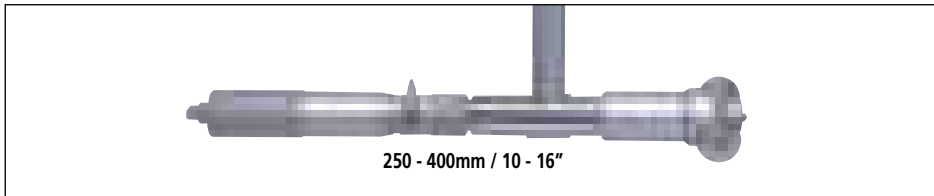
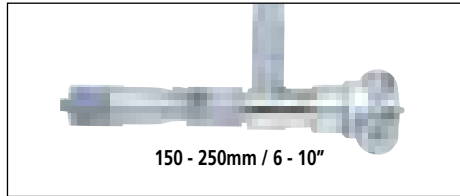
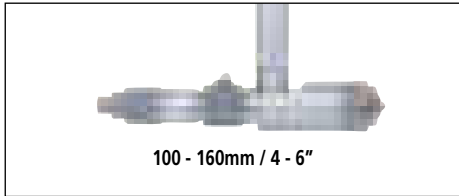
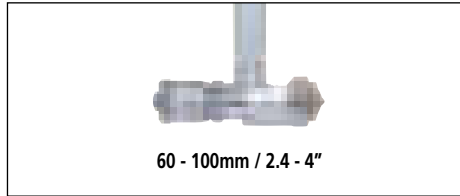
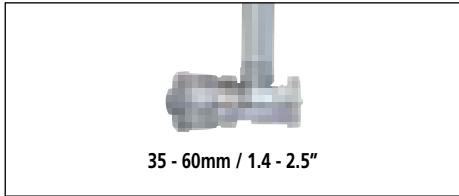

## DIMENSIONS

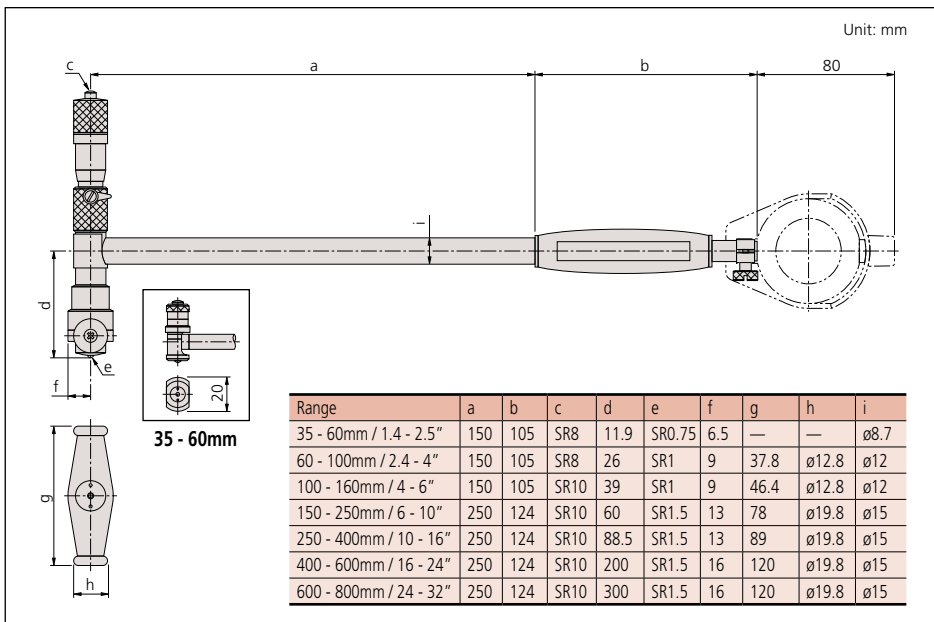



SPC

**ABSOLUTE**  
Absolute System Patented by MITUTOYO

**Technical Data**

Accuracy: Wide Range: 0.003mm / .00012"  
Resolution: .00005" / 0.001mm  
Display: LCD  
Battery: SR44 (1 pc.) (938882)  
Battery life: Approx. 9 months for normal use  
Dust/Water protection level: Conforming to IP53

**Functions**

Origin-set, Zero-Setting, Presetting, Power on/off, inch/mm conversion (inch/mm type only), Data output, go/no-go tolerance judgment  
Alarm: Low battery voltage, scale contamination, over-flow error, tolerance limit setting error

**Optional Accessories**

- 21DZA089: Extension rod 250 mm (10")
- 21DZA081: Extension rod 500 mm (20")
- 516-118-10: Origin setup metric rectangular gage block set
- 516-119-10: Origin setup metric square gage block set
- 516-120-26: GB calibration kit for series 511 bore gage. (9 pcs GB and plain jaw, 160mm holder)
- 905338: SPC cable (40" / 1m)
- 905409: SPC cable (80" / 2m)
- : Setting ring (See page C-29.)

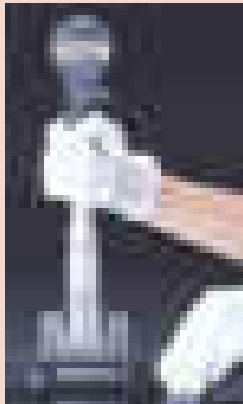

Origin setup gage block set

Example: using four extension rods.

# ABSOLUTE Digimatic Bore Gage

## SERIES 511

This ABSOLUTE Digimatic bore gage is exclusively designed for ID measurement.

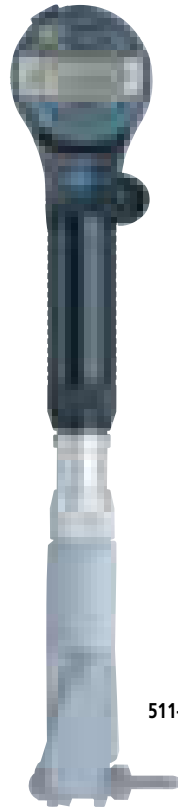

511-521

**FEATURES**

- The minimum value holding function provides the easy detection of hole diameter.



- Up to three sets of master value and upper/lower tolerance value can be memorized.
- An analog bar indicator is integrated to enhance the intuition in reading.
- Go/no-go judgment is performed by setting the upper and lower tolerances.
- Up to four rods (250mm or 500mm) can be used.

**SPECIFICATIONS**

Inch/Metric		
Range	Order No.	Probe depth
1.8 - 4" / 45 - 100mm	511-521	6" (152.4mm)
4 - 6.5" / 100 - 160mm	511-522	6" (152.4mm)

**DIMENSIONS AND MASS**

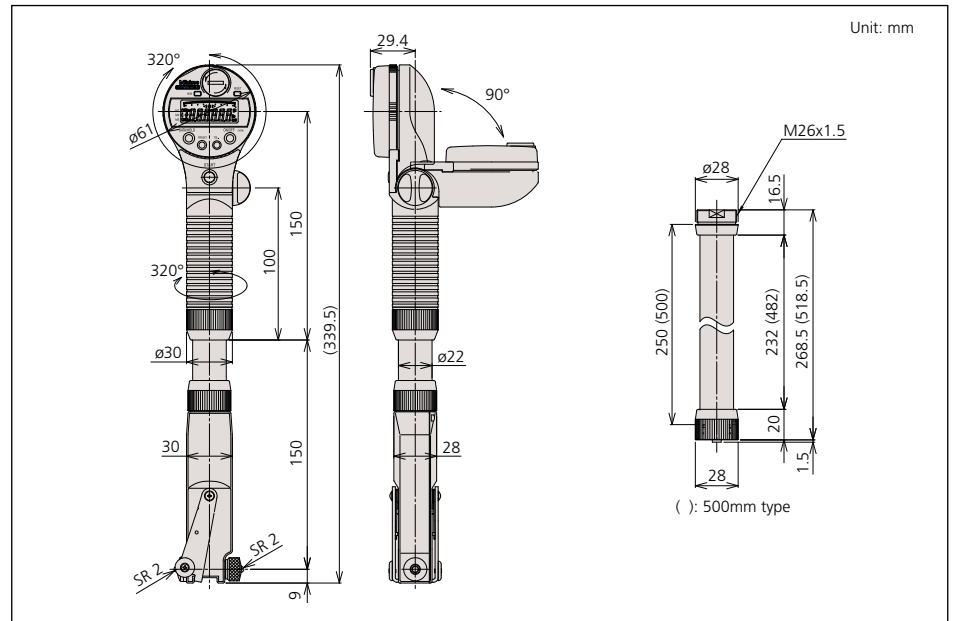

MASS: 500g

# Bore Gages

## SERIES 526 — for Extra Small Holes

These bore gages measure diameters of small holes. The radial displacement of split-ball contact is converted to axial displacement of measuring rod, which is shown on the dial indicator.

### FEATURES

- Optional stand (215-120-10) is available for efficient measurement of multiple small holes.

### SPECIFICATIONS

Metric		Gage Stem $\varnothing$ 8mm					
Measuring Range	Order No. Without Dial Gage	Order No. With 2046SB Graduation 0.01mm	Order No. With 2109SB-10 Graduation 0.001mm	Number of Anvils	Number of Needles	Probe depth (D)	Setting Rings
0.95-1.55mm	526-170-10*	526-173-10	526-172-10	5	1	11.5mm	-
0.95-1.55mm	526-170-11*	526-173-11	526-172-11	5	1	11.5mm	5
1.5-3.95mm	526-160-10*	526-163-10	526-162-10	9	2	17.5,22.5mm	-
1.5-3.95mm	526-160-11*	526-163-11	526-162-11	9	2	17.5,22.5mm	9
3.7-7.3mm	526-150-10*	526-153-10	526-152-10	7	1	32mm	-
3.7-7.3mm	526-150-11*	526-153-11	526-152-11	7	1	32mm	7
7 - 10mm	526-101*	526-126	526-124	6	1	56mm	
10 - 18mm	526-102*	526-127	526-125	8	1	62mm	

\*Does not come with Dial Gage Protector (21DZA000)

Inch		Gage Stem Dia .375"					
Measuring Range	Order No. Without Dial Gage	Order No. With 2922SB Graduation .0005"	Order No. With 2923SB-10 Graduation .0001"	Number of Anvils	Number of Needles	Probe depth (D)	Setting Rings
.037-.061"	526-175-10*	-	526-176-10	5	1	.453"	-
.037-.061"	526-175-11*	-	526-176-11	5	1	.453"	5
.059-.156"	526-165-10*	-	526-166-10	9	2	.689, .886"	-
.059-.156"	526-165-11*	-	526-166-11	9	2	.689, .886"	9
.146-.287"	526-155-10*	-	526-156-10	7	1	1.26"	-
.146-.287"	526-155-11*	-	526-156-11	7	1	1.26"	7
.3 - .4"	526-103*	526-119	526-122	6	1	2.2"	
.4 - .7"	526-104*	526-120	526-123	8	1	2.4"	

\*Does not come with Dial Gage Protector (21DZA000)

### DIMENSIONS

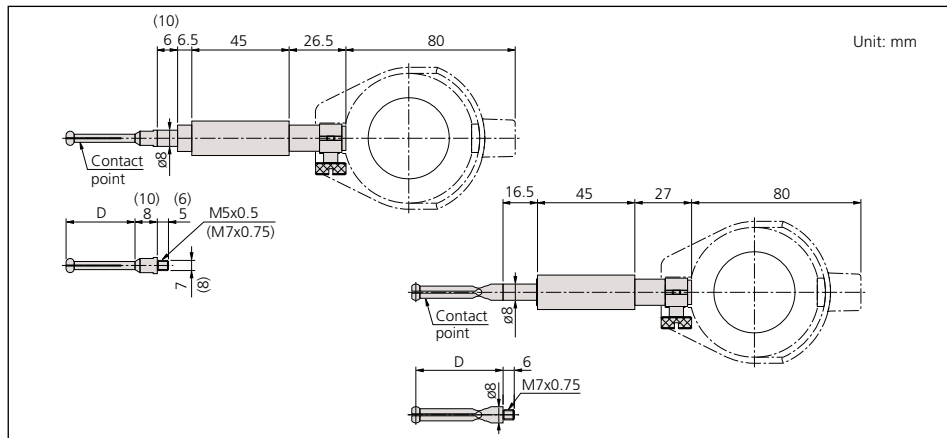

### DIAL FACES

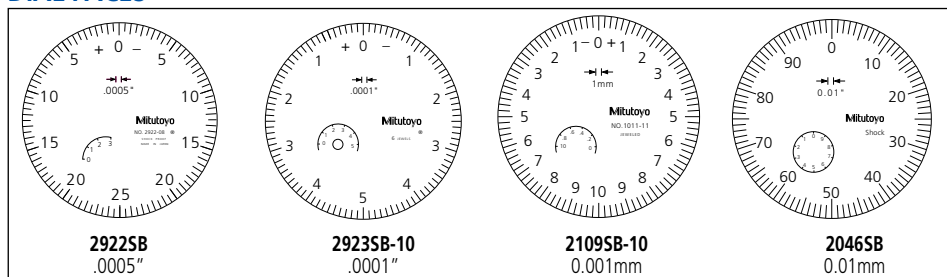

526-172

526-127

### Technical Data

Accuracy:  $4\mu\text{m} / .00016''$   
 Indication stability:  $2\mu\text{m} / .00008''$   
 Graduation: 0.01mm, 0.001mm, .0005" or .0001"

### Contact Point

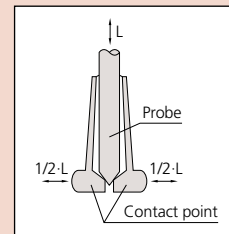

### Optional Accessory

215-120-10: Bore gage stand



----- : Setting ring (See page C-29.)



515-590

# Bore Gage Zero Checker

## SERIES 515

The Bore Gage Zero Checker allows easy zero adjustment of dial bore gages with ranges of 18mm (.7") through 400mm (16") using gage blocks.

### SPECIFICATIONS

Order No.	Applicable range
515-590	18 - 400mm (.7" - 16")

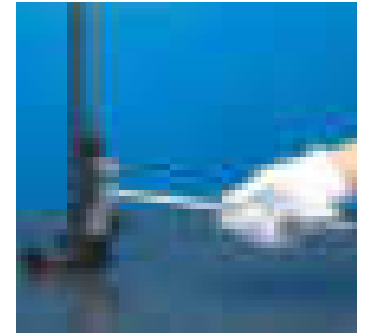

# Setting Rings

## SERIES 177 — Accessories for Inside Micrometers, Holtest and Dial Bore Gages

### FEATURES

- Used for quick and accurate setting of dial bore gages, Holtest and inside micrometers.
- If a setting ring of an optimal size is prepared, it can be used for calibration.

### How to read the indicated value

Series 526

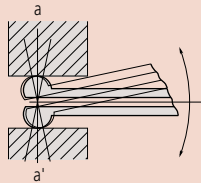

The 526 series has a gage head with high curvature. Alignment with the diameter (a-a') is achieved by rotating the gage head in the direction indicated by the arrow, and the reading is the maximum value read from the dial indicator.

Series 511

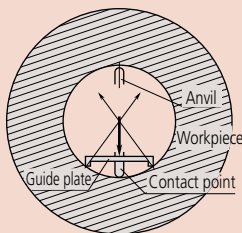

The 511 series provides a guide plate to align the setting ring diameter with the measurement axis of the bore gage.

### Steel Setting Rings



### Ceramic Setting Rings

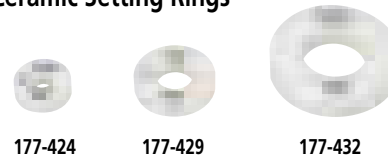

### DIMENSIONS

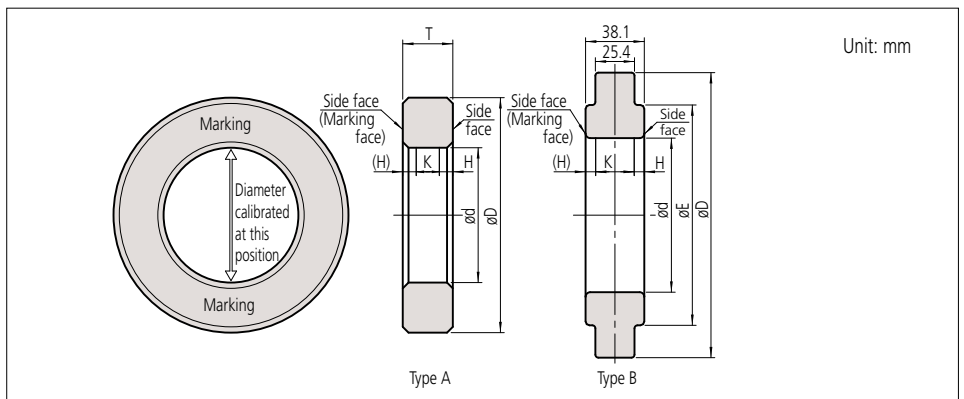





# D

## Small Tool Instruments Calipers Height Gages Depth Gages



**Digimatic Caliper**



**Digimatic Height Gages**

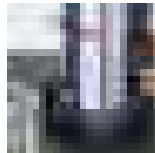

**Linear Height**



**Depth Gages**

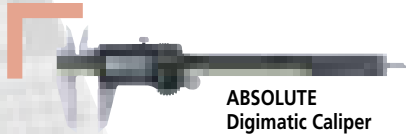

**ABSOLUTE  
Digimatic Caliper**

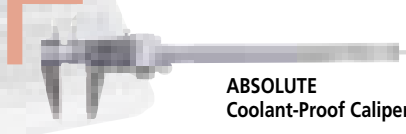

**ABSOLUTE  
Coolant-Proof Caliper**

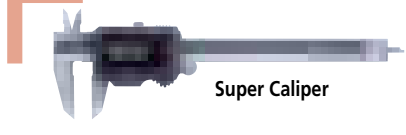

**Super Caliper**



**Digimatic Height  
Gage**

### INDEX

#### Calipers

Super Caliper-Solar Powered	D-2
ABSOLUTE Solar Caliper	D-3
ABSOLUTE Coolant-Proof Caliper	D-4,5
ABSOLUTE Digimatic Caliper	D-6,7
Dial Caliper	D-8,9
Vernier Caliper	D-10-14
ABSOLUTE Digimatic & Vernier Caliper	D-15
Long-Jaw Vernier Caliper	D-16
ABSOLUTE Digimatic Caliper	D-17
Digimatic Carbon-Fiber Caliper	D-18,19
ABSOLUTE Coolant-Proof Carbon-Fiber Caliper	D-20
ABSOLUTE Back-Jaw Centerline Caliper	D-21
Offset Caliper	D-22
Offset Centerline Caliper	D-23
Point Caliper	D-24
Blade-Type Caliper	D-25
Neck Caliper	D-26
Tube Thickness Caliper	D-27
ABSOLUTE Low-Force Caliper	D-28
ABSOLUTE Snap Caliper	D-28
Scribing Caliper	D-29
ABSOLUTE Inside Caliper	D-30,31
MyCAL-Lite	D-32
Center-Line Gage	D-33
Depth Base Attachment	D-33
Quick Guide to Precision Measuring Instruments - Calipers	D-34,35

#### Digimatic Height Gages

Linear Height LH-600E	D-36,37
QM-Height	D-38,39
Digimatic Height Gage	D-40,41
Dial Height Gage	D-42
ABSOLUTE Digimatic Height Gage	D-43,44
Vernier Height Gage	D-45,46
Carbide-Tipped Scriber	D-47
Optional Accessories for Height Gages	D-47
Quick Guide to Precision Measuring Instruments - Height Gages	D-48
CERA Caliper Checker	D-49

#### Depth Gages

Depth Micrometer	D-50,51
Depth Micro Checker	D-51
ABSOLUTE Digimatic Depth Gage	D-52
Tire-Tread Depth Gage	D-53
ABSOLUTE Point-Type Digimatic Depth Gage	D-53
Vernier Depth Gage	D-54,55
ABSOLUTE Digimatic Depth Gage	D-55
Dial-Depth Gage	D-56
Extension Bases	D-56
ABSOLUTE Digimatic/Dial Depth Gage	D-57,58

# Super Caliper–Solar Powered

**SERIES 500 — No battery or origin reset needed for IP67 Digital Caliper**



## FEATURES

- With no annoying origin restoration necessary, a measurement can be started at any time and without restrictions on operating speed.

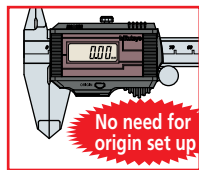
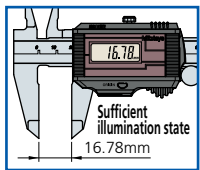
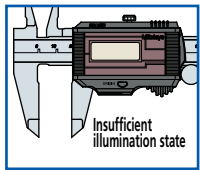

- This unique\* eco-friendly solar-powered Super Caliper requires no battery.  
\*According to Mitutoyo investigation in January, 2005
- The impact resistance of the display unit has been increased for improved usability in workshop conditions.
- IP67 protection ensures waterproof reliability.
- This Super Caliper uses components that do not contain harmful substances and is compatible with RoHS Directives.
- Supplied in fitted plastic case.

### Improvement in surface finish of beam

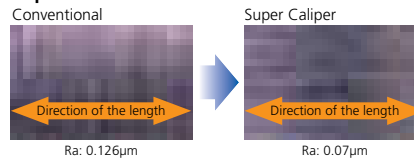

500-784

## SPECIFICATIONS

Metric			
Range	Order No.	Accuracy	Resolution
0 - 150mm	<b>500-776</b>	±0.02mm	0.01mm
0 - 150mm	<b>500-774*</b>	±0.02mm	0.01mm
0 - 200mm	<b>500-777</b>	±0.02mm	0.01mm
0 - 200mm	<b>500-775*</b>	±0.02mm	0.01mm

\*Without SPC data output

Inch/Metric			
Range	Order No.	Accuracy	Resolution
0 - 6" / 0 - 150mm	<b>500-786</b>	±.001"	.0005" / 0.01mm
0 - 6" / 0 - 150mm	<b>500-784*</b>	±.001"	.0005" / 0.01mm
0 - 8" / 0 - 200mm	<b>500-787</b>	±.001"	.0005" / 0.01mm
0 - 8" / 0 - 200mm	<b>500-785*</b>	±.001"	.0005" / 0.01mm

\*Without SPC data output

## DIMENSIONS AND MASS

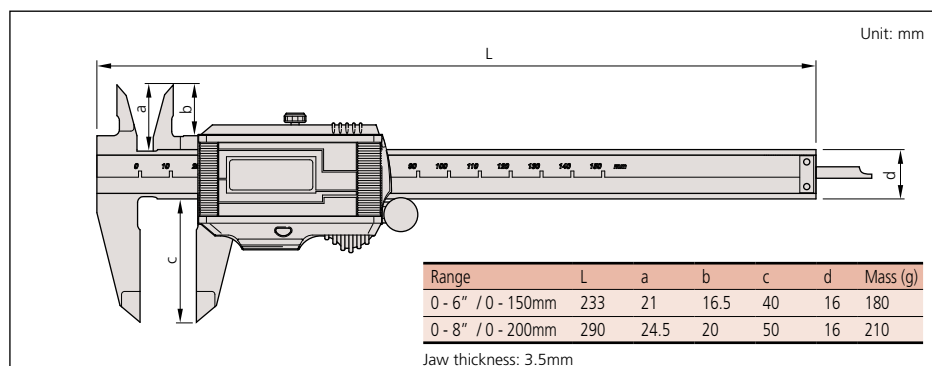

## Technical Data

Accuracy: Refer to the list of specifications  
 Resolution: .0005" / 0.01mm or 0.01mm  
 Repeatability: .0005" / 0.01mm  
 Display: LCD  
 Length standard: ABSOLUTE electromagnetic induction linear encoder  
 Max. response speed: Unlimited  
 Battery: Solar cell\*  
 Dust/Water protection level: IP67  
 \*Can be used continuously above 60 lux ambient illumination.

## Function

Origin-set, inch/mm conversion (on inch/metric models only)  
 Alarm: Counting value composition error

## Optional Accessories

- 05CZA624:** SPC cable with data switch (40" / 1m)
- 05CZA625:** SPC cable with data switch (80" / 2m)

## IP67 protection level

- Level 6: Dust-tight  
No ingress of dust.
- Level 7: Protected against the effects of temporary immersion in water.  
Ingress of water in quantities causing harmful effects shall not be possible when the enclosure is temporarily immersed 1 meter in water under standardized conditions of pressure and time (30 min.).

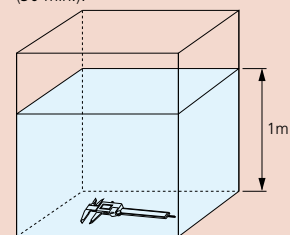

## About the charge function (Super Caliper)

The minimum illumination required in the uncharged state is 60 lux. As shown in the table, JIS Z 9110 Artificial Illumination Intensity Standard, this Super Caliper can be used without problems in a normal work environment.

The charge function allows the operator to use this Super Caliper without interrupting work even if the ambient illumination is temporarily insufficient.

- In the fully charged state, this Super Caliper can operate for approximately an hour in an environment of 50lux illumination (less than the minimum necessary illumination intensity).
- The time necessary for full charge differs, depending on the charging conditions. If this Super Caliper is left unused in an illumination of 500 lux (usual for manufacturing environments), it takes approximately one hour to reach full charge.

# ABSOLUTE Solar Caliper

**SERIES 500 — No battery or origin reset needed**

Mitutoyo's Absolute Solar Digimatic Caliper retains its origin point for the entire life of the caliper, even the display turns off. At 60 Lux and higher, the ABSOLUTE solar caliper is turned on ready to start measurement.

## FEATURES

- No more repeated zero setting caused by low-light intensity.
- Hard-coated solar panel for increased durability.
- No fear for overspeed errors.
- With thumb roller.
- Supplied in fitted plastic case.



500-474

## Technical Data

Accuracy: Refer to the list of specifications  
 Resolution: .0005"/0.01mm or 0.01mm  
 Repeatability: .0005" / 0.01mm  
 Display: LCD  
 Length standard: ABSOLUTE electrostatic capacitance type linear encoder  
 Max. response speed: Unlimited  
 Battery: Solar cell\*  
 \*Can be used continuously above 60 lux ambient illumination.

## Function

Origin-set, Data hold, Data output, inch/mm conversion (on inch/metric models only)  
 Alarm: Counting value composition error

## Optional Accessories

**959143:** Data hold unit (SPC output model only)  
**959149:** SPC cable with data switch (40" / 1m)  
**959150:** SPC cable with data switch (80" / 2m)

## SPECIFICATIONS

### Metric

Range	Order No.	Accuracy	Resolution	Remarks
0 - 100mm	<b>500-443</b>	±0.02mm	0.01mm	ø1.9mm round depth bar
0 - 100mm	<b>500-453*</b>	±0.02mm	0.01mm	ø1.9mm round depth bar
0 - 150mm	<b>500-444</b>	±0.02mm	0.01mm	
0 - 150mm	<b>500-454*</b>	±0.02mm	0.01mm	
0 - 200mm	<b>500-445</b>	±0.02mm	0.01mm	
0 - 200mm	<b>500-455*</b>	±0.02mm	0.01mm	

\*without SPC data output

### Inch/Metric

Range	Order No.	Accuracy	Resolution	Remarks
0 - 4" / 0 - 100mm	<b>500-463</b>	±.001"	.0005" / 0.01mm	.075" round depth bar
0 - 4" / 0 - 100mm	<b>500-473*</b>	±.001"	.0005" / 0.01mm	.075" round depth bar
0 - 6" / 0 - 150mm	<b>500-464</b>	±.001"	.0005" / 0.01mm	
0 - 6" / 0 - 150mm	<b>500-474*</b>	±.001"	.0005" / 0.01mm	
0 - 8" / 0 - 200mm	<b>500-465</b>	±.001"	.0005" / 0.01mm	
0 - 8" / 0 - 200mm	<b>500-475*</b>	±.001"	.0005" / 0.01mm	

\*without SPC data output

## DIMENSIONS AND MASS

Unit: mm

Range	L	a	b	c	Mass (g)
0 - 4" / 0 - 100mm	182	40	21	16.5	125
0 - 6" / 0 - 150mm	233	40	21	16.5	150
0 - 8" / 0 - 200mm	290	50	24.5	20	180

# ABSOLUTE Coolant-Proof Caliper

**SERIES 500 — with Dust/Water Protection Conforming to IP67 Level**

## FEATURES

- Can be used in workshop conditions exposed to coolant, water, dust or oil.
- Easy to use - no need to wipe or clean the scale.
- Advanced design.
- Character height increased from 7.4mm to 9.0mm for improved readability.
- Redesigned battery cover eliminates the need for a screwdriver.
- Incorporates absolute measurement system.
- Automatic power-on/off.
- Data output function.
- With thumb roller.
- Supplied in fitted plastic case.

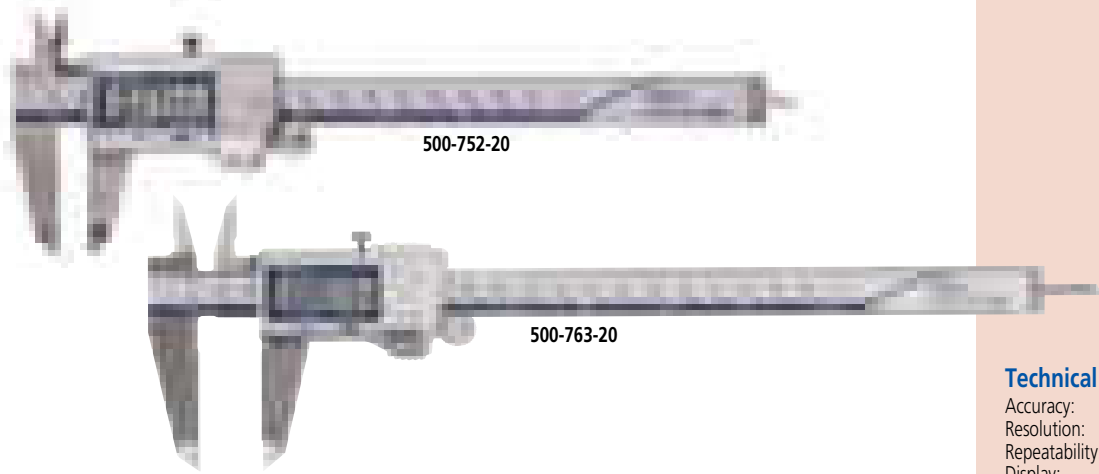

## COOLANT PROOF™ IP67

COOLANT PROOF is the universal term of Mitutoyo Digimatic Small Tool Instruments that are free from measurement error and physical deterioration due to routine exposure to water, cutting oil or coolant. This high performance is achieved by using encoders that are inherently immune to contamination, where exposure is inevitable, combined with comprehensive sealing techniques and extremely oil-resistant materials to guarantee a long working life under normal operating conditions.



**Built-in ABS (absolute) scale means that these calipers are ready to use immediately after power-on without origin resetting. It's as easy as vernier caliper measurements.**

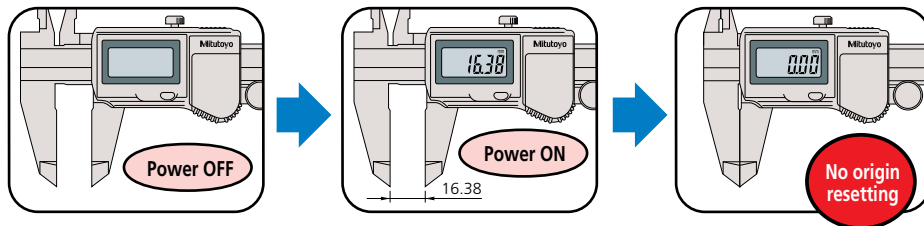

Certificate of inspection

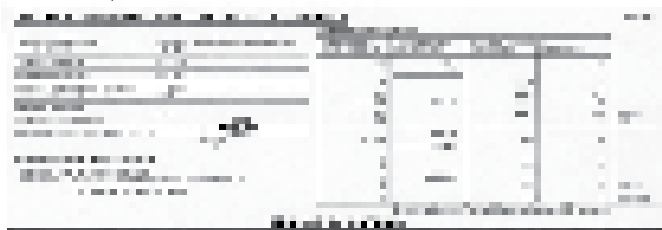

## Technical Data

Accuracy: Refer to the list of specifications  
 Resolution: .0005"/0.01mm or 0.01mm  
 Repeatability: .0005" / 0.01mm  
 Display: LCD  
 Length standard: ABSOLUTE electromagnetic induction linear encoder  
 Max. response speed: Unlimited  
 Battery: SR44 (1 pc./2 pcs\*), **938882**  
 Battery life: Approx. 5 years under normal use  
 (1 year: over 12" / 300mm models)  
 Dust/Water protection level: IP67  
 \*0 - 300mm model

## Function

Origin-set, Zero-setting, Automatic power on/off, Data output, inch/mm conversion (on inch/metric models only)  
 Alarm: Low voltage, Counting value composition error

## Optional Accessories

- 05CZA624:** SPC cable with data switch (40" / 1m)
- 05CZA625:** SPC cable with data switch (80" / 2m)



05CZA624



Measurement data output function is available with a water-resistant SPC cable.

## Air leakage detection system used for water-proof testing

Generally, air leakage tests are performed to evaluate water resistance. Testing begins by placing a measuring tool into the capsule. Next, air with equivalent pressure is supplied to the capsule and the master, then the valves are closed. If none of the air in the capsule seeps into the measuring tool, the capsule's air pressure will remain equal to that of the master, and the differential pressure gage will continue to point to the center. However, if some air seeps into the measuring tool, it will create an air pressure difference in the amount indicated by the differential pressure gage. Thus, detection of air pressure differences is used as a criterion for judging leakage. Every single unit of the ABS Coolant Proof calipers and Coolant Proof micrometer is tested this way for air leakage to help ensure product quality.

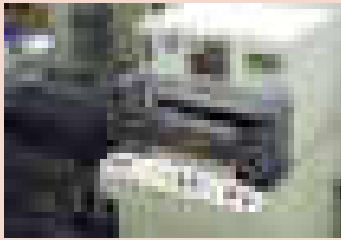
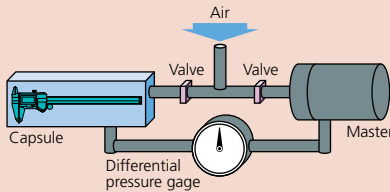

## IP67 protection level

- Level 6: Dust-tight  
No ingress of dust.
- Level 7: Protected against the effects of temporary immersion in water.  
Ingress of water in quantities causing harmful effects shall not be possible when the enclosure is temporarily immersed 1 meter in water under standardized conditions of pressure and time (30 min.).

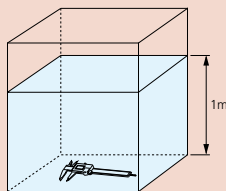

## SPECIFICATIONS

### Metric IP67 model

Range	Order No.	Accuracy	Resolution	Remarks
0-150mm	<b>500-702-20*</b>	+/-0.02mm	0.01mm	
0-150mm	<b>500-712-20</b>	+/-0.02mm	0.01mm	
0-150mm	<b>500-719-20</b>	+/-0.02mm	0.01mm	dia. 1.9mm rod depth bar
0-150mm	<b>500-721-20</b>	+/-0.02mm	0.01mm	carbide-tipped jaws for ID measurement
0-150mm	<b>500-723-20</b>	+/-0.02mm	0.01mm	carbide-tipped jaws for OD & ID measurement
0-200mm	<b>500-703-20*</b>	+/-0.02mm	0.01mm	
0-200mm	<b>500-713-20</b>	+/-0.02mm	0.01mm	
0-200mm	<b>500-722-20</b>	+/-0.02mm	0.01mm	carbide-tipped jaws for ID measurement
0-200mm	<b>500-724-20</b>	+/-0.02mm	0.01mm	carbide-tipped jaws for OD & ID measurement
0-300mm	<b>500-704-10*</b>	+/-0.03mm	0.01mm	
0-300mm	<b>500-714-10</b>	+/-0.03mm	0.01mm	

\*without SPC data output

### Inch/Metric IP67 model

Range	Order No.	Accuracy	Resolution	Remarks
0-6" / 0-150mm	<b>500-752-20*</b>	+/- .001"	.0005" / 0.01mm	
0-6" / 0-150mm	<b>500-762-20</b>	+/- .001"	.0005" / 0.01mm	
0-6" / 0-150mm	<b>500-768-20*</b>	+/- .001"	.0005" / 0.01mm	.075" rod depth bar
0-6" / 0-150mm	<b>500-769-20</b>	+/- .001"	.0005" / 0.01mm	.075" rod depth bar
0-6" / 0-150mm	<b>500-731-20*</b>	+/- .001"	.0005" / 0.01mm	carbide-tipped jaws for OD measurement
0-6" / 0-150mm	<b>500-735-20</b>	+/- .001"	.0005" / 0.01mm	carbide-tipped jaws for OD measurement
0-6" / 0-150mm	<b>500-733-20*</b>	+/- .001"	.0005" / 0.01mm	carbide-tipped jaws for OD & ID measurement
0-6" / 0-150mm	<b>500-737-20</b>	+/- .001"	.0005" / 0.01mm	carbide-tipped jaws for OD & ID measurement
0-8" / 0-200mm	<b>500-753-20*</b>	+/- .001"	.0005" / 0.01mm	
0-8" / 0-200mm	<b>500-763-20</b>	+/- .001"	.0005" / 0.01mm	
0-8" / 0-200mm	<b>500-732-20*</b>	+/- .001"	.0005" / 0.01mm	carbide-tipped jaws for OD measurement
0-8" / 0-200mm	<b>500-736-20</b>	+/- .001"	.0005" / 0.01mm	carbide-tipped jaws for OD measurement
0-8" / 0-200mm	<b>500-734-20*</b>	+/- .001"	.0005" / 0.01mm	carbide-tipped jaws for OD & ID measurement
0-8" / 0-200mm	<b>500-738-20</b>	+/- .001"	.0005" / 0.01mm	carbide-tipped jaws for OD & ID measurement
0-12" / 0-300mm	<b>500-754-10*</b>	+/- .0015"	.0005" / 0.01mm	
0-12" / 0-300mm	<b>500-764-10</b>	+/- .0015"	.0005" / 0.01mm	

\*without SPC data output

## DIMENSIONS AND MASS

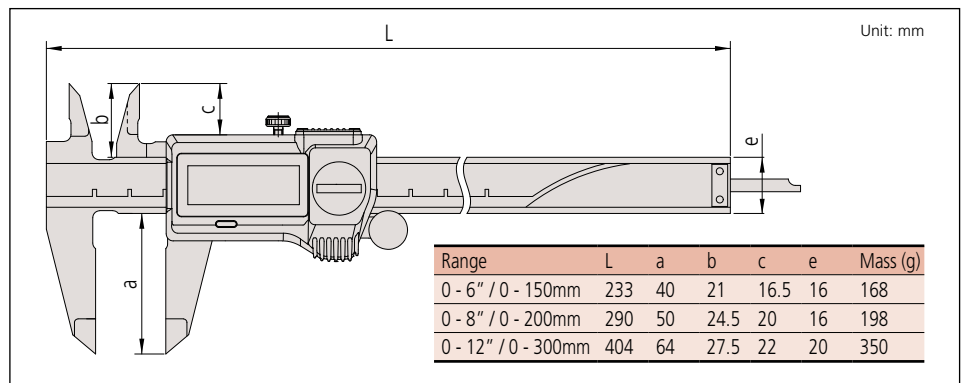

# ABSOLUTE Digimatic Caliper

**SERIES 500 — with Exclusive ABSOLUTE Encoder Technology**

Mitutoyo's absolute Digimatic Caliper is the next generation of electronic calipers. It keeps track of its origin point once set. Whenever turned on, the large LCD displays the actual slider position ready to start measurement. No more repeated zero setting is necessary with the absolute encoder technology, as well as no more concern for overspeed errors.

**High-quality guide surface finish for smooth slider movement.**

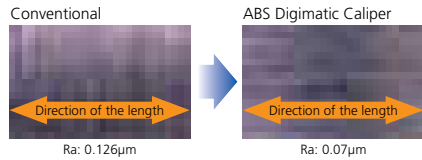

## FEATURES

- Large and clear LCD readout.
- The ZERO/ABS key allows the display to be zero-set at any slider position along the scale for incremental comparison measurements. This switch also will allow return to the absolute (ABS) coordinate and display of the true position from the origin point (usually jaws-closed point).
- Data Hold Unit (959143) is optional.
- Carbide-tipped jaw-type calipers are also available.
- Thumb roller included only on calipers up to and including 12" or 300mm.
- Supplied in fitted plastic case. Except 40" / 1000mm supplied in wooden case.

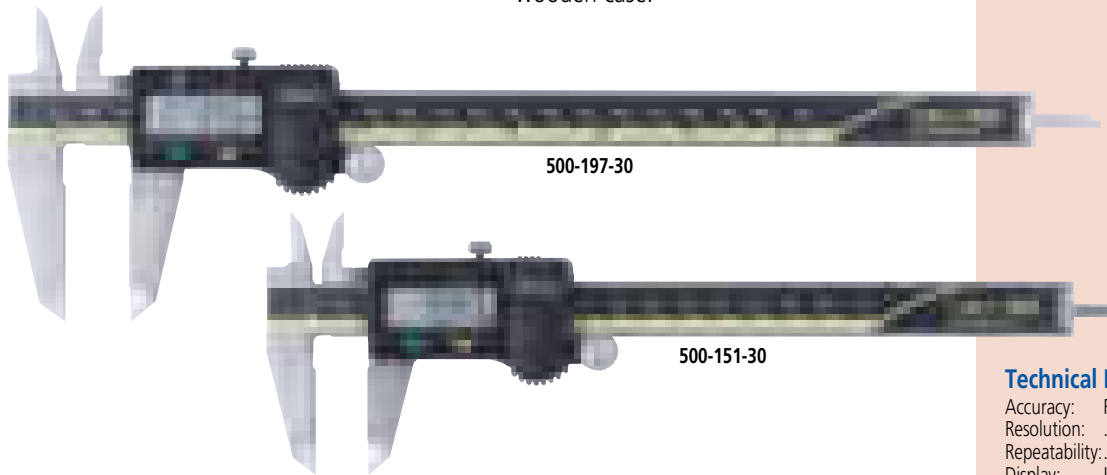

The new Mitutoyo ABS Digimatic Caliper line with exclusive AOS sensor technology. The patented Advanced Onsite Sensor (AOS) offers improved measurement dependability by increasing resistance to harsh workshop conditions.

## DIMENSIONS AND MASS

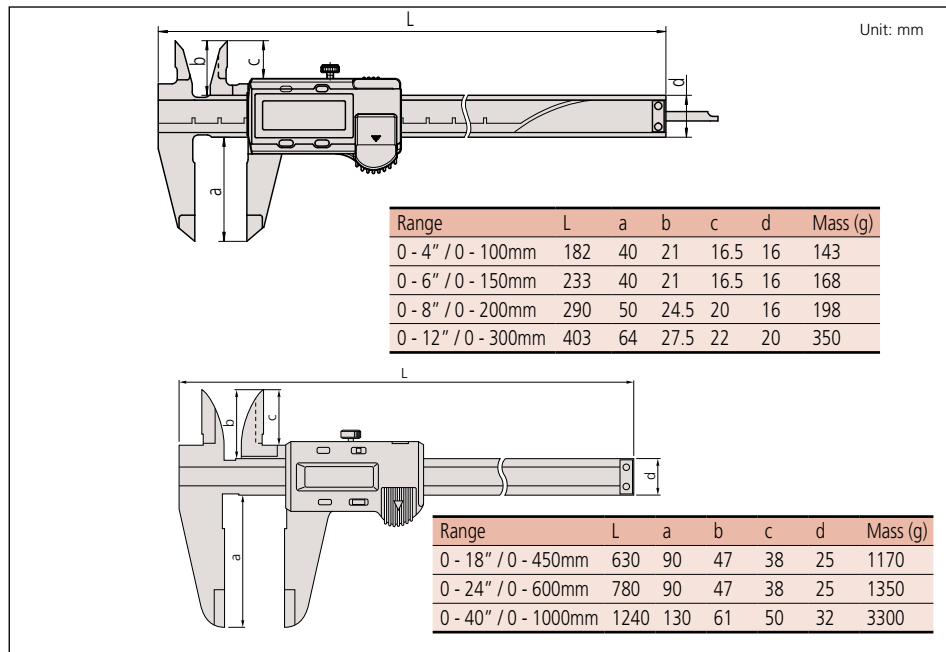

## Technical Data

Accuracy: Refer to the list of specifications  
 Resolution: .0005"/0.01mm or 0.01mm  
 Repeatability: .0005"/0.01mm  
 Display: LCD  
 Length standard:  
 ABSOLUTE electromagnetic induction type linear encoder (200mm and smaller models)  
 ABSOLUTE electrostatic capacitance type linear encoder (300mm and larger models)  
 Max. response speed: Unlimited  
 Battery: SR44 (1 pc.), **938882**  
 Battery life: Approx. 3.5 years under normal use

## Function

Origin-set, Zero-setting, Data output, inch/mm conversion (on inch/metric models only)  
 Alarm: Low voltage, Counting value composition error

## Optional Accessories

- 959143:** Data hold unit
- 959149:** SPC cable with data switch (40" / 1m)
- 959150:** SPC cable with data switch (80" / 2m)

**959143**



**959149**



500-506-10

500-502-10

500-501-10

500-500-10

## SPECIFICATIONS

### Metric

Range	Order No.	Accuracy	Resolution	Remarks
0 - 100mm	<b>500-150-30</b>	±0.02mm	0.01mm	ø1.9mm rod depth bar
0 - 150mm	<b>500-151-30</b>	±0.02mm	0.01mm	—
0 - 150mm	<b>500-154-30</b>	±0.02mm	0.01mm	Carbide-tipped jaws for OD measurement
0 - 150mm	<b>500-155-30</b>	±0.02mm	0.01mm	Carbide-tipped jaws for OD & ID measurement
0 - 150mm	<b>500-158-30</b>	±0.02mm	0.01mm	ø1.9mm rod depth bar
0 - 200mm	<b>500-152-30</b>	±0.02mm	0.01mm	—
0 - 200mm	<b>500-156-30</b>	±0.02mm	0.01mm	Carbide-tipped jaws for OD measurement
0 - 200mm	<b>500-157-30</b>	±0.02mm	0.01mm	Carbide-tipped jaws for OD & ID measurement
0 - 300mm	<b>500-153</b>	±0.03mm	0.01mm	—
0 - 450mm	<b>500-500-10</b>	±0.05mm	0.01mm	Without Thumb Roller
0 - 600mm	<b>500-501-10</b>	±0.05mm	0.01mm	Without Thumb Roller
0 - 1000mm	<b>500-502-10</b>	±0.07mm	0.01mm	Without Thumb Roller

### Inch/Metric

Range	Order No.	Accuracy	Resolution	Remarks
0 - 4" / 0 - 100mm	<b>500-170-30</b>	±.001"	.0005" / 0.01mm	.075" rod depth bar
0 - 4" / 0 - 100mm	<b>500-195-30*</b>	±.001"	.0005" / 0.01mm	.075" rod depth bar
0 - 6" / 0 - 150mm	<b>500-171-30</b>	±.001"	.0005" / 0.01mm	—
0 - 6" / 0 - 150mm	<b>500-174-30</b>	±.001"	.0005" / 0.01mm	Carbide-tipped jaws for OD measurement
0 - 6" / 0 - 150mm	<b>500-175-30</b>	±.001"	.0005" / 0.01mm	Carbide-tipped jaws for OD & ID measurement
0 - 6" / 0 - 150mm	<b>500-178-30</b>	±.001"	.0005" / 0.01mm	.075" rod depth bar
0 - 6" / 0 - 150mm	<b>500-196-30*</b>	±.001"	.0005" / 0.01mm	—
0 - 6" / 0 - 150mm	<b>500-159-30*</b>	±.001"	.0005" / 0.01mm	Carbide-tipped jaws for OD measurement
0 - 6" / 0 - 150mm	<b>500-160-30*</b>	±.001"	.0005" / 0.01mm	Carbide-tipped jaws for OD & ID measurement
0 - 8" / 0 - 200mm	<b>500-172-30</b>	±.001"	.0005" / 0.01mm	—
0 - 8" / 0 - 200mm	<b>500-176-30</b>	±.001"	.0005" / 0.01mm	Carbide-tipped jaws for OD measurement
0 - 8" / 0 - 200mm	<b>500-177-30</b>	±.001"	.0005" / 0.01mm	Carbide-tipped jaws for OD & ID measurement
0 - 8" / 0 - 200mm	<b>500-197-30*</b>	±.001"	.0005" / 0.01mm	—
0 - 8" / 0 - 200mm	<b>500-163-30*</b>	±.001"	.0005" / 0.01mm	Carbide-tipped jaws for OD measurement
0 - 8" / 0 - 200mm	<b>500-164-30*</b>	±.001"	.0005" / 0.01mm	Carbide-tipped jaws for OD & ID measurement
0 - 12" / 0 - 300mm	<b>500-173</b>	±.0015"	.0005" / 0.01mm	—
0 - 12" / 0 - 300mm	<b>500-167</b>	±.0015"	.0005" / 0.01mm	Carbide-tipped jaws for OD measurement
0 - 12" / 0 - 300mm	<b>500-168</b>	±.0015"	.0005" / 0.01mm	Carbide-tipped jaws for OD & ID measurement
0 - 12" / 0 - 300mm	<b>500-193*</b>	±.0015"	.0005" / 0.01mm	—
0 - 12" / 0 - 300mm	<b>500-165*</b>	±.0015"	.0005" / 0.01mm	Carbide-tipped jaws for OD measurement
0 - 12" / 0 - 300mm	<b>500-166*</b>	±.0015"	.0005" / 0.01mm	Carbide-tipped jaws for OD & ID measurement
0 - 18" / 0 - 450mm	<b>500-505-10</b>	±.002"	.0005" / 0.01mm	Without Thumb Roller
0 - 24" / 0 - 600mm	<b>500-506-10</b>	±.002"	.0005" / 0.01mm	Without Thumb Roller
0 - 40" / 0 - 1000mm	<b>500-507-10</b>	±.003"	.0005" / 0.01mm	Without Thumb Roller

\*without SPC data output

# Dial Caliper

## SERIES 505

### FEATURES

- New designed dial movement for ultra-smooth sliding and high-shock protection.
- Improved finish on sliding surfaces for longevity.
- New face for improved readability.
- Lock screw for dial bezel and for holding the sliding jaw position.
- Can measure OD, ID, depth and steps.
- Models available with carbide-tipped OD and ID jaws.
- Supplied in fitted plastic case.

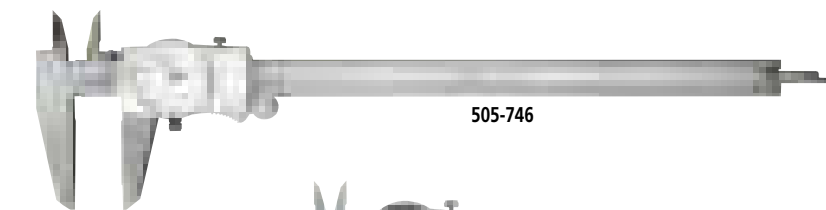

505-746

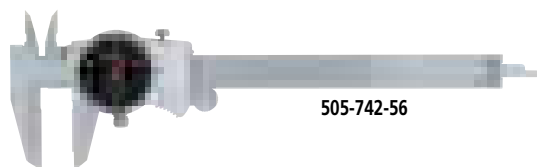

505-742-56

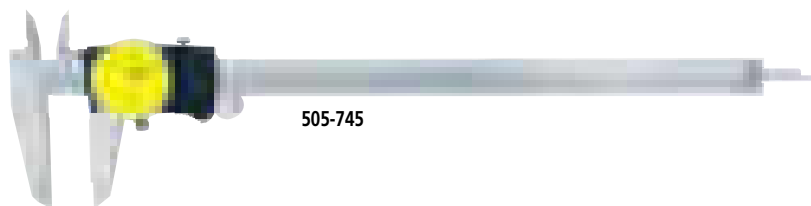

505-745

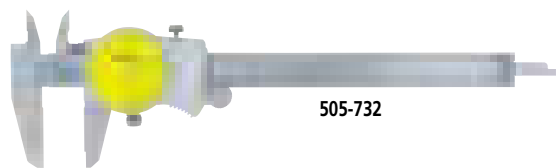

505-732



.100" per revolution



.200" per revolution



1mm per revolution



2mm per revolution

### SPECIFICATIONS

**Metric** 1mm Per One Revolution

Range	Order No.	Accuracy	Graduation	Remarks
0-150mm	<b>505-732</b>	+/-0.03mm	0.01mm	—
0-200mm	<b>505-733</b>	+/-0.03mm	0.01mm	—

**Metric** 2mm Per One Revolution

Range	Order No.	Accuracy	Graduation	Remarks
0-150mm	<b>505-730</b>	+/-0.03mm	0.02mm	—
0-150mm	<b>505-734</b>	+/-0.03mm	0.02mm	Carbide-tipped jaws for OD measurement
0-150mm	<b>505-735</b>	+/-0.03mm	0.02mm	Carbide-tipped jaws for OD & ID measurement
0-200mm	<b>505-731</b>	+/-0.03mm	0.02mm	—
0-300mm	<b>505-745</b>	+/-0.04mm	0.02mm	—



## Measurement Applications



1. Outside measurement

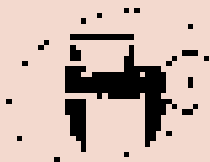

2. Inside measurement

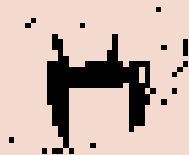

3. Step measurement

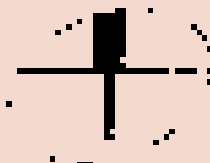

4. Depth measurement

## SPECIFICATIONS

**Inch** .1" Per Revolution

Range	Order No.	Accuracy	Graduation	Remarks
0-6"	<b>505-742</b>	+/- .001"	.001"	-
0-6"	<b>505-742-51</b>	+/- .001"	.001"	Blue Dial Face
0-6"	<b>505-742-52</b>	+/- .001"	.001"	Purple Dial Face
0-6"	<b>505-742-53</b>	+/- .001"	.001"	Green Dial Face
0-6"	<b>505-742-54</b>	+/- .001"	.001"	Red Dial Face
0-6"	<b>505-742-55</b>	+/- .001"	.001"	Orange Dial Face
0-6"	<b>505-742-56</b>	+/- .001"	.001"	Black Dial Face
0-6"	<b>505-736</b>	+/- .001"	.001"	Carbide-tipped jaws for OD measurement
0-6"	<b>505-738</b>	+/- .001"	.001"	Carbide-tipped jaws for OD & ID measurement
0-8"	<b>505-743</b>	+/- .002"	.001"	-
0-8"	<b>505-737</b>	+/- .002"	.001"	Carbide-tipped jaws for OD measurement
0-8"	<b>505-739</b>	+/- .002"	.001"	Carbide-tipped jaws for OD & ID measurement
0-12"	<b>505-746</b>	+/- .002"	.001"	—
0-12"	<b>505-747</b>	+/- .002"	.001"	Carbide-tipped jaws for OD measurement
0-12"	<b>505-748</b>	+/- .002"	.001"	Carbide-tipped jaws for OD & ID

**Inch** .2" Per Revolution

Range	Order No.	Accuracy	Graduation	Remarks
0-6"	<b>505-740</b>	+/- .001"	.001"	—
0-6"	<b>505-744</b>	+/- .001"	.001"	Carbide-tipped jaws for OD measurement
0-8"	<b>505-741</b>	+/- .002"	.001"	—
0-12"	<b>505-749</b>	+/- .002"	.001"	—
0-12"	<b>505-750</b>	+/- .002"	.001"	Carbide-tipped jaws for OD measurement

## DIMENSIONS AND MASS

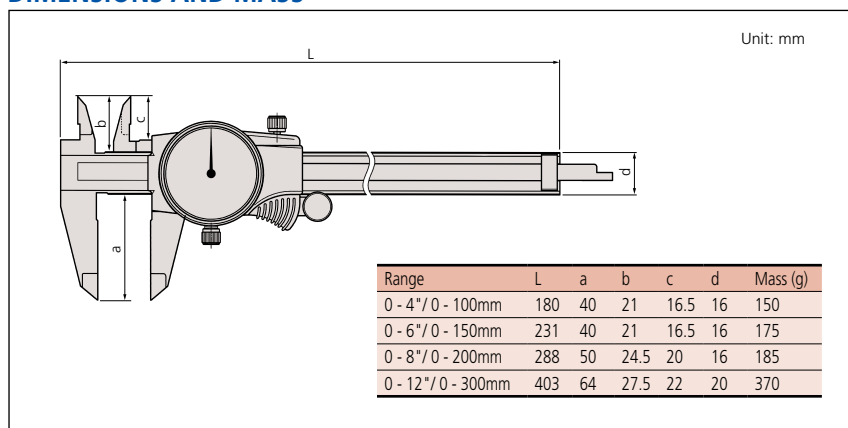

# Vernier Caliper

## SERIES 530 — Standard Model

### FEATURES

- Measures OD (outside diameter), ID (inside diameter), depth, and steps.
- The small vernier face angle ( $14^\circ$ ) provides easy reading.
- Dual reading scales on vernier. (metric/inch and inch models only).
- Lock screw for holding the sliding jaw position.
- Carbide-tipped jaw-type calipers are available.
- Supplied with vinyl holster in fitted carton. Except 24" / 600mm models are carton only. 40" / 1000mm supplied in wooden case.

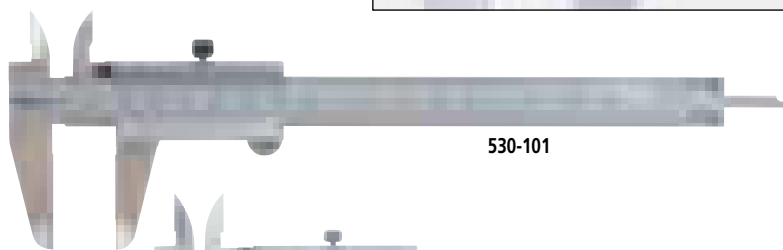
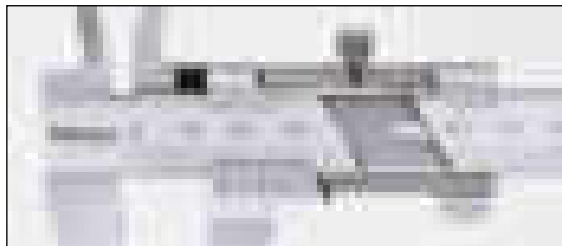
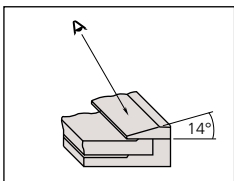

530-101



530-109

### DIMENSIONS AND MASS

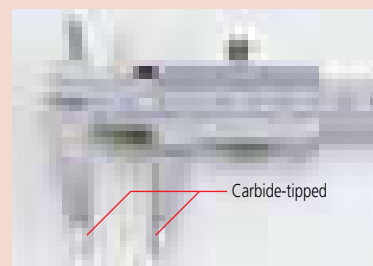
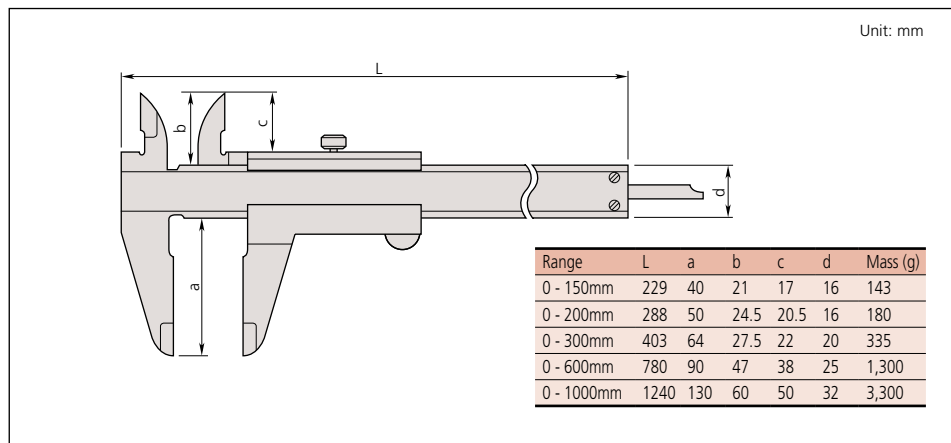

Carbide-tipped jaw type



Round depth bar type

## Measurement Applications



OD measurement



ID measurement

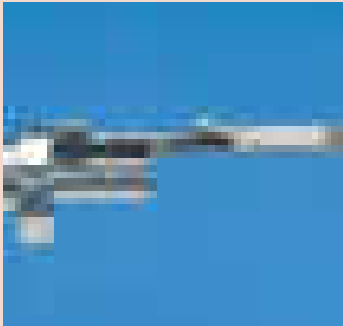

Step measurement

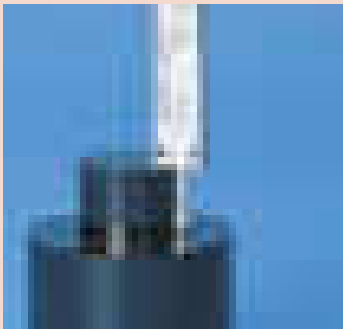

Depth measurement

## SPECIFICATIONS

### Metric

Range	Order No.	Accuracy	Graduation	Remarks
0 - 150mm	<b>530-102</b>	±0.05mm	0.05mm	∅ 1.9mm Depth bar
0 - 150mm	<b>530-101</b>	±0.05mm	0.05mm	—
0 - 150mm	<b>530-320</b>	±0.05mm	0.05mm	Carbide-tipped jaws for OD measurement
0 - 150mm	<b>530-335</b>	±0.05mm	0.05mm	Carbide-tipped jaws for OD & ID measurement
0 - 150mm	<b>530-122*</b>	±0.03mm	0.02mm	High-accuracy model
0 - 200mm	<b>530-108</b>	±0.05mm	0.05mm	—
0 - 200mm	<b>530-321</b>	±0.05mm	0.05mm	Carbide-tipped jaws for OD measurement
0 - 200mm	<b>530-123*</b>	±0.03mm	0.02mm	High-accuracy model
0 - 300mm	<b>530-109</b>	±0.08mm	0.05mm	—
0 - 300mm	<b>530-322</b>	±0.08mm	0.05mm	Carbide-tipped jaws for OD measurement
0 - 300mm	<b>530-124*</b>	±0.04mm	0.02mm	High-accuracy model: ±0.04mm
0 - 600mm	<b>530-501**</b>	±0.1mm	0.05mm	—
0 - 1000mm	<b>530-502**</b>	±0.15mm	0.05mm	—

\*Graduation: 0.02mm

\*\*No depth measuring bar

### Metric/Inch with metric/inch dual scale

Range	Order No.	Accuracy	Vernier Graduation		Remarks
			Lower Scale	Upper Scale	
0 - 150mm / 0 - 6"	<b>530-104</b>	±0.05mm	0.05mm	1/128"	—
0 - 150mm / 0 - 6"	<b>530-316</b>	±0.05mm	0.05mm	1/128"	—
0 - 150mm / 0 - 6"	<b>530-312*</b>	±0.03mm	0.02mm	.001"	High-accuracy model
0 - 200mm / 0 - 8"	<b>530-114</b>	±0.05mm	0.05mm	1/128"	—
0 - 200mm / 0 - 8"	<b>530-118*</b>	±0.03mm	0.02mm	.001"	High-accuracy model
0 - 300mm / 0 - 12"	<b>530-115</b>	±0.08mm	0.05mm	1/128"	—
0 - 300mm / 0 - 12"	<b>530-119*</b>	±0.04mm	0.02mm	.001"	High-accuracy model

\*Graduation: 0.02mm

### Inch with inch/inch dual scale

Range	Order No.	Accuracy	Vernier Graduation		Remarks
			Lower Scale	Upper Scale	
0 - 6"	<b>530-105</b>	±.0015"	.001"	1/128"	—
0 - 8"	<b>530-116</b>	±.0015"	.001"	1/128"	—

# Vernier Caliper

## SERIES 531 — with Thumb Clamp

### FEATURES

- The slider moves only when the spring loaded thumb clamp is depressed.
- Can measure OD, ID, depth and steps
- Supplied with vinyl holster in fitted carton.

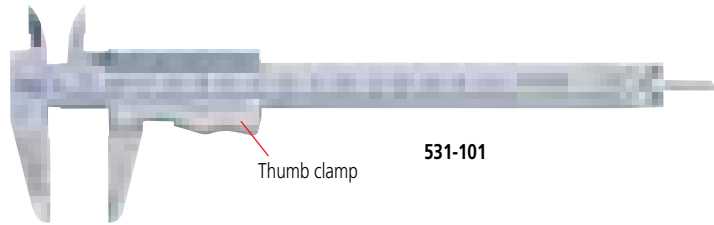

531-101

Thumb clamp

### SPECIFICATIONS

#### Metric

Range	Order No.	Accuracy	Graduation	Remarks
0 - 150mm	531-101	±0.05mm	0.05mm	—
0 - 200mm	531-102	±0.05mm	0.05mm	—
0 - 300mm	531-103	±0.08mm	0.05mm	—

#### Metric/Inch with metric/inch dual scale

Range	Order No.	Accuracy	Graduation		Remarks
			Lower Scale	Upper Scale	
0 - 150mm / 0 - 6"	531-122	±0.05mm	0.05mm	1/128"	with inch/mm conversion label
0 - 150mm / 0 - 6"	531-128	±0.03mm	0.02mm	.001"	High-accuracy model
0 - 200mm / 0 - 8"	531-108	±0.05mm	0.05mm	1/128"	—
0 - 200mm / 0 - 8"	531-129	±0.03mm	0.02mm	.001"	High-accuracy model
0 - 300mm / 0 - 12"	531-109	±0.08mm	0.05mm	1/128"	—
0 - 300mm / 0 - 12"	531-112	±0.04mm	0.02mm	.001"	High-accuracy model

### DIMENSIONS AND MASS

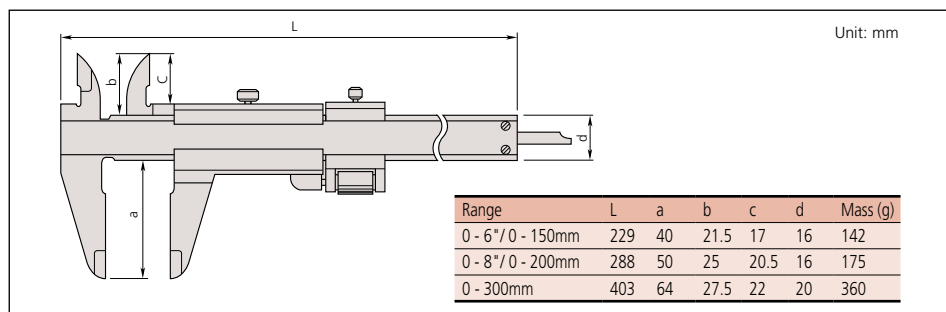

### Measurement Applications

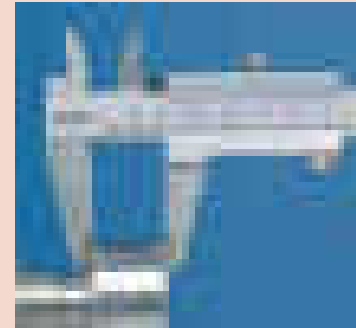

OD measurement



ID measurement

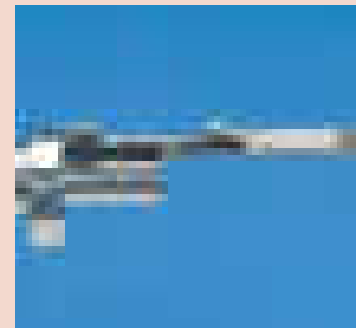

Step measurement

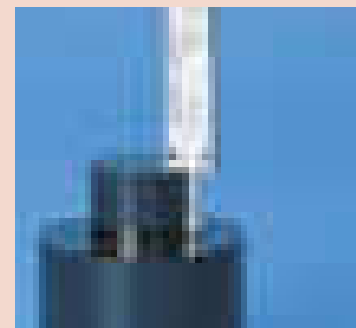

Depth measurement

# Vernier Caliper

**SERIES 532 — with Fine Adjustment**

## Measurement Applications

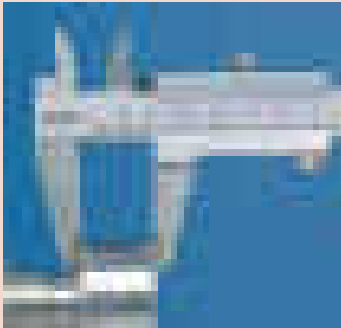

OD measurement



ID measurement

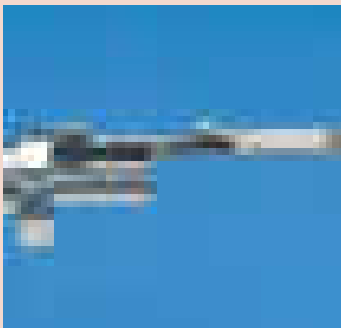

Step measurement

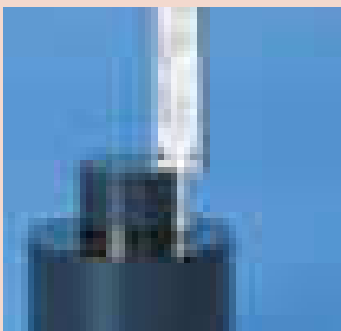

Depth measurement

## FEATURES

- Provided with a fine-adjustment carriage to feed the slider finely.
- Can measure OD, ID, depth and steps.
- Supplied with vinyl holster in fitted carton.

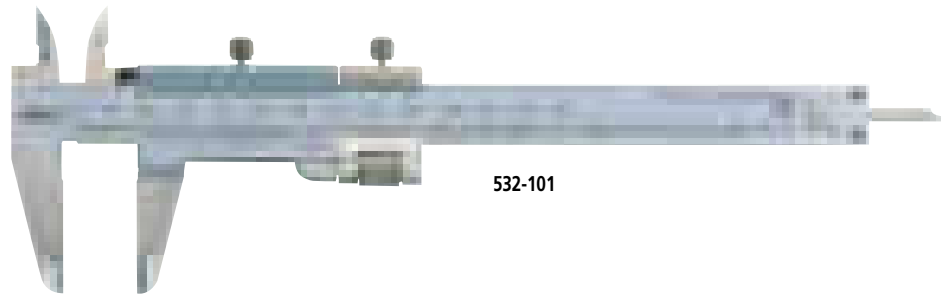

532-101

## SPECIFICATIONS

Metric			
Range	Order No.	Accuracy	Graduation
0 - 130mm	<b>532-101</b>	±0.03mm	0.02mm
0 - 180mm	<b>532-102</b>	±0.03mm	0.02mm
0 - 280mm	<b>532-103</b>	±0.04mm	0.02mm

## Metric/Inch with metric/inch dual scale

Range	Order No.	Accuracy	Graduation	
			Lower Scale	Upper Scale
0 - 130mm / 0 - 5"	<b>532-119</b>	±0.03mm	0.02mm	.001"
0 - 180mm / 0 - 7"	<b>532-120</b>	±0.03mm	0.02mm	.001"
0 - 280mm / 0 - 11"	<b>532-121</b>	±0.04mm	0.02mm	.001"

## DIMENSIONS AND MASS

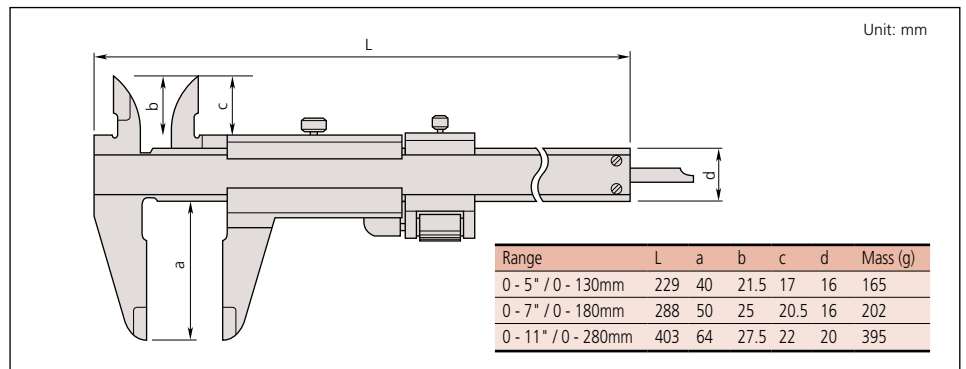

# Vernier Caliper

## SERIES 160 — with Nib Style Jaws and Fine Adjustment

### FEATURES

- The jaws have round measuring faces for accurate ID measurement.
- With fine adjustment carriage to feed the slider.
- Inside and outside measurements can be directly read from the upper and lower slider graduations, respectively.
- Supplied with vinyl holster in fitted carton. Except 12" / 300mm, 18" / 450mm and 24" / 600mm are fitted carton only. Over 24" / 600mm supplied in wooden case.



### SPECIFICATIONS

**Metric** \_\_\_\_\_ with metric/metric dual scale

Range*	Order No.	Accuracy	Graduation		Mass (g)
			Lower Scale	Upper Scale	
0 (10) - 300mm	<b>160-127</b>	±0.04mm	0.02mm	0.02mm	450
0 (20) - 450mm	<b>160-128</b>	±0.05mm	0.02mm	0.02mm	1,200
0 (20) - 600mm	<b>160-101</b>	±0.05mm	0.02mm	0.02mm	2,600
0 (20) - 1000mm	<b>160-104</b>	±0.07mm	0.02mm	0.02mm	3,500
0 (20) - 1500mm	<b>160-110</b>	±0.09mm	0.02mm	0.02mm	4,850
0 (20) - 2000mm	<b>160-113</b>	±0.12mm	0.02mm	0.02mm	10,200

\*( ): Minimum dimension in ID measurement

**Metric/Inch** \_\_\_\_\_ with metric/inch dual scale

Range*	Order No.	Accuracy	Graduation		Mass (g)
			Lower Scale	Upper Scale	
0 (10) - 300mm / 0 (.3") - 12"	<b>160-150</b>	±0.04mm	0.02mm	.001"	450
0 (20) - 450mm / 0 (.5") - 18"	<b>160-151</b>	±0.05mm	0.02mm	.001"	1,200
0 (20) - 600mm / 0 (.5") - 24"	<b>160-153</b>	±0.05mm	0.02mm	.001"	1,400
0 (20) - 1000mm / 0 (1") - 40"	<b>160-155</b>	±0.07mm	0.02mm	.001"	3,500
0 (20) - 1500mm / 0 (1") - 60"	<b>160-157</b>	±0.09mm	0.02mm	.001"	4,850
0 (20) - 2000mm / 0 (1") - 80"	<b>160-159</b>	±0.12mm	0.02mm	.001"	10,200

\*( ): Minimum dimension in ID measurement

**Inch** \_\_\_\_\_ with inch/inch dual scale

Range*	Order No.	Accuracy	Graduation		Mass (g)
			Lower Scale	Upper Scale	
0 (.3") - 12"	<b>160-124</b>	±.0015"	.001"	.001"	450
0 (.5") - 18"	<b>160-116</b>	±.002"	.001"	.001"	1,200
0 (.5") - 24"	<b>160-102</b>	±.002"	.001"	.001"	1,400
0 (1") - 40"	<b>160-105</b>	±.003"	.001"	.001"	3,500
0 (1") - 60"	<b>160-111</b>	±.004"	.001"	.001"	4,850
0 (1") - 80"	<b>160-114</b>	±.005"	.001"	.001"	10,200

\*( ): Minimum dimension in ID measurement

**Inch/Metric** \_\_\_\_\_ with inch/metric dual scale

Range*	Order No.	Accuracy	Graduation		Mass (g)
			Lower Scale	Upper Scale	
0 (.3") - 12" / 0 (10) - 300mm	<b>160-125</b>	±.0015"	.001"	0.02mm	450
0 (.5") - 18" / 0 (20) - 450mm	<b>160-119</b>	±.002"	.001"	0.02mm	1,200
0 (.5") - 24" / 0 (20) - 600mm	<b>160-103</b>	±.002"	.001"	0.02mm	1,400
0 (1") - 40" / 0 (20) - 1000mm	<b>160-106</b>	±.003"	.001"	0.02mm	3,500
0 (1") - 60" / 0 (20) - 1500mm	<b>160-112</b>	±.004"	.001"	0.02mm	4,850
0 (1") - 80" / 0 (20) - 2000mm	<b>160-115</b>	±.005"	.001"	0.02mm	10,200

\*( ): Minimum dimension in ID measurement

### Technical Data

Accuracy: Refer to the list of specifications  
Graduation: Refer to the list of specifications

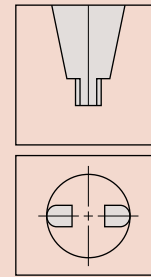

Round surface of jaws for accurate ID measurement.

### DIMENSIONS

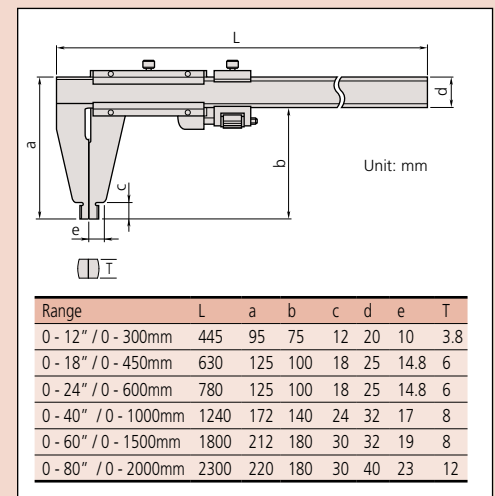



**ABSOLUTE**  
Absolute System Patented by MITUTOYO

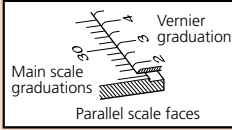

### Technical Data

Accuracy: Refer to the list of specifications  
 Display\*: LCD  
 Length standard\*: ABSOLUTE electrostatic capacitance type linear encoder  
 Max. response speed\*: Unlimited  
 Battery\*: SR44 (1 pc.), **938882**  
 Battery life\*: Approx. 3.5 years under normal use  
 \*Digital models \*\*Analog models

### Function of Digital Model

Origin-set, Zero-setting, Data output, inch/mm conversion (on inch/metric models only)  
 Alarm: Low voltage, Counting value composition error

### Optional Accessories for Digital Model

- 959143:** Data hold unit
- 959149:** SPC cable with data switch (40" / 1m)
- 959150:** SPC cable with data switch (80" / 2m)
- 05CZA624:** SPC cable with data switch (40" / 1m) for IP67 model
- 05CZA625:** SPC cable with data switch (80" / 2m) for IP67 model

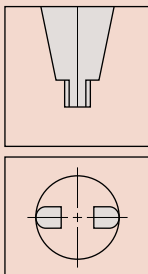

Round surface of jaws for accurate ID measurement.

# ABSOLUTE Digimatic & Vernier Caliper

**SERIES 550, 160 — with Nib-Style Jaws**

## FEATURES

- The rounded faces of the jaws are ideal for accurate ID (inside diameter) measurement.
- Inside and outside measurements can be directly read from the upper and lower slider graduations (Series 160).
- A fine-adjustment carriage type is available (Series 160).
- Parallax-free vernier scale type is available for easy and positive measurement (Series 160).
- With SPC output (Series 550).
- Supplied in fitted plastic case. Except 40"/1000mm supplied in wooden case.

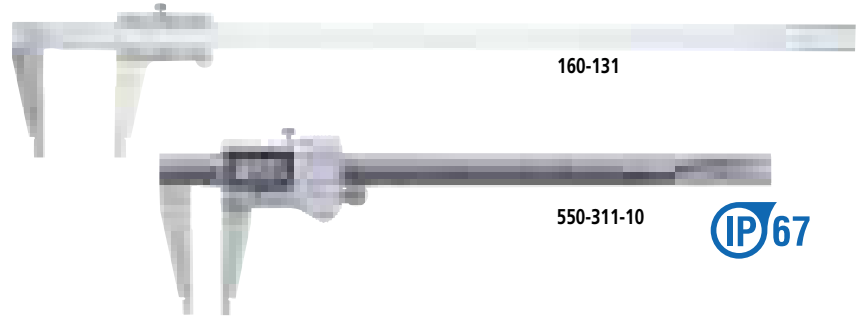

## SPECIFICATIONS

### Metric Digital model

Range*	Order No.	Accuracy	Resolution	Mass (g)	Remarks
0 (10) - 200mm	<b>550-301-20</b>	±0.03mm	0.01mm	180	IP67
0 (10) - 300mm	<b>550-331-10</b>	±0.03mm	0.01mm	380	w/ offset/preset function for easy ID measurement, IP67
0 (20) - 450mm	<b>550-203-10**</b>	±0.05mm	0.01mm	1,110	
0 (20) - 600mm	<b>550-205-10**</b>	±0.05mm	0.01mm	1,290	
0 (20) - 1000mm	<b>550-207-10**</b>	±0.07mm	0.01mm	3,350	

\*( ): Minimum dimension in ID measurement \*\*Models are not IP67 rated

### Inch/Metric Digital model

Range*	Order No.	Accuracy	Resolution	Mass (g)	Remarks
0 (.4") - 8" / 0 (10) - 200mm	<b>550-311-20</b>	±.001"	.0005" / 0.01mm	180	IP67
0 (.4") - 12" / 0 (10) - 300mm	<b>550-341-10</b>	±.0015"	.0005" / 0.01mm	380	w/ offset/preset function for easy ID measurement, IP67
0 (.5") - 18" / 0 (20) - 450mm	<b>550-223-10**</b>	±.002"	.0005" / 0.01mm	1,110	—
0 (.5") - 24" / 0 (20) - 600mm	<b>550-225-10**</b>	±.002"	.0005" / 0.01mm	1,290	—
0 (1") - 40" / 0 (20) - 1000mm	<b>550-227-10**</b>	±.003"	.0005" / 0.01mm	3,350	—

\*( ): Minimum dimension in ID measurement \*\*Models are not IP67 rated

### Metric with metric/metric dual scale

Range*	Order No.	Accuracy	Graduation	Mass (g)	Remarks
0 (20) - 450mm	<b>160-130</b>	±0.10mm	0.02mm	1,100	—
0 (20) - 600mm	<b>160-131</b>	±0.10mm	0.02mm	1,300	—
0 (20) - 1000mm	<b>160-132</b>	±0.15mm	0.02mm	3,350	—
0 (20) - 1500mm	<b>160-133</b>	±0.22mm	0.05mm	4,850	
0 (20) - 2000mm	<b>160-134</b>	±0.28mm	0.05mm	10,000	

\*( ): Minimum dimension in ID measurement

## DIMENSIONS

Range	L	a	b	d	T
0 - 8" / 0 - 200mm	288 (290)	60	8	16	3
0 - 12" / 0 - 300mm	445	75	12	20	3.8
0 - 18" / 0 - 450mm	632	100	18	25	6
0 - 24" / 0 - 600mm	780	100	18	25	6
0 - 40" / 0 - 1000mm	1240	140	24	32	8
0 - 60" / 0 - 1500mm	1800	180	30	32	8
0 - 80" / 0 - 2000mm	2300	180	30	40	12

( ): Digital models

# Long-Jaw Vernier Caliper

## SERIES 534

### FEATURES

- Long jaws for measuring hard-to-reach features.
- Fine adjustment for more accurate measurement (except 534-109 and 534-110)
- Supplied in fitted wooden case.



### SPECIFICATIONS

**Metric** with metric/metric dual scale without fine adjustment

Range*	Order No.	Accuracy	Graduation		Mass (g)
			Lower Scale	Upper Scale	
0 (10) - 300mm	<b>534-109</b>	±0.07mm	0.05mm	0.05mm	400
0 (20) - 500mm	<b>534-110</b>	±0.13mm	0.05mm	0.05mm	1,400

\*( ): Minimum dimension in ID measurement

**Metric** with metric/metric dual scale

Range*	Order No.	Accuracy	Graduation		Mass (g)
			Lower Scale	Upper Scale	
0 (10) - 300mm	<b>534-113</b>	±0.04mm	0.02mm	0.02mm	460
0 (20) - 500mm	<b>534-114</b>	±0.06mm	0.02mm	0.02mm	1,500
0 (20) - 750mm	<b>534-115</b>	±0.08mm	0.02mm	0.02mm	2,900
0 (20) - 1000mm	<b>534-116</b>	±0.10mm	0.02mm	0.02mm	3,500

\*( ): Minimum dimension in ID measurement

**Metric/Inch** with metric/inch dual scale

Range*	Order No.	Accuracy	Graduation		Mass (g)
			Lower Scale	Upper Scale	
0 (10) - 300mm / 0 (.3") - 12"	<b>534-101</b>	±0.07mm	0.05mm	1/128"	460
0 (10) - 300mm / 0 (.3") - 12"	<b>534-105</b>	±0.04mm	0.02mm	.001"	460
0 (20) - 500mm / 0 (.8") - 20"	<b>534-102</b>	±0.13mm	0.05mm	1/128"	1,500
0 (20) - 500mm / 0 (.8") - 20"	<b>534-106</b>	±0.06mm	0.02mm	.001"	1,500
0 (20) - 700mm / 0 (.8") - 30"	<b>534-103</b>	±0.16mm	0.05mm	1/128"	2,900
0 (20) - 700mm / 0 (.8") - 30"	<b>534-107</b>	±0.08mm	0.02mm	.001"	2,900
0 (20) - 1000mm / 0 (.8") - 40"	<b>534-104</b>	±0.20mm	0.05mm	1/128"	3,500
0 (20) - 1000mm / 0 (.8") - 40"	<b>534-108</b>	±0.10mm	0.02mm	.001"	3,500

\*( ): Minimum dimension in ID measurement

**Inch** with inch/inch dual scale

Range*	Order No.	Accuracy	Graduation		Mass (g)
			Lower Scale	Upper Scale	
0 (.3") - 12"	<b>534-117</b>	±.002"	.001"	.001"	400
0 (.8") - 20"	<b>534-118</b>	±.003"	.001"	.001"	1500
0 (.8") - 30"	<b>534-119</b>	±.004"	.001"	.001"	2900
0 (.8") - 40"	<b>534-120</b>	±.004"	.001"	.001"	3500

\*( ): Minimum dimension in ID measurement

### DIMENSIONS

Unit: mm

Range	L	a	b	c	d	e	T
0 - 12" / 0 - 300mm	445	110	90	12	20	7	3.8
0 - 20" / 0 - 500mm	682	225	200	18.5	25	12	6
0 - 30" / 0 - 750mm	995	232	200	18.5	32	12	8
0 - 40" / 0 - 1000mm	1230	232	200	18.5	32	12	8

### Technical Data

Accuracy: Refer to the list of specifications  
 Graduation: Refer to the list of specifications

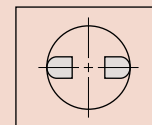
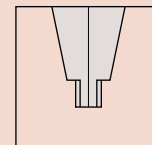
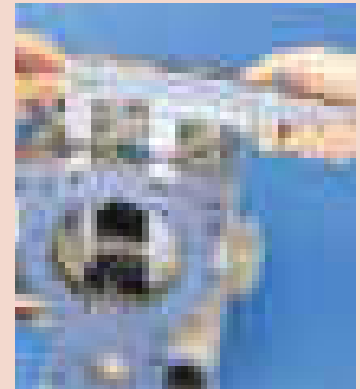

Round surface of jaws for accurate CD measurement.





### Technical Data

Accuracy: Refer to the list of specifications  
 Resolution: 0.01mm or .0005"/0.01mm  
 Display: LCD  
 Length standard: ABSOLUTE electrostatic capacitance type linear encoder  
 Max. response speed: Unlimited  
 Battery: SR44 (1 pc.), **938882**  
 Battery life: Approx. 3.5 years under normal use

### Function of Digital Model

Origin-set, Zero-setting, Data output,  
 inch/mm conversion (on inch/metric models only)  
 Alarm: Low voltage, Counting value composition error

### Optional Accessories for Digital Model

**05CZA624:** SPC cable with data switch (1m / 40") IP67  
**05CZA625:** SPC cable with data switch (2m / 80") IP67

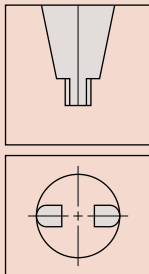

Round surface of jaws for accurate ID measurement.

# ABSOLUTE Digimatic Caliper

**SERIES 551 — with Nib Style and Standard Jaws**

### FEATURES

- The rounded faces of the jaws are ideal for accurate ID (inside diameter) measurement.
- With SPC output.
- Supplied in fitted plastic holster in carton. 18" / 450mm and larger supplied wooden case.



### SPECIFICATIONS

**Metric** Digital model

Range*	Order No.	Accuracy	Resolution	Mass (g)	Remarks
0 (10) - 200mm	<b>551-301-20</b>	±0.03mm	0.01mm	180	IP67
0 (10) - 300mm	<b>551-331-10</b>	±0.04mm	0.01mm	380	with offset/preset function for easy ID measurement, IP67
0 (20) - 500mm	<b>551-204-10**</b>	±0.06mm	0.01mm	1,060	—
0 (20) - 750mm	<b>551-206-10**</b>	±0.06mm	0.01mm	1,410	—
0 (20) - 1000mm	<b>551-207-10**</b>	±0.07mm	0.01mm	3,430	—

\*( ): Minimum dimension in ID measurement \*\* Models are not IP67 rated

**Inch/Metric** Digital model

Range*	Order No.	Accuracy	Resolution	Mass (g)	Remarks
0 (.4") - 8" / 0 (10) - 200mm	<b>551-311-20</b>	±.001"	.0005" / 0.01mm	180	IP67
0 (.4") - 12" / 0 (10) - 300mm	<b>551-341-10</b>	±.002"	.0005" / 0.01mm	380	w/ offset/preset function for easy ID measurement, IP67
0 (.5") - 20" / 0 (20) - 500mm	<b>551-224-10**</b>	±.0025"	.0005" / 0.01mm	1,060	—
0 (.5") - 30" / 0 (20) - 750mm	<b>551-226-10**</b>	±.0025"	.0005" / 0.01mm	1,410	—
0 (1") - 40" / 0 (20) - 1000mm	<b>551-227-10**</b>	±.003"	.0005" / 0.01mm	3,430	—

\*( ): Minimum dimension in ID measurement \*\* Models are not IP67 rated

### DIMENSIONS

Series 551 Unit: mm

Range	a	b	c	d	R	T
0 - 8" / 0 - 200mm	60	43	8	30	5	3
0 - 12" / 0 - 300mm	90	68	10	40.1	5	3.8
0 - 20" / 0 - 500mm	150	115	15	56	10	6
0 - 30" / 0 - 750mm	150	115	15	56	10	8
0 - 40" / 0 - 1000mm	150	115	20	56	10	8

# Digimatic Carbon-Fiber Caliper

**SERIES 552 — with Optional Jaw Attachments**



## FEATURES

- Lightweight Digimatic Calipers employ CFRP (Carbon-Fiber Reinforced Plastics) in the beam and jaws.
- Highly durable and easy to handle.
- The range of applications can be expanded by using the optional attachments.
- Direct readout of ID measurements from the LCD. (Offset value can be set easily by pressing the Offset key.)
- Preset function for setting a desired starting point.
- With SPC data output.
- Special model available with ceramic jaws which are suitable for measuring abrasive and magnetic products.
- Supplied in fitted wooden case.



## Technical Data

Accuracy: Refer to the list of specifications  
 Resolution: .0005"/0.01mm or 0.01mm  
 Display: LCD  
 Length standard: Electrostatic capacitance type linear encoder  
 Max. response speed: unlimited  
 Battery: SR44 (1 pc.), **938882**  
 Battery life: Approx. 3,000 hours in continuous use

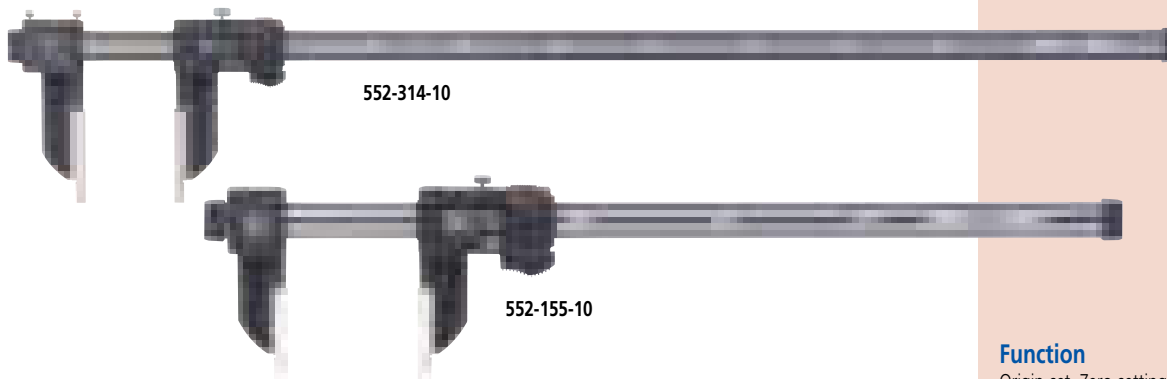

## SPECIFICATIONS

### Metric

Range*	Order No.	Accuracy	Resolution	Remarks
0(20)-450mm	<b>552-302-10</b>	+/-0.04mm	0.01mm	
0(20)-450mm	<b>552-150-10</b>	+/-0.06mm	0.01mm	long jaws 200mm
0(20)-450mm	<b>552-155-10</b>	+/-0.04mm	0.01mm	ceramic jaws
0(20)-600mm	<b>552-303-10</b>	+/-0.04mm	0.01mm	
0(20)-600mm	<b>552-151-10</b>	+/-0.06mm	0.01mm	long jaws 200mm
0(20)-600mm	<b>552-156-10</b>	+/-0.04mm	0.01mm	ceramic jaws
0(20)-1000mm	<b>552-304-10</b>	+/-0.05mm	0.01mm	
0(20)-1000mm	<b>552-152-10</b>	+/-0.07mm	0.01mm	long jaws 200mm
0(20)-1500mm	<b>552-305-10</b>	+/-0.09mm	0.01mm	
0(20)-1500mm	<b>552-153-10</b>	+/-0.11mm	0.01mm	long jaws 200mm
0(20)-2000mm	<b>552-306-10</b>	+/-0.12mm	0.01mm	
0(20)-2000mm	<b>552-154-10</b>	+/-0.14mm	0.01mm	long jaws 200mm

\*( ): Minimum dimension in ID measurement

### Inch/Metric

Range*	Order No.	Accuracy	Resolution	Remarks
0(.5")-18"	<b>552-312-10</b>	+/- .002"	.0005"/0.01mm	
0(.5")-18"	<b>552-160-10</b>	+/- .0025"	.0005"/0.01mm	long jaws 7.9"
0(.5")-18"	<b>552-165-10</b>	+/- .002"	.0005"/0.01mm	ceramic jaws
0(.5")-24"	<b>552-313-10</b>	+/- .002"	.0005"/0.01mm	
0(.5")-24"	<b>552-161-10</b>	+/- .0025"	.0005"/0.01mm	long jaws 7.9"
0(.5")-24"	<b>552-166-10</b>	+/- .002"	.0005"/0.01mm	ceramic jaws
0(1")-40"	<b>552-314-10</b>	+/- .002"	.0005"/0.01mm	
0(1")-40"	<b>552-162-10</b>	+/- .003"	.0005"/0.01mm	long jaws 7.9"
0(1")-60"	<b>552-315-10</b>	+/- .004"	.0005"/0.01mm	
0(1")-60"	<b>552-163-10</b>	+/- .0045"	.0005"/0.01mm	long jaws 7.9"
0(1")-80"	<b>552-316-10</b>	+/- .005"	.0005"/0.01mm	
0(1")-80"	<b>552-164-10</b>	+/- .0055"	.0005"/0.01mm	long jaws 7.9"

\*( ): Minimum dimension in ID measurement

## Function

Origin-set, Zero-setting, Presetting, Offsetting, Data hold, Data output, inch/mm conversion (on inch/metric models only)  
 Alarm: Low voltage, Counting value composition error

## Optional Accessories

**05CZA624:** SPC cable with data switch (40"/ 1m)  
**05CZA625:** SPC cable with data switch (80"/ 2m)

- 914055:**\* Centerline attachments (mm)
- 914056:**\* Centerline attachments (inch)
- 914057:**\* Pointed ID measuring attachments (mm)
- 914058:**\* Pointed ID measuring attachments (inch)
- 914053:**\*\* Attachment clamps (for models up to 24" / 600mm range)
- 914054:**\*\* Attachment clamps (for models over 24" / 600mm range)

\* Attachment clamps are required  
 \*\* Attachment clamps and attachments are not available for long jaw type calipers

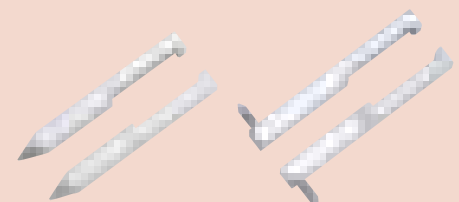

Centerline Attachments

Pointed ID Measuring Attachments



Attachment Clamps

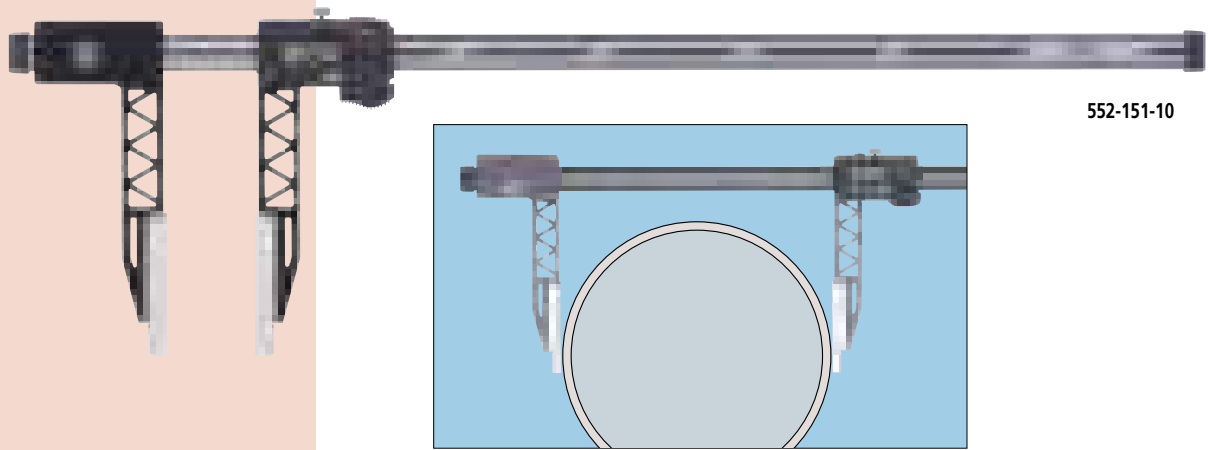

552-151-10



Ceramic jaws

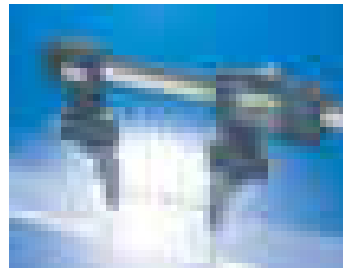

Centerline attachments

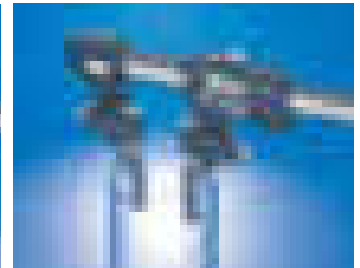

ID point attachments

## DIMENSIONS AND MASS

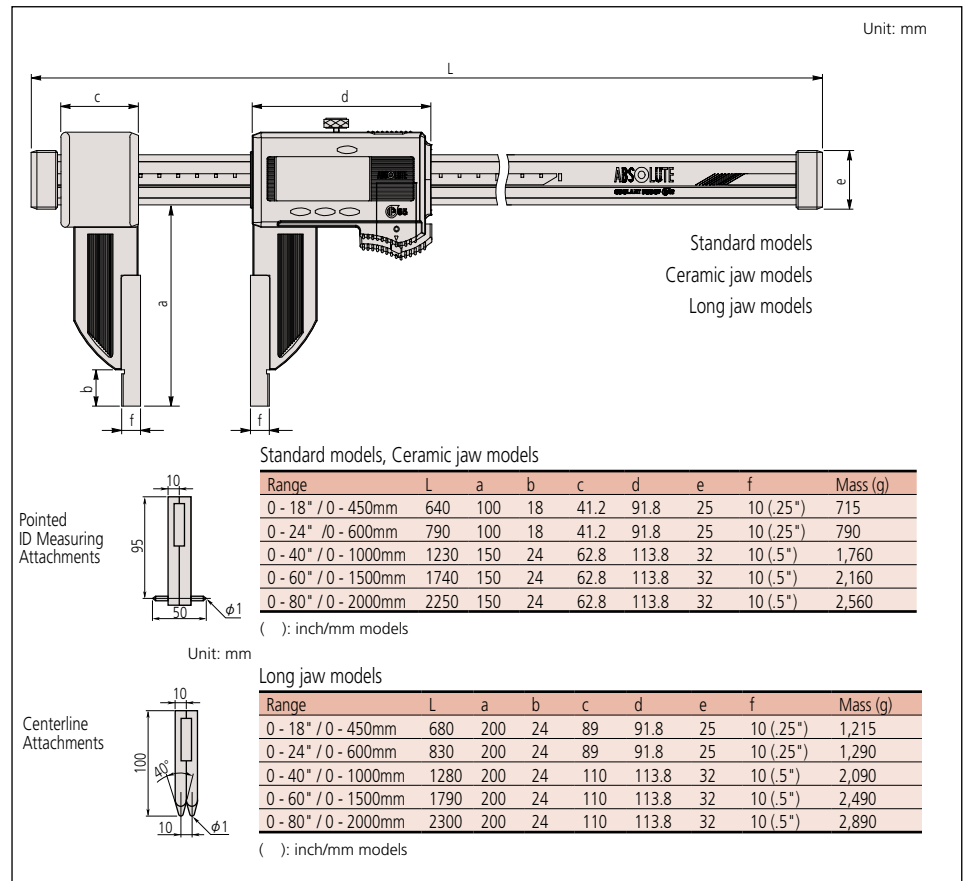

# ABSOLUTE Coolant-Proof Carbon-Fiber Caliper

## SERIES 552 — with Interchangeable Jaws

### FEATURES

- The range of applications can be expanded by using interchangeable jaws (optional).
- Quick and easy change of jaws due to the unique clamping mechanism. (A pair of clamping wheels is a standard accessory.)
- Provided with preset function for setting a desired starting point, which allows direct readout of offset measurements.
- SPC data output.



552-192-10 with optional interchangeable jaws

### SPECIFICATIONS

Inch/Metric

Range	Order No.	Accuracy	Mass(g)
0 - 18" / 0 - 450mm	552-191-10	±.002"	650
0 - 24" / 0 - 600mm	552-192-10	±.002"	725
0 - 40" / 0 - 1000mm	552-193-10	±.002"	1480
0 - 60" / 0 - 1500mm	552-194-10	±.004"	1880
0 - 80" / 0 - 2000mm	552-195-10	±.005"	2280

### Interchangeable Jaws (Optional)

Standard type	Inside point type	Standard Type																							
		<table border="1"> <thead> <tr> <th>Order No.</th> <th>Components</th> <th>a</th> <th>b</th> </tr> </thead> <tbody> <tr> <td>07CZA056</td> <td>Right (07CAA044), Left (07CAA045)</td> <td>28mm (1.1")</td> <td>30mm (1.2")</td> </tr> </tbody> </table>	Order No.	Components	a	b	07CZA056	Right (07CAA044), Left (07CAA045)	28mm (1.1")	30mm (1.2")															
Order No.	Components	a	b																						
07CZA056	Right (07CAA044), Left (07CAA045)	28mm (1.1")	30mm (1.2")																						
		<table border="1"> <thead> <tr> <th>Order No.</th> <th>Components</th> <th>a</th> <th>b</th> </tr> </thead> <tbody> <tr> <td>07CZA055</td> <td>Right (07CZA042), Left (07CZA043)</td> <td>8mm</td> <td>30mm</td> </tr> <tr> <td>07CZA061</td> <td>Right (07CZA042), Left (07CZA049)</td> <td>031"</td> <td>1.2"</td> </tr> </tbody> </table>	Order No.	Components	a	b	07CZA055	Right (07CZA042), Left (07CZA043)	8mm	30mm	07CZA061	Right (07CZA042), Left (07CZA049)	031"	1.2"											
Order No.	Components	a	b																						
07CZA055	Right (07CZA042), Left (07CZA043)	8mm	30mm																						
07CZA061	Right (07CZA042), Left (07CZA049)	031"	1.2"																						
		<table border="1"> <thead> <tr> <th>Order No.</th> <th>Components</th> <th>a</th> <th>b</th> </tr> </thead> <tbody> <tr> <td>07CZA057</td> <td>07CZA039 x 2pcs.</td> <td>30mm</td> <td>30mm</td> </tr> <tr> <td>07CZA060</td> <td>07CZA047 x 2pcs.</td> <td>1.2"</td> <td>1.2"</td> </tr> </tbody> </table>	Order No.	Components	a	b	07CZA057	07CZA039 x 2pcs.	30mm	30mm	07CZA060	07CZA047 x 2pcs.	1.2"	1.2"											
Order No.	Components	a	b																						
07CZA057	07CZA039 x 2pcs.	30mm	30mm																						
07CZA060	07CZA047 x 2pcs.	1.2"	1.2"																						
<table border="1"> <thead> <tr> <th>Surface Plate Type</th> <th>Order No.</th> <th>a</th> <th>b</th> </tr> </thead> <tbody> <tr> <td></td> <td>07CZA044</td> <td>3.5" / 90mm</td> <td>1.1" / 28mm</td> </tr> </tbody> </table>		Surface Plate Type	Order No.	a	b		07CZA044	3.5" / 90mm	1.1" / 28mm	<table border="1"> <thead> <tr> <th>Centerline Type</th> <th>Order No.</th> <th>Components</th> <th>a</th> <th>b</th> </tr> </thead> <tbody> <tr> <td></td> <td>07CZA057</td> <td>07CZA039 x 2pcs.</td> <td>30mm</td> <td>30mm</td> </tr> <tr> <td></td> <td>07CZA060</td> <td>07CZA047 x 2pcs.</td> <td>1.2"</td> <td>1.2"</td> </tr> </tbody> </table>	Centerline Type	Order No.	Components	a	b		07CZA057	07CZA039 x 2pcs.	30mm	30mm		07CZA060	07CZA047 x 2pcs.	1.2"	1.2"
Surface Plate Type	Order No.	a	b																						
	07CZA044	3.5" / 90mm	1.1" / 28mm																						
Centerline Type	Order No.	Components	a	b																					
	07CZA057	07CZA039 x 2pcs.	30mm	30mm																					
	07CZA060	07CZA047 x 2pcs.	1.2"	1.2"																					

Unit: mm



### Technical Data

Accuracy: Refer to the list of specifications  
 Resolution: .0005"/0.01mm  
 Display: LCD  
 Scale type: ABSOLUTE electromagnetic linear encoder  
 Max. response speed: Unlimited  
 Battery: SR44 (1 pc.), 938882  
 Battery life: Approx. 5,000 hours in continuous use  
 Dust/Water protection level: IP66  
 Standard accessory: Jaw clamps (2 pcs.), 05GZA033

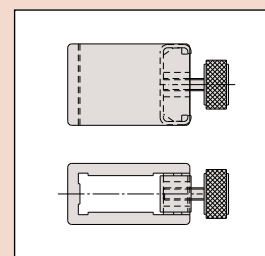

### Functions

Origin-set, Zero-setting, Presetting, Offsetting, Data hold,  
 Automatic power on/off, Data output, inch/mm conversion  
 (inch/mm models)  
 Alarm: Low voltage, Counting value composition error

### Optional Accessories

- 05CZA624: SPC cable with data switch (40" / 1m)
- 05CZA625: SPC cable with data switch (80" / 2m)

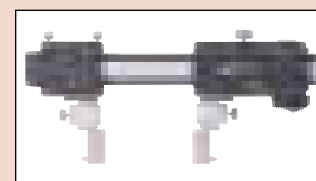



**ABSOLUTE**<sup>®</sup>

Absolute System Patented by MITUTOYO

# ABSOLUTE Back-Jaw Centerline Caliper

**SERIES 573 — Center-to-Center & Edge-to-Center Types**

## FEATURES

- Specially designed to measure the distance between two centers or the distance from an edge to center.
- Provided with jaws on the back of the slider, measurements can be read easily by upside down.
- Direct reading of pitch measurements is available due to the offset value setting function.
- With SPC data output.
- Supplied fitted in wooden case.

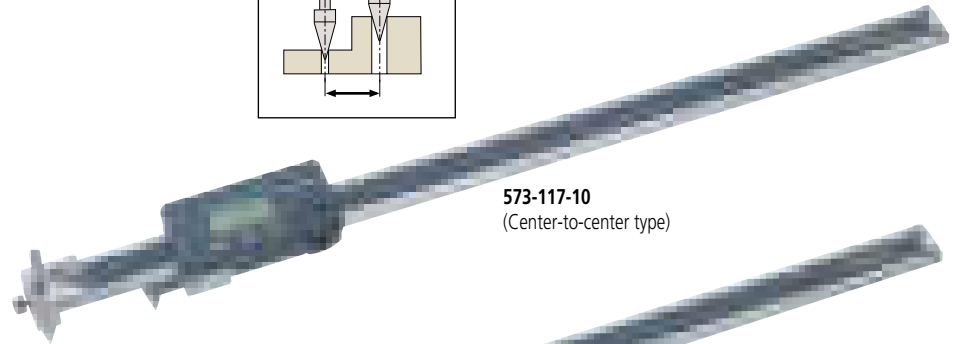
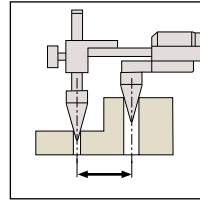

**573-117-10**  
(Center-to-center type)



**573-119-10**  
(Edge-to-center type)

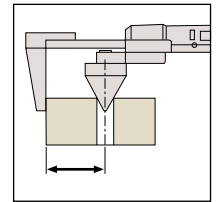

## Technical Data

Accuracy: Refer to the list of specifications  
 Resolution: 0.01mm  
 Display: LCD  
 Length standard\*: ABSOLUTE electrostatic capacitance type linear encoder  
 Max. response speed: Unlimited  
 Battery: SR44 (1 pc.), **938882**  
 Battery life: Approx. 3.5 years under normal use

## Function

Origin-set, Zero-setting, Power On/Off, Data output  
 Alarm: Low voltage, Counting value composition error

## Optional Accessories

- 959143:** Data hold unit  
**959149:** SPC cable with data switch (1m)  
**959150:** SPC cable with data switch (2m)

## SPECIFICATIONS

**Metric** Center-to-center distance type

Range	Order No.	Accuracy	Resolution	Mass (g)
10 - 200mm	<b>573-116-10</b>	±0.10mm	0.01mm	482
10 - 300mm	<b>573-117-10</b>	±0.15mm	0.01mm	578

**Metric** Edge-to-center distance type

Range	Order No.	Accuracy	Resolution	Mass (g)
10 - 200mm	<b>573-118-10</b>	±0.10mm	0.01mm	485
10 - 300mm	<b>573-119-10</b>	±0.15mm	0.01mm	581

## DIMENSIONS

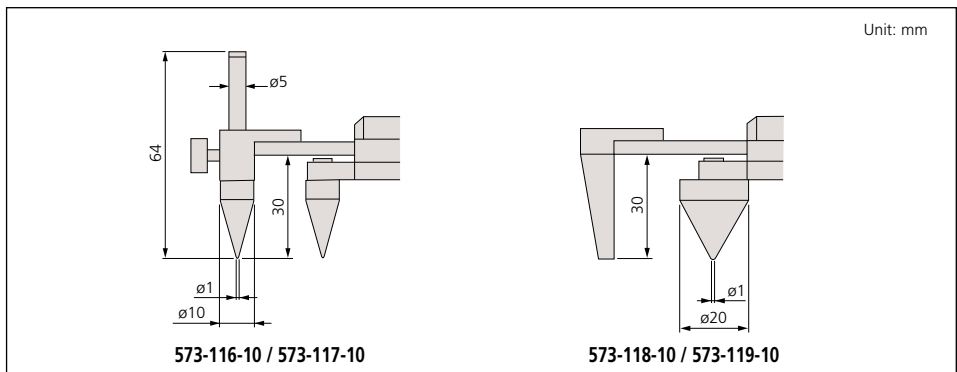

**573-116-10 / 573-117-10**

**573-118-10 / 573-119-10**

# Offset Caliper

**SERIES 573, 536 — ABSOLUTE Digimatic and Vernier Type**



## FEATURES

- Main scale jaw can slide up and down to facilitate measurement of stepped sections. (Hard-to-reach dimensions such as A, B, C can be accurately measured.)
- With depth bar.
- With SPC data output. (Series 573)
- Supplied in fitted plastic case.

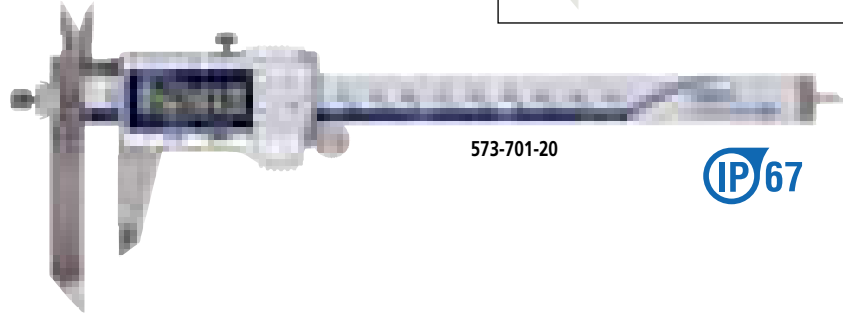
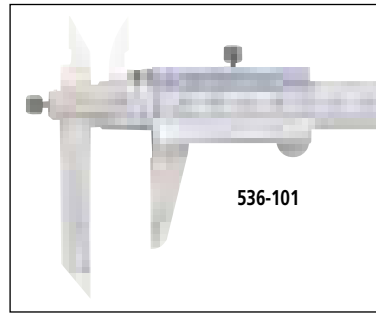

## SPECIFICATIONS

**Metric** Digital model

Range	Order No.	Accuracy	Resolution	Mass (g)
0 - 150mm	<b>573-601-20</b>	±0.02mm	0.01mm	168
0 - 200mm	<b>573-602-20</b>	±0.02mm	0.01mm	198
0 - 300mm	<b>573-604</b>	±0.03mm	0.01mm	350

**Metric**

Range	Order No.	Accuracy	Graduation	Mass (g)
0 - 150mm	<b>536-101</b>	±0.05mm	0.05mm	150
0 - 200mm	<b>536-102</b>	±0.05mm	0.05mm	200
0 - 300mm	<b>536-103</b>	±0.08mm	0.05mm	400

**Inch/Metric** Digital model

Range	Order No.	Accuracy	Resolution	Mass (g)
0 - 6" / 0 - 150mm	<b>573-701-20</b>	±.001"	.0005" / 0.01mm	168
0 - 8" / 0 - 200mm	<b>573-702-20</b>	±.001"	.0005" / 0.01mm	198
0 - 12" / 0 - 300mm	<b>573-704</b>	±.0015"	.0005" / 0.01mm	350

## DIMENSIONS

Vernier model

Digital model

Unit: mm

Range	a	b	c	d
0 - 6" / 0 - 150mm	95	10	40	30.4 (30)
0 - 8" / 0 - 200mm	95	10	50	40.4 (38.5)
0 - 12" / 0 - 300mm	135	15	64	51

( ) Digital Model



## Technical Data

Accuracy: Refer to the list of specifications  
 Resolution\*: .0005"/0.01mm or 0.01mm  
 Graduation\*\*\*: 0.05mm  
 Display\*: LCD  
 Length standard\*: ABSOLUTE electrostatic capacitance type linear encoder  
 Max. response speed\*: Unlimited  
 Battery\*: SR44 (1 pc.), **938882**  
 Battery life\*: Approx. 3.5 years under normal use  
 \*Digital models \*\*Analog models

## Function of Digital Model

Origin-set, Zero-setting, Power On/Off, Data output, inch/mm conversion (on inch/metric models only)  
 Alarm: Low voltage, Counting value composition error

## Optional Accessories for Digital Model

- 05CZA624**: SPC cable with data switch (40" / 1m)
- 05CZA625**: SPC cable with data switch (80" / 2m)

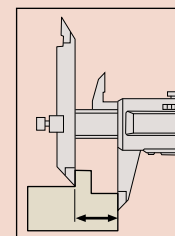
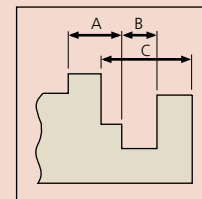



### Technical Data

Accuracy: Refer to the list of specifications  
 Resolution\*: .0005"/0.01mm or 0.01mm  
 Graduation\*\*: 0.05mm  
 Display\*: LCD  
 Length standard\*: ABSOLUTE electrostatic capacitance type linear encoder  
 Max. response speed\*: Unlimited  
 Battery\*: SR44 (1 pc.), **938882**  
 Battery life\*: Approx. 3.5 years under normal use  
 \*Digital models \*\*Analog models

### Function of Digital Model

Origin-set, Zero-setting, Power On/Off, Data output, inch/mm conversion (on inch/metric models only)  
 Alarm: Low voltage, Counting value composition error

### Optional Accessories for Digital Model

**05CZA624**: SPC cable with data switch (40" / 1m)  
**05CZA625**: SPC cable with data switch (80" / 2m)

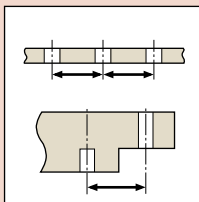

# Offset Centerline Caliper

**SERIES 573, 536 — ABSOLUTE Digimatic and Vernier Type**

## FEATURES

- Specially designed for center to center distance measurements on the same and offset planes.
- Can also measure from edge to center.
- Hole diameter should be in the range of 1.5mm - 10mm (.06" - .4").
- With SPC data output. (Series 573)
- Supplied in fitted plastic case.

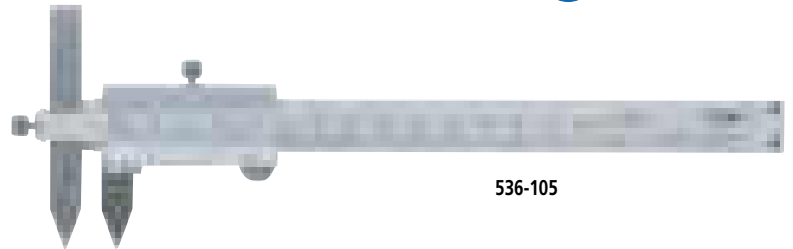
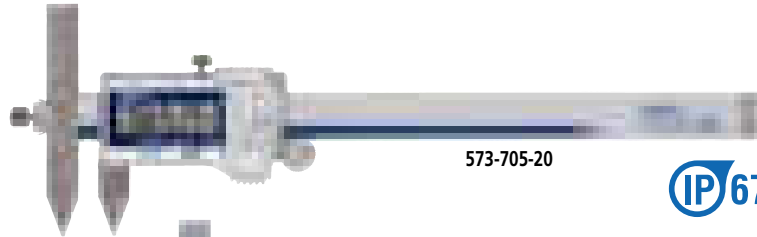

## SPECIFICATIONS

Metric		Digital model		
Range	Order No.	Accuracy	Resolution	Mass (g)
10 - 150mm	<b>573-605-20</b>	±0.03mm	0.01mm	157
10 - 200mm	<b>573-606-20</b>	±0.03mm	0.01mm	177
10 - 300mm	<b>573-608</b>	±0.04mm	0.01mm	320

Inch/Metric		Digital model		
Range	Order No.	Accuracy	Resolution	Mass (g)
.4 - 6" / 10 - 150mm	<b>573-705-20</b>	±.0015"	.0005" / 0.01mm	157
.4 - 8" / 10 - 200mm	<b>573-706-20</b>	±.0015"	.0005" / 0.01mm	177
.4 - 12" / 10 - 300mm	<b>573-708</b>	±.0015"	.0005" / 0.01mm	320

Metric		Vernier model		
Range	Order No.	Accuracy	Graduation	Mass (g)
10 - 150mm	<b>536-105</b>	±0.05mm	0.05mm	140
10 - 200mm	<b>536-106</b>	±0.05mm	0.05mm	160
10 - 300mm	<b>536-107</b>	±0.08mm	0.05mm	320

## DIMENSIONS

Unit: mm

Analog model

Range	W	t
10 - 150mm	75	3
10 - 200mm	75	3
10 - 300mm	100	3.8

Digital model

Range	W	t
10 - 160mm/.4 - 6.4"	75	3.5
10 - 210mm/.4 - 8.4"	75	3.5
10 - 310mm/.4 - 12.4"	100	3.8

# Point Caliper

**SERIES 573, 536 — ABSOLUTE Digimatic and Vernier Type**



## FEATURES

- Narrow tip jaws fit into very small grooves and tracks, making many previously difficult outside measurements far easier to obtain.
- With depth bar.
- With SPC data output. (Series 573)
- Supplied in fitted plastic case.

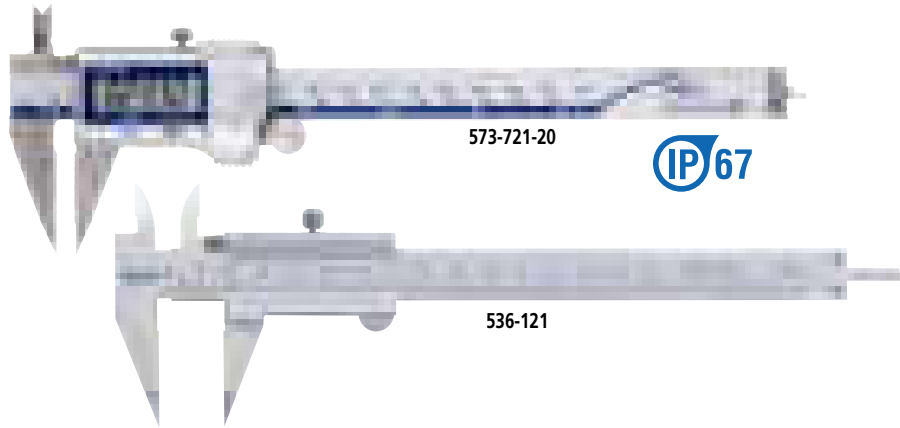

## SPECIFICATIONS

Metric		Digital model		
Range	Order No.	Accuracy	Resolution	Mass (g)
0 - 150mm	573-621-20	±0.02mm	0.01mm	163
0 - 150mm	573-625-20	±0.02mm	0.01mm	163

Inch/Metric		Digital model		
Range	Order No.	Accuracy	Resolution	Mass (g)
0 - 6" / 0 - 150mm	573-721-20	±.001"	.0005" / 0.01mm	163
0 - 6" / 0 - 150mm	573-725-20	±.001"	.0005" / 0.01mm	163

Metric		Digital model		
Range	Order No.	Accuracy	Graduation	Mass (g)
0 - 150mm	536-121	±0.05mm	0.05mm	150

## DIMENSIONS

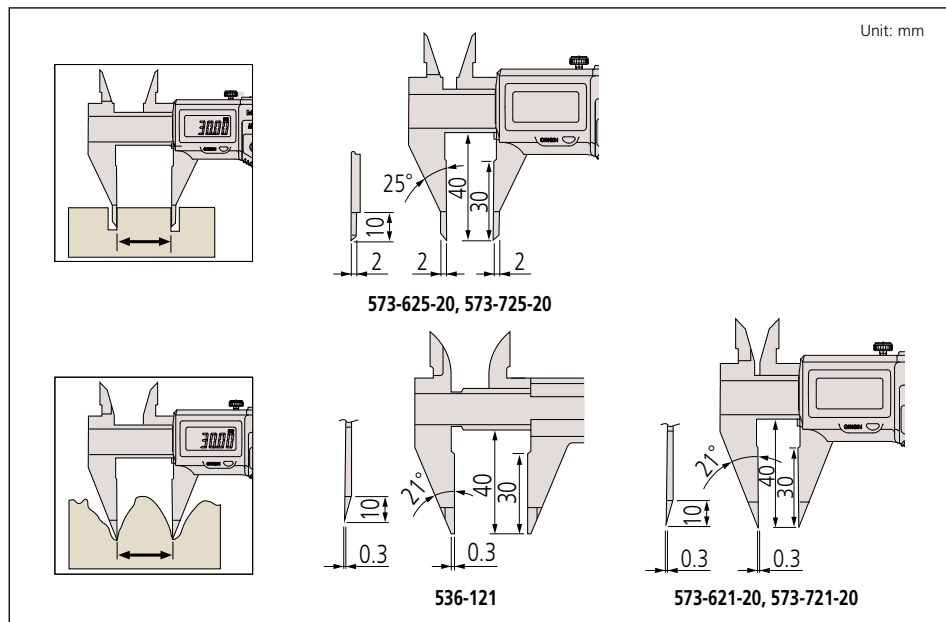

## Technical Data

Accuracy: Refer to the list of specifications  
 Resolution\*: .0005"/0.01mm or 0.01mm  
 Graduation\*\*: 0.05mm  
 Display\*: LCD  
 Length standard\*: ABSOLUTE electrostatic capacitance type linear encoder  
 Max. response speed\*: Unlimited  
 Battery\*: SR44 (1 pc.), **938882**  
 Battery life\*: Approx. 3.5 years under normal use  
 \*Digital models \*\*Analog models

## Function of Digital Model

Origin-set, Zero-setting, Power On/Off, Data output, inch/mm conversion (on inch/metric models only)  
 Alarm: Low voltage, Counting value composition error

## Optional Accessories for Digital Model

**05CZA624**: SPC cable with data switch (40" / 1m)  
**05CZA625**: SPC cable with data switch (80" / 2m)







### Technical Data

Accuracy: Refer to the list of specifications  
 Resolution\*: .0005" / 0.01mm or 0.01mm  
 Graduation\*\*: 0.05mm  
 Display\*: LCD  
 Length standard\*: ABSOLUTE electrostatic capacitance type linear encoder  
 Max. response speed\*: Unlimited  
 Battery\*: SR44 (1 pc.), **938882**  
 Battery life\*: Approx. 3.5 years under normal use  
 \*Digital models \*\*Analog models

### Function of Digital Model

Origin-set, Zero-setting, Power On/Off, Data output, inch/mm conversion (on inch/metric models only)  
 Alarm: Low voltage, Counting value composition error

### Optional Accessories for Digital Model

**05CZA624**: SPC cable with data switch (40" / 1m)  
**05CZA625**: SPC cable with data switch (80" / 2m)

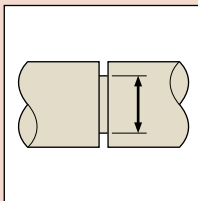

# Blade-Type Caliper

**SERIES 573, 536 — ABSOLUTE Digimatic and Vernier Type**

## FEATURES

- The thin-blade type jaws fit into very small grooves and making previously difficult outside measurements easier to obtain.
- The OD measuring faces are carbide-tipped.
- With depth bar.
- With SPC data output. (Series 573)
- Supplied in fitted plastic case.

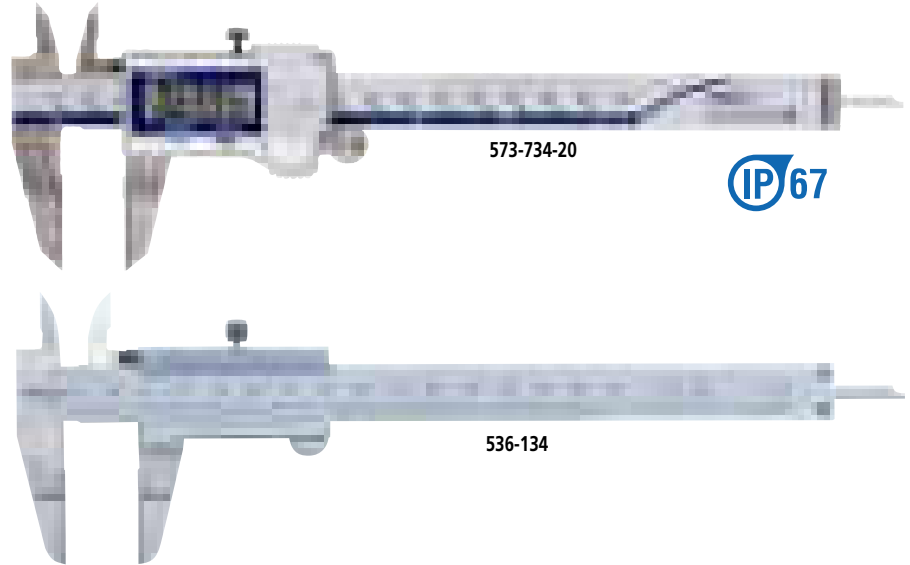

## SPECIFICATIONS

Metric		Digital model		
Range	Order No.	Accuracy	Resolution	Mass (g)
0 - 150mm	<b>573-634-20</b>	±0.02mm	0.01mm	168

Inch/Metric		Digital model		
Range	Order No.	Accuracy	Resolution	Mass (g)
0 - 6" / 0 - 150mm	<b>573-734-20</b>	±.001"	.0005" / 0.01mm	168

Metric				
Range	Order No.	Accuracy	Graduation	Mass (g)
0 - 150mm	<b>536-134</b>	±0.05mm	0.05mm	130
0 - 200mm	<b>536-135</b>	±0.05mm	0.05mm	160
0 - 300mm	<b>536-136</b>	±0.08mm	0.05mm	340

## DIMENSIONS

Analog model

Digital model

Unit: mm

Range	D	d	e	t
0 - 6" / 0 - 150mm	40	20	0.75	3
0 - 200mm	50	25	0.75	3
0 - 300mm	64	30	1	3.8

# Neck Caliper

**SERIES 573, 536 — ABSOLUTE Digimatic and Vernier Type**



## FEATURES

- Point-jaw type can measure wall thickness inside bores and recesses.
- Flat-jaw type can measure grooves and recesses.
- With SPC data output. (Series 573)
- Supplied in fitted plastic case.

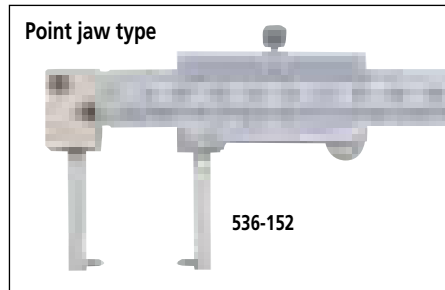
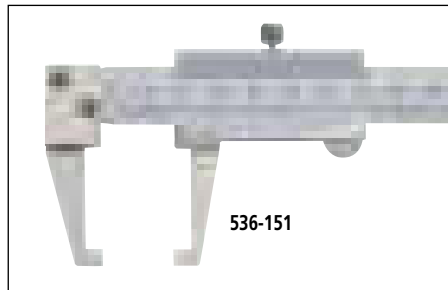

## SPECIFICATIONS

**Metric** Digital model

Range	Order No.	Accuracy	Resolution	Mass (g)
0 - 150mm	<b>573-651-20</b>	±0.03mm	0.01mm	157
0 - 150mm	<b>573-652-20*</b>	±0.03mm	0.01mm	157

\*Point jaw type

**Inch/Metric** Digital model

Range	Order No.	Accuracy	Resolution	Mass (g)
0 - 6" / 0 - 150mm	<b>573-751-20</b>	±.0015"	.0005" / 0.01mm	157
0 - 6" / 0 - 150mm	<b>573-752-20*</b>	±.0015"	.0005" / 0.01mm	157

\*Point jaw type

**Metric**

Range	Order No.	Accuracy	Graduation	Mass (g)
0 - 150mm	<b>536-151</b>	±0.05mm	0.05mm	140
0 - 150mm	<b>536-152*</b>	±0.05mm	0.05mm	140

\*Point jaw type

## DIMENSIONS

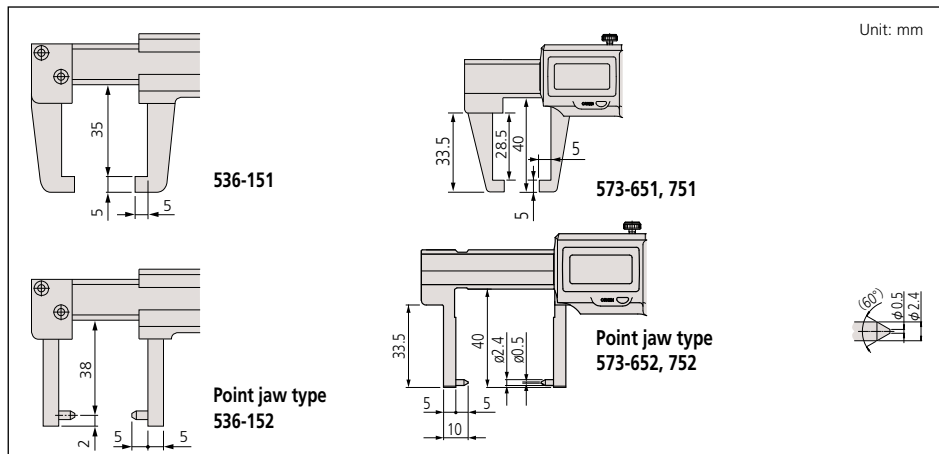

## Technical Data

Accuracy: Refer to the list of specifications  
 Resolution\*: 0.01mm or .0005"/0.01mm  
 Graduation\*\*: 0.05mm  
 Display\*: LCD  
 Length standard\*: ABSOLUTE electrostatic capacitance type linear encoder  
 Max. response speed\*: Unlimited  
 Battery\*: SR44 (1 pc.), **938882**  
 Battery life\*: Approx. 3.5 years under normal use  
 \*Digital models \*\*Analog models

## Function of Digital Model

Origin-set, Zero-setting, Power On/Off, Data output, inch/mm conversion (on inch/metric models only)  
 Alarm: Low voltage, Counting value composition error

## Optional Accessories for Digital Model

- 05CZA624**: SPC cable with data switch (1m / 40")
- 05CZA625**: SPC cable with data switch (2m / 80")

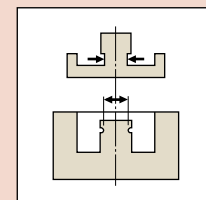
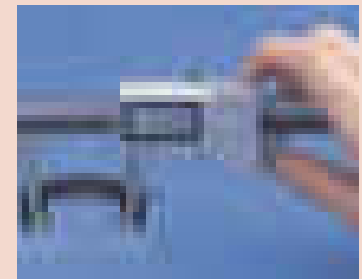



### Technical Data

Accuracy: Refer to the list of specifications  
 Display\*: LCD  
 Length standard: ABSOLUTE electrostatic capacitance type linear encoder  
 Max. response speed\*: Unlimited  
 Battery\*: SR44 (1 pc.), **938882**  
 Battery life\*: Approx. 3.5 years under normal use  
 \*Digital models \*\*Analog models

### Function of Digital Model

Origin-set, Zero-setting, Power On/Off, Data output, inch/mm conversion (on inch/metric models only)  
 Alarm: Low voltage, Counting value composition error

### Optional Accessories for Digital Model

**05CZA624**: SPC cable with data switch (40" / 1m)  
**05CZA625**: SPC cable with data switch (80" / 2m)

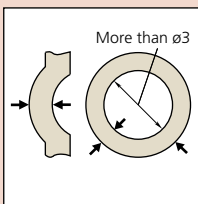
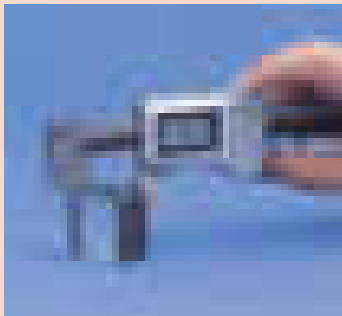

# Tube Thickness Caliper

**SERIES 573, 536 — ABSOLUTE Digimatic and Vernier Type**

### FEATURES

- The main scale jaw is a round bar that facilitates measurements of tube wall thickness.
- With SPC data output. (Series 573)
- Supplied in fitted plastic case.

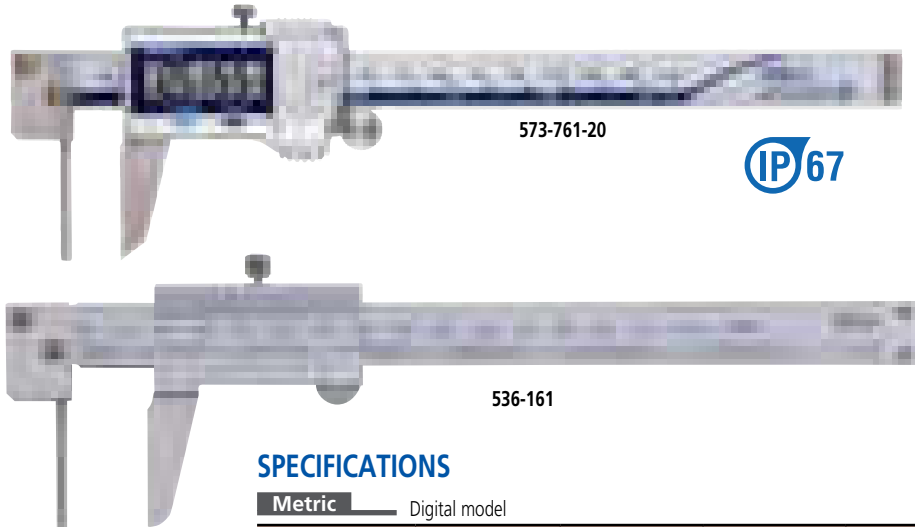

### SPECIFICATIONS

Metric		Digital model		
Range	Order No.	Accuracy	Resolution	Mass(g)
0 - 150mm	<b>573-661-20</b>	±0.05mm	0.01mm	167

Inch/Metric		Digital model		
Range	Order No.	Accuracy	Resolution	Mass(g)
0 - 6" / 0 - 150mm	<b>573-761-20</b>	±.002"	.0005" / 0.01mm	167

Metric		Vernier model		
Range	Order No.	Accuracy	Graduation	Mass(g)
0 - 150mm	<b>536-161</b>	±0.05mm	0.05mm	150

### DIMENSIONS AND MASS

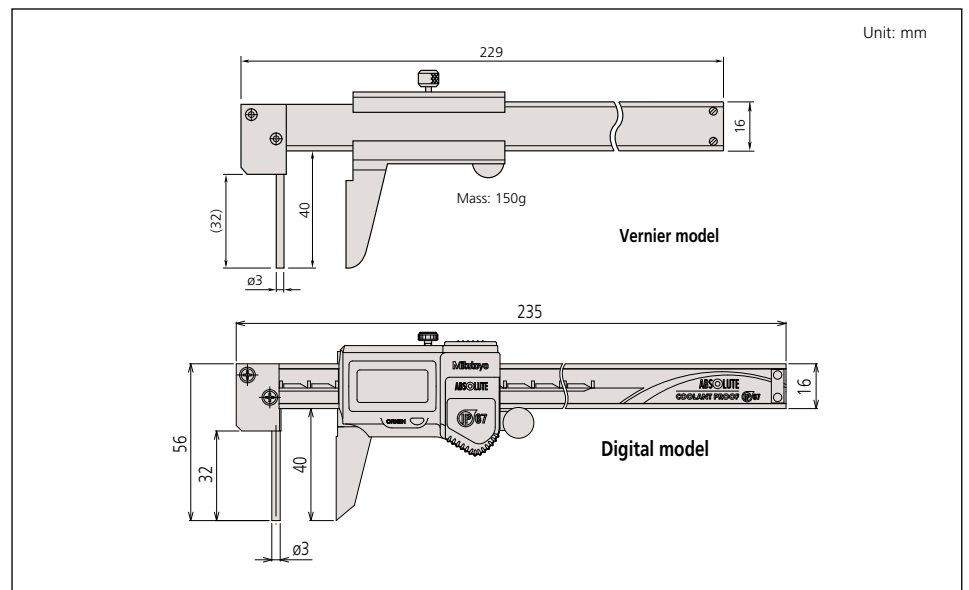

# ABSOLUTE Low-Force Caliper

**SERIES 573**

## FEATURES

- Due to their low measuring force, these calipers are ideal for elastic or resilient workpieces such as plastic parts and rubber parts that standard calipers cannot measure.
- With SPC data output.
- Supplied in fitted plastic case.

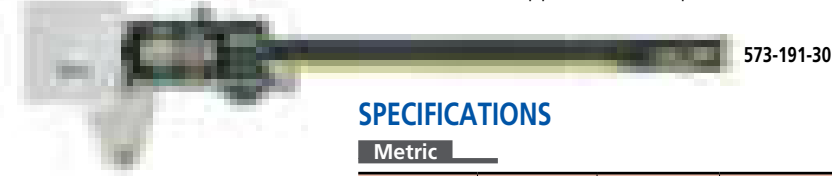

## SPECIFICATIONS

Metric				
Range	Order No.	Accuracy	Resolution	Mass (g)
0 - 180mm	<b>573-191-30</b>	±0.05mm	0.01mm	253

Inch/Metric				
Range	Order No.	Accuracy	Resolution	Mass (g)
0 - 7" / 0 - 180mm	<b>573-291-30</b>	±.002"	.0005" / 0.01mm	253

## DIMENSIONS AND MASS

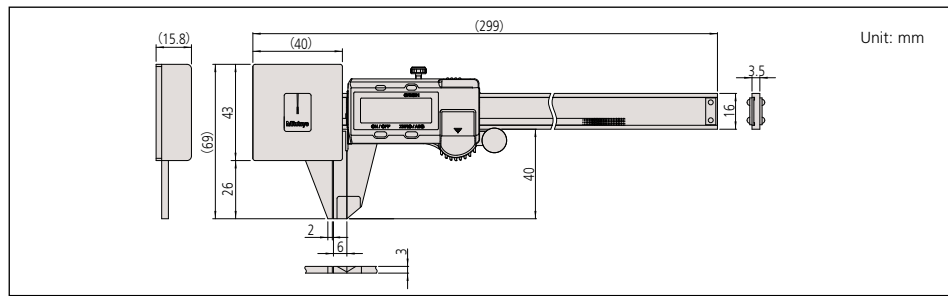

# ABSOLUTE Snap Caliper

**SERIES 573**

## FEATURES

- The ABSOLUTE Digimatic snap caliper features a spring-loaded mechanism to allow quick and efficient go/no-go inspection for mass production parts.
- With SPC data output.
- Supplied in fitted plastic case.

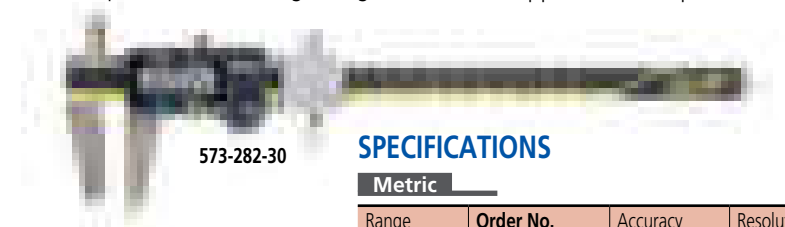

## SPECIFICATIONS

Metric				
Range	Order No.	Accuracy	Resolution	Mass (g)
0 - 100mm	<b>573-181-30</b>	±0.02mm	0.01mm	213
0 - 150mm	<b>573-182-30</b>	±0.02mm	0.01mm	233

Inch/Metric				
Range	Order No.	Accuracy	Resolution	Mass (g)
0 - 4" / 0 - 100mm	<b>573-281-30</b>	±.001"	.0005" / 0.01mm	213
0 - 6" / 0 - 150mm	<b>573-282-30</b>	±.001"	.0005" / 0.01mm	233

## DIMENSIONS AND MASS

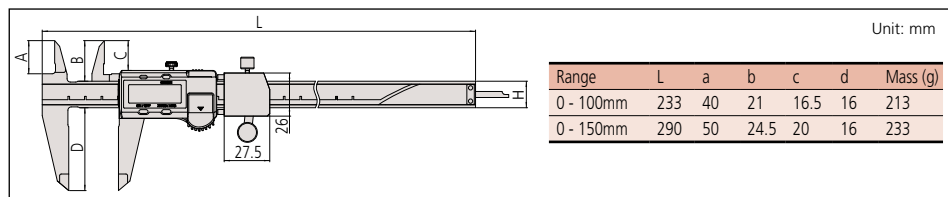

Range	L	a	b	c	d	Mass (g)
0 - 100mm	233	40	21	16.5	16	213
0 - 150mm	290	50	24.5	20	16	233



## Technical Data

Accuracy: Refer to the list of specifications  
 Resolution: .0005"/0.01mm or 0.01mm  
 Display: LCD  
 Length standard: ABSOLUTE Electromagnetic Induction-type Linear Encoder  
 Measuring force: 0.5N-1.0N (50gf to 100gf)  
 Jaw retraction: 0.3mm  
 Max. response speed: Unlimited  
 Battery: SR44 (1 pc.), **938882**  
 Battery life: Approx. 3.5 years under normal use

## Function

Origin-set, Zero-setting, Power On/Off, Data output, inch/mm conversion (on inch/metric models only)  
 Alarm: Low voltage, Counting value composition error

## Optional Accessories

- 959143:** Data hold unit
- 959149:** SPC cable with data switch (40" / 1m)
- 959150:** SPC cable with data switch (80" / 2m)

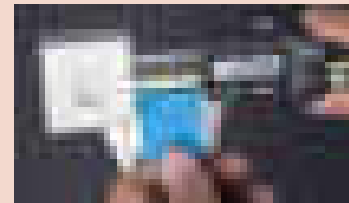

## Measurement procedures



A consistently low measuring force can be guaranteed by only taking measurements when the pointer is between the two fiducial lines.



## Technical Data

Accuracy: Refer to the list of specifications  
 Resolution: .0005"/0.01mm or 0.01mm  
 Repeatability: .0005" / 0.01mm  
 Display: LCD  
 Length standard: ABSOLUTE Electromagnetic Induction-type Linear Encoder  
 Measuring force: 7N to 14N (700gf to 1400gf)  
 Jaw retraction: 2mm  
 Max. response speed: Unlimited  
 Battery: SR44 (1 pc.), **938882**  
 Battery life: Approx. 3.5 years under normal use

## Function

Origin-set, Zero-setting, Power On/Off, Data output, inch/mm conversion (on inch/metric models only)  
 Alarm: Low voltage, Counting value composition error

## Optional Accessories

- 959143:** Data hold unit
- 959149:** SPC cable with data switch (40" / 1m)
- 959150:** SPC cable with data switch (80" / 2m)



### Technical Data

Accuracy: Refer to the list of specifications  
 Display: LCD  
 Length standard: ABSOLUTE electrostatic capacitance type linear encoder  
 Max. response speed: Unlimited  
 Battery: SR44 (1 pc.), **938882**  
 Battery life: Approx. 3.5 years under normal use

### Function

Origin-set, Zero-setting, Power On/Off, Data output, inch/mm conversion (on inch/metric models only)  
 Alarm: Low voltage, Counting value composition error

### Optional Accessories

**05CZA624:** SPC cable with data switch (40" / 1m)  
**05CZA625:** SPC cable with data switch (80" / 2m)

# Scribing Caliper

**SERIES 573, 536 — ABSOLUTE Digimatic and Vernier Type**

### FEATURES

- The carbide-tipped jaws facilitate fine scribing on workpiece.
- With depth bar.
- With SPC data output. (Series 573)
- Supplied in fitted plastic case.

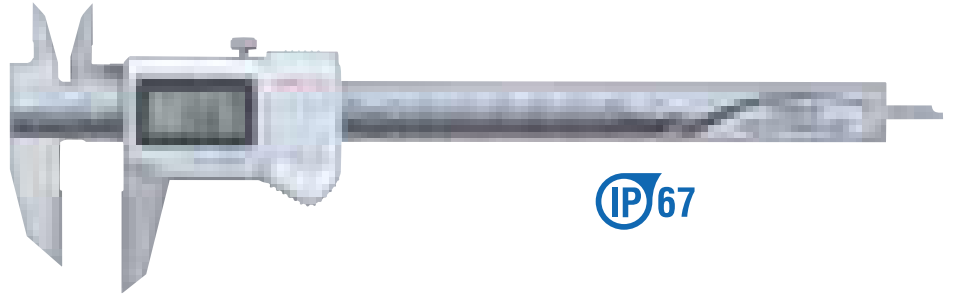

### SPECIFICATIONS

Metric		Digital model			
Range	Order No.	Accuracy	Resolution	Mass (g)	
0 - 150mm	<b>573-676-20</b>	±0.02mm	0.01mm	166	
0 - 200mm	<b>573-677-20</b>	±0.02mm	0.01mm	196	
0 - 300mm	<b>573-679</b>	±0.03mm	0.01mm	345	

Metric		Vernier type			
Range	Order No.	Accuracy	Graduation	Mass (g)	
0 - 150mm	<b>536-221</b>	±0.05mm	0.05mm	150	
0 - 200mm	<b>536-222</b>	±0.05mm	0.05mm	180	
0 - 300mm	<b>536-223</b>	±0.08mm	0.05mm	355	

### DIMENSIONS

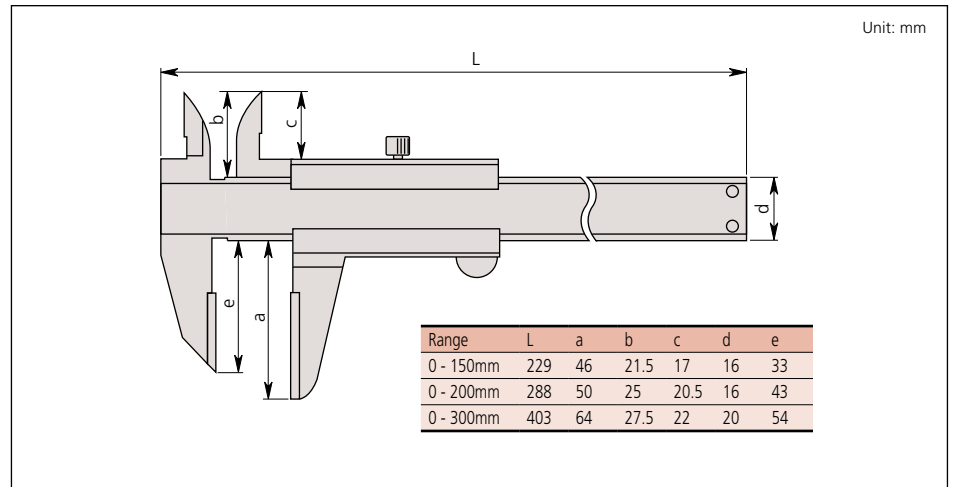

# ABSOLUTE Inside Caliper

**SERIES 573, 536 — Knife-edge/Inside Groove/Point-Jaw Type**



## FEATURES

- Specially designed for inside measurements in hard-to-reach places.
- With SPC data output. (Series 573)
- Supplied in fitted plastic case. 18" / 450mm and 24" / 600mm supplied in wooden case.

### Knife-edge type

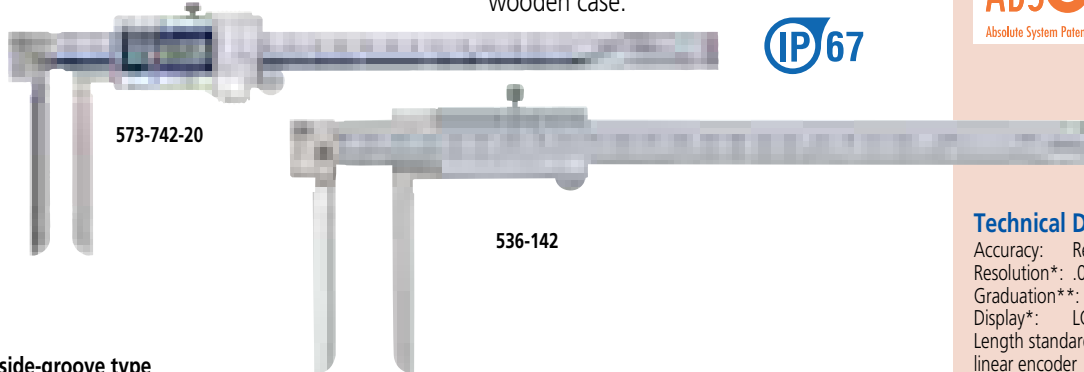

### Inside-groove type

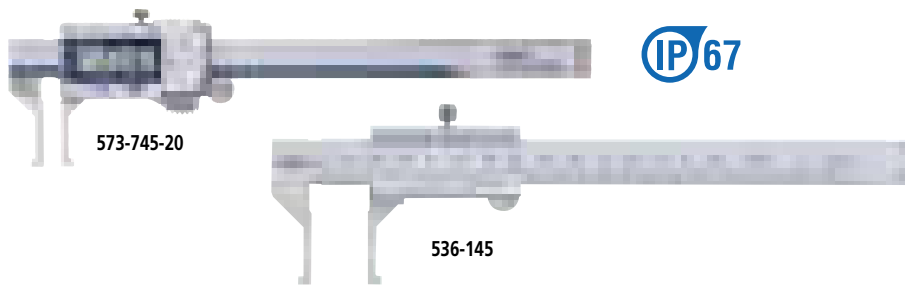

### Point-jaw type

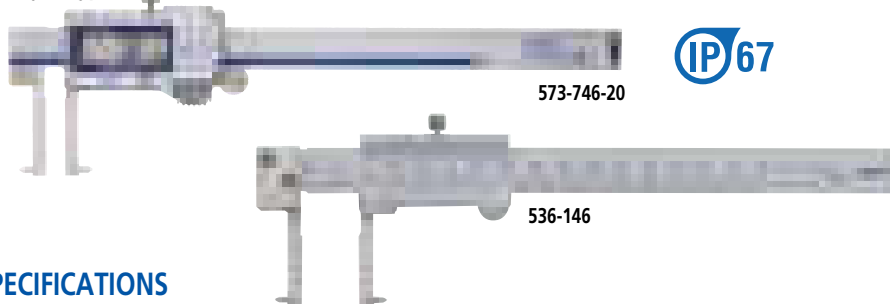

## Technical Data

Accuracy: Refer to the list of specifications  
 Resolution\*: .0005"/0.01mm / 0.01mm  
 Graduation\*\*: 0.05mm  
 Display\*: LCD  
 Length standard\*: ABSOLUTE electrostatic capacitance type linear encoder  
 Max. response speed\*: Unlimited  
 Battery\*: SR44 (1 pc.), **938882**  
 Battery life\*: Approx. 3.5 years under normal use  
 \*Digital models \*\*Analog models

## Function of Digital Model

Origin-set, Zero-setting, Power On/Off, Data output, inch/mm conversion (on inch/metric models only)  
 Alarm: Low voltage, Counting value composition error

## Optional Accessories for Digital Model

- 05CZA624:** SPC cable with data switch (40" / 1m)
- 05CZA625:** SPC cable with data switch (80" / 2m)

## SPECIFICATIONS

Metric		Digital model		
Range	Order No.	Accuracy	Remarks	Mass (g)
10 - 200mm	<b>573-642-20</b>	±0.05mm	Knife-edge type, Measurable min. hole diameter: ø10mm	227
10 - 160mm	<b>573-645-20</b>	±0.05mm	Inside-groove type, Measurable min. hole diameter: ø10mm	147
20 - 170mm	<b>573-646-20</b>	±0.03mm	Point-jaw type, Measurable min. hole diameter: ø20mm	157

Inch/Metric		Digital model		
Range	Order No.	Accuracy	Remarks	Mass (g)
.4" - 8" / 10-200mm	<b>573-742-20</b>	±.002"	Knife-edge type, Measurable min. hole diameter: ø.4"	227
.4" - 6" / 10-150mm	<b>573-745-20</b>	±.002"	Inside-groove type, Measurable min. hole diameter: ø.4"	147
.8" - 6" / 20-150mm	<b>573-746-20</b>	±.0015"	Point-jaw type, Measurable min. hole diameter: ø.8"	157

Metric				
Range	Order No.	Accuracy	Remarks	Mass (g)
10 - 200mm	<b>536-142</b>	±0.12mm	Knife-edge type, Measurable min. hole diameter: ø10mm	210
10 - 150mm	<b>536-145</b>	±0.05mm	Inside groove type, Measurable min. hole diameter: ø10mm	130
20 - 150mm	<b>536-146</b>	±0.05mm	Point jaw type, Measurable min. hole diameter: ø20mm	140
30 - 300mm	<b>536-147</b>	±0.08mm	Point jaw type, Measurable min. hole diameter: ø30mm	370
70 - 450mm	<b>536-148</b>	±0.10mm	Point jaw type, Measurable min. hole diameter: ø70mm	1,250
70 - 600mm	<b>536-149</b>	±0.12mm	Point jaw type, Measurable min. hole diameter: ø70mm	1,430

### Knife-edge type

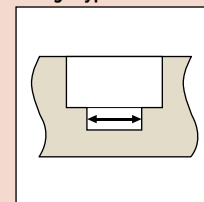

### Inside groove type

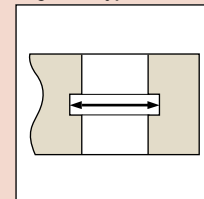

### Point jaw type

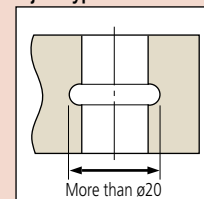

# DIMENSIONS AND MASS

Unit: mm

## Knife-edge type

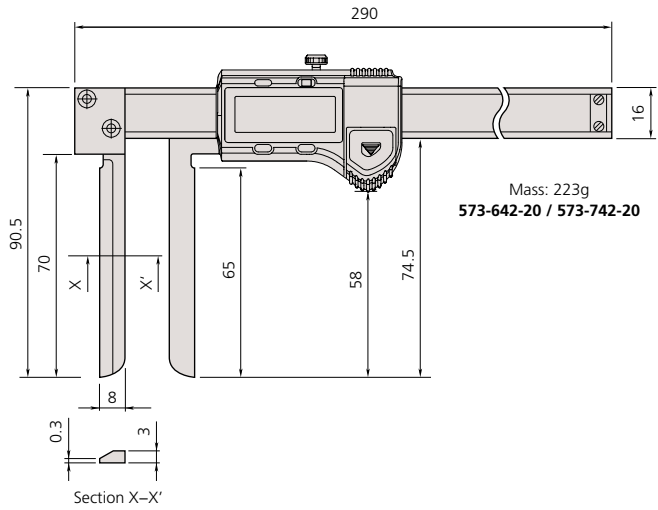
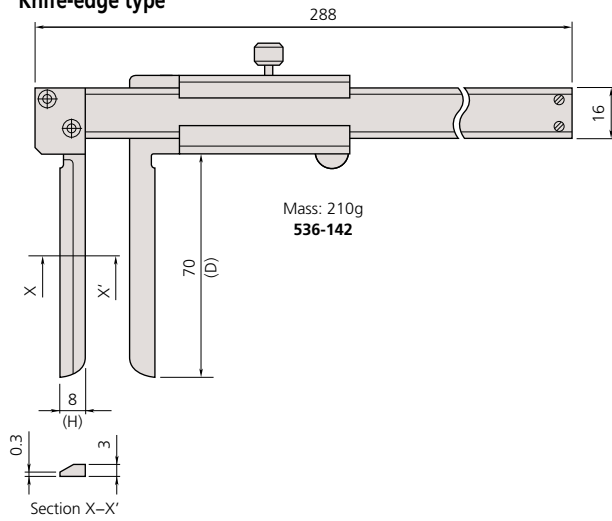

## Inside groove type

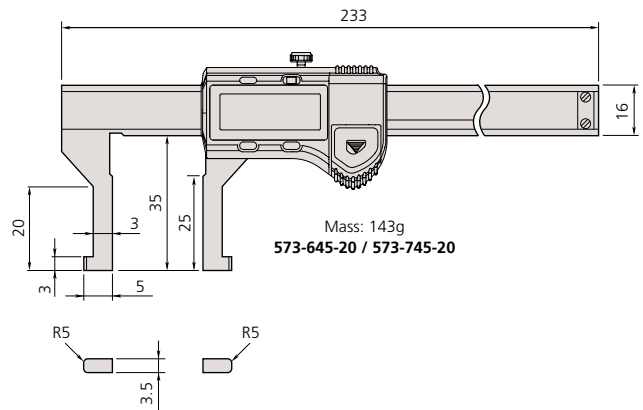
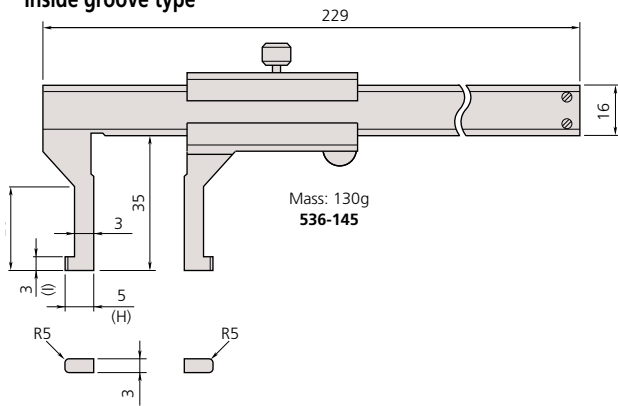

## Point jaw type

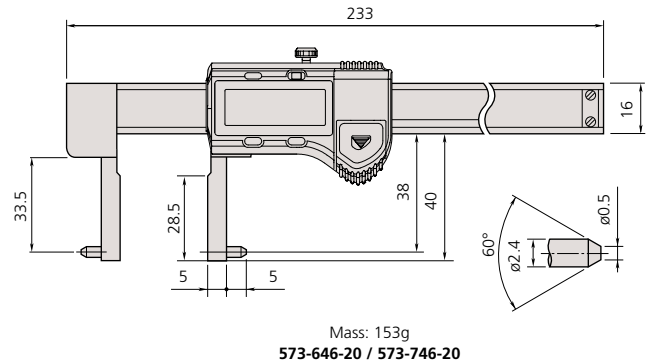
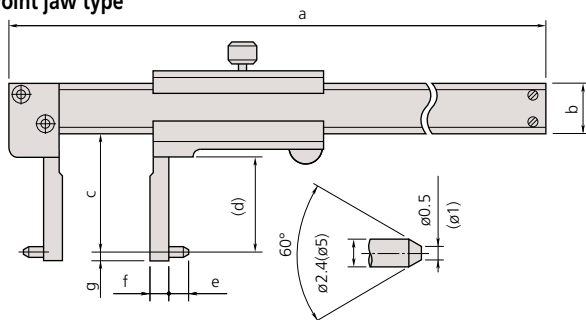

Order No.	Range	a	b	c	d	e	f	g	Mass (g)
536-146	150mm	229	16	38	31	5	5	2	140
536-147	300mm	403	20	98	89	5	10	2	370
536-148	450mm	610	25	145	136	10	25	5	1,250
536-149	600mm	750	25	145	136	10	25	5	1,430

# MyCAL-Lite

## SERIES 700 — Digital Caliper for DIY

### FEATURES

- The MyCAL-Lite is an ideal measuring tool for the DIY market.
- The LCD screen allows error-free readout of measurements.
- With depth measuring bar.

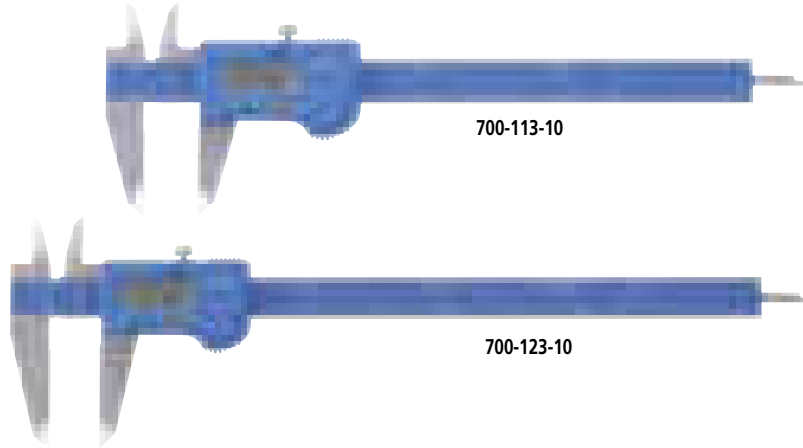

### SPECIFICATIONS

Inch/Metric			
Range	Order No.	Accuracy	Mass (g)
0 - 6" / 0 - 150mm	<b>700-113-10</b>	±.005" / ±0.2mm	150
0 - 8" / 0 - 200mm	<b>700-123-10</b>	±.005" / ±0.2mm	170

### DIMENSIONS

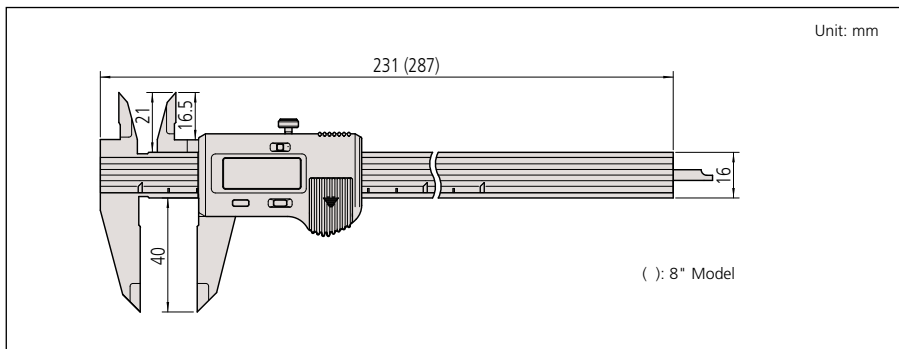

### Technical Data

Accuracy: Refer to the list of specifications  
 Resolution: .001" / 0.1mm  
 Display: LCD  
 Length standard: Electrostatic capacitance type linear encoder  
 Max. response speed: 1800mm/s  
 Battery: SR44 (1 pc.), **938882**  
 Battery life\*: Approx. 2 years under normal use

### Function

Zero-setting, Power on/off  
 inch/mm conversion  
 Alarm: Low voltage, Counting value composition error



# Center Line Gage

## Optional Accessories for Caliper

### FEATURES

Pairs of conical probes are specially designed for Digimatic, Dial and Vernier calipers to quickly measure centerline distances.

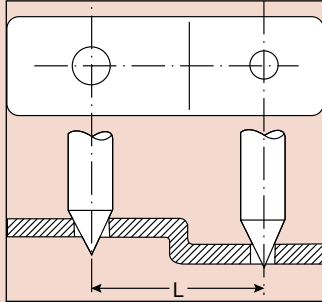

**050001**

Application for 4", 6" and 8" Vernier, Dial and Digimatic Calipers, requiring dimensions over .375".

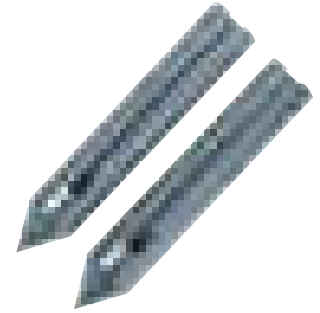

**050018**

Application for 12" Vernier, Dial and Digimatic Calipers requiring dimensions over .5".

### SPECIFICATIONS

Center Line Gage

Order No.	Description
<b>050001</b>	For 4, 6 and 8" Calipers
<b>050018</b>	For 12" Calipers

### DIMENSIONS

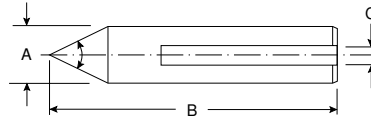

	A	B	C
<b>050001</b>	.375"	2.187"	.141"
<b>050018</b>	.500"	2.75"	.154"

# Depth Base Attachment

## Optional Accessories for Caliper

### FEATURES

- For 4", 6", 8", 12" / 100mm, 150mm, 200mm, 300mm, vernier, dial and digital calipers which have a depth measuring bar.

- Finely grounded base surface and secure locking clamp.

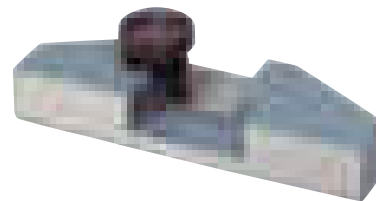

**050084-10**

### SPECIFICATIONS

Inch/Metric

Size	Order No.	Remarks (applicable measuring range of caliper)
3" / 75mm	<b>050083-10</b>	4", 6", 8" / 100mm, 150mm, 200mm
4" / 100mm	<b>050084-10</b>	4", 6", 8" / 100mm, 150mm, 200mm
5" / 125mm	<b>050085-10</b>	12" / 300mm

### DIMENSIONS

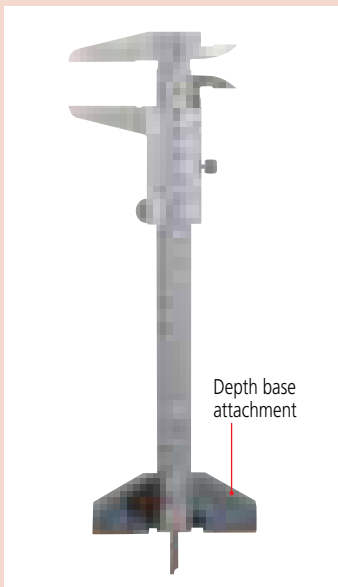
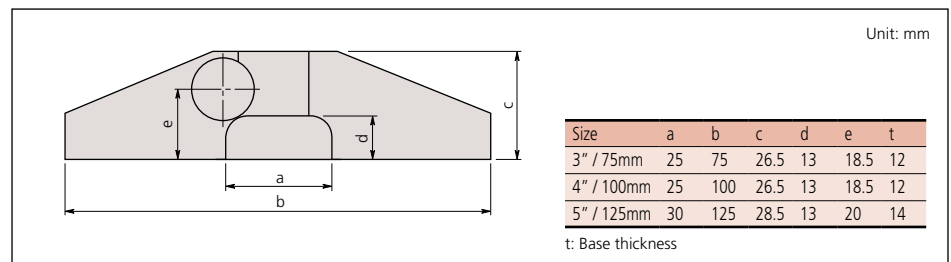

Depth base attachment

# Quick Guide to Precision Measuring Instruments

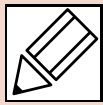

## Calipers

### Nomenclature

#### Vernier Caliper

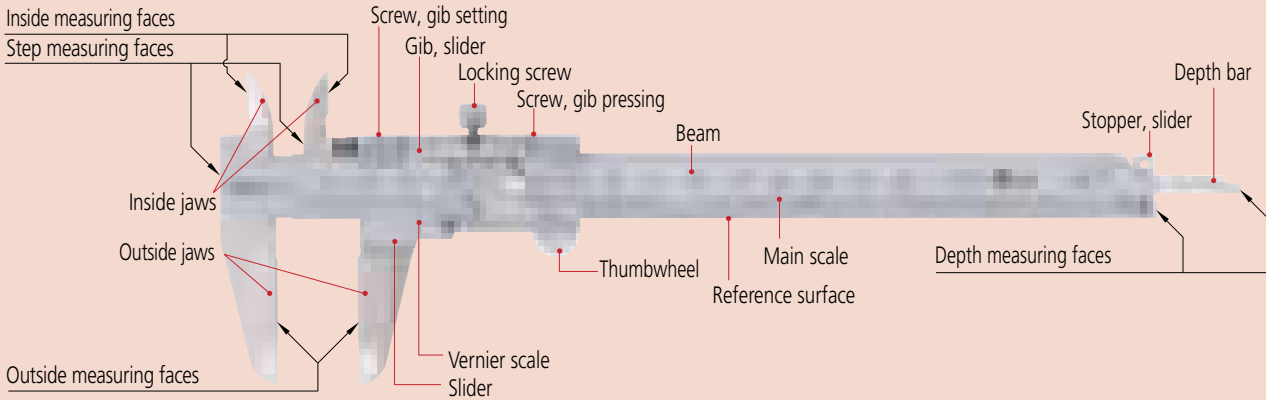

#### Absolute Digimatic Caliper

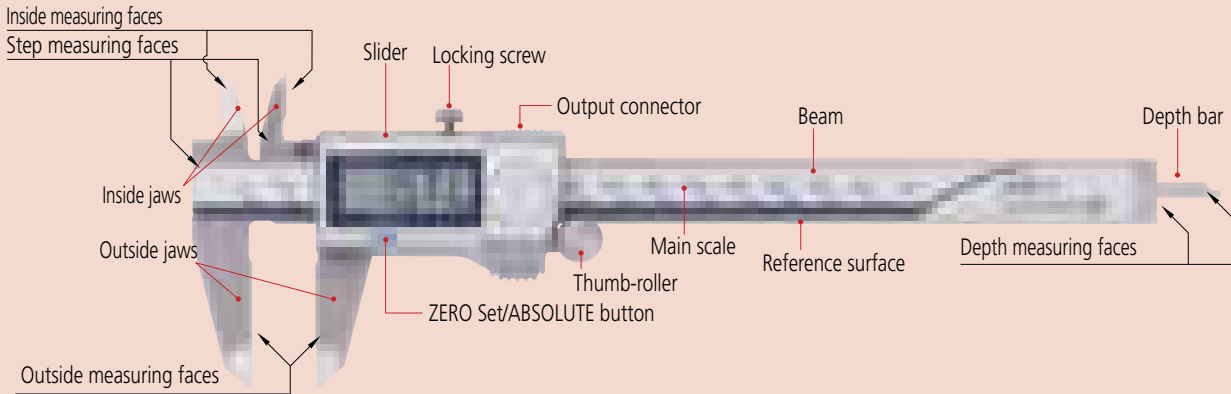

### How to Read the Scale

#### Vernier Calipers

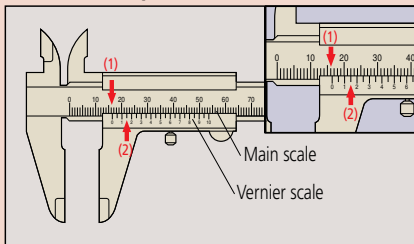

**Graduation 0.05mm**

(1) Main scale	16	mm
(2) Vernier	0.15	mm
Reading	16.15	mm

#### Dial Calipers

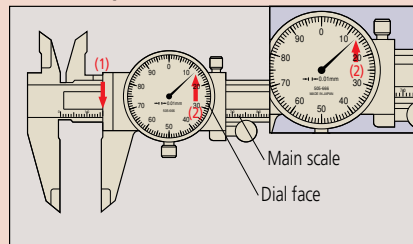

**Graduation 0.01mm**

(1) Main scale	16	mm
(2) Dial face	0.13	mm
Reading	16.13	mm

Note) Above left, 0.15 mm (2) is read at the position where a main scale graduation line corresponds with a vernier graduation line.

### Measurement applications

1. Outside measurement
2. Inside measurement

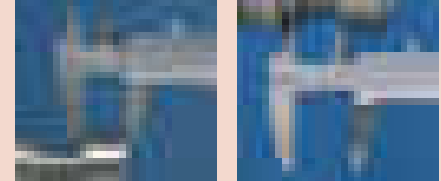

3. Step measurement
4. Depth measurement

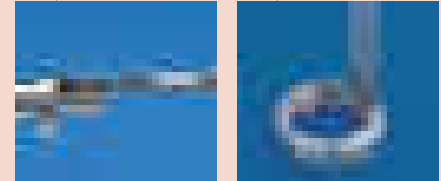

### Special Purpose Caliper Applications

#### Point jaw type

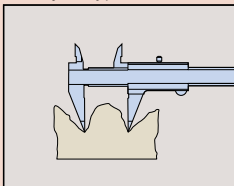

For uneven surface measurement

#### Offset jaw type

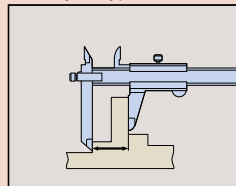

For stepped feature measurement

#### Depth type

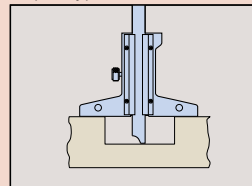

For depth measurement

#### Blade jaw type

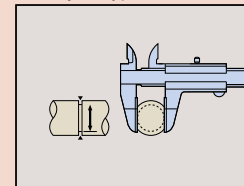

For diameter of narrow groove measurement

## Vernier scale

This is a short auxiliary scale that enables accurate interpolation between the divisions of a longer scale without using mechanical magnification. The principle of operation is that each vernier scale division is slightly smaller than a main scale division, so that successive vernier graduations successively coincide with main scale graduations as one is moved relative to the other. Specifically,  $n$  divisions on a vernier scale are the same length as  $n-1$  divisions on the main scale it works with, and  $n$  defines the division (or interpolation) ratio. Although  $n$  may be any number, in practice it is typically 10, 20, 25, etc., so that the division is a useful decimal fraction. The example below is for  $n = 10$ . The main scale is graduated in mm, and so the vernier scale is 9mm (10 divisions) long, the same as 9mm (9 divisions) on the main scale. This produces a difference in length of 0.1mm (1) as shown in figure A (the 1st vernier graduation is aligned with the first main scale graduation). If the vernier scale is slid 0.1mm to the right as shown in figure B, the 2nd graduation line on the vernier scale moves into alignment with the 2nd line on the main scale (2), and so enables easy reading of the 0.1mm displacement.

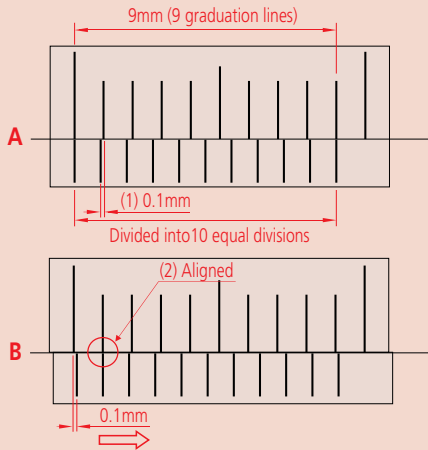

Some early calipers divided 19 divisions on the main scale by 20 vernier divisions to provide 0.05mm resolution. However, the closely spaced lines proved difficult to read and so, since the 1970s, a long vernier scale that uses 39 main scale divisions to spread the lines is generally used instead, as shown below.

### 19mm Vernier scale

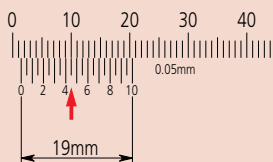

### 39mm vernier scale (long vernier scale)



Calipers were made that gave an even finer resolution of 0.02mm. These required a 49-division vernier scale dividing 50 main scale divisions. However, they were difficult to read and are now hard to find since digital calipers with an easily read display and resolution of 0.01mm appeared.

### C-type

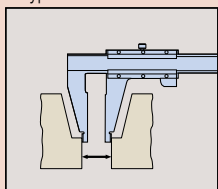

Standard outside measurement  
Inside measurement of a stepped hole  
Measurement of a stepped part

### CN-type

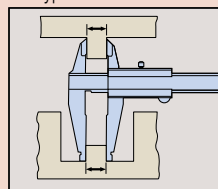

Standard outside measurement  
Measurement of a stepped hole  
Measurement of a stepped part

## About Long Calipers

Steel rules are commonly used to roughly measure large workpieces, but if more accuracy is needed, then a long caliper is suitable for the job. A long caliper is convenient for its user friendliness but does require some care during use. In the first place it is important to realize there is no relationship between resolution and accuracy. For details, refer to the values in our catalog. Resolution is constant whereas the accuracy obtainable varies dramatically according to how the caliper is used.

The measuring method with this instrument is a concern since distortion of the main beam causes a large amount of the measurement error, so accuracy will vary greatly depending on the method used for supporting the caliper at the time. Also, be careful not to use too much measuring force when using the outside measuring faces as they are furthest away from the main beam so potential errors will be at a maximum here. This precaution is also necessary when using the tips of the outside measuring faces of a long-jaw caliper.

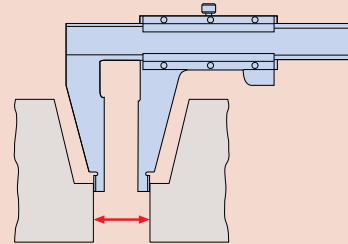

## Small hole measurement with an M-type caliper

Structural error ( $d$ ) occurs when you measure the internal diameter of a small hole.

$\phi D$ : True internal diameter

$\phi d$ : Measured diameter

$t$ ,  $t_c$ : Thickness of the inside jaw

$C$ : Distance between the inside jaws

$\Delta d$ : Measurement error ( $\phi D - \phi d$ )

True internal diameter ( $\phi D$ : 5mm)  
Unit: mm

$t, t_c + C$	0.3	0.5	0.7
$\Delta d$	0.009	0.026	0.047

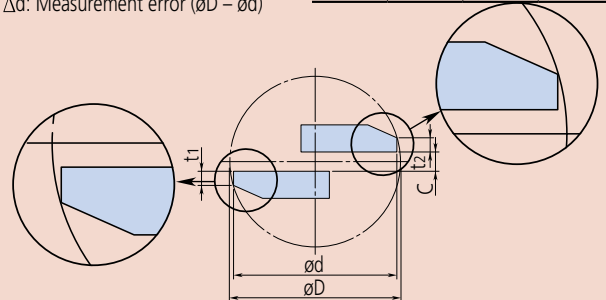

## Inside Measurement with a CM-type Caliper

Because the inside measuring faces of a CM-type caliper are at the tips of the jaws, the measuring face parallelism is heavily affected by measuring force, and this becomes a large factor in the measurement accuracy attainable.

In contrast to an M-type caliper, a CM-type caliper cannot measure a very small hole diameter because it is limited to the size of the stepped jaws, although normally this is not an inconvenience as it would be unusual to have to measure a very small hole with this type of caliper. Of course, the radius of curvature on the inside measuring faces is always small enough to allow correct hole diameter measurements right down to the lowest limit (jaw closure).

Mitutoyo CM-type calipers are provided with an extra scale on the slider for inside measurements so they can be read directly without the need for calculation, just as for an outside measurement. This useful feature eliminates the possibility of error that occurs when having to add the inside-jaw-thickness correction on a single-scale caliper.

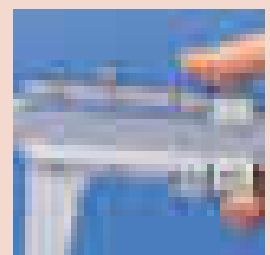
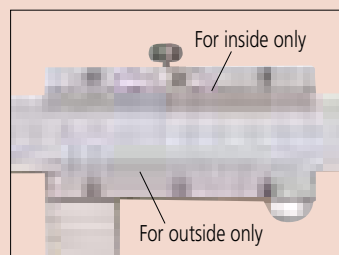

# Linear Height LH-600E

## SERIES 518 — High-Performance 2D Measurement System

### FEATURES

- Excellent accuracy of  $(1.1+0.6L/600)\mu\text{m}$  with  $0.1\mu\text{m}/0.5\mu\text{m}$  resolution/repeatability.
- Perpendicularity (frontal) of  $5\mu\text{m}$  and straightness of  $4\mu\text{m}$  are guaranteed.
- Pneumatic full/semi-floating system allows adjustment of air-cushion height.
- Basic statistical functions are provided and, additionally, RS-232C / USB data output provides the option of evaluating measurement data externally with SPC software on a PC.
- One-key operation for running a semi-automatic measurement.
- Data entry from a Digimatic tool.

With power grip

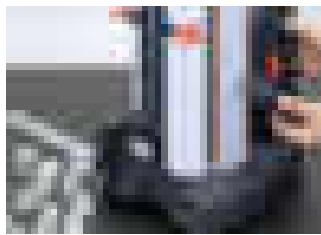

518-351A-21

### SPECIFICATIONS

Inch/Metric		
<b>Order No.</b>		<b>518-351A-21</b> <b>518-352A-21 w/power grip</b>
Model		LH-600E      LH-600EG
Measuring Range (stroke)		0-38" (24") / 0-977mm(600mm)
Resolution (selectable)		.000001" / .00001" / .0001" / .001" / 0.0001mm / 0.001mm / 0.01mm / 0.1mm
Accuracy at 20°C	Measuring accuracy	$(.000043 + .000024 \times L^*/24)" / (1.1 + 0.6L^{**}/600)\mu\text{m}$
	Repeatability (2s)	Plane: .000015" / 0.4μm Bore: .000035" / 0.9μm
	Perpendicularity	.0002" / 5μm
	Straightness	.0002" / 4μm
Drive Method		Motor Drive (5, 10, 15, 20, 25, 30, 40mm/s=7 steps) / manual
Measuring Force		1N
Balancing Method		Counter balance
Main Unit Floating Method		Full/semi-floating with air
Air Source		Built-in air compressor
LCD		TFT LCD (color)
Language for Display		English/German/French/Spanish/Italian/Japanese
Number of Programs		50 (max.)
Number of Datas		60,000 (max.) 1 program 30,000 (Max.)
Power Supply		AC Adapter/Battery (Ni-MH)
Power Consumption		43VA
Operation Time		Approx. 5 hours
Standard Accessories		ø5 Eccentric probe ( <b>12AAF634</b> ) Probe diameter calibration block ( <b>12AAA715</b> ) Battery ( <b>12AAF712</b> ) AC adapter ( <b>357651</b> ), Power Cable ( <b>02ZAA010</b> ) Clear Cover ( <b>223587</b> ) Conveying handle ( <b>510434</b> )
Mass		24kg      24.5kg

L\*=Measuring length (inch) L\*\*=Measuring length (mm)



### Technical Data

Measuring range: 0 - 38" / 0 - 972mm  
 Slider stroke: 24" / 600mm  
 Resolution: .000001" / .00001" / .0001" / .001" or  
 (switchable) 0.0001 / 0.001 / 0.01 / 0.1mm /  
 0.0001 / 0.001 / 0.01 / 0.1mm  
 Accuracy at 20°C: Refer to the list of specifications  
 Floating method: Full / semi-floating with built-in air  
 compressor  
 Display: TFT LCD (color)

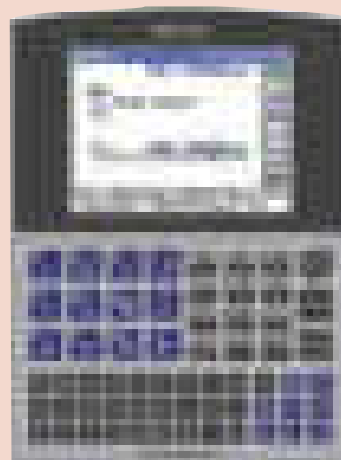
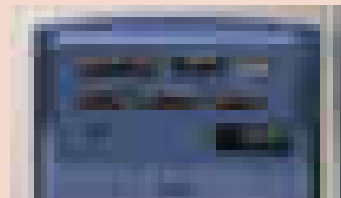
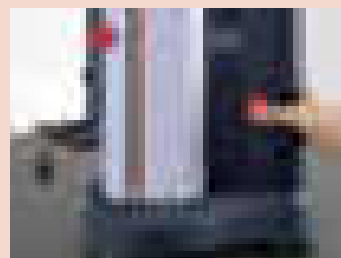

5.7" color LCD

## Optional probes and calibration blocks

### Optional Accessories

- 12AAF712:** Battery pack
- 12AAA797** Thermal printer (120V)
- 12AAA802** Thermal printing paper (10pcs.)
- 12AAA804** Cable for page printer\*\* (2m)
- 12AAA807** RS-232C cable (80" / 2m)
- 12AAA808** RS-232C cable (160" / 4m)

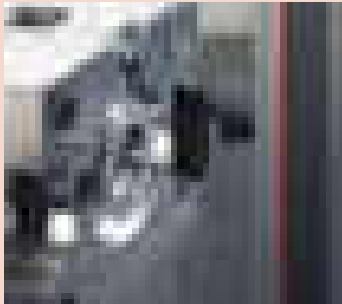
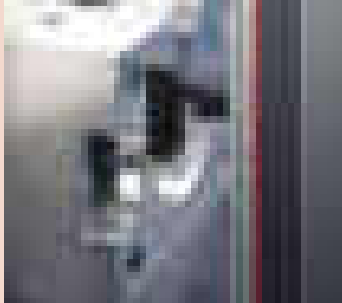

**12AAF666**  
ø1 ball probe

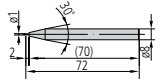

**957261**  
ø2 ball probe

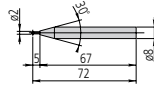

**12AAF667**  
ø2 ruby ball probe

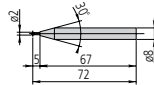

**957262**  
ø3 ball probe

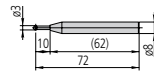

**957263**  
ø4 ball probe

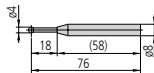

**12AAB552**  
ø10 ball probe, L=55

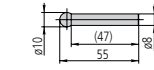

**12AAF668**  
ø10 ball probe, L=82

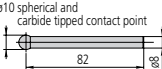

**12AAF669**  
ø10 ball probe, L=120

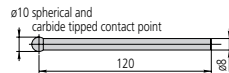

**932361** Mu-checker lever head holder  
CMM ball and disk hard probes are available.

**12AAA787** Block for calibrating probe diameter (applicable to taper probe)

**K650986** Styli Kit M3

**12AAF670**  
ø5 disk probe

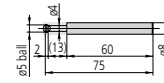

**12AAF671**  
ø10 disk probe

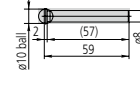

**957264**  
ø14 disk probe

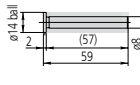

**957265**  
ø20 disk probe

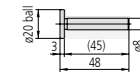

**12AAF672**  
ø1 ball offset probe\*  
\*test indicator stylus (103017)

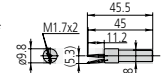

**12AAF673**  
ø2 ball offset probe

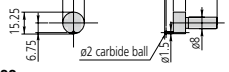

**12AAA788**  
ø4 ball offset probe

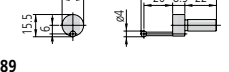

**12AAA789**  
ø6 ball offset probe

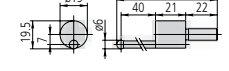

**226117**  
M2 CMM stylus adapter

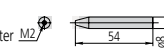

**226118**  
M3 CMM stylus adapter

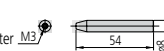

**12AAC072** Depth probe

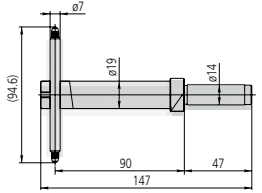

**12AAC073** ø20 taper probe

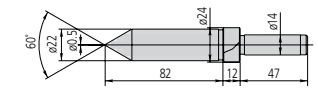

**12AAA792** Dial indicator (ø8 stem) holder

**12AAA837** Dial indicator (ø3/8" stem) holder

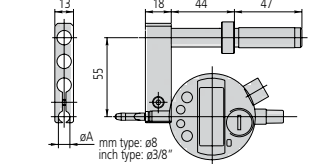

**12AAA793** Probe extension holder (85mm/3.3")

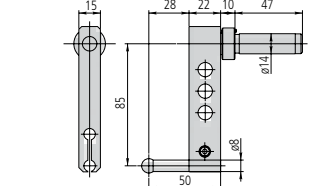

**12AAB136** ø10 cylindrical probe

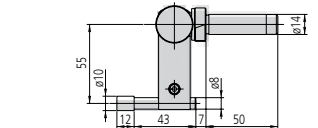

## DIMENSIONS AND MASS

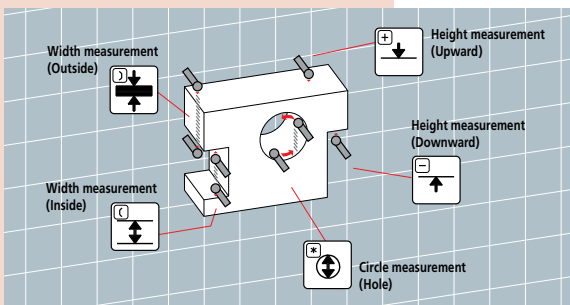
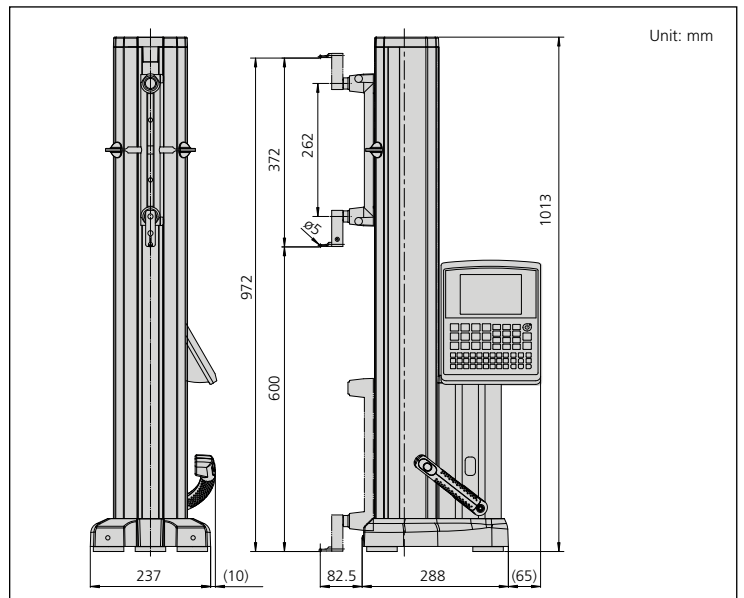

# QM-Height

## SERIES 518 — High-Precision ABSOLUTE Digital Height Gage

### FEATURES

- Newly developed high-accuracy and high-resolution ABSOLUTE linear encoder for position detection.
- Easy reference icon keys.
- Possible to measure inside/outside diameter via unique process (detect the circle apex and process by tracing measurement).
- Various types of optional probes are available.
- Large size LCD.
- Go/no-go judgment is performed by setting the upper and lower tolerances. If a result is out of tolerance, the display changes from green to red, so tolerance judgment can be made at a glance.
- Slider elevation knob (for travel) / wheel (for measurement).
- With SPC and USB output.



### Technical Data

Measuring range\*: 0 - 18.3" or 0 - 28.1"  
 0 - 465mm or 0 - 715mm  
 Slider stroke: 14" / 350mm or 24" / 600mm  
 Resolution: .00005" / .0001" / .0002" / 0.001mm / 0.005mm  
 Accuracy at 20°C: Refer to the list of specifications  
 Guiding method: Roller bearing  
 Drive method: Manual  
 Length standard: ABSOLUTE electromagnetic induction-type linear encoder  
 Measuring force: 1.5±0.5N  
 Display: LCD  
 Power supply: AC adapter (06AEG180JA) 120V battery (LR6x4)  
 Battery operation time: Refer to the list of specifications  
 \* Maximum values are obtained with the probe at the highest position. Any change of the probe orientation requires the coordinate system be re-zeroed. With the probe in the highest position, minimum measurable height is 4.53"/115mm.

### SPECIFICATIONS

Inch/Metric		64PKA094A	64PKA095A	64PKA129A	64PKA130A
Order No.		64PKA094A	64PKA095A	64PKA129A	64PKA130A
Model		QMH-14"A	QMH-24"A	QMH-14"B	QMH-24"B
Range		0 - 14" / 0-350mm	0 - 24" / 0-600mm	0 - 14" / 0-350mm	0 - 24" / 0-600mm
Resolution		0.001 / 0.005mm / .00005" / .0001"			
Accuracy	Accuracy*1	±(2.4+2.1L/600)µm L = Measuring length (mm)			
at 20°C	Repeatability*1	2σ ≤ 1.8µm			
Perpendicularity		7µm	12µm	7µm	12µm
Guiding method		Roller bearing			
Drive method		Manual operation			
Scale type		Electromagnetic induction-type ABSOLUTE linear encoder			
Measuring force		1.5±0.5(N)			
Data output		Digimatic output/USB			
Pneumatic floating system		NA	Included (for movement only)		
Power supply		AC adapter battery / (LR6 x 4) Standard accessory / Nickel metal hydride battery (x4)			
Battery life		Approx. 300 hours (Not using pneumatic floating system)			
		Approx. 80 hours (Using pneumatic floating system regularly)			
Standard accessories		Stepped probe (05HA148) Probe diameter calibration block (12AAA715) LR6 Battery / AC Adapter (06AEG180JA) 120V			
Mass		55.16 lbs (25kg)	63.93 lbs (29kg)	57.32 lbs (26kg)	66.14 lbs (30kg)
Dimensions		41.85"x21.85x18.94" 1063(W)x555(D)x481(H)	51.02"x21.85x18.94" 1296(W)x555(D)x481(H)	41.85"x21.85x18.94" 1063(W)x555(D)x481(H)	51.02"x21.85x18.94" 1296(W)x555(D)x481(H)
Main Unit		518-231	518-233	518-235	518-237

\*1 Guaranteed when using the standard eccentric ø5 probe.



## Optional Accessories

- 12AAC072:** Depth probe
- 12AAA792:** Dial indicator (ø8mm stem) holder
- 12AAA837:** Dial indicator (ø3/8" stem) holder
- 12AAA793:** Probe extension holder (3.3" / 85mm)
- 12AAF667:** ø2mm ruby ball probe
- 957261:** ø2mm ball probe
- 957262:** ø3mm ball probe
- 957263:** ø4mm ball probe
- 05HAA394:** ø5mm ball probe (for 05HZA148)
- 12AAB552:** ø10 mm ball probe, L=55mm
- 12AAF670:** ø5mm ball probe
- 12AAF671:** ø10mm ball probe
- 957264:** ø14mm disk probe
- 957265:** ø20mm disk probe
- 12AAA788:** ø4mm ball offset probe
- 05HAA394:** ø5mm ball offset probe
- 12AAA789:** ø6mm ball offset probe
- 05HZA173:** Scriber
- 264-504-5A:** DP-1VR
- 936937:** SPC cable (40" / 1m)
- 965014:** SPC cable (80" / 2m)

## Circle pitch measurement

The length A, B, C and D can be determined by measuring circles 1 to 3 once each, using the memory of measuring data together with the calculation function. (A maximum of nine circle measurements can be saved.)

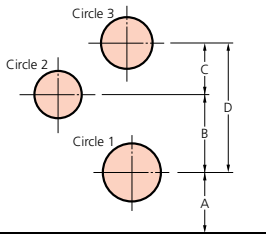

## Maximum/minimum and displacement measurement

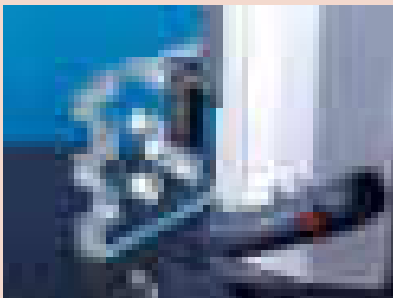
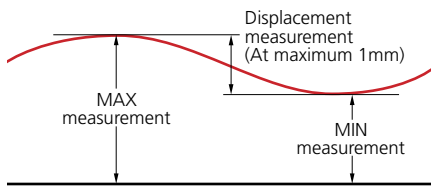

Inside diameter measurement

## DIMENSIONS

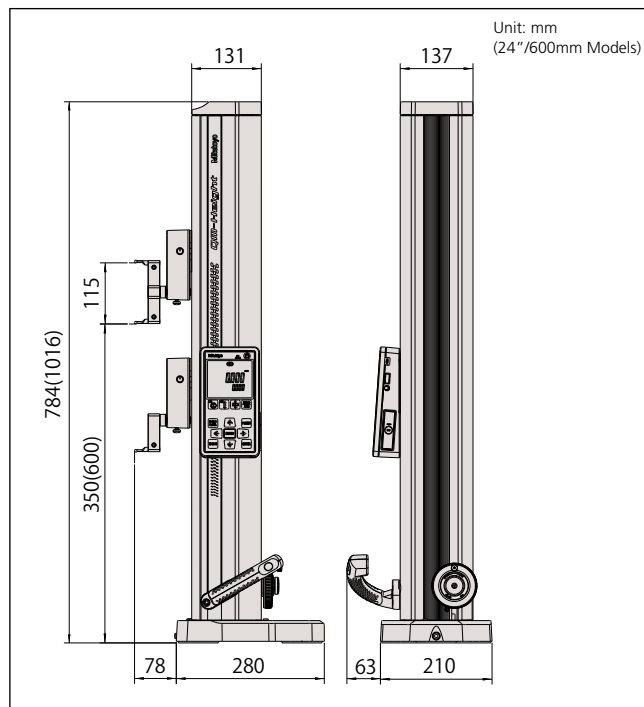

Digimatic mini processor DP-1VR



936937 (1m)  
965014 (2m)

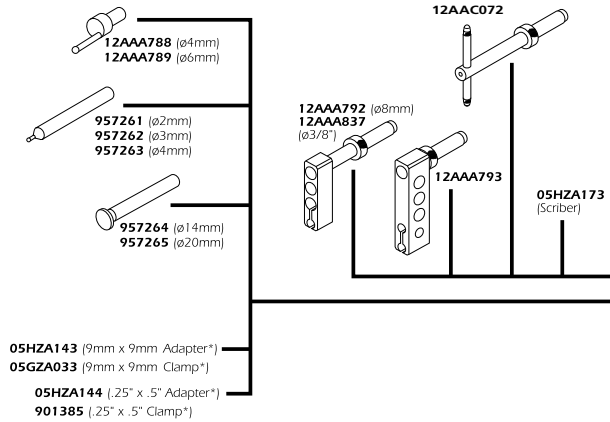

\* Possible to use the scriber for Height Gage.

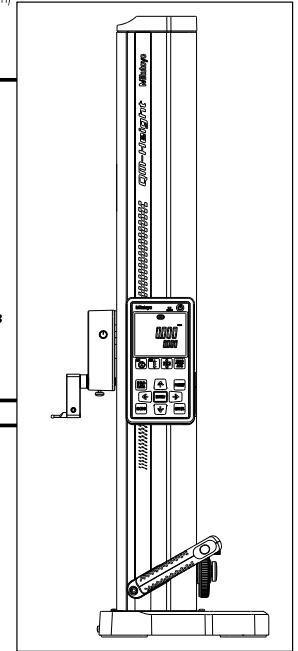

# Digimatic Height Gage

## SERIES 192 — Multi-Function Type with SPC Data Output

### FEATURES

- Highly versatile multi-function type.
- Carbide-tipped long scriber is provided.
- Rigid construction ensures repeatable measurement.
- Switchable resolution (.0002"/0.005mm or .0005"/0.01mm)
- Coarse/fine feed switching.
- Bi-directional touch-signal probe is an optional accessory. It can quickly and accurately measure steps, inside width and outside width.
- With SPC data output.
- Two preset reference heights.

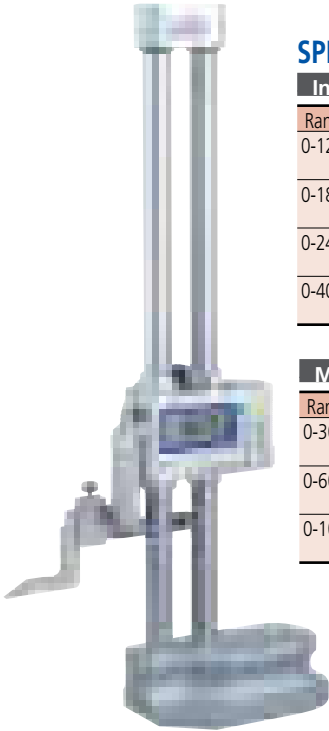

192-670-10

### SPECIFICATIONS

#### Inch/Metric

Range	Order No.	Accuracy	Resolution	Mass (kg)
0-12"/0-300mm	192-670-10	±001"	.0005"(0.01mm) [.0002"(0.005mm) Switchable]	5.7
0-18"/0-450mm	192-671-10	±0015"	.0005"(0.01mm) [.0002"(0.005mm) Switchable]	7.5
0-24"/0-600mm	192-672-10	±0015"	.0005"(0.01mm) [.0002"(0.005mm) Switchable]	8.3
0-40"/0-1000mm	192-673-10	±0025"	.0005"(0.01mm) [.0002"(0.005mm) Switchable]	15.7

#### Metric

Range	Order No.	Accuracy	Resolution	Mass (kg)
0-300mm	192-663-10	±0.02mm	Switchable between 0.01mm and 0.005mm	5.7
0-600mm	192-664-10	±0.04mm	Switchable between 0.01mm and 0.005mm	8.3
0-1000mm	192-665-10	±0.06mm	Switchable between 0.01mm and 0.005mm	15.7

### DIMENSIONS

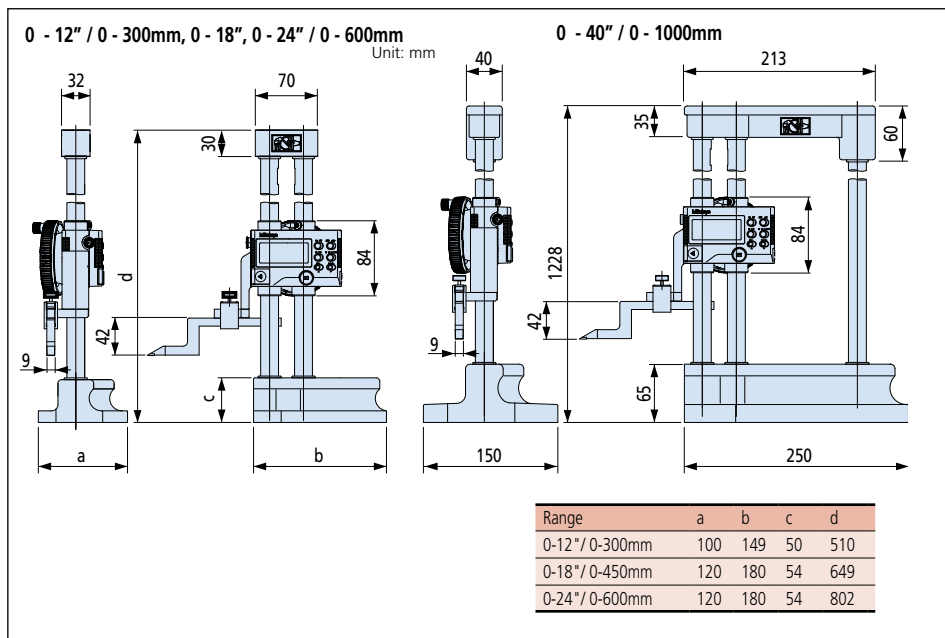

### Technical Data

Accuracy: Refer to the list of specifications  
 Resolution: 0.01+0.005mm or 0.0005"(0.01mm)  
 [0.0002"(0.005mm) switchable]  
 Display: LCD, 7-digits, character height 11mm  
 Max. response speed: 500mm/s  
 Battery: SR44 (1 pc.), **938882**  
 Battery life: Approx. 2000 hours under normal use

### Function

Zero-setting, ABS/INC switching, Two presets, Probe tip diameter compensation, +/- switching, Power ON/OFF, Data hold, Data output, inch/mm conversion (on inch/metric models only)  
 Alarm: Low voltage, Counting value composition error

### Standard Scriber Provided

Metric models: Carbide-tipped scriber (**905200**) and scriber clamp (**05GZA033**)  
 Inch/Metric models: Carbide-tipped scriber (**905201**) and scriber clamp (**901385**)

### Optional Accessories

- 905338:** SPC cable (40" / 1m)
- 905409:** SPC cable (80" / 2m)
- 905691:** SPC cable (L-shape, 40" / 1m)
- 905692:** SPC cable (L-shape, 80" / 2m)
- 192-007:** Bi-directional touch-signal probe (metric)
- 192-008:** Bi-directional touch-signal probe (inch)
- 953638:** Holding bar for test indicator (length: 50mm)
- 900209:** Holding bar for test indicator (length: 100mm)
- 953639:** Holding bar for test indicator (length: 2")
- 900306:** Holding bar for test indicator (length: 4")
- 900321:** Swivel clamp used with holding bar (metric)
- 900322:** Swivel clamp used with holding bar (inch)

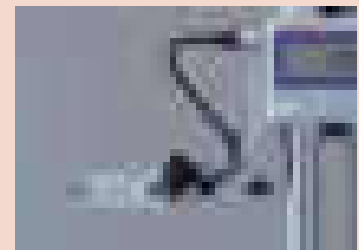

Shown with optional touch-signal probe

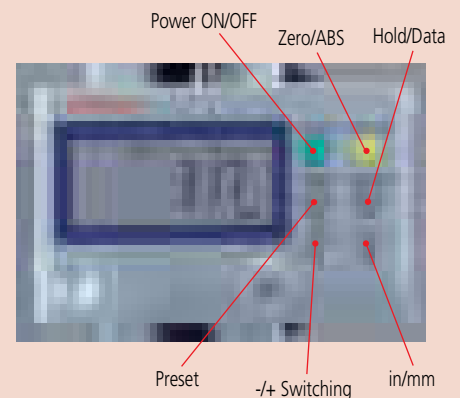



# Digimatic Height Gage

## SERIES 192 — Standard Type with SPC Data Output

### Technical Data

Accuracy: Refer to the list of specifications  
 Resolution: .0005" (0.01mm) [.0002" (0.005mm)]  
 or 0.01mm and 0.005mm  
 Display: LCD, 7-digit, character height 11mm  
 Max. response speed: 500mm/s  
 Battery: SR44 (1 pc.), **938882**  
 Battery life: Approx. 2000 hours under normal use

### Function

Zero-setting, ABS/INC switching, Two presets, Probe tip diameter compensation, +/- switching, Power ON/OFF, Data hold, With Output, inch/mm conversion (on inch/metric models only)  
 Alarm: Low voltage, Counting value composition error

### Standard Scriber Provided

Metric models: Carbide-tipped scriber (**07GZA000**) and scriber clamp (**05GZA033**)  
 Inch/Metric models: Carbide-tipped scriber (**900258**) and scriber clamp (**901385**)

### Optional Accessories

**953638:** Holding bar for test indicator (length: 50mm)  
**900209:** Holding bar for test indicator (length: 100mm)  
**953639:** Holding bar for test indicator (length: 2")  
**900306:** Holding bar for test indicator (length: 4")  
**900321:** Swivel clamp used with holding bar (metric)  
**900322:** Swivel clamp used with holding bar (inch)  
**905338:** SPC cable (CD type) 1m  
**905409:** SPC cable (CD type) 2m  
**905691:** CD/Connecting cable L-Type 1m RIG  
**905692:** CD/Connecting cable L-Type 2m RIG

### FEATURES

- Switchable resolution (.0002"/0.005mm or .0005"/0.01mm)
- Easy-to-use standard type.
- Carbide-tipped scriber is provided.
- Double-column structure ensures high measuring accuracy.
- Coarse/fine feed switching.
- Two preset reference heights.

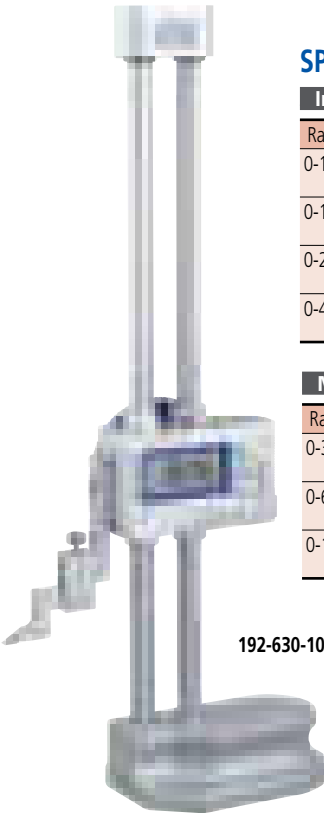

### SPECIFICATIONS

Inch/Metric				
Range	Order No.	Accuracy	Resolution	Mass (kg)
0-12"/0-300mm	<b>192-630-10</b>	±001"	.0005" (0.01mm) [.0002" (0.005mm) Switchable]	4.7
0-18"/0-450mm	<b>192-631-10</b>	±002"	.0005" (0.01mm) [.0002" (0.005mm) Switchable]	7.5
0-24"/0-600mm	<b>192-632-10</b>	±002"	.0005" (0.01mm) [.0002" (0.005mm) Switchable]	8.3
0-40"/0-1000mm	<b>192-633-10</b>	±003"	.0005" (0.01mm) [.0002" (0.005mm) Switchable]	15.7

Metric				
Range	Order No.	Accuracy	Resolution	Mass (kg)
0-300mm	<b>192-613-10</b>	±0.02mm	Switchable between 0.01mm and 0.005mm	4.7
0-600mm	<b>192-614-10</b>	±0.05mm	Switchable between 0.01mm and 0.005mm	8.3
0-1000mm	<b>192-615-10</b>	±0.07mm	Switchable between 0.01mm and 0.005mm	15.7

### DIMENSIONS

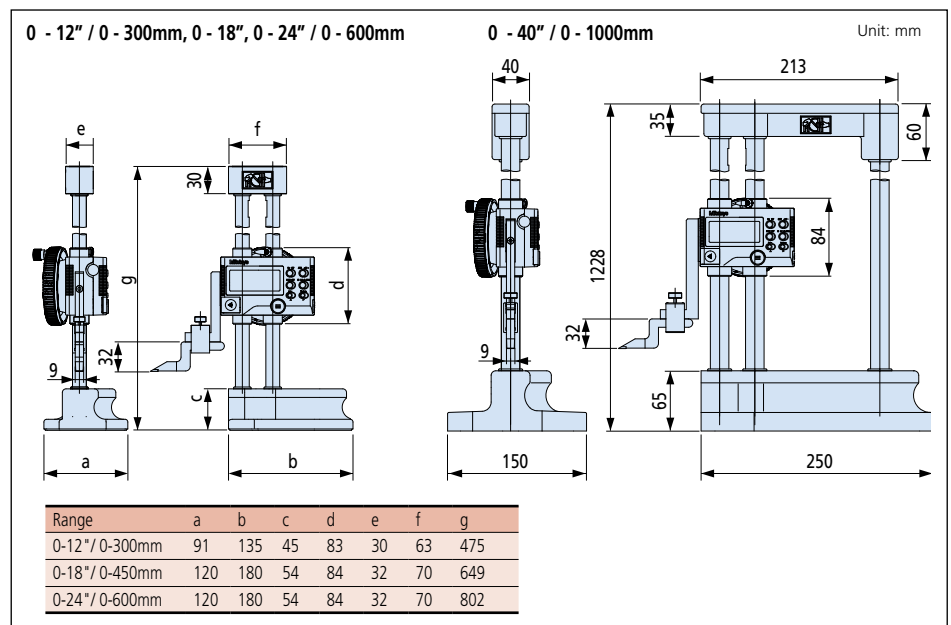

# Dial Height Gage

**SERIES 192 — with Digital Counter**

## FEATURES

- Easy and error-free reading with both up and down digital counters, as well as a dial.
- Provided with a feed wheel for easy coarse feeding.
- Carbide-tipped scriber is provided.
- The counters and dial can be re-zeroed at any scriber position.

## SPECIFICATIONS

### Metric

Range	Order No.	Accuracy	Graduation	Mass (kg)
0 - 300mm	<b>192-130</b>	±0.03mm	0.01mm	4.2
0 - 450mm	<b>192-131</b>	±0.05mm	0.01mm	9.2
0 - 600mm	<b>192-132</b>	±0.05mm	0.01mm	9.8
0 - 1000mm	<b>192-133</b>	±0.07mm	0.01mm	17.0

### Inch

Range	Order No.	Accuracy	Graduation	Mass (kg)
0 - 12"	<b>192-150</b>	±.0015"	.001"	4.2
0 - 18"	<b>192-151</b>	±.002"	.001"	9.2
0 - 24"	<b>192-152</b>	±.002"	.001"	9.8
0 - 40"	<b>192-153</b>	±.003"	.001"	17.0

## DIMENSIONS

0 - 12" / 0 - 300mm, 0 - 18" / 0 - 450mm  
0 - 24" / 0 - 600mm

0 - 40" / 0 - 1000mm

Unit: mm

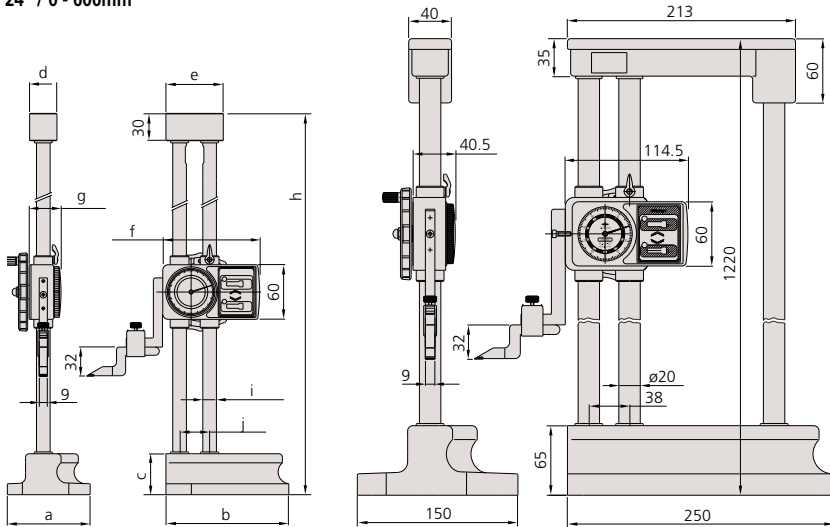

Range	a	b	c	d	e	f	g	h	i	j
0-12" / 0-300mm	91	135	45	30	63	106.5	35.5	470	ø15	33
0-18" / 0-450mm	120	180	54	32	70	114.5	40.5	645	ø20	38
0-24" / 0-600mm	120	180	54	32	70	114.5	40.5	798	ø20	38



## Technical Data

Dial reading: 0.01mm or .001"

## Standard Scriber Provided

Metric models: Carbide-tipped scriber (**07GZA000**) and scriber clamp (**05GZA033**)  
Inch/Metric models: Carbide-tipped scriber (**900258**) and scriber clamp (**901385**)

## Dimension of scriber

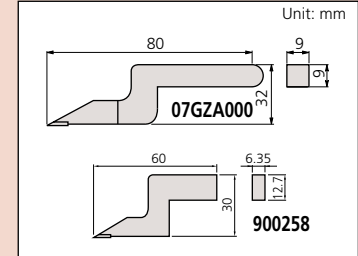

## Optional Accessories

- 953638:** Holding bar for test indicator (length: 50mm)
- 900209:** Holding bar for test indicator (length: 100mm)
- 953639:** Holding bar for test indicator (length: 2")
- 900306:** Holding bar for test indicator (length: 4")
- 900321:** Swivel clamp used with holding bar (metric)
- 900322:** Swivel clamp used with holding bar (inch)

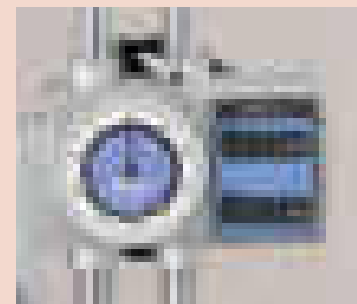
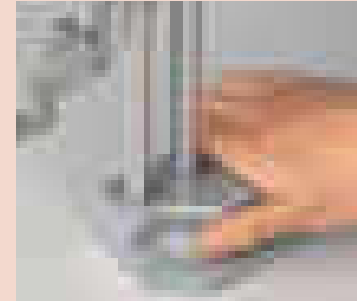



# ABSOLUTE Digimatic Height Gage

**SERIES 570 — with ABSOLUTE Linear Encoder**

## FEATURES

- Built-in ABSOLUTE linear encoder  
This encoder eliminates the necessity of setting the reference point at every power-on. It has improved reliability because no over-speed error will occur.
- Fine-adjustment carriage for smooth movement.
- Carbide-tipped scriber is provided.
- With SPC data output.

## Technical Data

Accuracy: Refer to the list of specifications  
 Resolution: .0005"/0.01mm or 0.01mm  
 Display: LCD, 6-digit  
 Length standard: ABSOLUTE electrostatic capacitance type linear encoder  
 Max. response speed: Unlimited  
 Battery: SR44 (1 pc.), **938882**  
 Battery life: Approx. 5000 hours under normal use

## Function

Origin setting, ABS/INC switching, Presetting, +/- switching, Data hold, Data output, inch/mm conversion (on inch/metric models only)  
 Alarm: Low voltage, Counting value composition error

## Standard Scriber Provided

Metric models: Carbide-tipped scriber (**900173/905200\***) and scriber clamp (**901338/05GZA033\***)  
 \*0 - 1000mm model  
 Inch/Metric models: Carbide-tipped scriber (**900173/905201\***) and scriber clamp (**901338/901385\***)  
 \*0 - 40" model

## Dimension of scriber

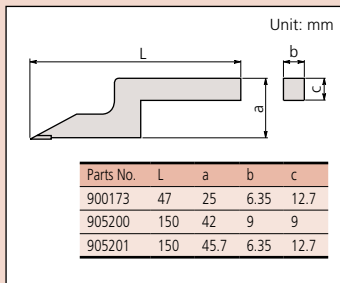

## Optional Accessories

- 905338:** SPC cable (40" / 1m)
- 905409:** SPC cable (80" / 2m)
- 953638:** Holding bar for test indicator (length: 50mm)
- 953639:** Holding bar for test indicator (length: 2")
- 902053:** Swivel clamp used with holding bar (metric)
- 900322:** Swivel clamp used with holding bar (inch)



## SPECIFICATIONS

Metric				
Range	Order No.	Accuracy	Resolution	Mass (kg)
0 - 200mm	<b>570-227</b>	±0.03mm	0.01mm	1.4
0 - 1000mm	<b>570-230</b>	±0.07mm	0.01mm	16.8

Inch/Metric				
Range	Order No.	Accuracy	Resolution	Mass(kg)
0 - 8" / 0 - 200mm	<b>570-244</b>	±.001"	.0005" / 0.01mm	1.4
0 - 40" / 0 - 1000mm	<b>570-248</b>	±.003"	.0005" / 0.01mm	16.8

## DIMENSIONS

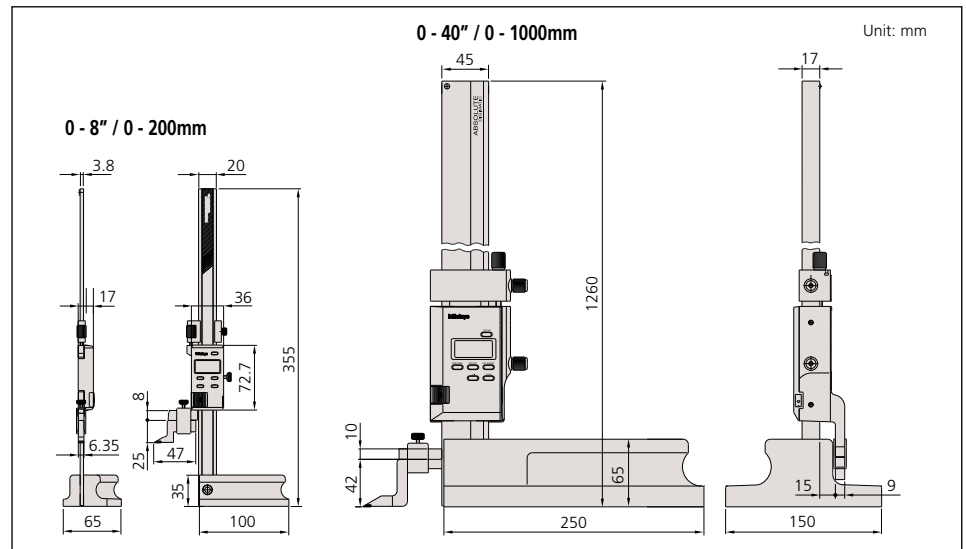

# ABSOLUTE Digimatic Height Gage

**SERIES 570 — with ABSOLUTE Linear Encoder**



## FEATURES

- Built-in ABSOLUTE linear encoder  
This encoder eliminates the necessity of setting the reference point at every power-on. It has improved reliability because no over-speed error will occur.
- Rigid column structure ensures high measuring accuracy.
- With large, smooth slider-feed wheel.
- Carbide-tipped scriber is provided.
- With SPC data output.

## Technical Data

Accuracy: Refer to the list of specifications  
 Resolution: .0005"/0.01mm or 0.01mm  
 Display: LCD, 6-digit  
 Length standard: ABSOLUTE electrostatic capacitance-type linear encoder  
 Max. response speed: Unlimited  
 Battery: SR44 (1 pc.), **938882**  
 Battery life: Approx. 20000 hours under normal use

## Function

Origin setting, ABS/INC switching, Power ON/OFF, Data hold, Data output, inch/mm conversion (on inch/metric models only)  
 Alarm: Low voltage, Counting value composition error

## Standard Scriber Provided

Metric models: Carbide-tipped scriber (**07GZA000**), scriber clamp (**05GZA033**)  
 Inch/Metric models: Carbide-tipped scriber (**900258**), scriber clamp (**901385**)

## Dimension of scriber

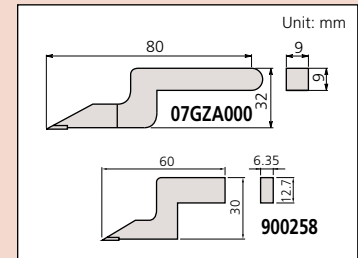

## Optional Accessories

- 905338:** SPC cable (40" / 1m)  
**905409:** SPC cable (80" / 2m)  
**953638:** Holding bar for test indicator (length: 50mm)  
**953639:** Holding bar for test indicator (length: 2")  
**902053:** Swivel clamp used with holding bar (metric)  
**900322:** Swivel clamp used with holding bar (inch)

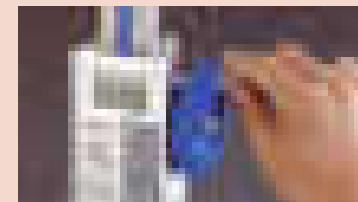

Large, smooth slider-feed wheel

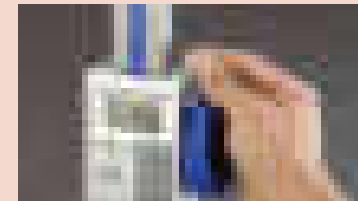

Large clamp lever

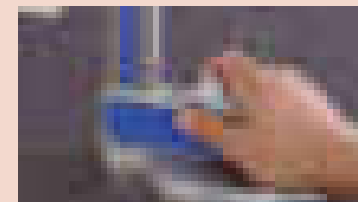

Comfortable grip base

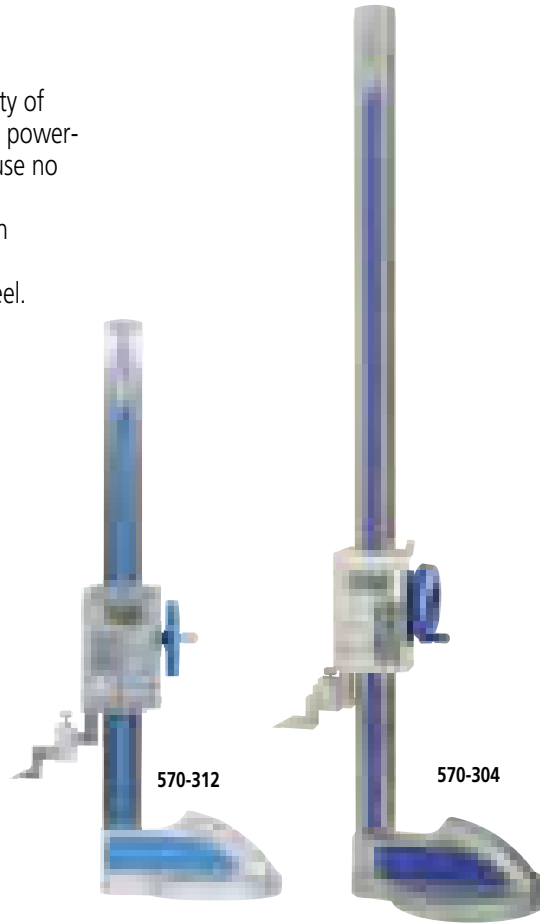
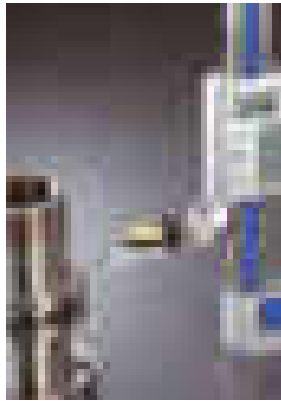

## SPECIFICATIONS

Metric			
Range	Order No.	Accuracy	Resolution
0 - 300mm	<b>570-302</b>	±0.03mm	0.01mm
0 - 600mm	<b>570-304</b>	±0.05mm	0.01mm

Inch/Metric			
Range	Order No.	Accuracy	Resolution
0 - 12" / 0 - 300mm	<b>570-312</b>	±.0015"	.0005" / 0.01mm
0 - 18" / 0 - 450mm	<b>570-313</b>	±.002"	.0005" / 0.01mm
0 - 24" / 0 - 600mm	<b>570-314</b>	±.002"	.0005" / 0.01mm

## DIMENSIONS AND MASS

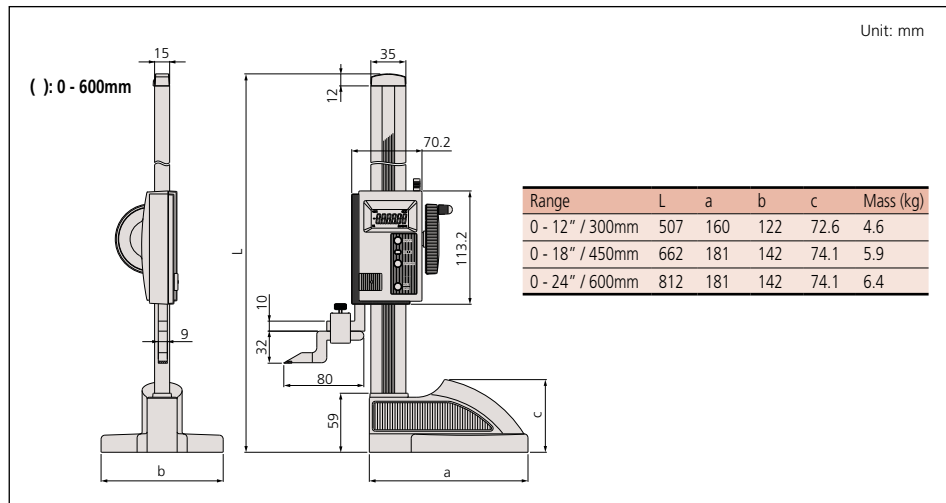

## Technical Data

Main scale adjustment: 15mm or 25mm  
Slider fine feed: 4mm, 6mm, 7mm or 20mm

## Standard Scriber Provided

Up to 600mm: Carbide-tipped scriber (**07GZA000**) and scriber clamp (**05GZA033**)  
0 - 1000mm: Carbide-tipped scriber (**905200**) and scriber clamp (**05GZA033**)  
0 - 1500mm: Carbide-tipped scriber (**900390**) and scriber clamp (**905008**)

## Dimension of scriber

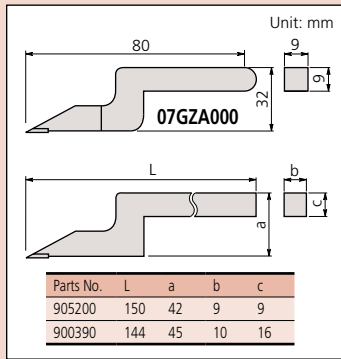

## Optional Accessories

**07GZA003**: Magnifier for 300, 450mm, 600mm models  
**07GZA015**: Magnifier for 1000mm and 1500mm models  
**953638**: Holding bar for test indicator (length: 50mm)  
**902053**: Swivel clamp used with holding bar

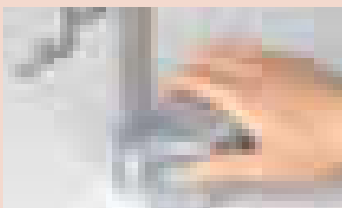
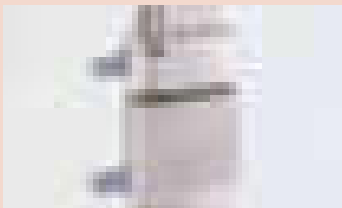
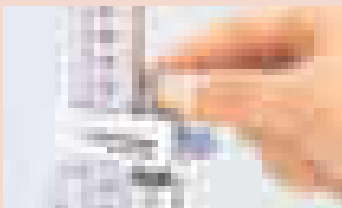
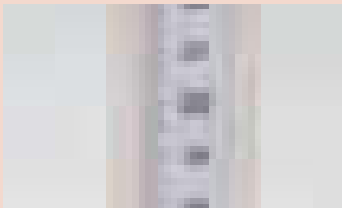

# Vernier Height Gage

## SERIES 514 — Standard Height Gage with Adjustable Main Scale

## FEATURES

- Zero reference point can be adjusted.
- Satin chrome-finished scales for glare-free reading.
- Extra-large base for rigidity.
- Optional magnifier for easier reading
- Carbide-tipped scriber is provided.

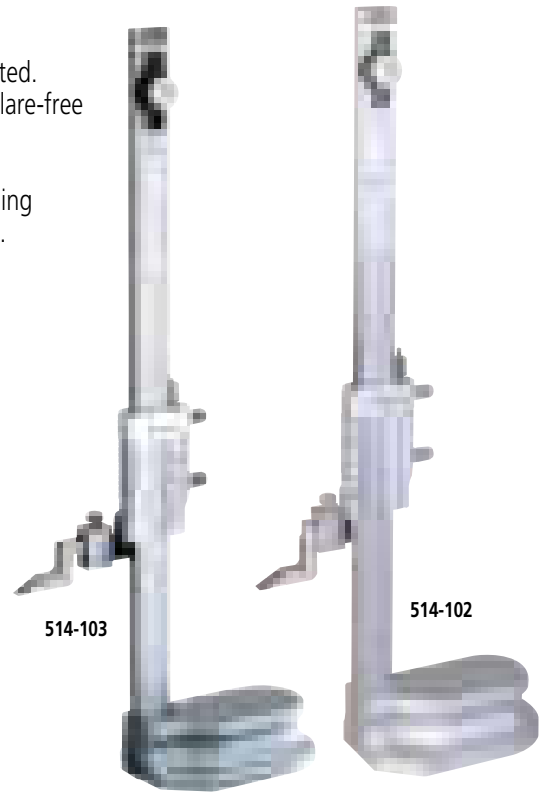

## SPECIFICATIONS

Metric				
Range	Order No.	Accuracy	Graduation	Mass (kg)
0 - 300mm	<b>514-102</b>	±0.04mm	0.02mm	3.1
0 - 450mm	<b>514-104</b>	±0.05mm	0.02mm	3.4
0 - 600mm	<b>514-106</b>	±0.05mm	0.02mm	7.4
0 - 1000mm	<b>514-108</b>	±0.07mm	0.02mm	20.0
0 - 1500mm	<b>514-170</b>	±0.18mm	0.02mm	26.0

## Inch/Metric — Inch model with inch/metric dual scale

Range	Order No.	Accuracy	Graduation	Mass (kg)
0 - 12" / 0 - 300mm	<b>514-103</b>	±.002"	.001" / 0.02mm	3.1
0 - 18" / 0 - 450mm	<b>514-105</b>	±.002"	.001" / 0.02mm	3.4
0 - 24" / 0 - 600mm	<b>514-107</b>	±.002"	.001" / 0.02mm	7.4
0 - 40" / 0 - 1000mm	<b>514-109</b>	±.003"	.001" / 0.02mm	20.0

## DIMENSIONS

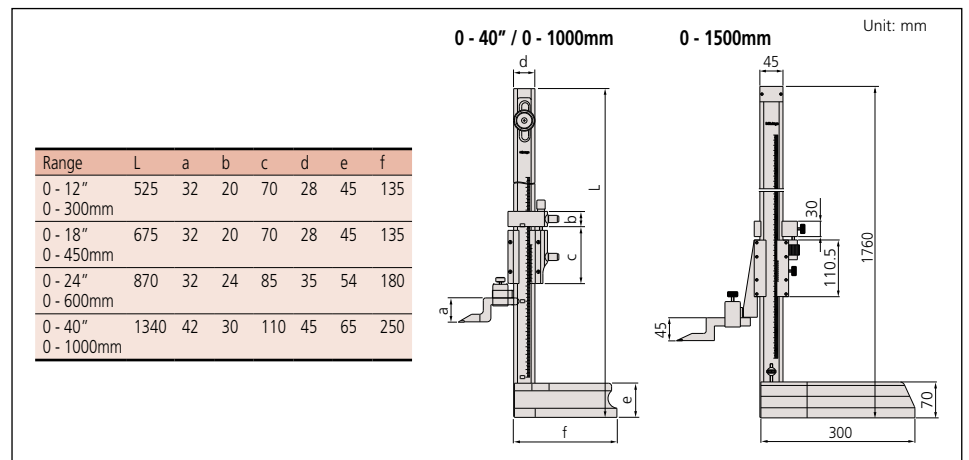

# Vernier Height Gage

## SERIES 506 — Light-Weight Height Gage

### FEATURES

- The Light-Weight Height Gage is designed for scribing from a vertical base or for small parts.
- Satin chrome-finished scales for glare-free reading.
- Beam and slider are made of stainless steel.
- Carbide-tipped scriber is provided.

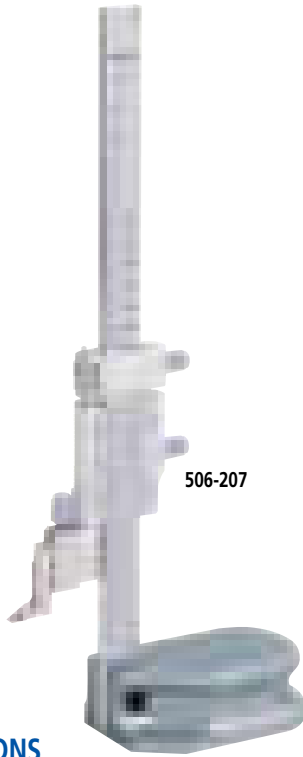

506-207



506-208

### SPECIFICATIONS

#### Metric

Range	Order No.	Accuracy	Graduation	Mass (kg)
0 - 200mm	506-207	±0.03mm	0.02mm	1.4

#### Inch/Metric — Inch model with inch/metric double scale

Range	Order No.	Accuracy	Graduation	Mass (kg)
0 - 8" / 0 - 200mm	506-208	±.001"	.001" / 0.02mm	1.4

### DIMENSIONS

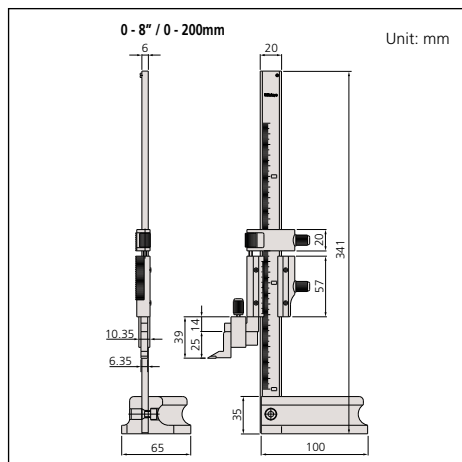

### Standard Scriber Provided

Carbide-tipped scriber (900173) and scriber clamp (901338)

### Dimension of scriber

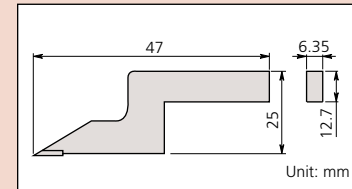

### Optional Accessories

- 953639: Holding bar for test indicator (length: 2" / 50mm)
- 900322: Swivel clamp used with holding bar

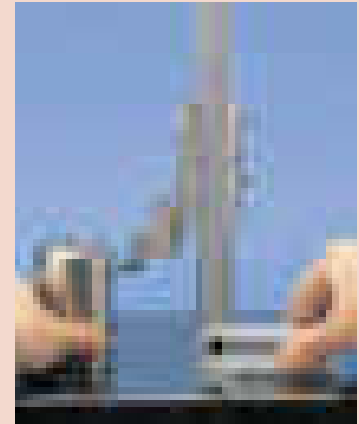

# Carbide-Tipped Scriber

## Optional Accessory for Height Gage

### FEATURES

- Use the appropriate scriber and clamp for each height gage.

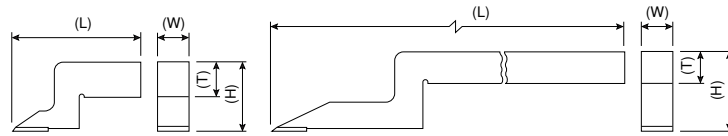

### DIMENSIONS

#### Metric

Scriber Order No.	Clamp Order No.	Scriber Dimensions (mm)			
		Length	Height	Width	Thickness
900167	05GZA033	143	23	9	9
07GZA000	07GZA002	80	32	9	9
905200	05GZA033	150	42	9	9
900390	905008	144	45	10	16

#### Inch

Scriber Order No.	Clamp Order No.	Scriber Dimensions (inch)			
		Length	Height	Width	Thickness
900258	901385	2.4	1.2	.25	.5
905201	901385	5.9	1.77	.25	.5
900172	901385	5.3	1.0	.25	.5
900173	901338	1.9	1.0	.25	.5

## Optional Accessories

### Optional Accessories for Height Gage

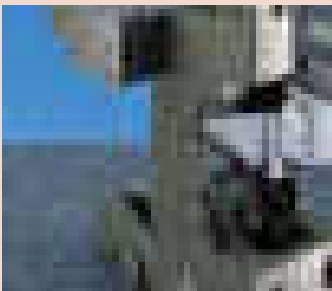

#### Center Master

- Allows quick measurement of center-to-center distance between holes.
- Measurable hole diameters: .040" to 1.50" /  $\varnothing$ 1 -  $\varnothing$ 38mm.

### SPECIFICATIONS

Order No.	Remarks
951144	With metric-type holding bar (9x9mm cross-section)
900581	With inch-type holding bar (.25x.5" cross-section)

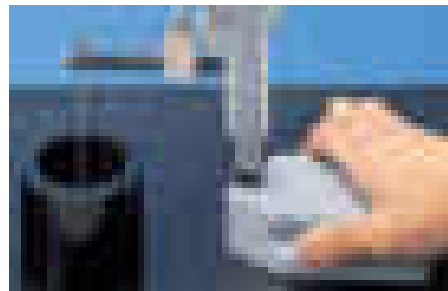
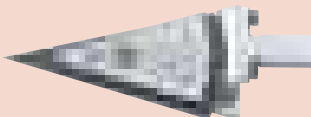

#### Depth Gage Attachment

- Attached to a height gage to measure groove and hole depth.
- Minimum hole diameter: 5.5mm
- Maximum distance from the bottom of the holding bar to the contact point: 2.95" (inch type), 80mm (metric type)
- Uses standard dial indicator points.

### SPECIFICATIONS

Order No.	Remarks
900764	With metric-type holding bar (9x9mm cross-section)
900878	With inch-type holding bar (.25x.5" cross-section)

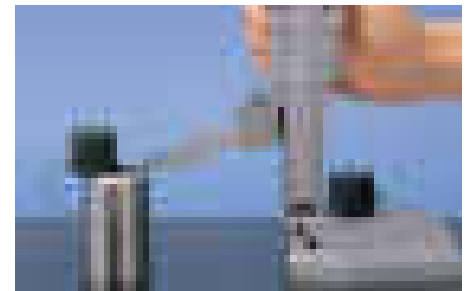

#### Contact Sensor

- The contact sensor eliminates errors caused by jacking-up the height gage while taking measurements. When the scriber of a height gage touches a conductive workpiece, an indicator will light up to indicate that measurement can be taken, which results in consistent height measurement.

### SPECIFICATIONS

Order No.	Remarks
900872	Battery (2pcs. SR44, required) is not included

# Quick Guide to Precision Measuring Instruments

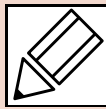

## Height Gages

### How to read

#### Vernier Height gage

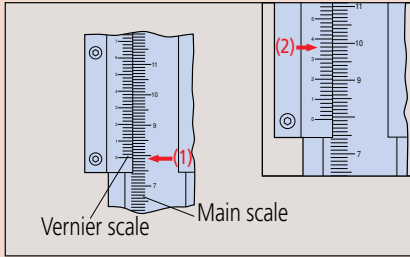

**Graduation 0.02mm**

(1) Main scale	79 mm
(2) Vernier	0.36 mm
Reading	79.36 mm

### General notes on use of Height Gages

#### 1. Potential causes of error

Like the caliper, the error factors involved include parallax effects, error caused by excessive measuring force due to the fact that a height gage does not conform to Abbe's Principle, and differential thermal expansion due to a temperature difference between the height gage and workpiece.

There are also other error factors caused by the structure of the height gage. In particular, the error factors related to a warped reference edge and scriber installation described below should be studied before use.

#### 2. Reference edge (column) warping and scriber installation

Like the caliper, and as shown in the following figure, measurement errors result when using the height gage if the reference column, which guides the slider, becomes warped. This error can be represented by the same calculation formula for errors caused by nonconformance to Abbe's Principle.

$$f = h \theta = h \frac{a}{L}$$

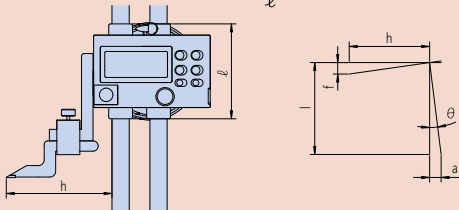

Installing the scriber (or a lever-type dial indicator) requires careful consideration because it affects the size of any error due to a warped reference column by increasing dimension h in the above formula. In other words, if an optional long scriber or lever-type dial indicator is used, the measurement error becomes larger.

Example: Effect of measuring point position

When h is 150 mm, the error is 1.5 times larger than when h is 100 mm.

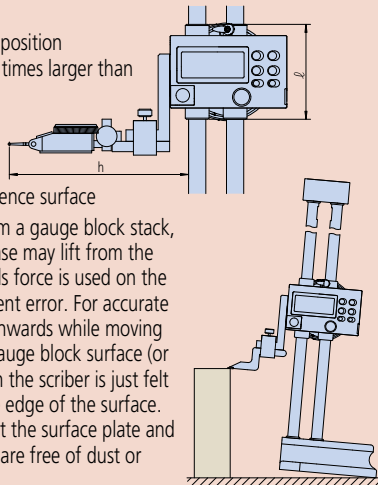

#### 3. Lifting of the base from the reference surface

When setting the scriber height from a gauge block stack, or from a workpiece feature, the base may lift from the surface plate if excessive downwards force is used on the slider, and this results in measurement error. For accurate setting, move the slider slowly downwards while moving the scriber tip to and fro over the gauge block surface (or feature). The correct setting is when the scriber is just felt to lightly touch as it moves over the edge of the surface. It is also necessary to make sure that the surface plate and height gage base reference surface are free of dust or burrs before use.

### Mechanical Digit Height gage

#### Measuring upwards from a reference surface

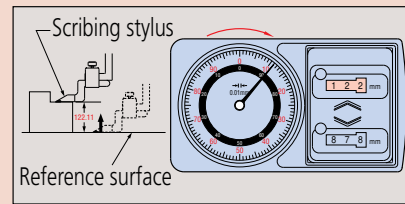

Counter	122 mm
Dial	0.11 mm
Reading	122.11 mm

#### Measuring downwards from a reference surface

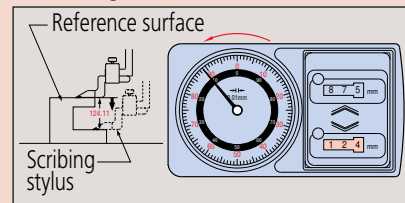

Counter	124 mm
Dial	0.11 mm
Reading	124.11 mm

#### 4. Error due to inclination of the main scale (column)

According to JIS standards, the perpendicularity of the column reference edge to the base reference surface should be better than:

$$\left(0.01 + \frac{L}{1000}\right) \text{ mm} \quad L \text{ indicates the measuring length (unit: mm)}$$

This is not a very onerous specification. For example, the perpendicularity limit allowable is 0.61 mm when L is 600 mm. This is because this error factor has a small influence and does not change the inclination of the slider, unlike a warped column.

#### 5. Relationship between accuracy and temperature

Height gages are made of several materials. Note that some combinations of workpiece material, room temperature, and workpiece temperature may affect measuring accuracy if this effect is not allowed for by performing a correction calculation.

6. The tip of a height gage scriber is very sharp and must be handled carefully if personal injury is to be avoided.

7. Do not damage a digital height gage scale by engraving an identification number or other information on it with an electric marker pen.

8. Carefully handle a height gage so as not to drop it or bump it against anything.

### Notes on using the height gage

1. Keep the column, which guides the slider, clean. If dust or dirt accumulates on it, sliding becomes difficult, leading to errors in setting and measuring.

2. When scribing, securely lock the slider in position using the clamping arrangements provided. It is advisable to confirm the setting after clamping because the act of clamping on some height gages can alter the setting slightly. If this is so, allowance must be made when setting to allow for this effect.

3. Parallelism between the scriber measuring face and the base reference surface should be 0.01 mm or better.

Remove any dust or burrs on the mounting surface when installing the scriber or lever-type dial indicator before measurement. Keep the scriber and other parts securely fixed in place during measurement.

4. If the main scale of the height gage can be moved, move it as required to set the zero point, and securely tighten the fixing nuts.

5. Errors due to parallax error are not negligible. When reading a value, always look straight at the graduations.

6. Handling after use: Completely wipe away any water and oil. Lightly apply a thin coating of anti-corrosion oil and let dry before storage.

7. Notes on storage:

Avoid direct sunlight, high temperatures, low temperatures, and high humidity during storage.

If a digital height gage will not be used for more than three months, remove the battery before storage.

If a protective cover is provided, use the cover during storage to prevent dust from adhering to the column.





# CERA Caliper Checker

## SERIES 515

### FEATURES

- The CERA Caliper Checker is designed to inspect vernier, dial and Digimatic calipers. It is comprised of permanently wrung, high-grade CERA gage blocks in a protective casting.
- The CERA Caliper Checker also stands perpendicular to a surface for height gage inspection.
- The zirconia-based ceramic CERA measuring blocks are corrosion-resistant and dimensionally stable.

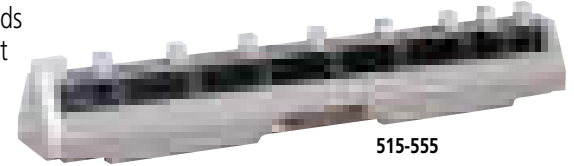

### Technical Data

Block pitch accuracy:  $\pm 0.005\text{mm}$  for range up to 300mm  
 $\pm 0.002''$  for range up to 12''  
 $\pm 0.007\text{mm}$  for range up to 600mm  
 Parallelism of blocks: 0.002mm for range up to 300mm  
 0.004mm for range up to 600mm

### Optional Accessories

**602162:** Wooden case for 300mm model  
**602164:** Wooden case for 600mm model

### SPECIFICATIONS

Metric			
Range	Order No.	Remarks (length to check)	Mass (kg)
0 - 300mm	<b>515-555</b>	Outside measurement: 20, 50, 100, 150, 200, 250, 300mm Inside measurement: 20, 50, 100, 150, 200, 250, 300mm	4.0
0 - 600mm	<b>515-556-2</b>	Outside, Inside measurement: 20, 50, 100, 150, 200, 250, 300, 350, 400, 450, 500, 550, 600mm	8.5

  

Inch			
Range	Order No.	Remarks (length to check)	Mass (kg)
0 - 12''	<b>515-565</b>	Outside measurement: 1'', 2'', 4'', 6'', 8'', 10'', 12'' Inside measurement: 1'', 2'', 4'', 6'', 8'', 10'', 12''	4.0

### DIMENSIONS

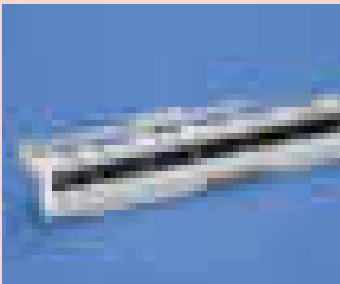
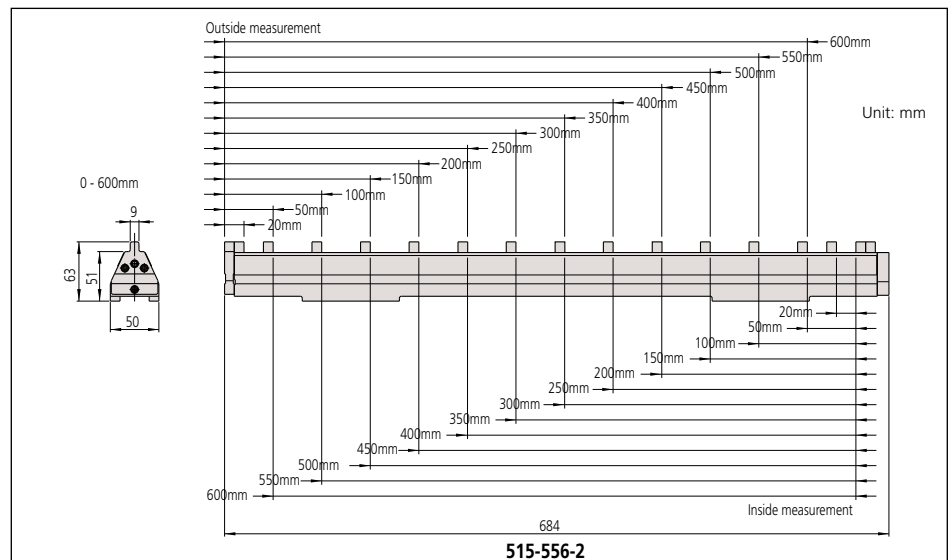
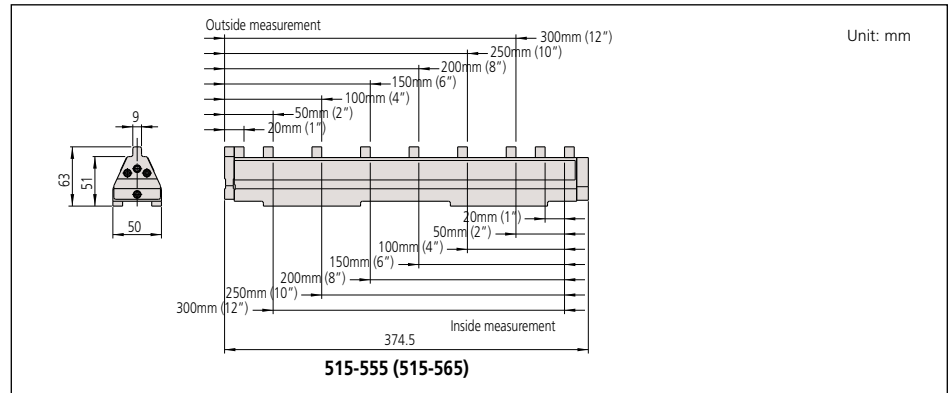

Used for caliper

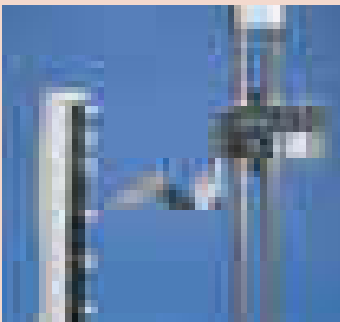

Used for height gage

# Depth Micrometer

## SERIES 329, 129 — Interchangeable Rod Type

### FEATURES

- $\varnothing 4$ mm interchangeable rods, with lapped measuring end, provide a wide measuring range.
- The rod length can be adjusted in 1" or 25mm increments.
- With ratchet stop for constant force.
- With measuring rod clamp.
- With SPC output (Series 329).
- Supplied in fitted plastic case.

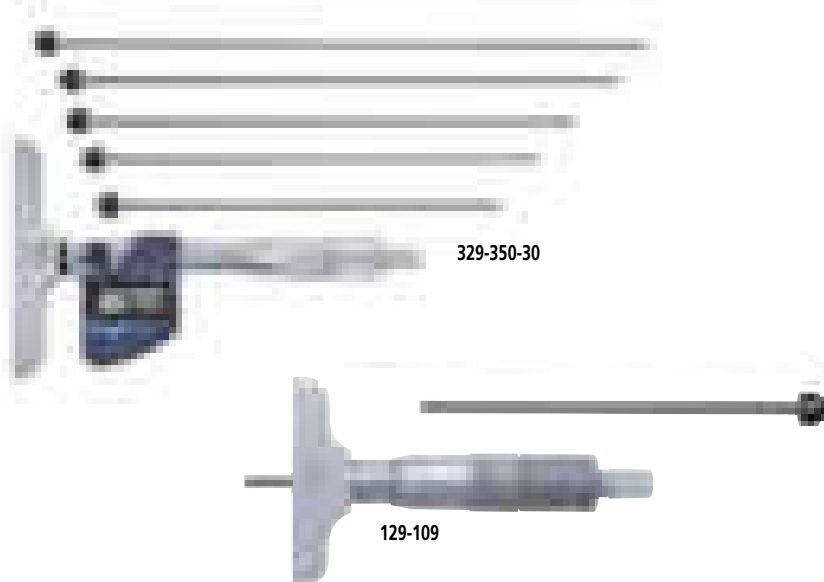

### SPECIFICATIONS

Metric Digimatic model			
Range	Order No.	Base Size	Rod Qty.
0 - 150mm	<b>329-250-30</b>	101.6x16mm	6 rods
0 - 300mm	<b>329-251-30</b>	101.6x16mm	12 rods

Metric			
Range	Order No.	Base Size	Rod Qty.
0 - 50mm	<b>129-109</b>	63.5x16mm	2 rods
0 - 100mm	<b>129-111</b>	63.5x16mm	4 rods
0 - 100mm	<b>129-115</b>	101.6x16mm	4 rods
0 - 150mm	<b>129-112</b>	63.5x16mm	6 rods
0 - 150mm	<b>129-116</b>	101.6x16mm	6 rods

Inch/Metric Digimatic model			
Range	Order No.	Base Size	Rod Qty.
0 - 6" / 0 - 152.4mm	<b>329-350-30</b>	4"x.63"	6 rods
0 - 12" / 0 - 304.8mm	<b>329-351-30</b>	4"x.63"	12 rods

Inch			
Range	Order No.	Base Size	Rod Qty.
0 - 4"	<b>129-127</b>	2.5"x.63"	4 rods
0 - 4"	<b>129-131</b>	4"x.63"	4 rods
0 - 6"	<b>129-128</b>	2.5"x.63"	6 rods
0 - 6"	<b>129-132</b>	4"x.63"	6 rods
0 - 12"	<b>129-149</b>	2.5"x.63"	12 rods
0 - 12"	<b>129-150</b>	4"x.63"	12 rods

### DIMENSIONS

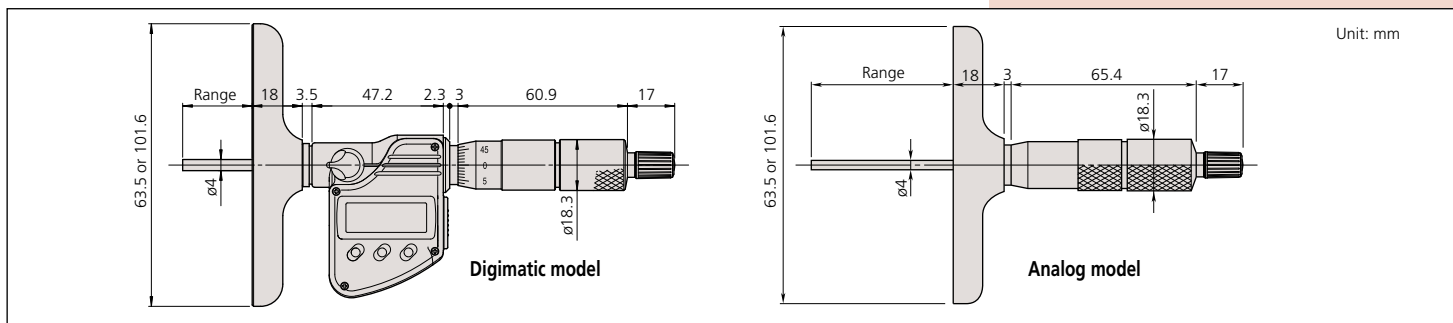

### Technical Data

Accuracy:  $\pm 0.0015"/3\mu\text{m}$  for micrometer head feed  
 $\pm [0.0008 + (0.0004 \times R/3)]"$   
 R = max. measuring length (inch)  
 $\pm (2 + L/75)\mu\text{m}$  for interchangeable rod,  
 L = Max. measuring length (mm)

Resolution\*:  $.00005"/0.001\text{mm}$  or  $0.001\text{mm}$   
 Graduation\*\*:  $.001"$  or  $0.01\text{mm}$   
 Flatness of reference surface (base):  
 $.00005"/1.3\mu\text{m}$  for  $2.5"/63.5\text{mm}$  wide base  
 $.00008"/2\mu\text{m}$  for  $4"/101.6\text{mm}$  wide base  
 Flatness of measuring face (rod):  
 $.000012"/0.3\mu\text{m}$   
 Parallelism between reference face and measuring rod face:  
 $[0.00016 + (0.00004 \times R/2)]"$   
 R = max. measuring range (inch)  
 $(4 + L/50)\mu\text{m}$   
 L = Max. measuring length (mm)

Zero point error of rods:  
 $\pm 0.0002"/4\mu\text{m}$  for  $0-6"/0-150\text{mm}$  models  
 $\pm 0.0003"/6\mu\text{m}$  for  $0-12"/0-300\text{mm}$  models

Measuring rod diameter:  $.157"/4\text{mm}$   
 Display\*: LCD  
 Battery\*: SR44 (1 pc.), **938882**  
 Battery life\*: Approx. 2.4 years under normal use  
 \*Digital models \*\*Analog models

### Function of Digimatic Model

Origin-set, Zero-setting, Data hold, Data output,  
 inch/mm conversion (on inch/metric models only)  
 Function Lock, 2 Presets  
 Alarm: Low voltage, Counting value composition error

### Optional Accessories for Digimatic Model

- 05CZA662**: SPC cable with data switch (40" / 1m)
- 05CZA663**: SPC cable with data switch (80" / 2m)

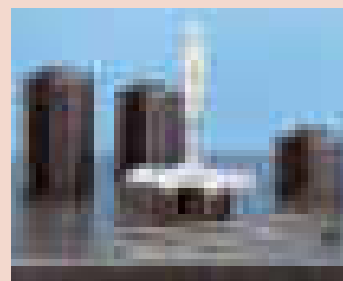

# Depth Micrometer

## SERIES 128

### Technical Data

Accuracy:  $\pm 3\mu\text{m}$  for micrometer head feed  
 Graduation: .001" or 0.01mm  
 Flatness of reference face: 1.3 $\mu\text{m}$  for 63.5mm width base,  
 2 $\mu\text{m}$  for 101.6mm width base  
 Flatness of measuring rod face: 0.3 $\mu\text{m}$   
 Parallelism between reference face and measuring rod face:  
 (4+L/50) $\mu\text{m}$ , L=Max. measuring length (mm)  
 Measuring rod diameter: 4mm

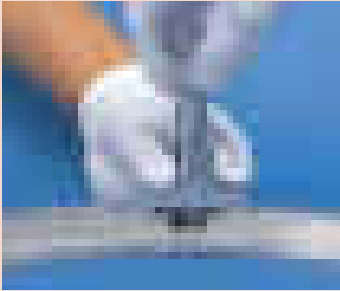

### FEATURES

- $\varnothing 4\text{mm}$  measuring rod.
- With measuring rod clamp.
- Carbide-tipped measuring rod model is available.
- With ratchet stop for constant force.

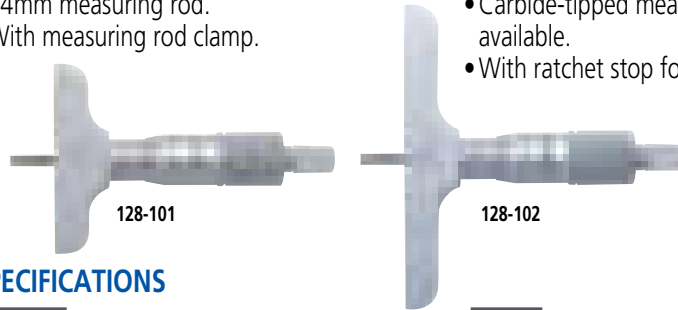

### SPECIFICATIONS

Metric		
Range	Order No.	Remarks (base)
0 - 25mm	<b>128-101</b>	63.5x16mm
0 - 25mm	<b>128-103*</b>	63.5x16mm
0 - 25mm	<b>128-102</b>	101.6x16mm
0 - 25mm	<b>128-104*</b>	101.6x16mm

Inch		
Range	Order No.	Remarks (base)
0 - 1"	<b>128-105</b>	2.5"x.63"
0 - 1"	<b>128-106</b>	4"x.63"

\*with carbide-tipped measuring rod

# Depth Micro Checker

## SERIES 515

### FEATURES

- The Depth Micro Checker is designed to efficiently check the zero point of a depth micrometer.

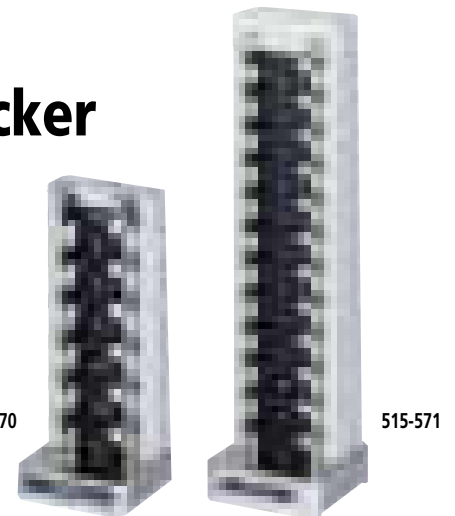

### SPECIFICATIONS

Metric		
Range	Order No.	Remarks (length to check)
0 - 150mm	<b>515-570</b>	25, 50, 75, 100, 125, 150mm
0 - 300mm	<b>515-571</b>	25, 50, 75, 100, 125, 150, 175, 200, 225, 250, 275, 300mm

Inch		
Range	Order No.	Remarks (length to check)
0 - 6"	<b>515-575</b>	1", 2", 3", 4", 5", 6"

### DIMENSIONS

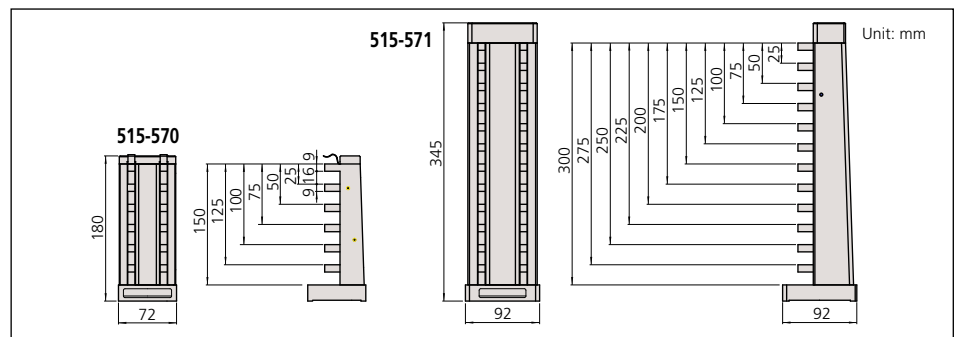

### Technical Data

Block pitch accuracy:  $\pm(1+L/150)\mu\text{m}$ ,  
 L=Length to check (mm)  
 Anvil block accuracy:  $\pm 0.5\mu\text{m}$

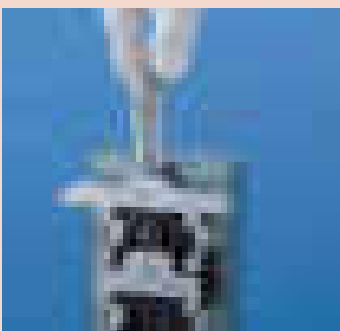

# ABSOLUTE Digimatic Depth Gage

**SERIES 571**



## FEATURES

- ABSOLUTE Digimatic Depth Gage can keep track of the origin point, once set, for the entire life of the battery.
- Base and measuring faces are hardened and micro-lapped.
- Optional wider extension base are available. (up to 450mm range models)
- With SPC data output.

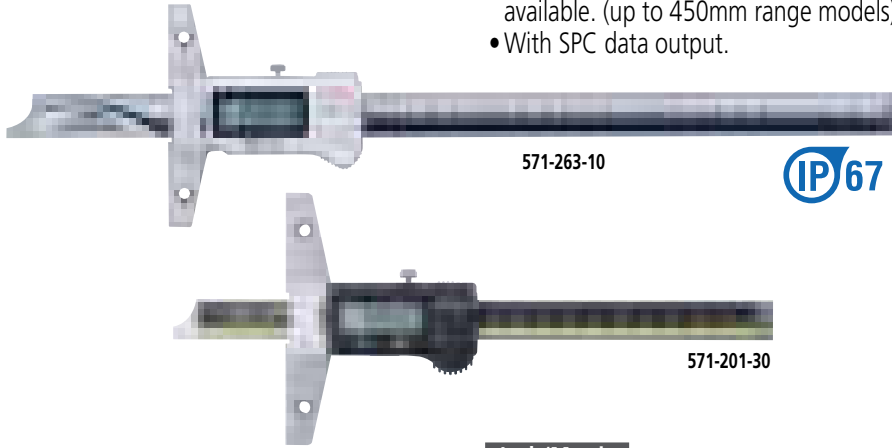

571-263-10



571-201-30

## SPECIFICATIONS

Metric				
Range	Order No.	Resolution	Accuracy	Mass(g)
0 - 150mm	571-201-30	0.01mm	±0.02mm	192
0 - 150mm	571-251-20*	0.01mm	±0.02mm	199
0 - 200mm	571-202-30	0.01mm	±0.02mm	212
0 - 200mm	571-252-20*	0.01mm	±0.02mm	219
0 - 300mm	571-203-20	0.01mm	±0.03mm	310
0 - 300mm	571-253-10*	0.01mm	±0.03mm	320
0 - 450mm	571-204-10	0.01mm	±0.05mm	1270
0 - 600mm	571-205-10	0.01mm	±0.05mm	1400
0 - 750mm	571-206-10	0.01mm	±0.06mm	1530
0 - 1000mm	571-207-10	0.01mm	±0.07mm	1760

\*IP67 Coolant-Proof model

Inch/Metric				
Range	Order No.	Resolution	Accuracy	Mass(g)
0 - 6" / 0 - 150mm	571-211-30	.0005" / 0.01mm	±.001"	192
0 - 6" / 0 - 150mm	571-261-20*	.0005" / 0.01mm	±.001"	199
0 - 8" / 0 - 200mm	571-212-30	.0005" / 0.01mm	±.001"	212
0 - 8" / 0 - 200mm	571-262-20*	.0005" / 0.01mm	±.001"	219
0 - 12" / 0 - 300mm	571-213-10	.0005" / 0.01mm	±.0015"	310
0 - 12" / 0 - 300mm	571-263-10*	.0005" / 0.01mm	±.0015"	320
0 - 18" / 0 - 450mm	571-214-10	.0005" / 0.01mm	±.002"	1270
0 - 24" / 0 - 600mm	571-215-10	.0005" / 0.01mm	±.002"	1400
0 - 30" / 0 - 750mm	571-216-10	.0005" / 0.01mm	±.0025	1530
0 - 40" / 0 - 1000mm	571-217-10	.0005" / 0.01mm	±.0025	1760

\*IP67 Coolant-Proof model

## Technical Data

Resolution: .0005" / 0.01mm or 0.01mm  
 Repeatability: 0.01mm  
 Display: LCD  
 Length standard: ABSOLUTE electrostatic capacitance (electromagnetic induction)\* type linear encoder  
 Max. response speed: Unlimited  
 Battery: SR44 (1 pc.), **938882**  
 Battery life: Approx. 20,000 hours (3 years)\* under normal use  
 Dust/Water protection level: IP67\*  
 \*Coolant-Proof models

## Function

Origin-set, Zero-setting, Automatic power on/off, Data output, inch/mm conversion (on inch/metric models only)  
 Alarm: Low voltage, Counting value composition error

## Optional Accessories

- 959143:** Data hold unit
- 959149:** SPC cable with data switch (40" / 1m)
- 959150:** SPC cable with data switch (80" / 2m)
- 05CZA624:** SPC cable with data switch (40" / 1m)\*
- 05CZA625:** SPC cable with data switch (80" / 2m)\*

\*For IP-67 models

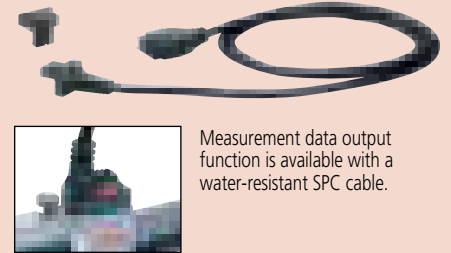

Measurement data output function is available with a water-resistant SPC cable.

## DIMENSIONS

Unit: mm

0-150mm/0-6" and 0-200mm/0-8"

0-450mm/0-18" and larger

Range	L	Base thickness
0 - 6" / 0 - 150mm	237	6
0 - 8" / 0 - 200mm	287	6
0 - 12" / 0 - 300mm	403	6
0 - 18" / 0 - 450mm	635	10
0 - 24" / 0 - 600mm	785	10
0 - 30" / 0 - 750mm	935	10
0 - 40" / 0 - 1000mm	1200	10



**ABSOLUTE®**

Absolute System Patented by MITUTOYO

### Technical Data

Accuracy: Refer to the list of specifications  
Resolution: .0005"/0.01mm or 0.01mm  
Display: LCD  
Battery: SR44 (1 pc.), **938882**  
Battery life: Approx. 2000 hours

### Function

Origin-set, Zero-setting, Power ON/OFF,  
inch/mm conversion (on inch/metric models only)  
Alarm: Low voltage, Counting value composition error

### Optional Accessories

**959143:** Data hold unit  
**959149:** SPC cable with data switch (40" / 1m)  
**959150:** SPC cable with data switch (80" / 2m)



**ABSOLUTE®**

Absolute System Patented by MITUTOYO

### Technical Data

Resolution: .0005"/0.01mm or 0.01mm  
Repeatability: .0005"/0.01mm  
Display: LCD  
Length standard: ABSOLUTE electromagnetic induction-type  
linear encoder  
Max. response speed: Unlimited  
Battery: SR44 (1 pc.), **938882**  
Battery life: Approx. 20,000 hours (3 years) under normal use  
Dust/Water protection level: IP67

### Function

Origin-set, Zero-setting, Automatic power on/off, Data  
output, inch/mm conversion (on inch/metric models only)  
Alarm: Low voltage, Counting value composition error

### Optional Accessories

**05CZA624:** SPC cable with data switch (40" / 1m)  
**05CZA625:** SPC cable with data switch (80" / 2m)  
—: Extension base (see page D-56.)

**05CZA624**



Measurement data output  
function is available with a  
water-resistant SPC cable.

# Tire Tread Depth Gage

**SERIES 571**

### FEATURES

- ABSOLUTE Digimatic Tread Depth Gage can keep track of the origin point, once set, for the life of the battery.

- Specially designed to measure tire tread depth.
- With SPC data output.



**571-100MOT-10**

### SPECIFICATIONS

#### Metric

Range	Order No.	Resolution	Accuracy
0 - 25mm	<b>571-100MOT-10</b>	0.01mm	±0.02mm

#### Inch/Metric

Range	Order No.	Resolution	Accuracy
0 - 1" / 0 - 25mm	<b>571-200MOT-10</b>	.0005" / 0.01mm	±.0005"

### DIMENSIONS

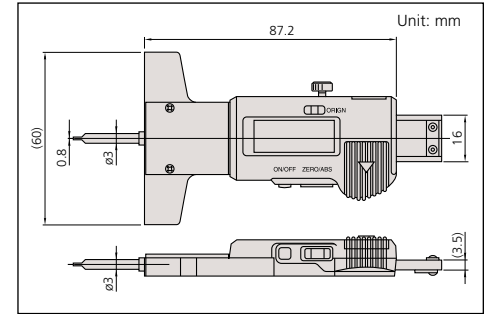

# ABSOLUTE Point-Type Digimatic Depth Gage

**SERIES 571**

### FEATURES

- ABSOLUTE Digimatic Depth Gage can keep track of the origin point, once set, for the life of the battery.

- Base and measuring faces are hardened and micro-lapped.
- Optional wider extension base are available.
- With SPC data output.



### SPECIFICATIONS

#### Metric

Range	Order No.	Resolution	Accuracy	Mass(g)
0-150mm	<b>571-301-20</b>	0.01mm	±0.02mm	207
0-200mm	<b>571-302-20</b>	0.01mm	±0.02mm	227

#### Inch/Metric

Range	Order No.	Resolution	Accuracy	Mass(g)
0-6" / 0-150mm	<b>571-311-20</b>	.0005" / 0.01mm	±.001" / ±0.02mm	207
0-8" / 0-200mm	<b>571-312-20</b>	.0005" / 0.01mm	±.001" / ±0.02mm	227

### DIMENSIONS

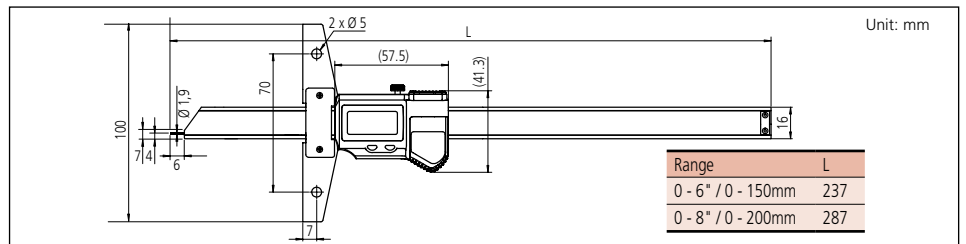

Range	L
0 - 6" / 0 - 150mm	237
0 - 8" / 0 - 200mm	287

# Vernier Depth Gage

## SERIES 527

### FEATURES

- Made of hardened stainless steel.
- Base and measuring faces are hardened and micro-lapped.
- Optional wider extension base are available. (up to 450mm range models)

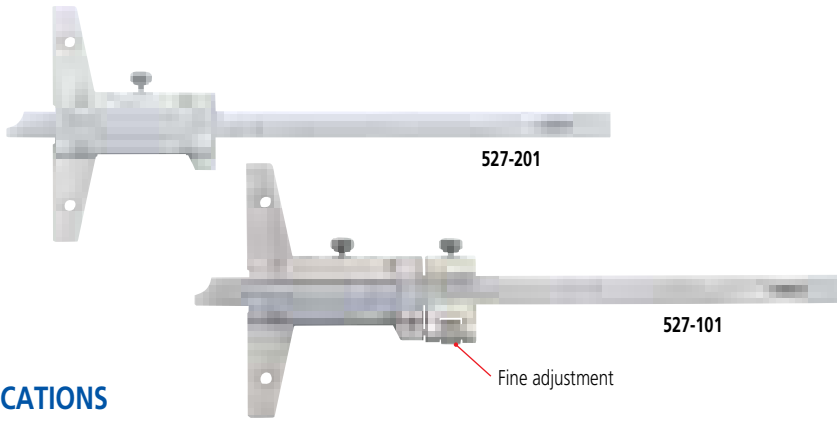

### SPECIFICATIONS

#### Metric

Range	Order No.	Vernier reading	Accuracy	Mass (g)	Remarks
0 - 150mm	527-201	0.05mm	±0.05mm	240	—
0 - 150mm	527-121	0.02mm	±0.03mm	215	—
0 - 150mm	527-101	0.02mm	±0.03mm	280	with fine adjustment
0 - 200mm	527-202	0.05mm	±0.05mm	260	—
0 - 200mm	527-122	0.02mm	±0.03mm	230	—
0 - 200mm	527-102	0.02mm	±0.03mm	300	with fine adjustment
0 - 300mm	527-203	0.05mm	±0.08mm	300	—
0 - 300mm	527-123	0.02mm	±0.04mm	265	—
0 - 300mm	527-103	0.02mm	±0.04mm	350	with fine adjustment
0 - 600mm	527-204	0.05mm	±0.10mm	1511	—
0 - 600mm	527-104	0.02mm	±0.05mm	1511	with fine adjustment
0 - 1000mm	527-205	0.05mm	±0.15mm	1880	—
0 - 1000mm	527-105	0.02mm	±0.07mm	1880	with fine adjustment

#### Inch

Range	Order No.	Vernier reading	Accuracy	Mass (g)	Remarks
0 - 6"	527-111	.001"	±.001"	280	with fine adjustment
0 - 8"	527-112	.001"	±.001"	300	with fine adjustment
0 - 12"	527-113	.001"	±.0015"	350	with fine adjustment
0 - 24"	527-114	.001"	±.002"	1511	with fine adjustment
0 - 40"	527-115	.001"	±.003"	1880	with fine adjustment

### DIMENSIONS

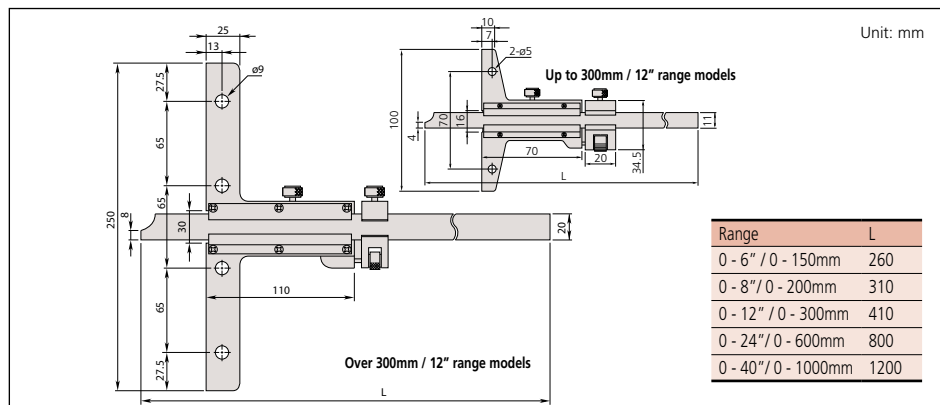

### Technical Data

Graduation: .001" or 0.05mm, 0.02mm

### Optional Accessories

—: Extension base (see page D-56.)

# Vernier Depth Gage

## SERIES 527 — Hook-End Type

### Technical Data

Graduation: 0.05mm or 0.02mm  
Base size: 100x6.5mm (WxT)

### Optional Accessory

—: Extension base (see page D-56.)

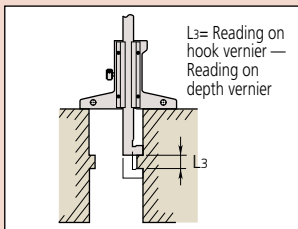
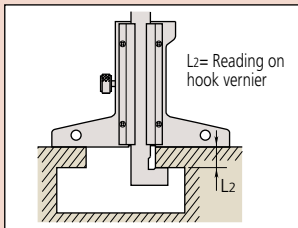
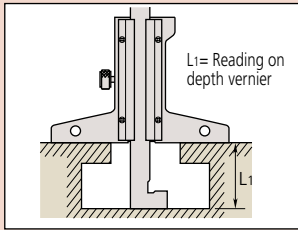

### FEATURES

- The end of the main scale is hook-shaped to allow depth and thickness measurements of a projected portion or lip in a hole, in addition to standard depth measurement.
- Fine adjustment models are available.
- Optional wider extension bases are available.

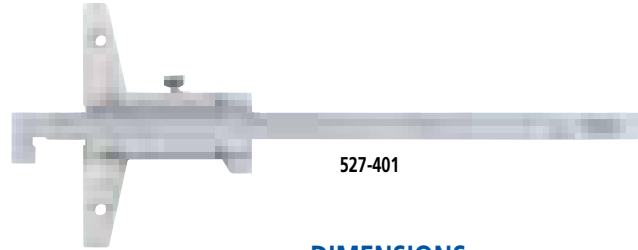

527-401

### SPECIFICATIONS

Metric				
Range	Order No.	Vernier reading	Accuracy	Mass (g)
0 - 150mm	527-401	0.05mm	±0.05mm	240
0 - 200mm	527-402	0.05mm	±0.05mm	240
0 - 300mm	527-403	0.05mm	±0.08mm	270

Metric with fine adjustment				
Range	Order No.	Vernier reading	Accuracy	Mass (g)
0 - 150mm	527-411	0.02mm	±0.03mm	280
0 - 200mm	527-412	0.02mm	±0.03mm	300
0 - 300mm	527-413	0.02mm	±0.04mm	350

### DIMENSIONS

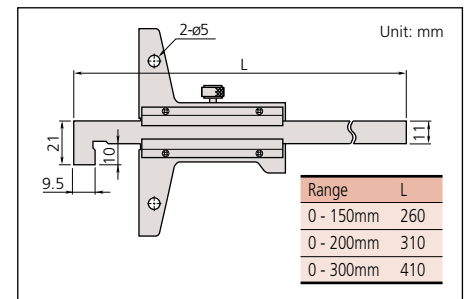

# ABSOLUTE Digimatic Depth Gage

## SERIES 571 — Hook-End Type

### FEATURES

- ABSOLUTE Digimatic Depth Gage can keep track of the origin point, once set, for the life of the battery.
- Base and measuring faces are hardened and micro-lapped.
- Optional wider extension bases are available.
- With SPC data output.

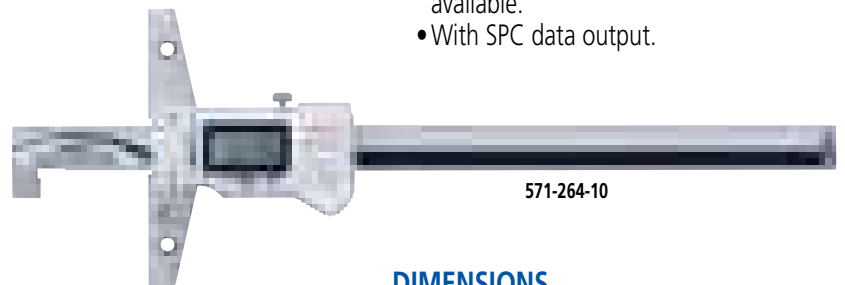

571-264-10

### SPECIFICATIONS

Inch/Metric				
Range	Order No.	Resolution	Accuracy	Mass (g)
0 - 6" / 0 - 150mm	571-264-20	.0005" / 0.01mm	±.0015"	578
0 - 8" / 0 - 200mm	571-265-20	.0005" / 0.01mm	±.0015"	598

### DIMENSIONS

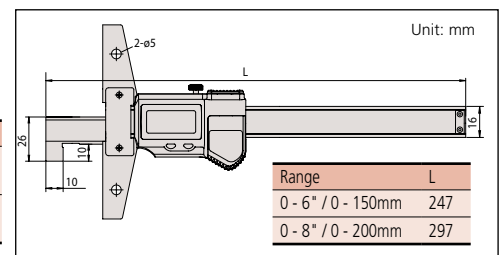

### Technical Data

Resolution: .0005"/0.01mm  
Repeatability: .0005"/0.01mm  
Display: LCD  
Length standard: ABSOLUTE electrostatic capacitance (electromagnetic induction)\* type linear encoder  
Max. response speed: Unlimited  
Battery: SR44 (1 pc.), 938882  
Battery life: Approx. 20,000 hours (3 years)\* under normal use  
Dust/Water protection level: IP67

### Function

Origin-set, Zero-setting, Automatic power on/off, Data output, inch/mm conversion (on inch/metric models only)  
Alarm: Low voltage, Counting value composition error

### Optional Accessories

05CZA624: SPC cable with data switch (40" / 1m)

05CZA625: SPC cable with data switch (80" / 2m)

—: Extension base (see page D-56.)

# Dial Depth Gage

**SERIES 527 — With Fine Adjustment**

## FEATURES

- Easier and faster reading of dial.
- Made of hardened stainless steel.
- Base and measuring faces are hardened and micro-lapped.
- Optional wider extension base are available.

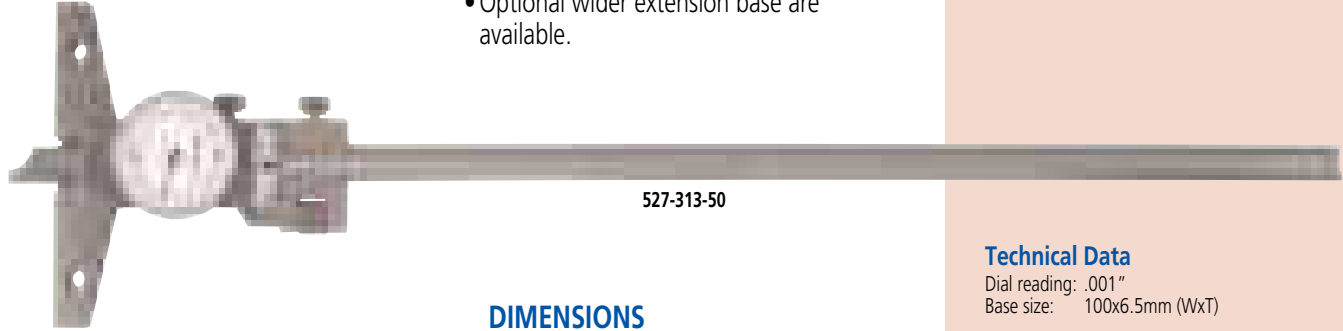

527-313-50

## SPECIFICATIONS

Inch				
Range	Order No.	Dial reading	Accuracy	Mass (g)
0 - 6"	527-311-50	.001"	±.001"	280
0 - 8"	527-312-50	.001"	±.001"	300
0 - 12"	527-313-50	.001"	±.0015"	340

## DIMENSIONS

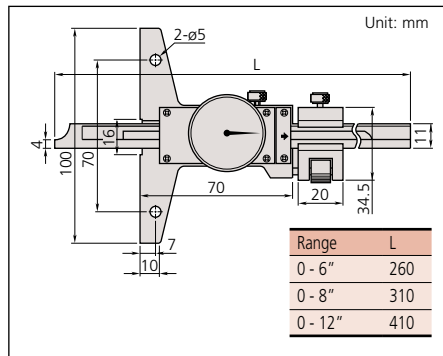

## Technical Data

Dial reading: .001"  
Base size: 100x6.5mm (WxT)

# Extension Bases

**Optional Accessory for Depth Gage**

## FEATURES

- Attached to the base (reference face) plate of a depth gage to extend its span.
- These extension base cannot be attached to 0-24" and 0-40", 0-600mm, 0-1000mm, range models.



900372

## SPECIFICATIONS

Metric			
Size	Order No.	Remarks (dimension a, b / n)	
180mm	900370	70mm, 55mm	2
260mm	900371	35mm, 60mm	5
320mm	900372	70mm, 55mm	4

Inch			
Size	Order No.	Remarks (dimension a, b / n)	
7"	900367	2.76", 2.17"	2
10"	900368	1.38", 2.36"	5
12"	900369	2.76", 2.17"	4

## DIMENSIONS

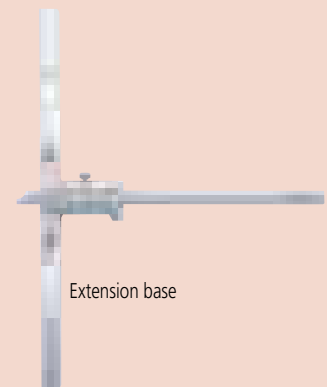
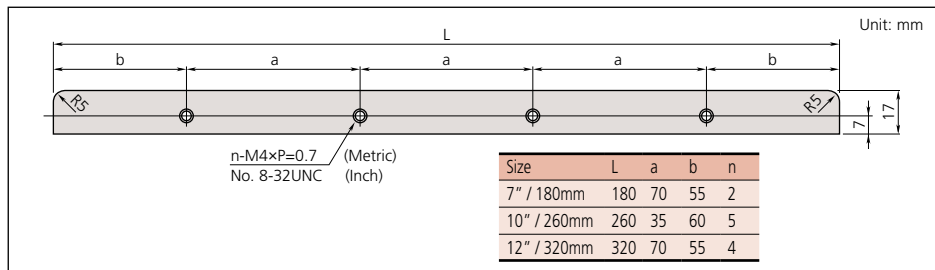

Extension base

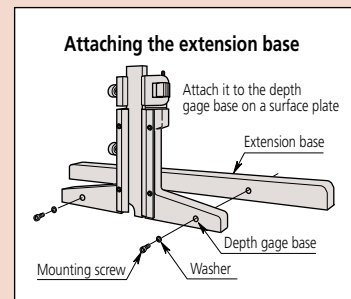





### Technical Data

Accuracy: Refer to the list of specifications  
 Resolution\*: .0005"/0.01mm or 0.001mm, 0.01mm, .00005"/0.001mm  
 Dial reading\*\*: .001" or 0.01mm  
 Flatness of base face: 5µm  
 Contact point: Carbide-tipped ball point or needle point (7210, 7222)  
 Measuring force: 1.4N, 1.5N (digital model), 2.5N (7213, 7214, 7217S, 7218S)  
 Display\*: LCD  
 Battery\*: SR44 (1 pc.), 938882  
 Battery life\*: Approx. 3.5 years under normal use  
 \*Digital models \*\*Dial models

### Technical Data of Dial Mode

Accuracy: Refer to the list of specifications  
 Dial reading: .001" or 0.01mm  
 Flatness of base face: 5µm or 2µm  
 Contact point: Carbide-tipped ball point (needle point: 7210, 7222)  
 Measuring force: 1.4N (2.5N: 7213, 7214, 7217S, 7218S)

### Function of Digimatic Model

Origin-set, Zero-setting, Data hold, Data output, inch/mm conversion (on inch/metric models only)  
 Alarm: Low voltage, Counting value composition error

### Optional Accessories

- 905338: SPC cable (40" / 1m)
- 905409: SPC cable (80" / 2m)
- 139167: .5" Extension Rod
- 301655: 1" Extension Rod
- 301657: 2" Extension Rod
- 301659: 4" Extension Rod
- 303611: 10mm Extension Rod
- 303612: 20mm Extension Rod
- 303613: 30mm Extension Rod
- 303614: 100mm Extension Rod

### Base Only (3/8" dia. hole)

Part No.	length	remark
902164:	2.5"	7217S, 7237, 547-217S, 547-257S
902165:	4"	7218S, 7238, 547-218S, 547-258S

# ABSOLUTE Digimatic/Dial Depth Gage

## SERIES 547, 7

### FEATURES

- ABSOLUTE Digimatic Depth Gage can keep track of the origin point, once set, for the life of the battery. (Series 547)
- Wide probing range is available with the supplied extension rod.
- Bottom surface of the base is hardened, ground and lapped for highest degree of flatness.
- Designed with a back-plunger type dial indicator for upward facing readings. (7231, 7237, 7238)
- With SPC data output. (Series 547)

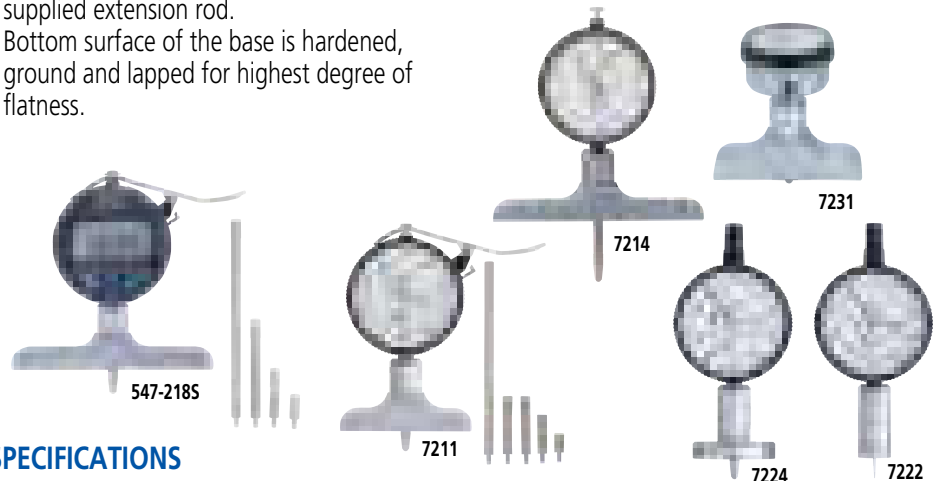

### SPECIFICATIONS

Metric Digimatic model							
Range	Order No.	Resolution	Stroke	Accuracy	Extension rod	Base (WxT)	Flatness
0 - 200mm	547-211	0.01mm	12mm	±0.02mm	5 pcs. (10, 20, 30, 30, 100mm)	63.5x16mm	5µm
0 - 200mm	547-212	0.01mm	12mm	±0.02mm	5 pcs. (10, 20, 30, 30, 100mm)	101.6x16mm	5µm
0 - 200mm	547-251	0.001mm	12mm	±0.005mm	5 pcs. (10, 20, 30, 30, 100mm)	63.5x16mm	2µm
0 - 200mm	547-252	0.001mm	12mm	±0.005mm	5 pcs. (10, 20, 30, 30, 100mm)	101.6x16mm	2µm

0.01mm graduation     0.001mm graduation

Inch/Metric Digimatic model							
Range	Order No.	Resolution	Stroke	Accuracy	Extension rod	Base (WxT)	Flatness
0 - 8" / 0-200mm	547-217S	.0005" / 0.01mm	.5"	±.001"	4 pcs. (.5", 1", 2", 4")	2.5"x.63"	.0002"
0 - 8" / 0-200mm	547-218S	.0005" / 0.01mm	.5"	±.001"	4 pcs. (.5", 1", 2", 4")	4"x.63"	.0002"
0 - 8" / 0-200mm	547-257S	.00005" / 0.001mm	.5"	±.0003"	4 pcs. (.5", 1", 2", 4")	2.5"x.63"	.00008"
0 - 8" / 0-200mm	547-258S	.00005" / 0.001mm	.5"	±.0003"	4 pcs. (.5", 1", 2", 4")	4"x.63"	.00008"

.005"/0.01mm graduation     .00005"/0.001mm graduation

Metric Dial Type							
Range	Order No.	Graduation	Stroke	Accuracy	Extension rod	Base (WxT)	Flatness
0 - 10mm	7210*	0.01mm	10mm	±0.015mm	—	40x16mm,	5µm
0 - 200mm	7211	0.01mm	10mm	±0.015mm	5 pcs. (10, 20, 30, 30, 100mm)	63.5x16mm	5µm
0 - 200mm	7212	0.01mm	10mm	±0.015mm	5 pcs. (10, 20, 30, 30, 100mm)	101.6x16mm	5µm
0 - 210mm	7213	0.01mm	30mm	±0.03mm	3 pcs. (30, 60, 90mm)	63.5x16mm	5µm
0 - 210mm	7214	0.01mm	30mm	±0.03mm	3 pcs. (30, 60, 90mm)	101.6x16mm	5µm
0 - 200mm	7220	0.01mm	10mm	±0.015mm	5 pcs. (10, 20, 30, 30, 100mm)	100x18mm	5µm
0 - 200mm	7221	0.01mm	10mm	±0.015mm	5 pcs. (10, 20, 30, 30, 100mm)	150x18mm	5µm
0 - 10mm	7222*	0.01mm	10mm	±0.015mm	5 pcs. (10, 20, 30, 30, 100mm)	ø16mm	5µm
0 - 10mm	7223	0.01mm	10mm	±0.015mm	5 pcs. (10, 20, 30, 30, 100mm)	ø25mm	5µm
0 - 10mm	7224	0.01mm	10mm	±0.015mm	5 pcs. (10, 20, 30, 30, 100mm)	ø40mm	5µm
0 - 200mm	7231	0.01mm	5mm	±0.015mm	5 pcs. (10, 20, 30, 30, 100mm)	63.5x16mm	5µm

\*with needle probe

Inch Dial Type							
Range	Order No.	Graduation	Stroke	Accuracy	Extension rod	Base (WxT)	Flatness
0 - 8"	7217S	.001"	1"	±.002"	4 pcs. (.5", 1", 2", 4")	2.5"x.63"	.0002"
0 - 8"	7218S	.001"	1"	±.002"	4 pcs. (.5", 1", 2", 4")	4"x.63"	.0002"
0 - 8"	7237T	.001"	.2"	±.002"	4 pcs. (.5", 1", 2", 4")	2.5"x.63"	.0002"
0 - 8"	7238T	.001"	.2"	±.002"	4 pcs. (.5", 1", 2", 4")	4"x.63"	.0002"



# DIMENSIONS

Unit: mm

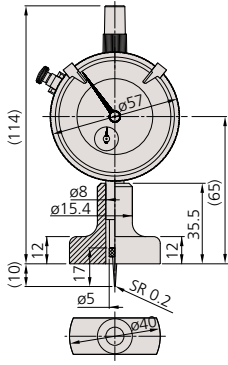

**7210**

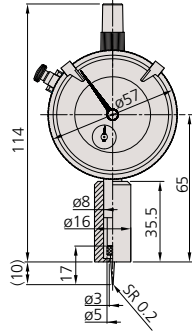

**7222**

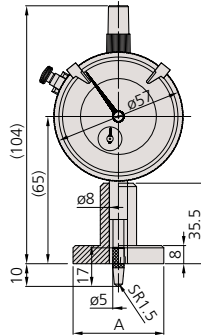

**7223** A=  $\varnothing$ 25mm  
**7224** A=  $\varnothing$ 40mm

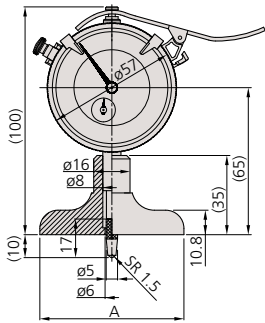

**7211** A= 63.5mm  
**7212** A= 101.6mm

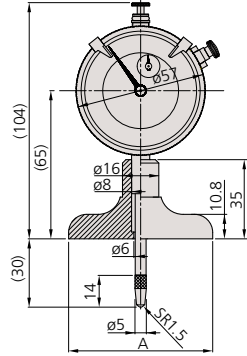

**7213, 7217S** A= 63.5mm  
**7214, 7218S** A= 101.6mm

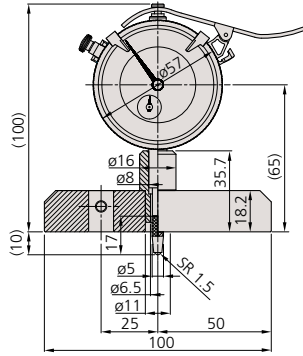

**7220**

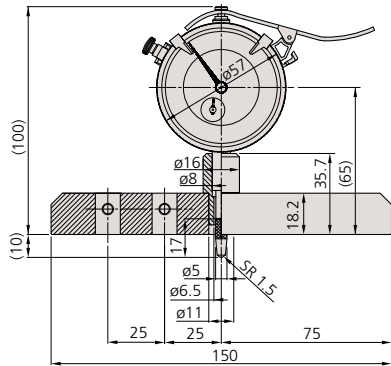

**7221**

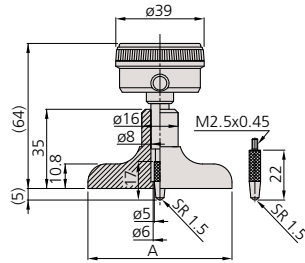

**7237T, 7231** A=63.5mm  
**7238T** A=101.6mm

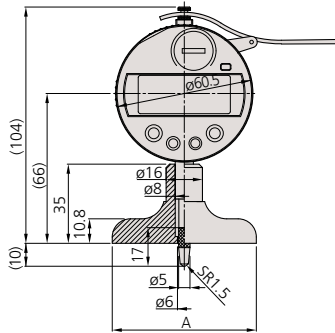

**547-211, 547-251, 547-217S, 547-257S** A= 63.5mm  
**547-212, 547-252, 547-218S, 547-258S** A= 101.6mm

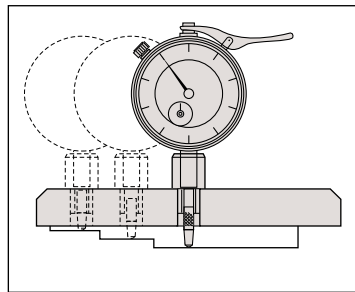

### INDEX

<b>Gage Blocks</b>	E-2-4
Metric Rectangular Gage Block Set	E-5,6
Inch Rectangular Gage Block Set	E-7
Micrometer Inspection Gage Block Sets	E-8
Bore Gage Calibration Kit	E-8
Individual Metric Rectangular Gage Block	E-9,10
Individual Inch Rectangular Gage Block	E-11
Rectangular Gage Block with CTE	E-12
Zero CERA Blocks	E-12
Rectangular Gage Block Accessories	E-13-15
Metric Square Gage Block Set	E-16
Inch Square Gage Block Set	E-17
Individual Metric Square Gage Block	E-18
Individual Inch Square Gage Block	E-19
Square Gage Block Accessories	E-20,21
Ceraston	E-22
Maintenance Kit for Gage Block	E-22
Step Master	E-23
Made-to-Order Block & Reference	E-23
Gage Block Comparator GBCD-250	E-24
Gage Block Comparator GBCD-100A	E-24
<b>Height Masters</b>	
Height Master	E-25
Digital Height Master	E-26
Riser Blocks	E-27
Auxiliary Block Kit	E-27
Universal Height Master	E-28
High-Accuracy Check Master HMC-H	E-29
CERA Straight Master SM-C	E-30
Square Master	E-31
<b>Reference Gages</b>	
Standard Scales	E-32
Working Standard Scales	E-32
High-Precision Square	E-33
Spring Dividers and Calipers	E-33
Steel Rules	E-34,35
Semi-Flexible Rules	E-35
Thickness/Feeler Gages	E-36
Precision Levels	E-36
Digital Universal Protractor	E-37
Universal Bevel Protractor	E-38
Bevel Protractor	E-38
Radius Gages	E-39
Pitch Gages	E-39
Radius Gages-Sets	E-40
Digital Protractor	E-41
Digital Hand Tachometers	E-42
Bench Center	E-43
<b>Granite Surface Plates</b>	
Granite Surface Plate Accessories	E-43
Black Granite Surface Plate	E-44,45
Steel Stands	E-45

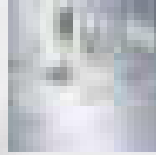

**Gage Blocks**



**Height Master**



**Reference Gages**

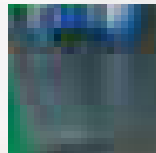

**Granite Surface Plates & Bench Comparator**

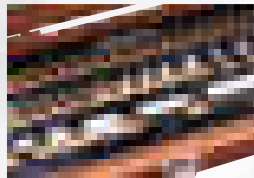

**CERA/Steel Combination Gage Block Sets**



**Step Master**



**ZERO CERA BLOCK**



**Ceramic Straight Master**

# Gage Block

## SERIES 516

### FEATURES

Precision gage blocks are the primary standards vital to dimensional quality control in the manufacture of parts. Mitutoyo offers

a complete selection of gage blocks available in a choice of rectangular or square, metric or inch and steel or CERA (ceramic) types.

### Accuracy

Mitutoyo gage blocks guarantee such a high accuracy that users can use them without anxiety. Mitutoyo has established a traceability system for our measurement products, up to the Metrology Management Center of the National Institute of Advanced Industrial Science and Technology (AIST), and we have been certified by the Japanese government as an accredited laboratory.

### Wringing

The lapping technique is one of Mitutoyo's specialties. Our advanced lapping technique, developed for more than a half century, allows us to achieve the best flatness and surface roughness needed for gage blocks.

### Abrasion Resistance and Dimensional Stability

High-carbon, high-chrome steel is employed to sufficiently satisfy a variety of material characteristics required for gage blocks. A high degree of hardness, obtained by our heat treatment technology, as well as methodically repeated heat treatment, have successfully reduced deterioration change over time.

### CERA Blocks

CERA blocks, made of ceramic materials with superior surface quality, were developed by Mitutoyo's ultra-precision machining techniques and solve problems commonly associated with steel gage blocks.

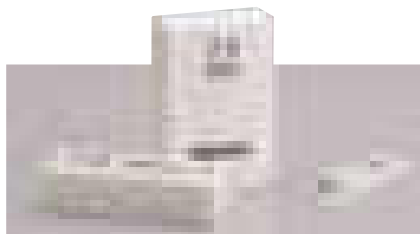

#### 1. Corrosion-Resistant

Anti-corrosion treatment is not required when handled normally (i.e. with fingers), resulting in simple maintenance and storage.

#### 2. No Burrs Caused by Dents, etc.

Since the CERA Block is very hard it will not scratch and is highly resistant to burrs. If a burr is formed, it can easily be removed with a ceramic deburring stone (Ceraston).

#### 3. Abrasion Resistant

CERA Blocks have 10 times the abrasion resistance of steel gage blocks.

#### 4. Dimensional Stability

CERA Blocks are free from dimensional change over time.

#### 5. Marking

The black characters, indicating the nominal length, are inscribed by laser and are clearly visible against the white surface of the block.

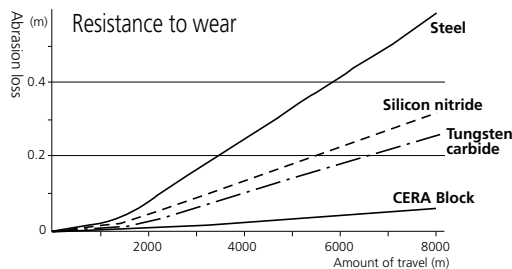

### Selecting Gage Blocks

- Select gage blocks in accordance with the combination range required. If a large length is required, add a long block set.
- Select gage blocks in accordance with the minimum length step required. Add wear block sets if necessary.
- If a set containing a large number of gage blocks is selected, the number of combination gage blocks required for a length is reduced and the number of combinations is increased. The accuracy will be retained and damage will be reduced.
- The specific gage block set for micrometer inspection and caliper inspection is available.
- If using only one length repeatedly, it is a good idea to purchase discrete gage blocks.
- The 2mm-based gage blocks, which take the base of the minimum length step as 2mm, are easy to handle and will not warp, as compared to the 1mm-based gage blocks.

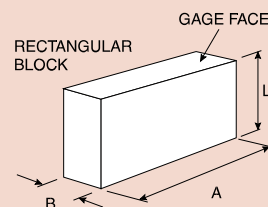

### Rectangular Block

Gage Size	Face Width (A)	Face Depth (B)
Up to 2"	1.181"	.355"
Over .2" up to 40"	1.378"	.355"
Up to 10mm	30mm	9mm
Over 10mm up to 1000mm	35mm	9mm

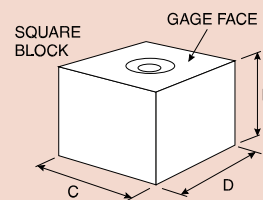

### Square Block

Gage Size	Face Width (C)	Face Depth (D)
Inch (up to 40")	.95"	.95"
Metric (up to 1000mm)	24.1mm	24.1mm

## Grade and Application

Refer to the following table to select the gage block grade according to usage.

	Applications	Grade
Workshop use	• Mounting tools and cutters	AS-1 or AS-2
	• Manufacturing gages • Calibrating instruments	0 or AS-1
Inspection use	• Inspecting mechanical parts, tools, etc.	0 or AS-1
	• Checking the accuracy of gages • Calibrating instruments	00 or 0
Calibration use	• Checking the accuracy of gage blocks for workshop • Checking the accuracy of gage blocks for inspection • Checking the accuracy of instruments	K or 00
Reference use	• Checking the accuracy of gage blocks for calibration • For academic research	K

### Grade AS-1:

These gage blocks are intended for shop-floor use to set and calibrate fixtures, as well as precision instruments.

### Grade 0:

This grade is used within an inspection area to verify the accuracy of plug and snap gages, as well as for setting electronic measuring devices.

### Grade 00:

These higher accuracy gages are intended for use within a controlled environment by skilled inspection staff. Mainly used as reference standards for setting high-precision measuring equipment and for the calibration of lower grade gage blocks.

### Grade K:

Gage blocks of this accuracy are intended for use within a temperature-controlled inspection room or calibration laboratory. They should be used as masters with certificates against other gage blocks which are calibrated by comparison.

### Combination of a Required Length

Multiple combinations of gage blocks can be used to make a required length. Care should be exercised in the following points.

1. Use as few gage blocks as possible to obtain the required length. (Select thick gage blocks whenever possible.)
2. Select gage blocks starting with the one that has the least significant digit required, and then work up to ones with more significant digits.
3. There are multiple combinations for the integer part of a length. To prevent wear as much as possible, do not always use the same gage blocks.

Example combination

Required length = 45.6785mm

#### For the 1mm-based gage block set (112 pcs.)

```

1.0005
1.008
1.17
17.5
+ 25
-----
45.6785mm
    
```

#### For the 2mm-based gage block set (112 pcs.)

```

2.0005
2.008
2.17
14.5
+ 25
-----
45.6785mm
    
```

## 6. Anti-magnetic Nature Keeps Away Steel Powders

## 7. High Wringing Force

An even, dense tissue can maintain a strong wringing force.



## 8. Material of CERA block

Property	Material	CERA Block (ZrO <sub>2</sub> )	Steel (Fe)	Carbide (WC-Co)	Silicon nitride (Si <sub>3</sub> N <sub>4</sub> )
Hardness (HV)		1350	800	1650	1500
Coefficient of thermal expansion (10 <sup>-6</sup> /K)		9.3±0.5	10.8±0.5	5.5±1.0	2
Flexural strength by 3-point bending (MPa)		1270	1960	1960	580
Fracture toughness K1c (MPa•m <sup>1/2</sup> )		7	120	12	6.5
Young's Modulus x104 (MPa)		20.6	20.6	61.8	28.4
Poisson's Ratio		0.3	0.3	0.2	0.3
Specific gravity		6.0	7.8	14.8	3.2
Thermal conductivity (W/m•k)		2.9	54.4	79.5	16.7

## 9. Closest Expansion Coefficient to Steel

The thermal expansion coefficient of a CERA Block is similar to that of a steel gage block.

## 10. Highly Resistant Against Drops and Other Shocks

The CERA block material is one of the toughest ceramics materials. It is extremely difficult to crack under normal use.

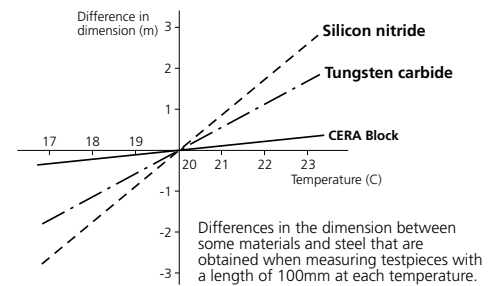

## Features of Square Gage Blocks

### 1. Perfect wringing is possible using the center hole.

After wringing the square gage blocks, an optional tie rod can be inserted through the center hole to fix the blocks using a screw.

### 2. A height reference standard can easily be made.

A precision height reference standard can be made easily and inexpensively using accessories such as the plain jaw and block base.

### 3. A dedicated inspection jig can be easily made.

A dedicated inspection jig for periodic inspection of instruments can be made easily and inexpensively.

### 4. A wide measuring surface with cross section dimensions of [24.1 x 24.1mm / .95 x .95"] is available.

A square gage block can retain stable orientation both longitudinally and laterally. A wide range of application measurements can be made, including cutting tool positioning, angle measurement with a sine bar, taper measurement with a roller, and inspection of depth micrometers.

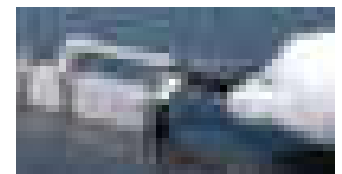
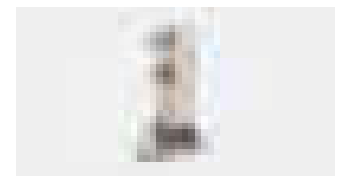
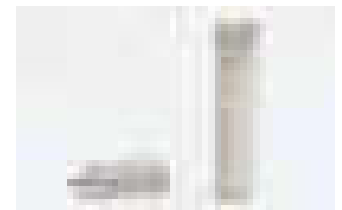

## Long and Ultra-Thin Gage Blocks

Mitutoyo offers extra thin gage blocks from 0.10 mm to 0.99 mm (increments of 0.01 mm), as well as long gage blocks up to 1,000 mm as standard products.

# Gage Block

## SERIES 516

### Accuracies of Mitutoyo Gage Blocks

All Mitutoyo gage blocks meet or exceed all known specifications. The flatness, parallelism and surface finish necessary to achieve the required accuracies are the same as or better than government requirements.

### ASME (American Society of Mechanical Engineers) Deviations and Tolerance on Length for Metric and inch Gage Blocks: ASME B89.1.9-2002 (USA)

Nominal Length Range l <sub>n</sub> in inches	Calibration Grade K		Grade 00		Grade 0		Grade AS-1		Grade AS-2	
	Limit Deviations of Length at any Point From Nominal Length ± l <sub>e</sub> μin.	Tolerance for the Variation In Length t <sub>v</sub> μin.	Limit Deviations of Length at any Point From Nominal Length ± l <sub>e</sub> μin.	Tolerance for the Variation In Length t <sub>v</sub> μin.	Limit Deviations of Length at any Point From Nominal Length ± l <sub>e</sub> μin.	Tolerance for the Variation In Length t <sub>v</sub> μin.	Limit Deviations of Length at any Point From Nominal Length ± l <sub>e</sub> μin.	Tolerance for the Variation In Length t <sub>v</sub> μin.	Limit Deviations of Length at any Point From Nominal Length ± l <sub>e</sub> μin.	Tolerance for the Variation In Length t <sub>v</sub> μin.
l <sub>n</sub> ≤ .05	12	2	4	2	6	4	12	6	24	12
.05 l <sub>n</sub> ≤ .4	10	2	3	2	5	4	8	6	18	12
.45 l <sub>n</sub> ≤ 1	12	2	3	2	6	4	12	6	24	12
1 l <sub>n</sub> ≤ 2	16	2	4	2	8	4	16	6	32	12
2 l <sub>n</sub> ≤ 3	20	2	5	3	10	4	20	6	40	14
3 l <sub>n</sub> ≤ 4	24	3	6	3	12	5	24	8	48	14
4 l <sub>n</sub> ≤ 5	32	3	8	3	16	5	32	8	64	16
5 l <sub>n</sub> ≤ 6	32	3	8	3	16	5	32	8	64	16
6 l <sub>n</sub> ≤ 7	40	4	10	4	20	6	40	10	80	16
7 l <sub>n</sub> ≤ 8	40	4	10	4	20	6	40	10	80	16
8 l <sub>n</sub> ≤ 10	48	4	12	4	24	6	48	10	104	18
10 l <sub>n</sub> ≤ 12	56	4	14	4	28	7	56	10	112	20
12 l <sub>n</sub> ≤ 16	72	5	18	5	36	8	72	12	144	20
16 l <sub>n</sub> ≤ 20	88	6	20	6	44	10	88	14	176	24
20 l <sub>n</sub> ≤ 24	104	6	25	6	52	10	104	16	200	28
24 l <sub>n</sub> ≤ 28	120	7	30	7	60	12	120	18	240	28
28 l <sub>n</sub> ≤ 32	136	8	34	8	68	12	136	20	260	32
32 l <sub>n</sub> ≤ 36	152	8	38	8	76	14	152	20	300	36
36 l <sub>n</sub> ≤ 40	160	10	40	10	80	16	168	24	320	40

Nominal Length Range l <sub>n</sub> in mm	Calibration Grade K		Grade 00		Grade 0		Grade AS-1		Grade AS-2	
	Limit Deviations of Length at any Point From Nominal Length ± l <sub>e</sub> μm	Tolerance for the Variation In Length t <sub>v</sub> μm	Limit Deviations of Length at any Point From Nominal Length ± l <sub>e</sub> μm	Tolerance for the Variation In Length t <sub>v</sub> μm	Limit Deviations of Length at any Point From Nominal Length ± l <sub>e</sub> μm	Tolerance for the Variation In Length t <sub>v</sub> μm	Limit Deviations of Length at any Point From Nominal Length ± l <sub>e</sub> μm	Tolerance for the Variation In Length t <sub>v</sub> μm	Limit Deviations of Length at any Point From Nominal Length ± l <sub>e</sub> μm	Tolerance for the Variation In Length t <sub>v</sub> μm
l <sub>n</sub> ≤ 0.5	0.30	0.05	0.10	0.05	0.14	0.10	0.30	0.16	0.60	0.30
0.5 l <sub>n</sub> ≤ 10	0.20	0.05	0.07	0.05	0.12	0.10	0.20	0.16	0.45	0.30
10 l <sub>n</sub> ≤ 25	0.30	0.05	0.07	0.05	0.14	0.10	0.30	0.16	0.60	0.30
25 l <sub>n</sub> ≤ 50	0.40	0.06	0.10	0.06	0.20	0.10	0.40	0.18	0.80	0.30
50 l <sub>n</sub> ≤ 75	0.50	0.06	0.12	0.06	0.25	0.12	0.50	0.18	1.00	0.35
75 l <sub>n</sub> ≤ 100	0.60	0.07	0.15	0.07	0.30	0.12	0.60	0.20	1.20	0.35
100 l <sub>n</sub> ≤ 150	0.80	0.08	0.20	0.08	0.40	0.14	0.80	0.20	1.60	0.40
150 l <sub>n</sub> ≤ 200	1.00	0.09	0.25	0.09	0.50	0.16	1.00	0.25	2.00	0.40
200 l <sub>n</sub> ≤ 250	1.20	0.10	0.30	0.10	0.60	0.16	1.20	0.25	2.40	0.45
250 l <sub>n</sub> ≤ 300	1.4	0.10	0.35	0.10	0.70	0.18	1.40	0.25	2.80	0.50
300 l <sub>n</sub> ≤ 400	1.80	0.12	0.45	0.12	0.90	0.20	1.80	0.30	3.60	0.50
400 l <sub>n</sub> ≤ 500	2.20	0.14	0.50	0.14	1.10	0.25	2.20	0.35	4.40	0.60
500 l <sub>n</sub> ≤ 600	2.60	0.16	0.65	0.16	1.30	0.25	2.60	0.40	5.00	0.70
600 l <sub>n</sub> ≤ 700	3.00	0.18	0.75	0.18	1.50	0.30	3.00	0.45	6.00	0.70
700 l <sub>n</sub> ≤ 800	3.40	0.20	0.85	0.20	1.70	0.30	3.40	0.50	6.50	0.80
800 l <sub>n</sub> ≤ 900	3.80	0.20	0.95	0.20	1.90	0.35	3.80	0.50	7.50	0.90
900 l <sub>n</sub> ≤ 1000	4.20	0.25	1.00	0.25	2.00	0.40	4.20	0.60	8.00	1.00

### Mitutoyo Gage Blocks and Inspection Certificates

A Certificate of Inspection is furnished with all Mitutoyo gage blocks with a serial number on the case and an identification number on each block. The deviation of each block is registered. For this inspection, each gage block is measured relative to the upper level master using a gage block comparator. Grade K gage blocks are manufactured by absolute measurement using an interferometer. The gage block set and discrete gage block are supplied with a Certificate of Calibration. The Certificate of Calibration specifies the deviation from the nominal length. (Comparative measurement, however, is performed for all square gage blocks.)



A Certificate of Accuracy, traceable to the NIST, is furnished with each gage block set and individual block.

### Mitutoyo America Corporation Calibration Laboratory:

ISO 17025-2005 accredited calibration available  
Calibration capability up to 1000mm/40" length  
Low measurement uncertainty

### Contact Information:

965 Corporate Blvd.  
Aurora, Illinois 60502  
Phone: (888) 648-8869 option 7  
Fax: (630) 978-6477

# Metric Rectangular Gage Block Set

## SERIES 516 — 1mm Base Block Set

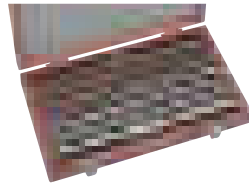

Steel 112-block set

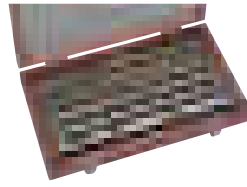

Steel 103-block set

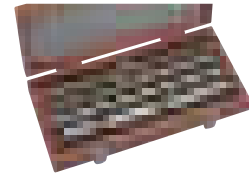

Steel 47-block set

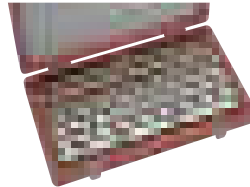

CERA 112-block set



CERA 56-block set



CERA/Steel combination  
47-block set

Provided with Inspection Certificate



### SPECIFICATIONS

#### 1mm Base Block Set

Blocks per set	Order No.		Grade	Blocks included in set		
	Steel	CERA		Size	Step	Qty.
112	516-531-56	516-541-56	K	1.0005		1
	516-937-26	516-337-26	00	1.001 - 1.009	0.001	9
	516-938-26	516-338-26	0	1.01 - 1.49	0.01	49
	516-939-26	516-339-26	AS-1	0.5 - 24.5	0.5	49
	516-940-26	516-340-26	AS-2	25 - 100	25	4
	516-941-26	516-341-26	AS-2	25 - 100	25	4
103	516-533-56	516-542-56	K	1.005		1
	516-941-26	516-341-26	00	1.01 - 1.49	0.01	49
	516-942-26	516-342-26	0	0.5 - 24.5	0.5	49
	516-943-26	516-343-26	AS-1	25 - 100	25	4
	516-944-26	516-344-26	AS-2	25 - 100	25	4
	516-945-26	516-345-26	AS-2	25 - 100	25	4
87	516-535-56	515-543-56	K	1.001 - 1.009	0.001	9
	516-945-26	516-345-26	00	1.01 - 1.49	0.01	49
	516-946-26	516-346-26	0	0.5 - 9.5	0.5	19
	516-947-26	516-347-26	AS-1	10 - 100	10	10
	516-948-26	516-348-26	AS-2	10 - 100	10	10
	516-949-26	516-349-26	AS-2	10 - 100	10	10
56	516-536-56	516-544-56	K	0.5		1
	516-953-26	516-353-26	00	1.001 - 1.009	0.001	9
	516-954-26	516-354-26	0	1.01 - 1.09	0.01	9
	516-955-26	516-355-26	AS-1	1.1 - 1.9	0.1	9
	516-956-26	516-356-26	AS-2	1 - 24	1	24
	516-957-26	516-357-26	AS-2	25 - 100	25	4
47	516-537-56	516-545-56	K	1.005		1
	516-957-26	516-357-26	00	1.01 - 1.09	0.01	9
	516-958-26	516-358-26	0	1.1 - 1.9	0.1	9
	516-959-26	516-359-26	AS-1	1 - 24	1	24
	516-960-26	516-360-26	AS-2	25 - 100	25	4
	516-961-26	516-361-26	AS-2	25 - 100	25	4

# Metric Rectangular Gage Block Set

**SERIES 516 — Long Block Set, Wear Block Set**

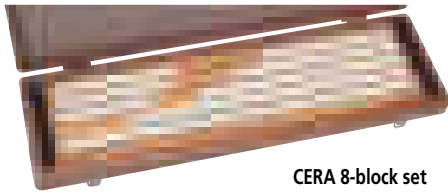

CERA 8-block set



Steel 8-block set

Provided with Inspection Certificate

## SPECIFICATIONS

### Long Block Set

Blocks per set	Order No.		Grade ASME	Blocks included in set		
	Steel	CERA		Size	Step	Qty.
<b>8</b>	—	<b>516-547-56</b>	K	25-200	25	8
	—	<b>516-164-26</b>	00	—	—	—
	<b>516-115-26</b>	<b>516-165-26</b>	0	—	—	—
	<b>516-116-26</b>	<b>516-166-26</b>	AS-1	—	—	—
<b>8</b>	<b>516-540-56</b>	<b>516-546-56</b>	K	125 - 175	25	3
	<b>516-701-26</b>	<b>516-731-26</b>	00	200 - 250	50	2
	<b>516-702-26</b>	<b>516-732-26</b>	0	300 - 500	100	3
	<b>516-703-26</b>	<b>516-733-26</b>	AS-1			



CERA 2-block set



Carbide 2-block

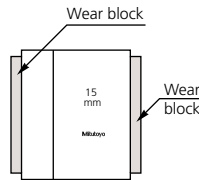

## SPECIFICATIONS

### Wear Block Set

Blocks per set	Order No.		Grade ASME	Blocks included in set	
	Carbide	CERA		Size	Qty.
<b>2</b>	<b>516-807-26</b>	<b>516-832-26</b>	0	1	2
	<b>516-806-26</b>	<b>516-833-26</b>	AS-1		
<b>2</b>	<b>516-803-26</b>	<b>516-830-26</b>	0	2	2
	<b>516-802-26</b>	<b>516-831-26</b>	AS-1		



# Inch Rectangular Gage Block Set

**SERIES 516 — Inch Block Set, Thin Block Set, Long Block Set, Wear Block Set**

## SPECIFICATIONS

### Inch Block Set

Blocks per set	Order No.			Grade	Blocks included in set		
	Steel	CERA	Steel/CERA		Size	Step	Qty.
<b>81</b>	516-549-56	516-557-56	—	K	.1001 – .1009	.0001	9
	516-901-26	516-301-26	—	00	.101 – .149	.001	49
	516-902-26	516-302-26	—	0	.05 – .95	.05	19
	516-903-26	516-303-26	—	AS-1	1 - 4	1	4
	516-904-26	516-304-26	—	AS-2			
<b>35</b>	516-550-56	516-558-56	—	K	.10005		1
	516-913-26	516-313-26	—	00	.1001 – .1009	.0001	9
	516-914-26	516-314-26	—	0	.101 – .109	.001	9
	516-915-26	516-315-26	—	AS-1	.11 – .19	.01	9
	516-916-26	516-316-26	—	AS-2	.1 - .3	.1	3
					.5, 1, 2, 4		4

81-block set: All are CERA blocks, except 2", 3", and 4" are steel blocks

Provided with Inspection Certificate



## SPECIFICATIONS

### Thin Block Set

Blocks per set	Order No.		Grade	Blocks included in set		
	Steel	CERA		Size	Step	Qty.
<b>28</b>	516-551-56	—	K	.02005		1
	516-917-26	—	00	.0201 – .0209	.0001	9
	516-918-26	—	0	.021 – .029	.001	9
	516-919-26	—	AS-1	.01 – .09	.01	9
	516-920-26	—	AS-2			
<b>10</b>	516-926-26	—	0	.005 - .050	.005	10
	516-927-26	—	AS-1			

## SPECIFICATIONS

### Long Block Set

Blocks per set	Order No.		Grade	Blocks included in set		
	Steel	CERA		Size	Step	Qty.
<b>8</b>	516-126-26	516-176-26	0	1-8	1	8
	516-127-26	516-177-26	AS-1			
<b>8</b>	—	516-564-56	K	5 - 7	1	3
	—	516-741-26	00	8, 10, 12	2	3
	516-712-26	516-742-26	0	16, 20	4	2
	516-713-26	516-743-26	AS-1			

## SPECIFICATIONS

### Wear Block Set

Blocks per set	Order No.		Grade	Blocks included in set	
	Carbide	CERA		Size	Qty.
<b>2</b>	516-809-26	516-836-26	0	.05	2
	516-808-26	516-837-26	AS-1		
<b>2</b>	516-805-26	516-834-26	0	.1	2
	516-804-26	516-835-26	AS-1		

# Micrometer Inspection Gage Block Sets

## SERIES 516

- Gage blocks for inspecting a variety of micrometers.
- Can be measured in both vertical and horizontal posture.
- Parallelism is measured by attaching the optional parallel (optional accessory) to the gage block set.

### SPECIFICATIONS

#### Metric Micro Checker (holder only)

Order No.	516-607
Applicable gage block set	516-106-26, 516-107-26, 516-156-26, 516-157-26
Applicable gage block size (mm)	2.5, 5.1, 7.7, 10.3, 12.9, 15, 17.6, 20.2, 22.8, 25

#### Inch/Metric Micro Checker (holder only)

Order No.	516-608
Applicable gage block set	516-921-26, 516-922-26, 516-923-26, 516-321-26, 516-322-26, 516-323-26
Applicable gage block size (inch)	.105, .210, .315, .420, .5, .605, .815, .920

#### Metric Block Set

Blocks per set	Order No.		Grade	Blocks included in set
	Steel	CERA		
10	516-103-26	516-152-26	0	1.00, 1.25, 1.50, 2, 3, 5, 10, 15, 20, 25mm
	516-101-26	516-153-26	AS-1	
10	516-106-26	516-156-26	0	2.5, 5.1, 7.7, 10.3, 12.9, 15, 17.6, 20.2, 22.8, 25mm • Optical parallel (t = 12mm)
	516-107-26	516-157-26	AS-1	

#### Inch Block Set

Blocks per set	Order No.		Grade	Blocks included in set
	Steel	CERA		
10	516-552-56	516-559-56	K	.105, .210, .315, .420, .500, .605, .710, .815, .920, 1" • Optical parallel (t = .5")
	516-921-26	516-321-26	00	
	516-922-26	516-322-26	0	
	516-923-26	516-323-26	AS-1	
10	516-529-26*	516-319-26*	0	.087, .189, .307, .409, .472, .598, .669, .772, .890, 1" • Optical parallel (t = .5")
9	516-554-56	516-561-56	K	.0625, .100, .125, .200, .250, .300, .500, 1, 2" • Optical parallel (t = .5")
	516-929-26	516-333-26	00	
	516-930-26	516-334-26	0	
	516-931-26	516-335-26	AS-1	
9	—	516-563-56	K	.0625, .100, .125, .200, .250, .300, .500, 1, 2"
	—	516-329-26	00	
	516-934-26	516-330-26	0	
	516-935-26	516-331-26	AS-1	

\* For QuantuMike

### Micro Checker



(Gage blocks are optional.)



Provided with Inspection Certificate



# Bore Gage Calibration Kit

## SERIES 516

### SPECIFICATIONS

Blocks per set	Order No.	Grade	Blocks included in set
	Carbide		Size
9	516-120-26	0	.04", .08", .16", .2", .4", .8", 1", 2", 3" 619018 (plain jaw 2 pc. set) and 619004 (160mm holder)

# Individual Metric Rectangular Gage Block

## FEATURES

- If using only one length repeatedly, it is good practice to purchase discrete gage blocks.
- Each gage block is supplied with a Certificate of Inspection.
- Each Grade K gage block of ASME standard is specially supplied with a Certificate of Calibration, which certifies that the gage block was manufactured via interferometry.



## Suffix Number for Selecting Standard and Certificate Provided

ASME	
Grade	Steel, CERA
K	-516**
00	-521*
0	-531*
AS-1	-541*
AS-2	-551*

\* provided with Inspection Certificate  
 \*\* provided with Calibration Certificate and Inspection Certificate

Example: 611821-521  
 0.1mm gage block in grade 00.  
 We make custom length gage blocks:  
 0.1-1000mm

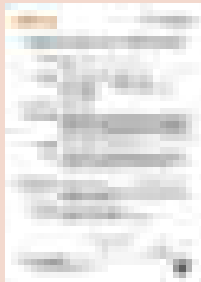

Inspection Certificate

## SPECIFICATIONS

Metric Block			Metric Block			Metric Block		
Length (mm)	Order No.		Length (mm)	Order No.		Length (mm)	Order No.	
	Steel	CERA		Steel	CERA		Steel	CERA
0.1	611821	—	0.53	611894	—	0.96	611937	—
0.11	611860	—	0.54	611895	—	0.97	611938	—
0.12	611861	—	0.55	611896	—	0.98	611939	—
0.13	611862	—	0.56	611897	—	0.99	611940	—
0.14	611863	—	0.57	611898	—	0.991	611551	613551
0.15	611822	—	0.58	611899	—	0.992	611552	613552
0.16	611864	—	0.59	611900	—	0.993	611553	613553
0.17	611865	—	0.6	611901	—	0.994	611554	613554
0.18	611866	—	0.61	611902	—	0.995	611555	613555
0.19	611867	—	0.62	611903	—	0.996	611556	613556
0.2	611823	—	0.63	611904	—	0.997	611557	613557
0.21	611868	—	0.64	611905	—	0.998	611558	613558
0.22	611869	—	0.65	611906	—	0.999	611559	613559
0.23	611870	—	0.66	611907	—	1	611611	613611
0.24	611871	—	0.67	611908	—	1.0005	611520	613520
0.25	611824	—	0.68	611909	—	1.001	611521	613521
0.26	611872	—	0.69	611910	—	1.002	611522	613522
0.27	611873	—	0.7	611911	—	1.003	611523	613523
0.28	611874	—	0.71	611912	—	1.004	611524	613524
0.29	611875	—	0.72	611913	—	1.005	611525	613525
0.3	611825	—	0.73	611914	—	1.006	611526	613526
0.31	611876	—	0.74	611915	—	1.007	611527	613527
0.32	611877	—	0.75	611916	—	1.008	611528	613528
0.33	611878	—	0.76	611917	—	1.009	611529	613529
0.34	611879	—	0.77	611918	—	1.01	611561	613561
0.35	611826	—	0.78	611919	—	1.02	611562	613562
0.36	611880	—	0.79	611920	—	1.03	611563	613563
0.37	611881	—	0.8	611921	—	1.04	611564	613564
0.38	611882	—	0.81	611922	—	1.05	611565	613565
0.39	611883	—	0.82	611923	—	1.06	611566	613566
0.4	611827	—	0.83	611924	—	1.07	611567	613567
0.41	611884	—	0.84	611925	—	1.08	611568	613568
0.42	611885	—	0.85	611926	—	1.09	611569	613569
0.43	611886	—	0.86	611927	—	1.1	611570	613570
0.44	611887	—	0.87	611928	—	1.11	611571	613571
0.45	611828	—	0.88	611929	—	1.12	611572	613572
0.46	611888	—	0.89	611930	—	1.13	611573	613573
0.47	611889	—	0.9	611931	—	1.14	611574	613574
0.48	611890	—	0.91	611932	—	1.15	611575	613575
0.49	611891	—	0.92	611933	—	1.16	611576	613576
0.5	611506	613506	0.93	611934	—	1.17	611577	613577
0.51	611892	—	0.94	611935	—	1.18	611578	613578
0.52	611893	—	0.95	611936	—	1.19	611579	613579

Length (mm)	Order No.		Length (mm)	Order No.		Length (mm)	Order No.	
	Steel	CERA		Steel	CERA		Steel	CERA
1.2	611580	613580	2.17	611717	—	13	611623	613623
1.21	611581	613581	2.18	611718	—	13.5	611653	613653
1.22	611582	613582	2.19	611719	—	14	611624	613624
1.23	611583	613583	2.2	611720	—	14.5	611654	613654
1.24	611584	613584	2.21	611721	—	15	611625	613625
1.25	611585	613585	2.22	611722	—	15.5	611655	613655
1.26	611586	613586	2.23	611723	—	16	611626	613626
1.27	611587	613587	2.24	611724	—	16.5	611656	613656
1.28	611588	613588	2.25	611725	—	17	611627	613627
1.29	611589	613589	2.26	611726	—	17.5	611657	613657
1.3	611590	613590	2.27	611727	—	17.6	611854	613854
1.31	611591	613591	2.28	611728	—	18	611628	613628
1.32	611592	613592	2.29	611729	—	18.5	611658	613658
1.33	611593	613593	2.3	611730	—	19	611629	613629
1.34	611594	613594	2.31	611731	—	19.5	611659	613659
1.35	611595	613595	2.32	611732	—	20	611672	613672
1.36	611596	613596	2.33	611733	—	20.2	611855	613855
1.37	611597	613597	2.34	611734	—	20.5	611660	613660
1.38	611598	613598	2.35	611735	—	21	611631	613631
1.39	611599	613599	2.36	611736	—	21.5	611661	613661
1.4	611600	613600	2.37	611737	—	22	611632	613632
1.41	611601	613601	2.38	611738	—	22.5	611662	613662
1.42	611602	613602	2.39	611739	—	22.8	611856	613856
1.43	611603	613603	2.4	611740	—	23	611633	613633
1.44	611604	613604	2.41	611741	—	23.5	611663	613663
1.45	611605	613605	2.42	611742	—	24	611634	613634
1.46	611606	613606	2.43	611743	—	24.5	611664	613664
1.47	611607	613607	2.44	611744	—	25	611635	613635
1.48	611608	613608	2.45	611745	—	25.25	611754	613754
1.49	611609	613609	2.46	611746	—	30	611673	613673
1.5	611641	613641	2.47	611747	—	35	611755	613755
1.6	611516	613516	2.48	611748	—	40	611674	613674
1.7	611517	613517	2.49	611749	—	41.3	611857	613857
1.8	611518	613518	2.5	611642	613642	45	611756	613756
1.9	611519	613519	2.6	611750	—	50	611675	613675
2	611612	613612	2.7	611751	—	60	611676	613676
2.0005	611690	—	2.8	611752	—	70	611677	613677
2.001	611691	—	2.9	611753	—	75	611801	613801
2.002	611692	—	3	611613	613613	80	611678	613678
2.003	611693	—	3.5	611643	613643	90	611679	613679
2.004	611694	—	4	611614	613614	100	611681	613681
2.005	611695	—	4.5	611644	613644	125	611802	613802
2.006	611696	—	5	611615	613615	131.4	611858	613858
2.007	611697	—	5.1	611850	613850	150	611803	613803
2.008	611698	—	5.5	611645	613645	175	611804	613804
2.009	611699	—	6	611616	613616	200	611682	613682
2.01	611701	—	6.5	611646	613646	250	611805	613805
2.02	611702	—	7	611617	613617	300	611683	613683
2.03	611703	—	7.5	611647	613647	400	611684	613684
2.04	611704	—	7.7	611851	613851	500	611685	613685
2.05	611705	—	8	611618	613618	600	611840	—
2.06	611706	—	8.5	611648	613648	700	611841	—
2.07	611707	—	9	611619	613619	750	611842	—
2.08	611708	—	9.5	611649	613649	800	611843	—
2.09	611709	—	10	611671	613671	900	611844	—
2.1	611710	—	10.3	611852	613852	1000	611845	—
2.11	611711	—	10.5	611650	613650			
2.12	611712	—	11	611621	613621			
2.13	611713	—	11.5	611651	613651			
2.14	611714	—	12	611622	613622			
2.15	611715	—	12.5	611652	613652			
2.16	611716	—	12.9	611853	613853			

Metric Wear Block	
Length (mm)	Order No.
	Tungsten carbide
1	612611
2	612612

## DIMENSIONS

Unit: mm

Nominal length:  
0.1mm - 5.5mm

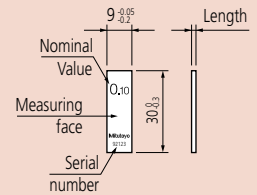

Nominal length:  
6mm - 10mm

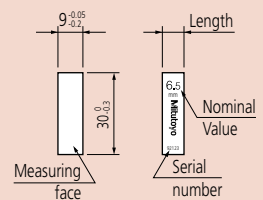

Nominal length:  
10.3mm - 100mm

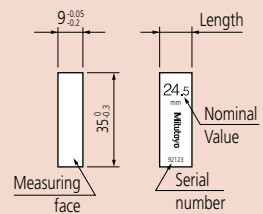

Nominal length 125mm - 1000mm

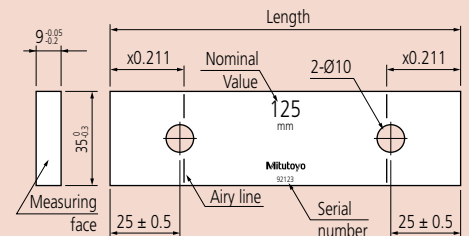

Suffix Number for Selecting Standard and Certificate Provided

ASME	Grade	Steel, CERA
	K	-516**
	00	-521*
	0	-531*
	AS-1	-541*
	AS-2	-551*

\* provided with Inspection Certificate  
 \*\* provided with Calibration Certificate and Inspection Certificate

Example: 611310-521  
 .1" gage block in grade 00.

We make custom length gage blocks:  
 .004 - 20"



Inspection Certificate

DIMENSIONS

Unit: Inch

Nominal length:  
 .004 - .25"

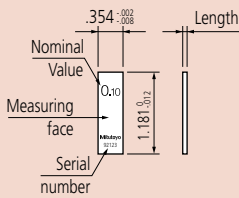

Nominal length:  
 .3 - 4"

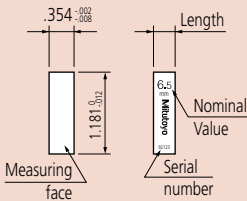

Nominal length:  
 .45 - 4"

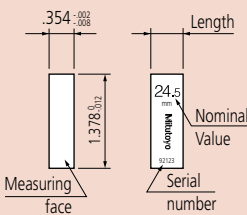

Nominal length 5 - 20"

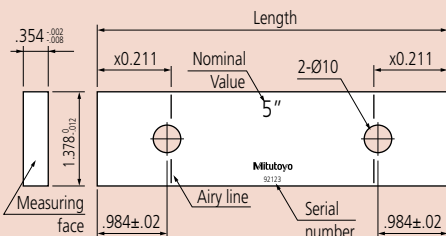

# Individual Inch Rectangular Gage Block

## SPECIFICATIONS

### Inch Block

Length (inch)	Order No.	
	Steel	CERA
.004	611304	—
.005	611305	—
.006	611306	—
.007	611307	—
.008	611308	—
.009	611309	—
.01	611310	—
.011	611311	—
.012	611312	—
.013	611313	—
.014	611314	—
.015	611315	—
.016	611316	—
.017	611317	—
.018	611318	—
.019	611319	—
.02	611320	—
.02005	611240	—
.0201	611231	—
.0202	611232	—
.0203	611233	—
.0204	611234	—
.0205	611235	—
.0206	611236	—
.0207	611237	—
.0208	611238	—
.0209	611239	—
.021	611321	—
.022	611322	—
.023	611323	—
.024	611324	—
.025	611325	—
.026	611326	—
.027	611327	—
.028	611328	—
.029	611329	—
.03	611330	—
.031	611331	—
.03125 (1/32)	611101	613103
.032	611332	—
.033	611333	—
.034	611334	—
.035	611335	—
.036	611336	—
.037	611337	—
.038	611338	—
.039	611339	—
.04	611340	—
.041	611341	—
.042	611342	—
.043	611343	—
.044	611344	—
.045	611345	—
.046	611346	—
.046875 (3/64)	611102	613104
.047	611347	—
.048	611348	—
.049	611349	—
.05	611105	613105

Length (inch)	Order No.	
	Steel	CERA
.06	611106	—
.0625	611303	613303
.07	611107	—
.078125 (5/64)	611103	613100
.08	611108	—
.09	611109	—
.09375 (3/32)	611104	613101
.1	611191	613191
.100025	611111	613110
.10005	611135	613135
.100075	611121	613111
.1001	611121	613121
.1002	611122	613122
.1003	611123	613123
.1004	611124	613124
.1005	611125	613125
.1006	611126	613126
.1007	611127	613127
.1008	611128	613128
.1009	611129	613129
.101	611141	613141
.102	611142	613142
.103	611143	613143
.104	611144	613144
.105	611145	613145
.106	611146	613146
.107	611147	613147
.108	611148	613148
.109	611149	613149
.109375 (7/64)	611110	613102
.11	611150	613150
.111	611151	613151
.112	611152	613152
.113	611153	613153
.114	611154	613154
.115	611155	613155
.116	611156	613156
.117	611157	613157
.118	611158	613158
.119	611159	613159
.12	611160	613160
.121	611161	613161
.122	611162	613162
.123	611163	613163
.124	611164	613164
.125	611165	613165
.126	611166	613166
.127	611167	613167
.128	611168	613168
.129	611169	613169
.13	611170	613170
.131	611171	613171
.132	611172	613172
.133	611173	613173
.134	611174	613174
.135	611175	613175
.136	611176	613176
.137	611177	613177
.138	611178	613178

Length (inch)	Order No.	
	Steel	CERA
.139	611179	613179
.14	611180	613180
.141	611181	613181
.142	611182	613182
.143	611183	613183
.144	611184	613184
.145	611185	613185
.146	611186	613186
.147	611187	613187
.148	611188	613188
.149	611189	613189
.15	611115	613115
.16	611116	613116
.17	611117	613117
.18	611118	613118
.19	611119	613119
.2	611192	613192
.21	611221	613221
.25	611212	613212
.3	611193	613193
.315	611209	613209
.35	611213	613213
.375 (3/8)	611113	613112
.4	611194	613194
.420	611210	613210
.45	611214	613214
.5	611195	613195
.55	611215	613215
.6	611196	613196
.605	611211	613211
.65	611216	613216
.7	611197	613197
.710	611220	613220
.75	611217	613217
.8	611198	613198
.815	611226	613226
.85	611218	613218
.9	611199	613199
.920	611227	613227
.95	611219	613219
1	611201	613201
2	611202	613202
3	611203	613203
4	611204	613204
5	611205	613205
6	611206	613206
7	611207	613207
8	611208	613208
10	611222	613222
12	611223	613223
16	611224	613224
20	611225	613225

### Inch Wear Block

Length (inch)	Order No.
	Tungsten carbide
.05	612105
.1	612191



# Rectangular Gage Block with CTE

## Gage Blocks with Thermal Expansion Coefficient Data

### FEATURES

- Mitutoyo offers top-level gage blocks (steel and ceramic) which are superior to K class blocks.
- Comes with a highly accurate thermal expansion coefficient measured with a high-accuracy double-faced interferometer (DFI).
- The high-accuracy gage block interferometer (GBI) guarantees high dimensional accuracy.
- Mitutoyo offers rectangular gage blocks, having nominal values from 100 to 500mm  
Grade: K class in ASME  
Uncertainty of thermal expansion coefficient:  $0.035 \times 10^{-6}/K$  ( $k = 2$ )  
Uncertainty of dimension measurement: 30nm ( $k = 2$ ), for 100mm block



Double-faced interferometer (DFI)

### SPECIFICATIONS

Metric Block with CTE		
Length (mm)	Order No. Steel	Order No. CERA
100	611681-51B	613681-51B
125	611802-51B	613802-51B
150	611803-51B	613803-51B
175	611804-51B	613804-51B
200	611682-51B	613682-51B
250	611805-51B	613805-51B
300	611683-51B	613683-51B
400	611684-51B	613684-51B
500	611685-51B	613685-51B

Inch Block with CTE		
Length (inch)	Order No. Steel	Order No. CERA
4	611204-51B	613204-51B
5	611205-51B	613205-51B
6	611206-51B	613206-51B
7	611207-51B	613207-51B
8	611208-51B	613208-51B
10	611222-51B	613222-51B
12	611223-51B	613223-51B
16	611224-51B	613224-51B
20	611225-51B	613225-51B

Suffix Number for Selecting Standard and Certificate Provided

ASME	
Grade K	-51B
-51B: provided with JCSS Calibration Certificate and Inspection Certificate	



Inspection Certificate

### ZERO CERA Blocks

- Thermal expansion in the temperature range  $20 \pm 1^\circ C$  less than 1/500 that of steel ( $0 \pm 0.02 \times 10^{-6}/K(20^\circ C)$ )
- Almost no secular change both in dimension and coefficient of thermal expansion
- Complementary ultra-low thermal expansion and high specific rigidity (Young's Modulus/specific gravity)

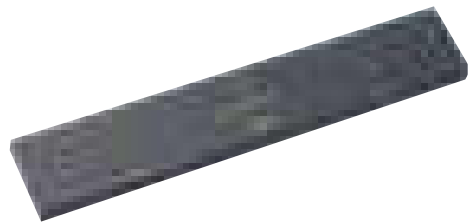

### SPECIFICATIONS

Metric Blocks			
Order No.			Length (mm)
JIS/ISO/DIN	BS	ASME	
617673-016	617673-116	617673-516	30
617675-016	617675-116	617675-516	50
617681-016	617681-116	617681-516	100
617682-016	617682-116	617682-516	200
617683-016	617683-116	617683-516	300
617684-016	617684-116	617684-516	400
617685-016	617685-116	617685-516	500
617840-016	617840-116	617840-516	600
617841-016	617841-116	617841-516	700
617843-016	617843-116	617843-516	800
617844-016	617844-116	617844-516	900
617845-016	617845-116	617845-516	1000
516-771-60	516-771-61	516-771-66	Above set



# Rectangular Gage Block Accessories

## SERIES 516 – For Gage Blocks over 100mm

Specially designed for long gage blocks over 100mm, which have two holes on the body for coupling.



516-605

### SPECIFICATIONS

#### Accessories for gage blocks over 100mm

Order No. 516-605	Included in set
1 pc.	Holder A (619031)
1 pc.	Holder B (619032)
1 pc.	Holder C (619033)
1 pc.	Holder D (619034)
1 pc.	Holder E (619035)
3 pcs.	Adaptor (619036)
1 pc.	Holder base 35mm (619009)
2 pcs.	Half round jaw 12mm (619013)
1 pc.	Plain jaw (2 pc. set) (619018)
1 pc.	Scriber point (619019)

Note: These accessories can be used for inch rectangular gage blocks.

#### Holder A: 619031

Used for coupling two long gage blocks.

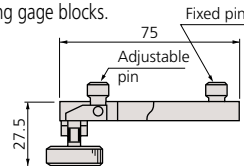

#### Holder B and C:

Used for coupling two long gage blocks together with other gage blocks up to 35mm (Holder B) or 140mm (Holder C). Also used for attaching jaws with two adaptors.

	Order No.	R (max.)	L
Holder B	619032	90mm	126mm
Holder C	619033	200mm	236mm

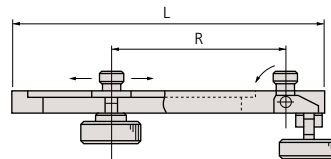

#### Holder D: 619034

Used for attaching to the holder base.

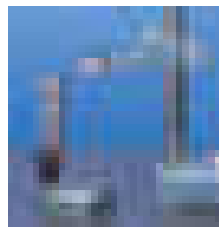
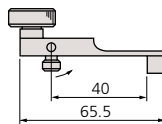

#### Holder E: 619035

Used for attaching to the holder base together with other gage blocks up to 125mm. Used for attaching jaws with one adaptor.

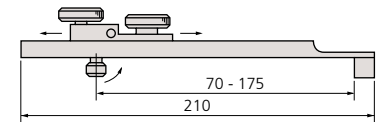

#### Half-round jaw: 619013

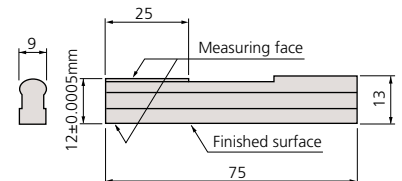

#### Holder base: 619009 Adaptor: 619036

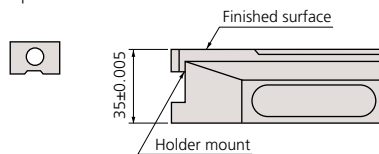

#### Scriber point: 619019

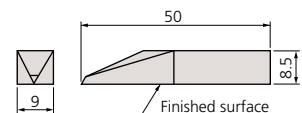

#### Plain jaw: 619018 (2 pc. set)

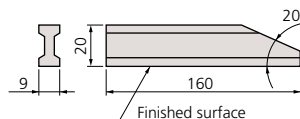

# Rectangular Gage Block Accessories

## SERIES 516

To expand the variety of rectangular gage block (steel and CERA) applications, Mitutoyo offers the gage block accessories set. By assembling the items in the set, you can easily and quickly build up a precision measuring instrument.

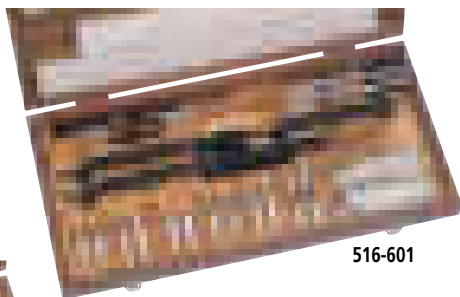

516-601



516-602

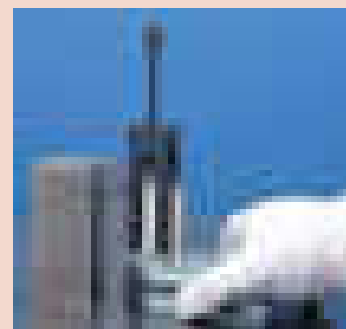

## SPECIFICATIONS

### Assortment of Accessories

Order No.	Accessories	Metric Set Order No.		Accessory (s) included in a set
		516-601	516-602	
619002	Holder 60mm		•	1 pc.
619003	Holder 100mm	•	•	1 pc.
619004	Holder 160mm	•	•	1 pc.
619005	Holder 250mm	•	•	1 pc.
619009	Holder Base 35mm	•	•	1 pc.
619010	Half round jaw 2mm	•	•	2 pcs.
619011	Half round jaw 5mm	•	•	2 pcs.
619012	Half round jaw 8mm	•	•	2 pcs.
619013	Half round jaw 12mm	•		2 pcs.
619014	Half round jaw 20mm	•		2 pcs.
619018	Plain jaw (2 pc. set) 160mm	•		1 pc.
619019	Scriber point	•	•	1 pc.
619020	Center point	•	•	1 pc.
619021	Tram point	•		2 pcs.
619022	Triangular straightness edge 100mm	•	•	1 pc.
619023	Triangular straight edge 160mm	•		1 pc.
	<b>Total Qty. in set</b>	22 pcs.	14 pcs.	



# Rectangular Gage Block Accessories

Holder:  
Used as a clamp if using plain jaws, scriber point, etc.

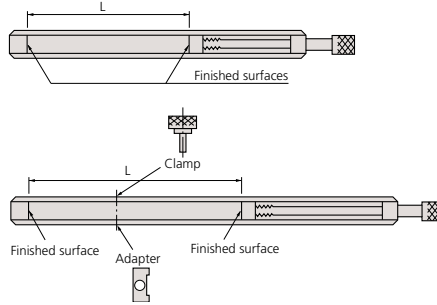

Order No.	L
619002	15 - 61mm
619003	4 - 106mm
619004	62 - 165mm
619005	153 - 256mm

Holder base 35mm: **619009**  
Measures a height on the surface plate and scribes a workpiece if used with the holder.

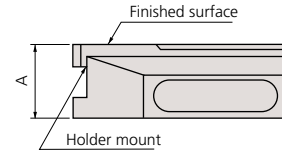

Order No.	A
619009	35±0.005mm

Scriber point: **619019**  
Scribes a workpiece if used with the holder and holder base.

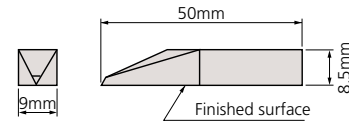

Center point: **619020**  
Scribes a workpiece if used with the holder and holder base.

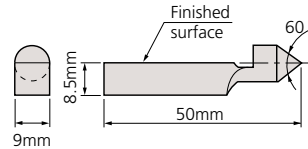

Tram point: **619021**  
Inspects the scale of the height gage, etc., if used with the holder and holder base.

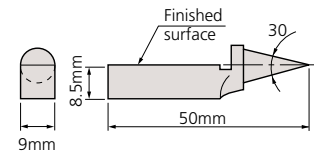

Plain jaw: **619018**  
Measures an outside or inside diameter if used with a pair of jaws and the holder.

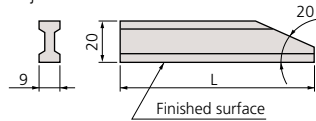

Order No.	L
619018*	160mm

\* 2 pc. set

Triangular straight edge: Measures parallelism.

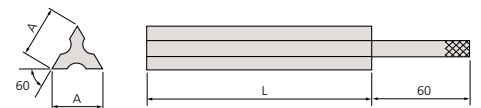

Order No.	L
619022	100mm
619023	160mm

Half-round jaw:  
Measures an outside or inside diameter if used with a pair of jaws and the holder.

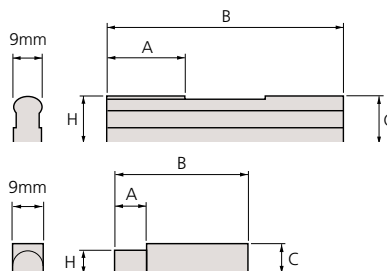

Order No.	H	A	B	C
619010	2±0.0005mm	6mm	40mm	8mm
619011	5±0.0005mm	6mm	50mm	8mm
619012	8±0.0005mm	12mm	60mm	8mm
619013	12±0.0005mm	25mm	75mm	13mm
619014	20±0.0005mm	25mm	125mm	20.5mm

# Metric Square Gage Block Set

## SERIES 516 — Metric Block Set, Long Block Set, Wear Block Set

A square gage block can retain stable orientation both longitudinally and laterally. A wide range of application measurements can be made, including cutting tool positioning, angle measurement with a sine bar, taper measurement with a roller, and inspection of depth micrometers.



Steel 32-block set



Steel 76-block set

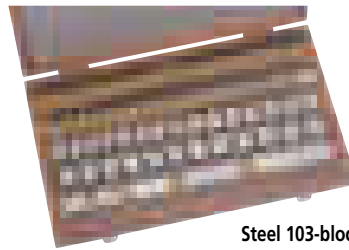

Steel 103-block set



Steel 112-block set

## SPECIFICATIONS

### Metric Block Set

Blocks per set	Order No.		Grade	Blocks included in set		
	Steel	CERA		Size	Step	Qty.
<b>112</b>	516-437-26	—	00	1.0005	—	1
	516-438-26	—	0	1.001 - 1.009	0.001	9
	516-439-26	—	AS-1	1.01 - 1.49	0.01	49
	516-440-26	—	AS-2	0.5 - 24.5	0.5	49
	—	—	—	25 - 100	25	4
<b>103</b>	516-441-26	—	00	1.005	—	1
	516-442-26	—	0	1.01 - 1.49	0.01	49
	516-443-26	—	AS-1	0.5 - 24.5	0.5	49
	516-444-26	—	AS-2	25 - 100	25	4
	—	—	—	—	—	—
<b>76</b>	516-449-26	—	00	1.005	—	1
	516-450-26	—	0	1.01 - 1.49	0.01	49
	516-451-26	—	AS-1	0.5 - 9.5	0.5	19
	516-452-26	—	AS-2	10 - 40	10	4
	—	—	—	50 - 100	25	3
<b>47</b>	516-457-26	—	00	1.005	—	1
	516-458-26	—	0	1.01 - 1.09	0.01	9
	516-459-26	—	AS-1	1.1 - 1.9	0.1	9
	516-460-26	—	AS-2	1 - 24	1	24
	—	—	—	25 - 100	25	4
<b>32</b>	516-465-26	—	00	1.005	—	1
	516-466-26	—	0	1.01 - 1.09	0.01	9
	516-467-26	—	AS-1	1.1 - 1.9	0.1	9
	516-468-26	—	AS-2	1 - 9	1	9
	—	—	—	10 - 30	10	3
	—	—	—	60	—	1

### Metric Long Block Set

Blocks per set	Order No.		Grade	Blocks included in set		
	Steel	CERA		Size	Step	Qty.
<b>8</b>	516-751-26	—	00	125, 150, 175	25	3
	516-752-26	—	0	200, 250	50	2
	516-753-26	—	AS-1	300, 400, 500	100	3
	516-754-26	—	AS-2	—	—	—

### Metric Wear Block Set

Blocks per set	Order No.		Grade	Blocks included in set		
	Carbide	CERA		Size	Step	Qty.
<b>2</b>	516-820-26	—	0	1	—	2
	516-821-26	—	AS-1	—	—	—

Provided with Inspection Certificate



Provided with Inspection Certificate

# Inch Square Gage Block Set

**SERIES 516 — Inch Block Set, Long Block Set, Wear Block Set**

## SPECIFICATIONS

### Inch Block Set

Blocks per set	Order No.		Grade	Blocks included in set		
	Steel	CERA		Size	Step	Qty.
<b>81</b>	516-401-26	516-201-26	00	.1001 - .1009	.0001	9
	516-402-26	516-202-26	0	.101 - .149	.001	49
	516-403-26	516-203-26	AS-1	.05 - .95	.05	19
	516-404-26	516-204-26	AS-2	1 - 4	1	4
<b>36</b>	516-421-26	516-221-26	00	.05"		1
	516-422-26	516-222-26	0	.1001 - .1009	.0001	10
	516-423-26	516-223-26	AS-1	.101 - .109	.001	9
	516-424-26	516-224-26	AS-2	.11 - .19 .1 - .5 1, 2, 4	.01 .1 1	9 5 3
<b>28</b>	516-417-26	—	00	.02005"		1
	516-418-26	—	0	.0201 - .0209"	.0001	9
	516-419-26	—	AS-1	.021 - .029"	.001	9
	516-420-26	—	AS-2	.021 - .029" .10 - .090"	.01	9

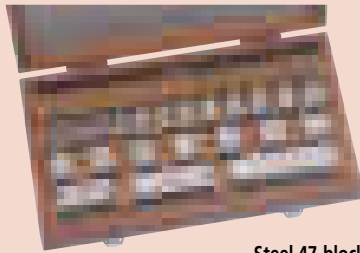

Steel 47-block set

### Inch Long Block Set

Blocks per set	Order No.		Grade	Blocks included in set		
	Steel	CERA		Size	Step	Qty.
<b>8</b>	516-762-26	—	0	5 - 7	1	3
	516-763-26	—	AS-1	8, 10, 12 16, 20	2 4	3 2

### Inch Wear Block Set

Blocks per set	Order No.		Grade	Blocks included in set		
	Carbide	CERA		Size	Step	Qty.
<b>2</b>	516-824-26	516-846-26	0	.05	—	2
	516-825-26	516-847-26	AS-1			
<b>2</b>	516-826-26	516-844-26	0	.1	—	2
	516-827-26	516-845-26	AS-1			



Steel 8-block set



Carbide 2-block set

### 92 pcs. Gage Blocks with accessories set in wooden box

Blocks in set	Order No.	Grade	Blocks included in set			Individual No.	Description	Qty.
			Size	Step	Qty.			
<b>92</b>	516-405-26	0	.0625	.0001	1	619052	Plain Jaw .500"	2
			.078125		1	619051	Half round jaw .250"	2
			.09375		1	619055	Holder base .500"	1
			.100025		1	619057	Flat head screw 1 1/4"	2
			.10005		1	619058	Flat head screw 5/8"	2
			.100075		1	619056	Stud	2
			.109375		1	619066	Knurled head screw	2
			.1001 - .1009		9	619059	Slotted head nut	2
			.101 - .149		49	619062	Tie rod 3"	1
			.05 - .95		4	619063	Tie rod 2 1/4"	1
			.16 - .19		19	619064	Tie rod 1 1/2"	1
			1 4		4	619065	3/4"	1

# Individual Metric Square Gage Block



## SPECIFICATIONS

### Metric Block

Length (mm)	Order No.		Length (mm)	Order No.		Length (mm)	Order No.	
	Steel	CERA		Steel	CERA		Steel	CERA
0.5	614506	—	1.33	614593	—	13	614623	—
1	614611	—	1.34	614594	—	13.5	614653	—
1.0005	614520	—	1.35	614595	—	14	614624	—
1.001	614521	—	1.36	614596	—	14.5	614654	—
1.002	614522	—	1.37	614597	—	15	614625	—
1.003	614523	—	1.38	614598	—	15.5	614655	—
1.004	614524	—	1.39	614599	—	16	614626	—
1.005	614525	—	1.4	614600	—	16.5	614656	—
1.006	614526	—	1.41	614601	—	17	614627	—
1.007	614527	—	1.42	614602	—	17.5	614657	—
1.008	614528	—	1.43	614603	—	18	614628	—
1.009	614529	—	1.44	614604	—	18.5	614658	—
1.01	614561	—	1.45	614605	—	19	614629	—
1.02	614562	—	1.46	614606	—	19.5	614659	—
1.03	614563	—	1.47	614607	—	20	614672	—
1.04	614564	—	1.48	614608	—	20.5	614660	—
1.05	614565	—	1.49	614609	—	21	614631	—
1.06	614566	—	1.5	614641	—	21.5	614661	—
1.07	614567	—	1.6	614516	—	22	614632	—
1.08	614568	—	1.7	614517	—	22.5	614662	—
1.09	614569	—	1.8	614518	—	23	614633	—
1.1	614570	—	1.9	614519	—	23.5	614663	—
1.11	614571	—	2	614612	—	24	614634	—
1.12	614572	—	2.5	614642	—	24.5	614664	—
1.13	614573	—	3	614613	—	25	614635	—
1.14	614574	—	3.5	614643	—	30	614673	—
1.15	614575	—	4	614614	—	40	614674	—
1.16	614576	—	4.5	614644	—	50	614675	—
1.17	614577	—	5	614615	—	60	614676	—
1.18	614578	—	5.5	614645	—	75	614801	—
1.19	614579	—	6	614616	—	100	614681	—
1.2	614580	—	6.5	614646	—	125	614802	—
1.21	614581	—	7	614617	—	150	614803	—
1.22	614582	—	7.5	614647	—	175	614804	—
1.23	614583	—	8	614618	—	200	614682	—
1.24	614584	—	8.5	614648	—	250	614805	—
1.25	614585	—	9	614619	—	300	614683	—
1.26	614586	—	9.5	614649	—	400	614684	—
1.27	614587	—	10	614671	—	500	614685	—
1.28	614588	—	10.5	614650	—			
1.29	614589	—	11	614621	—			
1.3	614590	—	11.5	614651	—			
1.31	614591	—	12	614622	—			
1.32	614592	—	12.5	614652	—			

### Metric Wear Block

Length (mm)	Order No. Tungsten carbide
1	615611
2	615612

Suffix Number for Selecting Standard and Certificate Provided

### ASME

Grade	Steel
K	—
00	-521*
0	-531*
AS-1	-541*
AS-2	-551*

\* provided with Inspection Certificate

Example: 614611-521  
1mm gage block in grade 00.

We make custom length gage blocks:  
0.5 - 500mm.

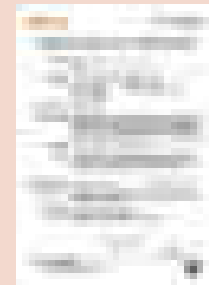

Inspection Certificate

# Individual Inch Square Gage Block

## Suffix Number for Selecting Standard and Certificate Provided

ASME	
Grade	Steel, CERA
K	—
00	-521*
0	-531*
AS-1	-541*
AS-2	-551*

\* provided with Inspection Certificate

Example: 614310-521  
.01" gage block in grade 00.

We make custom length gage blocks:  
.01 - 20"

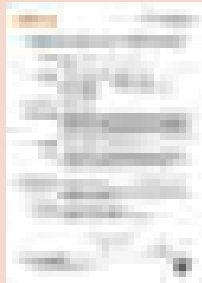

Inspection Certificate

## DIMENSIONS

Nominal length: 0.5mm - 4.5mm  
(.010" - .19")

Unit: mm

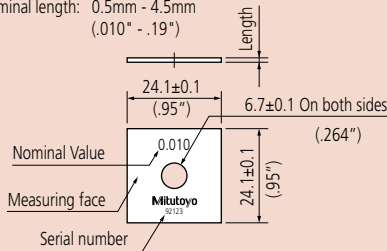

Nominal length: 5mm - 14.5mm  
(.02" - .450")

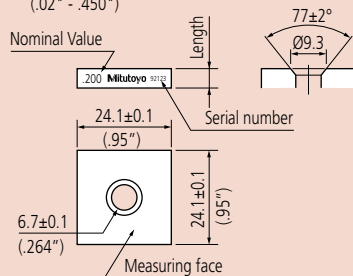

Nominal length: 15mm - 500mm  
(.500" - 20")

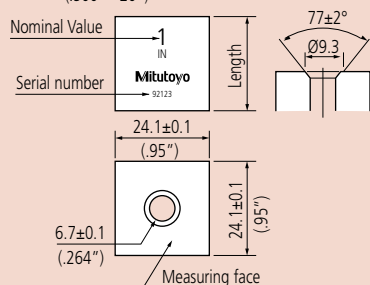

## SPECIFICATIONS

### Inch Block

Length (inch)	Order No.		Length (inch)	Order No.		Length (inch)	Order No.	
	Steel	CERA		Steel	CERA		Steel	CERA
.01	614310	—	.106	614146	616146	.25	614212	616212
.02005	614240	—	.107	614147	616147	.3	614193	616193
.0201	614231	—	.108	614148	616148	.35	614213	616213
.0202	614232	—	.109	614149	616149	.375 (3/8)	614309	—
.0203	614233	—	.109375 (7/64)	614306	—	.4	614194	616194
.0204	614234	—	.11	614150	616150	.45	614214	616214
.0205	614235	—	.111	614151	616151	.5	614195	616195
.0206	614236	—	.112	614152	616152	.55	614215	616215
.0207	614237	—	.113	614153	616153	.6	614196	616196
.0208	614238	—	.114	614154	616154	.65	614216	616216
.0209	614239	—	.115	614155	616155	.7	614197	616197
.02	614320	—	.116	614156	616156	.75	614217	616217
.021	614321	—	.117	614157	616157	.8	614198	616198
.022	614322	—	.118	614158	616158	.85	614218	616218
.023	614323	—	.119	614159	616159	.9	614199	616199
.024	614324	—	.12	614160	616160	.95	614219	616219
.025	614325	—	.121	614161	616161	1	614201	616201
.026	614326	—	.122	614162	616162	2	614202	616202
.027	614327	—	.123	614163	616163	3	614203	616203
.028	614328	—	.124	614164	616164	4	614204	616204
.029	614329	—	.125	614165	616165	5	614205	—
.03	614330	—	.126	614166	616166	6	614206	—
.03125 (1/32)	614301	—	.127	614167	616167	7	614207	—
.04	614340	—	.128	614168	616168	8	614208	—
.046875 (3/64)	614302	—	.129	614169	616169	10	614222	—
.05	614105	616105	.13	614170	616170	12	614223	—
.06	614106	—	.131	614171	616171	16	614224	—
.0625	614303	616303	.132	614172	616172	20	614225	—
.07	614107	—	.133	614173	616173			
.078125 (5/64)	614304	—	.134	614174	616174			
.08	614108	—	.135	614175	616175			
.09	614109	—	.136	614176	616176			
.09375 (3/32)	614305	—	.137	614177	616177			
.1	614191	616191	.138	614178	616178			
.100025	614307	—	.139	614179	616179			
.10005	614135	616135	.14	614180	616180			
.100075	614308	—	.141	614181	616181			
.1001	614121	616121	.142	614182	616182			
.1002	614122	616122	.143	614183	616183			
.1003	614123	616123	.144	614184	616184			
.1004	614124	616124	.145	614185	616185			
.1005	614125	616125	.146	614186	616186			
.1006	614126	616126	.147	614187	616187			
.1007	614127	616127	.148	614188	616188			
.1008	614128	616128	.149	614189	616189			
.1009	614129	616129	.15	614115	616115			
.101	614141	616141	.16	614116	616116			
.102	614142	616142	.17	614117	616117			
.103	614143	616143	.18	614118	616118			
.104	614144	616144	.19	614119	616119			
.105	614145	616145	.2	614192	616192			

### Inch Wear Block

Length (inch)	Order No. Tungsten carbide
.05	615105
.1	615191

# Square Gage Block Accessories

## SERIES 516

To expand the variety of square gage block applications, Mitutoyo offers the gage block accessories set. By assembling the items in the set, you can easily and quickly build up a precision measuring instrument.



516-611

### SPECIFICATIONS

Metric	
Order No. 516-611	Included in set
2 pcs.	Half round jaw 2mm (619070)
2 pcs.	Half round jaw 5mm (619071)
2 pcs.	Plain jaw (619072)
1 pc.	Center point (619073)
1 pc.	Scriber point (619054)
1 pc.	Block base (619074)
2 pcs.	Flat head screw 1-1/4" (619057)
2 pcs.	Flat head screw 5/8" (619058)
2 pcs.	Slotted head nut (619059)
2 pcs.	Adjustable tie rod 6" (619060)
2 pcs.	Adjustable tie rod 4-1/2" (619061)
1 pc.	Tie rod 3" (619062)
1 pc.	Tie rod 2-1/4" (619063)
1 pc.	Tie rod 1-1/2" (619064)
1 pc.	Tie rod 3/4" (619065)
2 pcs.	Stud (619056)
2 pcs.	Knurled head screw (619066)

Inch	
Order No. 516-612	Included in set
2 pcs.	Half round jaw .125" (619050)
2 pcs.	Half round jaw .25" (619051)
2 pcs.	Plain jaw (619052)
1 pc.	Center point (619053)
1 pc.	Scriber point (619054)
1 pc.	Block base (619055)
2 pcs.	Flat head screw 1-1/4" (619057)
2 pcs.	Flat head screw 5/8" (619058)
2 pcs.	Slotted head nut (619059)
2 pcs.	Adjustable tie rod 6" (619060)
2 pcs.	Adjustable tie rod 4-1/2" (619061)
1 pc.	Tie rod 3" (619062)
1 pc.	Tie rod 2-1/4" (619063)
1 pc.	Tie rod 1-1/2" (619064)
1 pc.	Tie rod 3/4" (619065)
2 pcs.	Stud (619056)
2 pcs.	Knurled head screw (619066)

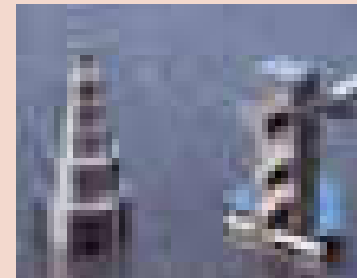
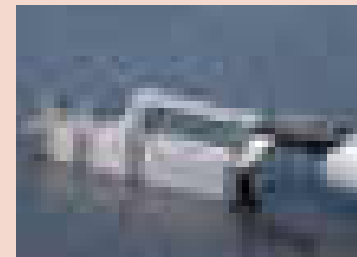

Half round jaw:  
Used to measure an inside or outside diameter.

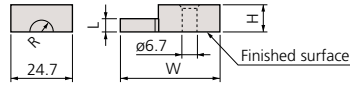

Order No.	R	L	W	H
<b>619070</b>	1.95mm	2mm	33.6mm	5.3mm
<b>619071</b>	4.95mm	5mm	39.9mm	10.3mm
<b>619050</b>	.123"	.125"	33.6mm	5.3mm
<b>619051</b>	.248"	.25"	39.9mm	10.3mm

Plain jaw: **619072** (10mm), **619052** (.5")  
Used to measure an inside or outside diameter.

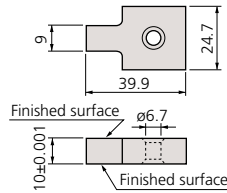

Center point: **619073** (2mm), **619053** (.1")  
Used to scribe a workpiece.

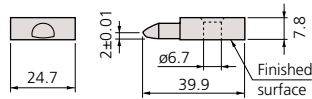

Scriber point: **619054**  
Used to scribe a workpiece.

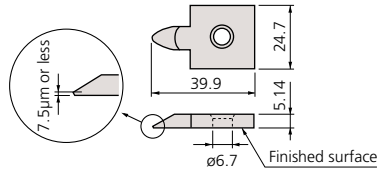

Base: **619074** (10mm), **619055** (.5")  
Used as clamps by inserting them into the center hole of a square gage block.

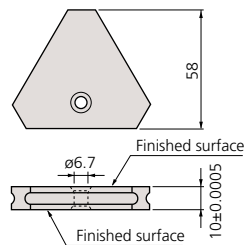

Stud: **619056**

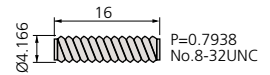

Flat head screw

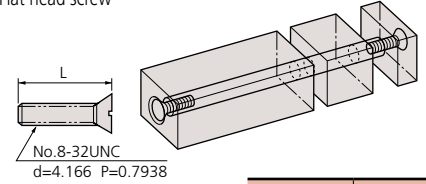

Order No.	L
<b>619057</b>	31.6mm
<b>619058</b>	15.8mm

Slotted head nut: **619059**

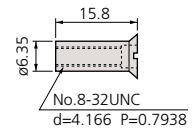

Knurled head screw: **619066**

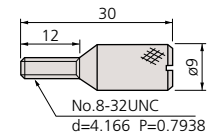

Tie rod

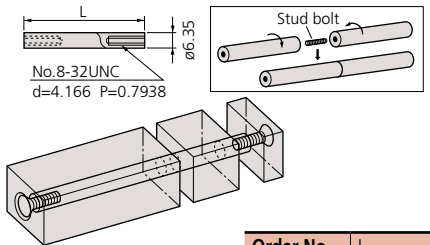

Order No.	L
<b>619065</b>	19mm
<b>619064</b>	38mm
<b>619063</b>	57mm
<b>619062</b>	76mm

Adjustable tie rod

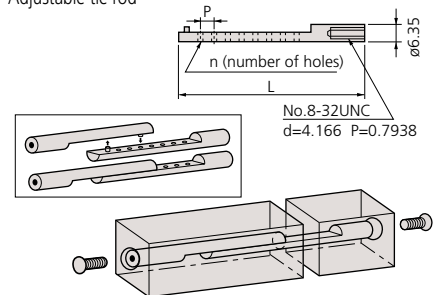

Order No.	L	P	n
<b>619060</b>	124.5mm	6.35mm	14
<b>619061</b>	86.5mm	6.35mm	8

# Ceraston

## Accessory for Gage Blocks

### FEATURES

- Alumina-ceramic grinding stone for removing burrs from hard materials such as ceramics that ordinary grinding stones cannot handle.
- Can be used both for steel gage blocks and CERA Blocks.

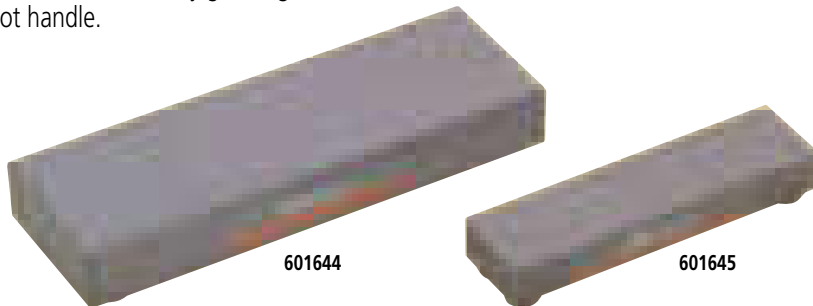

### SPECIFICATIONS

Order No.	Dimensions (W x D x H)	Mass
601645	100 x 25 x 12mm	110g
601644	150 x 50 x 20mm	530g

# Maintenance Kit for Gage Blocks

## SERIES 516

### FEATURES

- Includes all necessary maintenance tools for daily care and storage of gage blocks.
- Supplied in a fitted wooden case for portable use.



### SPECIFICATIONS

Order No.	Assortment of tools and accessories
516-650E	Ceraston (601645): Used for removing burrs on the measuring surface.
	Optical flat (158-117): Used for checking whether burrs exist.
	Tweezers (600004): Used for handling thin gage blocks.
	Blower brush (600005): Used for blowing out dust on the measuring surface.
	Cleaning paper (600006): Used for wiping off rust preventive oil and contamination.
	Artificial leather mat (600007): Used as a gage block mat.
	Reagent bottle (600008): Bottle of wiping solution (100mL)
	Gloves

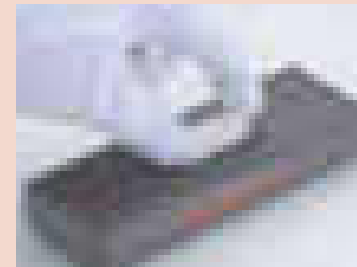

### Removing burrs

- (1) Wipe any dust and oil films from the gage block and the Ceraston (or Arkansas stone) using a solvent.
- (2) Place the gage block on the Ceraston so that the measuring face that has burrs is on the abrasive surface of the stone. While applying light pressure, move the gage block to and fro about ten times (Fig. 1). Use a block rubber for thin gage blocks to apply even pressure (Fig. 2).
- (3) Check the measuring face for burrs with an optical flat. If the burrs have not been removed, repeat step (2). If burrs are too large, they may not be removed with a grinding stone. If so, discard the gage block.

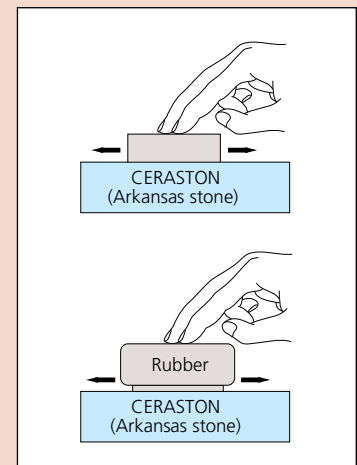

Note: The abrasive surface of a Ceraston must be made flat by lapping it from time to time. After lapping the Ceraston, the lapping powder must be completely removed from the surface to prevent the surface of the gage block from being scratched. Mitutoyo does not carry the Arkansas stone.





# Step Master

## SERIES 516

### FEATURES

Step master is a master gage used for the z-axis (vertical direction) calibration of optical instruments.

- Each adjacent step is measured down to  $0.01\mu\text{m}$  by using an interferometer within  $\pm 0.20\mu\text{m}$  allowance.
- Steel and ceramic types are available.

### Dimension

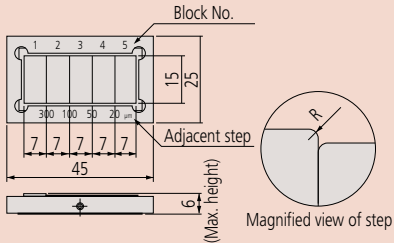

**516-498**  
Ceramic type



**516-199**  
Steel type



### SPECIFICATIONS

#### Metric

Order No.	Step value between adjacent blocks				Remarks
	No. 1 - No. 2	No. 2 - No. 3	No. 3 - No. 4	No. 4 - No. 5	
<b>516-198</b>	10 $\mu\text{m}$	5 $\mu\text{m}$	2 $\mu\text{m}$	1 $\mu\text{m}$	Steel type
<b>516-199</b>	300 $\mu\text{m}$	100 $\mu\text{m}$	50 $\mu\text{m}$	20 $\mu\text{m}$	Steel type
<b>516-498</b>	10 $\mu\text{m}$	5 $\mu\text{m}$	2 $\mu\text{m}$	1 $\mu\text{m}$	Ceramic type
<b>516-499</b>	300 $\mu\text{m}$	100 $\mu\text{m}$	50 $\mu\text{m}$	20 $\mu\text{m}$	Ceramic type

# Made-to-order Block & Reference

### Available Dimension

Nominal size: .004 to 20" / 0.1 to 1000mm (steel)  
.1 to 20" / 0.5 to 500mm (ceramic)

Nominal pitch: 0.0005mm (up to 100mm)  
0.001mm (over 100mm)

Minimum section dimension:  
Approx. .24 x .24" / 6 x 6mm

Maximum section dimension:  
Approx. 5.5 x 5.5" / 140 x 140mm (steel)  
Approx. 6.3" Dia. /  $\phi$ 160mm (steel, cylindrical)  
Approx. 3.94 x 1.97" / 100 x 50mm (ceramic)  
Approx. .24" Dia. /  $\phi$ 60mm (ceramic, cylindrical)

Accuracy: Gage Block Grade level

Special materials of low expansion glass and low expansion ceramic are available.

### FEATURES

- Mitutoyo can provide gage blocks and reference gages to your size and design.

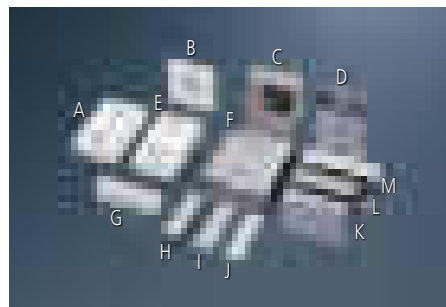

- A: Ceramic rectangular gage block (21.94mm)
- B: Ceramic square gage block (2.1005mm)
- C: Steel square gage block (10.72mm)
- D: Steel square gage block (2.2065mm)
- E: Ceramic rectangular gage block (20.64mm)
- F: Steel rectangular gage block (31.5mm)
- G: Ceramic rectangular gage block (6.34mm)
- H: Steel rectangular gage block (3.603mm)
- I: Steel rectangular gage block (1.1505mm)
- J: Steel rectangular gage block (0.555mm)
- K: Steel rectangular gage block (6.156mm)
- L: Steel rectangular gage block (9.694mm)
- M: Steel rectangular gage block (10.02mm)



- O: Steel long rectangular block (15 x 10 x 200mm)
- P: Ceramic square block (24.1 x 24.1 x 12.3mm)
- Q: Steel thin rectangular block (30 x 6 x 1.9mm)
- R: Steel square block (9 x 9 x 6mm)
- S: Steel thin rectangular block (30 x 6 x 2.1mm)
- T: Steel cylindrical block ( $\phi$ 13.08 x 12mm)

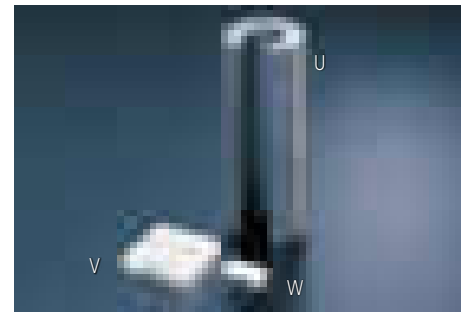

- U: Cylindrical reference block for depth micrometer ( $\phi$ 60 x 150mm)
- V: Ceramic reference plate (50 x 50 x 50mm, flatness 0.3 $\mu\text{m}$ )
- W: Ceramic stepped block (30 x 18 x 5mm, step: 0.15mm)

# Gage Block Comparator GBCD-250

**SERIES 565 — Manual Comparator with Dual Gage Heads**

## FEATURES

- Gage blocks between 0.1mm and 250mm easily can be compared with the standard gage block on the GBCD-250.
- The differential dual gaging heads assure the operator of a high-accuracy measurement with ease of use.

## SPECIFICATIONS

Inch/Metric	
Model No.	GBCD-250
Order No.	565-151A
Range	0.1mm - 250mm / .004 - 10"
Resolution	0.000001mm(0.01μm)/.0000001in(.1μin)
Accuracy in narrow range (20°C)	$\pm(0.03+0.3L/1000)\mu\text{m}^*$ L = Gage block length (mm)
Measuring units	Laser Hologage (upper and lower)
Operating condition	Temperature: 20°C $\pm$ 1°C Humidity: 30% RH to 60% RH
Data output	Via SPC output port
Dimensions (W x D x H)	Main unit: 455 x 318 x 691mm Display unit: 345 x 397 x 187mm
Mass	Main unit: Approx. 52kg Display unit: Approx. 9kg

\* 95% confidence interval (not including the calibration error of the standard gage block).

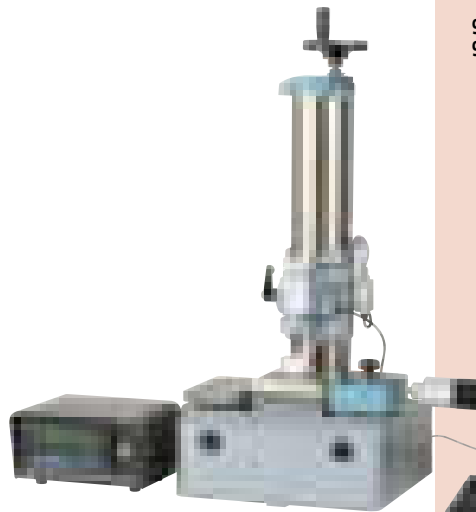

## Optional Accessories

- 962723: Gage head calibration kit  
 02ASD130: Square gage block holder kit  
 02ASF040: Heat protection shield  
 02ASQ953: GBPAK-M  
 Supporting OS: Windows XP, Vista, 7, or 10  
 937179T: Foot Switch  
 936937: Connecting cable



# Gage Block Comparator GBCD-100A

**SERIES 565 — Automatic-Type Comparator with Dual Gage Heads**

## SPECIFICATIONS

Model No.	GBCD-100A
Order No.	565-160A
Resolution	0.00001mm (0.01μm) / .000001"
Range	0.5mm - 100mm / .02 - 4"
Measuring unit	Differential (dual-head) type Mu-Checker
Accuracy in narrow range (20°C)	$\pm(0.03+0.3L/1000)\mu\text{m}^*$ L = Gage block length (mm)
Measuring force	Upper gage head: 1N (100gf) Lower gage head: 0.6N (60gf)
Air requirement	400kPa (4kgf/cm <sup>2</sup> )
Operating condition	Temperature: 20°C $\pm$ 1°C Humidity: 58%RH $\pm$ 15%RH
Dimensions (W x D x H)	Main unit: 710 x 366 x 783mm Electronic unit: 160 x 410 x 382mm
Mass	Main unit: 120kg Electronic unit: 14kg

\* 95% confidence interval (not including the calibration error of the standard gage block).



## Standard Accessories

GBPAK-A (software)

## Optional Accessories

516-146-E1: Gage block set for GBCD calibration

The GBCD-100A Automatic Gage Block Comparator is an easy-to-operate dual-head gage block inspecting system. It automatically compares workpieces with a standard gage block and determines accuracies such as central length, maximum length, minimum length and parallelism through the operation of an optional personal computer.



### Technical Data

Graduation: .00001" or 0.001mm  
 Counter Resolution: .001" or 0.01mm  
 Character Height: .16" / 4mm  
 Micrometer Head  
 Travel stroke: 1" or 20mm  
 Pitch: .025"/rev or 0.5mm/rev  
 Hysteresis: .00004" or 1µm  
 Provided with inspection certificate.

### Standard Accessories

Reference Block: 11mm for 515-322  
 Reference Block: .3" for 515-310, 515-311

### Optional Accessories

515-112: Auxiliary block kit for bore gage (mm)  
 515-119: Auxiliary block kit for bore gage (for 515-310)  
 515-121: Auxiliary block kit for bore gage (for 515-311)  
 —: Riser block

### Reading

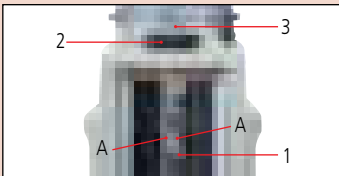

#### Height A

1. Scale	280	mm
2. Counter	5.67	mm
3. Thimble	0.000	mm
<hr/>		
	285.670	mm

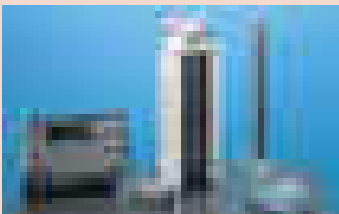

# Height Master

## SERIES 515

### FEATURES

- Models with staggered arrangement of block stack have two measuring faces on the same level, one facing up and the other down (except for 515-310).
- Each height master is supplied with a gage block for zero-setting.
- Supplied in fitted wooden case.

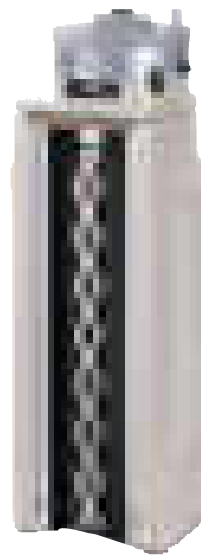

515-322

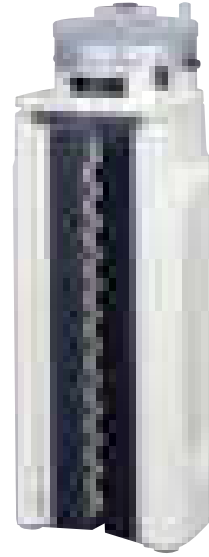

515-310

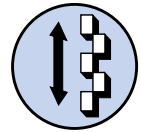

Staggered 20mm blocks (movable)

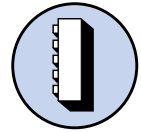

Vertical orientation

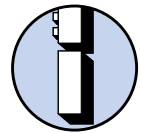

Riser block

### SPECIFICATIONS

#### Metric

Range (H)	Order No.	Block step	Graduation	Block Pitch Accuracy	Parallelism of Block	Micrometer Head Accuracy	Mass (kg)
5 < H ≤ 310mm	515-322	20mm (staggered)	0.001mm	±1.5µm	1µm	±1µm	23

#### Inch

Range (H)	Order No.	Block step	Graduation	Block Pitch Accuracy	Parallelism of Block	Micrometer Head Accuracy	Mass (kg)
.2" < H ≤ 12.2"	515-310	.5" (straight)	.00001"	±.00005"	.00004"	±.00005"	23
.2" < H ≤ 12.2"	515-311	1" (staggered)	.00001"	±.00005"	.00004"	±.00005"	23

# Digital Height Master

**SERIES 515**

## FEATURES

- Standard model with a digital display, featuring all essential specifications required for versatile height standard.
- With SPC output.
- Each height master is supplied with a gage block for zero setting.



515-374

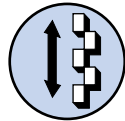

Staggered 20mm blocks (movable)

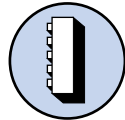

Vertical orientation

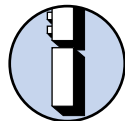

Riser block



## Technical Data

Resolution (LCD): .0001" or 0.001mm  
 Graduation: .0001" or 0.002mm  
 Character Height .21" / 5.4mm

### Micrometer Head

Travel Stroke: 1" or 20mm  
 Pitch: .025"/rev or 0.5mm/rev  
 Hysteresis: .0001" for all inch models  
 0.002mm for 300mm models  
 0.0025mm for 450 & 600mm models  
 Battery: SR44 (2 pcs.), **938882**  
 Battery life: Approx. 1.8 years under normal use

## Function

Zero-setting, Presetting, ABS/INC switching, Data hold, Data output, inch/mm conversion (on inch/metric models only)  
 Alarm: Low voltage, Counting value composition error

## Standard Accessories

Reference Block: 11mm for Metric Height Master **611621-031**  
 Reference Block: .6" for Inch Height Master **611196-531**  
 Provided with inspection certificate.

## Optional Accessories

- 515-111:** Auxiliary block kit for bore gage (mm)
- 515-120:** Auxiliary block kit for bore gage (inch)
- \_\_\_\_\_: Riser block (see page E-27.)
- 959149:** SPC cable (40" / 1m)
- 959150:** SPC cable (80" / 2m)
- 050019:** Fitted mahogany case for 12" / 300mm model
- 050059:** Fitted mahogany case for 18" / 450mm model  
24" / 600mm model

## SPECIFICATIONS

### Metric

Range (H)	Order No.	Block step	Resolution	Block Pitch Accuracy	Parallelism	Micrometer Head Accuracy	Mass (kg)
10 < H ≤ 310mm	<b>515-374</b>	20mm (staggered)	0.001mm	±1.5µm	2µm	±2µm	9.5
10 < H ≤ 460mm	<b>515-376</b>	20mm (staggered)	0.001mm	±2.5µm	2.5µm	±2µm	13.6
10 < H ≤ 610mm	<b>515-378</b>	20mm (staggered)	0.001mm	±3.5µm	2.5µm	±2.5µm	16.0

### Inch/Metric

Range (H)	Order No.	Block step	Resolution	Block Pitch Accuracy	Parallelism	Micrometer Head Accuracy	Mass (kg)
.5" < H ≤ 12"	<b>515-375</b>	1" (staggered)	.0001" / 0.001mm	±.0001"	.00005"	±.0001"	9.5
.5" < H ≤ 18"	<b>515-377</b>	1" (staggered)	.0001" / 0.001mm	±.0001"	.0001"	±.0001"	13.6
.5" < H ≤ 24"	<b>515-379</b>	1" (staggered)	.0001" / 0.001mm	±.0001"	.0001"	±.0001"	16.0

# Riser Blocks

## SERIES 515

### FEATURES

- These riser blocks are specially designed for standard/digimatic height masters.



515-113

515-114

515-115

### SPECIFICATIONS

Metric			
Height	Order No.	Accuracy of height	Mass (kg)
150mm	515-113	±0.6µm	5.7
300mm	515-114	±1.0µm	11.3
600mm	515-115	±2.0µm	31

Inch			
Height	Order No.	Accuracy of height	Mass (kg)
6"	515-116	±20µin	5.7
12"	515-117	±40µin	11.3
24"	515-118	±80µin	31

# Auxiliary Block Kit

## SERIES 515 — for Bore Gage

### FEATURES

- Used for efficient zero-setting of dial bore gages and tubular inside micrometers (18 - 150mm) on a Height Master.

Bore gage zero-setting

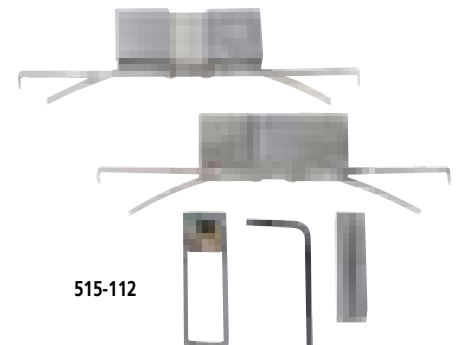
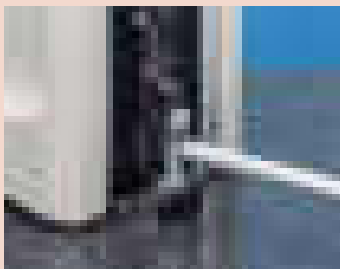

515-112

### SPECIFICATIONS

Metric	
Order No.	Applicable height master
515-110	Universal Height Master
515-111	Digimatic Height Master
515-112	Height Master

Inch	
Order No.	Applicable height master
515-119	Universal Height Master, Height Master (515-310)
515-120	Digimatic Height Master
515-121	Height Master (515-311)

# Universal Height Master

## SERIES 515 — Use in Vertical and Horizontal Orientation

### FEATURES

- The Universal Height Master is designed for both vertical and horizontal orientations, providing a wide range of applications, such as accuracy checking of machine tool table movements.
- Fitted wooden case supplied.

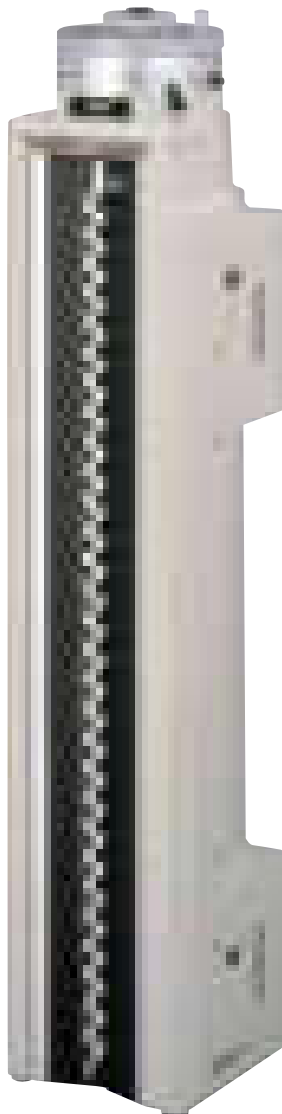

515-520

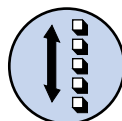

Single-row 10mm blocks (movable)

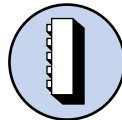

Vertical orientation

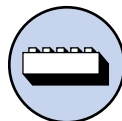

Horizontal orientation

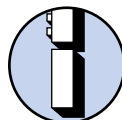

Riser block

### SPECIFICATIONS

#### Metric

Range (R)	Order No.	Block step	Graduation	Block Pitch Accuracy	Parallelism of Block	Micrometer Head Accuracy	Mass (kg)
$5 < R \leq 610\text{mm}$	<b>515-520</b>	10mm (straight)	0.001mm	$\pm 1.5\mu\text{m}$	$1.0\mu\text{m}$	$\pm 1.2\mu\text{m}$	42
$5 < R \leq 1010\text{mm}$	<b>515-523</b>	10mm (straight)	0.001mm	$\pm 3.5\mu\text{m}$	$2.5\mu\text{m}$	$\pm 1.5\mu\text{m}$	63.5

#### Inch

Range (R)	Order No.	Block step	Graduation	Block Pitch Accuracy	Parallelism of Block	Micrometer Head Accuracy	Mass (kg)
$.2" < R \leq 18.2"$	<b>515-512</b>	.5" (straight)	.00001"	$\pm .00005"$	.00006"	$\pm .00004"$	42
$.2" < R \leq 24.2"$	<b>515-510</b>	.5" (straight)	.00001"	$\pm .0001"$	.00006"	$\pm .00004"$	50
$.2" < R \leq 40.2"$	<b>515-513</b>	.5" (straight)	.00001"	$\pm .00015"$	.00008"	$\pm .00006"$	63.5



### Technical Data

Graduation: 0.001mm or .00001"  
 Counter Resolution: .001" or 0.01mm  
 Character Height: .16" / 4mm  
 Block arrangement: Straight arrangement

#### Micrometer Head

Travel stroke: 1" or 20mm  
 Pitch: .025"/rev or 0.5mm/rev  
 Hysteresis: .00004" / 1.2μm up to 24.2" / 610mm  
 .00006" / 1.5μm for 40.2" / 1010mm

Block pitch accuracy:  $\pm 1.5\mu\text{m}$  ( $0 < R \leq 310\text{mm}$ )  
 $\pm 2.5\mu\text{m}$  ( $310 < R \leq 610\text{mm}$ )  
 $\pm 3.5\mu\text{m}$  ( $610 < R \leq 1010\text{mm}$ )

Parallelism of blocks:  $1.0\mu\text{m}$  ( $0 < R \leq 310\text{mm}$ )  
 $2.5\mu\text{m}$  ( $310 < R \leq 1010\text{mm}$ )

Provided with inspection certificate.

### Optional Accessories

- 900574\***: Supporting base for vertical operation  
 Mass: 3kg  
 (\*supplied as a standard for **515-523** and **515-513**)
- 515-112**: Auxiliary block kit for bore gage (mm)  
**515-119**: Auxiliary block kit for bore gage (inch)

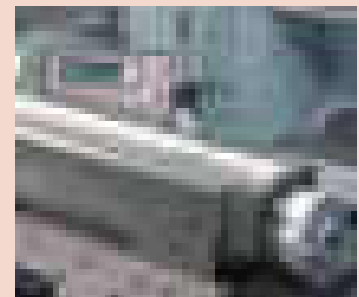

Using in horizontal orientation

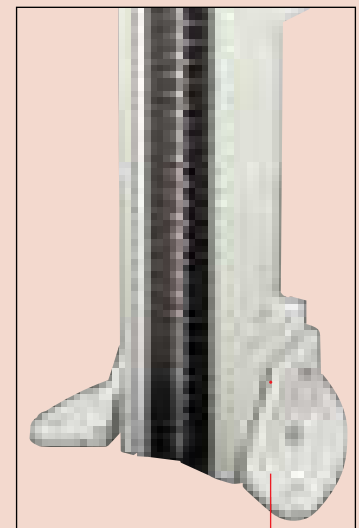

Supporting base



# High-Accuracy Check Master HMC-H

## SERIES 515

### Technical Data

Measuring range (R): Refer to the list of specifications.  
 Block pitch accuracy:  $\pm 1.2\mu\text{m}$  ( $0 < R \leq 310\text{mm}$ )  
 $\pm 1.8\mu\text{m}$  ( $310 < R \leq 610\text{mm}$ )  
 $\pm 2.5\mu\text{m}$  ( $610 < R \leq 1010\text{mm}$ )  
 $\pm 4.0\mu\text{m}$  ( $1010 < R \leq 1510\text{mm}$ )  
 Parallelism of blocks:  $1.0\mu\text{m}$  ( $0 < R \leq 450\text{mm}$ )  
 $1.5\mu\text{m}$  ( $450 < R \leq 1010\text{mm}$ )  
 $2.0\mu\text{m}$  ( $1010 < R \leq 1510\text{mm}$ )  
 Provided with inspection certificate.

### FEATURES

- Designed to check the accuracy of table movements of machine tools and calibrate CMMs. Permanently wrung stack of gage blocks is housed in a rigid frame.
- Can be used in either vertical and horizontal orientation.
- Fitted wooden case supplied.

### Specifications for Ceramic Check Master:

- Each measuring block is made of zirconia-based ceramic that requires no anti-corrosion treatment for measuring faces.
- Free from deterioration and dimensional changes over time.

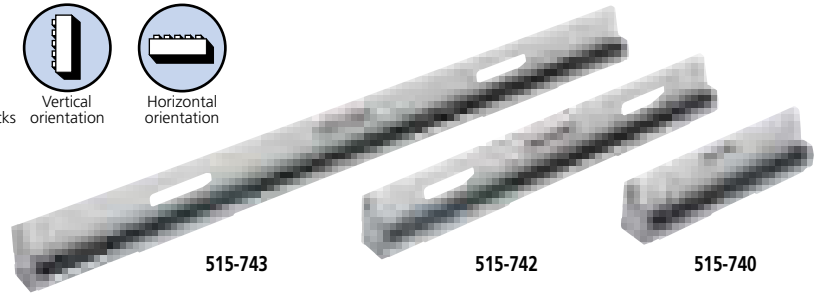
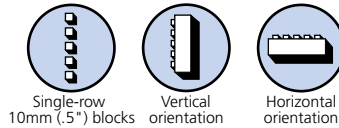

### SPECIFICATIONS

#### Metric

Range (R)	Order No.		Pitch		Accuracy of block pitch for the range shown below as measured from the bottom block				Length	Parallelism	Mass (kg)
	Steel	Ceramic	P	P	up to 300mm	300-600mm	600-1000mm	1000-1500mm			
300mm	515-740	515-760	20mm	10mm	$\pm 1.2\mu\text{m}$	—	—	—	331mm	$1\mu\text{m}$	3.6
450mm	515-741	515-761	20mm	10mm	$\pm 1.2\mu\text{m}$	$\pm 1.8\mu\text{m}$	—	—	482mm	$1\mu\text{m}$	5.4
600mm	515-742	515-762	20mm	10mm	$\pm 1.2\mu\text{m}$	$\pm 1.8\mu\text{m}$	—	—	631mm	$1.5\mu\text{m}$	7.2
1000mm	515-743	515-763	20mm	10mm	$\pm 1.2\mu\text{m}$	$\pm 1.8\mu\text{m}$	$\pm 2.5\mu\text{m}$	—	1037mm	$1.5\mu\text{m}$	12.0
1500mm	515-744	515-764	20mm	10mm	$\pm 1.2\mu\text{m}$	$\pm 1.8\mu\text{m}$	$\pm 2.5\mu\text{m}$	$\pm 4.0\mu\text{m}$	1546mm	$2\mu\text{m}$	18.0

#### Inch

Range (R)	Order No.		Pitch		Accuracy of block pitch for the range shown below as measured from the bottom block				Length	Parallelism	Mass (kg)
	Steel	Ceramic	P	P	up to 12"	12-24"	24-40"	40-60"			
12"	515-730	515-750	1"	.5"	$\pm 50\mu\text{in}$	—	—	—	13.0"	$40\mu\text{in}$	3.4
18"	515-731	515-751	1"	.5"	$\pm 50\mu\text{in}$	$\pm 70\mu\text{in}$	—	—	19.0"	$40\mu\text{in}$	5.2
24"	515-732	515-752	1"	.5"	$\pm 50\mu\text{in}$	$\pm 70\mu\text{in}$	—	—	25.0"	$60\mu\text{in}$	6.9
40"	515-733	515-753	1"	.5"	$\pm 50\mu\text{in}$	$\pm 70\mu\text{in}$	$\pm 100\mu\text{in}$	—	41.0"	$60\mu\text{in}$	11.5
60"	515-734	515-754	1"	.5"	$\pm 50\mu\text{in}$	$\pm 70\mu\text{in}$	$\pm 100\mu\text{in}$	$\pm 158\mu\text{in}$	61.5"	$80\mu\text{in}$	17.3

### Optional Accessories

**601167:** Supporting base for vertical operation

Dimensions: 14.2"(W) x 8.7"(D) x 8.3"(H)  
 360mm(W) x 220mm(D) x 210mm(H)

Mass: 3kg

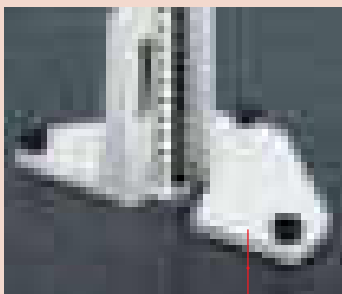

Supporting base

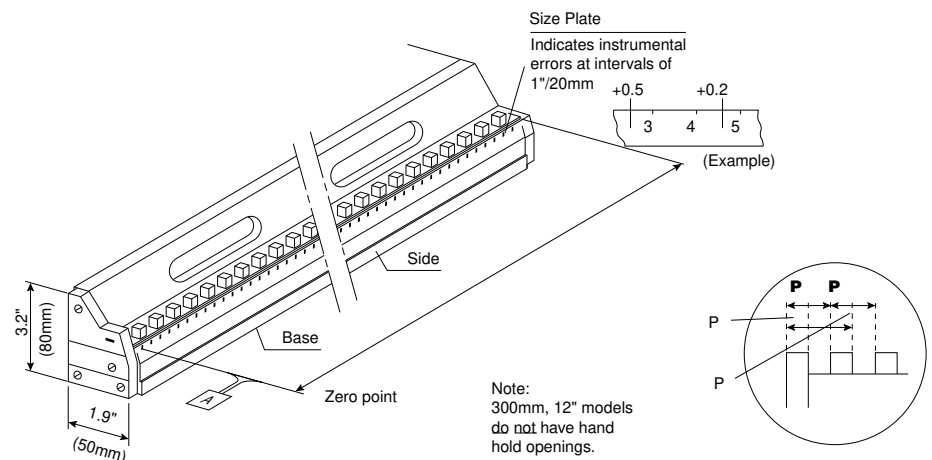

# CERA Straight Master SM-C

## SERIES 311 — Straightness Measuring Instrument

### FEATURES

CERA Straight master is a master gage used for the straightness inspection of each axis movement such as a CMM, machine tool, semiconductor-related equipment and form measuring machine.

- Made from Alumina-ceramic
- 50mm/2" pitch gradation scales
- Precision-lapped measuring surface
- Double-faced type is lapping the double face, which can be used for straightness in horizontal and vertical as a reference square.
- Lightweight
- Supplied with fitted wooden case.

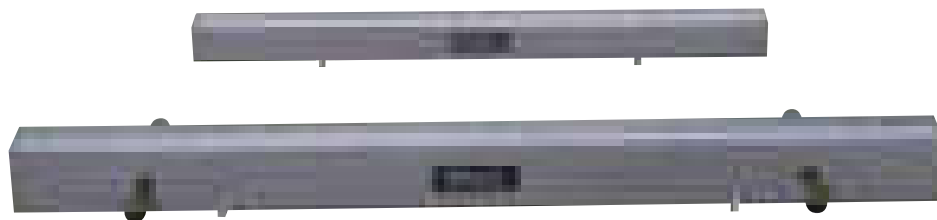

### SPECIFICATIONS

Metric		Inch		High-accuracy model		
Nominal length	Order No.*	Nominal length	Order No.*	Straightness	Size (L x H x W)	Mass
400mm	311-302-33	16"	311-322-33	0.3μm	440 x 35 x 50mm	1.8kg
700mm	311-305-33	28"	311-325-33	0.5μm	740 x 35 x 50mm	3kg
1000mm	311-307-33	40"	311-327-33	1.0μm	1040 x 45 x 80mm	8kg
1300mm	311-309-33	52"	311-329-33	1.5μm	1340 x 45 x 80mm	10kg

Metric		Inch		Ultra-high accuracy model		
Nominal length	Order No.*	Nominal length	Order No.*	Straightness	Size (L x H x W)	Mass
400mm	311-332-33	16"	311-342-33	0.2μm	440 x 35 x 50mm	1.8kg
700mm	311-335-33	28"	311-345-33	0.4μm	740 x 35 x 50mm	3kg
1000mm	311-337-33	40"	311-347-33	0.5μm	1040 x 45 x 80mm	8kg
1300mm	311-339-33	52"	311-349-33	0.7μm	1340 x 45 x 80mm	10kg

Double-faced type



### SPECIFICATIONS

Metric		Inch		Double-faced model		
Nominal length	Order No.*	Nominal length	Order No.*	Straightness	Size (L x H x W)	Mass
400mm	311-352-33	16"	311-362-33	0.3μm	440 x 45 x 80mm	3.2kg
700mm	311-355-33	28"	311-365-33	0.5μm	740 x 45 x 80mm	5.5kg
1000mm	311-357-33	40"	311-367-33	1.0μm	1040 x 45 x 80mm	8kg
1300mm	311-359-33	52"	311-369-33	1.5μm	1340 x 45 x 80mm	10kg

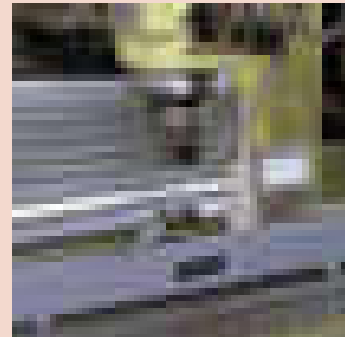

### Technical Data

Provided with inspection certificate.

### Cross section

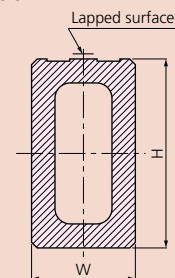

### Double-faced type

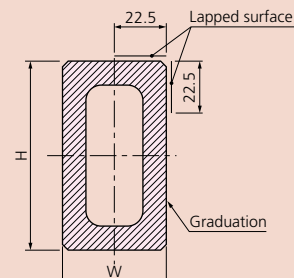



# Square Master

## SERIES 311 — Squareness / Straightness Measuring Instrument

### Technical Data

Squareness: Refer to the list of specifications  
 Straightness: Refer to the list of specifications  
 Dial test indicator provided  
 Range: 0.2mm  
 Graduation: 0.002mm  
 Accuracy: 3µm

### Optional Accessory

—: Riser blocks (see page E-27.)\*  
**900571**: Adjustable holder  
**900551**: Extension holder  
**900565**: Feeler\*\*

\*Not available for 450mm model.  
 \*\*Adapter (**902803**) is required for metric model.

### Adjustable holder

No.900571

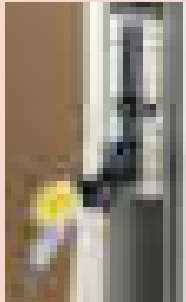
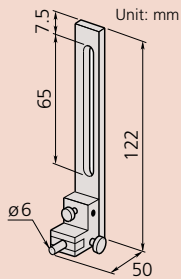

### Extension holder

No.900551

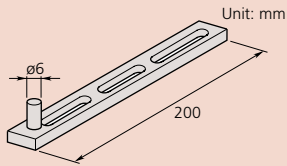

### Feeler

No.900565

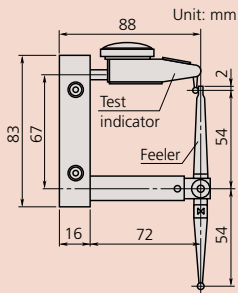

### FEATURES

- Squareness (perpendicularity) and straightness measurements can be performed accurately and efficiently by moving a lever.
- With a dial test indicator for reading displacements.
- Its own squareness is adjustable for high-accuracy measurement.



311-215



311-225



311-245

### SPECIFICATIONS

Metric				
Vertical travel	Order No.	Squareness	Straightness	Mass (kg)
150mm	<b>311-215</b>	3µm	2µm	13.7
250mm	<b>311-225</b>	6µm	2.5µm	16.2
450mm	<b>311-245</b>	9µm	3.5µm	24

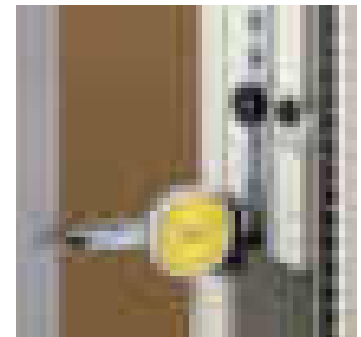
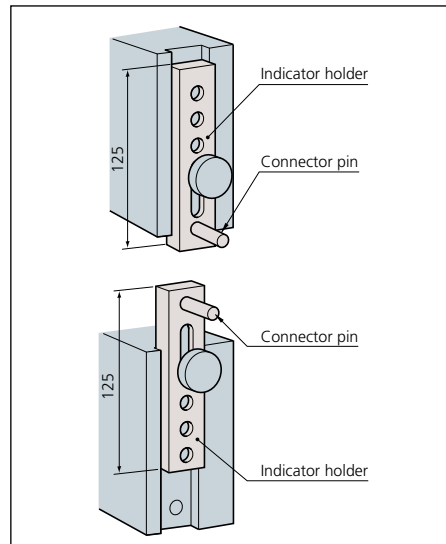

# Standard Scales

**SERIES 182 — Made of Low-Expansion Glass**

## FEATURES

- High-precision glass scales manufactured under Mitutoyo's leading-edge Linear Scale production technology.
- High accuracy is guaranteed to be used as a standard for calibrating graduated scales.

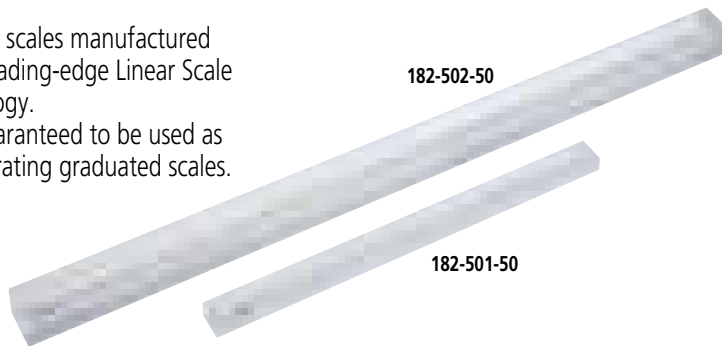

## DIMENSIONS

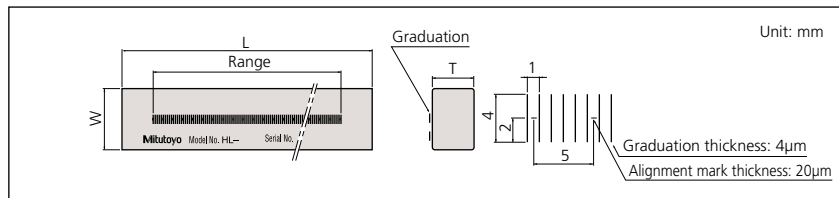

## Technical Data

Accuracy (at 20°C):  $(0.5+L/1000)\mu\text{m}$ ,  
L = Measured length (mm)  
Glass material: Low expansion glass  
Thermal expansion coefficient:  $8 \times 10^{-6}/\text{K}$   
Graduation: 1mm  
Graduation thickness: 4µm  
Mass: 0.75kg (250mm), 1.8kg (500mm)

## SPECIFICATIONS

### Metric

Range	Order No.	L	W	T
250mm	<b>182-501-50</b>	280mm	20mm	10mm
250mm	<b>182-501-60*</b>	280mm	20mm	10mm
500mm	<b>182-502-50</b>	530mm	30mm	20mm
500mm	<b>182-502-60*</b>	530mm	30mm	20mm

\*with English JCSS certificate.

# Working Standard Scales

**SERIES 182**

## FEATURES

- High-precision glass scales manufactured under Mitutoyo's leading-edge linear scale production technology.
- Ideal for checking magnification accuracy of profile projectors and microscopes, and the table feeding accuracy of measuring equipment.

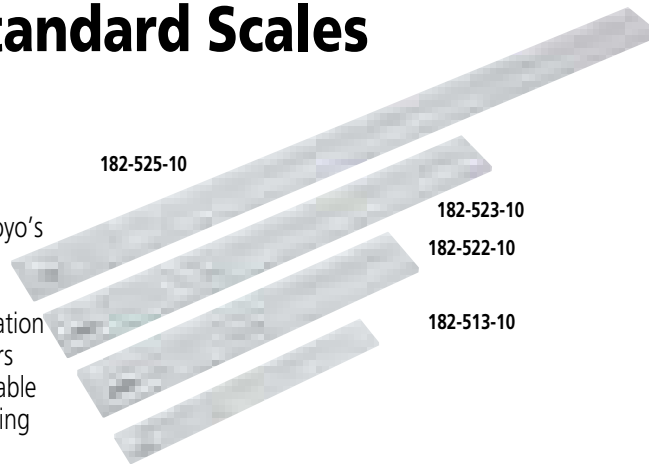

## DIMENSIONS

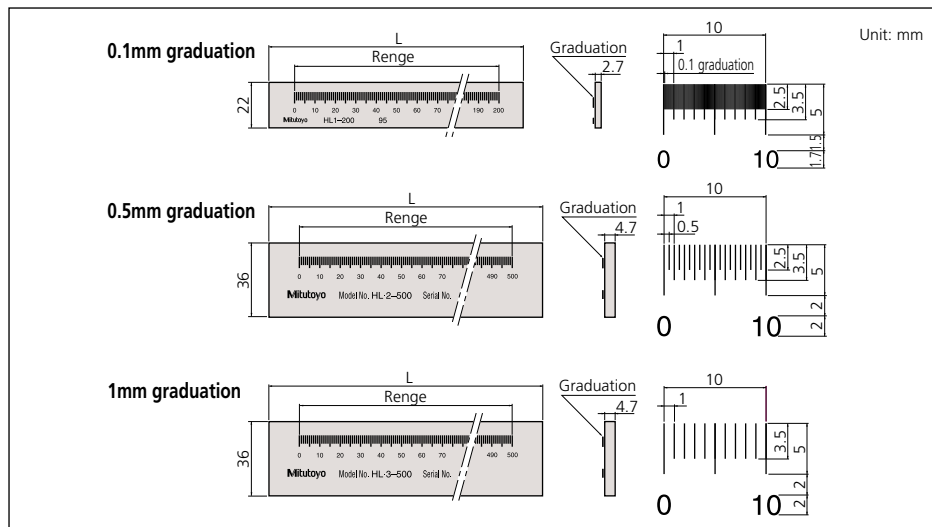

## Technical Data

Accuracy (at 20°C):  $(1.5+2L/1000)\mu\text{m}$ ,  
L = Measured length (mm)  
Glass material: Sodium glass  
Thermal expansion coefficient:  $8.5 \times 10^{-6}/\text{K}$   
Graduation: 0.1mm (thickness: 20µm)  
0.5mm (thickness: 50µm)  
1mm (thickness: 100µm)

## SPECIFICATIONS

### Metric

Range	Order No.	Graduation	L	Mass
50mm	<b>182-511-10</b>	0.1mm	75mm	0.23kg
100mm	<b>182-512-10</b>	0.1mm	125mm	0.24kg
150mm	<b>182-513-10</b>	0.1mm	175mm	0.35kg
200mm	<b>182-514-10</b>	0.1mm	225mm	0.36kg
100mm	<b>182-521-10</b>	0.5mm	130mm	0.27kg
200mm	<b>182-522-10</b>	0.5mm	230mm	0.32kg
300mm	<b>182-523-10</b>	0.5mm	330mm	0.57kg
400mm	<b>182-524-10</b>	0.5mm	430mm	0.71kg
500mm	<b>182-525-10</b>	0.5mm	530mm	0.86kg
250mm	<b>182-531-10</b>	1mm	280mm	0.55kg
500mm	<b>182-532-10</b>	1mm	530mm	0.86kg
750mm	<b>182-533-10</b>	1mm	780mm	1.22kg
1000mm	<b>182-534-10</b>	1mm	1030mm	1.54kg

# High-Precision Square

## SERIES 311

### FEATURES

The High-Precision Square gage is used for inspecting the travel straightness and axial perpendicularity of moving elements on equipment, such as machine tools, CMMs, form measuring machines and semiconductor-related equipment.

- Four precision-lapped reference surfaces.
- Better than 1 $\mu$ m/300mm straightness and perpendicularity.

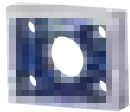

311-111

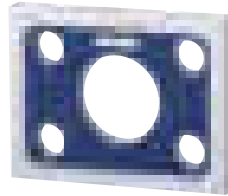

311-112

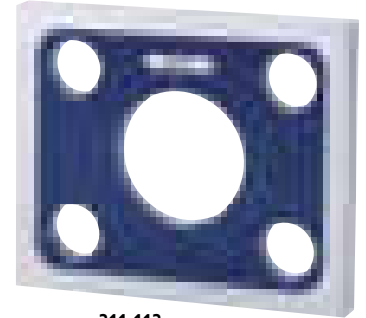

311-113

### SPECIFICATIONS

#### Metric

Order No.	Dimension (W x L x T)	Mass
311-111	90 x 110 x 25mm	1.5kg
311-112	160 x 210 x 25mm	5.0kg
311-113	260 x 310 x 30mm	14.0kg

\* 311-113 is supplied with a removable handle.

# Spring Dividers and Calipers

## SERIES 950

### FEATURES

- Spring Divider — Fully hardened and tempered joints, spring, washers and divider points.
- Outside Spring Caliper — Contact ends fully rounded to give accurate dimensions.
- Inside Spring Caliper — Ends fully rounded to give accurate contact with a workpiece.

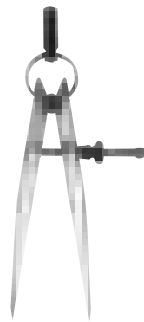

Spring divider

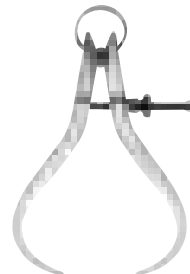

Outside spring calipers

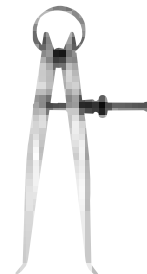

Inside spring calipers

### SPECIFICATIONS

Range	Order No.		
	Spring divider	Outside spring calipers	Inside spring calipers
6" (150mm)	950-212	950-222	950-232
8" (200mm)	950-213	950-223	950-233

# Steel Rules

## SERIES 182

### FEATURES

- Clear graduations on satin-chrome finish.
- Stainless tempered.



182-125

### SPECIFICATIONS

#### Wide Rigid Rules (thickness 3/64")

Order No.	Size	Graduations				Width	Accuracy (Length)
182-101	6"(4R)	1/8	1/16	1/32	1/64th	3/4"	+ .004" / - .0035" (+0.1mm / -0.09mm)
182-102	6"(16R)	1/32	1/64	1/50	1/100th	3/4"	
182-103	6"(5R)	1/32	1/64	1/10	1/100th	3/4"	
182-104	6"(3R)	1/32	1/64	1/10	1/50th	3/4"	
182-105	6" x 150mm	1/32	1/64	1mm	0.5mm	3/4"	
182-106	6" x 150mm	1/50	1/100	1mm	0.5mm	3/4"	
182-107	6" x 150mm	1/10	1/100	1mm	0.5mm	3/4"	
182-108	6" x 150mm	1/10	1/50	1mm	0.5mm	3/4"	
182-111	150mm	1mm	0.5mm	1mm	0.5mm	19mm	+ .005" / - .0035" (+0.13mm / -0.09mm)
182-121	12"(4R)	1/8	1/16	1/32	1/64th	1"	
182-122	12"(16R)	1/32	1/64	1/50	1/100th	1"	
182-123	12"(5R)	1/32	1/64	1/10	1/100th	1"	
182-124	12"(3R)	1/32	1/64	1/10	1/50th	1"	
182-125	12" x 300mm	1/32	1/64	1mm	0.5mm	1"	
182-126	12" x 300mm	1/50	1/100	1mm	0.5mm	1"	
182-131	300mm	1mm	0.5mm	1mm	0.5mm	25mm	
182-241	18"(4R)	1/8	1/16	1/32	1/64	13/16"	+ .006" / - .035" (+0.15mm / -0.09mm)
182-142	18"(16R)	1/32	1/64	1/50	1/100th	13/16"	
182-143	18"(5R)	1/32	1/64	1/10	1/100th	13/16"	
182-145	18" x 450mm	1/32	1/64	1mm	0.5mm	13/16"	
182-151	450mm	1mm	0.5mm	1mm	0.5mm	30mm	+ .007" / - .0035" (+0.18mm / -0.09mm)
182-161	24"(4R)	1/8	1/16	1/32	1/64	13/16"	
182-162	24"(16R)	1/32	1/64	1/50	1/100th	13/16"	
182-163	24"(5R)	1/32	1/64	1/10	1/100th	13/16"	
182-165	24" x 600mm	1/32	1/64	1mm	0.5mm	13/16"	
182-171	600mm	1mm	0.5mm	1mm	0.5mm	30mm	

# Steel Rules

## SERIES 182

### FEATURES

- Clear graduations on satin-chrome finish.
- Stainless tempered.



182-265



182-223

### SPECIFICATIONS

#### Full-Flexible Rules (thickness 1/64")

Order No.	Size	Graduations				Width	Accuracy (Length)
182-201	6"(4R)	1/8	1/16	1/32	1/64th	1/2"	+0.004" / -0.0035" (+0.1mm / -0.09mm)
182-202	6"(16R)	1/32	1/64	1/50	1/100th	1/2"	
182-203	6"(5R)	1/32	1/64	1/10	1/100th	1/2"	
182-204	6"(3R)	1/32	1/64	1/10	1/50th	1/2"	
182-205	6" x 150mm	1/32	1/64	1mm	0.5mm	1/2"	
182-206	6" x 150mm	1/50	1/100	1mm	0.5mm	1/2"	
182-207	6" x 150mm	1/10	1/100	1mm	0.5mm	1/2"	
182-208	6" x 150mm	1/10	1/50	1mm	0.5mm	1/2"	
182-211	150mm	1mm	0.5mm	1mm	0.5mm	12mm	+0.005" / -0.0035" (+0.13mm / -0.09mm)
182-221	12"(4R)	1/8	1/16	1/32	1/64th	1/2"	
182-222	12"(16R)	1/32	1/64	1/50	1/100th	1/2"	
182-223	12"(5R)	1/32	1/64	1/10	1/100th	1/2"	
182-224	12"(3R)	1/32	1/64	1/10	1/50th	1/2"	
182-225	12" x 300mm	1/32	1/64	1mm	0.5mm	1/2"	
182-226	12" x 300mm	1/50	1/100	1mm	0.5mm	1/2"	+0.006" / -0.0035" (+0.15mm / -0.09mm)
182-231	300mm	1mm	0.5mm	1mm	0.5mm	12mm	
182-141	18"(4R)	1/8	1/16	1/32	1/64	3/4"	
182-242	18"(16R)	1/32	1/64	1/50	1/100th	3/4"	
182-243	18"(5R)	1/32	1/64	1/10	1/100th	3/4"	
182-245	18" x 450mm	1/32	1/64	1mm	0.5mm	3/4"	+0.007" / -0.0035" (+0.18mm / -0.09mm)
182-251	450mm	1mm	0.5mm	1mm	0.5mm	18mm	
182-261	24"(4R)	1/8	1/16	1/32	1/64	3/4"	
182-262	24"(16R)	1/32	1/64	1/50	1/100th	3/4"	+0.007" / -0.0035" (+0.18mm / -0.09mm)
182-263	24"(5R)	1/32	1/64	1/10	1/100th	3/4"	
182-264	24"(3R)	1/32	1/64	1/10	1/50th	3/4"	
182-265	24" x 600mm	1/32	1/64	1mm	0.5mm	3/4"	
182-271	600mm	1mm	0.5mm	1mm	0.5mm	18mm	

## Semi-Flexible Rules

### SERIES 182

### FEATURES

- Engraved on frontside only

### SPECIFICATIONS

Inch/Metric		Graduations				Width	Accuracy (Length)	
182-301	4" x 100mm	1/2mm	1mm	1/32	1/64	1/16th	5/8"	+0.004" / -0.0035" (+0.1mm / -0.09mm)
182-302	6" x 150mm	1/2mm	1mm	1/32	1/64	1/16th	5/8"	
182-303	8" x 200mm	1/2mm	1mm	1/32	1/64	1/16th	5/8"	+0.005" / -0.0035"
182-305	12" x 300mm	1/2mm	1mm	1/32	1/64	1/16th	5/8"	+0.013mm / -0.09mm)
182-307	20" x 500mm	1/2mm	1mm	1/32	1/64	1/16th	5/8"	+0.007" / -0.0035" (+0.18mm / -0.09mm)
182-309	40" x 1000mm	1/2mm	1mm	1/32	1/64	1/16th	5/8"	+0.008" / -0.004" (+0.2mm / -0.1mm)

# Thickness/Feeler Gages

**SERIES 950, 184**

## FEATURES

- Each leaf is marked with its thickness.
- Each leaf is detachable.

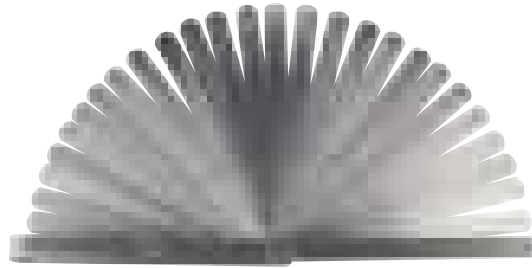

184-303S

## SPECIFICATIONS

**Inch**

Range	Order No.	Type of Blade	Blade Length	Composition of leaves
.0015" - .035" (26 leaves)	<b>950-251</b>	Straight 1/2" width	3"	.002 thru .018" by .001" step plus .0015, .020, .022, .024, .025, .028, .030, .032"
.0015" - .025" (26 leaves)	<b>950-252</b>	Tapered 1/4" width at tip	3"	.002 thru .025 by .001" step plus .0015, .0025"
.0015" - .200" (15 leaves)	<b>950-254</b>	Straight 1/2" width	3"	.0015, .002, .003, .004, .006, .008, .010, .012, .015, .020, .030, .040, .075, .100, .200"
.0015" - .200" (13 leaves)	<b>950-255</b>	Straight 1/2" width	4.5"	.0015, .002, .003, .004, .006, .008, .010, .020, .030, .040, .075, .100, .200"
.0015" - .015" (9 leaves)	<b>950-256</b>	Straight 1/2" width	6"	.0015, .002, .003, .004, .006, .008, .010, .012, .015"

**Metric**

Range	Order No.	Type of Blade	Blade Length	Composition of leaves
0.05 - 1mm	<b>184-313S</b>	Straight 13mm width	100mm	28 leaves: 0.05 - 0.15mm by 0.01mm, 0.2 - 1mm by 0.05mm
	<b>184-303S</b>		150mm	28 leaves: 0.05 - 0.15mm by 0.01mm, 0.2 - 1mm by 0.05mm
0.05 - 1mm	<b>184-304S</b>	Straight 13mm width	150mm	20 leaves: 0.05 - 1mm by 0.05mm
	<b>184-305S</b>		100mm	13 leaves: 0.05 - 0.3mm by 0.05mm, 0.4 - 1mm by 0.1mm
0.05 - 1mm	<b>184-301S</b>	Straight 13mm width	100mm	13 leaves: 0.05 - 0.3mm by 0.05mm, 0.4 - 1mm by 0.1mm
	<b>184-301S</b>		150mm	13 leaves: 0.05 - 0.3mm by 0.05mm, 0.4 - 1mm by 0.1mm
0.05 - 0.8mm	<b>184-306S</b>	Straight 13mm width	100mm	10 leaves: 0.05 - 0.2mm by 0.05mm, 0.3 - 0.8mm by 0.1mm
	<b>184-308S</b>		150mm	10 leaves: 0.05 - 0.2mm by 0.05mm, 0.3 - 0.8mm by 0.1mm
0.03 - 0.5mm	<b>184-307S</b>	Straight 13mm width	100mm	13 leaves: 0.03 - 0.1mm by 0.01mm, 0.2 - 0.5mm by 0.1mm, 0.15mm
	<b>184-302S</b>		150mm	13 leaves: 0.03 - 0.1mm by 0.01mm, 0.2 - 0.5mm by 0.1mm, 0.15mm

## Technical Data

Accuracy of Leaves Thickness

**Nominal Thickness**

Metric

0.01mm to less than 0.06mm:

0.06mm to less than 0.10mm:

0.10mm to less than 0.35mm:

0.35mm to less than 0.65mm:

0.65mm to less than 3.0mm:

Inch

.0015 to less than .007":

.007 to less than .015":

.015 to less than .025":

.026 to less than .030":

.031 to less than .040":

.041 to less than .075":

.076 to less than .100":

.101 to less than .200":

.200" and over:

**Tolerance**

±0.003mm

±0.004mm

±0.005mm

±0.008mm

±0.01mm

±.0002"

±.0003"

±.0004"

±.00045"

±.0005"

±.00055"

±.0006"

±.00065"

±.00075"

# Precision Levels

**SERIES 960**

## FEATURES

- High-precision longitudinal and transverse vials make it possible to check or level surfaces.
- Supplied in wooden box.

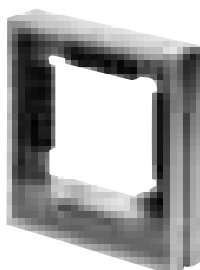

960-703

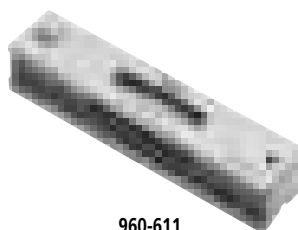

960-611

## SPECIFICATIONS

**Metric**

Order No.	Sensitivity	Accuracy	Dimensions (W x D x H)
<b>960-703</b>	0.02mm/m	±0.006mm	200 x 44 x 200mm

**Inch**

Order No.	Sensitivity	Accuracy	Dimensions		
			W	D	H
<b>960-611</b>	.0012"/12"	±.0006"	7.87"	1.73"	1.50"
<b>960-612</b>	.0006"/12"	±.0003"	7.87"	1.73"	1.50"
<b>960-613</b>	.00024"/12"	±.00017"	7.87"	1.73"	1.50"

## Wooden Box Part No.

Part No.	Spare
073112	<b>960-703</b>
063413	<b>960-611</b>
	<b>960-611</b>
	<b>960-613</b>

# Digital Universal Protractor

## SERIES 187

### Technical Data

Range:	-360° to +360°
Tolerance:	±2' (±0.03°)
Repeatability:	1'
Resolution:	1' (0.01°)
Battery:	Lithium Battery
Battery life:	2,000 hours

### Function

Presetting

### Standard Accessories

12" Blade (Code No. 187-103)  
 Battery (CR2032) (Part No. 05SAA217)  
 Clamp box for Inch Height Gage (Part No. 950749)  
 Plastic Case

### Optional Accessories

<b>187-104</b>	6" blade
<b>187-105</b>	Acute angle attachment
<b>950750</b>	Clamp box for Metric Height Gage
<b>905338</b>	Connecting cable (40" / 1m)
<b>905409</b>	Connecting cable (80" / 2m)

### FEATURES

- Data output function make it easy to see the statistical data.
- Can be attached to height gages, gage holder (950750, metric)
- Setting preset value.
- Removable blade.

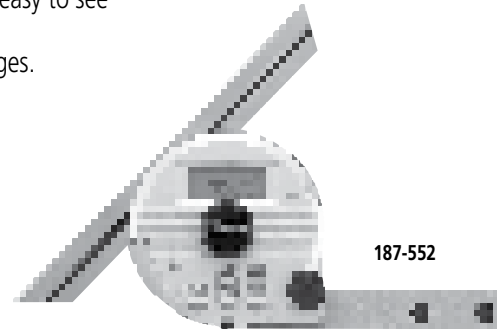

### SPECIFICATIONS

Code No.	187-552
Model	BP-D300E
Blade	12" (187-103)
Display	LCD - 5 digit, (-) sign, character height 6.5mm
Measuring range	-360° ~ +360°
Resolution	1' (0.01°)
Accuracy	± 2' (±0.03°)
Repeatability	1' (0.01°)
Mass	1.45 lbs (659g)
Dust / Water protection level	IP40
Function	Zero, Direction select, Data output / Data hold, Preset, Switchable Seagesimal or Decimal Notation
Max. response speed	3 rps
Battery	Lithium battery (CR2032) 1 pc. (Part No. 05SAA217)
Battery life	2,000 hours
Alarm	Battery voltage low, Over speed error (Err)
Temperature	Operation temperature: 0 to 40°C Storage temperature: -10 to 60°C

### DIMENSIONS

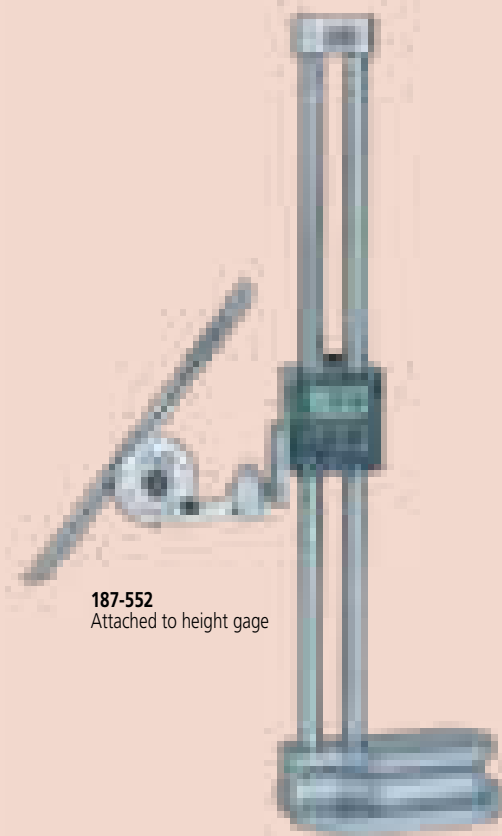

**187-552**  
Attached to height gage

# Universal Bevel Protractor

## SERIES 187

### FEATURES

- High-precision angle gage for accurate angle measurement of machines, molds, and jigs.
- Can be attached to height gages.

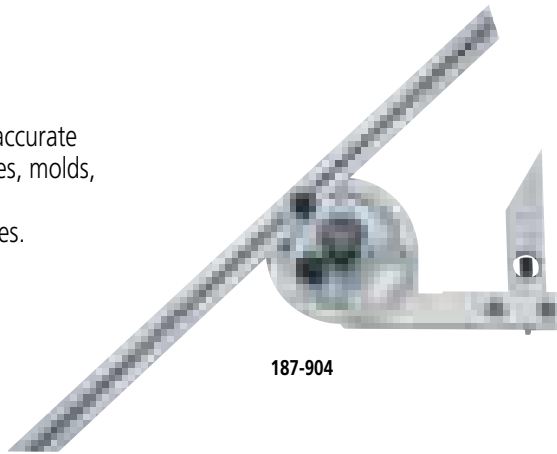

187-904

### SPECIFICATIONS

#### Universal Bevel Protractors

Graduation			
Order No.	Dial	Vernier	Remarks
187-904	1°	5 min	with 6" blade (187-104) and Clamp box for Inch Height Gages (950749)
187-906	1°	5min	with 12" blade (187-103) and Clamp box for Inch Height Gages (950749)

#### Universal Bevel Protractor Accessories and Parts

Order No.	Remarks
187-103	12" Blade
187-104	6" Blade
187-105	Acute angle attachment
950749	Clamp box for Inch Height Gages
950750	Clamp box for Metric Height Gages

### DIMENSIONS



### Technical Data

Graduation:	5min. (0° - 90° - 0°)
Accuracy	
Vernier	±5'
Straightness	[.00016" + (.00005xL/2)]"
Parallelism	[.00016" + (.00005xL/2)]"
L = Length in inch	
Diameter:	2.56" / 70mm

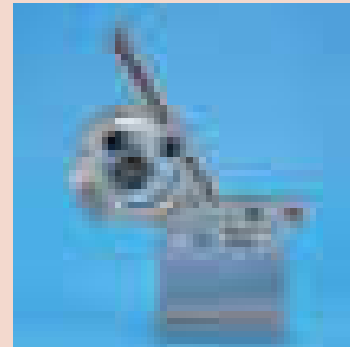
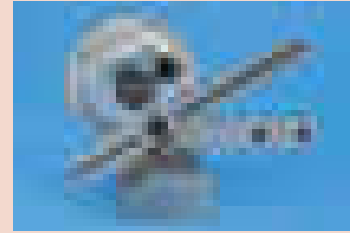

# Bevel Protractor

## SERIES 187

### FEATURES

- Consists of three sheets of stainless steel, the middle one of which is made for angle measurements.

### SPECIFICATIONS

Order No.	Graduation	Remarks
187-201	1° / 5 min	Center black knob locks the blade position Protractor Graduation: 0°-90° , 90°-0°

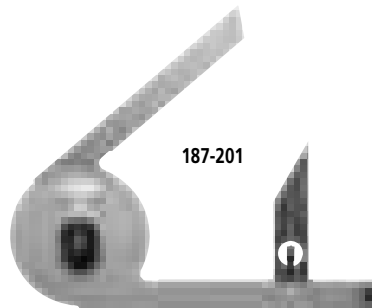

187-201

### Technical Data

Graduation:	5 min. (0° - 90° - 0°)
Blade edge angle:	30° and 60°
Diameter:	2.56" / 70mm



# Radius Gages

## SERIES 186

### FEATURES

- Radius size is stamped on each gage.
- Both concave and convex radius gages become a pair.
- With a locking clamp.

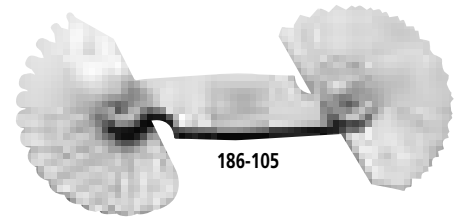

### Technical Data

Accuracy: ±.002"

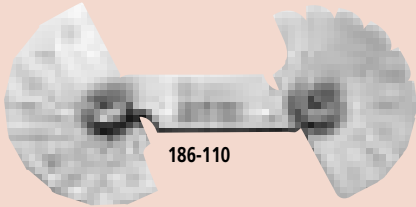

### SPECIFICATIONS

#### Metric

Range	Order No.	Composition of leaves	Remarks
0.4 - 6mm	<b>186-110</b>	18 leaves: 0.4, 0.8, 1, 1.2, 1.5, 1.6mm, 1.75 - 3mm by 0.25mm, 3.5 - 6mm by 0.5mm	90° arc
1 - 7mm	<b>186-105</b>	34 pairs: 1 - 3mm by 0.25mm 3.5 - 7mm by 0.5mm	180° arc
7.5 - 15mm	<b>186-106</b>	32 pairs: 7.5 - 15mm by 0.5mm	180° arc
15.5 - 25mm	<b>186-107</b>	15 pairs: 15.5 - 20mm by 0.5mm, 21 - 25mm by 1mm	180° arc

#### Inch

Range	Order No.	Composition of leaves	Remarks
1/32" - 17/64"	<b>186-103</b>	16 leaves: 1/32" - 17/64" by 64ths	90° arc
1/32" - 1/4"	<b>186-101</b>	15 pairs: 1/32" - 1/4" by 64ths	180° arc
17/64" - 1/2"	<b>186-102</b>	16 pairs: 17/64" - 1/2" by 64ths	180° arc
9/32" - 33/64"	<b>186-104</b>	16 leaves: 9/32" - 33/64" by 64ths	90° arc

# Pitch Gages

## SERIES 188, 950

### FEATURES

- Thread pitch size is stamped on each gage.
- Metric, Unified, and Whitworth screw pitch gages.

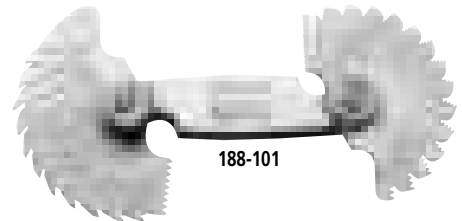

### Technical Data

TPI	Metric	Accuracy	
		Pitch (mm)	Angular (minutes)
4-6	6.35-4.23	±0.05	±35
7-12	3.63-2.12	±0.05	±40
13-25	1.95-1.02	±0.05	±45
26-48	0.98-0.53	±0.05	±50
60	0.42	±0.05	±60

### SPECIFICATIONS

#### Metric Screw Pitch Gages (60°)

Range	Order No.	Composition of leaves
0.25 - 2.5mm	<b>188-153</b>	28 leaves: 0.25, 0.30, 0.35, 0.40, 0.45, 0.50, 0.55, 0.60, 0.65, 0.70, 0.75, 0.80, 0.85, 0.90, 1.00, 1.10, 1.20, 1.25, 1.30, 1.40, 1.50, 1.60, 1.70, 1.75, 1.80, 1.90, 2.00, 2.50 mm
0.35 - 6mm	<b>188-130</b>	22 leaves: 0.35, 0.4, 0.45, 0.5, 0.6, 0.7, 0.75, 0.8, 1, 1.25, 1.5, 1.75, 2, 2.5, 3, 3.5, 4, 4.5, 5, 5.5, 6mm and 60° angle gage
0.4 - 7mm	<b>188-122</b>	21 leaves: 0.4, 0.5, 0.7, 0.75, 0.8, 0.9, 1, 1.25, 1.5, 1.75, 2, 2.5, 3, 3.5, 4, 4.5, 5, 5.5, 6, 6.5, 7mm
0.4 - 7mm	<b>188-121</b>	18 leaves: 0.4, 0.5, 0.75, 1, 1.25, 1.5, 1.75, 2, 2.5, 3, 3.5, 4, 4.5, 5, 5.5, 6, 6.5, 7mm

#### Unified Screw Pitch Gages (60°)

Range	Order No.	Composition of leaves
4 - 42 TPI	<b>188-111</b>	30 leaves: 4, 4 1/2, 5, 5 1/2, 6, 7, 8, 9, 10, 11, 11 1/2, 12, 13, 14, 15, 16, 18, 20, 22, 24, 26, 27, 28, 30, 32, 34, 36, 38, 40, 42 TPI
4 - 84 TPI	<b>950-253</b>	51 leaves: 4, 4 1/2, 5, 5 1/2, 6, 7, 8, 9, 10, 11, 11 1/2, 12, 13, 14, 15, 16, 18, 20, 22, 24, 26, 27, 28, 30, 32, 34, 36, 38, 40, 42, 44, 46, 48, 50, 52, 54, 56, 58, 60, 62, 64, 66, 68, 70, 72, 74, 76, 78, 80, 82, 84 TPI

Note: Metric and Unified Pitch Gage Set (**188-151**) is available. It consists of **188-122** (Metric) and **188-111** (Unified).

#### Metric and Unified Screw Pitch Gage Set (60°)

Range	Order No.	Composition of leaves
0.4 - 7mm / 4 - 42 TPI	<b>188-151</b>	51 leaves: Set of 188-122 and 188-111
0.5 - 6mm / 4 - 56 TPI	<b>188-152</b>	28 leaves: 4, 6, 8, 10, 11, 11-1/2, 12, 13, 16, 20, 28, 32, 40, 56 TPI 0.50, 0.75, 1.00, 1.25, 1.50, 1.75, 2.00, 2.50, 3.00, 3.50, 4.00, 4.50, 5.00, 6.00 mm

#### Whitworth Screw Pitch Gages (55°)

Range	Order No.	Composition of leaves
4 - 42 TPI	<b>188-101</b>	30 leaves: 4, 4 1/2, 5, 5 1/2, 6, 7, 8, 9, 10, 11, 11 1/2, 12, 13, 14, 15, 16, 18, 20, 22, 24, 26, 27, 28, 30, 32, 34, 36, 38, 40, 42 TPI
4 - 60 TPI	<b>188-102</b>	28 leaves: 4, 4 1/2, 5, 6, 7, 8, 9, 10, 11, 12, 13, 14, 16, 18, 19, 20, 22, 24, 25, 26, 28, 30, 32, 34, 36, 40, 48, 60 TPI

# Radius Gages-Sets

## SERIES 186

### FEATURES

Radius Gages are recommended for checking or laying out concave or convex radii. An individual gage for each dimension makes it possible to verify radius or fillet dimensions easier, faster and more accurately in machining, layout, inspection and pattern-making work. The measuring surfaces are precisely finished with smooth, accurate edges. Radius gages are available separately or in six sets. Each radius gage has five measuring locations, and it is identified with its particular radius dimensions. The gages have a satin or dull-chrome finish.

The holding cases, provided to protect the sets of radius gages, have indexed pockets to facilitate the selection of the proper size gage. A 4" long holder is furnished with Set No. 186-901 to make it possible to check radii in confined or hard-to-reach locations.

### SPECIFICATIONS

#### Metric

Order No.	No. of Leaves	Sizes	Remarks
186-902	26	0.5 - 13mm by 0.5mm	90° arc

#### Inch

Order No.	No. of Leaves	Sizes	Remarks
186-901	25	1/64"-17/64" by 64ths and 9/32"-1/2" by 32nds	Holder
186-903	17	1/64"-17/64" by 64ths	
186-904	8	9/32"-1/2" by 32nds	
186-905	8	9/16"-1" by 16ths	Holder
186-906	26	.010-.030" by .005" .040-.100" by .010" .120-.300" by .020" .350-.500" by .050"	Holder
186-907	10	.550-1" by .050"	

Replacement handle: **950753**

#### Decimal

Radius	Part No.	Radius	Part No.
.010"	211798	.240"	211816
.015"	211799	.260"	211817
.020"	211800	.280"	211818
.025"	211801	.300"	211819
.030"	211802	.350"	211820
.040"	211803	.400"	211821
.050"	211804	.450"	211822
.060"	211805	.500"	211823
.070"	211806	.550"	211824
.080"	211807	.600"	211825
.090"	211808	.650"	211826
.100"	211809	.700"	211827
.120"	211810	.750"	211828
.140"	211811	.800"	211829
.160"	211812	.850"	211830
.180"	211813	.900"	211831
.200"	211814	.950"	211832
.220"	211815	1.000"	211833

#### Fraction

Radius	Part No.	Radius	Part No.
1/64"	201441	5/16"	201459
1/32"	201442	11/32"	201460
3/64"	201443	3/8"	201461
1/16"	201444	13/32"	201462
5/64"	201445	7/16"	201463
3/32"	201446	15/32"	201464
7/64"	201447	1/2"	201465
1/8"	201448	9/16"	211790
9/64"	201449	5/8"	211791
5/32"	201450	11/16"	211792
11/64"	201451	3/4"	211793
3/16"	201452	13/16"	211794
13/64"	201453	7/8"	211795
7/32"	201454	15/16"	211796
15/64"	201455	1"	211797
1/4"	201456		
17/64"	201457		
9/32"	201458		

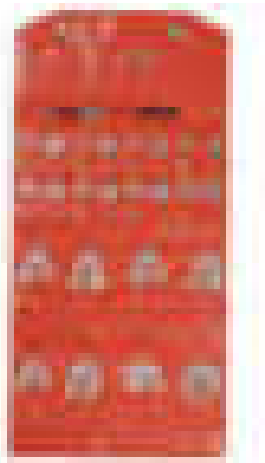

186-901

Accuracy:  $\pm .0016"$  / 0.04mm

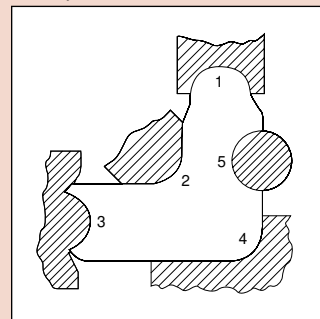

5 concave and convex radii per leaf.

# Digital Protractor

## SERIES 950

### FEATURES

These digital protractors present inclination values on an easy-to-read LCD. The measurements are generated by an electronic gravity sensor and processed by the latest low-power electronic circuit technology.

- Full 360° range (90° x 4).
- Machined aluminum frame.
- Alternate reference (zero).
- Reading hold.
- Simple calibration requiring no special fixtures.
- Display remains upright to view at all angles. (950-317, Pro 360 Model).
- RS232C output. (950-318 Pro 3600 Model).
- Supplied in fitted carrying case.



Front View



950-317 Back View



950-318 Back View

### Optional Accessories

**50AAA983A** RS-232C Output cable w/foot switch

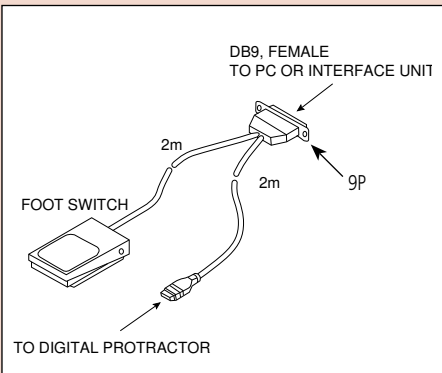

**50AAA983A** RS-232C Output cable w/foot switch 10P-9P

### SPECIFICATIONS

Order No.	950-317	950-318
Model	Pro 360	Pro 3600
Range	360° (90°x4)	360° (90°x4)
Resolution	0.1°	0.01° (0° to 9.99°) 0.1° (10° to 90°)
Accuracy	±0.1° Level ±10°, Plumb ±10° ±0.2° Maximum error	±0.05° (0° to 10°) ±0.1° (80° to 90°) ±0.2° (10° to 80°)
Repeatability	±0.1°	±0.05°
Cross Axis Error	Minimal	Minimal
Battery Life	500 Hrs. Standard 9-Volt Battery	500 Hrs. Standard 9-Volt Battery
Temperature Operation	-5°C to 50°C (23° to 122°F)	-5°C to 50°C (23° to 122°F)
Storage	-20°C to 65°C (-4°F to 149°F)	-20°C to 65°C (-4°F to 149°F)
Weight	289g (10.2oz.)	295g (10.4oz.)
Output	N/A	RS-232C Compatible
Standard Accessories	Plastic Case	Plastic Case

±Represents clockwise or counter-clockwise slope.

### DIMENSIONS

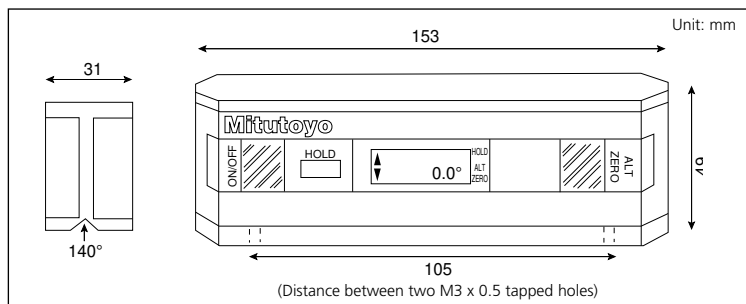

# Digital Hand Tachometers

## SERIES 982

### FEATURES

- New digital hand tachometers are compact and easy to handle.
- NIST certification is supplied with each digital hand tachometer.
- Model PH-200LC (982-552) has laser diode detection and a combination of contact and non-contact measurement.
- Supplied with plastic carrying case.



982-551



982-552

### SPECIFICATIONS

Order No.	982-551	982-552
Model No.	PH-100A	PH-200LC
Revolution per minute	1.0 – 25,000 rpm	—
Rotation speed	—	Non-contact: 6.0 – 99,999 rpm; Contact: 6.0 – 25,000 rpm
Measuring accuracy Revolution Surface, Speed, Length	1.0 – 599.9rpm: ±1rpm, 600.0 – 25,000 rpm: ±0.006% and ±0.5 digit ±0.4% and 1 digit	6.0 – 599.9 rpm: ±1rpm, 600.0 – 99,999 rpm ±0.006% and ±0.5 digit ±0.4% and ±1 digit
Detection	Optical coupler, 20 pulses per revolution	Laser diode
Outside dimensions	4.83" L x 2.52" W x 1.24" H (122.5mm x 64mm x 31.5mm)	4.55" L x 2.52" W x 1.24" H Overall length with contact adapter: 149mm
Mass	170 g	160 g
Power	Battery: AA 3 pcs.	Battery: AA 3 pcs.

### Optional Accessories for Digital Hand Tachometers

Order No.	Description	Dimension	Drawing
010049	Cone Adapter, Standard	D = 1/2"	
010051	Cone Adapter, 3/4"	D = 3/4"	
010052	Cone Adapter, 1-1/4"	D = 1-1/4" d = 1/2"	
010053	Funnel Adapter, Standard	D = 1/2"	
010054	Funnel Adapter, 3/4"	D = 3/4"	
010055	Measuring Wheel FPM (6" cir), Standard	D = 1.91"	
010056	Measuring Wheel FPM (12" cir)	D = 3.82"	
010057	Measuring Wheel YPM (0.1 yard cir)	D = 1.15"	
010058	Measuring Wheel MPM (0.1 meter cir)	D = 1.25"	
010059	Reflective Tabs 1/2" square (35 pcs)		
010060	Extension Shaft (3" length)		

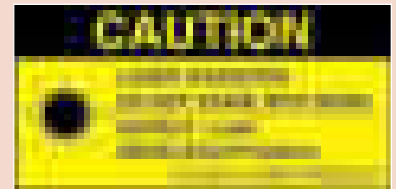

### DIMENSIONS

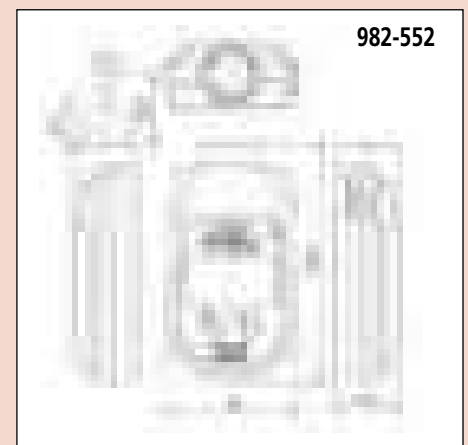
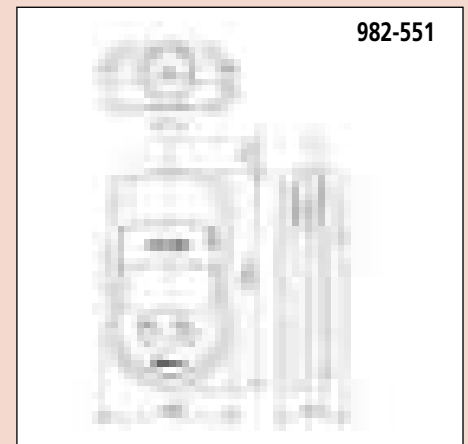

# Bench Center

## SERIES 967

### Technical Data

Spindle tip material: Hardened Steel

### FEATURES

- Used with a dial test indicator (optional), the bench center provides precision measurement of concentricity verification on cylindrical workpieces.
- With an indicator clamp. (Holding stem diameter: 9.53mm / .375")

967-201-10

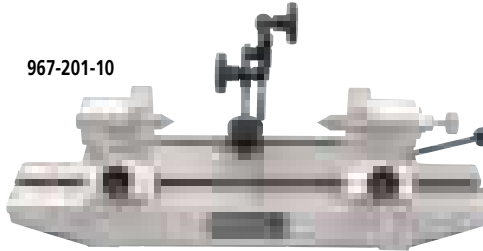

### DIMENSIONS

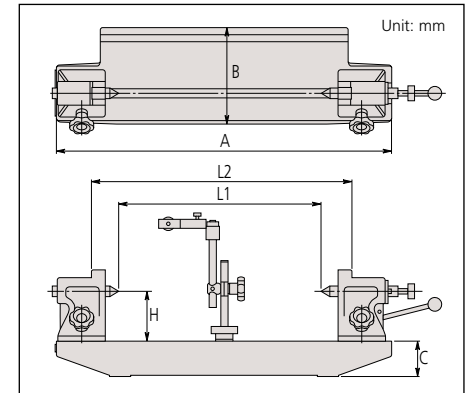

Order No.	A	B	C	H	L1	L2
967-203-10	310	113	40	50	150	220
967-201-10	500	144	55	75	300	400
967-204-10	700	202	80	100	450	590
967-202-10	900	222	100	125	600	730

### Standard Accessories:

**56AAK066** Indicator rod assembly  
**967-201-10**  
**967-203-10**

**56AAK961R** Indicator rod assembly

**967-202-10**  
**967-204-10**

### Optional Accessories:

**56AAJ988** Special attachment for mounting **967-201-10** in vertical position.

**56AAJ987** Special attachment for mounting **967-203-10** in vertical position.

### SPECIFICATIONS

Order No.	Center-to-Center	Workpiece Capacity Diameter	Max. Weight Hold	Parallelism of Centers	Flatness of Surface	Attachment Diameter	Mass (kg)
967-203-10	5.9" / 150mm	3.8"	15.5lbs.(7kg)	.00024"	.0005"	3/8", 8mm	7
967-201-10	11.8" / 300mm	5.8"	35 lbs. (16kg)	.0004"	.0006"	3/8", 8mm	13
967-204-10	17.7" / 450mm	7.8"	44 lbs. (20kg)	.0004"	.0007"	3/8", 8mm	60
967-202-10	23.6" / 600mm	9.8"	66 lbs. (30kg)	.00047"	.00075"	3/8", 8mm	70

# Granite Surface Plate Accessories

## SERIES 517

These accessories are made from the same high-quality black granite as Mitutoyo surface plates, allowing flexibility in work holding and positioning.

### SPECIFICATIONS

**Angle Blocks** \_\_\_\_\_ with or without inserts

Grade	Laboratory*			Master**		
	2 Face	4 Face		2 Face	4 Face	
no inserts		w/ inserts	no inserts		w/ inserts	
4 x 4 x 4"	<b>517-767</b>	<b>517-761</b>	<b>517-773</b>	<b>517-867</b>	<b>517-861</b>	<b>517-873</b>
6 x 6 x 6"	<b>517-768</b>	<b>517-762</b>	<b>517-774</b>	<b>517-868</b>	<b>517862</b>	<b>517-874</b>

\*Laboratory overall accuracy: .000025" per 6".

\*\*Master overall accuracy: .000050" per 6".

### Parallels

Grade	Pair Accuracy	Laboratory		Master		
		2 Face	4 Face	Accuracy	2 Face	4 Face
.75 x 1 x 6"	.00003"	<b>517-755</b>	<b>517-750</b>	.00006"	<b>517-855</b>	<b>517-850</b>
.75 x 1.5 x 9"	.00004"	<b>517-756</b>	<b>517-751</b>	.00008"	<b>517-856</b>	<b>517-851</b>
1 x 2 x 12"	.00006"	<b>517-757</b>	<b>517-752</b>	.0001"	<b>517-857</b>	<b>517-852</b>

### V-Blocks

V-1 type have matching accuracy on "V" from the bottom face only. V-5 type have four face matching accuracy plus "V".

Grade	Laboratory*		Master**	
	V-1	V-5	V-1	V-5
2 x 2 x 2.5"	<b>517-787</b>	<b>517-783</b>	<b>517-887</b>	<b>517-883</b>
3 x 3 x 3"	<b>517-788</b>	<b>517-784</b>	<b>517-888</b>	<b>517-884</b>
6 x 6 x 6"	<b>517-789</b>	<b>517-785</b>	<b>517-889</b>	<b>517-885</b>

\*Laboratory overall accuracy: .00005" per 6".

\*\*Master overall accuracy: .0001" per 6"

Angle Blocks

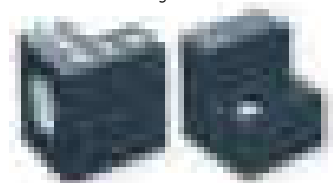

**517-862**  
(without inserts)

**517-884** V-Blocks (matching pair)



**517-852**  
Parallels  
(in pairs)

**Mitutoyo**

# Black Granite Surface Plate

## SERIES 517

### FEATURES

- Natural granite seasoned for thousands of years is free from deterioration or dimensional change over time.
- Granite surface plate has many advantages over cast iron surface plates: Twice as hard as cast iron. Minimal changes in dimension due to temperature changes. Free from wringing, so there is no interruption of work. Free from burrs or protrusions because of the fine grain structure and insignificant stickiness; this ensures a high degree of flatness over a long service life and causes no damage to other parts or instruments.
- Trouble-free operation for use with magnetic materials.
- Long life and rust-free, resulting in low maintenance costs.
- Mitutoyo granite surface plates meet or exceed federal specification GGG-P-463c. Each surface plate is shipped with a Certificate of Accuracy which guarantees its accuracy and verifies its traceability to NIST.
- All plates from 48" x 108" and larger are machine base gray granite. Smaller plates are black granite.
- Surface plates, to size of specifications other than standard, available by special order.
- Surface plates, with the bolt screws, available by special order.
- All Mitutoyo surface plates shipped F.O.B. Escondido, CA.

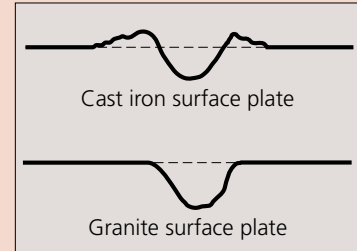

### SPECIFICATIONS

Inch 100 lbs.-Load / sq. ft. no ledge

Size	AA Laboratory Grade				A Inspection Grade				B Shop Grade			
	H	Acc.*	Order No.	Wt. (lbs)	H	Acc.*	Order No.	Wt. (lbs)	H	Acc.*	Order No.	Wt. (lbs)
8 x 12"	3"	50	517-700	30	2"	100	517-800	25	2"	200	517-900	25
9 x 12"	3"	50	517-701	40	3"	100	517-801	40	2"	200	517-901	30
12 x 12"	3"	50	517-702	50	3"	100	517-802	50	3"	200	517-902	50
12 x 18"	4"	50	517-703	100	4"	100	517-803	100	4"	200	517-903	100
18 x 18"	4"	50	517-704	150	4"	100	517-804	150	3"	200	517-904	100
18 x 24"	4"	65	517-705	200	4"	130	517-805	200	4"	260	517-905	200
24 x 24"	5"	70	517-706	310	4"	140	517-806	259	3"	280	517-906	200
24 x 30"	5"	75	517-707	400	5"	150	517-807	400	4"	300	517-907	300
24 x 36"	6"	85	517-708	600	5"	170	517-808	500	4"	340	517-908	400
24 x 48"	8"	150	517-709	1000	6"	300	517-809	800	5"	600	517-909	650
30 x 36"	6"	100	517-710	800	5"	200	517-810	600	5"	400	517-910	600
30 x 48"	8"	150	517-711	1300	6"	300	517-811	1000	6"	600	517-911	1000
30 x 60"	12"	200	517-712	1900	10"	500	517-812	1535	8"	1000	517-912	1150
36 x 36"	6"	100	517-713	900	5"	200	517-813	780	5"	400	517-913	700
36 x 48"	8"	150	517-714	1500	6"	300	517-814	1200	6"	600	517-914	1200
36 x 60"	12"	200	517-715	2850	10"	400	517-815	2350	8"	800	517-915	1900
36 x 72"	12"	250	517-716	3400	10"	500	517-816	2850	8"	1000	517-916	2300
48 x 48"	8"	200	517-717	2025	6"	400	517-817	1525	6"	800	517-917	1500
48 x 60"	12"	250	517-718	3800	10"	500	517-818	3150	8"	1000	517-918	2525
48 x 72"	12"	300	517-719	4500	10"	600	517-819	3800	8"	1200	517-919	3050
48 x 84"	14"	350	517-720	6150	12"	700	517-820	5325	10"	1400	517-920	4450
48 x 96"	14"	400	517-721	7000	12"	800	517-821	6050	10"	1600	517-921	5150
48 x 108"	14"	500	517-722	7900	12"	1000	517-822	6830	10"	2000	517-922	5700
48 x 120"	18"	700	517-723	11300	16"	1400	517-823	10160	14"	2800	517-923	8800
48 x 144"	18"	800	517-724	13500	16"	1600	517-824	12200	14"	3200	517-924	10500
60 x 60"	14"	250	517-725	5500	12"	500	517-825	4800	10"	1000	517-925	4000
60 x 72"	14"	350	517-726	6600	12"	700	517-826	5750	10"	1400	517-926	4900
60 x 96"	14"	500	517-727	8800	12"	1000	517-827	7600	10"	2000	517-927	6500
60 x 120"	16"	700	517-728	11050	14"	1400	517-828	11100	12"	2800	517-928	9800
60 x 144"	18"	900	517-729	16950	16"	1800	517-829	15100	14"	3600	517-929	14200
72 x 72"	14"	400	517-730	8000	12"	800	517-830	7000	10"	1600	517-930	5700
72 x 96"	16"	500	517-731	12025	14"	1000	517-831	10800	12"	2000	517-931	9200
72 x 120"	16"	700	517-732	15070	14"	1400	517-832	13400	12"	2800	517-932	11400
72 x 144"	18"	1000	517-733	20300	16"	2000	517-833	18100	14"	4000	517-933	15900

\* Accuracies shown in microinches (µin)

# Black Granite Surface Plate

**SERIES 517**

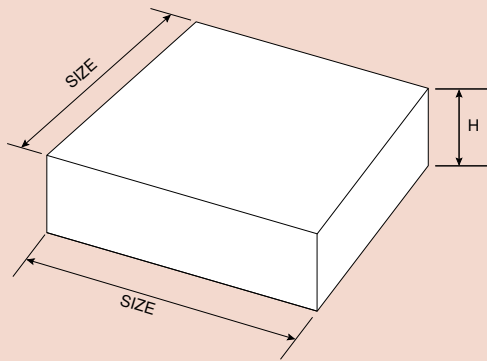

**Inch** 50 lbs.-Load / sq. ft. no ledge

Size	AA Laboratory Grade				A Inspection Grade				B Shop Grade			
	H	Acc.	Order No.	Wt.	H	Acc.	Order No.	Wt.	H	Acc.	Order No.	Wt.
8 x 12"	2"	50	<b>517-740</b>	25	2"	100	<b>517-840</b>	25	2"	200	<b>517-940</b>	25
12 x 18"	3"	50	<b>517-741</b>	80	3"	100	<b>517-841</b>	80	2"	200	<b>517-941</b>	60
18 x 24"	4"	65	<b>517-742</b>	200	3"	130	<b>517-842</b>	165	2"	260	<b>517-942</b>	100
24 x 36"	5"	85	<b>517-743</b>	500	4"	170	<b>517-843</b>	400	3"	340	<b>517-943</b>	300
36 x 48"	6"	150	<b>517-746</b>	1200	5"	300	<b>517-846</b>	1000	4"	600	<b>517-946</b>	800

## Steel Stands

**SERIES 517**

Steel stands for supporting black granite surface plates, at working levels, are available either stationary or with casters. Sizes and weights are given below.

### SPECIFICATIONS

Size	Stationary		With Casters	
	Order No.	Wt.	Order No.	Wt.
12 x 18"	<b>517-950</b>	42lbs	<b>517-950-1</b>	46lbs
18 x 18"	<b>517-951</b>	46lbs	<b>517-951-1</b>	50lbs
18 x 24"	<b>517-952</b>	50lbs	<b>517-952-1</b>	56lbs
24 x 24"	<b>517-954</b>	65lbs	<b>517-954-1</b>	69lbs
24 x 30"	<b>517-955</b>	70lbs	<b>517-955-1</b>	74lbs
24 x 36"	<b>517-956</b>	73lbs	<b>517-956-1</b>	77lbs
24 x 48"	<b>517-957</b>	90lbs	<b>517-957-1</b>	94lbs
30 x 36"	<b>517-960</b>	85lbs	<b>517-960-1</b>	89lbs
30 x 48"	<b>517-961</b>	95lbs	<b>517-961-1</b>	99lbs
30 x 60"	<b>517-962</b>	105lbs	<b>517-962-1</b>	109lbs
36 x 36"	<b>517-963</b>	95lbs	<b>517-963-1</b>	99lbs
36 x 48"	<b>517-964</b>	105lbs	<b>517-964-1</b>	109lbs
36 x 60"	<b>517-965</b>	160lbs	<b>517-965-1</b>	164lbs
36 x 72"	<b>517-966</b>	180lbs	<b>517-966-1</b>	184lbs
48 x 48"	<b>517-967</b>	190lbs	<b>517-967-1</b>	194lbs
48 x 60"	<b>517-968</b>	200lbs	<b>517-968-1</b>	204lbs
48 x 72"	<b>517-969</b>	205lbs	<b>517-969-1</b>	209lbs
48 x 84"	<b>517-970</b>	320lbs	<b>517-970-1</b>	324lbs
48 x 96"	<b>517-971</b>	335lbs	<b>517-971-1</b>	339lbs
48 x 108"	<b>517-972</b>	350lbs	<b>517-972-1</b>	354lbs
48 x 120"	<b>517-973</b>	365lbs	<b>517-973-1</b>	369lbs
48 x 144"	<b>517-974</b>	430lbs	<b>517-974-1</b>	434lbs
60 x 60"	<b>517-975</b>	245lbs		
60 x 72"	<b>517-976</b>	340lbs		
60 x 96"	<b>517-977</b>	375lbs		
60 x 120"	<b>517-978</b>	455lbs		
60 x 144"	<b>517-979</b>	480lbs		
72 x 72"	<b>517-980</b>	380lbs		
72 x 96"	<b>517-981</b>	465lbs		
72 x 120"	<b>517-982</b>	510lbs		
72 x 144"	<b>517-983</b>	530lbs		

48x72 and smaller include keepers to prevent the surface plate from being pushed off the stand.

Note: Stands can only be purchased with granite surface plates. Working height is 36" unless otherwise specified.



# MITUTOYO CALIBRATION SERVICES

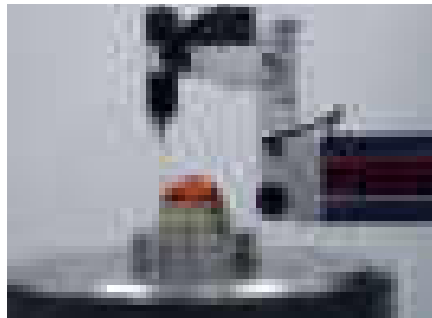
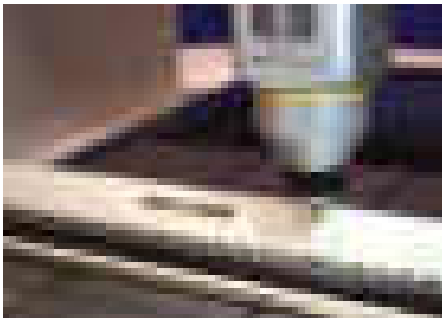

Mitutoyo America has expanded three-dimensional calibration and inspection services at our new precision measurement facility located in our corporate headquarters in Aurora, IL. Equipped with multiple Mitutoyo Legex CMMs, along with high-accuracy vision and form measuring instruments, our laboratory offers accredited dimensional measurement services with uncertainty as low as  $0.25\ \mu\text{m}$  (10  $\mu\text{inches}$ ). And for form measurement, our uncertainty goes as low as 5 nanometers (0.2  $\mu\text{inches}$ ).

Our experienced staff is ready for your challenges – we specialize in specialty gage calibration, complex prototype or master parts, specialty and custom-built 3D gages, and long length standards such as ball bars, step gages and gage blocks. We can also assist you in the validation of your measurement processes by providing accredited reference values on your parts.

Mitutoyo America calibration and inspection services are accredited to ISO/IEC 17025 by A2LA (Certificate 0750.01). We welcome customer tours of our laboratory.

If you have any questions or would like more information regarding Mitutoyo Calibration Services, contact: [mim@mitutoyo.com](mailto:mim@mitutoyo.com)







### Digimatic Indicators



### Dial Indicators



### Dial Test Indicators

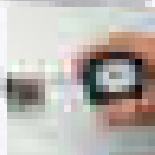

### Dial Indicator Applications and Stands

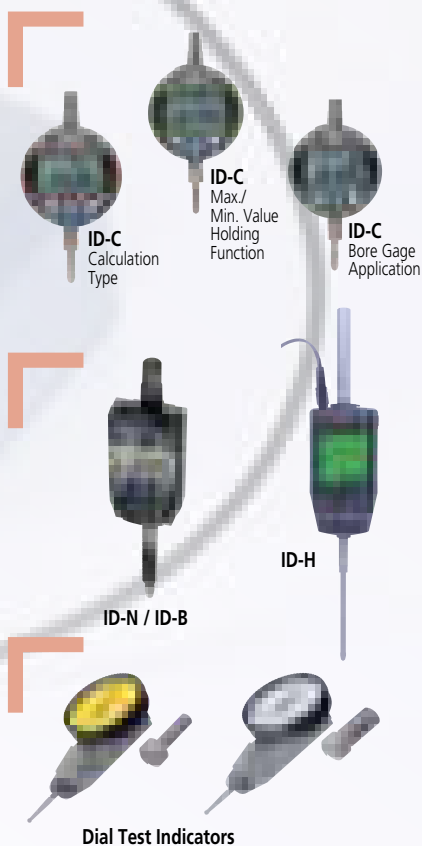

### INDEX

Digimatic Indicators		
ABSOLUTE Solar Digimatic Indicator ID-S		F-2,3
ABSOLUTE Digimatic Indicator ID-U		F-4
ABSOLUTE Digimatic Indicator ID-C		F-5,6
ABSOLUTE Digimatic Indicator ID-C Calculation Type		F-7
ABSOLUTE Digimatic Indicator ID-C With Max./Min. Value Holding Function		F-8
ABSOLUTE Digimatic Indicator ID-C Specially Designed for Bore Gage Application		F-9
ABSOLUTE Digimatic Indicator ID-C With Green/Red LED and Go/No-go Signal Output Function		F-10
ABSOLUTE Digimatic Indicator ID-H		F-11
ABSOLUTE Digimatic Indicator ID-F		F-12
ABSOLUTE Digimatic Indicator ID-N / B		F-13
EC Counter		F-14
Dial Indicators		
Special Dial Indicators		F-15-21, 23-30
Back Plunger Dial Indicators		F-31,32
Backs		F-33
Contact Points		F-34,35
Spindle Lifting Lever and Cable		F-36
Color Spindle Caps		F-37
Limit Stickers		F-37
Dial Indicator Repair Tool Kit		F-38
Dial Crystal Setter		F-38
Dial Test Indicators		
Pocket Dial Test Indicators		F-39-43
Dial Test Indicators		F-44,45
Contact Points and Clamp Holders		F-46
Dial Indicator Applications		F-47
i-Checker		F-48
UDT-2 Dial Gage Testers		F-49
Calibration Testers		F-49
Thickness Gages		F-50-52
Quick-Mini		F-53
Digimatic Caliper Gages		F-54,55
Dial Caliper Gages		F-56,57
Dial Tension Gages		F-58
V-Block Sets		F-58
Magnetic V-Block		F-58
Dial Snap Gages		F-59
Stands		
Dial/Test Indicator & Magnetic Stand Sets		F-60
Magnetic Stands		F-60
Dial Gage Stands		F-61
Transfer Stands		F-62
Granite Comparator Stands		F-63
Comparator Stands		F-64
Precision Granite Stands		F-65

# ABSOLUTE Solar Digimatic Indicator ID-S

## 543 Series – With Simple Design

### FEATURES

- Mitutoyo's unique ABSOLUTE sensor automatically restores the last origin position when the indicator is turned on. This allows quick-start operation, which is particularly useful in multipoint measurement.
- Measurement tool with a solar power source. Ready for use from 40 lux illumination.
- Similar in size to Series 2 dial indicators.
- SPC output provided.
- Two large buttons (three on inch/mm models) improve functionality.



543-502B  
ID-S112ESB

543-500  
ID-S112S

### SPECIFICATIONS

**Inch/Metric** with 3/8" dia. Stem, #4-48UNF Thread

Order	Model	Range	Resolution	Accuracy	Stem Diameter	Measuring Force	Back Type
543-502	ID-S112ES	.5"/12.7mm	.00005"/0.001mm	.0001"/0.003mm	3/8" (ANSI/AGD)	1.5N or less	Lug Back
543-502B	ID-S112ESB	.5"/12.7mm	.00005"/0.001mm	.0001"/0.003mm	3/8" (ANSI/AGD)	1.5N or less	Flat Back
543-507	ID-S1012ES	.5"/12.7mm	.0005"/0.01mm	.001"/0.02mm	3/8" (ANSI/AGD)	1.5N or less	Lug Back
543-507B	ID-S1012ESB	.5"/12.7mm	.0005"/0.01mm	.001"/0.02mm	3/8" (ANSI/AGD)	1.5N or less	Flat Back

**Metric** with 8mm dia. Stem, M2.5x.45 Thread

Order	Model	Range	Resolution	Accuracy	Stem Diameter	Measuring Force	Back Type
543-500	ID-S112S	12.7mm	0.001mm	0.003mm	8mm (ISO)	1.5N or less	Lug Back
543-500B	ID-S112SB	12.7mm	0.001mm	0.003mm	8mm (ISO)	1.5N or less	Flat Back
543-505	ID-S1012S	12.7mm	0.01mm	0.02mm	8mm (ISO)	1.5N or less	Lug Back
543-505B	ID-S1012SB	12.7mm	0.01mm	0.02mm	8mm (ISO)	1.5N or less	Flat Back

**Inch/Metric** with 8mm dia. Stem, M2.5x.45 Thread

Order	Model	Range	Resolution	Accuracy	Stem Diameter	Measuring Force	Back Type
543-501	ID-S112MS	.5"/12.7mm	.00005"/0.001mm	.0001"/0.003mm	8mm (ISO)	1.5N or less	Lug Back
543-501B	ID-S112MSB	.5"/12.7mm	.00005"/0.001mm	.0001"/0.003mm	8mm (ISO)	1.5N or less	Flat Back
543-506	ID-S1012MS	.5"/12.7mm	.0005"/0.01mm	.001"/0.02mm	8mm (ISO)	1.5N or less	Lug Back
543-506B	ID-S1012MSB	.5"/12.7mm	.0005"/0.01mm	.001"/0.02mm	8mm (ISO)	1.5N or less	Flat Back

### Technical Data

Accuracy: Refer to the list of specifications  
 Resolution: 0.01mm, 0.001mm, .00005"/0.001mm, or .0005"/0.01mm  
 Display: LCD  
 Length Standard: ABSOLUTE electrostatic capacitance-type linear encoder  
 Max. Response Speed: Unlimited  
 Measuring Force: Refer to the list of specifications  
 Battery: Solar Battery\*  
 Dust/Water Protection Level: IP42  
 \*Can be used continuously above 40 lux

### Function

Origin Set, Counting Direction Switching, in/mm conversion

### Optional Accessories

- 21EZA198 Lifting lever (mm)
- 21EZA199 Lifting lever (inch)
- 540774 Lifting cable
- 21EZA105 Lifting knob (mm)
- 21EZA150 Lifting knob (inch)
- 905338 SPC cable (1m)
- 905409 SPC cable (2m)
- : Backs (See page F-33.)
- : Contact points (See page F-34.)

### About the charge function:

Reserve capacity allows a fully charged ID-S Solar to be used for about 3.5 hours under light conditions below the minimum level. The charging time differs depending on the environment, but it usually takes about 1.5 hours for a fully discharged ID-S Solar to fully recharge under light conditions of 500 lux.

### DIMENSIONS

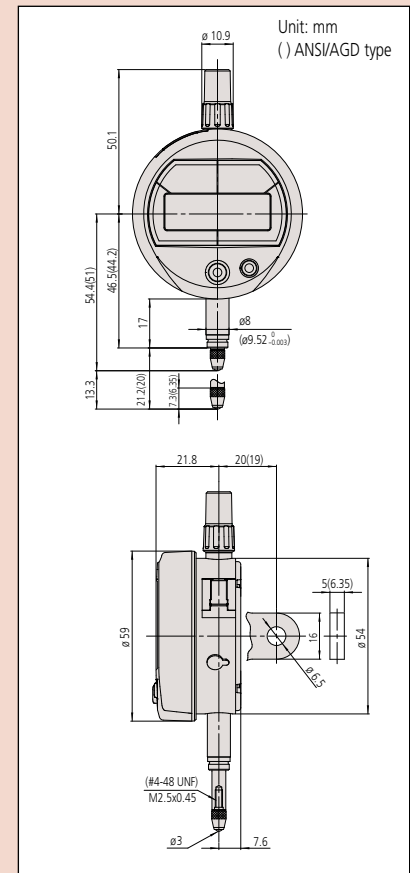



### Technical Data

Accuracy: Refer to the list of specifications  
 Resolution: 0.01mm, 0.001mm, .0005"/0.01mm, .0001"/0.001mm or .00005"/0.001mm  
 Display: LCD  
 Length standard: ABSOLUTE electrostatic capacitance-type linear encoder  
 Max. response speed: Unlimited  
 Measuring force: Refer to the list of specifications  
 Battery: SR44 (1 pc.), **938882**  
 Battery life: Approx. 20,000 hours under normal use  
 Dust/Water protection level: IP42 (IP53: **543-794B**, **543-795B**, **543-796B**)  
 Inspection certificate is included.

### Function

Origin-set, Zeroset, Counting direction switching, Power ON/OFF, Data output, inch/mm conversion (on inch/metric models only)  
 Alarm: Low voltage, Counting value composition error, Over-flow error

### Optional Accessories

- 905338:** SPC cable (40" / 1m)
- 905409:** SPC cable (80" / 2m)
- 21EZA198:** Spindle lifting lever (ISO/JIS type)
- 21EZA199:** Spindle lifting lever (ANSI/AGD type)
- 540774:** Spindle lifting cable (stroke: .4" / 10mm)
- 21EZA105:** Lifting knob (mm)
- 21EZA150:** Lifting knob (inch)
- 125317:** Spare rubber boot (for dust-proof type)
- : Backs (See page F-33.)
- : Contact points (See page F-34.)

# ABSOLUTE Digimatic Indicator ID-S

## SERIES 543 — with Simple Design

### FEATURES

- After the initial zero-setting with the Origin button, the repeated absolute positioning is no longer necessary over entire battery life.
- Similar in size to standard Series 2 dial indicators.
- SPC data output.
- Unlimited response speed eliminates over-speed errors



543-782B



543-792B

### SPECIFICATIONS

Inch/Metric		Stem dia. 3/8", #4-48 UNF Thread		ISO/JIS type	ANSI/AGD type		
Resolution	Range	Order No.		Model	Accuracy	Measuring force	Remarks
		w/ lug back	w/ flat-back				
.00005"/0.001mm	.5" / 12.7mm	<b>543-792</b>	<b>543-792B</b>	ID-S112EX	±.0001"	1.5N or less	—
.00005"/0.001mm	.5" / 12.7mm	<b>543-796</b>	<b>543-796B</b>	ID-S112PEX	±.0001"	2.5N	Dust-proof
.0001"/0.001mm	.5" / 12.7mm	<b>543-793</b>	<b>543-793B</b>	ID-S112TX	±.0001"	1.5N or less	—
.0005"/0.01mm	.5" / 12.7mm	<b>543-783</b>	<b>543-783B</b>	ID-S1012EX	±.0010"	1.5N or less	—

Inch/Metric		Stem ø 8mm, M2.5 x 0.45 Thread					
Resolution	Range	Order No.		Model	Accuracy	Measuring force	Remarks
		w/ lug back	w/ flat-back				
.00005"/0.001mm	.5" / 12.7mm	<b>543-791</b>	<b>543-791B</b>	ID-S112MX	±.0001"	1.5N or less	—
.00005"/0.001mm	.5" / 12.7mm	<b>543-795</b>	<b>543-795B</b>	ID-S112PMX	±.0001"	2.5N or less	Dust-proof
.0005"/0.01mm	.5" / 12.7mm	<b>543-782</b>	<b>543-782B</b>	ID-S1012MX	±.0008"	1.5N or less	—

Metric		Stem ø 8mm, M2.5 x 0.45 Thread					
Resolution	Range	Order No.		Model	Accuracy	Measuring force	Remarks
		w/ lug back	w/ flat-back				
0.001mm	12.7mm	<b>543-790</b>	<b>543-790B</b>	ID-S112X	0.003mm	1.5N or less	—
0.001mm	12.7mm	<b>543-794</b>	<b>543-794B</b>	ID-S112PX	0.003mm	2.5N or less	Dust-proof
0.01mm	12.7mm	<b>543-781</b>	<b>543-781B</b>	ID-S1012X	0.02mm	1.5N or less	—

### DIMENSIONS

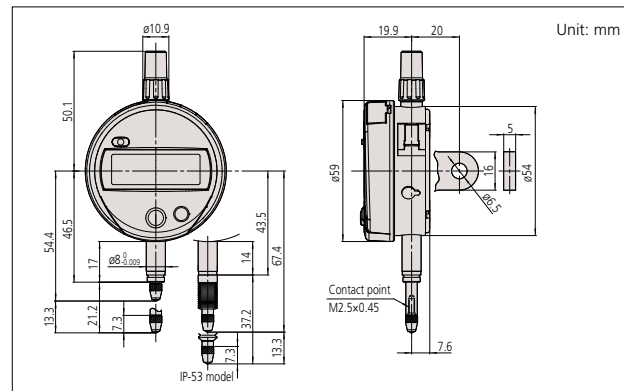

- Note 1: Dimensions of the inch (ANSI/AGD Type) dial indicator partly differ from those of the metric (ISO/JIS Type) indicator.
- Note 2: Inch (ANSI/AGD Type) dial indicators are provided with a stem of 3/8" dia. and #4-48UNF thread mount for the contact point.



# ABSOLUTE Digimatic Indicator ID-U

**SERIES 575 — With Slim and Simple Design**

## FEATURES

- Slim digital indicator with low price.
- Large LCD and simple key operation.
- After the initial origin setting, the ID-U no longer needs absolute positioning over entire battery life; the origin is remembered even after power-off.
- Ideal for installation into measuring devices because of compact design and long battery life.
- Employing the ABSOLUTE linear encoder, the ID-U always displays the spindle "Absolute Position" from the origin at power-on. Also unlimited response speed eliminates over-speed errors.
- Flat back type only has no option for backs.
- SPC data output.

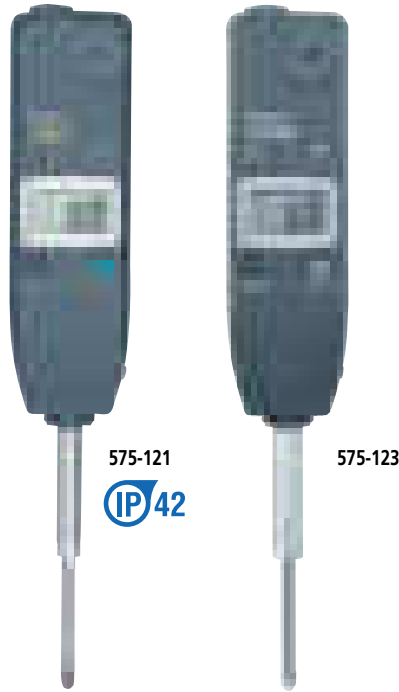

## SPECIFICATIONS

**Inch/Metric** Stem dia. 3/8", #4-48 UNF Thread  ISO/JIS type  ANSI/AGD type

Resolution	Range	Order No.	Model	Accuracy	Measuring force
.0005"/0.01mm	1" / 25.4mm	<b>575-123</b>	ID-U1025E	.0008"	1.8N or less

**Inch/Metric** Stem  $\varnothing$  8mm, M2.5 x 0.45 Thread

Resolution	Range	Order No.	Model	Accuracy	Measuring force
.0005"/0.01mm	1" / 25.4mm	<b>575-122</b>	ID-U1025M	.0008"	1.8N or less

**Metric** Stem  $\varnothing$  8mm, M2.5 x 0.45 Thread

Resolution	Range	Order No.	Model	Accuracy	Measuring force
0.01mm	25.4mm	<b>575-121</b>	ID-U1025	0.02mm	1.8N or less

## DIMENSIONS

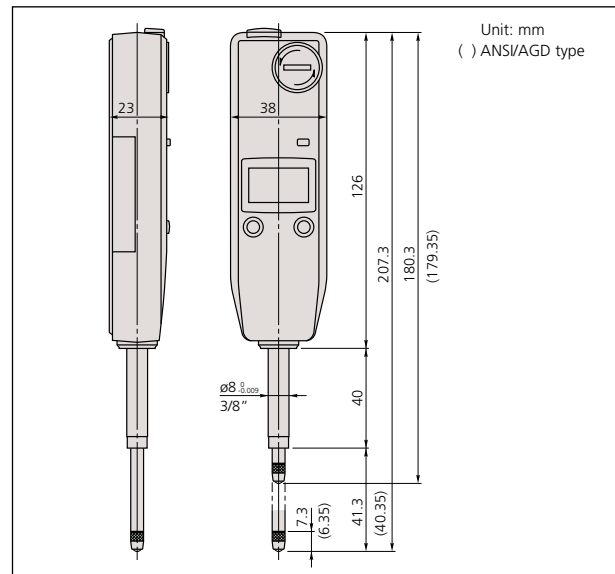

**ABSOLUTE**<sup>®</sup>

Absolute System Patented by MITUTOYO

## Technical Data

Accuracy: Refer to the list of specifications  
 Resolution: 0.01mm or .0005"/0.01mm,  
 Display: LCD  
 Length standard: ABSOLUTE electrostatic capacitance type linear encoder  
 Max. response speed: Unlimited  
 Measuring force: Refer to the list of specifications  
 Battery: SR44 (1 pc.), **938882**  
 Battery life: Approx. 20,000 hours under normal use  
 Dust/Water protection level: IP42

## Function

Origin-set, Zeroset, Counting direction switching, Power ON/OFF, Data output, inch/mm conversion (on inch/metric models only)  
 Alarm: Low voltage, Counting value composition error, Over-flow error

## Optional Accessories

**905338**: SPC cable (40" / 1m)  
**905409**: SPC cable (80" / 2m)  
**540774**: Spindle lifting cable (stroke: 4" / 10mm)  
 \_\_\_\_\_: Contact points (See page F-34.)

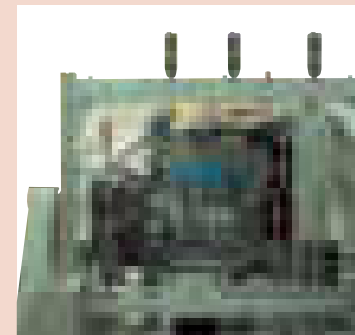

Application example



# ABSOLUTE Digimatic Indicator ID-C

## SERIES 543 — Standard Type

### FEATURES

- Similar in size to Series 2 dial indicators.
- Large, easy-to-read LCD.
- Go/no-go judgment can be performed by setting upper and lower tolerance limits. The judgment result (go/no-go) can be displayed in full-size characters.
- The positive/negative count resulting from the spindle's up/down movement can be toggled.
- Internal calculations using the simple formula of  $[F(x) = Ax]$  are available.
- Employing the ABSOLUTE linear encoder, the ID-C always displays the spindle "Absolute Position" from the origin at power-on. Also unlimited response speed eliminates over-speed errors.
- The ID-C indicator face can be rotated 330° to an appropriate angle for easy reading.
- With SPC data output.

### Technical Data

Accuracy: Refer to the list of specifications

Resolution:	0.01mm type	0.01mm
	0.001mm type*	0.001mm/0.01mm
	.0005"/0.01mm type	.0005"/0.01mm
	.00005"/0.001mm type*	.0005"/.0001"/.00005"/0.01mm/0.001mm

\* Switchable resolution

Display: LCD  
 Length standard: ABSOLUTE electrostatic capacitance type linear encoder  
 Max. response speed: Unlimited  
 Measuring force: Refer to the list of specifications  
 Battery: SR44 (1 pc.), **938882**  
 Battery life: Approx. 7,000 hours under normal use  
 Dust/Water protection level: IP42  
 Inspection certificate is included

### Function

Origin-set/Preset, Zeroset, go/no-go judgment, Counting direction switching, Power ON/OFF, Data output, inch/mm conversion (on inch/metric models only)  
 Alarm: Low voltage, Counting value composition error, Over-flow error, Tolerance limit setting error  
 Internal calculations using the simple formula of  $[F(x) = Ax]$  are available.

### Optional Accessories

- 905338:** SPC cable (40" / 1m)
- 905409:** SPC cable (80" / 2m)
- 21EZA198:** Spindle lifting lever (ISO/JIS type)\*
- 21EZA199:** Spindle lifting lever (ANSI/AGD type)\*
- 21EZA105:** Spindle lifting knob (12.7mm/.5" ISO/JIS type)\*\*
- 21EZA150:** Spindle lifting knob (12.7mm/.5" ANSI/AGD type)\*\*
- 21EZA197:** Spindle lifting knob (25.4mm/1" , 50.8mm/2" models)
- 21EZA200:** Spindle lifting knob (50.8mm/2")
- 540774:** Spindle lifting cable (stroke: (1" / 25.4mm)
- 02ACA571:** Auxiliary spindle spring for 25mm/1" models\*\*\*
- 02ACA773:** Auxiliary spindle spring for 50mm/2" models\*\*\*
- : Backs (See page F-33.)
- : Contact points (See page F-34.)

\*Can be used on 12mm/.5" models only.  
 \*\*Not available for low measuring force models.  
 \*\*\*Required when orienting gage upside down.



543-392  
IP42



543-402  
IP42



543-472B  
IP42



543-492B  
IP42

# SPECIFICATIONS

**Inch/Metric** Stem dia. 3/8", #4-48 UNF Thread  ISO/JIS type  ANSI/AGD type

Resolution	Range	Order No. (w/lug, flat-back)	Model	Accuracy	Measuring force	Remarks
.00005"/0.001mm*	.5" / 12.7mm	<b>543-392</b> <b>543-392B</b>	ID-C112EXB	.0001"	1.5N or less	—
.00005"/0.001mm*	.5" / 12.7mm	<b>543-396</b> <b>543-396B</b>	ID-C112CEX	.0001"	0.4N - 0.7N	Low measuring force
.00005"/0.001mm*	1" / 25.4mm	— <b>543-472B</b>	ID-C125EXB	.0001"	1.8N or less	—
.00005"/0.001mm*	2" / 50.8mm	— <b>543-492B</b>	ID-C150EXB	.0002"	2.3N or less	—
.0005"/0.01mm	.5" / 12.7mm	<b>543-402</b> <b>543-402B</b>	ID-C1012EX	.001"	0.9N or less	—
.0005"/0.01mm	.5" / 12.7mm	<b>543-406</b> <b>543-406B</b>	ID-C1012CEX	.001"	0.2N - 0.5N	Low measuring force
.0005"/0.01mm	1" / 25.4mm	— <b>543-476B</b>	ID-C1025EXB	.001"	1.8N or less	—
.0005"/0.01mm	2" / 50.8mm	— <b>543-496B</b>	ID-C112CEXB	.0016"	2.3N or less	—

\* Switchable Resolution Type

**Inch/Metric** Stem ø 8mm, M2.5 x 0.45 Thread

Resolution	Range	Order No. (w/lug, flat-back)	Model	Accuracy	Measuring force	Remarks
.00005"/0.001mm*	.5" / 12.7mm	<b>543-391</b> <b>543-391B</b>	ID-C112MX	.0001"	1.5N or less	—
.00005"/0.001mm*	.5" / 12.7mm	<b>543-395</b> <b>543-395B</b>	ID-C112CMX	.0001"	0.4N - 0.7N	Low measuring force
.00005"/0.001mm*	1" / 25.4mm	— <b>543-471B</b>	ID-C125MXB	.0001"	1.8N or less	—
.00005"/0.001mm*	2" / 50.8mm	— <b>543-491B</b>	ID-C150MXB	.0002"	2.3N or less	—
.0005"/0.01mm	.5" / 12.7mm	<b>543-401</b> <b>543-401B</b>	ID-C1012MX	.001"	0.9N or less	—
.0005"/0.01mm	.5" / 12.7mm	<b>543-405</b> <b>543-405B</b>	ID-C1012CMX	.001"	0.2N - 0.5N	Low measuring force
.0005"/0.01mm	1" / 25.4mm	— <b>543-475B</b>	ID-C1025MXB	.001"	1.8N or less	—
.0005"/0.01mm	2" / 50.8mm	— <b>543-495B</b>	ID-C1050MXB	.0016"	2.3N or less	—

\* Switchable Resolution Type

**Metric** Stem ø 8mm, M2.5 x 0.45 Thread

Resolution	Range	Order No. (w/lug, flat-back)	Model	Accuracy	Measuring force	Remarks
0.001mm*	12.7mm	<b>543-390</b> <b>543-390B</b>	ID-C112X	0.003mm	1.5N or less	—
0.001mm*	12.7mm	<b>543-394</b> <b>543-394B</b>	ID-C112CX	0.003mm	0.4N - 0.7N	Low measuring force
0.001mm*	25.4mm	— <b>543-470B</b>	ID-C125XB	0.003mm	1.8N or less	—
0.001mm*	50.8mm	— <b>543-490B</b>	ID-C150XB	0.006mm	2.3N or less	—
0.01mm	12.7mm	<b>543-400</b> <b>543-400B</b>	ID-C1012X	0.02mm	0.9N or less	—
0.01mm	12.7mm	<b>543-404</b> <b>543-404B</b>	ID-C1012CX	0.02mm	0.2N - 0.5N	Low measuring force
0.01mm	25.4mm	— <b>543-474B</b>	ID-C1025XB	0.03mm	1.8N or less	—
0.01mm	50.8mm	— <b>543-494B</b>	ID-C1050XB	0.04mm	2.3N or less	—

\* Switchable Resolution Type

# DIMENSIONS

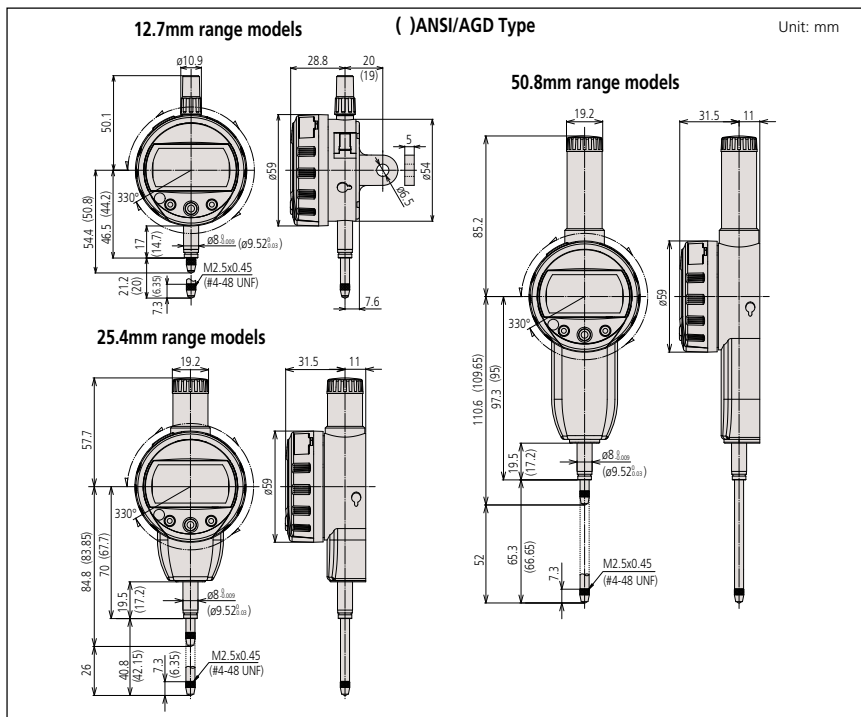

## 330° Rotary display

The display can be rotated 330°, allowing use at a position where you can easily read the measurement value.

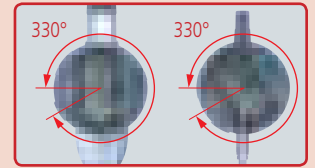

## Calculation: f(x) = Ax

Mounting the ID-C on a measuring jig and setting the multiplying factor A (to any value) allows direct measurement without using a conversion table and improves measurement efficiency.



## Function locking

Ensures reliability of measurement by locking the settings to prevent preset function settings from being changed by mistake.

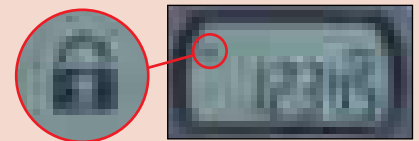

## Setting measuring force on low measuring force models.

### •543-404/404B/405/405B/406/406B

Spindle orientation	Spring	Weight (approximately 0.1N)	Maximum measuring force
Pointing vertically downward	Yes	Yes	0.5N
	Yes	No	0.4N
	No	Yes	0.3N
	No	No	0.2N
Horizontal	Yes	No	0.2N

Note: Operation using configurations other than shown above is not guaranteed.

### •543-394/394B/395/395B/396/396B

Spindle orientation	Spring	Weight (approximately 0.1N)	Maximum measuring force
Pointing vertically downward	Yes	Yes	0.7N
	Yes	No	0.6N
	No	Yes	0.4N
	No	No	Not guaranteed
Horizontal	Not guaranteed		

Note: Operation using configurations other than shown above is not guaranteed.



### Technical Data

Accuracy: Refer to the list of specifications  
 Resolution: 12 Steps  
 .00005/.0001/.0005"  
 0.001/0.01mm  
 Display: LCD  
 Length standard: ABSOLUTE electrostatic capacitance-type linear encoder  
 Max. response speed: Unlimited  
 Measuring force: Refer to the list of specifications  
 Battery: CR2032 (1 pc.), **05SAA217**  
 Battery life: Approx. 12 months under normal use  
 IP Rating: Equivalent to IP-42<sup>\*1</sup>

<sup>\*1</sup> A protection class indication (IP=International Protection) is based on the IEC 60529 /DIN40050 part 1/JIS D0207, C0920. The level indicated is valid only if the output connector cap is installed.

### Function

Key Lock, Parameter Lock, PC-USB Input, Analog Bar, FAST measurement frequency, Preset (up to 3 values), Tolerance Judgment, Peak Detection, Calculation, inch/mm conversion (on inch/metric models only), Counting direction switching, Data Output

Alarm: Low voltage, Counting value composition error, Over-flow error, Tolerance limit setting error

### Optional Accessories

- 905338:** Connecting Cable (1m)
- 905409:** Connecting Cable (2m)
- 21EZA313:** Parameter Setting USB Cable
- 21EZA198:** Spindle lifting lever (12.7mm ISO/JIS type)
- 21EZA199:** Spindle lifting lever (12.7mm ASME/AGD type)
- 21EZA105:** Lifting Knob (12.7mm/.5" ISO/JIS Models)
- 21EZA150:** Lifting Knob (12.7mm/.5" ASME/AGD Models)
- 21EZA197:** Lifting Knob (for 25.4/1" mm models)
- 21EZA200:** Lifting Knob (for 50.8/2" mm models)
- 540774:** Spindle lifting cable
- : Backs (See page F-33.)
- : Contact points (See page F-34.)

### APPLICATIONS

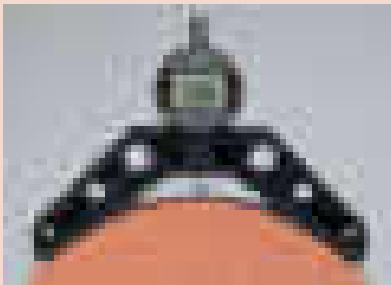

- Various fixtures suited for individual workpieces can be prepared.
- Measuring accuracy is subject to fixture accuracy

# ABSOLUTE Digimatic Indicator ID-C

## SERIES 543 — Calculation Type

### FEATURES

- The new Calculation-Type Digimatic Indicator features both a Key-Lock and Parameter-Lock to prevent accidental changing of settings during operation.
- Improved parameter setting software makes easy to set all available parameters, and determine and upload the proper coefficients for calculation. (optional)
- Fast measurement frequency allows the user to increase the number of readings per second from 10 to 50, allowing higher accuracy measurements of TIR and MAX/MIN.
- An analog bar provides easy-to-read values when scanning for Max, Min, and TIR Values.
- The Absolute Digimatic indicator performs internal calculations using the formula  $Ax+B+Cx-1$  (assuming spindle displacement as  $x$ ) while the specified coefficients  $A$ ,  $B$  and  $C$  can be set with respect to the purpose of measurement or dimensions of the fixtures. This unique features allows you to read your measurements directly, without the need for conversions.



543-342B

### SPECIFICATIONS

ISO/JIS type      ANSI/AGD type

Inch/Metric		Stem dia. 3/8" #4-48 UNF Thread			
Resolution	Range	Order No.*	Model	Accuracy	Measuring Force
.00005/.0001/.0005"	.5"/12.7mm	<b>543-342B</b>	ID-C112REXB	±.00010"/0.003mm	1.5N or less
0.001/0.01mm	1"/25.4mm	<b>543-592B</b>	ID-C125REXB	±.00010"/0.003mm	1.8N or less
Selectable	2"/50.8mm	<b>543-597B</b>	ID-C150REXB	±.00025"/0.006mm	2.3N or less

Inch/Metric		Stem ø 8mm, M2.5 x 0.45 Thread			
Resolution	Range	Order No.*	Model	Accuracy	Measuring Force
.00005/.0001/.0005"	.5"/12.7mm	<b>543-341B</b>	ID-C112RMXB	±.00010"/0.003mm	1.5N or less
0.001/0.01mm	1"/25.4mm	<b>543-591B</b>	ID-C125RMXB	±.00010"/0.003mm	1.8N or less
Selectable	2"/50.8mm	<b>543-596B</b>	ID-C150RMXB	±.00025"/0.006mm	2.3N or less

Metric		Stem ø 8mm, M2.5 x 0.45 Thread			
Resolution	Range	Order No.*	Model	Accuracy	Measuring Force
0.001/0.01mm	.5"/12.7mm	<b>543-340B</b>	ID-C112RXB	0.003mm	1.5N or less
Selectable	1"/25.4mm	<b>543-590B</b>	ID-C125RXB	0.003mm	1.8N or less
	2"/50.8mm	<b>543-595B</b>	ID-C150RXB	0.006mm	2.3N or less

\*Flat back

### DIMENSIONS

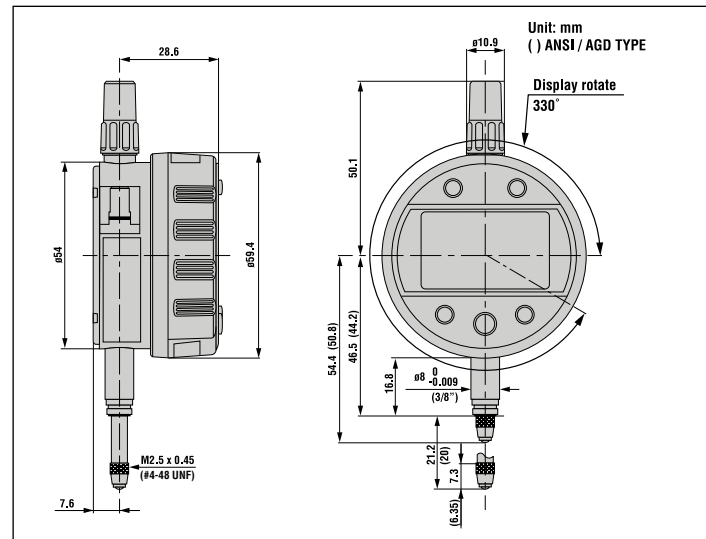

# ABSOLUTE Digimatic Indicator ID-C

**SERIES 543 — With Max./Min. Value Holding Function**

## FEATURES

- The new Peak Hold-Type Digimatic Indicator features both a Key-Lock and Parameter-Lock to prevent accidental changing of settings during operation.
- Parameter setting software makes it even easy to set all available parameters.
- An analog bar provides easy-to-read values when scanning for Max, Min and TIR Values.
- The maximum, minimum or runout value can be displayed during measurement.
- Go/no-go judgment is performed by setting the upper and lower tolerances for max., min. and runout values.
- High speed sampling ratio of 50 times/s.
- Employing the ABSOLUTE linear encoder, the Signal ID-C always displays the spindle Absolute Position from the origin when turned on.



543-302B

## SPECIFICATIONS

ISO/JIS type    ANSI/AGD type

Resolution	Range	Order No.		Model	Accuracy
		w/lug	Flat-back		
.00005/.0001/.0005" 0.001/0.01mm Selectable	.5"/12.7mm	<b>543-302</b>	<b>543-302B</b>	ID-C112AEX(B)	±.00010"/0.003mm

Resolution	Range	Order No.		Model	Accuracy
		w/lug	Flat-back		
.00005/.0001/.0005" 0.001/0.01mm Selectable	.5"/12.7mm	<b>543-301</b>	<b>543-301B</b>	ID-C112AMX(B)	±.00010"/0.003mm

Resolution	Range	Order No.		Model	Accuracy
		w/lug	Flat-back		
0.001-0.01mm Selectable	12.7mm	<b>543-300</b>	<b>543-300B</b>	ID-C112AX(B)	0.003mm

## DIMENSIONS

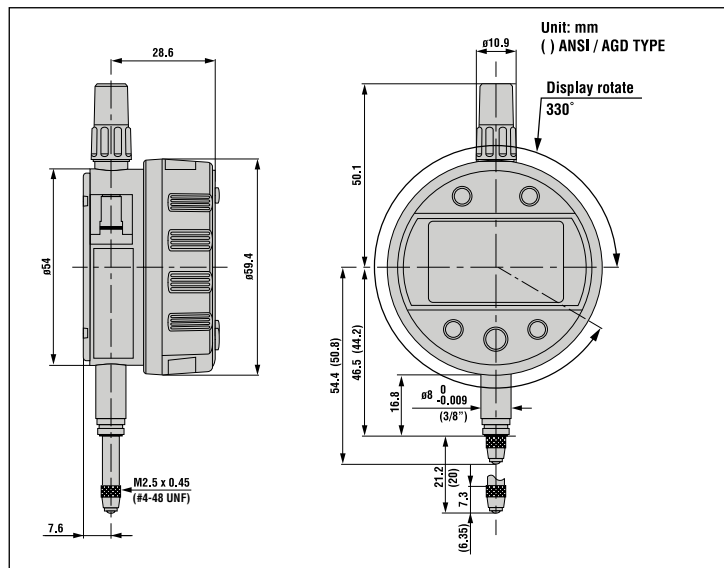

## Technical Data

Accuracy: Refer to the list of specifications  
 Resolution: 0.001-0.01mm or .00005-.0005"/  
 0.001-0.01mm  
 Display: LCD  
 Length standard: ABSOLUTE electrostatic capacitance-type  
 linear encoder  
 Max. response speed: Unlimited  
 Measuring force: 1.5N or less  
 Battery: CR2032 (1 pc.), **05SAA217**  
 Battery life: Approx. 12 months under normal use  
 IP Rating: Equivalent to IP-42<sup>\*1</sup>

<sup>\*1</sup> A protection class indication (IP=International Protection) is based on the IEC 60529 / DIN40050 part 1 / JIS D0207, C0920. The level indicated is valid only if the output connector cap is installed.

## Function

Key Lock, Parameter Lock, PC-USB Input, Analog Bar, Fast measurement frequency, Preset (up to 3 values), Tolerance Judgment, Peak Detection, Calculation (Ax), inch/mm conversion (on inch/metric models only) Counting direction switching, Data Output  
 Alarm: Low voltage, Counting value composition error, Overflow error, Tolerance limit setting error

## Optional Accessories

- 905338:** Connecting Cable (1m)
- 905409:** Connecting Cable (2m)
- 21EZA313:** Parameter Setting USB Cable
- 21EZA198:** Spindle lifting lever (12.7mm ISO/JIS type)
- 21EZA199:** Spindle lifting lever (12.7mm ASME/AGD type)
- 21EZA105:** Lifting Knob (12.7mm/.5" ISO/JIS models)
- 21EZA150:** Lifting Knob (12.7mm/.5" ASME/AGD models)
- 21EZA197:** Lifting Knob (for 25.4/1" mm models)
- 21EZA200:** Lifting Knob (for 50.8/2" mm models)
- 540774:** Spindle lifting cable
- : Backs (See page F-33.)
- : Contact points (See page F-34.)





### Technical Data

Accuracy: Refer to the list of specifications  
 Resolution: 0.001-0.01mm or  
 .00005-.0005"/0.001-0.01mm  
 Display: LCD  
 Length standard: ABSOLUTE electrostatic capacitance type  
 linear encoder  
 Max. response speed: Unlimited  
 Measuring force: 1.5N or less  
 Battery: CR2032 (1 pc.), **055AA217**  
 Battery life: Approx. 12 months under normal use  
 IP Rating: Equivalent to IP-42<sup>\*1</sup>

<sup>\*1</sup> A protection class indication (IP=International Protection) is based on the IEC 60529 /DIN40050 part 1/JIS D0207, C0920. The level indicated is valid only if the output connector cap is installed.

### Function

Key Lock, Parameter Lock, PC-USB Input, Analog Bar, Fast measurement frequency, Preset (up to 3 values), Tolerance Judgment, Peak Detection (Min Only), inch/mm conversion (on inch/metric models only), Data Output  
 Alarm: Low voltage, Counting value composition error, Overflow error, Tolerance limit setting error

### Optional Accessories

**905338:** Connecting Cable (1m)  
**905409:** Connecting Cable (2m)  
**21EZA313:** Parameter Setting USB Cable  
 Applicable Gages Series 511 and 526

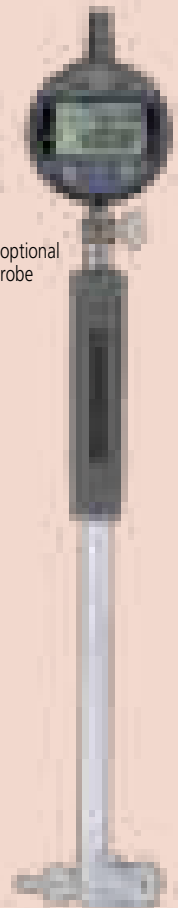

Installed on optional bore gage probe (511-703)

# ABSOLUTE Digimatic Indicator ID-C

## SERIES 543 — Specially Designed for Bore Gage Application

### FEATURES

- The new Bore Gage-Type Digimatic Indicator features both a Key-Lock and Parameter-Lock to prevent accidental changing of settings during operation.
- Parameter setting software makes it easy to set all available parameters. (optional)
- Fast measurement frequency allows the user to increase the number of readings per second from 10 to 50.
- The minimum value holding function provides the easy detection of hole diameter.
- An analog bar indicator is integrated to enhance the intuition in reading.
- Go/no-go judgment is performed by setting the upper and lower tolerances.
- Up to three sets of master values and upper/lower tolerance values can be memorized.
- Employing the ABSOLUTE linear encoder, the ID-C always displays the spindle Absolute Position from the origin when turned on.



543-310B

### SPECIFICATIONS

ISO/JIS type    ANSI/AGD type

Inch/Metric		Stem dia. 3/8" #4-48 UNF Thread			
Resolution	Range	Order No.	Model	Accuracy	Measuring Force
.00005/.0001/.0005" 0.001/0.01mm Selectable	.5"/12.7mm	<b>543-312B</b>	ID-C112GEXB	±.00010"/0.003mm	1.5N or less

Inch/Metric		Stem ø 8mm, M2.5 x 0.45 Thread			
Resolution	Range	Order No.	Model	Accuracy	Measuring Force
.00005/.0001/.0005" 0.001/0.01mm Selectable	.5"/12.7mm	<b>543-311B</b>	ID-C112GMXB	±.00010"/0.003mm	1.5N or less

Metric		Stem ø 8mm, M2.5 x 0.45 Thread			
Resolution	Range	Order No.	Model	Accuracy	Measuring Force
0.001/0.01mm Selectable	12.7mm	<b>543-310B</b>	ID-C112GXB	0.003mm	1.5N or less

### DIMENSIONS

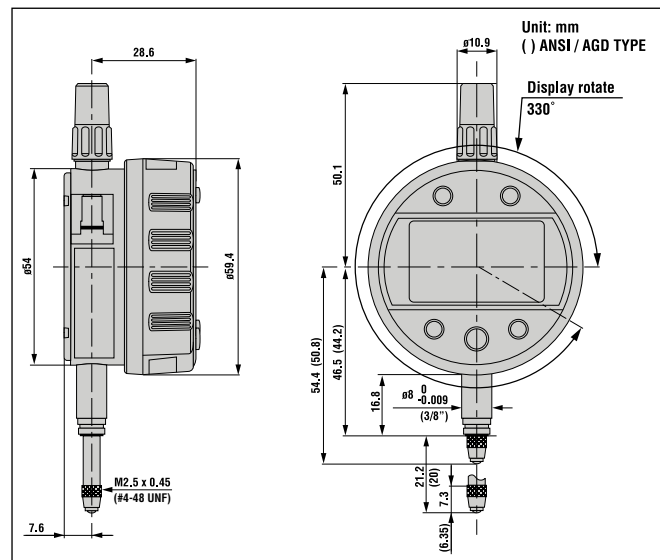

# ABSOLUTE Digimatic Indicator ID-C

SERIES 543 — With Green/Red LED and Go/No-go Signal Output Function

**ABSOLUTE®**  
Absolute System Patented by MITUTOYO



## FEATURES

- With the max./min. value holding function, the signal ID-C can output the go/no-go judgment result against the peak values set. Substitute for the mechanical/electrical contact, the judgment is carried out by calculating the measurement data obtained. This provides high reliability with no deterioration of the contact point and volume adjustment.
- The signal can be output to an external device such as a sequencer through the NPN open-collector.
- The go/no-go judgment result is also indicated by the green/red LED and the "<, O, >" signs on LCD.
- Employing the ABSOLUTE linear encoder, the Signal ID-C always displays the spindle Absolute Position from the origin when powered up.
- The Signal ID-C achieves the IP54 protection level to resist dust and contaminants for safe operation in harsh machine shop environments.
- The high-speed detector measures 100 times per second.
- Analog Bar



## SPECIFICATIONS

Inch/Metric		Stem dia. 3/8" #4-48 UNF Thread		ISO/JIS type	ANSI/AGD type
Resolution	Range	Order No. (w/ lug, flat-back)	Model	Accuracy	Measuring force
.00005/.0001/.0005" 0.001/0.01mm	.5" / 12.7mm	<b>543-352</b> <b>543-352B</b>	ID-C112JEX(B)	±.00010/0.003mm	2.5N or less

Inch/Metric		Stem ø 8mm, M2.5 x 0.45 Thread		ISO/JIS type	ANSI/AGD type
Resolution	Range	Order No. (w/ lug, flat-back)	Model	Accuracy	Measuring force
.00005/.0001/.0005" 0.001/0.01mm	.5" / 12.7mm	<b>543-351</b> <b>543-351B</b>	ID-C112JMX(B)	±.00010/0.003mm	2.5N or less

Metric		Stem ø 8mm, M2. x 0.45 Thread		ISO/JIS type	ANSI/AGD type
Resolution	Range	Order No. (w/ lug, flat-back)	Model	Accuracy	Measuring force
0.001/0.01mm	12.7mm	<b>543-350</b> <b>543-350B</b>	ID-C112JX(B)	0.003mm	2.5N or less

## DIMENSIONS

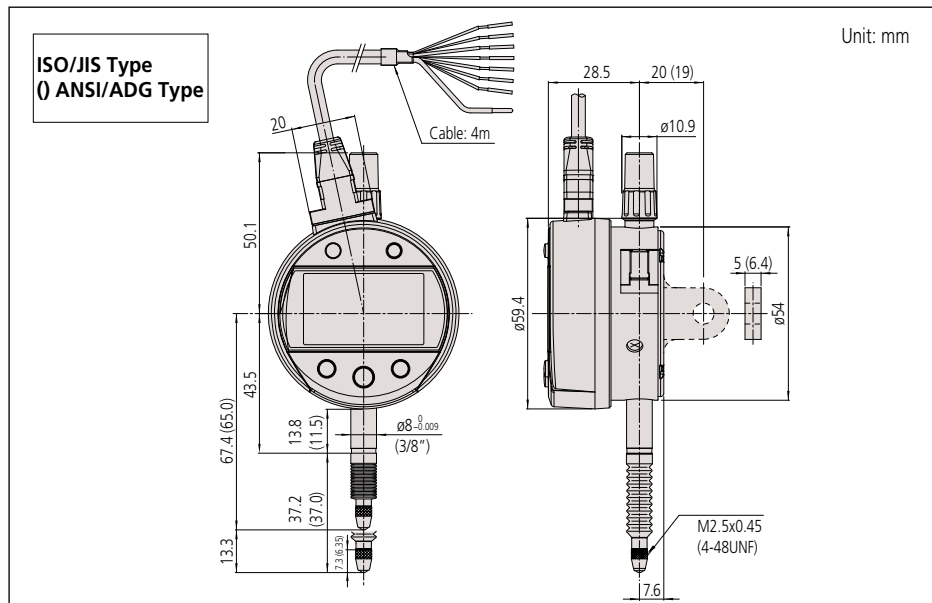

## Technical Data

Accuracy: Refer to the list of specifications  
 Resolution: 0.001mm, .00005"/0.001mm  
 Display: LCD  
 Length standard: ABSOLUTE electrostatic capacitance type linear encoder  
 Max. response speed: Unlimited  
 Measuring force: 2.5N or less  
 Power supply: DC 5-24V±10%  
 Dust/Water protection level: IP54

## Function

Data output (-NG/OK/NG signal, NPN open collector), Remote control (hold-preset, preset-recall, zero-set), Origin-Set, Preset (up to 3 values), Zero-Set, Analog-Bar, go/no-go judgment, Max/Min/Runout value holding, Counting direction switching, Power ON/OFF, inch/mm conversion (on inch/metric models only), calibration mode

Internal calculations using the simple formula of  $[F(x) = Ax]$  are available.

Alarm: Low voltage, Counting value composition error, Overflow error, Tolerance limit setting error

## Optional Accessories

- 902011:** Spindle lifting lever\* (ISO/JIS type)
- 902794:** Spindle lifting lever\* (ANSI/AGD type)
- 540774:** Spindle lifting cable\* (Stroke: .4" / 10mm)
- 125317:** Rubber boot
- Backs (See page F-33.)
- Contact points (See page F-34.)

- 21EAA194:** Connecting Cable (1m)\*\*
- 21EAA190:** Connecting Cable (2m)\*\*
- 21EZA345A:** Digimatic Power Supply Unit\*\*

\*When using the spindle lifting lever/cable, IP54 is not guaranteed.  
 \*\* Used only for calibration mode and for automated testing with an i-Checker

## Output pattern

Wire	- NG	OK	+ NG	Composition error
Orange (- NG)	Low	High	High	High
Green (OK)	High	Low	High	High
Brown (+ NG)	High	High	Low	High
LED	Red	Green	Red	Red (blinking)
LCD	<	O	>	"x.xx" indication

## I/O Specifications

Wire	Signal	I/O	Description
Black	- V (GND)	—	Connected to minus (-) terminal
Red	+ V (GND)	I	Power supply (5-24VDC)
Orange	- NG	O	Tolerance judgment result output: Only the terminal corresponding to a judgment result is set to the below level.
Green	OK	O	
Brown	+ NG	O	
Yellow	PRESET_REC-ALL ZERO	I	External input terminal: If the relevant terminal is set to the low level, its signal becomes true.
Blue	PEAK_START	I	
Shield	FG	—	Connected to GND

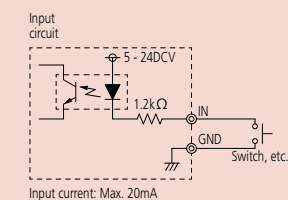
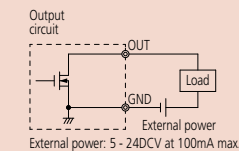



### Technical Data

Accuracy: Refer to the list of specifications  
 Resolution: 0.0005mm/0.001mm or .00002"/.00005"  
 /.0001"/0.0005mm/0.001mm  
 Display: LCD  
 Length standard: Linear encoder  
 Max. response speed: 1000mm/s  
 Measuring force: 2.0N/2.5N\* or less (\*60mm range models)  
 Power supply: 6V DC (via AC adaptor)

### Function

Origin-set/Preset, Zeroset, go/no-go judgment, Max/Min value hold, Runout measurement, Resolution switching, Counting direction switching, Power ON/OFF, Data output, inch/mm conversion (on inch/metric models only)  
 Alarm: Low voltage, Counting value composition error, Overflow error, Tolerance limit setting error

### Standard Accessories

06AEG180JA: AC Adapter 120v  
 137693: Lifting Lever

### Optional Accessories

936937: SPC cable (40" / 1m)  
 965014: SPC cable (80" / 2m)  
 21EAA131: RS-232C cable (80" / 2m)  
 21EZA099: Remote controller  
 540774: Spindle lifting cable (stroke: .4" / 10mm)  
 21EZA101: Spindle lifting knob  
 264-504-5A: Digimatic Min-processor DP-1VR  
 21EZA152A: FREE PARAMETER SETTING SOFTWARE  
 —: Backs (See page F-33.)  
 —: Contact points (See page F-34.)

### Application

#### Difference/Runout measurement

#### Example: Indicator travel from points A to D

Difference (or Total Runout) is displayed as A. Dimensions B (maximum value) and C (minimum value) can be recalled from memory with a simple key sequence.

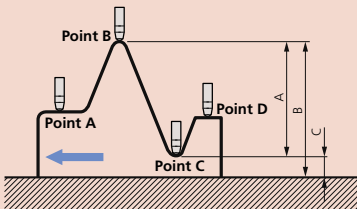

Order No.	A	B	C	D	E
543-561A	251.3	47.3	30.48	60	7.3
543-562A	250.35	46.35	30.48	60	6.35
543-563A	311.3	77.3	60.96	90	7.3
543-564A	310.35	76.35	60.96	90	6.35

# Digimatic Indicator ID-H

## SERIES 543 — High-Accuracy and High-Functional Type

### FEATURES

- This new generation digital indicator offers the excellent accuracy and functionality expected from this class of indicator. Take advantage of its high accuracy backed by 0.5µm / .00002" resolution, remote control functionality via a handheld controller (or an RS-232C interface) and easy runout measurements with the analog bar display.
- The maximum, minimum, or runout value can be displayed during measurement.
- Go/no-go judgment is performed by setting the upper and lower tolerances. If a judgment result is out of tolerance, the display backlighting changes from green to red, so tolerance judgment can be made at a glance.
- With SPC data output.
- With RS-232C input/output.



### SPECIFICATIONS

**Inch/Metric** Stem dia. 3/8" #4-48 UNF Thread

Resolution	Range	Order No.	Model	Accuracy
.00002", .00005", .0001", 0.0005mm, 0.001mm	1.2" / 30.4mm	543-562A	ID-H530E	0.0015mm
	2.4" / 60.9mm	543-564A	ID-H560E	0.0025mm

**Metric** Stem ø 8mm M2.5 X 0.45 Thread

Resolution	Range	Order No.	Model	Accuracy
0.0005mm, 0.001mm	30.4mm	543-561A	ID-H530	0.0015mm
	60.9mm	543-563A	ID-H560	0.0025mm

### DIMENSIONS

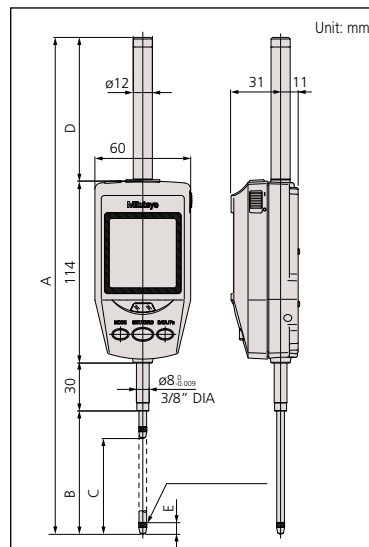

Tolerance judgment

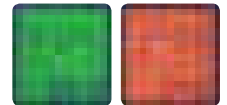

Analog bar display



Max/Min value measurement



Runout measurement



Resolution switching



# ABSOLUTE Digimatic Indicator ID-F

SERIES 543 — With Back-lit LCD



## FEATURES

- With ABSOLUTE linear encoder technology, once the measurement reference point has been set it, will not be lost when the power is turned on.
- Go/no-go judgment is performed by setting the upper and lower tolerances. If a judgment result is out of tolerance, the display backlighting changes from green to red, so tolerance judgment can be made at a glance.
- The maximum, minimum, or runout value can be displayed during measurement.
- An analog bar indicator has been integrated to handle upper/lower limit approaching and zero approaching. The display range can be changed.
- With SPC data output.

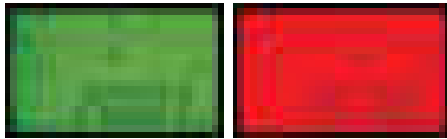

## SPECIFICATIONS

**Inch/Metric** Stem dia. 3/8" #4-48 UNF Thread

Resolution	Range	Order No.	Model	Accuracy
.00005", .0001", .0005", .001", 0.001mm, 0.01mm	1" / 25.4mm	<b>543-552A</b>	ID-F125E	.00012"
	2" / 50.8mm	<b>543-558A</b>	ID-F150HE	.00012"

**Metric** Stem ø 8mm M2.5 X 0.45 Thread

Resolution	Range	Order No.	Model	Accuracy
0.001mm, 0.01mm	25mm	<b>543-551A</b>	ID-F125	0.003mm
	50mm	<b>543-557A</b>	ID-F150H	0.003mm

## DIMENSIONS

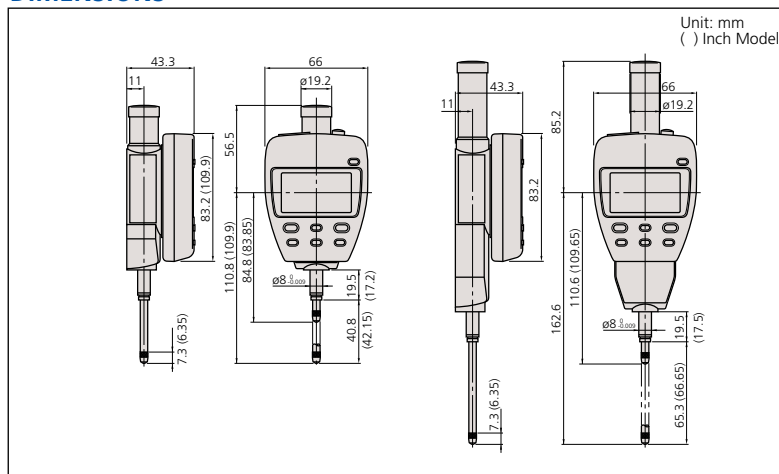

## Technical Data

Accuracy: Refer to the list of specifications  
 Resolution: 0.01mm/0.001mm or .00005"/.0001"/.0005"/.001"/.001mm/0.01mm  
 Display: LCD  
 Length standard: ABSOLUTE electrostatic capacitance type linear encoder  
 Max. response speed: Unlimited  
 Measuring force: 1.8N/2.3N\* or less (\*50mm range models)  
 Power supply: 9V DC (via AC adaptor)

## Function

Origin-set/Preset, Zeroset, Go/no-go judgment, Max/Min value hold, Runout measurement, Resolution switching, Counting direction switching, Power ON/OFF, Data output, inch/mm conversion (on inch/metric models only)  
 Alarm: Low voltage, Counting value composition error, Overflow error, Tolerance limit setting error

## Standard Accessories

**06AEG302JA**: AC Adapter 120v  
**137693**: Lifting Level

## Optional Accessories

**936937**: SPC cable (40" / 1m)  
**965014**: SPC cable (80" / 2m)  
**540774**: Spindle lifting cable (stroke: .4" / 10mm)  
**02ACA571**: Auxiliary spindle spring for 25mm/1" models\*  
**02ACA773**: Auxiliary spindle spring for 50mm/2" models\*  
**264-504-5A**: Digimatic Min-processor DP-1VR  
**543-004-1**: Digimatic presetter  
 ———: Backs (See page F-33.)  
 ———: (See page F-34.)

\*Required when orienting the indicator upside down.

## Application

### Difference/Runout measurement

**Example: Indicator travel from points A to D**

Difference (or Total Runout) is displayed as A. Dimensions B (maximum value) and C (minimum value) can be recalled from memory with a simple key sequence.

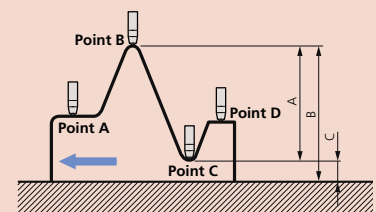

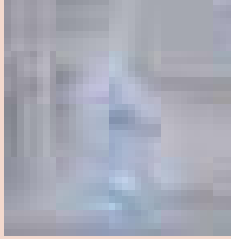

**Technical Data**

Accuracy: Refer to the list of specifications  
 Resolution: 0.01mm, 0.01mm/0.001mm, .0005"/0.01mm or .0005"/0.0005"/0.01mm/0.001mm  
 Display: LCD  
 Length standard: ABSOLUTE electrostatic capacitance-type linear encoder  
 Max. response speed: Unlimited  
 Measuring force: 2.5N (2.0N: Back plunger type)  
 Battery: SR44 (1 pc.), **938882**  
 Battery life: Approx. 7000 hours under normal use  
 Dust/Water protection level: IP66

**Function**

Zero-setting, Presetting, Direction switching, Tolerance judgment, Display hold, Data output, inch/mm conversion (on inch/metric models only)  
 Alarm: Low voltage, Counting value composition error, Overflow error, Tolerance limit setting error

**Optional Accessories**

- 21EZA105:** Lifting knob (for ISO/JIS model, ID-N only)
- 21EZA150:** Lifting knob (for AGD model, ID-N only)
- 21EZA145:** Lug (for JIS/ISO model)
- 21EZA146:** Lug (for AGD model)
- 02ACA376:** Rubber boot (for ID-N, NBR)
- 238774:** Rubber boot (for ID-N, silicon)
- 125317:** Rubber boot (for ID-B, NBR)
- 21EAA212:** Rubber boot (for ID-B, silicon)
- 21EAA194:** SPC cable (40" / 1m)
- 21EAA190:** SPC cable (80" / 2m)
- 21EAA210:** Bifurcated connecting cable with zero-setting terminal (40" / 1m)
- 21EAA211:** Bifurcated connecting cable with zero-setting terminal (80" / 2m)
- : Contact points (See page F-34.)

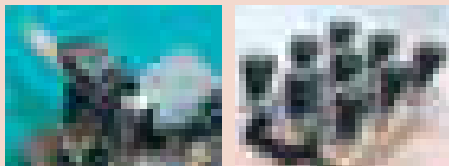

# ABSOLUTE Digimatic Indicator ID-N / B

**SERIES 543 — With Dust/Water Protection Conforming to IP66**

**FEATURES**

- Proven ABSOLUTE sensor.
- Rated to IP66 water- and dust-proofing standard, and oil resistance improved.
- Slim body design is advantageous for multi-point measurements.
- Improvement in workability with the LCD readout-rotation function.
- Back plunger design (ID-B).
- Built-in tolerance judgment function.
- Switchable resolution.
- Waterproof data output connector.
- Built-in hold/preset function.

Slim type ID-N  
**543-576**



Back plunger type ID-B  
**543-586**



**ID-B Digimatic Indicators**

**SPECIFICATIONS**

Metric		Stem ø 8mm M2.5 X 0.45 Thread			
Resolution	Range	Order No.	Model No.	Accuracy	Measuring Force
0.01mm	5.0mm	<b>543-580</b>	ID-B1005	0.02mm	2.0N or less
0.001mm	5.0mm	<b>543-585</b>	ID-B105	0.003mm	2.0N or less

Inch / Metric		Stem dia. 3/8" #4-48 UNF Thread			
Resolution	Range	Order No.	Model No.	Accuracy	Measuring Force
.0005" / 0.01mm	.22" / 5.6mm	<b>543-581</b>	ID-B1005E	.0008" / 0.02mm	2.0N or less
.0005" / 0.01mm .00005" / 0.001mm	.22" / 5.6mm	<b>543-586*</b>	ID-B105E	.00012" / 0.003mm	2.0N or less

\* Switchable resolution

**ID-N Digimatic Indicators**

Metric		Stem ø 8mm M2.5 X 0.45 Thread			
Resolution	Range	Order No.	Model No.	Accuracy	Measuring Force
0.01mm	5.0mm	<b>543-570</b>	ID-N1012	0.02mm	2.0N or less
0.001mm / 0.01mm	5.0mm	<b>543-575</b>	ID-N112	0.003mm	2.0N or less

Inch / Metric		Stem dia. 3/8" #4-48 UNF Thread			
Resolution	Range	Order No.	Model No.	Accuracy	Measuring Force
.0005" / 0.01mm	.5" / 12.7mm	<b>543-571</b>	ID-N1012E	.0008" / 0.02mm	2.0N or less
.0005" / 0.01mm .00005" / 0.001mm	.5" / 12.7mm	<b>543-576*</b>	ID-N112E	.00012" / 0.003mm	2.0N or less

\* Switchable resolution

**DIMENSIONS AND MASS**

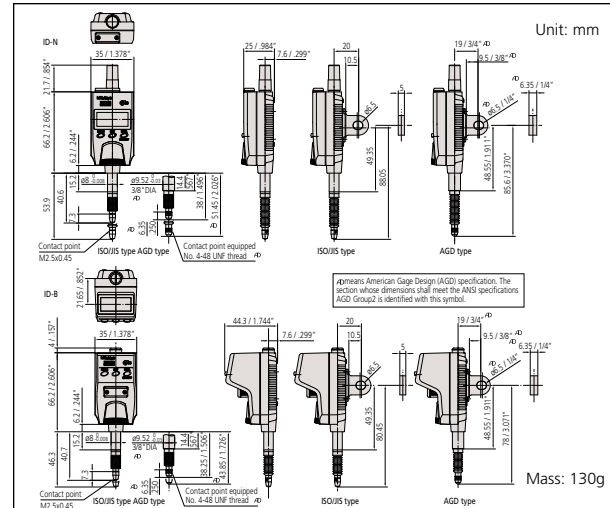

# EC Counter

## SERIES 542 — Low-Cost, Assembly-Type Display Unit

### FEATURES

- Employed the DIN size (96 X 48mm) and mount-on-panel configuration, which greatly facilitates the incorporation into a system.
- Possible to produce either tolerance judgment output or Digimatic output.



542-007A

### SPECIFICATIONS

Order No.	Description
542-007A	EC Counter

### DIMENSIONS

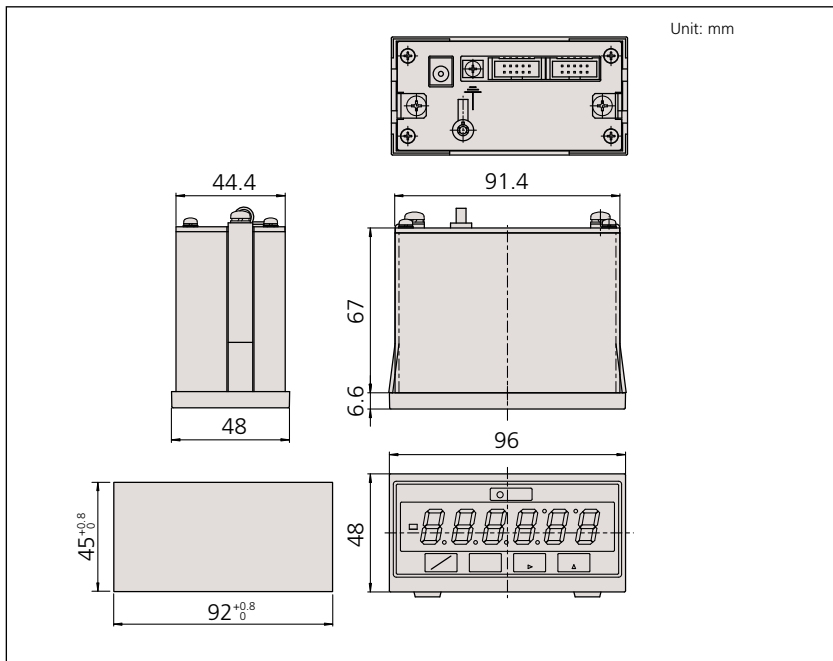

### EC Counter

#### Technical Data

Applicable gage: LGD, LGS, All SPC output gages  
 Resolution: 0.001mm, 0.01mm, .00005, .0005", .0001"  
 No. of gage input: 1  
 Display: 6-digit LED and a negative [-] sign  
 Function: Preset  
           Go/no-go judgment  
 Output (open-collector): 3-Step limit signal\*, Digimatic  
 External control: Preset, Data hold  
 Power supply: Via AC adaptor  
 Dimensions (W x D x H): 96 x 48 x 84.6mm  
 Mass: 500g  
 \*Requires C162-155 (see Optional Accessories)

#### Standard Accessories

**06AEG302JA:** AC Adaptor

#### Optional Accessories

**936937:** SPC cable (40"/1m)  
**965014:** SPC cable (80"/1m)  
**214938:** PJ-2 (DC Plug)  
**C162-155:** Go/no-go judgment cable

# Dial Indicators

## Description of Icon

Icon	Description
	Reverse reading type suitable for depth and step measurement
	One revolution type for easy and error-free reading
	Double scale spacing type, easy to read
	Shockproof
	Waterproof
	With damper at lowest rest point
	Jeweled bearing
	Peak retaining
	Long stem
	Dustproof
	With coaxial revolution counter
	Back plunger
	Adjustable hand
	Double-face type

## FEATURES: S Series

- Revolutionary stem-bush design for trouble-free stem clamping (longer clamping range).
- No through screw hole on the frame for high dust-resistance.
- Involute curved lifting lever for smooth movement of spindle and dovetail joint for tool-less connection.
- Grater rigidity in the bearing plate for reducing the retracing error (20%) and 4-screw mounting for increasing impact resistance.

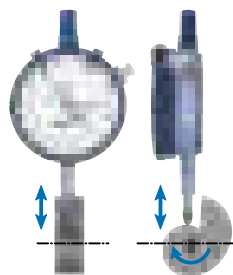
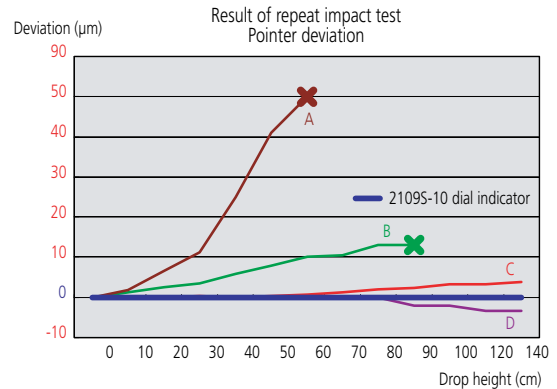
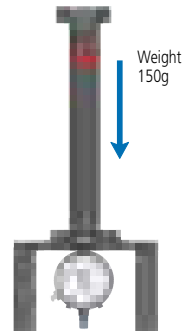
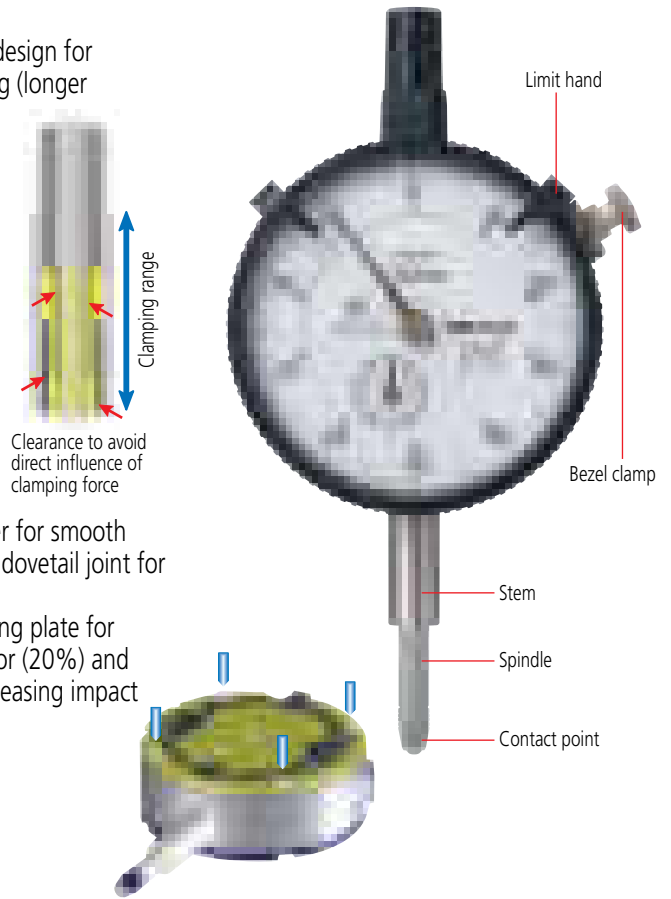

Endurance testing with cam  
Rotation speed: 120rpm

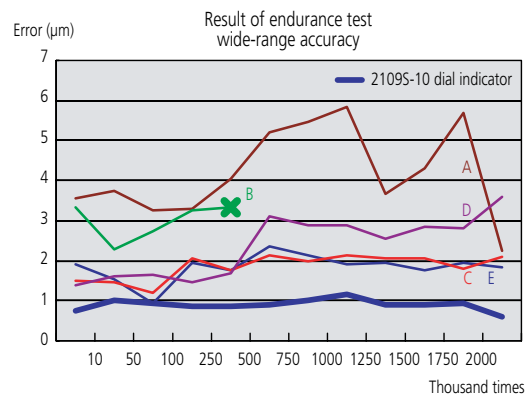

# Dial Indicators

## SERIES 0 - Compact type

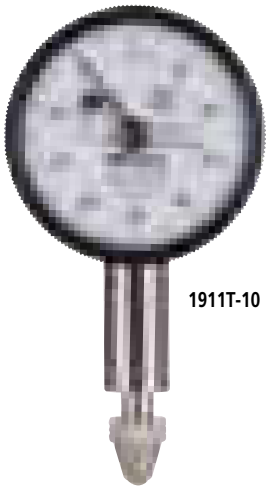

1911T-10

 **Balanced scale**

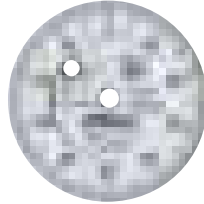

1911T-10

 **Jeweled bearing**

 **Balanced scale**





1913T-10

 **Jeweled bearing**

### SPECIFICATIONS

**Inch** Stem dia. 3/8", #4-48 UNF Thread  ANSI/AGD type

Graduation	Range	Range/rev	Dial reading	Order No.		Accuracy		Measuring force	
				w/ lug	Flat-back	First 2.5 Rev	Overall Accuracy		
.0001"	.025"	.01"	0-5-0	<b>1925T-10</b>	<b>1925TB-10</b>	±.0002"	±.0002"	0.3 - 1.8N	✓
.0005"	.05"	.02"	0-10-0	<b>1923T-10</b>	<b>1923TB-10</b>	±.0005"	±.0005"	0.3 - 1.8N	✓
.001"	.1"	.04"	0-20-0	<b>1921T-10</b>	<b>1921TB-10</b>	±.001"	±.001"	0.3 - 1.8N	✓

**Metric** Stem ø 8mm, M2.5 x 0.45 Thread  ISO/JIS type

Graduation	Range	Range/Rev	Dial reading	Order No.		Accuracy		Measuring force	
				w/ lug	Flat-back	Any Rev	Overall Accuracy		
0.002mm	0.5mm	0.2mm	0-100-0	<b>1913T-10</b>	<b>1913TB-10</b>	±5µm	±6µm	0.3 - 1.8N	✓
0.01mm	2.5mm	1mm	0-50-0	<b>1911T-10</b>	<b>1911TB-10</b>	±10µm	±12µm	0.3 - 1.8N	✓

 Jeweled bearing

### DIMENSIONS

**Inch Model** Unit: Inch

Order Number	A	B
1925T-10	1.48"	.28"
1923T-10	1.51"	.31"
1921T-10	1.58"	.37"

**Metric Model** Unit: mm

Order Number	A	B
1911T-10	42	11.5
1913T-10	39.5	9



# Dial Indicators

## SERIES 1



1803S-10



1411S



1506S

### SPECIFICATIONS

**Inch** Stem dia. 3/8" #4-48 UNF Thread ANSI/AGD type

Graduation	Range	Range / Rev	Dial reading	Order No.		Accuracy		Measuring force	Shockproof	Jeweled bearing
				(W/Lug)	(Flat-back)	First 2.5 Rev	Overall Accuracy			
.0001"	.025"	.01"	0-10	<b>1802S-10</b>	<b>1802SB-10</b>	±.0001"	±.0001"	1.4N or less	✓	✓
.0001"	.025"	.01"	0-5-0	<b>1803S-10</b>	<b>1803SB-10</b>	±.0001"	±.0001"	1.4N or less	✓	✓
.0005"	.1"	.04"	0-40	<b>1670S</b>	<b>1670SB</b>	±.0005"	±.0005"	1.4N or less		
.0005"	.1"	.04"	0-20-0	<b>1671S</b>	<b>1671SB</b>	±.0005"	±.0005"	1.4N or less		
.0005"	.125"	.05"	0-50	<b>1506S</b>	<b>1506SB</b>	±.0005"	±.0005"	1.4N or less		
.0005"	.125"	.05"	0-25-0	<b>1507S</b>	<b>1507SB</b>	±.0005"	±.0005"	1.4N or less		
.001"	.125"	.05"	0-50	<b>1780S</b>	<b>1780SB</b>	±.001"	±.001"	1.4N or less		
.001"	.125"	.025"	0-25-0	<b>1781S</b>	<b>1781SB</b>	±.001"	±.001"	1.4N or less		
.001"	.25"	.1"	0-100	<b>1410S</b>	<b>1410SB</b>	±.001"	±.001"	1.4N or less		
.001"	.25"	.1"	0-100	<b>1410S-10</b>	<b>1410SB-10</b>	±.001"	±.001"	1.4N or less		✓
.001"	.25"	.1"	0-50-0	<b>1411S</b>	<b>1411SB</b>	±.001"	±.001"	1.4N or less		



Shockproof



Jeweled bearing

**Metric** Metric - ANSI Standard Stem dia. 3/8" #4-48 UNF Thread yellow dial face ANSI/AGD type

Graduation	Range	Range / Rev	Dial reading	Order No.		Accuracy		Measuring force
				(W/Lug)	(Flat-back)	First 2.5 Rev	Overall Accuracy	
0.002mm	0.5mm	0.2mm	0-20	<b>1010S-11</b>	<b>1010SB-11</b>	±0.002mm	±0.002mm	1.5N or less
0.002mm	0.5mm	0.2mm	0-10-0	<b>1011S-11</b>	<b>1011SB-11</b>	±0.002mm	±0.002mm	1.5N or less
0.01mm	2.5mm	1mm	0-100	<b>1230S-01</b>	<b>1230SB-01</b>	±0.01mm	-	1.4N or less
0.01mm	2.5mm	1mm	0-50-0	<b>1231S-01</b>	<b>1231SB-01</b>	±0.01mm	-	1.4N or less
0.01mm	5mm	1mm	0-100	<b>1044S-01</b>	<b>1044SB-01</b>	±0.01mm	±0.013mm	1.4N or less
0.01mm	5mm	1mm	0-50-0	<b>1045S-01</b>	<b>1045SB-01</b>	±0.01mm	±0.013mm	1.4N or less

### DIMENSIONS

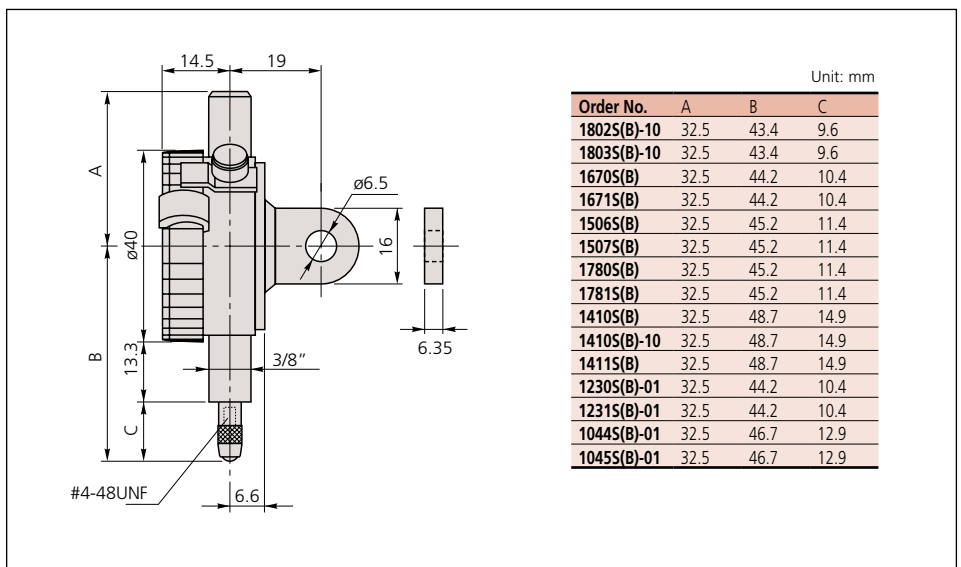

# Dial Indicators

## SERIES 1

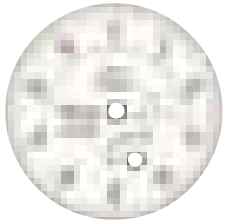

1040S

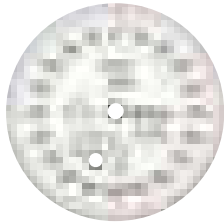

1013S



1045S



1109S-10

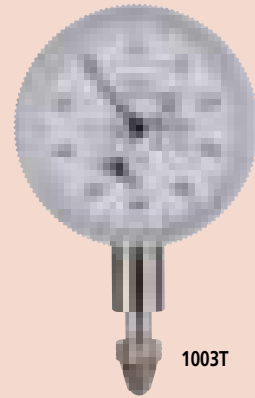

1003T



1044S

Metric										ISO/JIS type		
Stem $\phi$ 8mm M2.5 X 0.45 Thread												
Graduation	Range	Range / Rev	Dial reading	Order No.		Accuracy		Measuring force	S	W	D	
				(W/Lug)	(Flat-back)	First 2.5 Rev	Overall Accuracy					
0.001mm	1mm	0.2mm	0-100-0	<b>1109S-10</b>	<b>1109SB-10</b>	$\pm 0.001$ mm	$\pm 0.007$ mm	1.5N or less	✓		✓	
0.002mm	1mm	0.2mm	0-100-0	<b>1013S-10</b>	<b>1013SB-10</b>	$\pm 0.002$ mm	$\pm 0.01$ mm	1.5N or less	✓		✓	
0.005mm	3.5mm	0.5mm	0-50	<b>1124S</b>	<b>1124SB</b>	$\pm 0.005$ mm	$\pm 0.013$ mm	1.4N or less			✓	
0.01mm	3.5mm	0.5mm	0-50	<b>1040S</b>	<b>1040SB</b>	$\pm 0.01$ mm	$\pm 0.013$ mm	1.5N or less				
0.01mm	3.5mm	0.5mm	0-25-0	<b>1041S</b>	<b>1041SB</b>	$\pm 0.01$ mm	$\pm 0.013$ mm	1.5N or less				
0.01mm	4mm	1mm	0-50-0	<b>1003T</b>	<b>1003TB</b>	$\pm 0.01$ mm	$\pm 0.013$ mm	0.3 - 1.4N				
0.01mm	5mm	1mm	0-100	<b>1044S</b>	<b>1044SB</b>	$\pm 0.01$ mm	$\pm 0.013$ mm	1.5N or less				
0.01mm	5mm	1mm	0-100	<b>1044S-60</b>	<b>1044SB-60</b>	$\pm 0.01$ mm	$\pm 0.013$ mm	2N or less		✓		
0.01mm	5mm	1mm	0-100	<b>1044S-15</b>	<b>1044SB-15</b>	$\pm 0.01$ mm	$\pm 0.013$ mm	.4N or less	✓			
0.01mm	5mm	1mm	0-50-0	<b>1045S</b>	<b>1045SB</b>	$\pm 0.01$ mm	$\pm 0.013$ mm	1.4N or less				

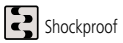

Shockproof



Waterproof



Jeweled bearing

## DIMENSIONS

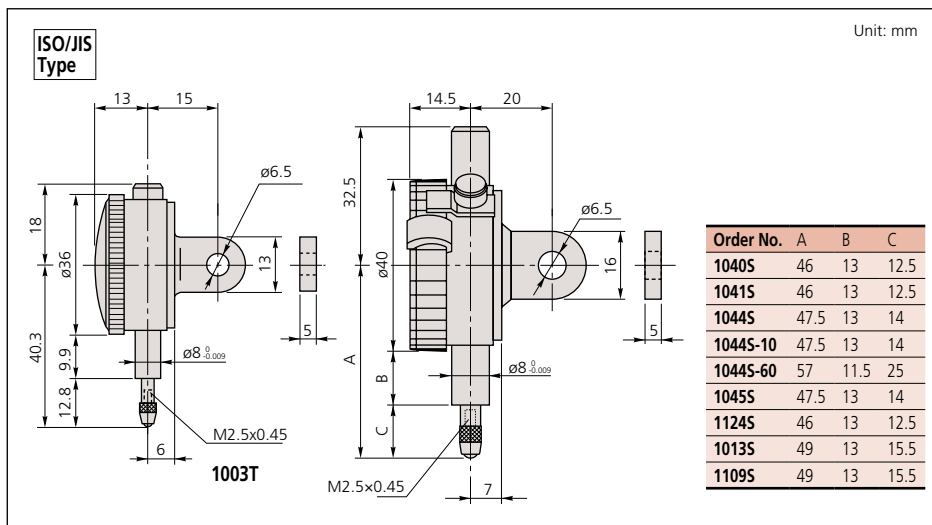

## Optional Accessories

- : Backs (See page F-33.)
- : Contact points (See page F-34.)



# Dial Indicators

## SERIES 1 — Compact One Revolution Type for Error-free Reading



One revolution type



1929S  
1929S-62



1900S-10  
1900S-72



1929S

Unlike many other dial indicators, the one-revolution dial indicator shows the entire spindle travel or range as one sweep of the hand, eliminating the possibility of reading errors due to miscounting the multiple revolutions. With one-revolution dial indicators, within tolerance and out of tolerance can't be misinterpreted. Unique shock-proof mechanism provides improved immunity to shock due to sudden spindle retraction caused by high impact.



Shockproof type



Dustproof type



Waterproof type



Jeweled bearing type

### SPECIFICATIONS

**Inch**

Stem dia. 3/8", #4-48 UNF Thread

ANSI/AGD type

Graduation	Range (range/full stroke)	Dial reading	Order No.		Accuracy	Measuring force			<input type="checkbox"/>	
			w/lug	Flat-back						
.0001"	.006" / .0079"	3-0-3	<b>1910S-72</b>	<b>1910SB-72</b>	±.0001"	1.4N or less	✓	✓	<input type="checkbox"/>	<input type="checkbox"/>
.0005"	.04" / .055"	20-0-20	<b>1909S-62</b>	<b>1909SB-62</b>	±.0005"	1.4N or less	✓	✓	<input type="checkbox"/>	<input type="checkbox"/>

**Metric**

Stem ø 8mm, M2.5 x 0.45 Thread

ISO/JIS type

Graduation	Range (range/full stroke)	Dial reading	Order No.		Accuracy	Measuring force			<input type="checkbox"/>	
			w/lug	Flat-back						
0.001mm	0.1mm / 0.14mm	50-0-50	<b>1900S-10</b>	<b>1900SB-10</b>	±0.005mm	1.5N or less	✓	—	<input type="checkbox"/>	✓
0.001mm	0.1mm / 0.14mm	50-0-50	<b>1900S-72</b>	<b>1900SB-72</b>	±0.006mm	1.5N or less	✓	✓	<input type="checkbox"/>	✓
0.01mm	1mm / 1.4mm	50-0-50	<b>1929S</b>	<b>1929SB</b>	±0.011mm	1.4N or less	✓	—	<input type="checkbox"/>	—
0.01mm	1mm / 1.4mm	50-0-50	<b>1929S-62</b>	<b>1929SB-62</b>	±0.011mm	1.4N or less	✓	✓	<input type="checkbox"/>	—

### Optional Accessories

- : Backs (See page F-33.)
- : Contact points (See page F-34.)

### DIMENSIONS

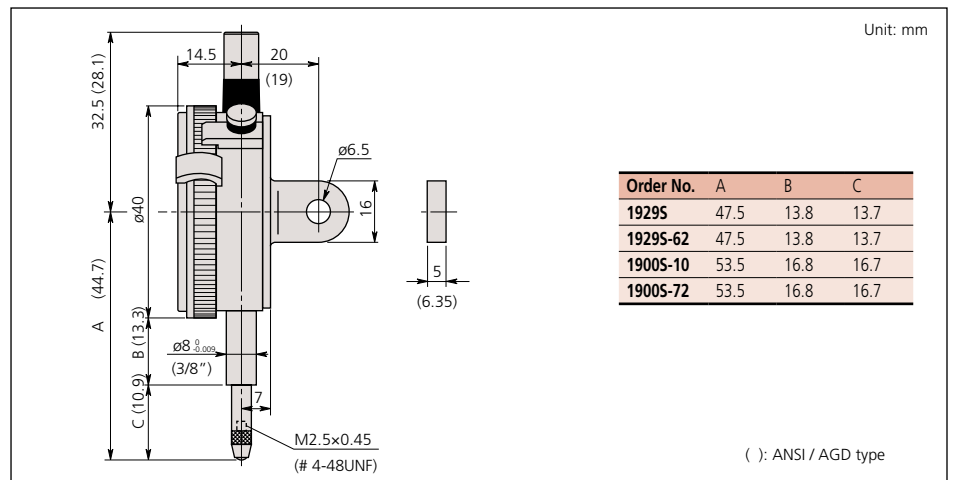

# Dial Indicators

## SERIES 2 — Standard One Revolution Type for Error-free Reading



One revolution type.

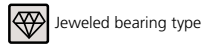
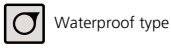

### SPECIFICATIONS

**Metric** Stem  $\phi$  8mm, M2.5 x 0.45 Thread ISO/JIS type

Graduation	Range (range/full stroke)	Dial reading	Order No.		Accuracy	Measuring force	Shockproof	Waterproof	Dustproof	Jeweled bearing
			w/ lug	Flat-back						
0.001mm	0.08mm / 0.1mm	40-0-40	<b>29005-10</b>	<b>29005B-10</b>	$\pm 0.003$ mm	1.4N or less	✓	—	—	✓
0.001mm	0.08mm / 0.1mm	40-0-40	<b>29005-70</b>	<b>29005B-70</b>	$\pm 0.003$ mm	2.0N or less	✓	✓	—	✓
0.001mm	0.08mm / 0.1mm	40-0-40	<b>29005-72</b>	<b>29005B-72</b>	$\pm 0.003$ mm	2.0N or less	✓	—	✓	✓
0.001mm	0.16mm / 0.2mm	80-0-80	<b>29015-10</b>	<b>29015B-10</b>	$\pm 0.004$ mm	1.4N or less	✓	—	—	✓
0.01mm	0.8mm / 1mm	40-0-40	<b>29295</b>	<b>29295B</b>	$\pm 0.009$ mm	2.0N or less	✓	—	—	—
0.01mm	0.8mm / 1mm	40-0-40	<b>29295-60</b>	<b>29295B-60</b>	$\pm 0.009$ mm	2.0N or less	✓	✓	—	—
0.01mm	0.8mm / 1mm	40-0-40	<b>29295-62</b>	<b>29295B-62</b>	$\pm 0.009$ mm	2.0N or less	✓	—	✓	—
0.01mm	1.6mm / 2mm	80-0-80	<b>29595</b>	<b>29595B</b>	$\pm 0.013$ mm	1.4N or less	✓	—	—	—
0.01mm	0.5mm / 0.7mm	25-0-25	—	<b>2971TB*</b>	$\pm 0.008$ mm	0.4 - 1.4N	✓	—	✓	—
0.01mm	1mm / 1.4mm	50-0-50	—	<b>2972TB*</b>	$\pm 0.008$ mm	0.4 - 1.4N	✓	—	✓	—
0.02mm	1.6mm / 2mm	80-0-80	—	<b>2973TB*</b>	$\pm 0.016$ mm	0.4 - 1.4N	✓	—	✓	—
0.1mm	4mm / 10mm	2-0-2	<b>29285</b>	<b>29285B</b>	$\pm 0.040$ mm	1.4N or less	✓	—	—	—

\* Flat-back type only. (Lug-on-center back is not available.)

### DIMENSIONS

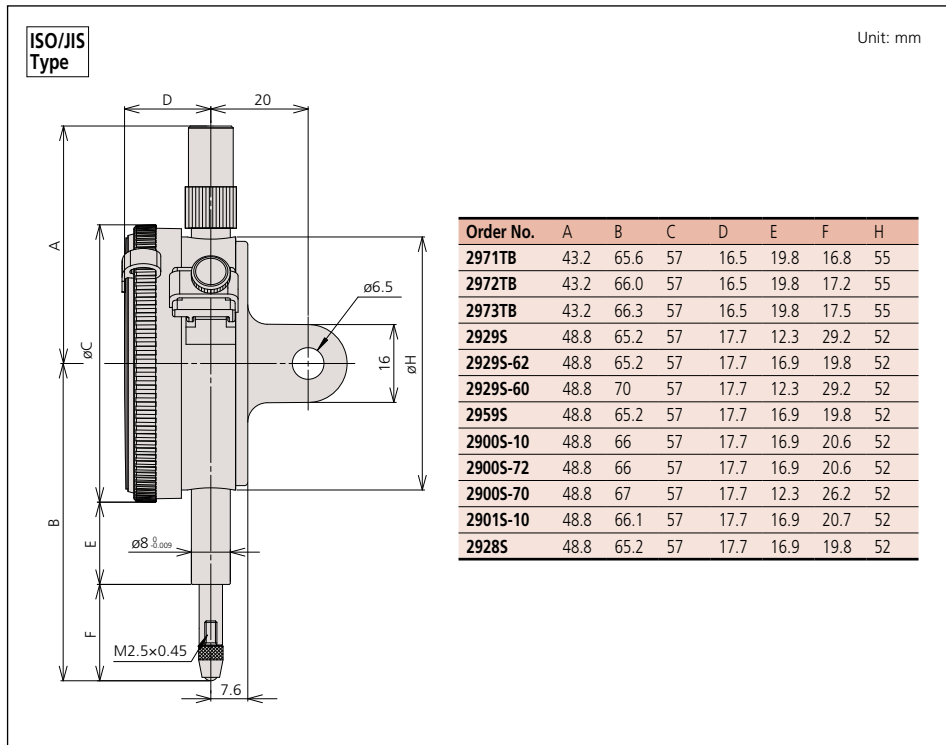

29005-10



29295  
29295-60  
29295-62



29595



29005-10  
29005-70  
29005-72

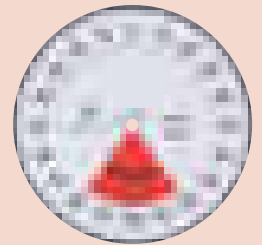

29015-10

### Optional Accessories

- : Backs (See page F-33.)
- : Contact points (See page F-34.)



# Dial Indicators

## SERIES 2 — Standard One Revolution Type for Error-free Reading

### FEATURES

- Unique shock-proof mechanism provides improved immunity to shock due to sudden spindle retraction caused by high impact.
- The crystal is hard coated for durability and scratch resistance.
- Approximately 40% lighter than conventional dial indicator.
- Improved resistance to shop-floor contaminants such as water and dust.
- Due to the spindle bushing being offset from the stem, spindle movement will not be hindered or jammed when clamping along the stem.
- A pair of limit hands are provided for quick and easy tolerance judgment (go/no-go).



One revolution type.

### SPECIFICATIONS

**Inch** Stem 3/8" dia., #4-48 UNF Thread

ANSI/AGD type

Graduation	Range	Range/full stroke	Dial reading	Order No.		Accuracy	Measuring force	
				w/ lug	Flat-back			
.0001"	.008"	.01"	4-0-4	<b>2910S-10</b>	<b>2910SB-10</b>	±.0001"	1.8N or less	<input checked="" type="checkbox"/> <input checked="" type="checkbox"/> <input checked="" type="checkbox"/>
.0001"	.008"	.01"	4-0-4	<b>2910S-72</b>	<b>2910SB-72</b>	±.0001"	2.5N or less	<input checked="" type="checkbox"/> <input checked="" type="checkbox"/> <input checked="" type="checkbox"/>
.0005"	.04"	.05"	20-0-20	<b>2909S-62</b>	<b>2909SB-62</b>	±.0005"	2.5N or less	<input checked="" type="checkbox"/> <input checked="" type="checkbox"/> <input type="checkbox"/>
.0005"	.02"	.028"	10-0-10	—	<b>2976TB*</b>	±.0005"	0.4 - 1.4N	<input checked="" type="checkbox"/> <input checked="" type="checkbox"/> <input type="checkbox"/>
.0005"	.04"	.055"	20-0-20	—	<b>2977TB*</b>	±.0005"	0.4 - 1.4N	<input checked="" type="checkbox"/> <input checked="" type="checkbox"/> <input type="checkbox"/>
.001"	.06"	.079"	30-0-30	—	<b>2978TB*</b>	±.001"	0.4 - 1.4N	<input checked="" type="checkbox"/> <input checked="" type="checkbox"/> <input type="checkbox"/>

\*Flat-back type only. (Lug-on-center back is not available.)

**Metric** Stem 3/8" dia., #4-48 UNF Thread Yellow Dial Face

ANSI/AGD type

Graduation	Range	Range/full stroke)	Dial reading	Order No.		Accuracy	Measuring force	
				w/ lug	Flat-back			
0.001mm	0.08mm	0.1mm	40-0-40	<b>2900S-73</b>	<b>2900SB-73</b>	±0.003mm	2.0N or less	<input checked="" type="checkbox"/> <input checked="" type="checkbox"/> <input checked="" type="checkbox"/>

\*Flat-back type only. (Lug-on-center back is not available.)

### DIMENSIONS

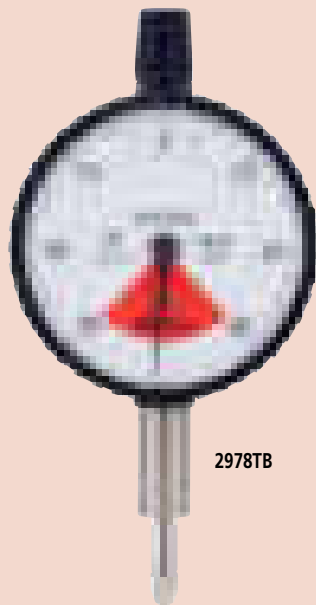
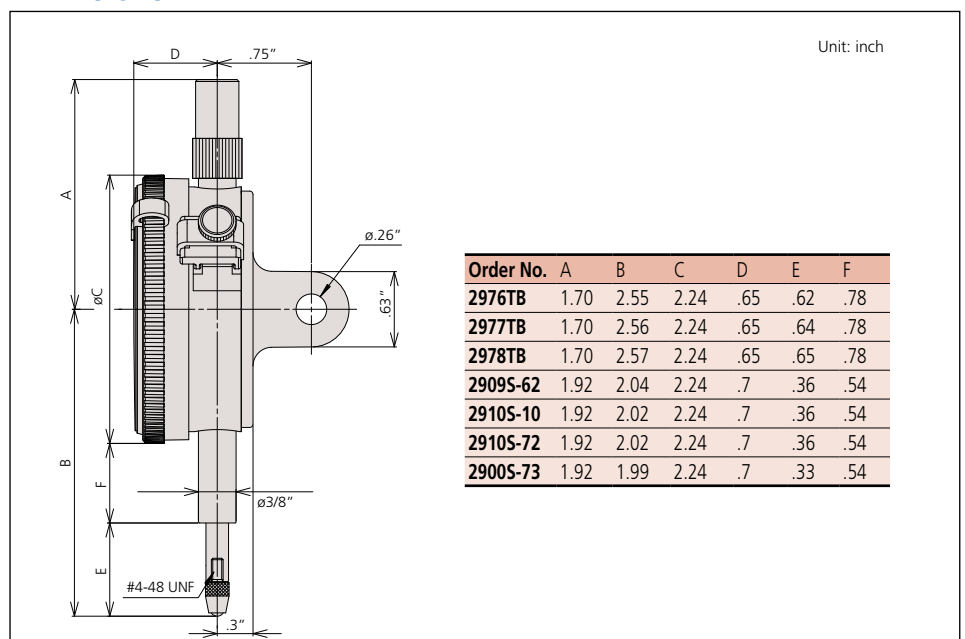

#### Optional Accessories

- : Backs (See page F-33.)
- : Contact points (See page F-34.)

# Special Dial Indicators

## SERIES 2



Adjustable hand



20485-10

### Adjustable hand dial gage

The hand position can be adjusted independently of the vertical movement of the spindle by rotating the top knob.



Peak hold



20465-80

### Peak hold dial gage

A mechanism that stops the pointer and the spindle at the depressed position where the spindle is depressed makes the pointer stop and display the maximum value.

## SPECIFICATIONS

**Inch** Stem dia. 3/8" #4-48 UNF Thread ANSI/AGD type

Graduation	Range	Range /rev	Dial reading	Order No.		Accuracy		Measuring force			
				w/lug	Flat-back	First 2.5 Rev	Overall Accuracy				
.001"	.5"	.1"	0-100	<b>29155-10</b>	<b>29155B-10</b>	±.001"	±.001"	1.8N or less	✓	✓	✓
.001"	.5"	.1"	0-50-0	<b>29185-10</b>	<b>29185B-10</b>	±.001"	±.001"	1.8N or less	✓	✓	✓

**Metric** Stem dia. 3/8" #4-48 UNF Thread, Yellow Dial Face ANSI/AGD type

Graduation	Range	Range /rev	Dial reading	Order No.		Accuracy		Measuring force			
				w/lug	Flat-back	First 2.5 Rev	Overall				
0.01mm	10mm	1mm	0-100	<b>20485-11</b>	<b>20485B-11</b>	±13μm	±0.013mm	1.4N or less	✓	✓	✓

**Metric** Stem ø 8mm, M2.5 x 0.45 Thread ISO/JIS type

Graduation	Range	Range /rev	Dial reading	Order No.		Accuracy	Measuring force				
				w/lug	Flat-back						
0.01mm	10mm	1mm	0-100	<b>20485-10</b>	<b>20485B-10</b>	±0.015mm	1.4N or less	✓	✓	✓	
0.01mm	10mm	1mm	0-100	<b>20465-80</b>	<b>20465B-80</b>	±0.015mm	5.0N or less				✓

## DIMENSIONS

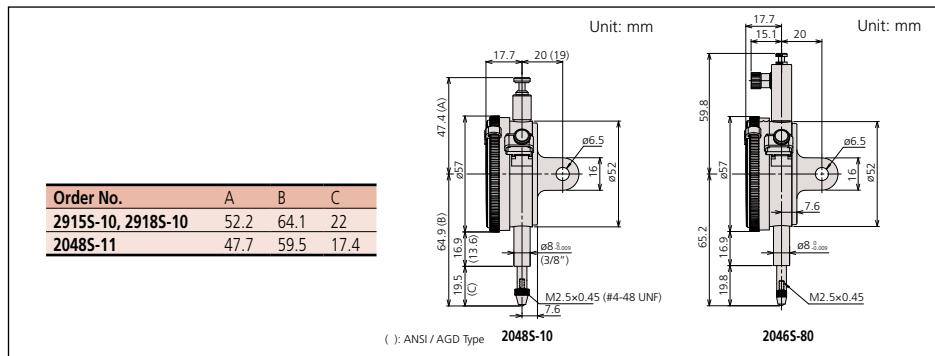



# Dial Indicators

## SERIES 2 — Standard Type, Inch Reading



2416S



2803S-10

### Optional Accessories

- : Backs (See page F-33.)
- : Contact points (See page F-34.)

### SPECIFICATIONS

Inch		Stem 3/8" dia. #4-48 UNF Thread				ANSI/AGD type					
Graduation	Range	Range /Rev	Dial Reading	Order No.		Accuracy		Measuring force			
				w/lug	Flat-back	First 2.5 Rev	Overall				
.0001"	.025"	.01"	0-10	<b>2802S-10</b>	<b>2802SB-10</b>	±.0001"	±.0001"	2.5N or less	✓		✓
.0001"	.025"	.01"	0-5-0	<b>2803S-10</b>	<b>2803SB-10</b>	±.0001"	±.0001"	2.5N or less	✓		✓
.0001"	.05"	.01"	0-10	<b>2804S-10</b>	<b>2804SB-10</b>	±.0001"	±.0002"	2.0N or less	✓		✓
.0001"	.05"	.01"	0-5-0	<b>2805S-10</b>	<b>2805SB-10</b>	±.0001"	±.0002"	2.0N or less	✓		✓
.0001"	.05"	.01"	10-0	<b>2905S-10</b>	<b>2905SB-10</b>	±.0001"	±.0002"	2.0N or less	✓	✓	✓
.0001"	.05"	.01"	0-5-0	<b>2923S-10</b>	<b>2923SB-10</b>	±.0001"	±.0002"	2.0N or less	✓	✓	✓
.0001"	.25"	.01"	0-10	<b>2356S-10</b>	<b>2356SB-10</b>	±.0001"	±.0005"	2.0N or less			✓
.0001"	.5"	.01"	0-10	<b>2358S-10</b>	<b>2358SB-10</b>	±.0001"	±.0008"	2.0N or less			✓
.0005"	.125"	.05"	0-50	<b>2506S</b>	<b>2506SB</b>	±.0005"	±.0005"	1.8N or less			
.0005"	.125"	.05"	0-25-0	<b>2507S</b>	<b>2507SB</b>	±.0005"	±.0005"	1.8N or less			
.0005"	.125"	.05"	0-25-0	<b>2922S</b>	<b>2922SB</b>	±.0005"	±.0005"	1.8N or less		✓	
.0005"	.5"	.05"	0-50	<b>2514S</b>	<b>2514SB</b>	±.0005"	±.0015"	1.8N or less			
.0005"	1"	.05"	0-50	<b>2776S</b>	<b>2776SB</b>	±.0005"	±.002"	2.5N or less			
.001"	.5"	.1"	0-100	<b>2414S</b>	<b>2414SB</b>	±.001"	±.001"	1.8N or less			
.001"	.5"	.1"	100-0	<b>2914S</b>	<b>2914SB</b>	±.001"	±.001"	0.4-1.8N		✓	
.001"	.5"	.1"	0-50-0	<b>2415S</b>	<b>2415SB</b>	±.001"	±.001"	1.8N or less			
.001"	1"	.1"	0-100	<b>2416S</b>	<b>2416SB</b>	±.001"	±.002"	1.8N or less			
.001"	1"	.1"	0-100	<b>2416S-06*</b>	<b>2416SB-06*</b>	±.001"	±.002"	1.8N or less			
.001"	1"	.1"	0-100	<b>2416S-10</b>	<b>2416SB-10</b>	±.001"	±.002"	1.8N or less			✓
.001"	1"	.1"	0-50-0	<b>2417S</b>	<b>2417SB</b>	±.001"	±.002"	1.8N or less			
.001"	1"	.1"	100-0	<b>2904S</b>	<b>2904SB</b>	±.001"	±.002"	1.8N or less		✓	
.001"	2"	1"	0-100	<b>2424S-19</b>	<b>2424SB-19</b>	±.001"	±.003"	2.5N or less	✓		✓

\* Black Face



Shockproof type



Reverse reading type



Jeweled bearing type

# Dial Indicators

## SERIES 2 — Standard Type, Inch Reading



2506S



2923S-10



2424S-19

### DIMENSIONS

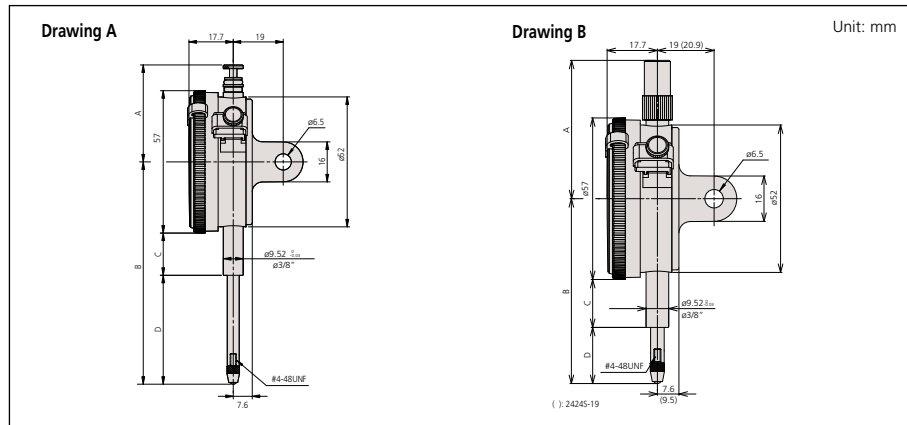

### 2 Group Inch

Order No.	A	B	C	D	Drawing
2356S(B)-10	48.8	57.2	13.6	15.1	B
2358S(B)-10	38.9	63.6	13.6	21.5	A
2414S(B)	38.9	64.1	13.6	22	A
2415S(B)	38.9	64.1	13.6	22	A
2416S(B)	38.9	76.8	13.6	34.7	A
2416S(B)-06	38.9	76.8	13.6	34.7	A
2416S(B)-10	38.9	76.8	13.6	34.7	A
2417S(B)	38.9	76.8	13.6	34.7	A
2424S(B)-19	118.5	142.5	54.3	59.7	B
2506S(B)	48.8	54.3	13.6	12.2	B
2507S(B)	48.8	54.3	13.6	12.2	B
2514S(B)	38.9	64.1	13.6	22	A

Order No.	A	B	C	D	Drawing
2776S(B)	38.9	76.8	13.6	34.7	A
2802S(B)-10	48.8	51.4	13.6	9.3	B
2803S(B)-10	48.8	51.4	13.6	9.3	B
2804S(B)-10	48.8	51.7	13.6	9.6	B
2805S(B)-10	48.8	51.7	13.6	9.6	B
2904S(B)	38.9	76.8	13.6	34.7	A
2905S(B)-10	48.8	51.7	13.6	9.6	B
2914S(B)	38.9	64.1	13.6	22	A
2915S(B)-10	52.2	63.3	13.6	21.2	A
2918S(B)-10	52.2	63.3	13.6	21.2	A
2922S(B)	48.8	54.3	13.6	12.2	B
2923S(B)-10	48.8	51.7	13.6	9.6	B



# Dial Indicators

## SERIES 2 — Metric Standard Type

Series 2 dial indicators are Mitutoyo's most popular and have the widest application.



### FEATURES

- Standard 0.01mm graduation dial gages having an outer frame with an outside diameter of 57mm. All types come with limit pins and an outer-frame clamp as standard.
- The outer clamp and lifting lever (optional) can be attached to either the right or left side. These parts can be easily installed and removed without tools.
- Secured adhesion between the outer frame and crystal, as well as the use of an O-ring, protect against water and oil permeation via the front face.
- The stem spindle is made of high-strength quench-hardened stainless steel for longevity.
- A carbide contact point is used.
- The grand gear uses stainless steel that is resistant to wear and deformation.
- Application of a hard coating on the surface of the crystal makes the gage highly scratch- and chemical-resistant.



### SPECIFICATIONS

Graduation	Range	Range / Rev	Dial reading	Order No.		Accuracy	Measuring Force	Features								
				w/ lug	Flat-back			Shockproof	Waterproof	Long stem	Jeweled bearing	Double scale	Coaxial counter	Reverse reading	Damper	
0.001mm	1mm	(0.1mm)	0-100	2110S-10	2110SB-10	±0.005mm	1.5N or less	✓			✓	✓				
0.001mm	1mm	(0.1mm)	0-100	2110S-70	2110SB-70	±0.005mm	2.0N or less	✓	✓		✓	✓				
0.001mm	1mm	(0.2mm)	0-100-0	2109S-10	2109SB-10	±0.005mm	1.5N or less	✓			✓					
0.001mm	1mm	(0.2mm)	0-100-0	2109S-70	2109SB-70	±0.005mm	2.0N or less	✓	✓		✓					
0.001mm	2mm	(0.2mm)	0-100-0	2113S-10	2113SB-10	±0.007mm	1.5N or less	✓			✓					
0.001mm	5mm	(0.2mm)	0-100-100	2118S-10	2118SB-10	±0.010mm	1.5N or less				✓					
0.001mm	5mm	(0.2mm)	0-100-0	2119S-10	2119SB-10	±0.010mm	1.5N or less				✓					
0.005mm	5mm	(0.5mm)	0-50	2124S-10	2124SB-10	±0.012mm	1.5N or less				✓					
0.01mm	5mm	(1mm)	0-100	2044S	2044SB	±0.012mm	1.4N or less									
0.01mm	5mm	(1mm)	0-100	2044S-09	2044SB-09	±0.013mm	1.4N or less	✓								
0.01mm	5mm	(1mm)	0-100	2044S-60	2044SB-60	±0.012mm	2.5N or less		✓							
0.01mm	5mm	(1mm)	0-50-0	2045S	2045SB	±0.012mm	1.4N or less								✓	
0.01mm	10mm	(1mm)	0-100	2046S	2046SB	±0.013mm	1.4N or less									
0.01mm	10mm	(1mm)	0-100	2046S-09	2046SB-09	±0.015mm	1.4N or less	✓								
0.01mm	10mm	(1mm)	0-100	2046S-60	2046SB-60	±0.013mm	2.5N or less		✓							
0.01mm	10mm	(1mm)	0-100	2310S-10	2310SB-10	±0.015mm	1.4N or less				✓		✓			
0.01mm	10mm	(1mm)	100-0	2902S	2902SB	±0.013mm	1.4N or less								✓	
0.01mm	10mm	(1mm)	0-50-0	2047S	2047SB	±0.013mm	1.4N or less									
0.01mm	20mm	(1mm)	0-100	2050S	2050SB	±0.020mm	2.0N or less									✓
0.01mm	20mm	(1mm)	0-100	2050S-60	2050SB-60	±0.020mm	2.5N or less		✓							
0.01mm	20mm	(1mm)	0-100	2050S-19	2050SB-19	±0.020mm	2.0N or less	✓			✓				✓	✓
0.01mm	20mm	(1mm)	0-100	2320S-10	2320SB-10	±0.020mm	2.0N or less				✓		✓		✓	✓
0.01mm	30mm	(1mm)	0-100	2052S	2052SB	±0.025mm	2.5N or less									✓
0.01mm	30mm	(1mm)	0-100	2052S-19	2052SB-19	±0.025mm	2.5N or less	✓			✓					✓
0.01mm	30mm	(1mm)	0-100	2330S-10	2330SB-10	±0.025mm	2.5N or less				✓		✓			✓
0.01mm	30mm	(1mm)	100-0	2952S	2952SB	±0.025mm	2.5N or less								✓	✓

\*Use in a vertical position only (contact point downward).

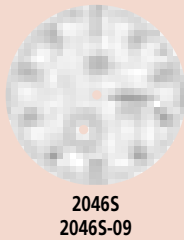

20465  
20465-09



20465-60



20475

# Dial Indicators

## SERIES 2 — Metric Standard Type



### DIMENSIONS

ISO/JIS Type

Unit: mm

Order No.	A	B	C
21245-10	60.3	16.9	14.9
21105-10	66.5	16.9	21.1
21105-70	67.5	12.3	26.7
21095-10	60.5	16.9	15.1
21095-70	65.3	12.3	24.5
21135-10	61	16.9	15.6
21185-10	60.3	16.9	14.9
21195-10	60.3	16.9	14.9
20445	65.2	16.9	19.8
20445-09	65.2	16.9	19.8
20445-60	70	12.3	29.2
20455	65.2	16.9	19.8
20465	65.2	16.9	19.8
20465-09	65.2	16.9	19.8
20465-60	70	12.3	29.2
23105-10	65.2	16.9	19.8
29025	65.2	16.9	19.8
20475	65.2	16.9	19.8

ISO/JIS Type

Unit: mm

Order No.	A	B	C	D
20505	38.8	75.2	16.9	29.8
20505-60	59.8	87.2	12.3	46.4
20505-19	38.8	75.2	16.9	29.8
23205-10	38.8	75.2	16.9	29.8
20525	38.8	88.7	16.9	43.3
20525-19	38.8	88.7	16.9	43.3
23305-10	38.8	88.7	16.9	43.3
29525	38.8	88.7	16.9	43.3



29025

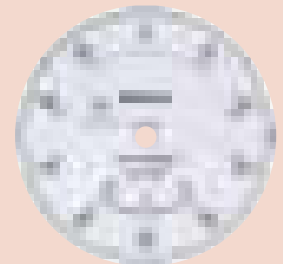

23105-10

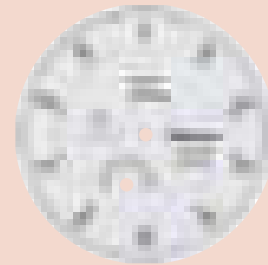

20445  
20445-60  
20445-09



20455



### Optional Accessories

- : Backs (See page F-33.)
- : Contact points (See page F-34.)

# Dial Indicators

## SERIES 2 — ANSI / AGD Type Metric Dial Indicator

### SPECIFICATIONS

Graduation	Range	Range / Rev	Dial reading	Order No.		Accuracy		Measuring force	 
				w/ lug	Flat-back	First 2.5 Rev	Overall		
0.001mm	1mm	0.2mm	0-100-0	<b>2109S-11</b>	<b>2109SB-11</b>	±0.003mm	±0.004mm	1.5N or less	✓ ✓
0.001mm	5mm	0.2mm	0-100-0	<b>2119S-11</b>	<b>2119SB-11</b>	±0.007mm	±0.01mm	1.5N or less	✓
0.01mm	2.5mm	1mm	0-100	<b>2230S-01</b>	<b>2230SB-01</b>	±0.01mm	±0.01mm	1.4N or less	
0.01mm	2.5mm	1mm	0-50-0	<b>2231S-01</b>	<b>2231SB-01</b>	±0.01mm	±0.01mm	1.4N or less	
0.01mm	10mm	1mm	0-100	<b>2046S-01</b>	<b>2046SB-01</b>	±0.01mm	±0.013mm	1.4N or less	
0.01mm	10mm	1mm	0-100	<b>2046S-11</b>	<b>2046SB-11</b>	±0.01mm	±0.013mm	1.4N or less	✓
0.01mm	10mm	1mm	0-50-0	<b>2047S-01</b>	<b>2047SB-01</b>	±0.01mm	±0.013mm	1.4N or less	
0.01mm	10mm	1mm	0-50-0	<b>2047S-11</b>	<b>2047SB-11</b>	±0.01mm	±0.013mm	1.4N or less	✓
0.01mm	10mm	1mm	100-0	<b>2902S-01</b>	<b>2902SB-01</b>	±0.01mm	±0.013mm	1.4N or less	
0.01mm	20mm	1mm	0-100	<b>2050S-01</b>	<b>2050SB-01</b>	±0.01mm	±0.02mm	2.0N or less	
0.01mm	20mm	1mm	0-100	<b>2050S-11</b>	<b>2050SB-11</b>	±0.01mm	±0.02mm	2.0N or less	✓
0.01mm	25mm	1mm	0-100	<b>2056S-01</b>	<b>2056SB-01</b>	±0.01mm	±0.025mm	2.5N or less	

### DIMENSIONS

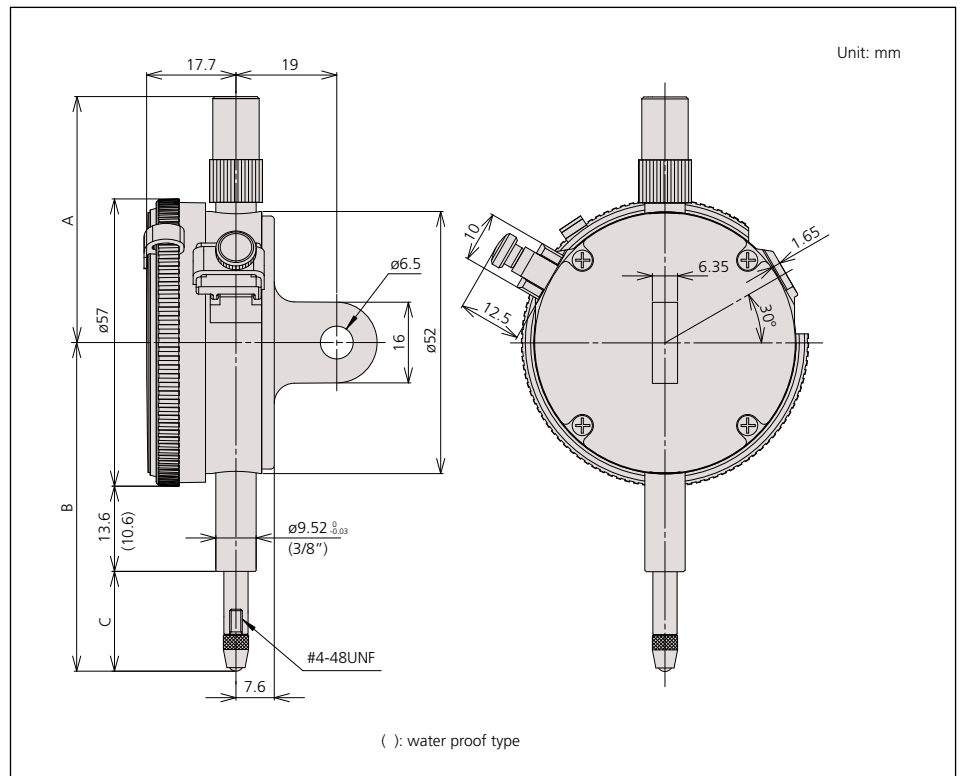

Order No.	A	B	C
<b>2109S-11</b>	48.8	51.4	9.3
<b>2119S-11</b>	48.8	55.8	13.7
<b>2230S-01</b>	48.8	53.6	11.5
<b>2231S-01</b>	48.8	53.6	11.5
<b>2046S-01</b>	48.8	61.1	19.0
<b>2046S-11</b>	48.8	61.1	19.0
<b>2047S-01</b>	48.8	61.1	19.0
<b>2902S-01</b>	48.8	61.1	19.0
<b>2050S-01</b>	38.8	71.1	29.0
<b>2050S-11</b>	38.8	71.1	29.0
<b>2056S-01</b>	38.8	76.1	34.0

#### Optional Accessories

- : Backs (See page F-33.)
- : Contact points (See page F-34.)

# Dial Indicators

## SERIES 3 — Large Dial Face and Long Stroke

- Dial gages with a large-diameter (78mm / 3.07") graduation face for easy reading.

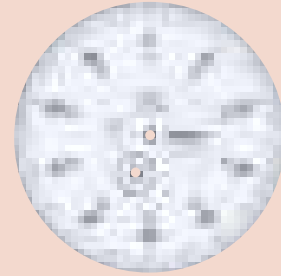

30465

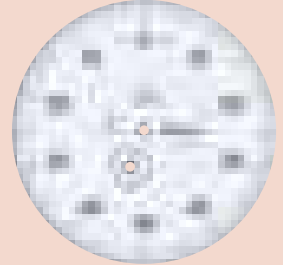

30475

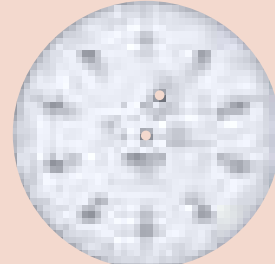

30505

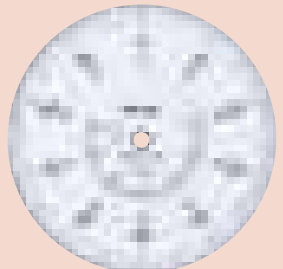

30525-19

## DIMENSIONS

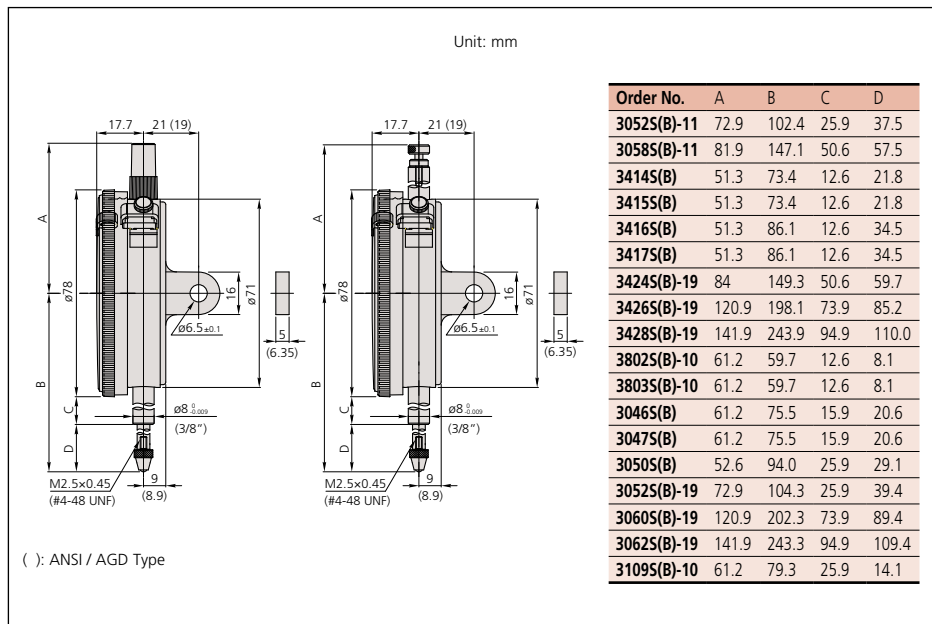

# Dial Indicators

## SERIES 3 — Large Dial Face

### SPECIFICATIONS

**Inch** Stem 3/8" DIA. #4-48 UNF Thread ANSI/AGD type

Graduation	Range	Range /rev	Dial reading	Order No.		Accuracy		Measuring Force				
				W/ lug	Flat-back	First 2.5 Rev	Overall Accuracy					
.0001"	.025"	.01"	0-10	<b>3802S-10</b>	<b>3802SB-10</b>	±.0001"	±.0001"	2.0N or less	✓	✓		
.0001"	.025"	.01"	0-5-0	<b>3803S-10</b>	<b>3803SB-10</b>	±.0001"	±.0001"	2.0N or less	✓	✓		
.001"	.5"	.1"	±0-100	<b>3414S</b>	<b>3414SB</b>	±.001"	±.001"	1.8N or less				
.001"	.5"	.1"	0-50-0	<b>3415S</b>	<b>3415SB</b>	±.001"	±.001"	1.8N or less				
.001"	1"	.1"	±0-100	<b>3416S</b>	<b>3416SB</b>	±.001"	±.002"	1.8N or less				
.001"	1"	.1"	0-50-0	<b>3417S</b>	<b>3417SB</b>	±.001"	±.002"	1.8N or less				
.001"	2"	.1"	±0-100	<b>3424S-19</b>	<b>3424SB-19</b>	±.001"	±.003"	3.0N or less	✓	✓	✓	✓
.001"	3"	.1"	±0-100	<b>3426S-19</b>	<b>3426SB-19</b>	±.001"	±.005"	3.0N or less	✓	✓	✓	✓
.001"	4"	.1"	±0-100	<b>3428S-19</b>	<b>3428SB-19</b>	±.001"	±.005"	3.2N or less	✓	✓	✓	✓

**Metric** Stem 3/8" DIA. #4-48 UNF Thread, Yellow dial face ANSI/AGD type

Graduation	Range	Range /rev	Dial reading	Order No.		Accuracy		Measuring Force				
				W/ lug	Flat-back	First 2.5 Rev	Overall Accuracy					
0.01mm	30mm	1mm	±0-100	<b>3052S-11</b>	<b>3052SB-11</b>	±0.01mm	±0.03mm	2.5N or less	✓	✓	✓	✓
0.01mm	50mm	1mm	±0-100	<b>3058S-11</b>	<b>3058SB-11</b>	±0.01mm	±0.04mm	3.0N or less	✓	✓	✓	✓

**Metric** Stem ø 8mm M2.5x0.45 Thread ISO/IS type

Graduation	Range	Range /rev	Dial reading	Order No.		Accuracy	Measuring Force					
				W/ lug	Flat-back							
0.001mm	1mm	0.2mm	0-10-0	<b>3109S-10</b>	<b>3109SB-10</b>	±0.005mm	1.5N or less	✓	✓			
0.01mm	10mm	1mm	0-100	<b>3046S</b>	<b>3046SB</b>	±0.015mm	1.4N or less					
0.01mm	10mm	1mm	0-50-0	<b>3047S</b>	<b>3047SB</b>	±0.015mm	1.4N or less					
0.01mm	20mm	1mm	0-100	<b>3050S</b>	<b>3050SB</b>	±0.020mm	2.0N or less					✓
0.01mm	30mm	1mm	0-100	<b>3052S-19</b>	<b>3052SB-19</b>	±0.025mm	2.5N or less	✓	✓	✓	✓	
0.01mm	50mm	1mm	0-100	<b>3058S-19</b>	<b>3058SB-19</b>	±0.035mm	3.0N or less	✓	✓	✓	✓	
0.01mm	80mm	1mm	0-100	<b>3060S-19*</b>	<b>3060SB-19*</b>	±0.045mm	3.0N or less	✓	✓	✓	✓	
0.01mm	100mm	1mm	0-100	<b>3062S-19*</b>	<b>3062SB-19*</b>	±0.050mm	3.2N or less	✓	✓	✓	✓	

\*use in a vertical position only

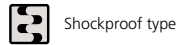

Shockproof type



w/ coaxial revolution counter



w/ damper at lowest rest point



Jeweled bearing type

### Optional Accessories

- : Backs (See page F-33.)
- : Contact points (See page F-34.)

# Dial Indicators

## SERIES 4 — Large Dial Face

- Dial gages with a large-diameter (92mm / 3.62") graduation face for easy reading.
- All types come standard with limit pins and an outer frame clamp.



4046S



4887S-19

### SPECIFICATIONS

Inch		Stem 3/8" DIA. #4-48 UNF Thread				ANSI/AGD type			
Graduation	Range	Range /rev	Dial reading	Order No.		Accuracy		Measuring Force	
				W/ lug	Flat-back	First 2.5 Rev	Overall accuracy		
.001"	3"	.1"	±0-100	<b>4887S-19</b>	<b>4887SB-19</b>	±.001"	±.005"	3.0N or less	

Metric		Stem ø 8mm M2.5x0.45 Thread				ISO/JIS type			
Graduation	Range	Range /rev	Dial reading	Order No.		Accuracy		Measuring Force	
				W/ lug	Flat-back	First 2.5 Rev	Overall accuracy		
0.01mm	10mm	1mm	0-100	<b>4046S</b>	<b>4046SB</b>	± 0.01mm	± 0.015mm	1.4N or less	

### DIMENSIONS

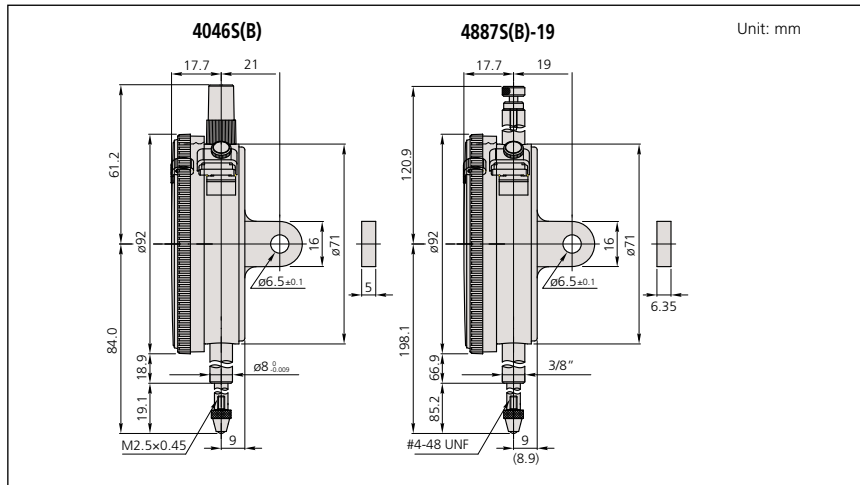

### Optional Accessories

- : Backs (See page F-33.)
- : Contact points (See page F-34.)

# Back Plunger Dial Indicators

## SERIES 1 and 2



Mitutoyo's back-plunger dial indicators are built with the measuring spindles on the back of the units. This type of indicator offers the same precision and durability as all other Mitutoyo dial indicators, and operates effectively with optional holding bars.

- Back-plunger dial gages are suitable for mounting onto leveling machine tool tables or inspection jigs, and for use in small spaces where the graduations of standard dial gages are difficult to see.
- Model No. 1960T, which uses Mitutoyo's proprietary shock-proofing mechanism, has excellent durability and shock resistance.



One revolution type



Shockproof type



Jeweled bearing type

### Optional Accessories

- 136567:** Holding bar (ø6mm, L=81mm)  
**136568:** Holding bar (ø8mm, L=81mm)  
**124625:** Holding bar (.25" DIA, L=3.19")

—: Backs (See page F-31.)

—: Contact points (See page F-34.)

### SPECIFICATIONS

**Inch** Series 1 Stem 3/8" dia., #4-48 UNF Thread ANSI/AGD type

Graduation	Range	Range / Rev	Dial reading	Order No.	Accuracy	Measuring Force			
.001"	.04"	.05"*	20-0-20	<b>1961T</b>	±.001"	0.4 - 1.4N	✓	✓	
.001"	.2"	.05"	0-50	<b>1166T</b>	±.001"	0.4 - 1.4N			
.001"	.2"	.05"	0-25-0	<b>1167T</b>	±.001"	0.4 - 1.4N			
.001"	.2"	.05"	50-0	<b>1168T</b>	±.001"	0.4 - 1.4N			✓

\*Full stroke

**Metric** Series 1 Stem ø8mm, M2.5x0.45 Thread ISO/JIS type

Graduation	Range	Range / Rev	Dial reading	Order No.	Accuracy	Measuring Force				Remarks
0.01mm	1mm	1.27mm*	50-0-50	<b>1960T</b>	±0.014mm	0.4 - 1.4N	✓	✓		—
0.01mm	5mm	1mm	0-100	<b>1160T</b>	±0.016mm	0.4 - 1.4N				—
0.01mm	5mm	1mm	100-0	<b>1162T</b>	±0.016mm	0.4 - 1.4N			✓	—

\*Full stroke

**Inch** Series 2 Stem 3/8" dia., #4-48 UNF Thread ANSI/AGD type

Graduation	Range	Range/full stroke	Dial reading	Order No.	Accuracy	Measuring Force			
.0001"	.008"	.01"	4-0-4	<b>2991T-10</b>	±.0002"	0.4 - 1.5N	✓	✓	✓
.0005"	.04"	.05"	20-0-20	<b>2961T</b>	±.0005"	0.4 - 1.4N	✓	✓	

**Metric** Series 2 Stem ø8mm, M2.5x0.45 Thread ISO/JIS type

Graduation	Range	Range/full stroke	Dial reading	Order No.	Accuracy	Measuring Force			
0.001mm	0.1mm	0.14mm	50-0-50	<b>2990T-10</b>	±0.005mm	0.4 - 1.5N	✓	✓	✓
0.01mm	1mm	1.27mm	50-0-50	<b>2960T</b>	±0.014mm	0.4 - 1.4N	✓	✓	

# Back Plunger Dial Indicators

SERIES 1 and 2



2960T

Balanced scale



Graduation: 0.01mm,  
Measuring range: 1mm

2960T

- One revolution
- Shockproof
- Back plunger



2990T-10

Balanced scale



Graduation: 0.01mm,  
Measuring range: 1mm

2990T-10

- One revolution
- Shockproof
- Back plunger
- Jeweled bearing

## DIMENSIONS

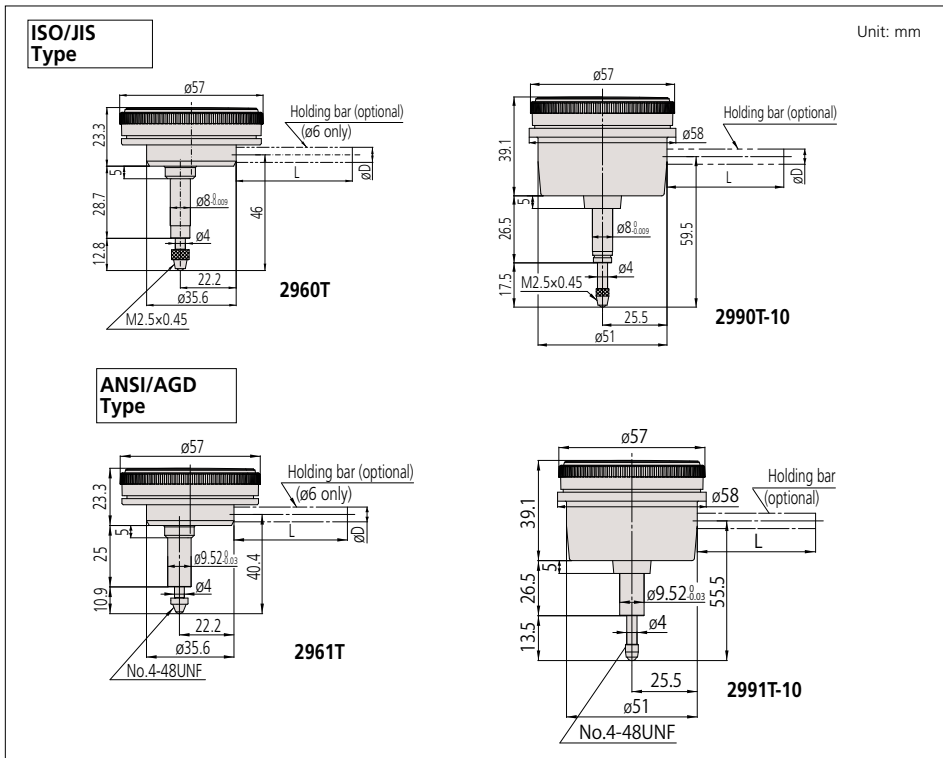

## DIMENSIONS

ANSI/AGD Type

Unit: mm

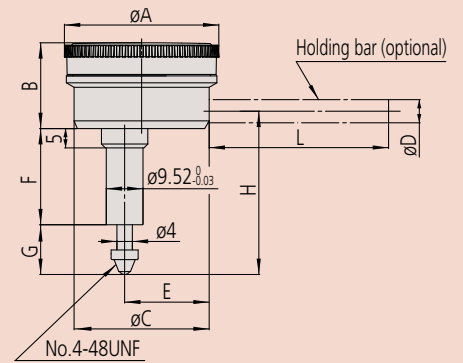

Order No.	A	B	C	E	F	G	H
1166T	40	22.1	35.6	22.2	25	10.9	42
1167T	40	22.1	35.6	22.2	25	10.9	42
1168T	40	22.1	35.6	22.2	25	10.9	42
1961T	40	22.1	35.6	22.2	25	10.9	40

ISO/JIS Type

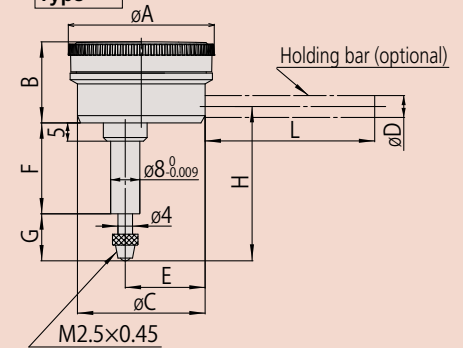

Order No.	A	B	C	E	F	G	H
1160T	40	22.1	35.6	22.2	25	13.8	43.3
1162T	40	22.1	35.6	22.2	25	13.8	43.3
1960T	40	22.1	35.6	22.2	28.7	12.8	46

Note 1: Refer to pages F-34 to F-35 for contact point details.  
Note 2: Dimensions of the inch (ANSI/AGD Type) dial indicator partly differ from those of the metric (ISO/JIS Type) indicator.

Note 3: Inch (ANSI/AGD Type) dial indicators are provided with a stem of 3/8" dia. and #4-48UNF thread mount for the contact point.

## Holding bar (optional)

Order No.	ØD	L
21AAA166	Ø6mm	42mm
136567	Ø6mm	81mm
124625	Ø6.35mm	81mm
21AAA167	Ø6.35mm	42mm
21AAA168	Ø8mm	42mm
136568	Ø8mm	81mm

\* ØD and L: detail shown in drawing below.



# Backs

## Optional Accessory for Digimatic and Dial Indicators

There are two ways to support Digimatic and dial indicators--by either holding the stem or the lug on the back of the indicator. The back of the indicator may need to be replaced for special applications. A variety of backs are available for Mitutoyo Digimatic and dial indicators.

### Application

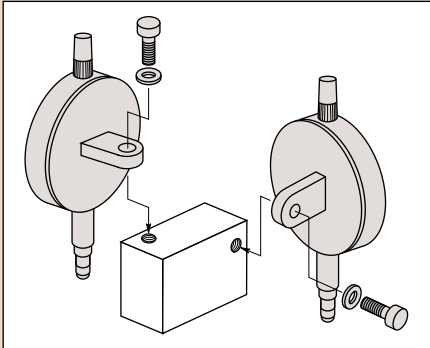









### ID-S (543-6xx only)\*1

- 02ACB420:** Lug-on-center back for ISO/JIS type
- 02ACB430:** Lug-on-center back for AGD type
- 02ACB440:** Flat back
- 02ACB610:** Back with post
- 02ACB620:** Adjustable back for AGD type
- 02ACB630:** Adjustable back (ISO/JIS type)
- 02ACB640:** Back with offset lug
- 02ACB650:** Magnetic back
- 02ACB660:** Back with screw mount for AGD type
- 02ACB670:** Back with screw mount (ISO/JIS type)
- 02ACB680:** Back with adjustable bracket

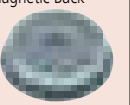
\*1 Includes the required adapter.

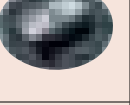

### SPECIFICATIONS

Description	Order No.	Series 0	Series 1	Series 2	Series 3, 4
		(ø31mm) 1003 (ø36mm)	(ø41mm)	ID-C (all types), ID-F, ID-H ID-S (excludes 543-6xx) (ø57mm)	(ø77, 91mm)
Flat Back  Unit: mm	<b>191559:</b> a=1.0 <b>137906:</b> for 1003 a=1.0	<b>101211:</b> a=2.2 <b>136872:</b> for water- proof type <b>191559:</b> for 1911, 1913-10	<b>101039:</b> a=2.5 <b>21AZB231:</b> for waterproof of S type	<b>100836:</b> a=3.0	
Lug-on-Center Back  Unit: mm	<b>190561:</b> Metric type <b>190139:</b> Inch type <b>137905:</b> for 1003	<b>101210:</b> metric type <b>101307:</b> inch type <b>190561:</b> for 1911, 1913-10	<b>101040:</b> metric type <b>101306:</b> inch type <b>21AZB230:</b> for waterproof of S type	<b>100691:</b> metric type <b>100797:</b> inch type	
Magnetic Back  Unit: mm	—	<b>Special order</b>	<b>900928</b>	<b>900929</b>	
Back with Offset Lug  Unit: mm	—	<b>Special order</b>	<b>101167</b>	<b>100837</b>	
Back with Post  Unit: mm	—	<b>193172</b>	<b>101169</b>	<b>100839</b>	
Back with Screw Mount  Unit: mm	—	<b>193173:</b> M6x1, <b>193174:</b> #1/4-28UNF, #1/4-28UNF,	<b>136023:</b> M6x1 <b>101170:</b> #1/4-28UNF	<b>136024:</b> M6x1 <b>100840:</b> #1/4-28UNF	
Adjustable Back  Unit: mm	—	<b>136025:</b> M6x1 <b>129721:</b> #1/4-20UNC	<b>136026:</b> M6x1 <b>101168:</b> #1/4-20UNC	<b>136027:</b> M6x1 <b>100838:</b> #1/4-20UNC	
Back with Adjustable Bracket  Unit: mm	—	—	<b>129902:</b> Dovetail Rack Back <b>901964:</b> Dovetail bracket for rack back	—	

( ): ANSI / AGD Type

# Contact Points

## Optional Accessories for Digimatic and Dial Indicators and Linear Gages

### ø.118" (ø3mm) Ball point

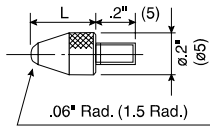

#### 4-48UNF

L	Carbide	Sapphire	Ruby	Plastic
.25"	21BZB005*	—	—	—
.28"	—	—	—	902018
.3"	131262	131263	131264	—
.6"	131265	131266	131267	—
1"	131268	131269	131270	—

#### M2.5 x 0.45mm

L	Carbide	Sapphire	Ruby	Plastic
7.3mm	901312*	—	—	901994
8mm	120045	120046	120047	—
15mm	120049	120050	120051	—
25mm	120053	120054	120055	—

\*Furnished with standard metric dial indicators.

### Shell point

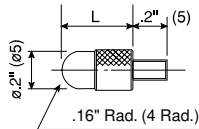

#### 4-48UNF

L	Order No.
3/32" (.094")	193697
5/32" (.156")	101184
1/4" (.25")	21AAA031
3/8" (.375")	21AAA032
1/2" (.5")	101185
5/8" (.625")	21AAA033
3/4" (.75")	101186
7/8" (.875")	21AAA034
1"	101187
1 1/4" (1.25")	21AAA035
1 1/2" (1.5")	21AAA036
1 3/4" (1.75")	21AAA037
2"	21AAA038
2 1/4" (2.25")	21AAA039
2 1/2" (2.5")	21AAA040
2 3/4" (2.75")	21AAA041
3"	21AAA042

#### M2.5 x 0.45mm

L	Order No.
5mm	101386
10mm	101118
15mm	137393
20mm	101387
25mm	101388
30mm	21AAA254

### ø.16 Ball Point

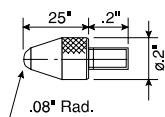

#### 4-48UNF

Order No.
21BZB005

### ø1.8mm Ball Point

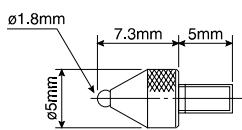

#### M2.5 x 0.45mm

Order No.
101122

### Needle point

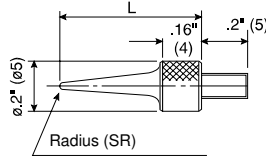

#### 4-48UNF

L	Order No.	SR
.6"	21AAA030	.016"
1"	21AAA046	.016"
1 1/2"	21AAA047	.016"
2"	21AAA048	.016"

#### M2.5 x 0.45mm

L	Order No.	SR
15mm	101121	0.4
17mm	137413	0.2

### Flat point

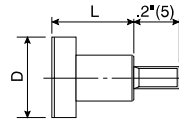

#### 4-48UNF

D	L	Order No.
ø1/2"	3/8"	101188
ø3/8"	3/8"	101189

#### M2.5 x 0.45mm

D	L	Order No.
ø10mm	10mm	101117

### Flat-point, Carbide tip

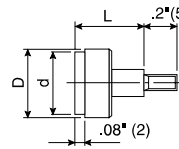

#### 4-48UNF

D	d	L	Order No.
ø.2"	ø.17"	.2"	131259
ø.27"	ø.25"	.4"	131260
ø.41"	ø.37"	.4"	131261

#### M2.5 x 0.45mm

D	d	L	Order No.
ø5.2mm	ø4.3mm	5mm	120041
ø7mm	ø6.5mm	10mm	120042
ø10.5mm	ø9.5mm	10mm	120043

### Spherical-point, Carbide tip

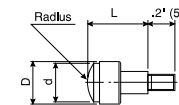

#### 4-48UNF

D	d	Radius	L	Order No.
ø.2"	ø.17"	.2"	.2"	131273
ø.27"	ø.16"	.16"	.4"	131274
ø.41"	ø.37"	.4"	.4"	131275

#### M2.5 x 0.45mm

D	d	Radius	L	Order No.
ø5.2mm	ø4.3mm	5mm	5mm	120058
ø7mm	ø6.5mm	7mm	10mm	120059
ø10.5mm	ø9.5mm	10mm	10mm	120060

### Needle point, Carbide tipped

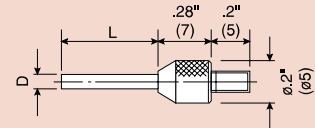

#### 4-48UNF

D	L	Order No.
ø.018"	.12"	131281
ø.04"	.12"	131280
ø.06"	.5"	131279
ø.078"	.04"	131271

#### M2.5 x 0.45mm

D	L	Order No.
ø0.45mm	2.5mm	120066
ø1mm	2.5mm	120065
ø1.5mm	13mm	120064
ø2mm	1mm	120056
ø2mm	8mm	137257

### ø.2" (ø5mm) Flat point

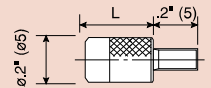

#### 4-48UNF

L	Order No.
5/16"	133017
1/2"	21AAA043
3/4"	21AAA044
1"	21AAA045

#### M2.5 x 0.45mm

L	Order No.
8mm	131365

### Knife-edge point, Carbide tipped

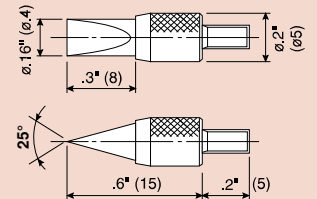

#### 4-48UNF

Order No.
131282

#### M2.5 x 0.45mm

Order No.
120067

### Spherical point

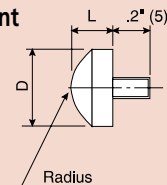

#### 4-48UNF

D	L	Radius	Order No.
ø.5"	.125"	.28"	101205
ø.375"	.09375"	.35"	101204

#### M2.5 x 0.45mm

D	L	Radius	Order No.
ø10mm	5mm	7mm	101119

# Contact Points

Optional Accessories for Digimatic and Dial Indicators and Linear Gages

## 60° Conical point

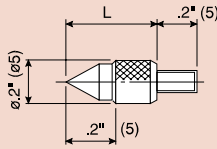

4-48UNF		M2.5 x 0.45mm	
L	Order No.	L	Order No.
1/2"	101190	10mm	101120

## 90° Conical point

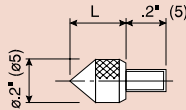

4-48UNF		M2.5 x 0.45mm	
L	Order No.	L	Order No.
1/4"	101191	5mm	101385

## Blade point, Carbide tip

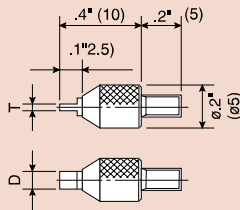

4-48UNF			M2.5 x 0.45mm		
D	T	Order No.	D	T	Order No.
.08"	.016"	131276	2mm	0.4mm	120061
.08"	.024"	131277	2mm	0.6mm	120062
.16"	.04"	131278	4mm	1mm	120063

## 90° Conical point, Carbide tipped

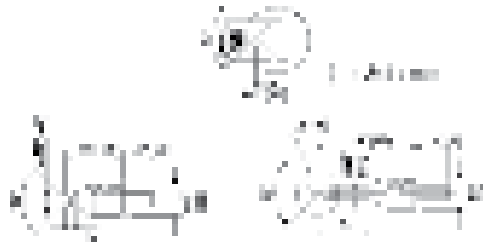

4-48UNF		4-48UNF	
L	Order No.	L	Order No.
.08"	131272	.3"	131283

M2.5 x 0.45mm		M2.5 x 0.45mm	
L	Order No.	L	Order No.
2mm	120057	8mm	120068

## Extension Rod

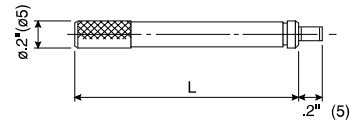

4-48UNF		M2.5 x 0.45mm	
L	Order No.	L	Order No.
1/2"	139167	10mm	303611
1"	301655	15mm	21AAA259A
2"	301657	20mm	303612
4"	301659	25mm	21AAA259B
		30mm	303613
		35mm	21AAA259C
		40mm	21AAA259D
		45mm	21AAA259E
		50mm	21AAA259F
		55mm	21AAA259G
		60mm	304146
		65mm	21AAA259H
		70mm	21AAA259J
		75mm	21AAA259L
		80mm	21AAA259M
		90mm	304147
		100mm	303614

## Roller Point

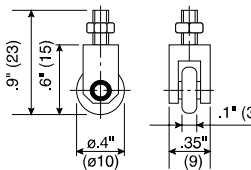

4-48UNF		M2.5 x 0.45mm	
Order No.	Order No.	Order No.	Order No.
901991	901954		

## Point Conversion

M2.5 x 0.45mm 4-48 UNFI

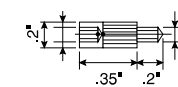

Order No.
21AAA011

4-48 UNFI M2.5 x 0.45mm

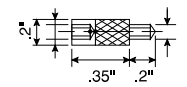

Order No.
21AAA012

## Interchangeable Contact Point Set (M2.5x0.45)

Set Order No. 7822

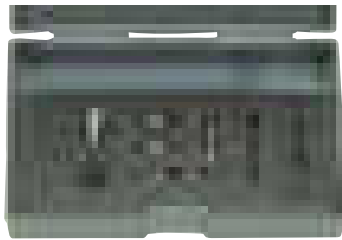

Individual No.	Description
131365	Flat Point (ø5mm)
101117	Flat Point (ø10mm)
101121	Needle Point
101119	Spherical Point
101118	Shell Type Point
101387	Shell Type Point

## Lever Point

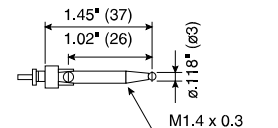

4-48UNF		M2.5 x 0.45mm	
Order No.	Order No.	Order No.	Order No.
900393	900391		

# Spindle Lifting Lever and Cable

## Optional Accessories for Digimatic and Dial Indicators

### Spindle Lifting Lever

- The Spindle Lifting Lever is attached to the top end of the spindle for improved inspection efficiency when using a dial indicator mounted on a stand.

Applicable S-Type Thickness and Depth Gages

Order No.	Description
21AZB149	Depth gages up to 12.7mm/.5"
21AZB150	Depth gages up to 25mm/1"
21AZB151	S-Type thickness gage



Dove Tail Type Lever Assembly

Order No.	Lever up to .5" / 12.7mm	Screw	Screw Thread
21EZA198	21AZB149	101171	M2.5
21EZA199	21AZB149	101047	4/48 UNF



ANSI Screw **101047**  
JIS Screw **101171**

### Spindle Lifting Cable

- 901975**: with auto-stop function
  - 540774**: without auto-stop function
  - 971753**: With release-speed control
- Lifting range: 1" / 25.4mm  
Cable length: 300mm



### Spindle Lifting Pick

- 137693**
- Applicable spindle diameter; 4.8mm

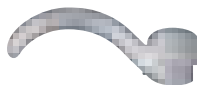

Use for Series 1 Dial Indicators (up 5mm / .25")

Set Order No.	Lever	Screw	Screw Thread
21BZA610	900527	101047	4-48 UNF
21BZA205	900527	101171	M2.5 x 0.45



Use for Series 2 Dial Indicators (up to 10mm/.4")

Set Order No.	Lever	Screw	Screw Thread
902794	900525	101047	4-48 UNF
902011	900525	101171	M2.5 x 0.45



Use for Series 2 Dial Indicators (up to 10mm/.4") and 1 Group S-Type

Set Order No.	Lever	Screw	Screw Thread
21BZA613	21BZA612	101047	4-48 UNF
902100	21BZA612	101171	M2.5 x 0.45



Use for Series 2 Dial Indicators (up to 20mm/.8") and Series 3 and 4 Dial Indicators (up to 10mm/.4")

Set Order No.	Lever	Screw	Screw Thread
903425	903307	192753	4-48 UNF
903424	903307	192686	M2.5 x 0.45

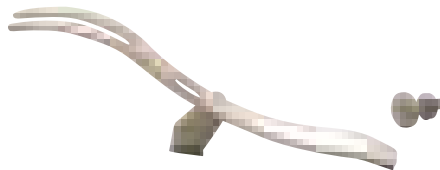

### Spindle Lifting Knob

Set Order No.	Range
21EZA197	For 1" range
21EZA200	For 2" range



### Application

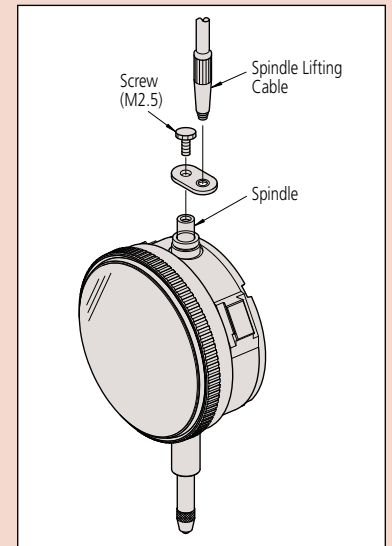
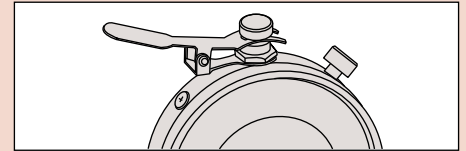
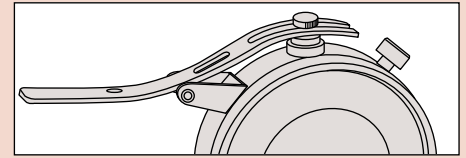

# Color Spindle Caps

## Optional Accessories for Digimatic and Dial Indicators

8 colors of spindle caps are available for dial indicators with a range of 10mm or less.

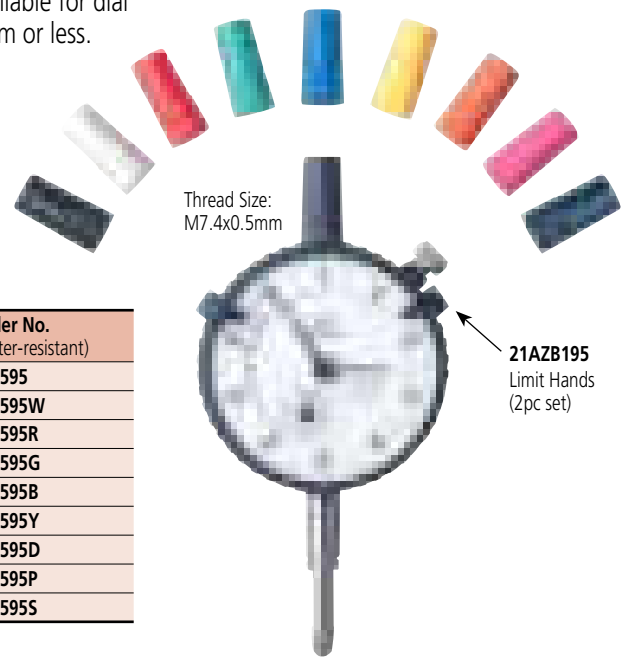

### SPECIFICATIONS

Color	Order No. (normal)	Order No. (water-resistant)
Black	193051	193595
White	193051W	193595W
Red	193051R	193595R
Green	193051G	193595G
Blue	193051B	193595B
Yellow	193051Y	193595Y
Orange	193051D	193595D
Pink	193051P	193595P
Dark blue	193051S	193595S

# Limit Stickers

## Optional Accessories for Digimatic and Dial Indicators

### FEATURES

- Stuck on the dial face or crystal of a Series 2 dial indicator (55.6mm or 57mm bezel dia.) to indicate tolerance limits.



136420: Red (10-sheet/set)

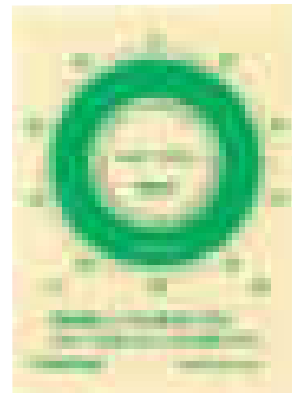

136421: Green (10-sheet/set)



136422: Yellow (10-sheet/set)

# Dial Indicator Repair Tool Kit

## Optional Accessories for Digimatic and Dial Indicators

Mitutoyo offers a tool set designed to let you perform simple repairs to your Mitutoyo dial indicator, as well as a device that lets you reset the indicator crystals.



### SPECIFICATIONS

Order No.	Description
7823EU	Dial indicator repair tool kit

Order No. 7823U

### Set Configuration

- (1) 901173: Screwdriver (Phillips)
- (2) 901174: Screwdriver (Phillips/flat blade)
- (3) 129729: Tweezers
- (4) 901175: Pin-vise
- (5) 901176: Brush
- (6) 21JAA314: Stick
- (7) 901177: Brush
- (8) 901178: Hammer
- (9) 129730: Spindle rest
- (10) 129731: Pin rest
- (11) 901179: Nippers
- (12) 901180: Pliers
- (13) 126628: Hand remover (main unit)
- 126630: Interchangeable Pin, 0.8mm DIA.
- 126630B: Interchangeable Pin, 0.5mm DIA.
- 126630C: Interchangeable Pin, 1.6mm DIA.
- 100699: Nut
  
- (14) 129732: Pin remover
- (15) 129733: Punch
- (16) 129734: Bearing adjuster
- (17) 129735: Pinion rest
- (18) 129736: Reamer  $\phi 1$
- 193702: Reamer  $\phi 0.6$
- 21JAA273: Reamer  $\phi 0.5$
- (19) 901182: Case

# Dial Crystal Setter

## Optional Accessories for Dial Indicators

### FEATURES

- Used for fitting a crystal on dial indicators, dial test indicators and dial calipers.

### SPECIFICATIONS

Order No.	Description
7000	Dial indicator crystal setter



With 8 sizes of crystal setting pads

# Dial Test Indicators

## SERIES 513

### FEATURES

Contact point length is printed on dial face to avoid accuracy issues

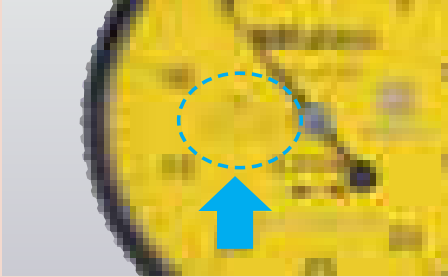

Scratch and smudge-resistant, anti-glare crystal for easy-to-read dial



Newly designed contact point holder prevents backlash



Includes NIST-traceable Certificate of Inspection - bidirectional

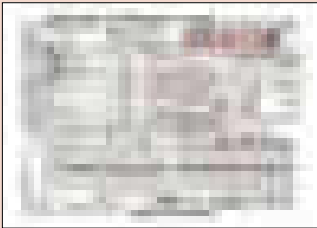

- One piece movement for high-impact resistance and durability
- Contact point length is printed on dial face to avoid accuracy issues
- Scratch and smudge-resistant, anti-glare crystal for easy-to-read dial
- Newly designed contact point holder prevents backlash
- Includes NIST-traceable Certificate of Inspection - bidirectional
- Limit hands (optional) can be attached to the bezel, allowing easy identification of the upper and lower limits of tolerance.
- A  $\varnothing 8\text{mm}$  ( $\varnothing 0.315$  in) plain stem (21CAB104) for the Metric models or a  $\varnothing 9.52\text{mm}$  ( $\varnothing 3/8$  in) plain stem (21CAB105) for the Inch models that attaches to any dovetail on the frame is supplied as a standard accessory. Other sizes are available as optional accessories:
  - $\varnothing 4\text{mm}$  ( $\varnothing 0.157$  in) stem: **21CAB106**
  - $\varnothing 6\text{mm}$  ( $\varnothing 0.236$  in) stem: **21CAB103**
- Optional ruby tip has wear-resistance several times greater than a carbide tip and, since it is nonconductive, it can be used safely on an electrical discharge machine.
- Using universal fonts, changing dial face color and reviewing the relationship between pointer and scale marks have drastically improved readability.
- The O-ring seal on the bezel provides smooth rotation and prevents dust and oil from penetrating the dial face.
- Bonding the bezel and crystal eliminates a gap for cutting fluid or oil to penetrate the dial face.
- A flange prevents the bezel from unintentionally being removed during handling.
- Four models are available, each with a different orientation of the dial to allow the best visibility in any situation.
  - Standard - dial is on top of the frame.
  - Vertical: dial is on the end of the frame.
  - Standard ( $20^\circ$  tilted face): dial is on top of the frame but tilted  $20^\circ$ .
  - Horizontal: dial is on the side of the frame.
- The conventional method of mounting the stylus pivot bearing screw in the frame is prone to loosen with prolonged use. A unique sub-plate structure has been incorporated in all models to eliminate this issue.

One piece movement for high-impact resistance and durability

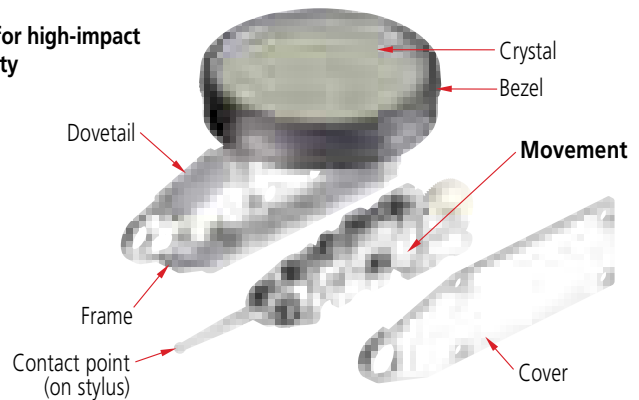

Four models are available:

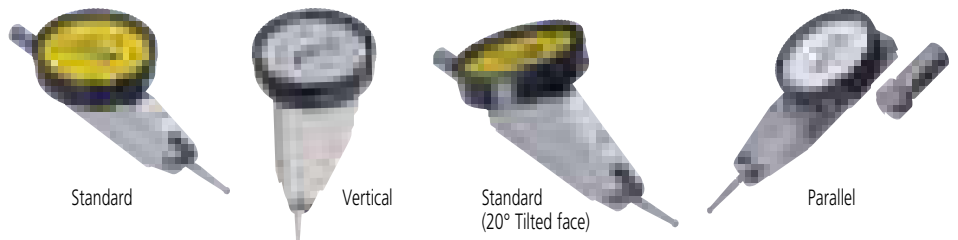

# Dial Test Indicators

## SERIES 513 — Horizontal Type

### FEATURES

- Performs easy and accurate measurement of narrow or recessed areas, plus inside and outside diameters that dial indicators cannot access.
- No-clutch structure for automatic reversal of measuring direction.
- One-piece bezel and crystal design with O-ring provide resistance to water and dust.
- The glare-free flat crystal face has a scratch-resistant coating.
- High sensitivity and quick response because of jeweled bearings.
- Standard carbide contact point provide.



513-424-10E



513-414-10E



513-404-10E



513-402-10E

### DIMENSIONS AND MASS

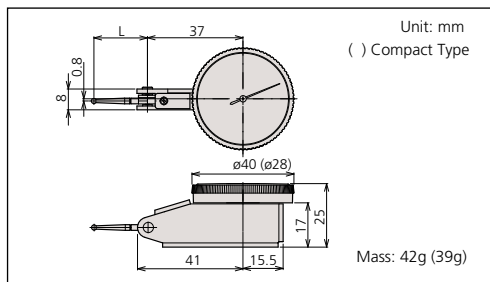

### Optional Accessories

- : Swivel clamp
- : Holding bar
- : Stem
- : Contact points

### Special Set: No. 513-908-10E (mm)

- 513-404-10E: Dial test indicator
- 7014-10E: Mini magnetic stand

### No. 513-907-10E (inch)

- 513-402-10E: Dial test indicator
- 7014E-10: Mini magnetic stand



### Description of Icon

Icon	Description
	With revolution counter
	Long contact point
	Jeweled bearing
	Double scale spacing, easy to read
	Compact
	Dustproof
	Anti-magnetic



## Set Configuration: Test Indicators

Inch

**Full set**

Contact point, .039" DIA. carbide  
 Contact point, .118" DIA. carbide  
 Stem, .157" DIA. (21CAB106)

Swivel clamp (900322, for .157" DIA., 3/8" DIA., dovetail)  
 Inch holding bar (L: 4") (900306)

**Basic set**

Contact point, .079" DIA. (Carbide)  
 Indicator  
 Knurled clamp ring  
 Stem, 3/8" DIA. (Set No. 21CZB130)

Metric

**Full set**

Swivel clamp (900321, for ø4mm, ø8mm, dovetail)  
 Metric holding bar (L: 100mm) (900209)

**Plus set**

Contact point, ø1mm carbide  
 Contact point, ø3mm carbide  
 Stem, ø4mm (21CAB106)

**Basic set**

Contact point, ø2mm (Carbide)  
 Indicator  
 Knurled clamp ring  
 Stem, ø8mm (Set No. 21CZB129)



Anti-magnet type



Double scale spacing type



Long contact point type



Jeweled bearing type



Compact type



With revolution counter type



## SPECIFICATIONS

Inch

Graduation	Order No.		Range	Accuracy	Dial reading	Measuring force	L (mm)						—	—
	Basic set	Full set												
.00005"	513-407-10E	513-407-10T	.008"	±.0001"	0-4-0	0.3N or less	19	✓	—	✓	—	—	—	—
.0005"	513-402-10E	513-402-10T	.03"	±.0005"	0-15-0	0.3N or less	19.9	✓	—	✓	—	—	—	—
.0005"	513-472-10E*		.03"	±.0005"	0-15-0	0.3N or less	19.9	✓	—	✓	—	—	—	—
.0005"	513-412-10E	513-412-10T	.03"	±.0005"	0-15-0	0.2N or less	33.9	✓	✓	✓	—	—	—	—
.0005"	513-479-10E*		.03"	±.0005"	0-15-0	0.2N or less	33.9	✓	✓	✓	—	—	—	—
.0005"	513-462-10E		.03"	±.0005"	0-15-0	0.3N or less	19.9	✓	—	✓	✓	—	—	—
.0001"	513-403-10E	513-403-10T	.008"	±.0001"	0-4-0	0.3N or less	19	✓	—	✓	—	—	—	—
.0001"	513-473-10E*		.008"	±.0001"	0-4-0	0.3N or less	19	✓	—	✓	—	—	—	—
.0001"	513-463-10E		.008"	±.0001"	0-4-0	0.3N or less	15	✓	—	✓	✓	—	—	—

\*Provided with a ø2mm ruby contact point as a substitute for ø2mm carbide contact point.

Metric

Graduation	Order No.		Range	Accuracy	Dial reading	Measuring force	L (mm)							—	—
	Basic set	Full set													
0.01mm	513-424-10E	513-424-10T	0.5mm	5µm	0-25-0	0.3N or less	22.3	✓	✓	—	✓	—	—	—	—
0.01mm	513-414-10E	513-414-10T	0.5mm	10µm	0-25-0	0.2N or less	36.8	✓	✓	✓	✓	—	—	—	—
0.01mm	513-466-10E	-	0.5mm	5µm	0-25-0	0.3N or less	22.3	✓	✓	—	✓	✓	—	—	—
0.01mm	513-478-10E*	-	0.5mm	5µm	0-25-0	0.3N or less	22.3	✓	—	—	✓	—	—	—	—
0.01mm	513-404-10E	513-404-10T	0.8mm	8µm	0-40-0	0.3N or less	20.9	✓	—	—	✓	—	—	—	—
0.01mm	513-474-10E*	-	0.8mm	8µm	0-40-0	0.3N or less	20.9	✓	—	—	✓	—	—	—	—
0.01mm	513-464-10E	-	0.8mm	8µm	0-40-0	0.3N or less	20.9	✓	—	—	✓	✓	—	—	—
0.01mm	513-415-10E	513-415-10T	1mm	10µm	0-50-0	0.2N or less	44.5	✓	—	✓	✓	—	—	—	—
0.01mm	513-477-10E*	-	1mm	10µm	0-50-0	0.2N or less	44.5	✓	—	✓	✓	—	—	—	—
0.01mm	513-426-10E	-	1.5mm	16µm	0-25-0	0.4N or less	22.3	✓	✓	—	✓	—	—	—	—
0.002mm	513-405-10E	513-405-10T	0.2mm	4µm	0-100-0	0.3N or less	14.7	✓	—	—	✓	—	—	—	—
0.002mm	513-465-10E	-	0.2mm	4µm	0-100-0	0.3N or less	14.7	✓	—	—	✓	✓	—	—	—
0.002mm	513-475-10H*	-	0.2mm	4µm	0-100-0	0.3N or Less	18.7	✓	—	—	✓	—	—	—	—
0.002mm	513-425-10E	-	0.6mm	7µm	0-100-0	0.4N or less	14.7	✓	—	—	✓	—	—	—	—
0.001mm	513-401-10E	-	0.14mm	4µm	0-70-0	0.3N or less	12.8	✓	—	—	✓	—	—	—	—
0.001mm	513-471-10E*	-	0.14mm	4µm	0-70-0	0.3N or less	12.8	✓	—	—	✓	—	—	—	—

\*Provided with a ø2mm ruby contact point as a substitute for ø2mm carbide contact point.

Metric/inch

Graduation	Order No.		Range	Accuracy	Dial reading	Measuring force	L (mm)			—	—	—	—
	Basic set	Full set											
0.002mm, .0001"	513-409-10E	513-409-10T	0.2mm, .0075"	3µm	0-10-0, 0-38-0	0.3N or less	14.7	✓	✓	—	—	—	—

Inch/Metric

Graduation	Order No.		Range	Accuracy	Dial reading	Measuring force	L (mm)			—	—	—	—
	Basic set	Full set											
.0005", 0.01mm	513-406-10E	513-406-10T	.03", 0.7mm	±.0005"	0-15-0, 0-35-0	0.3N or less	19.9	✓	✓	—	—	—	—

# Dial Test Indicators

**SERIES 513 — Horizontal (20° Tilted Face), Vertical and Parallel**

## FEATURES

- Specially designed for easy viewing of measurements.

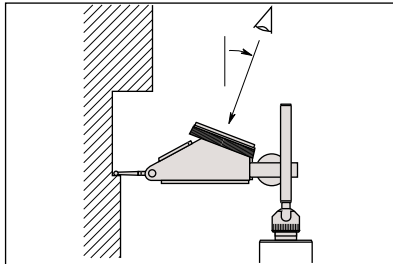

- The dial face points upward, allowing users to read the graduations from the user's side. It is convenient when measuring on the side of a large workpiece and the workbench is high.

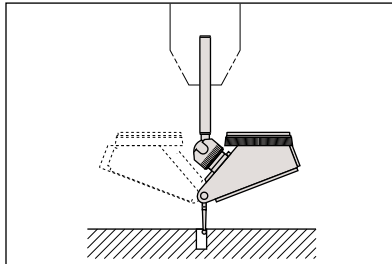

- Using the universal holder allows easy hole centering. The dial face always faces upward when the indicator is rotated for easy reading.



513-444-10E



513-445-10E



513-454-10E  
513-484-10E



513-455-10E



513-452-10E



513-482-10A



513-444-10E



513-455-10E



513-484-10E



513-442-10A



513-446-10A

## Optional Accessories

- : Swivel clamp
- : Holding bar
- : Stem
- : Contact points

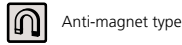

Anti-magnet type

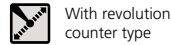

With revolution counter type



Jeweled bearing type

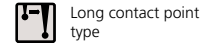

Long contact point type

## Set Configuration: Test Indicators

Inch

**Full set**

Contact point, .039" DIA. carbide

Contact point, .118" DIA. carbide

Stem, .157" DIA. (21CAB106)

Swivel clamp (900322, for .157" DIA., 3/8" DIA., dovetail)

Inch holding bar (L: 4") (900306)

**Basic set**

Contact point, .079" DIA. (Carbide)

Knurled clamp ring

Indicator

Stem, 3/8" DIA. (Set No. 21CZB130)

Metric

**Full set**

Swivel clamp (900321, for ø4mm, ø8mm, dovetail)

Metric holding bar (L: 100mm) (900209)

**Plus set**

Contact point, ø1mm carbide

Contact point, ø3mm carbide

Stem, ø4mm (21CAB106)

**Basic set**

Contact point, ø2mm (Carbide)

Knurled clamp ring

Indicator

Stem, ø8mm (Set No. 21CZB129)

## SPECIFICATIONS

**Metric** Horizontal (20° tilted face) type

Graduation	Order No.		Range	Accuracy	Dial reading	Measuring force	Mass (g)	L (mm)			
	Basic set	Full set									
0.01mm	513-444-10E	513-444-10T	1.6mm	10µm	0-40-0	0.3N or less	48	20.9	<input checked="" type="checkbox"/>	<input checked="" type="checkbox"/>	<input checked="" type="checkbox"/>
0.002mm	513-445-10E	513-445-10T	0.4mm	5µm	0-100-0	0.3N or less	48	14.7	<input checked="" type="checkbox"/>	<input checked="" type="checkbox"/>	<input checked="" type="checkbox"/>

**Inch** Horizontal (20° tilted face) type

Graduation	Order No.		Range	Accuracy	Dial reading	Measuring force	Mass (g)	L (mm)					Remarks
	Basic set	Full set											
.0005"	513-442-10A	513-442-10T	.06"	±.0005"	0-15-0	0.3N or less	48	19.9	<input checked="" type="checkbox"/>	<input checked="" type="checkbox"/>	<input checked="" type="checkbox"/>	<input type="checkbox"/>	—
.0005"	513-442-16A	513-442-16T	.06"	±.0005"	0-15-0	0.3N or less	48	19.9	<input checked="" type="checkbox"/>	<input checked="" type="checkbox"/>	<input checked="" type="checkbox"/>	<input type="checkbox"/>	Black dial
.0005"	513-446-10A	513-446-10T	.06"	±.0005"	0-15-0	0.2N or less	48	33.9	<input checked="" type="checkbox"/>	<input checked="" type="checkbox"/>	<input checked="" type="checkbox"/>	<input type="checkbox"/>	—
.0005"	513-446-16A	513-446-16T	.06"	±.0005"	0-15-0	0.2N or less	48	33.9	<input checked="" type="checkbox"/>	<input checked="" type="checkbox"/>	<input checked="" type="checkbox"/>	<input type="checkbox"/>	Black dial
.0001"	513-443-10A	513-443-10T	.016"	±.0002"	0-4-0	0.3N or less	48	15	<input checked="" type="checkbox"/>	<input checked="" type="checkbox"/>	<input checked="" type="checkbox"/>	<input type="checkbox"/>	—
.0001"	513-443-16A	513-443-16T	.016"	±.0002"	0-4-0	0.3N or less	48	15	<input checked="" type="checkbox"/>	<input checked="" type="checkbox"/>	<input checked="" type="checkbox"/>	<input type="checkbox"/>	Black dial

**Metric** Vertical type

Graduation	Order No.		Range	Accuracy	Dial reading	Measuring force	Mass (g)	L (mm)		
	Basic set	Full set								
0.01mm	513-454-10E	513-454-10T	0.8mm	8µm	0-40-0	0.3N or less	50	20.9	<input checked="" type="checkbox"/>	<input checked="" type="checkbox"/>
0.002mm	513-455-10E	513-455-10T	0.2mm	3µm	0-100-0	0.3N or less	50	14.7	<input checked="" type="checkbox"/>	<input checked="" type="checkbox"/>

**Inch** Vertical type

Graduation	Order No.		Range	Accuracy	Dial reading	Measuring force	Mass (g)	L (mm)		
	Basic set	Full set								
.0005"	513-452-10E	513-452-10T	.03"	±.0005"	0-15-0	0.3N or less	50	19.9	<input checked="" type="checkbox"/>	<input checked="" type="checkbox"/>
.0001"	513-453-10E	513-453-10T	.008"	±.0001"	0-4-0	0.3N or less	50	19	<input checked="" type="checkbox"/>	<input checked="" type="checkbox"/>

**Metric** Parallel type

Graduation	Order No.		Range	Accuracy	Dial reading	Measuring force	Mass (g)	L (mm)		
	Basic set	Full set								
0.01mm	513-484-10E	513-484-10T	0.8mm	8µm	0-40-0	0.3N or less	68	20.9	<input checked="" type="checkbox"/>	<input checked="" type="checkbox"/>

**Inch** Parallel type

Graduation	Order No.		Range	Accuracy	Dial reading	Measuring force	Mass (g)	L (mm)		
	Basic set	Full set								
.0005"	513-482-10A	513-482-10T	.03"	±.0005"	0-15-0	0.3N or less	68	20	<input checked="" type="checkbox"/>	<input checked="" type="checkbox"/>

## DIMENSIONS

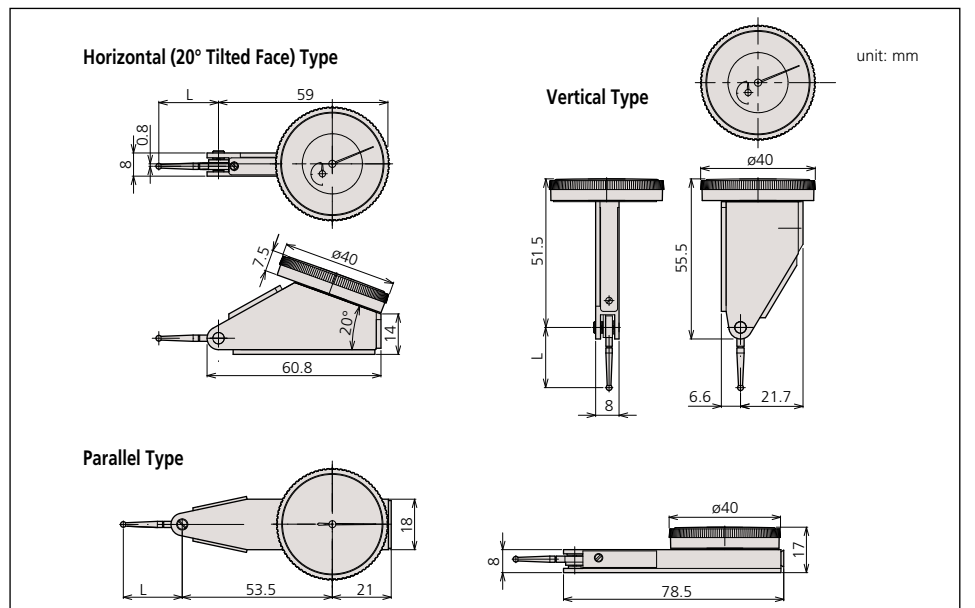

# Pocket Dial Test Indicators

## SERIES 513

### FEATURES

- Jeweled bearings ensure high sensitivity and accuracy.
- Reversible measuring direction.
- Two holding bars are supplied. (Full sets only.)
- Fully adjustable bezel/dial face.
- Contact point is adjustable within 220°.
- Bezel is sealed with an O-ring to keep out water / oil.

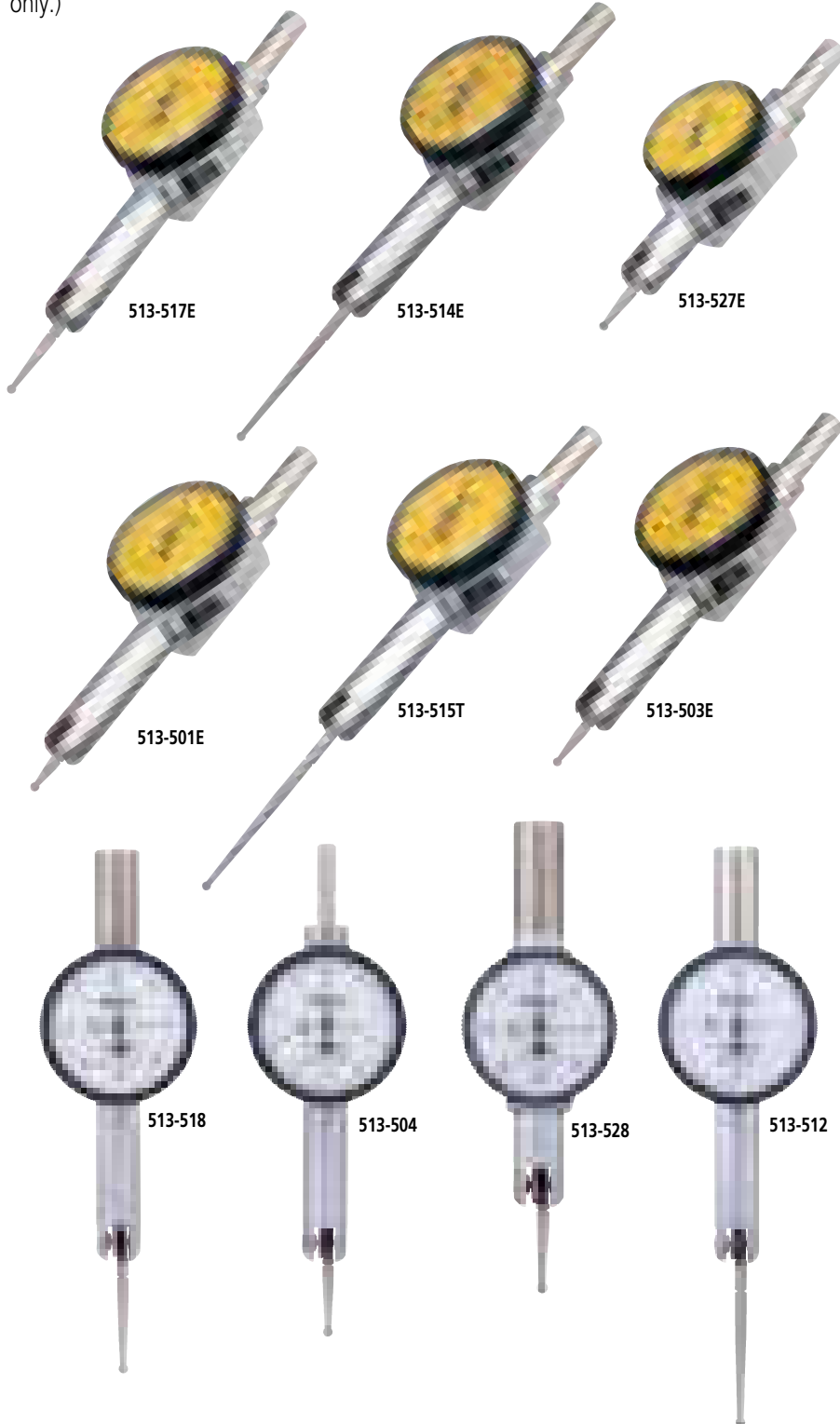

513-514E



513-517E  
513-527E



513-515T



513-503E



513-501E

### Optional Accessories

- : Swivel clamp
- : Holding bar
- : Stem
- : Contact points

## Set Configuration: Metric

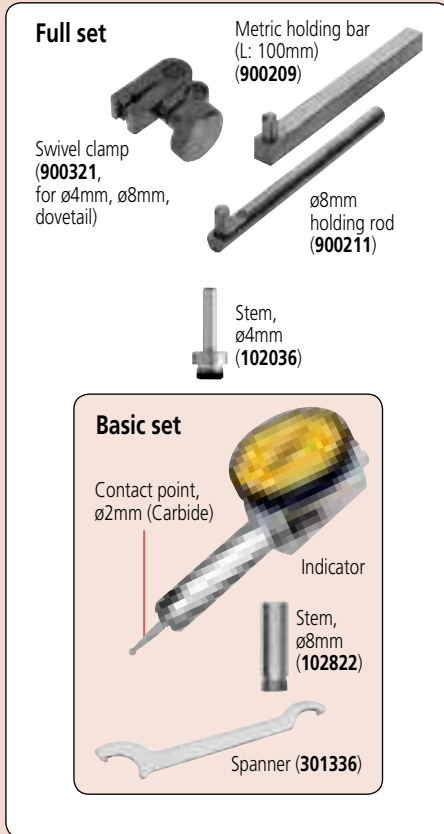

## Set Configuration: Inch

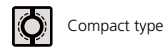
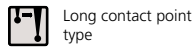
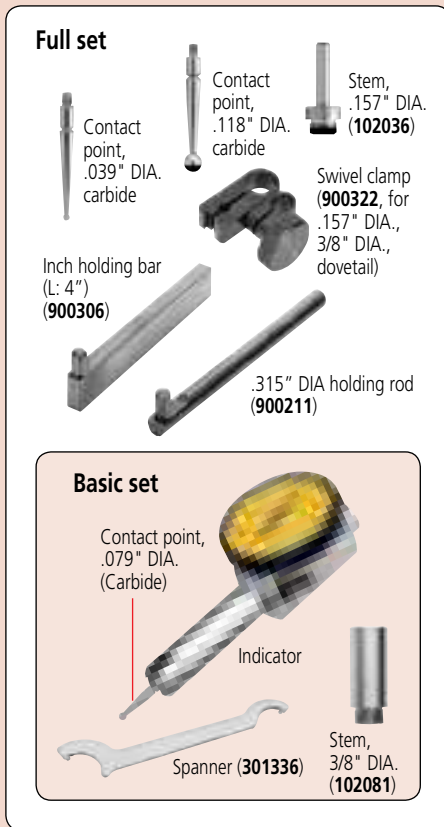

## SPECIFICATIONS

### Metric

Graduation	Order No.		Range	Accuracy	Dial reading	Measuring force	L (mm)			
	Basic set	Full set								
0.01mm	513-514E	513-514T	0.5mm	10µm	0-25-0	0.3N or less	36.8	✓	✓	—
0.01mm	513-517E	513-517T	0.8mm	8µm	0-40-0	0.3N or less	20.9	—	✓	—
0.01mm	513-527E	513-527T	0.8mm	8µm	0-40-0	0.3N or less	14.7	—	✓	✓
0.01mm	—	513-515T	1mm	10µm	0-50-0	0.3N or less	44.5	✓	✓	—
0.002mm	513-503E	513-503T	0.2mm	3µm	0-100-0	0.3N or less	14.7	—	✓	—
0.001mm	513-501E	513-501T	0.14mm	3µm	0-70-0	0.4N or less	12	—	✓	—

### Inch

Graduation	Order No.		Range	Accuracy	Dial reading	Measuring force	L (mm)			
	Basic set	Full set								
.001"	513-518	513-518T	.04"	±.001"	0-20-0	0.3N or less	26.5	—	✓	—
.001"	513-528	513-528T	.04"	±.001"	0-20-0	0.3N or less	18.7	—	✓	✓
.0005"	513-512	513-512T	.02"	±.0005"	0-10-0	0.3N or less	37.4	✓	✓	—
.0001"	513-504	513-504T	.01"	±.0002"	0-5-0	0.3N or less	18.7	—	✓	—

## Optional Contact Points

### Pocket Type

Order No.	1mm	2mm	3mm	0.5mm	0.7mm
513-501E	136756	136104	136758	—	—
513-503E 513-527E	103017	103010	103018	190547	190548
513-504 513-528	131314	103011	131315	—	—
513-512	131316	131324	131317	—	—
513-514E	137746	129949	137747	—	—
513-515T	136235	136013	136236	190656	190655
513-517E	103013	103006	103014	190549	190550
513-518	103008	103007	103009	—	—

## DIMENSIONS AND MASS

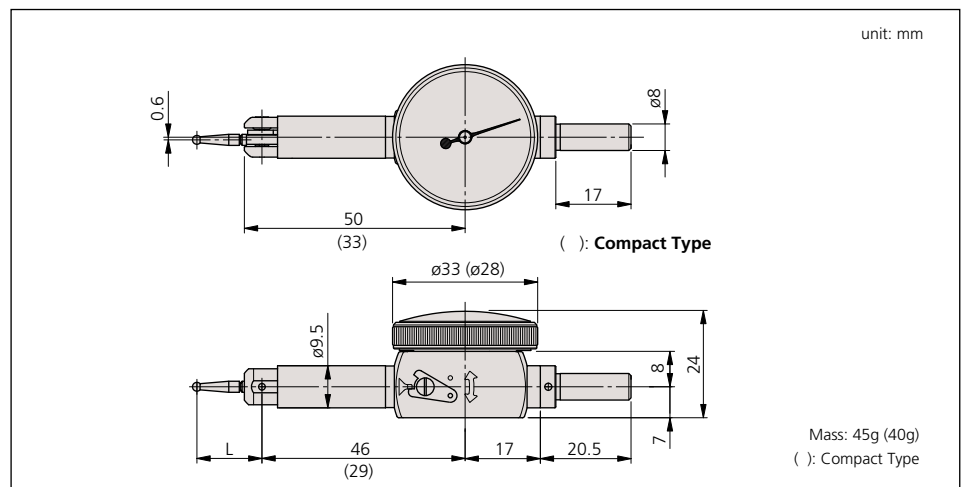

# Dial Test Indicators

## SERIES 513 — Universal Type

### FEATURES

- Universal application for all directions. Not only the direction of the measuring point, but also the direction of measurement itself can be adjusted 360 degrees without moving the indicator.

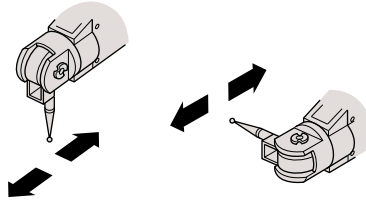

513-304GE

### SPECIFICATIONS



#### Metric

Graduation	Order No.		Range	Accuracy	Dial reading	Measuring force	
	Basic set	Full set					
0.01mm	513-304GE	513-304GT	0.8mm	8µm	0-40-0	0.3N or less	✓

#### Inch

Graduation	Order No.		Range	Accuracy	Dial reading	Measuring force	
	Basic set	Full set					
.0005"	513-302G	513-302GT	.03"	±.0005"	0-15-0	0.3N or less	✓

### DIMENSIONS AND MASS

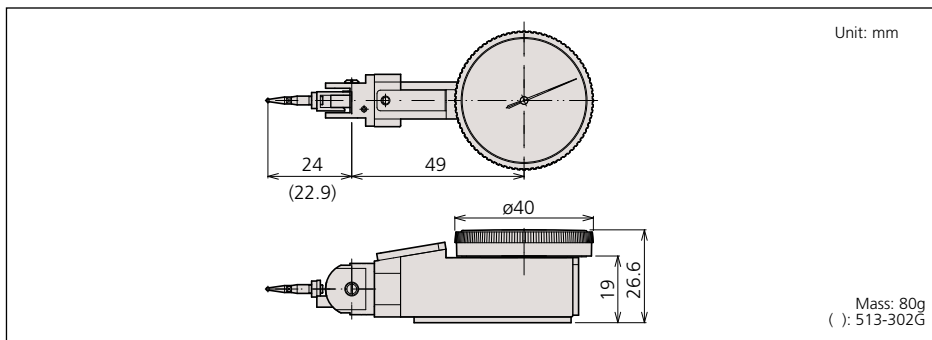

### Set Configuration: Metric

#### Full set

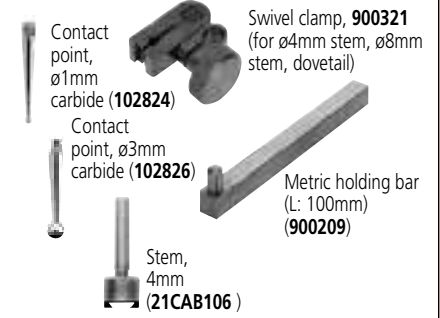

#### Basic set

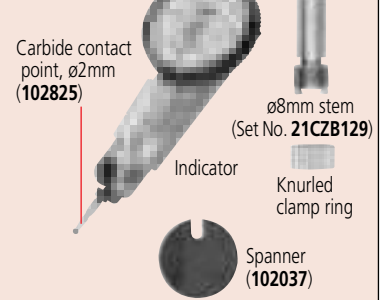

### Set Configuration: Inch

#### Full set

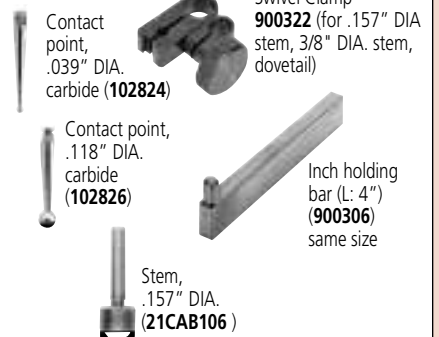

#### Basic set

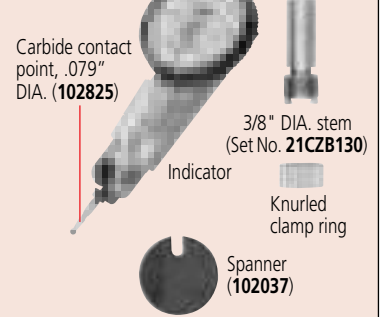

### Optional Accessories

- : Swivel clamp
- : Holding bar
- : Stem

# Contact Points and Clamp Holders

## Optional Accessories for Dial Test Indicator

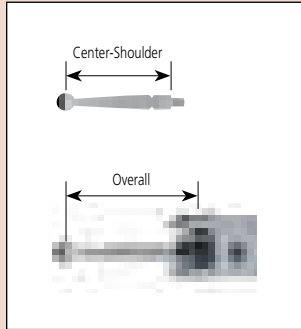

Inch										
Length (mm)		Part No.						Test Indicator Code No.		
Center-Shoulder	Overall	ø0.5	ø0.7	ø1	ø2	ø3	Ruby Ø2mm			
11.5	15.0	—	—	136076	136075	136077	21CZA213	513-403-10E 513-453-10E	513-443-10A 513-463-10E	513-473-10E <sup>3</sup> 513-443-16A
16.4	19.9	—	—	133196	133195	133197	21CZA204	513-401-10E 513-406-10E 513-452-10E	513-442-10A 513-462-10E	513-472-10E <sup>3</sup> 513-442-16A 513-482-10A
30.4	33.9	—	—	136291	136290	136292	21CZA214	513-412-10E 513-446-16A	513-446-10A	
15.2	18.7	—	—	131314	103011	131315	—	513-504 <sup>1</sup>	513-528 <sup>1</sup>	
23.0	26.5	—	—	103008	103007	103009	—	513-518 <sup>1</sup>		
33.9	37.4	—	—	131316	131324	131317	—	513-512 <sup>1</sup>		

Metric										
Length (mm)		Part No.						Test Indicator Code No.		
Center-Shoulder	Overall	ø0.5	ø0.7	ø1	ø2	ø3	Ruby Ø2mm			
9.4	12.9	—	—	21CZA044	21CZA036	21CZA045	21CZA212	513-401-10E	513-471-10E	
11.2	14.7	190547	190548	103017	103010	103018	21CZA209	513-405-10E 513-503E 513-527E	513-425-10E 513-455-10E 513-455-10E	513-445-10E
17.4	20.9	190549	190550	103013	103006	103014	21CZA201	513-404-10E 513-464-10E 513-484-10E	513-444-10E 513-517E <sup>1</sup>	513-454-10E 513-474-10E <sup>3</sup>
18.7	22.2	190654	190653	137558	137557	137559	21CZA210	513-424-10E 513-478-10H <sup>3</sup>	513-426-10E	513-466-10E
41.0	44.5	190656	190655	136235	136013	136236	21CZA211	513-415-10E	513-515T <sup>1</sup>	
33.3	36.8	—	—	137746	129949	137747	—	513-414-10E	513-514E <sup>1</sup>	
8.6	12.0	—	—	136756	136104	136758	—	513-501E <sup>1</sup>		
6.5	24.0	—	—	102824	102825	102826	—	513-304GE <sup>2</sup>	513-302G <sup>2</sup>	

\*1 Denotes Pocket Indicators  
\*2 Denotes Universal Indicator  
\*3 Indicator Ships with Ruby Contact

### Holding Bars (with 6mm mounting pin)

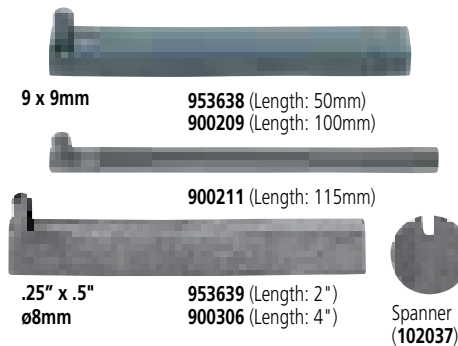

### Universal Holder

- Allows the indicator to be set at a desired position.

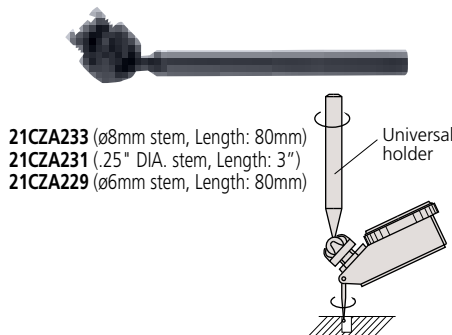

### Centering Holder

- Allows large diameter cylinders or holes to be centered.

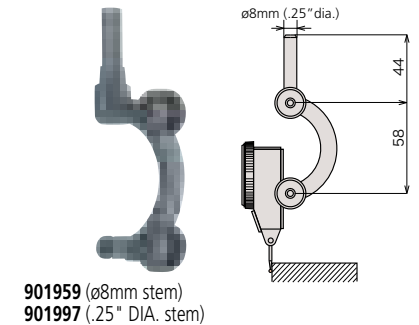

### Universal Holder (pocket type)

- Since the Dial Test Indicator can be swiveled to a desired angle, the holder is useful for centering workpieces and installing workpieces on a milling machine.

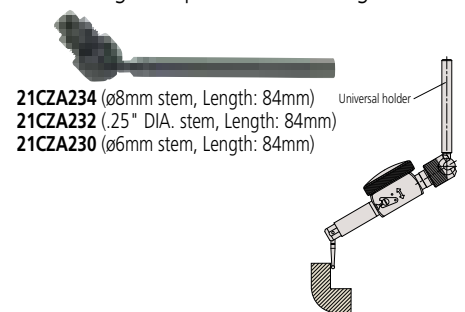

# i-Checker

## SERIES 170 – Inspection Instrument for Dial Indicator

The i-Checker is specially designed to calibrate dial indicators, dial test indicators, and other electronic comparison gage heads with a stroke of up to 100mm (4").

- $\pm(0.1+0.4L/100)$   $\mu\text{m}$  indication accuracy.
- Directly inspects an indicator with a stroke of up to 100mm (4"). The dial test indicator, bore gage and lever-type inductive head can be inspected with optional accessories.

- Adjustment of the measurement position is easily accomplished due to semi-automatic measurement and fully automatic measurement functions.
- Creates and prints out a simple inspection certificate.
- Saves inspection results as a CSV file for analysis by software.



## SPECIFICATIONS

Order No.	Remarks
64PKA148	comes with both 8mm and 3/8" bushing

Recommended PC Part No. **64PKA149E**

## DIMENSIONS

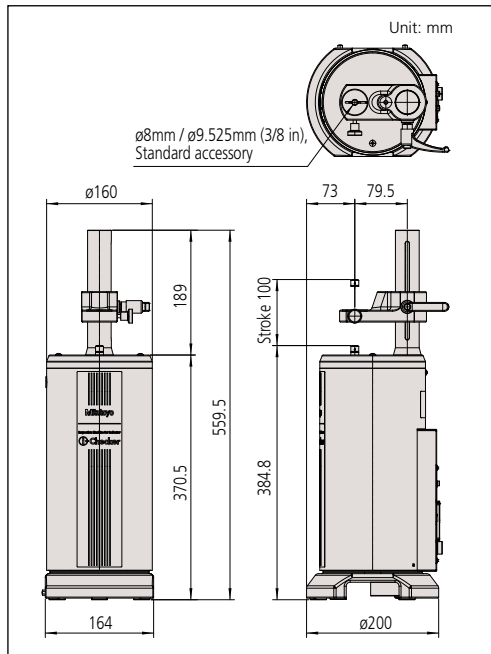

## Applicable Indicators

- Dial indicator
  - Hicator
  - Digimatic indicator\*\*\*
  - Test indicator\*
  - Bore gage\*\*
  - Linear gage
- \* Requires optional test indicator attachment set.  
 \*\* Contact the nearest Mitutoyo sales office for testable indicators.  
 \*\*\* Requires optional SPC cable for fully automatic measurement.



Using test indicator attachment set (02ASK000)



## Technical Data

Measuring Range: 100mm / 4"  
 Resolution: 0.01  $\mu\text{m}$  / 0.4  $\mu\text{in}$   
 Accuracy:  $\pm(0.1+0.4L/100)$   $\mu\text{m}$  in vertical position  
 $\pm(0.15+0.6L/100)$   $\mu\text{m}$  in lateral position  
 L = measuring length (mm)  
 Drive method: Motor direct drive  
 Measuring Unit: "STVC-4Z" linear encoder  
 Thermal Expansion coefficient: 0.4 ppm / °C  
 Measurement method: Semi / Full automatic\*  
 Dimensions: 116 x 205.5 x 559.5mm (W x D x H)  
 Operating temperature range: 20°C  $\pm$  0.5°C  
 Power supply: 100 – 240VAC  $\pm$ 10%, 50/60 Hz  
 Mass: 20kg / 44.1lbs

\* Automatic measurement requires the indicator's connection cable. Additionally, some form of indicator, along with a connecting machine (the optional accessory for indicator as a Digimatic power-supply unit on EF counter), will be needed.

## Functions

### Semi-automatic inspection of analog indicator

The pointer of the analog indicator is positioned just before the measuring point automatically via Mitutoyo's Semi-automatic Measurement function. After that, inspection begins simply by adjusting the pointer position with the jog-dial. Because of this function, measurement time is reduced and user fatigue is practically eliminated. Additionally all functions necessary for inspection are combined in the control box so that the operator need not rely on excessive eye movement to adjust the pointer.

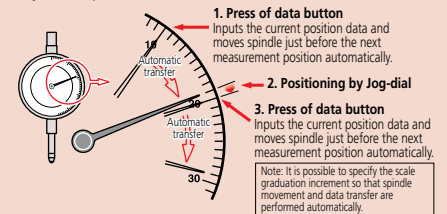
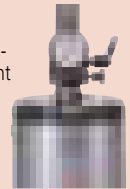

### Fully automatic inspection of digital indicator

The Automatic Measurement function, in tandem with a digital indicator, makes the spindle move so that measurement data is acquired automatically. Therefore, manual adjustment to the measurement position is unnecessary and the efficiency of every inspection is enhanced.



### Create and printout a simplified inspection certificate

Create, edit and print your own inspection certificate. Data can be saved as a CSV file.

## Optional Accessories

- 02ASK000: Test indicator attachment set ( $\phi$ 6mm stem)
- 02ASK180: Test indicator attachment set ( $\phi$ 8mm stem)
- 02ASK370: Test indicator holder ( $\phi$ 6mm stem)
- 02ASK380: Test indicator holder ( $\phi$ 8mm stem)
- 02ASU162: CG accessory set (type C) for bore gages\*
- 21CZB128:  $\phi$ 6mm dovetail grooved stem
- 21CZB129:  $\phi$ 8mm dovetail grooved stem
- 02ASK040: Stem bush  $\phi$ 6mm
- 02ASJ856: Stem bush  $\phi$ 8mm
- 02ASK150: Stem bush  $\phi$ 8mm, short
- 02ASL150: Stem bush  $\phi$ 10, short
- 02ASK050: Bush  $\phi$ 9.5 (Requires 02ASK070)
- 02ASK060: Stem bush  $\phi$ 12mm
- 02ASK070: Stem bush  $\phi$ 15mm
- 02ASK080: Stem bush  $\phi$ 20mm
- 02ASK710: Stem bush  $\phi$ 28mm
- 02ASK090: Stem bush 3/8"
- 02ASK130: Stem bush case
- 02ASK730: Reflector
- 937179T: Foot switch

\* Not compatible with IC1000 models





### Optional Accessory

**12AKK824:** Stand for bore gage inspection



# UDT-2 Dial Gage Testers

## SERIES 170

The UDT-2 Dial Gage Tester consists of a specially designed 0-1" / 0-25mm micrometer head, with a large disc, and rigid holding fixtures. Gage tester to calibrate measuring accuracy of dial indicators, dial test indicators and dial bore gage.

### FEATURES

- Clamping stem diameter—  
170-102-10: 6mm and 8mm,  
170-101-10: .25" and .375"
- With the optional stand (**12AAK824**), inspection of dial bore gages becomes possible.



170-102-10

### SPECIFICATIONS

Metric			
Range	Order No.	Graduation	Accuracy
0 - 25mm	<b>170-102-10</b>	0.001mm	±1µm

Inch			
Range	Order No.	Graduation	Accuracy
0 - 1"	<b>170-101-10</b>	.0001"	±.0001"

# Calibration Testers

## SERIES 521

The Calibration Tester is specially designed to calibrate measuring accuracy of short-range dial indicators, dial test indicators, and other electronic comparison gage heads.

### FEATURES

- Universal bracket accepts any dial indicator, dial test indicator, and lever head of Mu-Checker without any additional accessory.
- Clamping capacity: ø4mm - ø10mm / .157"-.394" dia.
- Dual color-indexed directional graduations to facilitate measurements.

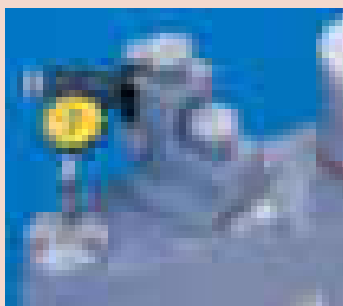

Calibrating test indicator



521-103

### SPECIFICATIONS

Metric			
Range	Order No.	Graduation	Accuracy
0 - 1mm	<b>521-103</b>	0.0002mm	±0.2µm
0 - 5mm	<b>521-105</b>	0.0002mm	±0.8µm

Inch			
Range	Order No.	Graduation	Accuracy
0 - .05"	<b>521-104</b>	.00001"	±.00001"
0 - .2"	<b>521-106</b>	.00001"	±.00003"

# Thickness Gages

## SERIES 547, 7

Thickness Gages offer a quick and efficient means of inspection with a convenient grip handle, thumb trigger and spring-loaded spindle. The various models cover a range of applications.

### FEATURES

• Wide range of applications with various types of measuring faces (on the spindle and anvil).

- Digital models incorporate Mitutoyo's popular ID-C and ID-S Series Digimatic Indicators to provide error-free LCD readings, as well as data output for SPC analysis.
- **547-400S** is ideally suited for measuring thicknesses of paper, film, wire, sheet metal and similar materials.

### Flat-Anvil Type

#### Standard Type / Digital



#### Deep-Throat Type / Digital



#### Deep-Throat Type / Dial

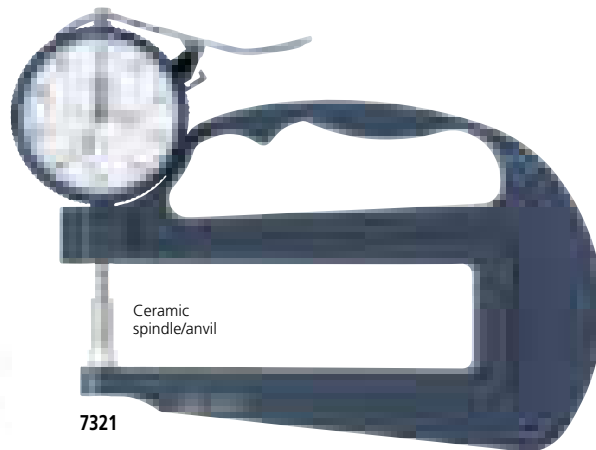

#### High-Accuracy Type / Digital



### DIMENSIONS

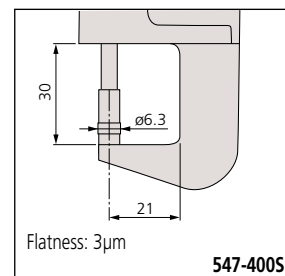

### Technical Data

#### Function of Digital Models

- IDS Types
- ON/OFF
  - Inch / mm Conversion
  - Origin
  - ±Direction Changeover
  - SPC Output
  - Battery Life: 20,000 hrs
  - Power Supply: Silver Oxide Cell (SR-44 1pc.)

#### IDC Types

- ON/OFF
- Inch / mm Conversion
- Zero / ABS
- ±Direction Changeover
- SPC Output
- Battery Life: 5,000 hrs
- Power Supply: Silver Oxide Cell (SR-44 1pc.)
- Preset
- Provides go/no-go judgment
- Face Rotates 330°

### DIMENSIONS

Unit: mm

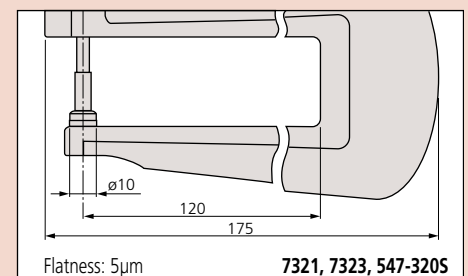
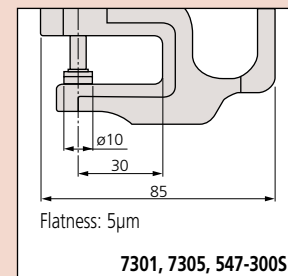

# Thickness Gages

## SERIES 547, 7

### Optional Accessories

- 905338:** SPC cable (40" / 1m) for digital type  
**905409:** SPC cable (80" / 2m) for digital type  
**902794:** Spindle lifting lever for IDS digimatic type (stroke .5" / 12.7mm)

### Standard Accessories

- 21AZB149:** Spindle lifting lever for digimatic and dial thickness gage (stroke .5" / 12.7mm)  
**21AZB150:** Spindle lifting lever for dial indicator (stroke 1" / 25.4mm)

### Flat Anvil

#### SPECIFICATIONS

Inch/Metric		Digital Type				
Range	Order No.	Resolution	Accuracy	Measuring Force	Indicator	Spindle/Anvil Material
0 - .47" / 0 - 12mm	<b>547-500S</b>	.0005"/0.01mm	±.001"	1.5N or less	Digimatic IDS	Ceramic
0 - .47" / 0 - 12mm	<b>547-520S</b>	.0005"/0.01mm	±.001"	1.5N or less	Digimatic IDS	Ceramic
0 - .47" / 0 - 12mm	<b>547-526S</b>	.0001"/0.001mm	±.0002"	1.5N or less	Digimatic IDS	Ceramic
0 - .4" / 0 - 10mm	<b>547-300S</b>	.0005"/0.01mm	±.001"	1.5N or less	Digimatic IDC	Ceramic
0 - .4" / 0 - 10mm	<b>547-320S</b>	.0005"/0.01mm	±.001"	1.5N or less	Digimatic IDC	Ceramic
0 - .47" / 0 - 12mm	<b>547-400S</b>	.0005"/0.001mm	±.00015"	3.5N or less	Digimatic IDC	Carbide

#### Inch Dial Type

Range	Order No.	Graduation	Accuracy	Measuring Force	Remarks
0 - .05"	<b>7326S</b>	.0001"	±.0002"	1.4N or less	Fine dial reading, ceramic spindle/anvil
0 - .5"	<b>7300S</b>	.001"	±.001"	1.4N or less	Standard, ceramic spindle/anvil
0 - 1"	<b>7304S</b>	.001"	±.002"	2.0N or less	Standard, ceramic spindle/anvil
0 - 1"	<b>7322S</b>	.001"	±.002"	2.0N or less	Deep throat, ceramic spindle/anvil

#### Metric Dial Type

Range	Order No.	Graduation	Accuracy	Measuring Force	Remarks
0 - 1mm	<b>7327</b>	0.001mm	±5µm	1.4N or less	Fine dial reading, ceramic spindle/anvil
0 - 10mm	<b>7301</b>	0.01mm	±15µm	1.4N or less	Standard, ceramic spindle/anvil
0 - 20mm	<b>7305</b>	0.01mm	±20µm	2.0N or less	Standard, ceramic spindle/anvil
0 - 10mm	<b>7321</b>	0.01mm	±15µm	1.4N or less	Deep throat, ceramic spindle/anvil
0 - 20mm	<b>7323</b>	0.01mm	±22µm	2.0N or less	Deep throat, ceramic spindle/anvil

### DIMENSIONS

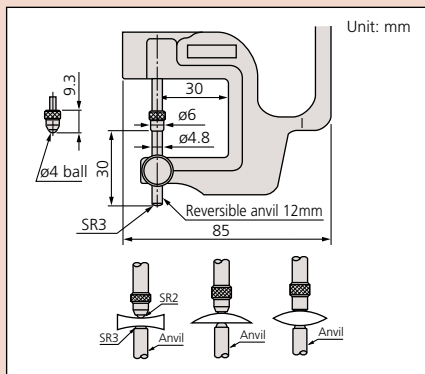

### Lens thickness measurement (reverse anvil)



#### SPECIFICATIONS

Inch/Metric		Digital Type			
Range	Order No.	Resolution	Accuracy	Measuring Force	Indicator
0 - .47" / 0 - 12mm	<b>547-512S</b>	.0005"/0.01mm	±.001"	1.5N or less	Digimatic IDS
0 - .4" / 0 - 10mm	<b>547-312S</b>	.0005"/0.01mm	±.001"	1.5N or less	Digimatic IDC

#### Inch Dial Type

Range	Order No.	Graduation	Accuracy	Measuring Force	Remarks
0 - .5"	<b>7312S</b>	.001"	±.001"	1.4N or less	Lens thickness

#### Metric Dial Type

Range	Order No.	Graduation	Accuracy	Measuring Force	Remarks
0 - 10mm	<b>7313</b>	0.01mm	±15µm	1.4N or less	Lens thickness

# Thickness Gages

## SERIES 547, 7

### Tube thickness measurement



547-3615

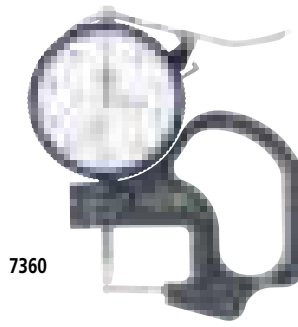

7360

### SPECIFICATIONS

**Inch/Metric** Digital Type

Range	Order No.	Resolution	Accuracy	Measuring Force	Indicator
0 - .47" / 0 - 12mm	<b>547-5615</b>	.0005"/0.01mm	±.001"	1.5N or less	Digimatic IDS
0 - .4" / 0 - 12mm	<b>547-3615</b>	.0005"/0.01mm	±.001"	1.5N or less	Digimatic IDC

**Inch** Dial Type

Range	Order No.	Graduation	Accuracy	Measuring Force	Remarks
0 - .5"	<b>73615</b>	.001"	±.001"	1.4N or less	Tube thickness

**Metric** Dial Type

Range	Order No.	Graduation	Accuracy	Measuring Force	Remarks
0 - 10mm	<b>7360</b>	0.01mm	±15µm	1.4N or less	Tube thickness

### DIMENSIONS

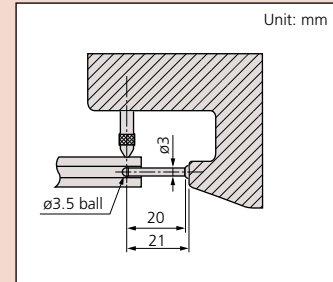

### Optional Accessories

- 905338:** SPC cable (40" / 1m) for digital type
- 905409:** SPC cable (80" / 2m) for digital type
- 902794:** Spindle lifting lever for IDS digimatic type (stroke .5" / 12.7mm)

### Standard Accessories

- 21AZB149:** Spindle lifting lever for digimatic and dial thickness gage (stroke .5" / 12.7mm)
- 21AZB150:** Spindle lifting lever for dial indicator (stroke 1" / 25.4mm)

### Groove thickness measurement (Blade anvil)



547-3165



7315

### SPECIFICATIONS

**Inch/Metric** Digital Type

Range	Order No.	Resolution	Accuracy	Measuring Force	Indicator
0 - .47" / 0 - 12mm	<b>547-5165</b>	.0005"/0.01mm	±.001"	1.5N or less	Digimatic IDS
0 - .47" / 0 - 10mm	<b>547-3165</b>	.0005"/0.01mm	±.001"	1.5N or less	Digimatic IDC

**Inch** Dial Type

Range	Order No.	Graduation	Accuracy	Measuring Force	Remarks
0 - .5"	<b>73165</b>	.001"	±.001"	1.4N or less	Groove thickness

**Metric** Dial Type

Range	Order No.	Graduation	Accuracy	Measuring Force	Remarks
0 - 10mm	<b>7315</b>	0.01mm	±15µm	1.4N or less	Groove thickness

### DIMENSIONS

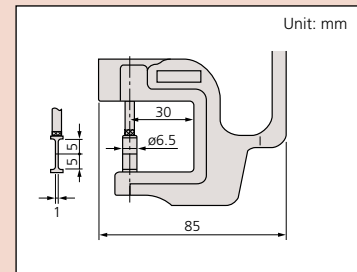

# Quick-Mini

## SERIES 700

A compact comparator designed for carrying convenience is suited for quick inspection of paper thickness, leather, wires, plastic parts, etc. The digital display provides error-free reading with 0.01mm / .0005" resolution.

### FEATURES

- Measuring force less than 2N.
- Notifications for:
  - Low battery voltage
  - Scale surface contamination
  - overflow
- Supplied in fitted plastic case.



700-118-20

### Technical Data

Accuracy: Refer to the list of specifications.  
 Resolution: 0.01mm or .0005"/0.01mm  
 Display: LCD  
 Battery: SR44 (1 pc.), **938882**  
 Battery life: Approx. 5 years under normal use

### Function

Zero-setting, Data hold, Power ON/OFF, inch/mm conversion (on inch/metric models only)



### SPECIFICATIONS

Metric		
Range	Order No.	Accuracy
0 - 12mm	<b>700-119-30</b>	±0.02mm

Inch/Metric		
Range	Order No.	Accuracy
0 - .5"/0 - 12.7mm	<b>700-118-30</b>	±.001"

### DIMENSIONS AND MASS

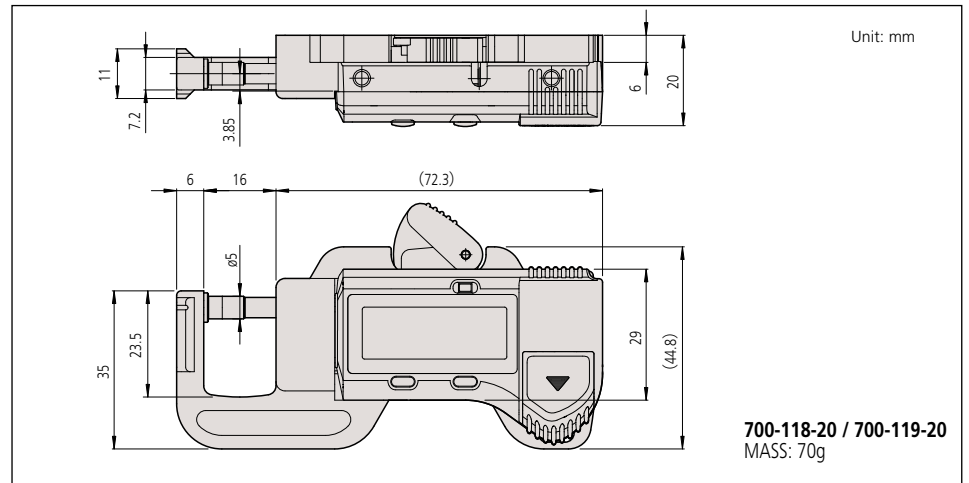

# Digimatic Caliper Gages

## SERIES 209 — Internal Tube Thickness Measurement

Versatile ID measuring gages for hole diameters, groove thickness, tube diameter and hard-to-reach dimensions. The Digimatic Caliper Gages provide error-free LCD readings, as well as data output for SPC analysis.

### Internal measurement type

209-552

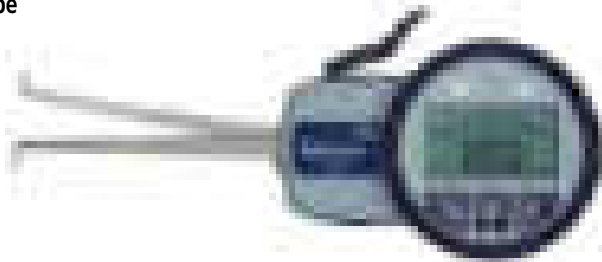

### Technical Data

Accuracy: Refer to the list of specifications  
 Resolution: .001", .0005", or .0002"  
 .01mm, 0.02mm, or 0.005mm  
 Display: LCD Analog / Digital  
 Power Supply: AAA Battery (2 pcs.)  
 Battery life: Approx. 350 hours  
 Measuring Force: 0.9 - 1.8N  
 Dust/Water protection level: IP67  
 Provided with inspection certificate.

### Function

Zeraset, Preset, Auto power off, Inch/Metric, conversion Data hold, Max/Min value holding, Data output

### Optional Accessories

**KPL1961-09** SPC Adapter  
**937387** Digimatic cable (1m)  
**965013** Digimatic cable (2m)  
**KPL8004-50** Holder for stand

## SPECIFICATIONS

Inch / Metric

Range	Order No.	Resolution	Accuracy	Max. Measuring Depth L	Max. Groove Depth A	Min. Groove Width B	Type of Measuring Contact	Mass(g)
.10 - .49" / 2.5 - 12.5mm	<b>209-550</b>	.0002" / 0.005mm	.0008" / 0.015mm	.47" / 12mm	.027" / 0.7mm	.023" / 0.5mm	Chisel R .0039" / 0.1mm	225
.20 - .59" / 5 - 15mm	<b>209-551</b>	.0002" / 0.005mm	.0008" / 0.015mm	1.37" / 35mm	.09" / 2.3mm	.032" / 0.8mm	Ball .024" / 0.6mm dia.	230
.39 - 1.18" / 10-30mm	<b>209-552</b>	.0005" / 0.01mm	.0015" / 0.03mm	3.3" / 85mm	.19" / 5.2mm	.06" / 1.2mm	Ball .04" / 1mm dia.	250
.79 - 1.58" / 20-40mm	<b>209-553</b>	.0005" / 0.01mm	.0015" / 0.03mm	3.3" / 85mm	.26" / 7mm	.06" / 1.2mm	Ball .04" / 1mm dia.	250
1.18 - 1.97" / 30-50mm	<b>209-554</b>	.0005" / 0.01mm	.0015" / 0.03mm	3.3" / 85mm	.26" / 7mm	.06" / 1.2mm	Ball .04" / 1mm dia.	255
1.58 - 2.36" / 40-60mm	<b>209-555</b>	.0005" / 0.01mm	.0015" / 0.03mm	3.3" / 85mm	.31" / 8.3mm	.06" / 1.2mm	Ball .04" / 1mm dia.	265
1.97 - 2.75" / 50-70mm	<b>209-556</b>	.0005" / 0.01mm	.0015" / 0.03mm	3.3" / 85mm	.31" / 8.3mm	.06" / 1.2mm	Ball .04" / 1mm dia.	265
2.36 - 3.15" / 60-80mm	<b>209-557</b>	.0005" / 0.01mm	.0015" / 0.03mm	3.3" / 85mm	.31" / 8.3mm	.06" / 1.2mm	Ball .04" / 1mm dia.	270
2.75 - 3.54" / 70-90mm	<b>209-558</b>	.0005" / 0.01mm	.0015" / 0.03mm	3.3" / 85mm	.31" / 8.3mm	.06" / 1.2mm	Ball .04" / 1mm dia.	270
0.51 - 1.69" / 13-43mm	<b>209-904</b>	.001" / 0.02mm	.002" / 0.04mm	5.0" / 127mm	.177" / 4.5mm	.079" / 2.0mm	Ball Ø.05" / 1.3mm	360
1.18 - 2.36" / 30-60mm	<b>209-906</b>	.001" / 0.02mm	.002" / 0.04mm	5.2" / 132mm	.256" / 6.5mm	.098" / 2.5mm	Ball Ø.06" / 1.5mm	370
1.97 - 3.15" / 50-80mm	<b>209-907</b>	.001" / 0.02mm	.002" / 0.04mm	5.2" / 132mm	.335" / 8.5mm	.098" / 2.5mm	Ball Ø.08" / 2mm	370
2.76 - 3.94" / 70-100mm	<b>209-908</b>	.001" / 0.02mm	.002" / 0.04mm	5.2" / 132mm	.335" / 8.5mm	.098" / 2.5mm	Ball Ø.08" / 2mm	375
3.54 - 4.72" / 90-120mm	<b>209-909</b>	.001" / 0.02mm	.002" / 0.04mm	5.2" / 132mm	.335" / 8.5mm	.098" / 2.5mm	Ball Ø.08" / 2mm	380
0.59 - 2.56" / 15-65mm	<b>209-905</b>	.001" / 0.02mm	.0024" / 0.06mm	7.4" / 188mm	.196" / 5mm	.087" / 2.2mm	Ball Ø.06" / 1.5mm	415
1.57 - 3.54" / 40-90mm	<b>209-910</b>	.001" / 0.02mm	.0024" / 0.06mm	7.56" / 192mm	.315" / 8mm	.098" / 2.5mm	Ball Ø.08" / 2mm	420

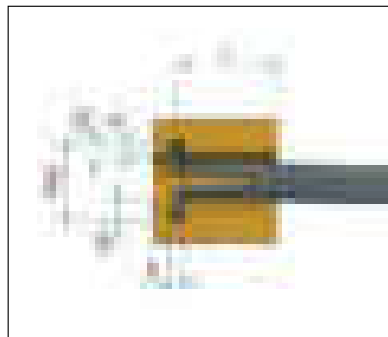
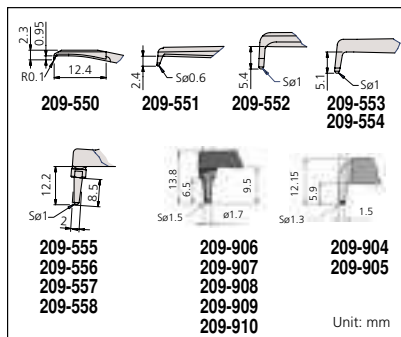

Edge R 0.1 mm

Ball Ø 0.6mm, Ø 1mm, Ø 1.3mm  
 Ø 1.5mm and Ø 2mm



# Digimatic Caliper Gages

## SERIES 209 — External Tube Thickness Measurement

### Technical Data

Accuracy: Refer to the list of specifications  
 Resolution: .001", .0005", or .0002"  
 0.01mm, 0.02mm, or 0.005mm  
 Display: Analog / Digital  
 Power Supply: AAA Battery (2 pcs.)  
 Battery life: Approx. 350 hours  
 Measuring Force: 0.8 - 1.7N  
 Dust/Water protection level: IP67  
 Provided with inspection certificate.

### Function

Zeraset, Preset, Auto power off, Inch/Metric conversion, Data hold, Max/Min value holding, Data output  
 \* Contact type 3, 4 does not have max. min. value hold.

Versatile OD measuring gages for groove thickness, tube thickness and hard-to-reach dimensions. Digimatic Caliper Gages provide error-free LCD readings, as well as data output for SPC analysis.

External measurement type

209-572



### SPECIFICATIONS

Inch / Metric

Range	Order No.	Resolution	Accuracy	Max. Measuring Depth L	Measuring Contact length Hb	Measuring Contact length Hf	Type of Measuring Contact/type of set up	Mass(g)
0 - .39" / 0-10mm	209-570	.0002" / 0.005mm	.0008" / 0.05mm	1.37" / 35mm	.75" / 19.1mm	.73" / 18.6mm	Ball .059" / 1.5mm dia. Both/ A	240
0 - .39" / 0-10mm	209-571	.0002" / 0.005mm	.001" / 0.02mm	1.37" / 35mm	.85" / 21.7mm	.58" / 14.8mm	Desc .24" / 6mm dia. Both/ C	175
0 - .78" / 0-20mm	209-572	.0005" / 0.01mm	.0015" / 0.03mm	3.2" / 85mm	.97" / 24.7mm	.97" / 24.6mm	Ball .059" / 1.5mm dia. Both/ A	280
0 - .78" / 0-20mm	209-573	.0005" / 0.01mm	.0015" / 0.03mm	3.2" / 80mm	.97" / 24.7mm	.10" / 2.5mm	Ball .059" / 1.5mm dia. Both/ B	270
0-1.18" / 0-30mm	209-913	.001" / 0.02mm	.002" / 0.04mm	4.5" / 114mm	1.17" / 30mm	1.17" / 30mm	Ball Ø.12" / 3mm A	430
0-1.18" / 0-30mm	209-914	.001" / 0.02mm	.002" / 0.04mm	4.58" / 116mm	1.17" / 30mm	.16" / 4mm	Ball Ø.12" / 3mm B	410
0-1.18" / 0-30mm	209-915	.001" / 0.02mm	.002" / 0.04mm	4.56" / 116mm	1.42" / 36mm	.94" / 24mm	Disc Ø1.97" / 50mm D	430
0-1.97" / 0-50mm	209-918	.001" / 0.02mm	.002" / 0.04mm	6.57" / 167mm	1.17" / 30mm	1.17" / 30mm	Ball Ø.12" / 3mm A	490
0-1.97" / 0-50mm	209-919	.001" / 0.02mm	.0024" / 0.06mm	6.57" / 167mm	1.17" / 30mm	.18" / 4.6mm	Ball Ø.12" / 3mm B	460
0-1.97" / 0-50mm	209-920	.001" / 0.02mm	.003" / 0.08mm	6.57" / 167mm	1.42" / 36mm	.94" / 24mm	Disc Ø1.97" / 50mm both/D	500

### Optional Accessories

- KPL1961-09: SPC Adapter
- 937387 Digimatic cable (1m)
- 965013 Digimatic cable (2m)
- KPL8004-50 Holder for stand

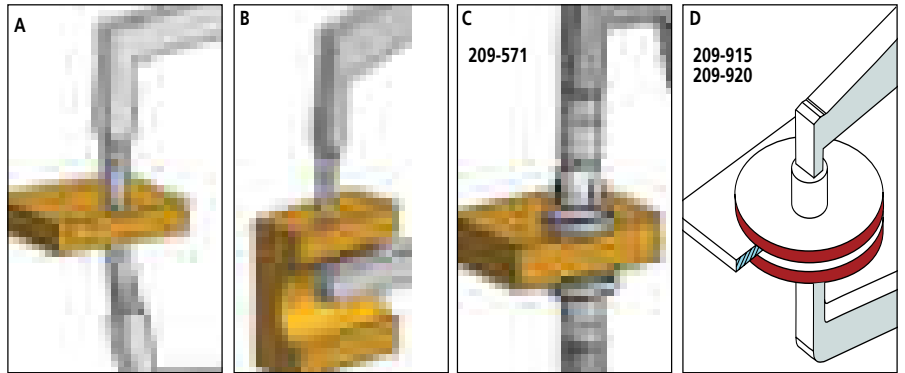
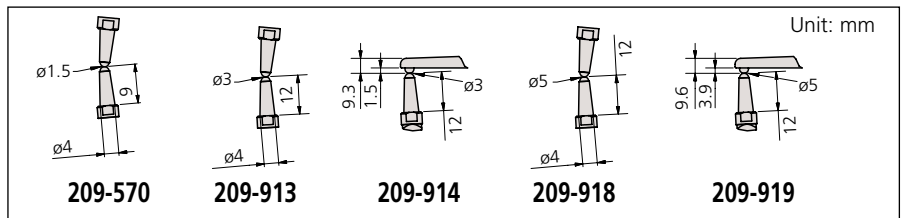
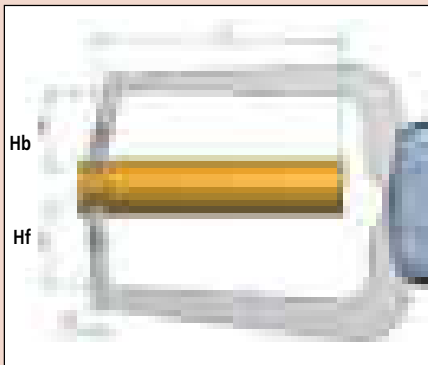

A Ball ø 1.5 and 3mm for wall thickness

B Ball ø 1.5 and 3mm for min. wall thickness ø3mm / 9mm

C Disk ø6mm for flat surfaces

D Disk ø50mm for flat surfaces

# Dial Caliper Gages

## SERIES 209 — Internal Measurement



The caliper is spring loaded and makes point contact at a constant measuring pressure.

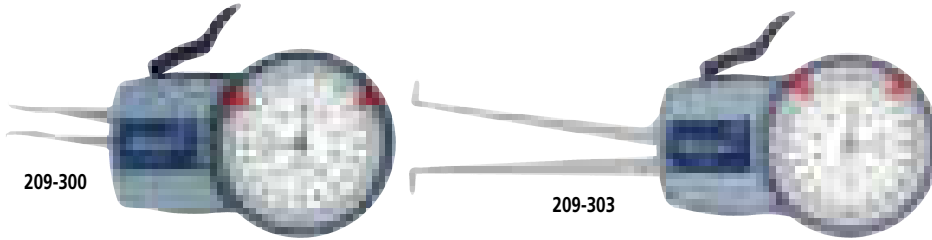

### DIMENSIONS

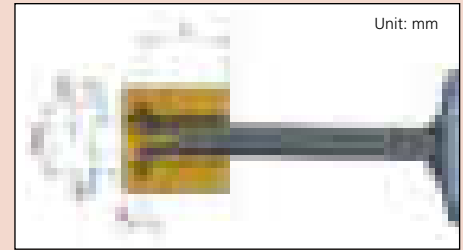

### SPECIFICATIONS

Inch									
Measuring Range	Order No.	Graduation	Accuracy	Max. Measuring Depth L	Max. Groove Depth A	Min. Groove Width B	Measuring Contact Type	Size (mm)	Mass (g)
.10 - .50"	<b>209-350</b>	.0002"	± .0008"	.47"	.027"	.023"	A	R0.1	200
.20 - .60"	<b>209-351</b>	.0002"	± .0008"	1.37"	.09"	.032"	B	ø0.6	200
.40 - 1.2"	<b>209-352</b>	.0005"	± .0015"	3.3"	.19"	.06"	B	ø1	200
.80 - 1.6"	<b>209-354</b>	.0005"	± .0015"	3.3"	.26"	.06"	B	ø1	200
1.2 - 2"	<b>209-355</b>	.0005"	± .0015"	3.3"	.26"	.06"	B	ø1	200
1.6 - 2.4"	<b>209-356</b>	.0005"	± .0015"	3.3"	.31"	.06"	B	ø1	200
2 - 2.8"	<b>209-357</b>	.0005"	± .0015"	3.3"	.31"	.06"	B	ø1	200
2.4 - 3.2"	<b>209-358</b>	.0005"	± .0015"	3.3"	.31"	.06"	B	ø1	250
2.8 - 3.6"	<b>209-359</b>	.0005"	± .0015"	3.3"	.31"	.06"	B	ø1	250
3.2 - 4"	<b>209-360</b>	.0005"	± .0015"	3.3"	.31"	.06"	B	ø1	250
2 - 4"	<b>209-361*</b>	.0005"	± .0015"	3.3"	.31"	.06"	C	ø1	250
3.6 - 5.6"	<b>209-362*</b>	.0005"	± .0015"	3.3"	.31"	.06"	C	ø1	250
5.2 - 7.2"	<b>209-363*</b>	.0005"	± .0015"	3.3"	.31"	.06"	C	ø1	250

\*Interchangeable contact points (additional anvil 4 pcs.) with ball point .04" dia. These Dial Caliper Gages are used only as comparison gages and should be used along with a setting ring or a micrometer.

Metric									
Measuring Range	Order No.	Graduation	Accuracy	Max. Measuring Depth L	Max. Groove Depth A	Min. Groove Width B	Measuring Contact Type	Size (mm)	Mass(g)
2.5 - 12.5mm	<b>209-300</b>	0.005mm	±0.015mm	12mm	0.7mm	0.5mm	A	R0.1	155
5 - 15mm	<b>209-301</b>	0.005mm	±0.015mm	35mm	2.3mm	0.8mm	B	ø0.6	160
10 - 30mm	<b>209-302</b>	0.01mm	±0.03mm	85mm	5.2mm	1.2mm	B	ø1	180
20 - 40mm	<b>209-303</b>	0.01mm	±0.03mm	85mm	7mm	1.2mm	B	ø1	180
30 - 50mm	<b>209-304</b>	0.01mm	±0.03mm	85mm	7mm	1.2mm	B	ø1	185
40 - 60mm	<b>209-305</b>	0.01mm	±0.03mm	85mm	8.3mm	1.2mm	B	ø1	195
50 - 70mm	<b>209-306</b>	0.01mm	±0.03mm	85mm	8.3mm	1.2mm	B	ø1	195
60 - 80mm	<b>209-307</b>	0.01mm	±0.03mm	85mm	8.3mm	1.2mm	B	ø1	200
70 - 90mm	<b>209-308</b>	0.01mm	±0.03mm	85mm	8.3mm	1.2mm	B	ø1	200
80 - 100mm	<b>209-309</b>	0.01mm	±0.03mm	85mm	8.3mm	1.2mm	B	ø1	200
50 - 100mm	<b>209-310*</b>	0.01mm	±0.03mm	85mm	8.3mm	1.2mm	C	ø1	220
90 - 140mm	<b>209-311*</b>	0.01mm	±0.03mm	85mm	8.3mm	1.2mm	C	ø1	230
130 - 180mm	<b>209-312*</b>	0.01mm	±0.03mm	85mm	8.3mm	1.2mm	C	ø1	240
15-65mm	<b>209-901</b>	0.05mm	±0.05	188	5	1.9	B	ø1.5mm	355
40-90mm	<b>209-902</b>	0.05mm	±0.05	192	8.5	2.4	B	ø2mm	370
70-120mm	<b>209-903</b>	0.05mm	±0.05	192	8.5	2.4	B	ø2mm	380

\*Interchangeable contact point (additional anvil 5pcs.) with ball point 1mm dia. These Dial Caliper Gages are used only as comparison gages and should be used along with a setting ring or a micrometer.

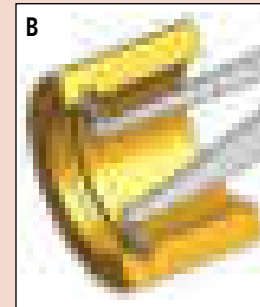
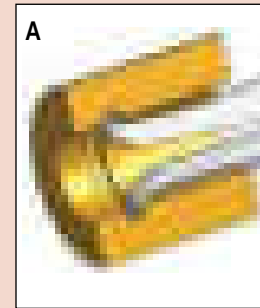



## Type of Contact Points

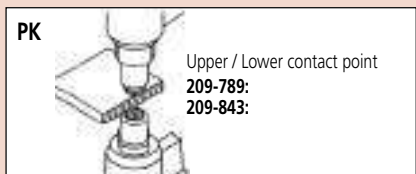
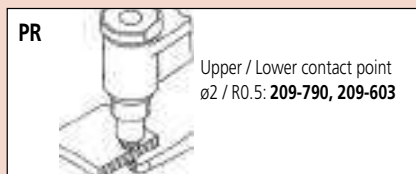
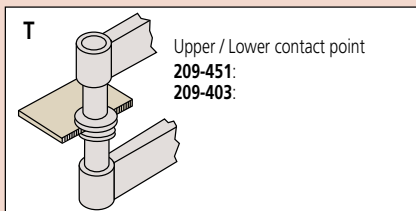
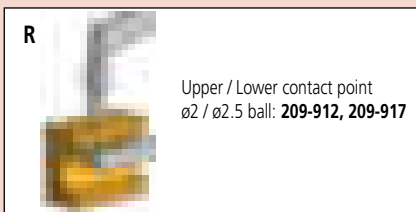
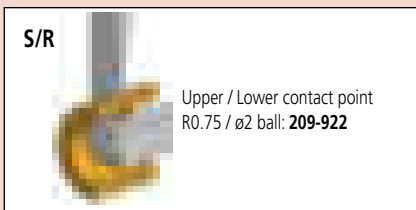
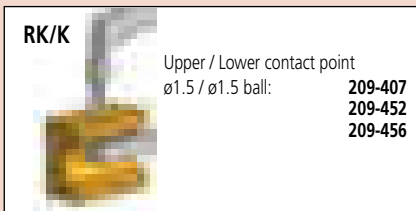
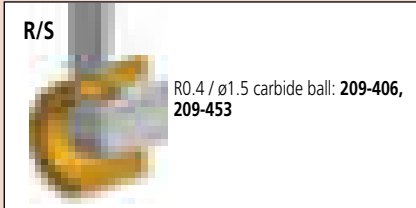
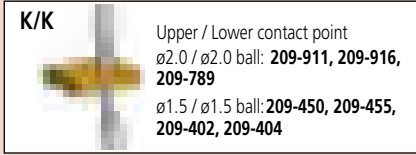
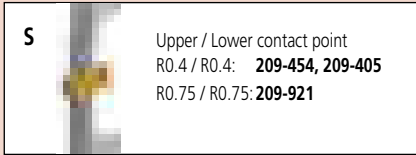

# Dial Caliper Gages

## SERIES 209 — External Measurement

IP65



## DIMENSIONS

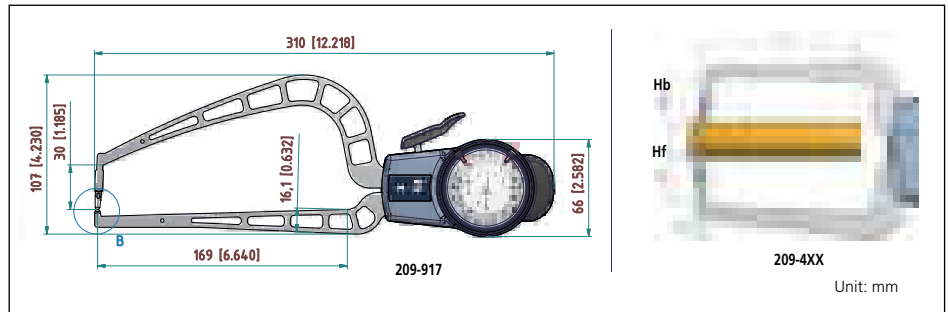

## SPECIFICATIONS

Measuring Range	Order No.	Graduation	Accuracy	Max. Measuring Depth L	Length Hb	Length Hf	Measuring Contact Type	Size (mm)	Mass (g)
0 - .40"	<b>209-450</b>	.0002"	± .0008"	1.37"	.75"	.75"	K/K	ø1.5	170
0 - .40"	<b>209-451</b>	.0002"	± .001"	1.37"	.85"	.58"	T	ø6	175
0 - .40"	<b>209-452</b>	.0002"	± .0008"	1.37"	.75"	.035"	RK/K	ø1.5	165
0 - .40"	<b>209-453</b>	.0002"	± .0008"	1.37"	.75"	.035"	R/S	Chisel R0.4, ø1.5	165
0 - .50"	<b>209-789</b>	.005"	± .005"	1.38"	-	-	PK	ø2, Chisel R0.5	40
0 - .50"	<b>209-790</b>	.005"	± .005"	1.38"	-	-	PR	ø2	40
0 - .80"	<b>209-454</b>	.0005"	± .0015"	3.2"	.97"	.97"	S	Chisel R0.4	210
0 - .80"	<b>209-455</b>	.0005"	± .0015"	3.2"	.97"	.97"	K/K	ø1.5	210
0 - .80"	<b>209-456</b>	.0005"	± .0015"	3.2"	.97"	.10"	RK/K	ø1.5	200
0 - .80"	<b>209-457</b>	.0005"	± .0015"	3.2"	.97"	.10"	R/S	Chisel R0.4, ø1.5	200
0 - 2.0"	<b>209-916</b>	.001"	± .002"	6.6"	1.2"	1.2"	K/K	ø3	430
0 - 2.0"	<b>209-917</b>	.001"	± .002"	6.6"	1.2"	.18"	RK/K	ø3	400

## Metric

Measuring Range	Order No.	Graduation	Accuracy	Max. Measuring Depth L	Length Hb	Length Hf	Measuring Contact	Size (mm)	Mass (g)
0 - 10mm	<b>209-402</b>	0.005mm	±0.015mm	35mm	19.1mm	18.6mm	K/K	ø1.5	240
0 - 10mm	<b>209-403</b>	0.005mm	±0.02mm	35mm	21.7mm	14.8mm	T	ø6	175
0 - 20mm	<b>209-404</b>	0.01mm	±0.03mm	85mm	7mm	24.6mm	K/K	ø1.5	210
0 - 20mm	<b>209-405</b>	0.01mm	±0.03mm	85mm	7mm	24.6mm	S	R 0.4	210
0 - 20mm	<b>209-406</b>	0.01mm	±0.03mm	80mm	7mm	2.5mm	R/S	Chisel R0.4, ø1.5	200
0 - 20mm	<b>209-407</b>	0.01mm	±0.03mm	80mm	7mm	2.5mm	RK/K	ø1.5	200
0 - 10mm	<b>209-843</b>	0.1mm	±0.1mm	36mm	-	-	PK	ø2, Chisel R0.5	40
0 - 10mm	<b>209-603</b>	0.1mm	±0.1mm	33mm	-	-	PR	ø2	40
0 - 50mm	<b>209-911</b>	0.05mm	±0.05mm	167mm	30mm	30mm	KK	Ball ø3mm	430
0 - 50mm	<b>209-912</b>	0.05mm	±0.05mm	169mm	30mm	4.5mm	RK/K	Ball ø3mm	400
0 - 50mm	<b>209-921</b>	0.05mm	±0.05mm	167mm	30mm	30mm	S	Chisel R0.75	490
0 - 50mm	<b>209-922</b>	0.05mm	±0.05mm	169mm	30mm	4.5mm	R/S	ø3, Chisel R0.75	400

Mitutoyo

# Dial Tension Gages

## SERIES 546

### FEATURES

- Can measure dynamic tension in Newton (N) units.
- Dial Tension Gages are widely used to determine the contact force of other measuring instruments, as well as that of electrical relays, micro-switches, valves and precision springs.
- Convenient peak-hold type gages are also available.

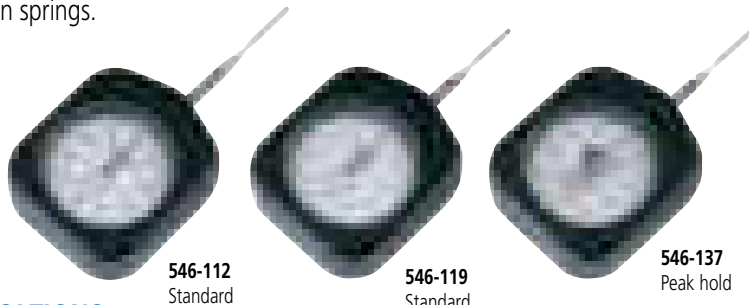

### SPECIFICATIONS

#### Standard

Range	Order No.	Minimum reading
6mN - 50mN	546-112	2mN
10mN - 100mN	546-113	5mN
30mN - 300mN	546-114	10mN
0.06N - 0.5N	546-115	0.02N
0.1N - 1N	546-116	0.05N
0.15N - 1.5N	546-117	0.05N
0.3N - 3N	546-118	0.1N
0.6N - 5N	546-119	0.2N

#### Peak hold

Range	Order No.	Graduation
10mN - 100mN	546-133	5mN
30mN - 300mN	546-134	10mN
0.06N - 0.5N	546-135	0.02N
0.1N - 1N	546-136	0.05N
0.15N - 1.5N	546-137	0.05N
0.3N - 3N	546-138	0.1N
0.6N - 5N	546-139	0.2N

# V-Block Sets

## SERIES 181

### FEATURES

- Two V-blocks per set.
- Magnetic type is available. (The magnetic V-block is not provided with a workpiece clamp.)



### SPECIFICATIONS

#### Inch

Max. workpiece dia.	Order No.	Thread Size	Remarks	Mass(g)
1"	181-901-10	UNC 1/4"-20	With clamp	750
2"	181-904-10	5/16"-18NC	With clamp	3600

# Magnetic V-Block

## SERIES 181

### SPECIFICATIONS

#### Metric

Max. workpiece dia.	Order No.	Magnetic Pull	Remarks
50mm	181-146	60 kg	1 Piece



### Application

Measuring contact force of relay

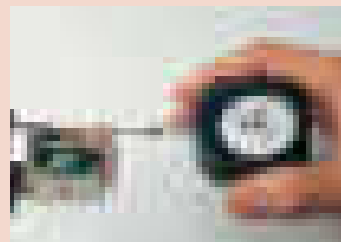

### DIMENSIONS

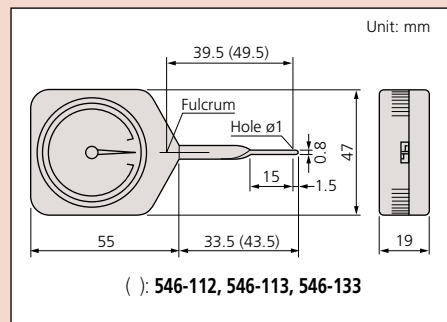

### DIMENSIONS

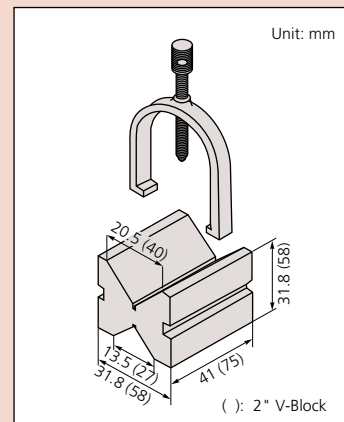

### DIMENSIONS

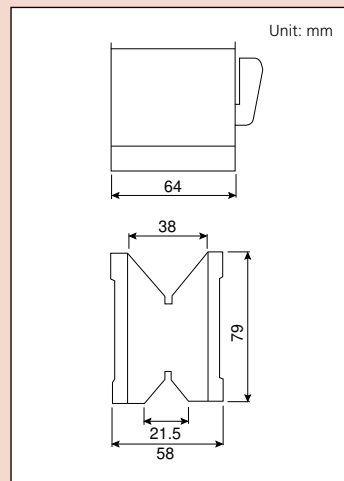

# Dial Snap Gages

## SERIES 201

### FEATURES

- Designed for quick go/no-go judgment of diameters of cylinders and shafts in machining processes.
- Dial or Digital indicators are optional.
- Anvil retracting stroke: .078" / 2mm
- Anvil positioning range: 1" / 25mm
- Wide (.53 x .47" / 13.5 x 12mm), flat carbide anvils
- Both front edges of the anvil are chamfered for easy insertion.

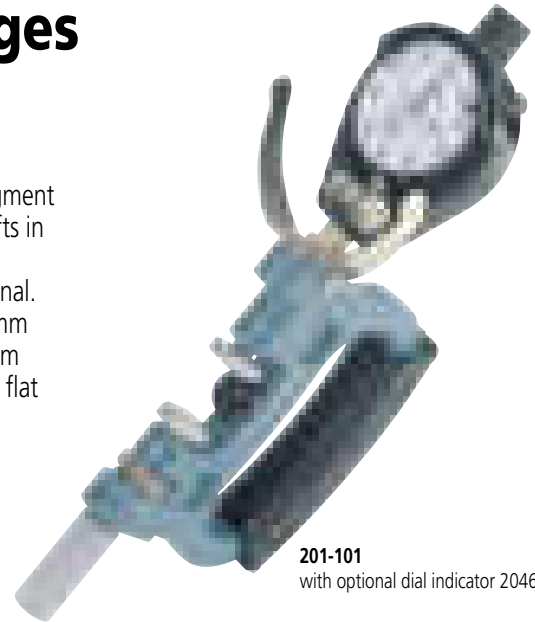

201-101  
with optional dial indicator 2046SB

### Technical Data

Accuracy: Refer to the list of specifications  
 Anvil retracting stroke: .078" / 2mm  
 Anvil positioning range: 1" / 25mm  
 Anvil flatness: .00004" / 1μm

### SPECIFICATIONS

**Metric** Gage stem diameter 8mm

Range	Order No.	Parallelism	Measuring force	Recommended dial indicator (optional)
0 - 25mm	201-101	5μm or less	15N±3N	2046SB (0.01mm reading), 2109SB-10 (0.001mm reading)
25 - 50mm	201-102	5μm or less	15N±3N	2046SB (0.01mm reading), 2109SB-10 (0.001mm reading)
50 - 75mm	201-103	5μm or less	15N±3N	2046SB (0.01mm reading), 2109SB-10 (0.001mm reading)
75 - 100mm	201-104	5μm or less	15N±3N	2046SB (0.01mm reading), 2109SB-10 (0.001mm reading)
100 - 125mm	201-105	5μm or less	15N±3N	2046SB (0.01mm reading), 2109SB-10 (0.001mm reading)
125 - 150mm	201-106	5μm or less	15N±3N	2046SB (0.01mm reading), 2109SB-10 (0.001mm reading)
150 - 175mm	201-107	5μm or less	15N±3N	2046SB (0.01mm reading), 2109SB-10 (0.001mm reading)
175 - 200mm	201-108	5μm or less	15N±3N	2046SB (0.01mm reading), 2109SB-10 (0.001mm reading)
200 - 225mm	201-109	5μm or less	15N±3N	2046SB (0.01mm reading), 2109SB-10 (0.001mm reading)
225 - 250mm	201-110	5μm or less	15N±3N	2046SB (0.01mm reading), 2109SB-10 (0.001mm reading)
250 - 275mm	201-111	5μm or less	15N±3N	2046SB (0.01mm reading), 2109SB-10 (0.001mm reading)
275 - 300mm	201-112	5μm or less	15N±3N	2046SB (0.01mm reading), 2109SB-10 (0.001mm reading)

**Inch** Gage stem diameter 3/8"

Range	Order No.	Parallelism	Measuring force	Recommended dial indicator (optional)
0 - 1"	201-151	.00025" or less	15N±3N	2803SB-10 (.0001" reading)
1 - 2"	201-152	.00025" or less	15N±3N	2803SB-10 (.0001" reading)
2 - 3"	201-153	.00025" or less	15N±3N	2803SB-10 (.0001" reading)
3 - 4"	201-154	.00025" or less	15N±3N	2803SB-10 (.0001" reading)
4 - 5"	201-155	.00025" or less	15N±3N	2803SB-10 (.0001" reading)
5 - 6"	201-156	.00025" or less	15N±3N	2803SB-10 (.0001" reading)
6 - 7"	201-157	.00025" or less	15N±3N	2803SB-10 (.0001" reading)
7 - 8"	201-158	.00025" or less	15N±3N	2803SB-10 (.0001" reading)
8 - 9"	201-159	.00025" or less	15N±3N	2803SB-10 (.0001" reading)
9 - 10"	201-160	.00025" or less	15N±3N	2803SB-10 (.0001" reading)
10 - 11"	201-161	.00025" or less	15N±3N	2803SB-10 (.0001" reading)
11 - 12"	201-162	.00025" or less	15N±3N	2803SB-10 (.0001" reading)

### DIMENSIONS

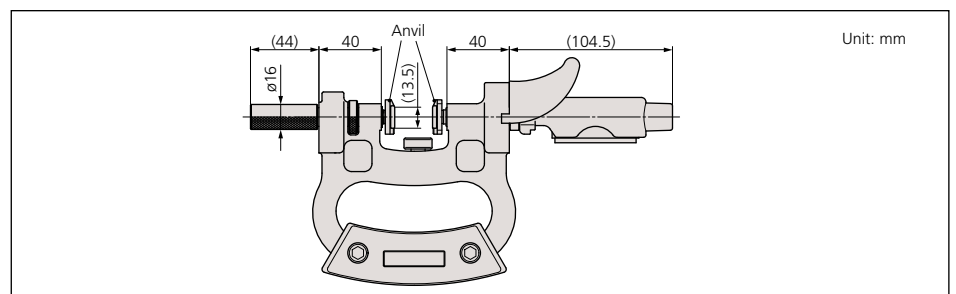

Unit: mm

# Dial/Test Indicator & Magnetic Stand Sets

## SERIES 7



513-907

### SPECIFICATIONS

Set No.	Included in set
64PKA078*	2804S-10, 7010S
64PKA079*	2416S, 7010S
513-907-10E	513-402-10E, 7014E-10
513-908-10E	513-404-10E, 7014-10

\*Supplied with collar 02AZC291

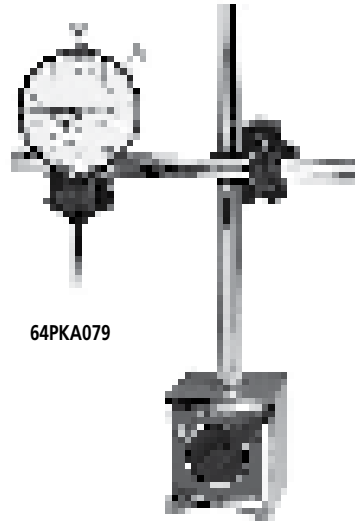

64PKA079

# Magnetic Stands

## SERIES 7

Mitutoyo's Magnetic Stands accept all dial indicators and dial test indicators. The On-Off switch offers instant mounting and dismounting without any adverse effect to the indicators or workpiece surface.

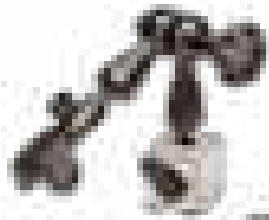

7031B

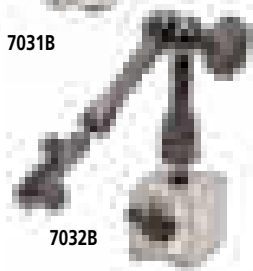

7032B

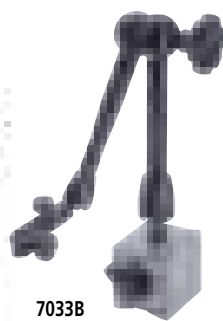

7033B



7012-10

7014-10 / 7014E-10  
No magnet force On/Off



7010S



7011BN

## DIMENSIONS

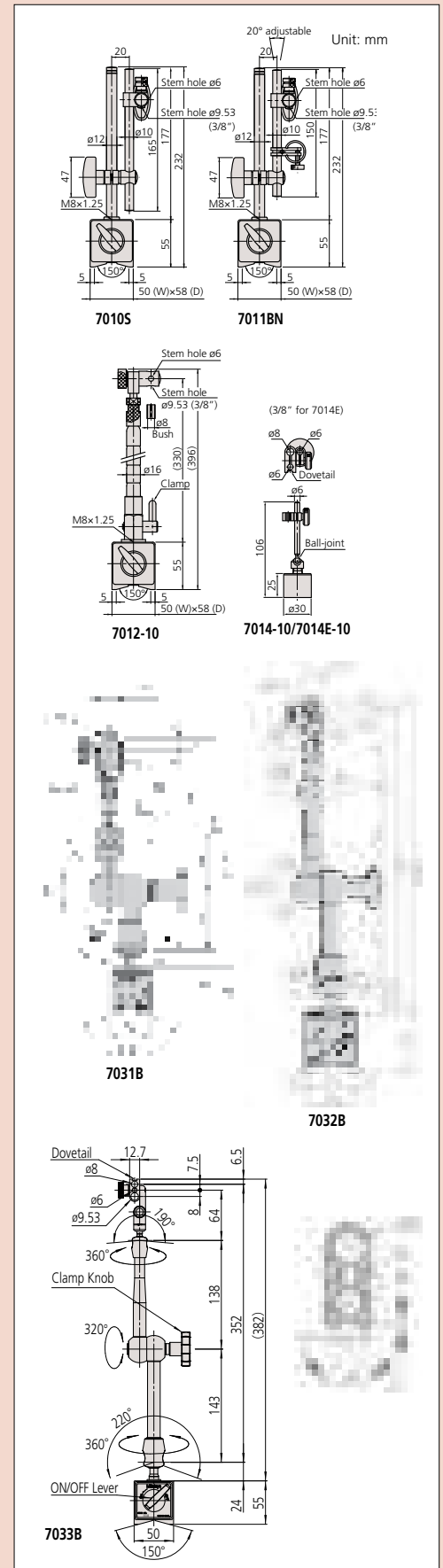

### SPECIFICATIONS

Order No.	Description	Applicable holding stem dia.	Dovetail groove	Remarks
7010S	Magnetic stand	$\phi 8\text{mm}^*$ , $\phi 9.53\text{mm}$ (3/8")	—	—
7011BN	Magnetic stand	$\phi 6\text{mm}$ , $\phi 8\text{mm}^*$ , $\phi 9.53\text{mm}$ (3/8")	—	With fine adjustment
7011S-10	Magnetic stand	$\phi 4\text{mm}$ , $\phi 8\text{mm}$ , $\phi 9.53\text{mm}$ (3/8")	—	With fine adjustment
7012-10	Magnetic flexi-stand	$\phi 6\text{mm}$ , $\phi 8\text{mm}^*$ , $\phi 9.53\text{mm}$ (3/8")	—	For dial test indicator
7014-10	Mini magnetic stand	$\phi 6\text{mm}$ , $\phi 8\text{mm}$	Provided	Without magnet ON/OFF
7014E-10	Mini magnetic stand	$\phi 6\text{mm}$ , $\phi 8\text{mm}^*$ , $\phi 9.53\text{mm}$ (3/8")	Provided	Without magnet ON/OFF
7031B	Universal magnetic stand	$\phi 6\text{mm}$ , $\phi 8\text{mm}$ , $\phi 9.53\text{mm}$ (3/8")	Provided	With mechanical locking system
7032B	Universal magnetic stand	$\phi 6\text{mm}$ , $\phi 8\text{mm}$ , $\phi 9.53\text{mm}$ (3/8")	Provided	With mechanical locking system
7033B	Universal magnetic stand	$\phi 6\text{mm}$ , $\phi 8\text{mm}$ , $\phi 9.53\text{mm}$ (3/8")	Provided	With mechanical locking system

\*Supplied with collar 02AZC291

# Dial Gage Stands

## SERIES 7

### FEATURES

- Dial Gage Stands are designed for comparison measurements of size using a dial indicator or Digimatic Indicator.
- Vertical fine adjustment is available with one-touch control thanks to the parallel spring suspension.
- Anvil of 7001-10 and 7002-10:  $\phi 58$ mm  
Anvil of 7007-10: 90mm square

### Optional Accessories

- 101461:** Hardened-steel flat anvil
  - 101462:** Hardened-steel serrated anvil
  - 101463:** Hardened-steel domed anvil\*
- \*Not available for 7007-10.

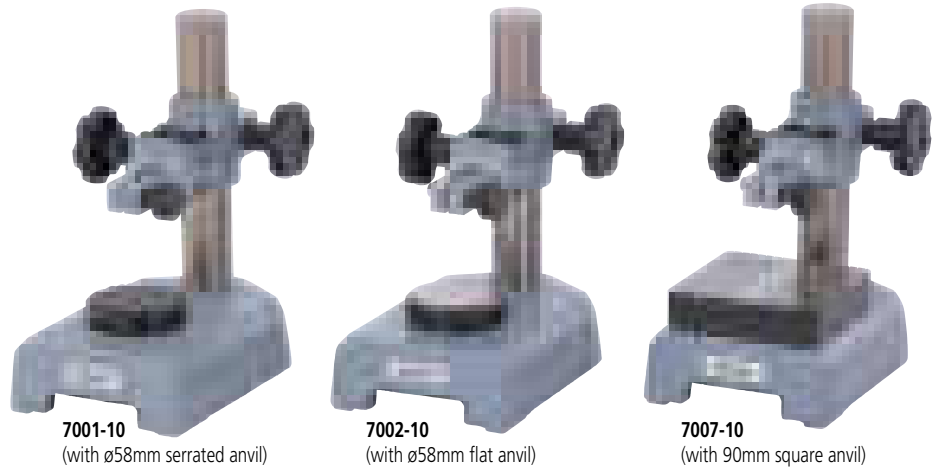
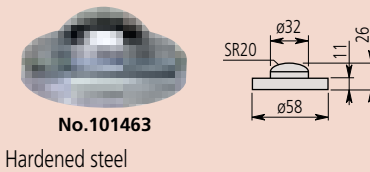
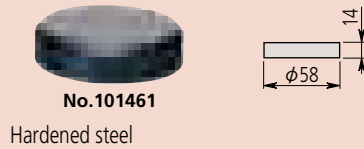
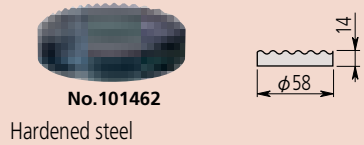

### SPECIFICATIONS

Metric			
Order No.	Stem hole	Remarks	Mass(g)
7001-10	$\phi 8$ mm, $\phi 9.53$ mm	With serrated anvil (101462)	4
7002-10	$\phi 8$ mm, $\phi 9.53$ mm	With flat anvil (101461)	4
7007-10	$\phi 8$ mm, $\phi 9.53$ mm	With square anvil	5

### DIMENSIONS

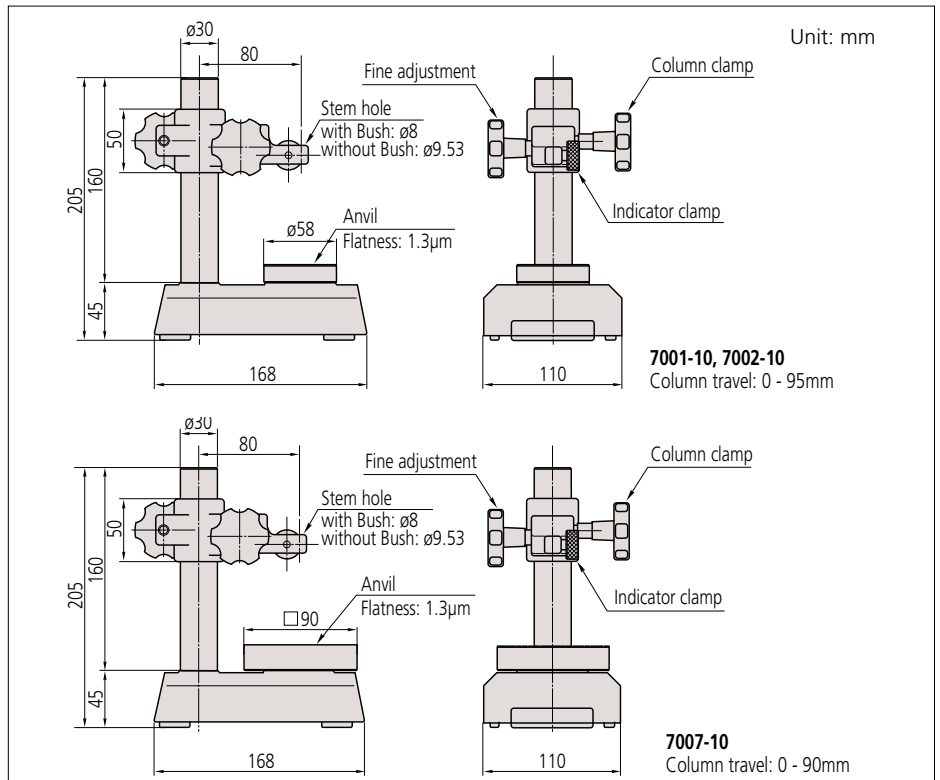

# Transfer Stands

## SERIES 519

### FEATURES

- Transfer Stands are designed for comparison measurements of size using a dial indicator or Digimatic Indicator.



519-109-10  
(with a serrated anvil)

### Optional Accessories

**101461:** Hardened-steel flat anvil

**101463:** Hardened-steel domed anvil

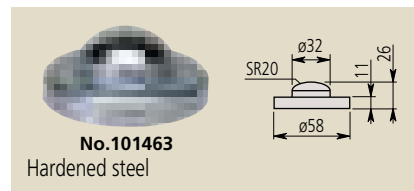
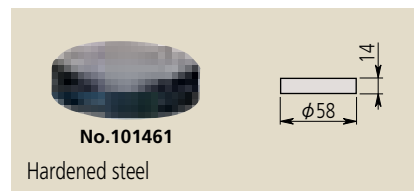

### SPECIFICATIONS

Metric

Order No.	Stem hole	Remarks
519-109-10	ø8mm, ø9.53mm	With serrated anvil (101462)

### DIMENSIONS

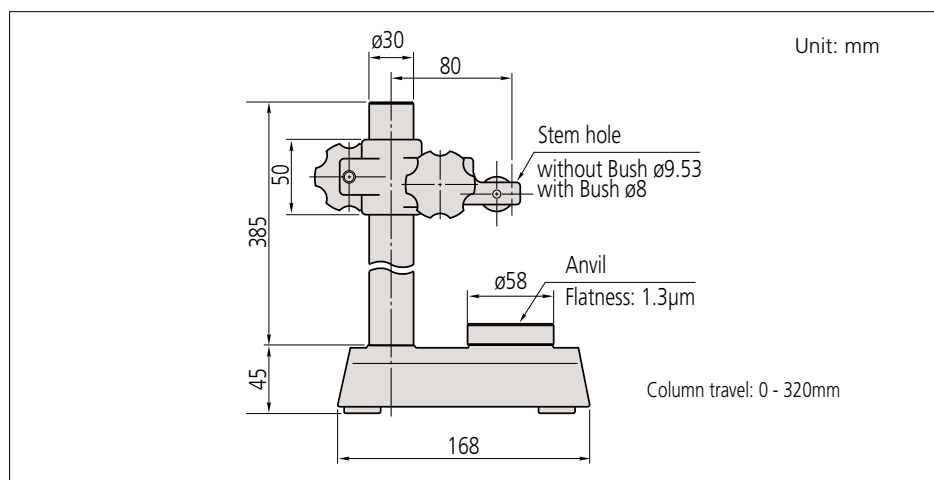

# Granite Comparator Stands

## SERIES 215

### FEATURES

- Easy maintenance due to the non-rusting base.
- The rigid granite base is free from burrs and pileups due to its fine-grain composition and less viscousness compared with casting iron. The flatness is always accurate and the workpiece is free from damage.

### Optional Accessories

21JAA329: ø8mm bush  
 21JAA330: ø9.53mm bush  
 21JAA331: ø15mm bush  
 only available for 215-156-10

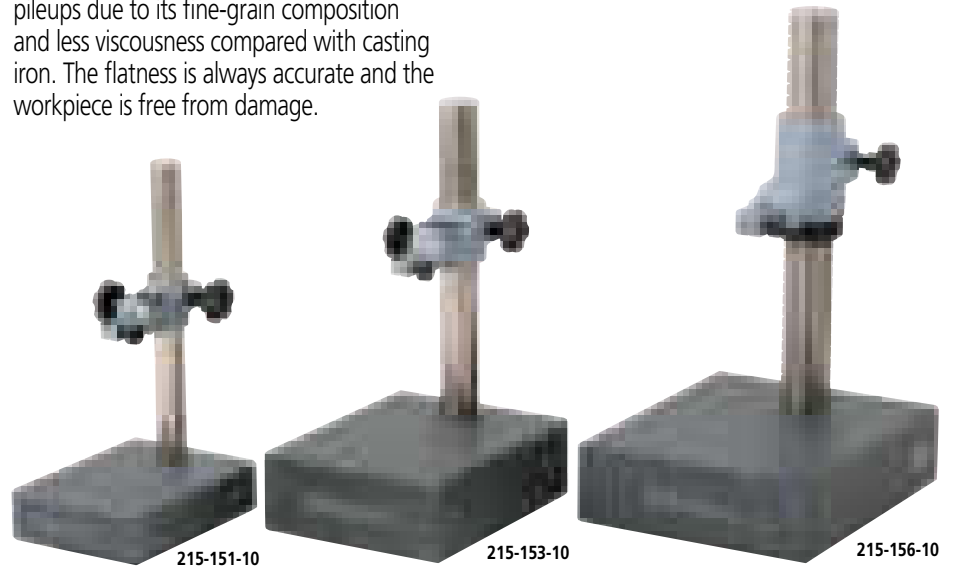

### SPECIFICATIONS

Order No.	Granite base size (W x D x H)	Column travel	Stem hole	Remarks
215-151-10	150 x 200 x 50mm	250mm	ø8mm, ø9.53mm	With fine adjustment of 1mm range
215-153-10	200 x 250 x 80mm	260mm	ø8mm, ø9.53mm	With fine adjustment of 1mm range
215-156-10	300 x 250 x 80mm	275mm	ø8mm, ø9.53mm, ø20mm	With fine adjustment over the entire travel

### DIMENSIONS

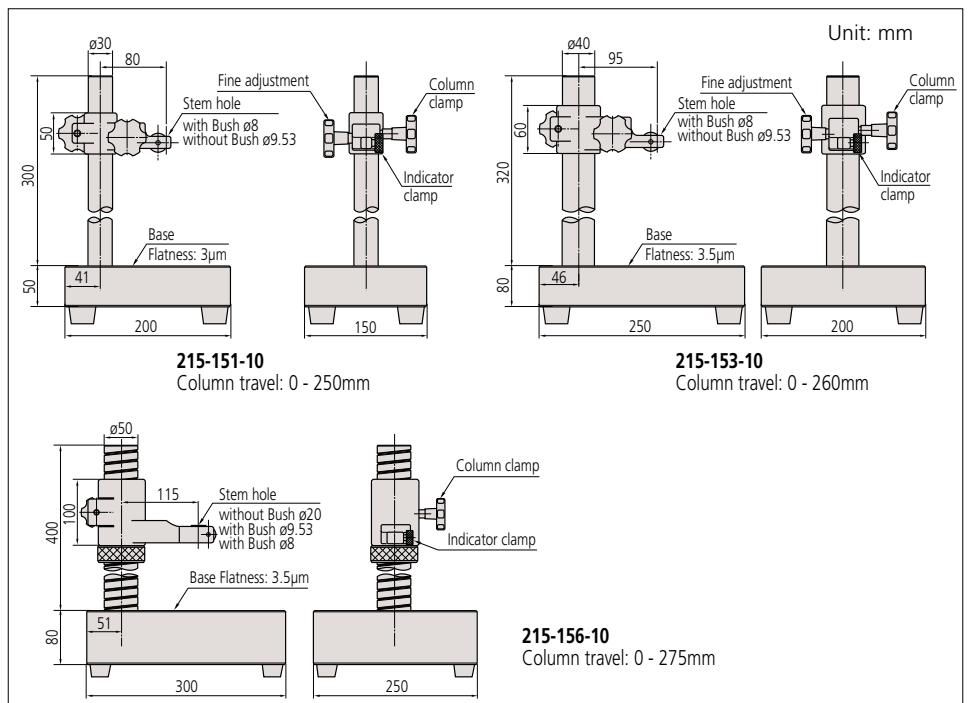

# Comparator Stands

## SERIES 215

### FEATURES

- Comparator Stands have a stable, cast-iron base which enables precise measurement.
- The partially serrated anvil prevents flat workpieces from wringing to it and the 2.3µm flatness (or better) promotes accurate measurement.
- The **215-505-10** model has a threaded column which enables easy and precise coarse adjustment.
- Serrated anvils 110x110mm are supplied with **215-405-10**, and 150x150mm with **215-505-10** models.



215-405-10

### SPECIFICATIONS

Order No.	Square anvil size (W x D)	Column travel	Stem hole	Remarks
215-405-10	110 x 110mm	235mm	ø8mm, ø9.53mm	With fine adjustment of 1mm range
215-505-10	150 x 150mm	275mm	ø8mm, ø9.53mm, ø20mm	With fine adjustment over the entire travel

\* Perpendicularity of the mounting hole to the anvil: less than 0.4mm/100mm

### DIMENSIONS

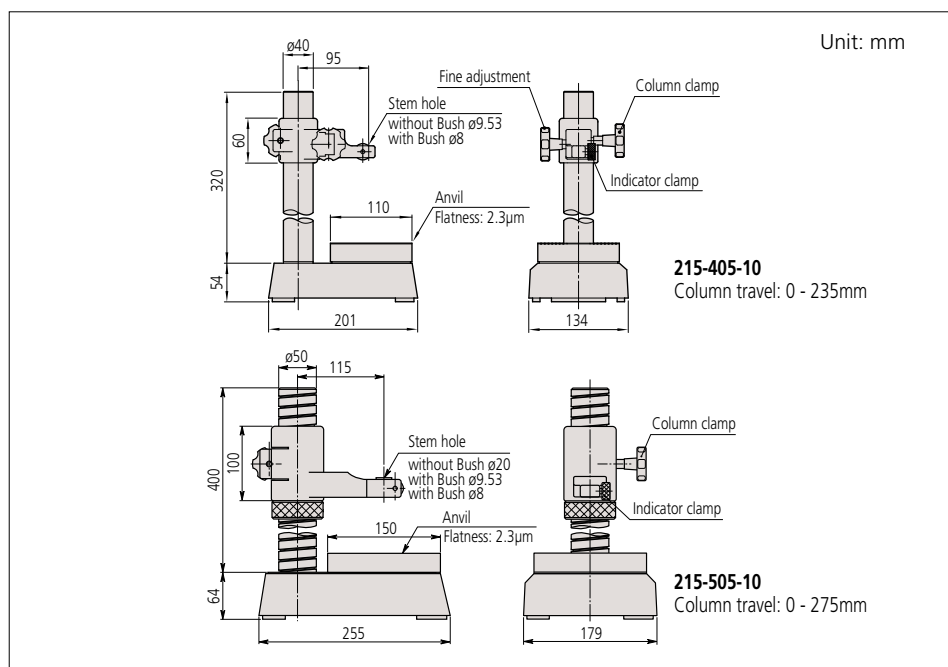

Application example using Digimatic Indicator ID-H.

### Optional Accessories

- 21JAA329: ø8mm bush\*
- 21JAA330: ø9.53mm (3/8") bush\*
- 21JAA331: ø15mm bush\*

\* Only available for 215-505-10.



# Precision Granite Stands (with black granite bases)

## SERIES 517

### FEATURES

Mitutoyo's Granite Comparator Stands are basic building blocks for the assembly of special purpose, precision measuring equipment. By mounting precision measuring instruments such as Digimatic indicators, Mu-Checker Cartridge Heads and Linear Gages on the stands, it is possible to satisfy all manners of measuring assignment. The rigid granite base is free from burrs, pileups and rust, thereby preventing deterioration over time.

#### Optional Accessories

012580: Holder for Lug-Back indicator



### SPECIFICATIONS

Order No.	Base	Column Diameter	Column Height	Throat Clearance	Table Flatness	Table Thickness	Weight
517-890	6 x 8"	1.181"	6"	4.375"	.0001"	2"	18 lbs
517-891	6 x 8"	1.181"	8"	4.375"	.0001"	2"	19 lbs
517-892	6 x 8"	1.181"	12"	4.375"	.0001"	2"	20 lbs
517-893	6 x 8"	1.181"	18"	4.375"	.0001"	2"	21 lbs
517-895	8 x 12"	1.181"	6"	5.8"	.0001"	2"	29 lbs
517-896	8 x 12"	1.181"	8"	5.8"	.0001"	2"	30 lbs
517-897	8 x 12"	1.181"	12"	5.8"	.0001"	2"	31 lbs
517-898	8 x 12"	1.181"	18"	5.8"	.0001"	2"	32 lbs
517-899	8 x 12"	1.181"	24"	5.8"	.0001"	2"	35 lbs

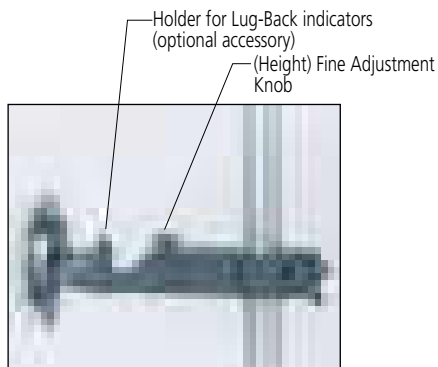

# MITUTOYO INSTITUTE OF METROLOGY

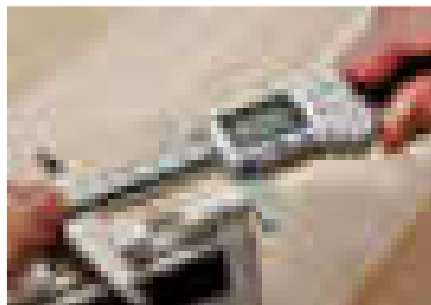
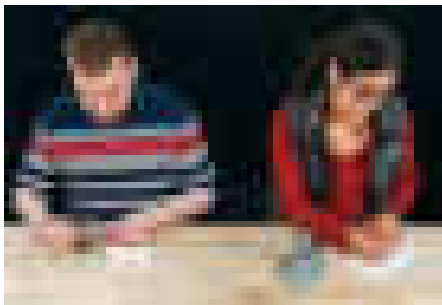

The Mitutoyo Institute of Metrology, the educational department of Mitutoyo America, provides unrivaled educational seminars, courses and on-demand resources for a wide variety of metrology and measurement-related topics such as basic inspection techniques, principles of dimensional metrology, calibration methods and GD&T. This comprehensive curriculum meets the educational needs of manufacturing, quality and measurement professionals. These popular courses are scheduled regularly throughout the year.

The calibration expertise of Mitutoyo America is now available on-demand for anybody through our On-Demand Portal. Here, you can access metrology educational materials that leverages the available American National Standards in dimensional metrology.

Mitutoyo now offers online courses introducing important concepts in general calibration of micrometers and calipers. Mitutoyo also offers the first certified credentials in dimensional calibration in the United States, addressing both theory (Level 1 credential) and hands-on performance skills (Level 2 credential). These credentials satisfy auditors' requirements.

If you have any questions or would like more information regarding Mitutoyo Institute of Metrology, contact: [MIM@Mitutoyo.com](mailto:MIM@Mitutoyo.com)





### Linear Gages



### Mu-checker



### Laser Scan Micrometers

## INDEX

### Linear Gage

Gage Heads / Display Units Selection Guide	G-2,3
Linear Gage LGK	G-4
Linear Gage LGF	G-5
Linear Gage LGF-Z	G-6
Linear Gage LGB-Slim	G-7
Linear Gage LGB2-Slim	G-8,9
Linear Gage LG-Long Range	G-10,11
Linear Gage LGD	G-12,13
Linear Gage LGS	G-14
Linear Gage LGF-High Resolution	G-15
Linear Gage LGB2-High Resolution	G-16
Linear Gage LGH-High Resolution	G-17
Laser Hologage LGH-High Resolution	G-18
EH Counter-Multi Function	G-19
EC Counter-Single-function	G-20
EG Counter-Single-function	G-21
EB Counter-Single-function	G-22
EV Counter-Multi-function	G-23
EV Counter System Configuration	G-24
D-EV Display Unit	G-25
Sensopak Software	G-26
Litematic G-27	G-27
Quick Guide to Precision Measuring Instruments-Linear Gages	G-28,29

### Mu-checker

Mu-checker Probes	G-30,31
Mu-checker	G-32,33

### Laser Scan Micrometer

Laser Scan Micrometer Selection Guide	G-34,35
Laser Scan Micrometer LSM-6902H	G-36
Laser Scan Micrometer LSM-500S	G-37
Laser Scan Micrometer LSM-501S	G-38
Laser Scan Micrometer LSM-503S	G-39
Laser Scan Micrometer LSM-506S	G-40
Laser Scan Micrometer LSM-512S	G-41
Laser Scan Micrometer LSM-516S	G-42
Laser Scan Micrometer LSM-9506	G-43
LSM-6200 Display Unit	G-44
LSM-5200 Display Unit	G-45
Laser Scan Micrometer Optional Accessories	G-46-49
Interface for LSM6200, LSM 6900	G-48
Quick Guide to Precision Measuring Instruments-Laser Scan Micrometers	G-51













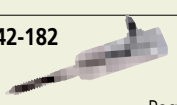
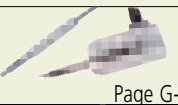
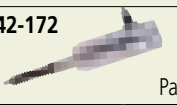

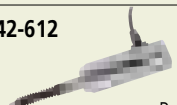

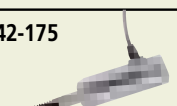



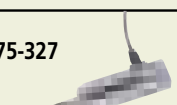
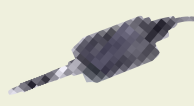







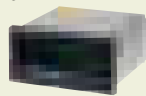





Linear Gage LGK

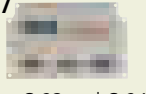

Laser Scan Micrometer  
LSM-500S

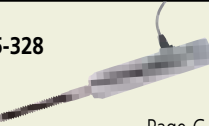
# Gage Heads / Display Units

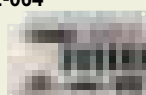
		Gage Heads			
		Measuring range			
Resolution		5mm / .2"	10mm / .4"	25mm / .1"	
5nm (0.005µm) 10nm (0.01µm)	<b>Laser Hologage</b> Page G-17 Page G-18		<b>542-715A, 542-716A, 542-720A, 542-721A,</b> (Low measuring force) Page G-17 and G-18		
0.0001mm	<b>LGB series</b> (nut clamp) Page G-8 <b>L GK series</b> Page G-4 <b>LGF series</b> Page G-15	<b>542-246</b> Refer to page G-16	<b>542-158</b> <b>542-181</b> 	<b>542-182</b> 	Page G-15
	<b>LG Long Stroke series</b> Page G-11				
0.0005mm	<b>L GK series</b> Page G-4 <b>LGF series</b> Page G-5		<b>542-171</b> <b>542-157</b> 	<b>542-172</b> 	Page G-5
0.001mm	<b>L GK series</b> Page G-4 <b>LGF series</b> • 0.5µm high-resolution type Page G-5		<b>542-156</b> <b>542-161</b> 	<b>542-162</b> 	Page G-5
	<b>LGB series</b> (ø8mm Straight) Page G-7	<b>542-204</b> Refer to page G-7	<b>542-222</b> (Sine-wave output) <b>542-222H</b> (High-precision) <b>542-224</b> (Low measuring force) <b>542-230</b> (air drive) Page G-7		
	Long Stroke series (Motor-drive type) Refer to page G-11				
	<b>LGB series</b> (nut clamp) Page G-8	<b>542-244</b> Refer to page G-8	<b>542-262</b> <b>542-262H</b> (High accuracy) <b>542-264</b> (Low measuring force) <b>542-270</b> (Air drive) Page G-8		
0.005mm	<b>LGF series</b> Page G-5			<b>542-612</b> 	Page G-5
0.0005mm	<b>LGF series</b> Series with reference point mark Page G-6		<b>542-174</b> 	<b>542-175</b> 	Page G-6
0.001mm	<b>LGF series</b> Series with reference point mark Page G-6		<b>542-164</b> 	<b>542-165</b> 	Page G-6
0.01mm	<b>LGD series</b> Page G-12		<b>575-326</b> 	<b>575-327</b> 	Page G-12
	<b>LGS series</b> Page G-14		<b>575-303</b> 		Page G-14

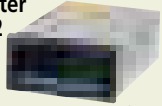
Gage Heads		Display unit		
Measuring range		Point measurement	Calculation measurement (addition and subtraction)	Multi-point measurement
50mm / 2"	100mm / 4"			
		<b>EH Counter</b> 542-074A 		
			Page G-19	
		<b>EG Counter</b> 542-015 		
			Page G-21	
	<b>542-312</b> <b>542-316</b> 			
			Page G-10	
<b>542-173</b> 		<b>EB Counter (LGH excluded)</b> 542-092-2 	<b>EH Counter</b> 542-071A 	<b>EV Counter</b> (LGH excluded) 542-063 
			Page G-5	
			Page G-22	
			Page G-19	Page G-23 and G-24
<b>542-163</b> 		<b>EH Counter</b> 542-075A 		
			Page G-5	
			Page G-19	
	<b>542-332</b> <b>542-336</b> 	<b>EG Counter</b> 542-015 		
			Page G-10	
			Page G-21	
<b>542-613</b> 		<b>EG Counter</b> 542-015 		
			Page G-5	
			Page G-21	
<b>542-176</b> 		<b>EG Counter</b> 542-017 	<b>EH Counter</b> 542-073A 	<b>EV Counter</b> 542-067 
			Page G-6	
			Page G-21	
<b>542-166</b> 		<b>EB Counter</b> 542-094-2 		
			Page G-6	
			Page G-22	Page G-23 and G-24
<b>575-328</b> 		<b>EC Counter</b> 542-007A 	<b>EH Counter</b> 542-072A 	<b>EV Counter</b> 542-064 
			Page G-12	
			Page G-20	
		<b>EG Counter</b> 542-016 		
			Page G-21	
		<b>EB Counter</b> 542-093-2 		
			Page G-22	Page G-23 and G-24
			Page G-19	

# Linear Gage LGK – Slim, Robust

Series 542 — Resolutions: 0.1µm, 0.5µm, 1µm

- Ideal for integration into harsh environments such as automation applications.
- Compact model offers the vibration/shock resistance of the proven LGF series at 1/5 the size compared to LGF-110L-B. Cross-sectional area is approx. 1/5 compared to LGF-110L-B.
- Resolution of each model can be selected from 0.1µm, 0.5µm, or 1µm.
- Excellent sliding durability improved to remain serviceable for at least 15 million cycles (in-house testing).
- Excellent shock resistance, 100g/11ms (IEC 60068-2-27).

542-158



542-157



542-156

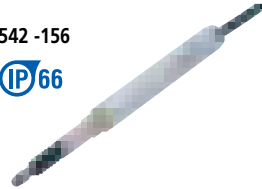

## SPECIFICATIONS

Order No.	542-158	542-157	542-156
Measuring range		10mm (.4")	
Resolution	0.1µm (.000005")	0.5µm (.000020")	1µm (.000050")
Measuring accuracy (20°C)	(0.8+L/50) µm (L=mm)		(1.5+L/50) µm (L=mm)
Quantizing error	±1 count		
Measuring force	Contact point upward	0.7N or less	
	Contact point horizontal	0.75N or less	
	Contact point downward	0.8N or less	
Position detection method	Photoelectric linear encode		
Response speed*1	400mm/s	1500mm/s	
Output signal	90° phase difference, differential square wave (RS-422A equivalent), minimum edge intervals: 200ns for 0.1µm model, 200ns for 0.5µm model, 400ns for 1µm model		
Output signal pitch	0.4µm	2µm	4µm
Mass	Approx. 175g		
Dust/water resistance*2	Equivalent to IP66 (only gage head)		
Contact point	ø3mm carbide-tipped (fixing screw: M2.5 (P=0.45)×5), standard contact point <b>No.901312</b>		
Stem dia.	ø8mm		
Bearing type	Linear ball bearing		
Output cable length	2m (directly from casing)		
Connector	Plug: RM12BPE-6PH (HIROSE), Compatible receptacle: RM12BRD-6S (HIROSE)		
Operating temperature (humidity) range	0 to 40°C (RH 20 to 80%, no condensation)		
Storage temperature (humidity) range	-10 to 60°C (RH 20 to 80%, no condensation)		
Standard Accessories	Wrench for contact point: <b>No.538610</b>		
Remarks	Gold banded	Blue banded	Green banded

\*1: When the spindle speed exceeds 1500mm/s (400mm/s for 0.1µm model), an alarm signal will be output. Also, if using Mitutoyo counter, an error message will be displayed. If using counters made by other companies, please inquire separately for the alarm signals. For the models of 0.1µm resolution, note that over-speed error may occur depending on the impact amount when releasing the contact point freely.

\*2: IP Code is a standard which classifies and rates the degree of protection provided against the intrusion of solid objects and water. This may not be applicable depending on the kind of liquid.

## DIMENSIONS

Unit: mm

542-158

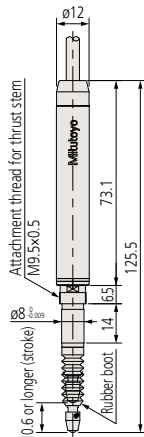

542-157

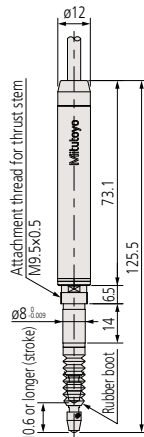

542-156

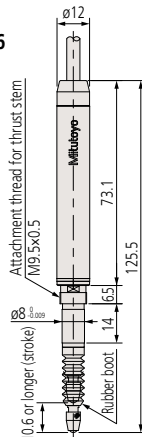

## Connector

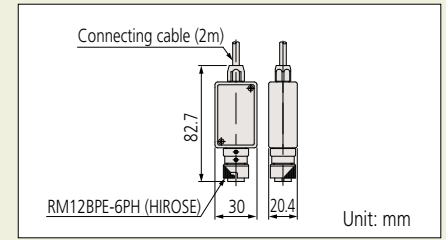

## Optional Accessories

- Air lifter 10: **No.02ADE230**
- \* Required air pressure: 0.2 to 0.4MPa
- \* Spindle extends when air is supplied.



- Rubber boot: **No.238772** (spare)
- Thrust stem set: \***No.02ADB680**
- Thrust stem: **No.02ADB681**
- Clamp nut: **No.02ADB682**
- Spanner wrench: **No.02ADB683**
- \* A thrust stem set is a combination of thrust stem and a clamp nut. A special spanner is required for tightening. If using multiple gages, a thrust stem set for each gage and one special spanner are required.

Extension cable (5m): **902434**

Extension cable (10m): **902433**

Extension cable (20m): **902432**

## Applicable Counters

**542-075A** EH-101P

**542-071A** EH-102P

**64PKA131** EG-101P

**64PKA134** EB-11P

**64PKA137** EV-16P (not compatible with 542-158)

# Linear Gage LGF – Standard Dimensions, Robust

## Series 542 — Resolutions: 0.5µm, 1µm, 5µm

### Connector

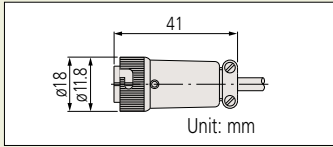

### Optional Accessories

- Air drive unit  
For 10mm range models: **No.02ADE230**  
For 25mm range models: **No.02ADE250**  
For 50mm range models: **No.02ADE270**
- \* Required air pressure: 0.2 to 0.4MPa
- \* Spindle extends when air is supplied.



- Rubber boot (spare)  
For 10mm range models: **No.238772**  
For 25mm range models: **No.962504**  
For 50mm range models: **No.962505**
- Thrust stem set  
For 10mm range models: **No.02ADB680**  
Thrust stem: **No.02ADB681**  
Clamp nut: **No.02ADB682**  
For 25/50mm range models: **No.02ADN370**  
Thrust stem: **No.02ADN371**  
Clamp nut: **No.02ADB692**
- \* External dimensions are described in the dimensional drawing of the product.
- \* A thrust stem set is a combination of thrust stem and a clamp nut. A special spanner is required for tightening. If using multiple gages, a thrust stem set for each gage and one special spanner are required.
- Spanner wrench  
For 10mm range models: **No.02ADB683**  
For 25/50mm range models: **No.02ADB693**

- Extension cable (5m): **902434**
- Extension cable (10m): **902433**
- Extension cable (20m): **902432**

### Applicable Counters

- 542-075A** EH-101P
- 542-071A** EH-102P
- 64PKA131** EG-101P
- 64PKA134** EB-11P
- 64PKA137** EV-16P (not compatible with 542-158)

- Excellent vibration/shock resistance due to the design of the spindle guide section.
- Sliding durability improved to remain serviceable for at least 15 million cycles (in-house testing).
- Shock resistance, 100g/11ms (IEC 60068-2-27)
- LGF-Z series, which is equipped with reference point mark on the linear encoder (refer to page G-7), and 0.1µm resolution type (refer to page G-16) are also available.

542-171, -161



542-172, -162



542-173, -163



542-612, -613



### SPECIFICATIONS

Order No.	542-171	542-161	542-172	542-162	542-612	542-173	542-163	542-613
Measuring range	10mm (.4")		25mm (1")			50mm (2")		
Resolution	0.5µm (.000020")	1µm (.000050")	0.5µm (.000020")	1µm (.000050")	5µm (.0002")	0.5µm (.000020")	1µm (.000050")	5µm (.0002")
Measuring accuracy (20°C) L=arbitrary measuring length (mm)	(1.5+L/50) µm				(7.5+L/50) µm	(1.5+L/50) µm		(7.5+L/50) µm
Quantizing error	±1 count							
Measuring force	Contact point upward	1.0N or less		4.0N or less			4.9N or less	
	Contact point horizontal	1.1N or less		4.3N or less			5.3N or less	
	Contact point downward	1.2N or less		4.6N or less			5.7N or less	
Position detection method	Photoelectric linear encoder							
Response speed*1	1500mm/s							
Output	90° phase difference, differential square wave (RS-422A equivalent), minimum edge intervals: 1000ns for 5µm model, 500ns for 1µm model, 250ns for 0.5µm model							
Output square wave pitch	2µm	4µm	2µm	4µm	20µm	2µm	4µm	20µm
Mass	Approx. 260g			Approx. 300g			Approx. 400g	
Dust/water resistance	Equivalent to IP66 (only gage head)							
Contact point	ø3mm carbide-tipped (fixing screw: M2.5 (P=0.45)×5), standard contact point <b>No.901312</b>							
Stem dia.	ø8mm			ø15mm				
Bearing type	Linear ball bearing							
Output cable length	2m (directly from casing)							
Connector	Plug: RM12BPE-6PH (HIROSE), Compatible receptacle: RM12BRD-6S (HIROSE)							
Operating temperature (humidity) range	0 to 40°C (RH 20 to 80%, no condensation)							
Storage temperature (humidity) range	-10 to 60°C (RH 20 to 80%, no condensation)							
Standard accessories	Wrench for contact point: <b>No.538610</b>			Wrench for contact point: <b>No.04GAA857</b>				

\*1: When the spindle speed exceeds 1500mm/s, an alarm signal will be output. Also, if using a Mitutoyo counter, an error message will be displayed. If using counters made by other companies, please inquire separately for the alarm signals. For the models using 50mm stroke gage, note over-speed speed error may occur depending on the impact amount when releasing the contact point freely.

\*2: IP Code is a standard which classifies and rates the degree of protection provided against the intrusion of solid objects and water. This may not be applicable depending on the kind of liquid.

### DIMENSIONS

542-171, -161

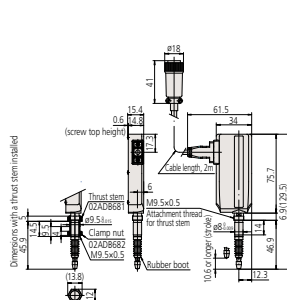

542-172, -162, -612

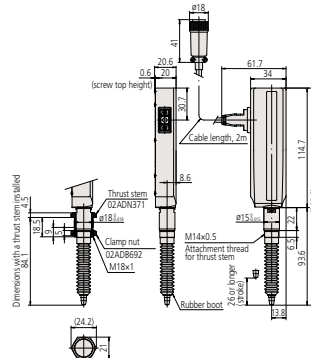

542-173, -163, -613

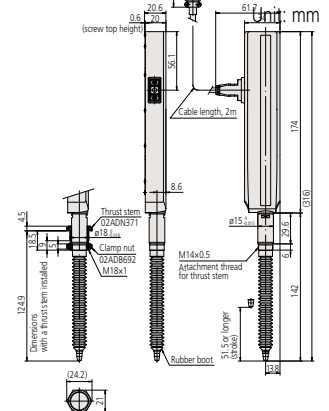

# Linear Gage LGF-Z – with Reference Point, Standard Dimensions, Robust

Series 542 — Resolutions: 0.5µm, 1µm

- LGF series with reference point signal output function.  
The master setting to use it, incorporated in the unit, is easy to operate. The origin point can be easily detected even when a fault, such as over-speed error, etc. occurs.
- Sliding durability improved to remain serviceable for at least 15 million cycles (in-house testing).
- Shock resistance, 100g/11ms (IEC 60068-2-27).
- Resolutions are available in 0.5µm or 1µm.



## SPECIFICATIONS

Order No.	542-174	542-164	542-175	542-165	542-176	542-166
Measuring range	10mm (.4")		25mm (1")		50mm (2")	
Resolution	0.5µm (.000020")	1µm (.000050")	0.5µm (.000020")	1µm (.000050")	0.5µm (.000020")	1µm (.000050")
Measuring accuracy (20°C)	(1.5+L/50)µm (L= measuring length (mm))					
Quantizing error	±1 count					
Measuring force	Contact point upward	1.0N or less	4.0N or less		4.9N or less	
	Contact point horizontal	1.1N or less	4.3N or less		5.3N or less	
	Contact point downward	1.2N or less	4.6N or less		5.7N or less	
Position detection method	Photoelectric linear encoder					
Reference mark position	3mm from contact point tip (lowest rest point)		5mm from contact point tip (lowest rest point)			
Reference mark repeatability (20°C): σ	σ≤0.5µm (at a constant reference point passing speed less than 300mm/s in the same direction)					
Response speed*1	1500mm/s					
Output signal	90° phase difference, differential square wave (RS-422A equivalent), minimum edge intervals: 250ns for 0.5µm model, 500ns for 1µm model					
Output square wave pitch	2µm	4µm	2µm	4µm	2µm	4µm
Mass	Approx. 260g		Approx. 300g		Approx. 400g	
Dust/water resistance*2	Equivalent to IP66 (only gage head)					
Contact point	ø3mm carbide-tipped (fixing screw: M2.5 (P=0.45)×5), standard contact point <b>No.901312</b>					
Stem dia.	ø8mm		ø15mm			
Bearing type	Linear ball bearing					
Output cable length	2m (directly extended from the main unit)					
Connector	Plug: PRC05-P8M (TAJIMI), Compatible receptacle: PRC05-R8F (TAJIMI)					
Operating temperature (humidity) range	0 to 40°C (RH 20 to 80%, no condensation)					
Storage temperature (humidity) range	-10 to 60°C (RH 20 to 80%, no condensation)					
Standard accessories	Wrench for contact point: <b>No.538610</b>			Wrench for contact point: <b>No.04GAA857</b>		
Remarks	w/ origin point mark					

\*1: When the spindle speed exceeds 1500mm/s, an alarm will signal. For use of alarm signals, please inquire separately. For models with 50mm stroke, note that over-speed error may occur depending on the impact amount when releasing the contact point freely.

\*2: IP code is a standard which classifies and rates the degree of protection provided against the intrusion of solid objects and water. This may not be applicable depending on the kind of liquid.

## DIMENSIONS

542-174, -164

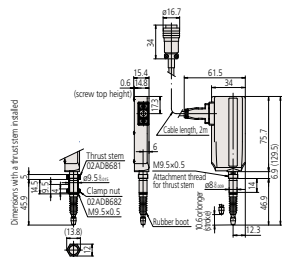

542-175, -165

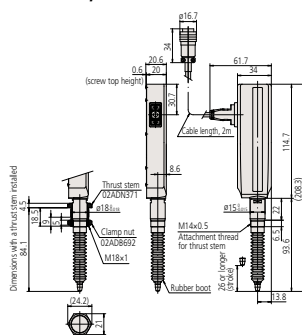

542-176, -166

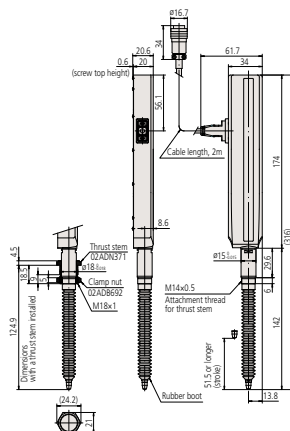

Unit: mm

## Connector

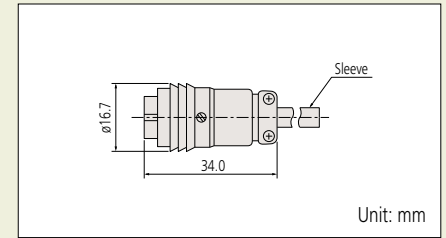

## Optional Accessories

- Air drive unit  
For 10mm range models: **No.02ADE230**  
For 25mm range models: **No.02ADE250**  
For 50mm range models: **No.02ADE270**
- \* Required air pressure: 0.2 to 0.4MPa
- \* Spindle extends when air is supplied.

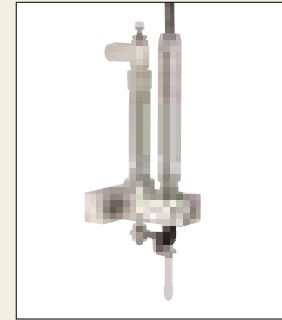

- Rubber boot (spare)  
For 10mm range models: **No.238772**  
For 25mm range models: **No.962504**  
For 50mm range models: **No.962505**
- Thrust stem set  
For 10mm range models: **No.02ADB680**  
Thrust stem: **No.02ADB681**  
Clamp nut: **No.02ADB682**  
For 25/50mm range models: **No.02ADN370**  
Thrust stem: **No.02ADN371**  
Clamp nut: **No.02ADB692**
- \* External dimensions are described in the dimensional drawing of the product.
- \* Thrust stem set is a combination of thrust stem and a clamp nut. A special spanner is required for tightening. If using multiple gages, a thrust stem set for each gage and one special spanner are required.
- Spanner wrench  
For 10mm range models: **No.02ADB683**  
For 25/50mm range models: **No.02ADB693**

Extension cable (5m): **02ADF260**  
Extension cable (10m): **02ADF280**  
Extension cable (20m): **02ADF300**

## Applicable Counters

542-073A EH-102Z  
64PKA133 EG-101Z  
64PKA136 EB-11Z  
64PKA139 EV-16Z



# Linear Gage LGB - Slim

## Series 542 — Resolution: 1µm

### Optional Accessories

- Rubber boot (spare)  
For 5mm range models: **No.238773**  
For 10mm range models: **No.238772**
- Extension cable (5m): **902434**
- Extension cable (10m): **902433**
- Extension cable (20m): **902432**

### Applicable Counters

- 542-075A** EH-101P
- 542-071A** EH-102P
- 64PKA131** EG-101P
- 64PKA134** EB-11P
- 64PKA137** EV-16P
- 542-074A** EH-1025 (for sine wave gages only)

- Compact form (ø8mm straight stem) is an optimal choice as a built-in type sensor.
- The spindle guide uses high-precision linear ball bearings for extremely smooth

- movement and exceptional durability.
- Nut clamp type is also available (LGB2: refer to page G-9).

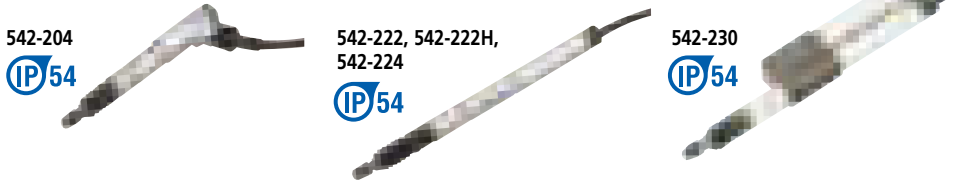

### SPECIFICATIONS

Type	L-shaped	Straight		Low measuring force	Air-driven contact point *1
Order No.	<b>542-204</b>	<b>542-222</b>	<b>542-222H</b>	<b>542-224</b>	<b>542-230</b> *2
Measuring range	5mm (.2")	10mm (.4")			
Resolution	1µm (.000050")				
Measuring accuracy (20°C)	2µm	1µm			2µm
Quantizing error	±1 count				
Measuring force*4	Contact point upward	Approx. 0.55N or less	Approx. 0.7N or less	Approx. 0.5N or less	Approx. 0.7N or less
	Contact point horizontal	Approx. 0.6N or less	Approx. 0.75N or less	Approx. 0.55N or less	Approx. 0.45N or less
	Contact point downward	Approx. 0.65N or less	Approx. 0.8N or less	Approx. 0.6N or less	Approx. 0.8N or less
Protection level	Equivalent to IP54 (only gage head)				
Mass	145g	150g			165g

\*1: Required air pressure: 0.3 to 0.4MPa

\*2: Spindle extends when air is supplied.

\*3: Spindle retracts when air is supplied.

\*4: Depends on the settings of the connected counter. Potential resolution down to 1µm.

### Slim-head low-measuring force series (made to order)

- Low measuring force, suitable for measurement of soft material workpieces.

Model	LGB-105L-1	LGB-110A-1/LGB-110AR-1*2
Measuring range	5mm	10mm
Resolution	1µm	1µm
Measuring force*1	Contact point upward	Approx. 0.4N or less
	Contact point horizontal	Approx. 0.45N or less
	Contact point downward	Approx. 0.5N or less

\*1: Measuring force at the retraction of the spindle

\*2: The "R" suffix indicates air retracted spindle

The LGB-□□□-1 is a low measuring force model. Depending on the operating method, the spindle forward speed may become slow compared to the standard model. Please check if this restriction is compatible with the application. Please contact Mitutoyo to verify the application.



Refer to No. (E13007) for more details.

### Connector

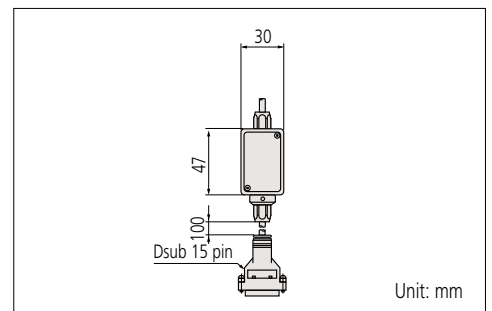
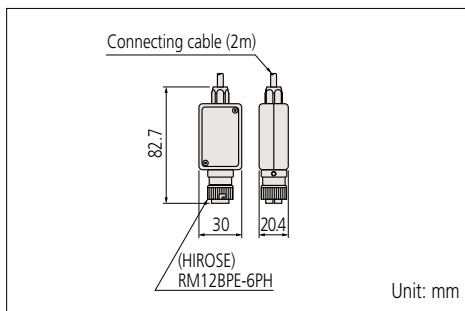

External dimensions: refer to page G-9.

# Linear Gage LGB2 – Slim, w/Clamp Nut

Series 542 — Resolution: 1µm

- Slim design, nut clamp type (Stem dia. is ø9.5mm)
- The spindle guide uses high precision linear ball bearings for extremely smooth movement and exceptional durability.



## SPECIFICATIONS

Type	L-shaped	Straight		Low measuring force	Air-driven contact point*1
Order No.	542-244	542-262	542-262H	542-264	542-270*2
Measuring range	5mm (.2")			10mm (.4")	
Resolution				1µm (.000050")	
Measuring accuracy (20°C)	2µm	1µm		2µm	
Maximum response speed				900mm/s	
Measuring force	Contact point upward	Approx. 0.55N or less	Approx. 0.7N or less	Approx. 0.5N or less	Approx. 0.7N or less
	Contact point horizontal	Approx. 0.6N or less	Approx. 0.75N or less	Approx. 0.55N or less	Approx. 0.75N or less
	Contact point downward	Approx. 0.65N or less	Approx. 0.8N or less	Approx. 0.6N or less	Approx. 0.8N or less
Protection level*4	IP54			IP54	
Mass	160g	170g		170g	

\*1: Required air pressure: 0.3 to 0.4MPa

\*2: Spindle extends when air is supplied.

\*3: Depends on the settings of the connected counter. Potential resolution down to 1µm.

\*4: IP code is a standard which classifies and rates the degree of protection provided against the intrusion of solid objects and water. This may not be applicable depending on the type of liquid.

## Slim head low measuring force series (made to order)

- Low measuring force, suitable for measurement of soft-material workpieces.

Model	LGB2-105L-1	LGB2-110AR-1	
Measuring range	5µm	10µm	
Resolution	1µm	1µm	
Measuring force*	Contact point upwards	Approx. 0.4N or less	Approx. 0.5N or less
	Contact point horizontal/ Contact point upwards	Approx. 0.45N or less	Approx. 0.55N or less
	Contact point downwards	Approx. 0.5N or less	Approx. 0.6N or less

\* Measuring force at the retraction of the spindle

The LGB2-□□□-1 is a low measuring force model. Depending on the operating method, the spindle forward speed may become slow compared to the standard model. Please check if this restriction is compatible with the application. Please contact Mitutoyo to verify the application

## Connector

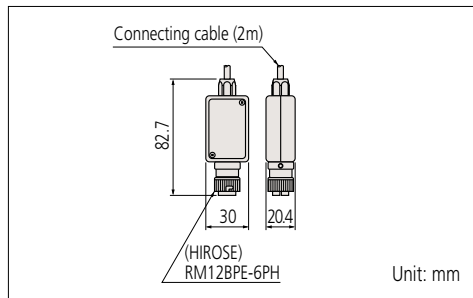

External dimensions: refer to page G-9.

## Optional Accessories

- Rubber boot (spare)  
For 5mm range models: **No.238773**  
For 10mm range models: **No.238772**
- Extension cable (5m): **902434**
- Extension cable (10m): **902433**
- Extension cable (20m): **902432**

## Applicable Counters

- 542-075A EH-101P
- 542-071A EH-102P
- 64PKA131 EG-101P
- 64PKA134 EB-11P
- 64PKA137 EV-16P
- 542-074A EH-1025 (for sine wave gages only)

# Linear Gage LGB2 – Slim

Series 542 — Resolution: 1µm

## Applicable Counters

<b>542-075A</b>	EH-101P
<b>542-071A</b>	EH-102P
<b>64PKA131</b>	EG-101P
<b>64PKA134</b>	EB-11P
<b>64PKA137</b>	EV-16P
<b>542-074A</b>	EH-1025 (for sine wave gages only)

## DIMENSIONS

Unit: mm

**542-204**

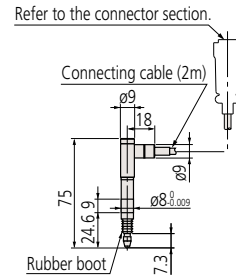

**542-222/No.542-222H**  
**542-224**

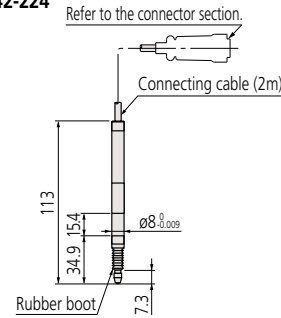

**542-230**

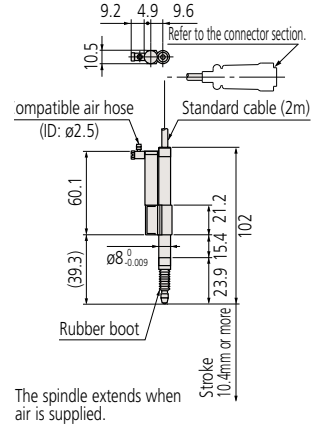

**542-244**

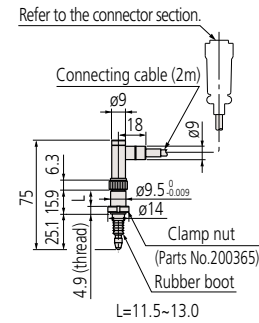

**542-262/542-262H**  
**542-264**

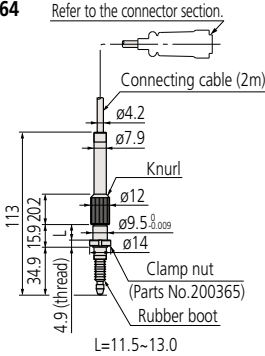

**542-270**

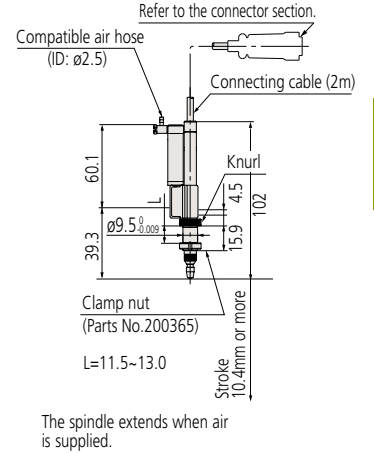

Refer to No. (E13007) for more details.

# Linear Gage LG – Long Range

**Series 542 — Resolutions: 0.1µm, 1µm**

- A series to cover maximum measuring range, 100mm.
- Three versions are available; standard model, low measuring force model, and rubber boot type (made to order).
- The resolution of each model can be selected from 0.1µm and 1µm.

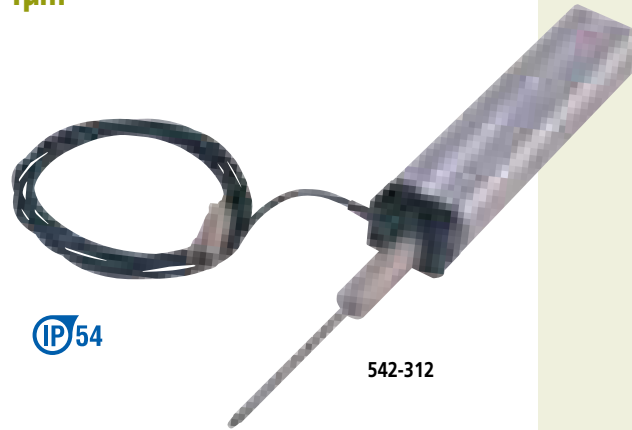

IP 54

542-312

## SPECIFICATIONS

Type	Standard spar type	Low measuring force	Rubber boot type	Standard spar type	Low measuring force	Rubber boot type
Order No.	<b>542-312</b>	<b>542-316</b>	<b>542-314</b>	<b>542-332</b>	<b>542-336</b>	<b>542-334</b>
Measuring range	100mm (4")					
Resolution	0.1µm (.000005")			1µm (.000050")		
Measuring accuracy (20°C)	(2+L/100)µm ≤ 2.5µm L= measuring length (mm)			(2.5+L/100)µm ≤ 3µm L= measuring length (mm)		
Quantizing error	±1 count					
Measuring force	Contact point downward	Approx. 8.0N or less	Approx. 3.0N or less	Approx. 8.0N or less	Approx. 8.0N or less	Approx. 3.0N or less
	Contact point horizontal	Approx. 6.5N or less	—	Approx. 6.5N or less	Approx. 6.5N or less	—
	Contact point upward	Approx. 5.0N or less	—	Approx. 5.0N or less	Approx. 5.0N or less	—
Position detection method	Photoelectric linear encoder					
Response speed*1 (max. electrical response speed)	Approx. 400mm/s			Approx. 800mm/s		
Output signal	90° phase difference, differential squarewave (RS-422A equivalent)					
Spindle drive	Helical extension spring					
Spindle guide	Bearing guide					
Stem diameter	ø20mm					
Contact point	ø3mm carbide-tipped (fixing screw: M2.5 (P=0.45)×5) Standard contact point No.901312					
Shock resistance	60g (in-house testing)					
Cable length	Approx. 2m (directly extended from the gage unit)					
Spindle sealing method	Scraper type		Rubber boot type	Scraper type		Rubber boot type
Dust/water resistance*2	Equivalent to IP54		Equivalent to IP66	Equivalent to IP54		Equivalent to IP66
Operating temperature (humidity) range	0 to 40°C (RH 20 to 80%, no condensation)					
Storage temperature (humidity) range	-10 to 60°C (RH 20 to 80%, no condensation)					
Input/output connector	For calculation: RM12BPE-6PH (HIROSE) Compatible receptacle: RM12BRD-6S (HIROSE)					
Mass (including cables)	Approx. 750g		Approx. 780g	Approx. 750g		Approx. 780g
Standard accessories	Wrench for contact point: <b>No.04GAA857</b> Hexagon socket head cap screw, M4×0.7×35, 2 pcs. (for gage fixing) Round flat washer, nominal 4, 2 pcs. (for gage fixing) Lifting clip: <b>No.137693</b> Fixing holder: <b>02ADG181</b> (for fixing lifting lever)					
Remarks	Standard	Low measuring force	w/ rubber boot	Standard	Low measuring force	w/ rubber boot

\*1: Note that over-speed error may occur depending on the indentation amount when releasing the contact point freely after indentation.

\*2: IP code is a standard which classifies and rates the degree of protection provided against the intrusion of solid objects and water. This may not be applicable depending on the kind of liquid. (Only gage head)

## Lifting clip attachment

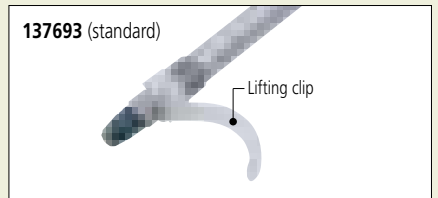

## Optional Accessories

- Rubber boot: **02ADA004** (for rubber boot type)

Extension cable (5m): **902434**

Extension cable (10m): **902433**

Extension cable (20m): **902432**

## Applicable Counters

For **542-312, 542-316, 542-314**

**542-075A** EH-101P

**542-071A** EH-102P

**64PKA131** EG-101P

**64PKA134\*** EB-11P

For **542-332, 542-336, 542-334**

**542-075A** EH-101P

**542-071A** EH-102P

**64PKA131** EG-101P

**64PKA134\*** EB-11P

**64PKA137\*** EV-16P

\* Not for use with 0.1µm resolution gages.

# Linear Gage LG – Long Range

Series 542 — Resolutions: 0.1µm, 1µm

## DIMENSIONS

542-312, -316, -332, -336

Unit: mm

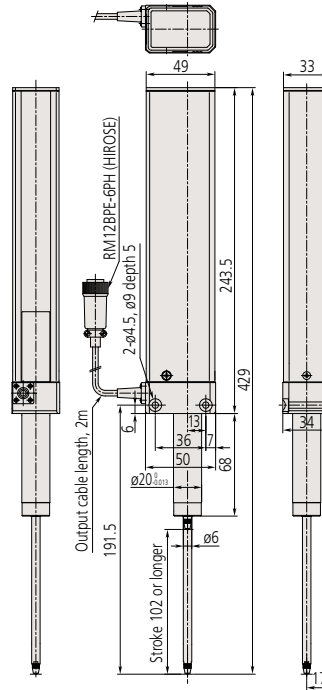

Refer to No. (E13007) for more details.

542-314, -334

Unit: mm

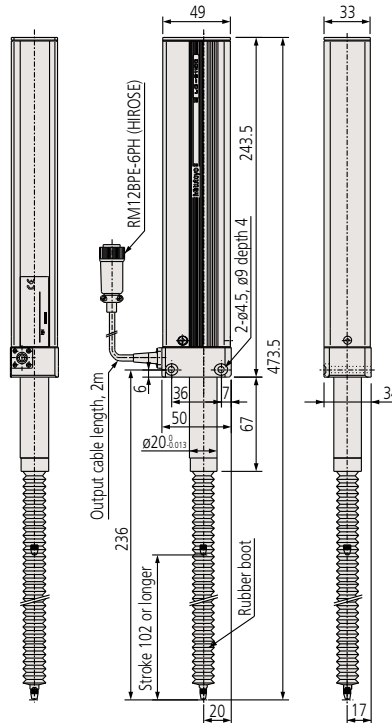

# Linear Gage LGD – Absolute, Standard Dimensions, Robust

Series 575 — Resolution: 10µm

- Absolute position detection makes it possible to maintain the reference point even when the power is switched off.
- Excellent protection against dust and splashing water (IP66) on the factory floor.
- Ultra-compact design enables installation in very tight spaces.
- The spindle guide uses high-precision linear ball bearings for extremely smooth movement and exceptional durability.
- Sliding durability improved to remain serviceable for at least 15 million cycles (in-house testing).
- Shock resistance, 100g/11ms (IEC 60068-2-27)



## SPECIFICATIONS

Order No.*1	575-326	575-327	575-328
Measuring range	.4" / 10mm	1" / 25mm	2" / 50mm
Resolution	.0005" / 10µm		
Measuring accuracy (20°C)	.001" / 20µm		30µm
Quantizing error	±1 count		
Measuring force	Contact point upward	1.0N or less	4.0N or less
	Contact point horizontal	1.1N or less	4.3N or less
	Contact point downward	1.2N or less	4.6N or less
Position detection method	ABSOLUTE electrostatic capacitance-type linear encoder		
Response speed	Unlimited (not applicable to scanning measurement)		
Output	Digimatic output		
External input	Reference-setting signal (Absolute reference position*2) can be changed externally.		
Mass*3	Approx. 260g	Approx. 300g	Approx. 400g
Contact point	ø3mm carbide-tipped (fixing screw: M2.5 (P=0.45)×5), standard contact point No.901312		
Stem dia.	ø8	ø15	
Bearing type	Linear ball bearing		
Dust/water resistance*4	Equivalent to IP66 (only gage head)		
Output cable length (directly extended from the main unit)	2m, 3m, 5m, 7m		
Operating temperature (humidity) range	0 to 40°C (RH 20 to 80%, no condensation)		
Storage temperature(humidity) range	-10 to 60°C (RH 20 to 80%, no condensation)		
Standard Accessories	Wrench for contact point: <b>No.538610</b>	Wrench for contact point: <b>No.04GAA857</b>	

\*1: The last number of the Code No. represents special cable length. (meters)

\*2: The absolute reference point is near the lowest rest point at shipment.

\*3: Mass including 2m cable.

\*4: IP code is a standard which classifies and rates the degree of protection provided against the intrusion of solid objects and water. This may not be applicable depending on the type of liquid.

ABSOLUTE™

## Connector

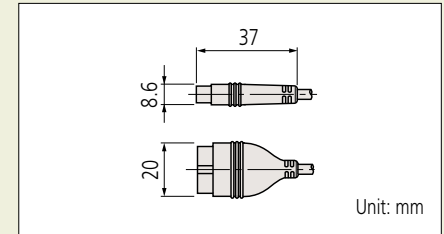

## Optional Accessories

- Air drive unit
  - For 10mm range models: **No.02ADE230**
  - For 25mm range models: **No.02ADE250**
  - For 50mm range models: **No.02ADE270**
- \* Required air pressure: 0.2 to 0.4MPa
- \* Spindle extends when air is supplied.
- Rubber boot (spare)
  - For 10mm range models: **No.238772**
  - For 25mm range models: **No.962504**
  - For 50mm range models: **No.962505**
- Thrust stem set
  - For 10mm range models: **No.02ADB680**
  - Thrust stem: **No.02ADB681**
  - Clamp nut: **No.02ADB682**
  - For 25/50mm range models: **No.02ADN370**
  - Thrust stem: **No.02ADN371**
  - Clamp nut: **No.02ADB692**
- \* External dimensions are described in the dimensional drawing of the product.
- \* Thrust stem set is a combination of thrust stem and a clamp nut. A special spanner is required for tightening. If using multiple gages, a thrust stem set for each gage and one special spanner are required.
- Spanner wrench
  - For 10mm range models: **No.02ADB683**
  - For 25/50mm range models: **No.02ADB693**

SPC cable extension adapter: **02ADF640**

Extension cable (0.5m): **02ADD950**

Extension cable (1m): **936937**

Extension cable (2m): **965014**

\*when connecting an extension cable, an SPC cable extension adapter is required (02ADF640)

Power supply and origin setter **21EZA345A**

Digimatic cable extension adapter **02ADF640**



## Applicable Counters

- 542-007A** EC-101D Counter, 120V
- 64PKA132** EG-101D
- 64PKA135** EB-11D
- 542-072A** EH-102D
- 542-064** EV-16D COUNTER

# Linear Gage LGD – Absolute, Standard Dimensions, Robust

Series 575 — Resolution: 10 $\mu$ m

## DIMENSIONS

575-326

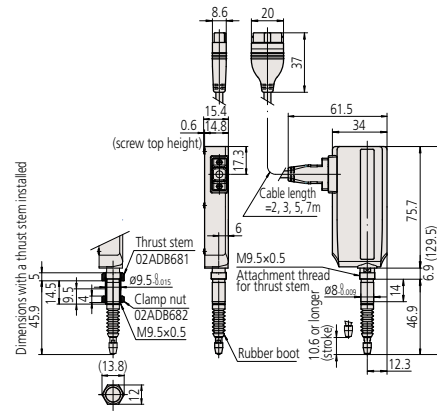

575-328

Unit: mm

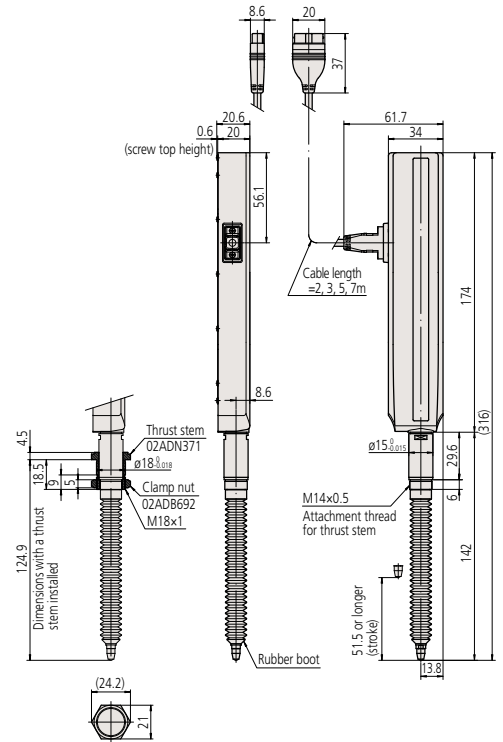

575-327

LGD®-1025L-B, -1025L/3-B, -1025L/5-B, -1025L/7-B

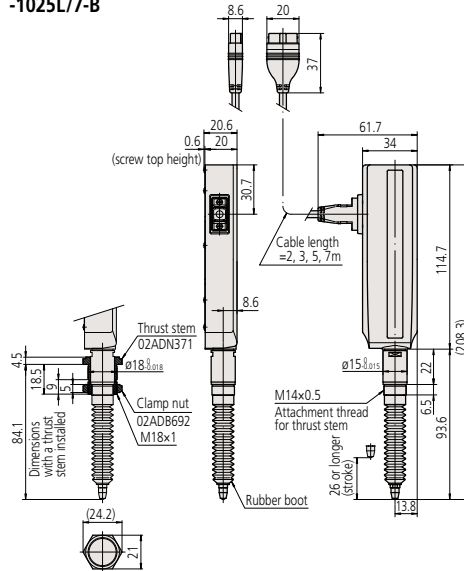

### Applicable Counters

- 542-007A EC-101D Counter, 120V
- 64PKA132 EG-101D
- 64PKA135 EB-11D
- 542-072A EH-102D
- 64PKA138 EV-16D COUNTER

3D models available on request.

# Linear Gage LGS – Absolute

Series 575 — Resolution: 10µm

575-303

IP66



- ABSOLUTE electrostatic capacitance-type encoder makes it possible to maintain the reference point even when the power is switched off.
- Excellent protection against dust and splashing water (IP66) on the factory floor.

## SPECIFICATIONS

Metric		
Order No.	575-303	
Measuring range	12.7mm	
Resolution	10µm	
Measuring accuracy (20°C)	15µm	
Quantizing error	±1 count	
Measuring force	Contact point upward	1.6N or less
	Contact point horizontal	1.8N or less
	Contact point downward	2N or less
Position detection method	ABSOLUTE electrostatic capacitance-type linear encoder	
Response speed	Unlimited (not applicable to scanning measurement)	
Output	Digimatic output	
Mass	Approx. 190g	
Contact point	ø3mm carbide-tipped (fixing screw: M2.5 (P=0.45)×5) Standard contact point <b>No.901312</b>	
Stem dia.	ø8mm	
Bearing type	Slide bearing	
Dust/water resistance	Equivalent to IP66 (only gage head)	
Output cable length	2m (directly extended from the main unit)	
Operating temperature (humidity) range	0 to 40°C (RH 20 to 80%, no condensation)	
Storage temperature (humidity) range	-10 to 60°C (RH 20 to 80%, no condensation)	

\* IP code is a standard which classifies and rates the degree of protection provided against the intrusion of solid objects and water. This may not be applicable depending on the type of liquid.

Inch		
Order No.	575-313	
Measuring range	.5"	
Resolution	.0005"	
Measuring accuracy (20°C)	.0008"	
Quantizing error	±1 count	
Measuring force	Contact point upward	1.6N or less
	Contact point horizontal	1.8N or less
	Contact point downward	2N or less
Position detection method	ABSOLUTE electrostatic capacitance-type linear encoder	
Response speed	Unlimited (not applicable to scanning measurement)	
Output	Digimatic output	
Mass	Approx. 190g	
Contact point	ø3mm carbide-tipped (fixing screw: M2.5 (P=0.45)×5) Standard contact point <b>No.901312</b>	
Stem dia.	ø9.52=3/8"	
Bearing type	Slide bearing	
Dust/water resistance	Equivalent to IP66 (only gage head)	
Output cable length	2m (directly extended from the main unit)	
Operating temperature (humidity) range	0 to 40°C (RH 20 to 80%, no condensation)	
Storage temperature (humidity) range	-10 to 60°C (RH 20 to 80%, no condensation)	

\* IP code is a standard which classifies and rates the degree of protection provided against the intrusion of solid objects and water. This may not be applicable depending on the type of liquid.

ABSOLUTE™

## Connector

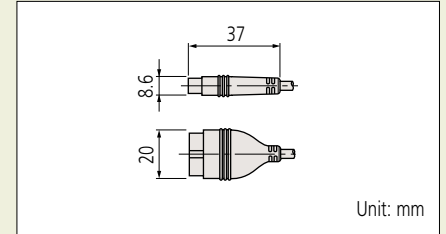

Unit: mm

## Optional Accessories

- Rubber boot: **No.238774** (spare)
- Air drive unit (metric): **No.903594**
- Air drive unit (inch): **No.903598**
- SPC cable extension adapter: **No.02ADF640**
- Extension cable (0.5m): **No.02ADD950**
- Extension cable (1m): **No.936937**
- Extension cable (2m): **No.965014**
- Power supply and origin setter **21EZA345A**

\* When connecting an extension cable, an SPC cable extension adapter is required. (**02ADF640**)

## Digimatic cable extension adapter 02ADF640



## Applicable Counters

- 542-007A** EC-101D Counter, 120V
- 64PKA132** EG-101D
- 64PKA135** EB-11D
- 542-072A** EH-102D
- 64PKA138** EV-16D COUNTER

## DIMENSIONS

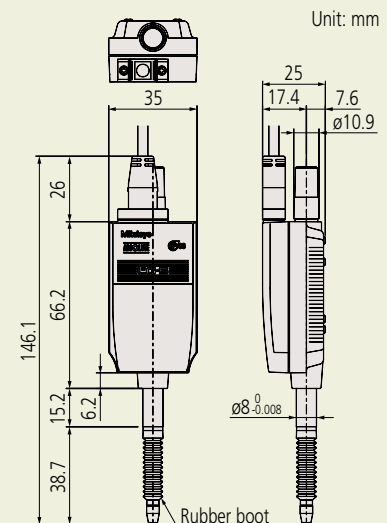

Unit: mm



# Linear Gage LGF – High Resolution, Standard Dimensions, Robust

## Series 542 — Resolution: 0.1 μm

### Connector

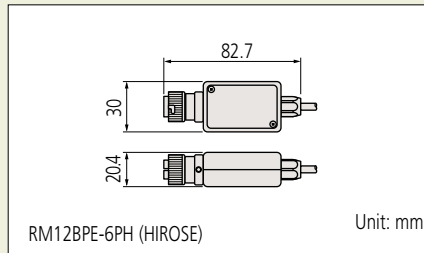

- 0.1 μm resolution type of reliable LGF series gage.
- Excellent protection against dust and splashing water (IP66) on the factory floor.

542-181  
IP66



542-182  
IP66

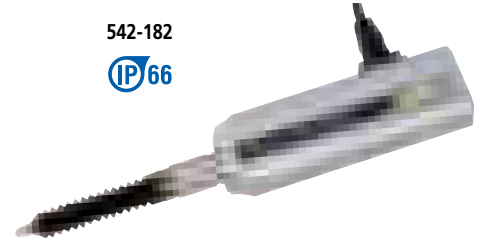

### Optional Accessories

- Rubber boot (spare)
  - For 10mm range models: **No.238772**
  - For 25mm range models: **No.962504**
  - For 50mm range models: **No.962505**
- Thrust stem set
  - For 10mm range models: **No.02ADB680**
  - Thrust stem: **No.02ADB681**
  - Clamp nut: **No.02ADB682**
  - For 25mm range models: **No.02ADN370**
  - Thrust stem: **No.02ADN371**
  - Clamp nut: **No.02ADB692**
- \* External dimensions are described in the dimensional drawing of the product.
- \* Thrust stem set is a combination of thrust stem and a clamp nut. A special spanner is required for tightening. If using multiple gages, a thrust stem set for each gage and one special spanner are required.
- Wrench
  - For 10mm range models: **No.02ADB683**
  - For 25mm range models: **No.02ADB693**
- Extension cable (5m): **902434**
- Extension cable (10m): **902433**
- Extension cable (20m): **902432**
- Air drive unit
  - For 10mm range models: **No.02ADE230**
  - For 25mm range models: **No.02ADE250**
  - For 50mm range models: **No.02ADE270**
- \* Required air pressure: 0.2 to 0.4MPa
- \* Spindle extends when air is supplied.

### SPECIFICATIONS

Order No.	542-181	542-182
Measuring range	10mm (.4")	25mm (1")
Resolution	0.1μm (.000005")	
Measuring accuracy (20°C)	(0.8+L/50) μm (L=arbitrary measuring length (mm))	
Quantizing error	±1 count	
Measuring force	Contact point upward	1.0N or less
	Contact point horizontal	1.1N or less
	Contact point downward	1.2N or less
Position detection method	Photoelectric linear encoder	
Response speed*1	400mm/s	
Output signal	90° phase difference, differential squarewave (RS-422A equivalent) Minimum edge-to-edge interval, 200ns	
Output signal pitch	0.4μm	
Mass	Approx. 310g	Approx. 350g
Dust/water resistance*2	Equivalent to IP66 (only gage head)	
Stylus	ø3mm carbide-tipped (fixing screw: M2.5 (P=0.45)×5), standard contact point <b>No.901312</b>	
Stem dia.	ø8	ø15
Bearing type	Linear ball bearing	
Output cable length	2m (directly extended from the main unit)	
Connector	Plug: RM12BPE-6PH (HIROSE), Compatible receptacle: RM12BRD-6S (HIROSE)	
Operating temperature (humidity) range	0 to 40°C (RH 20 to 80%, no condensation)	
Storage temperature (humidity) range	-10 to 60°C (RH 20 to 80%, no condensation)	
Standard accessories	Wrench for contact point: <b>No.538610</b>	Wrench for contact point: <b>No.04GAA857</b>

\*1: When the spindle speed exceeds 400mm/s, an alarm will signal. Also, if using a Mitutoyo counter, an error message will be displayed. If using counters made by other companies, please consult your local Mitutoyo office. Note that over-speed error may occur depending on the impact amount when releasing the contact point freely.

\*2: IP code is a standard which classifies and rates the degree of protection provided against the intrusion of solid objects and water. This may not be applicable depending on the type of liquid.

### Applicable Counters

- 542-075A** EH-101P
- 542-071A** EH-102P

### DIMENSIONS

542-181

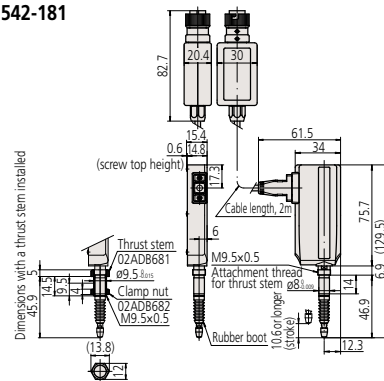

542-182

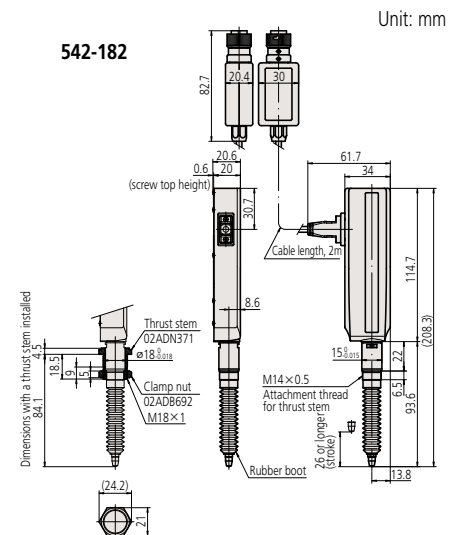

# Linear Gage LGB2 – High Resolution, Slim, with Clamp Nut

## Series 542 (0.1µm resolution)

- Slim type high-precision linear gage with resolution of 0.1µm. It is an optimal choice as a built-in type sensor.
- High-precision linear ball bearings are used in the spindle guide for extremely smooth movement and exceptional durability.

542-246



### Optional Accessories

- Rubber boot: **No.238773** (spare)
- Extension cable (5m): **902434**
- Extension cable (10m): **902433**
- Extension cable (20m): **902432**

### Applicable Counters

- 542-075A** EH-101P
- 542-071A** EH-102P

## SPECIFICATIONS

Order No.		542-246
Measuring range		5mm (.2")
Resolution		0.1µm (.000005")
Measuring accuracy (20°C)		0.8µm
Measuring force	Contact point upward	Approx. 0.55 or less
	Contact point horizontal	Approx. 0.6N or less
	Contact point downward	Approx. 0.65 or less
Output signal		90° phase difference, differential square wave (RS-422A equivalent)
Position detection method		Photoelectric linear encoder
Response speed		380mm/s
Mass		160g
Dust/water resistance*		Equivalent to IP54 (only gage head)
Contact point		Carbide ball (M2.5x0.45)   Steel ball (4-48UNF)
Stem dia.		ø9.5mm
Bearing type		Linear ball bearing
Output cable length		2m
Connector		Plug: RM12BPE-6PH (HIROSE), Compatible receptacle: RM12BRD-6S (HIROSE)
Operating temperature (humidity) range		10 to 30°C (RH 20 to 80%, no condensation)
Standard accessories		Wrench for contact point: <b>No.538610</b>   Wrench for contact point: <b>No.538610</b> , Stem bushing

\*1: IP code is a standard which classifies and rates the degree of protection provided against the intrusion of solid objects and water. This may not be applicable depending on the type of liquid.

## DIMENSIONS

Unit: mm

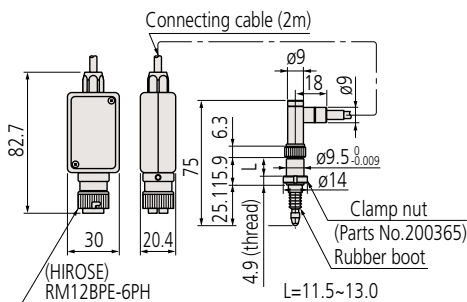



# Linear Gage LGH – High Resolution, High Accuracy

## SERIES 542 (0.01µm resolution)

### Optional Accessories

- LGH stand: **971750**
- Stem fixture for fixing to top surface: **971751**
- Stem fixture for fixing to bottom surface: **971752**
- Spindle lifting cable: **971753**
- Rubber boot: **238772** (spare for **542-715**)
- I/O output connector (with cover): **02ADB440**

### DIMENSIONS

Unit: mm

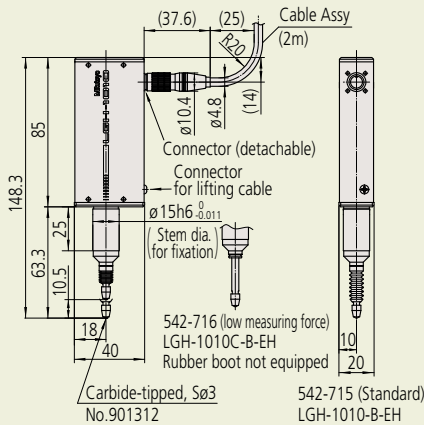

- A gage head featuring a very accurate, ultra-high-resolution photoelectric linear encoder that approaches laser interferometer performance over its measuring range of 10mm. This head is suitable for measuring high-precision components and inclusion in high-accuracy positioning applications.
- Relatively long range, very high accuracy and extreme resolution enable the head to act as a master gage for measuring-instrument calibration in many instances.
- The compact design contributes to reducing measuring system costs and permits downsizing entire system configurations.
- Linear encoder is highly resistant to being affected by unfavorable environmental conditions, such as drafts and rapid atmospheric pressure, temperature and humidity changes.
- A low measuring force model is available (**542-716A**). As low as 0.12N can be selected, which enables measurement of easily-deformed workpieces or thickness of delicate films.
- Responsivity has been improved by 2.8 times (250mm/s => 700mm/s) compared to the previous model.
- Every **LGH** series gage is bundled with a dedicated counter.

### SPECIFICATIONS

Linear gage	Standard	Low measuring force
Order No.	<b>542-715A</b>	<b>542-716A</b>
Measuring range	10mm	
Resolution	0.01µm (0.05µm, 0.1µm, 0.5µm, 1µm can be selected from the counter)	
Measuring accuracy (20°C)*	0.2µm	
Repeatability (20°C)*	0.1µm (2σ)	
Retrace error (20°C)*	0.1µm	
Measuring force	Contact point downwards	0.65N or less
	Contact point horizontal	0.55N or less
	Contact point upwards	0.45N or less
Position detection method	Photoelectric reflection type linear encoder	
Detectable operation speed	In normal measurement: 700mm/sec; for peak detection: 120mm/sec	
Mass of gage head	220g (excluding cable of approx. 150g)	
Contact point	ø3mm carbide-tipped (fixing screw: M2.5 (P=0.45)×5)	
Stem	ø15mm	
Bearing	Linear ball type	
Output cable length	Approx. 2m	
Operating temperature/humidity	0 to 40°C/RH 20 to 80% (no condensation)	
Storage temperature	-10 to 60°C/RH 20 to 80% (no condensation)	

### Counter

Quantizing error	±1 count
Display range	±999.99999mm
Functions	Presetting, tolerance judgment, peak measurement, analog output
Interface	RS-232C/Digimatic/USB (only for SENSORPAK)
Power supply	Supplied AC Adapter, or +12 to 24 V DC, max. 700mA
Current Consumption	8.4W (MAX 700mA) (Ensure at least 1A power supply per unit.)
External dimensions	144(W)×157(D)×75(H)
Mass	Approx. 900g (AC Adapter excluded)
Standard accessories	Wrench for contact point, rubber boot, stand, washer (for counter), AC Adapter, AC cord, DC plug, user's manual, inspection certificate

\*Indication accuracy applies when used with counters.

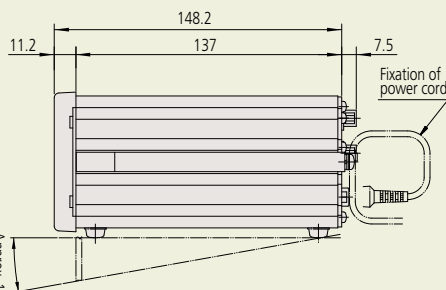
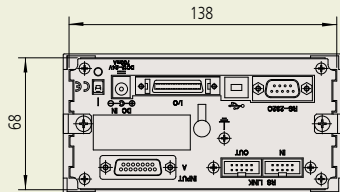
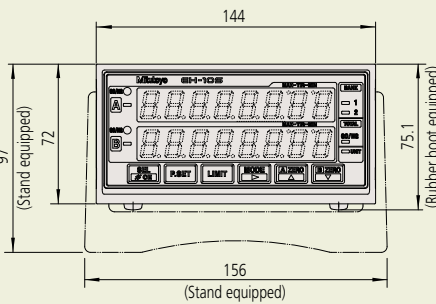

# Laser Hologage LGH – High Resolution, High Accuracy

## Series 542 — Resolution: 0.005 $\mu$ m

- The Mitutoyo Laser Hologage is a high-end digital gaging system that employs laser beam interference to make highly accurate and repeatable measurements.
- The compact gage head reduces the cost required for assembling the laser scale unit for each device. The head can also contribute to downsizing the entire system. The master gage is the best tool available for measuring tools or for a length measurement sensor of the control unit, as well as for measuring high-precision components.
- High resolution and high accuracy. Highly accurate measurement due to an ultra-high resolution of 0.000005mm (0.005 $\mu$ m), which is close to the performance of laser interferometers.
- Excellent measuring stability. The design is also highly resistant to unfavorable environmental conditions such as air movement and atmospheric pressure changes.
- Low measuring force models are also available. Low measuring force models are available for easily deformed precision workpieces.
- High reliability and excellent durability. High-precision linear ball bearings are used in the spindle guide for extremely smooth movement and exceptional durability.
- 0.005 $\mu$ m resolution LGH is for use with counter EH-102S.

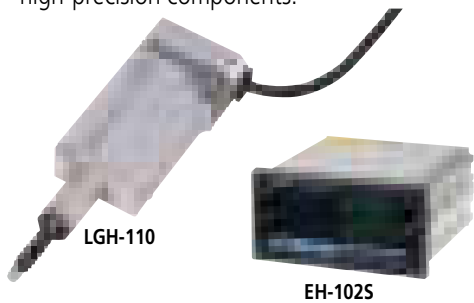

## SPECIFICATIONS

Code No.		542-720A	542-721A
Configuration		Set of 1-axis gage head and display unit	Set of 1-axis gage head and display unit
Measuring range		10mm	
Resolution		0.005 $\mu$ m (.5 microinch)	
Measuring accuracy (20°C)		0.1 $\mu$ m*1	
Repeatability (2 $\sigma$ )		0.02 $\mu$ m	
Retrace error		0.05 $\mu$ m	
Measuring force	Contact point upward	Approx. 0.65N or less	Approx. 0.12N
	Contact point horizontal	Approx. 0.55N or less	—
	Contact point downward	Approx. 0.45N or less	—
Stylus		$\varnothing$ 3mm carbide-tipped (fixing screw: M2.5 (P=0.45) $\times$ 5), standard contact point No.120058	
Output cable length		2m	
Display range		$\pm$ 99.999995mm	
Minimum reading		0.01 $\mu$ m	
Operating temperature (humidity) range		15 to 25°C (RH 30-60%, no condensation) -10 to 60°C (RH 20 to 80%, (no condensation)	
Storage temperature (humidity) range		The temperature and humidity range for storage after unpacking is the same as that for operation.	
Standard accessories		Wrench for contact point: <b>No. 538610</b> AC adapter: <b>No. 357651</b> AC cable (USA): <b>No.02ZAA010*</b>	
Mass (gage head + display unit)		1400g	

\*1: Indication accuracy applies when used with counters.

### Laser Beam Safety Precautions

This system uses a low-power invisible laser beam (780nm) which corresponds to a CLASS 1 (invisible radiation) of IEC 60825-1 for measurement. The CLASS 1 laser warning label as shown below is attached to the main unit.

**CLASS 1 LASER PRODUCT**

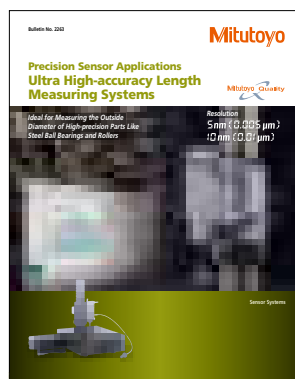

Refer to Bulletin No. (2263) for more details.



## Optional Accessories

- Laser hologage stand: **No.971750**
- Stem fixture for fixing to top surface: **No.971751**
- Stem fixture for fixing to bottom surface: **No.971752**
- Spindle lifting cable: **No.971753**
- Rubber boot: **No.238772** (spare)

## DIMENSIONS

Unit: mm

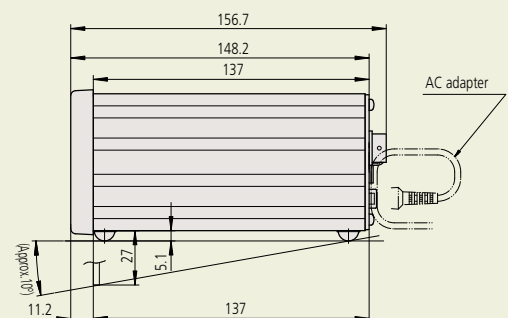
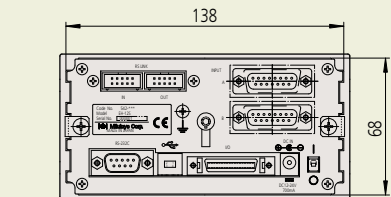
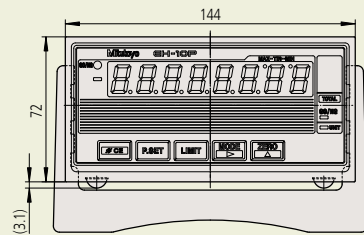
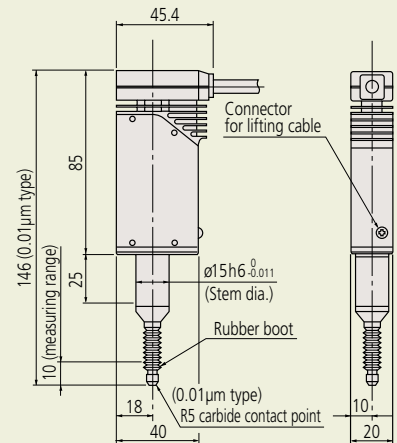

# EH Counter – Multi-function Type

**Series 542 — Versatile, Multi-function Displays for all Linear Gage Formats**

## Optional Accessories

- I/O output connector (with cover): **No.02ADB440**

- Two types are available for this model: a 1-axis display and a 2-axis display, which enables addition or subtraction calculations between two gages.
- Multifunctional counter equipped with zero-setting, presetting and tolerance judgment.
- RS-232C and USB are equipped as standard. Data transfer to a PC is possible. (\*USB is supported only by Mitutoyo SENSORPAK.)
- A multi-point (max. 12 points) measuring system can easily be configured with the built-in RS link networking function. Refer to "Quick Guide to Precision Measuring Instruments" on page G-32 for details of the RS link.
- Employs DIN size (144x72mm) and mount-on-panel configuration to facilitate system integration.
- Peak mode feature: Max, Min, and TIR (can be toggled)



## SPECIFICATIONS

Order No.	542-075A	542-071A	542-073A	542-074A	542-072A
Applicable gage head	LGE, LGF, LGK, LGB, LGM, LG, LGH (not compatible with LGH-110, reference point, or sine wave models)		LGF with reference point mark	LGB sine wave output / Linear scale sine wave output	LGD, LGS, ID, SD
Number of gage inputs	1		2		
Number of axes to be displayed	1 axis		2 axes		
Quantizing error	±1 count				
Maximum input frequency	2.5MHz (2-phase square wave)		1MHz (2-phase sine wave)		—
Resolution	0.01mm (±9999.99mm) / .0005" (±9.9995") 0.001mm (±999.999mm) / .00005" (±9.99995") 0.0001mm (±99.9999mm) / .000005" (±.999995") [Parameter set]				Automatic setting by gage
Display	Sign plus 8 digits (Green LED)				
Tolerance judgment display	LED display (3 steps: Amber, Green, Red/ 5 steps: Amber, Amber flashing, Green, Red flashing, Red)				
Interface	RS-232C/USB/parameter selection via digimatic (only DP-1VR, digimatic mini-processor can be connected) (USB used only with SENSORPAK.) Selection by parameter from 3-step, 5-step, or digit BCD Total tolerance judgment output (when tolerance function is enabled) Analog output (1V-4V)				
Input/output	Control output	Normal operation signal (NOM): open collector			
	Control input	Display BANK switching, peak mode, presetting, display hold, hold per axis: open-collector or no-voltage contact signal (with/without contact point)			
Rating	Power supply voltage	Supplied AC adapter, or 12 - 24V DC			
	Power consumption	8.4W (max. 700mA) Ensure at least 1A is available per unit.			
Operating temperature (humidity) range	0 to 40°C (RH 20 to 80%, no condensation)				
Storage temperature (humidity) range	-10 to 50°C (RH 20 to 80%, no condensation)				
External dimensions	144 (W) x 72 (H) x 156.7 (D) mm				
AC adapter / AC cable (standard accessory)	AC adapter: <b>No. 357651</b> / AC cable (USA): <b>No.02ZAA010*</b> ,				
Applicable input	Differential square-wave			Differential sine-wave	Digimatic code output
Mass	Approx. 760g	Approx. 800g	Approx. 800g	Approx. 900g	Approx. 800g

## DIMENSIONS

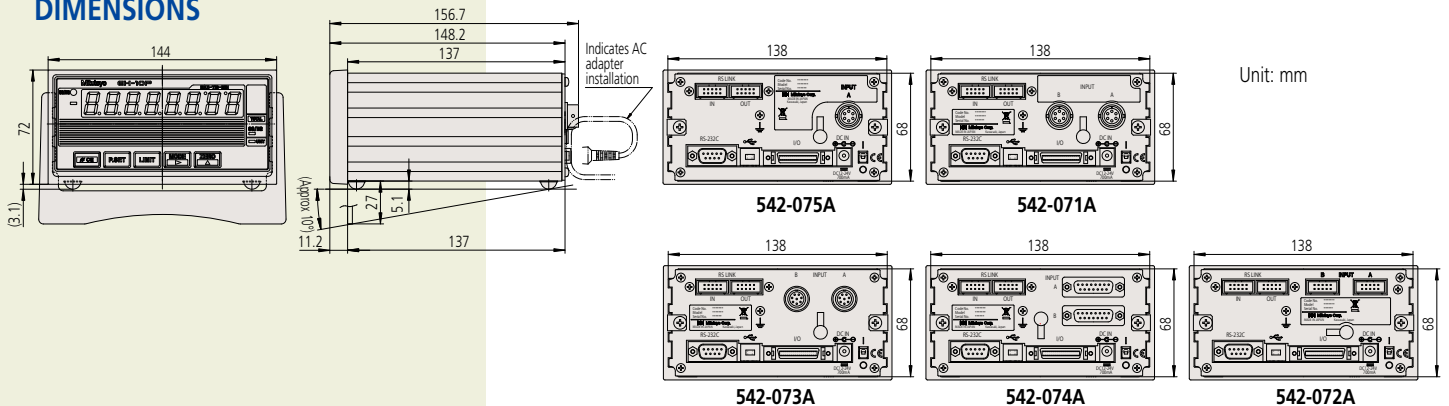

# EC Counter – Single-function Type

Series 542 — Simple Display for LGD, LGS, or other Digimatic Gages, Go/NG Judgment and Output

- Produces 3-step/5-step, 3 types of tolerance output and BCD output.
- Employs DIN size (96×48mm) and mount-on-panel configuration to facilitate system integration.



542-007A



## Function

- Preset
- Tolerance judgment (3/5-step, 3 types)
- Zero

## Optional Accessories

- Connecting cable for digimatic mini-processor: **No.936937** (1m), **No.965014** (2m)
- DC plug PJ-2: **No.214938**
- I/O cable (2m): **No.C162-155**

## SPECIFICATIONS

Order No.	<b>542-007A</b>	
Applicable head/input	<b>LGD, LGS, ID, SD, Digimatic code (SPC)</b>	
Number of gage inputs	1	
Resolution	0.01mm (±9999.99) / .0005" (±99.9995") / .001" (±999.999") 0.001mm (±9999.999) / .00005" (±9.99995") / .0001" (±99.999") [automatic setting by gage]	
Display	Sign plus 6 digits (Green LED)	
Tolerance judgment display	LED display (3 steps: Amber, Green, Red)	
External output (switching type)	Tolerance judgment output	Go/No-Go (open-collector)
	Data output	Digimatic output
Control input	External PRESET, external HOLD	
Rating	Power supply voltage	Supplied AC adapter, or 9 - 12V DC
	Power consumption	4.8W (max. 400mA) Ensure at least 1A is available per unit.
Operation/storage temperature range	Operation: 0 - 40°C / Storage: -10 to 50°C	
External dimensions	96 (W) × 48 (H) × 84.6 (D) mm	
Standard accessories	AC adapter: <b>No.06AEG302JA</b>	
Mass	220g	

## DIMENSIONS

Unit: mm

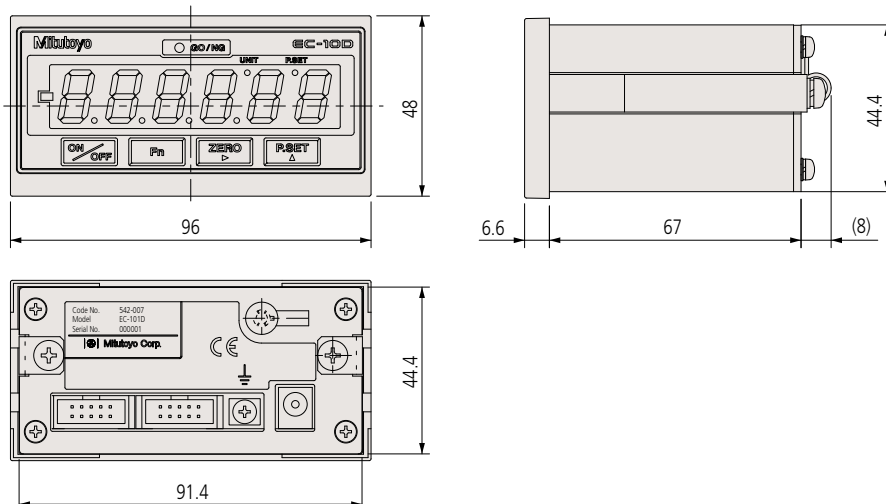

# EG Counter – Single-function Type

## Series 542 — Simple Display, Multi-Step Go/No Go Judgment and Output, BCD Output, Open Collector

### Function

- Preset
- Direction switch
- Tolerance judgment (3/5-step, 3 kinds)
- Peak (max., min., runout) measurement
- Constant number
- Smoothing
- Error display/output
- Key protection

### Optional Accessories

- I/O output connector (with cover): **No. 357651**
- AC adapter: **No.357651 \***
- AC cable (USA): **02ZAA010\***
- Terminal connecting cable: **No.02ADD930\***
- \* Included in package Order No.

- Produces 3-step/5-step, 7 types of tolerance output and limit value output independently for each of 7 channels.
- Comes with serial BCD output capability, for connection to a programmable controller or personal computer, etc.
- Employs DIN size (96x48mm) and mount-on-panel configuration to facilitate system integration.



542-015

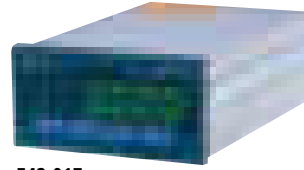

542-017

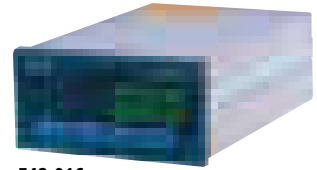

542-016

### SPECIFICATIONS

Order No. (counter only)	542-015	542-017	542-016
Package No. (counter w/AC adapter)	64PKA131A	64PKA133A	64PKA132A
Applicable gage head	LGE, LGF, LGK, LGB, LGM, LG, LGH (Not compatible with LGH110, reference point or sine wave models)	LGF with reference point mark (LGF-Z)	LGD, LGS, ID, SD
Number of gage inputs	1		
Quantizing error	±1 count		
Maximum input frequency	1.25MHz, response speed depends on gage specification.		
Resolution	0.01mm (±9999.99mm) / .0005" (±99.9995") / .001" (±999.999") 0.005mm (±9999.995mm) / .00005" (±9.99995") / .0001" (±99.999") 0.001mm (±999.999mm) / .00005" (±9.99995") / .0001" (±99.999") 0.0005mm (±99.9995mm) / .000005" (±.999995") / .00001" (±9.99999") 0.0001mm (±99.9999mm) / .000005" (±.999995") / .00001" (±9.99999")*	—	0.01mm (±9999.99mm) / .0005" (±99.9995") / .001" (±999.999") (±99.9995") / .001" (±999.999") 0.001mm (±999.999mm) / .00005" (±9.99995") / .0001" (±99.999") .00005" (±9.99995") / .0001" (±99.999") (±99.999") [Automatic setting by gage]
Display	Sign plus 6 digits (Green LED)		
Tolerance judgment display	LED display (3 steps: Amber, Green, Red/ 5 steps: Amber, Amber flashing, Green, Red flashing, Red)		
Tolerance judgment output	L1 to L5 (Open-collector / Switchover between L1 to L5 and BCD output with parameter)		
Control output	Normal operation signal (NOM): open-collector		
BCD output	Open-collector / Switchover between 6-digit (positive/negative-true logic) and tolerance judgment output with parameter		
Control input	Presetting, display hold, peak value clear, tolerance judgment BANK switch		
Rating	Power supply voltage	12 - 24V DC	
	Power consumption	6W or less (500mA max.) Ensure at least 1A is available per unit.	
Operating temperature range	0 to 40°C (RH 20 to 80%, no condensation)		
Storage temperature range	-10 to 50°C (RH 20 to 80%, no condensation)		
External dimensions	96 (W) x 48 (H) x 156 (D) mm		
Applicable input	Differential square-wave	Differential square-wave with origin point mark	Digimatic code (SPC)
Number of gage inputs	1		
Mass	Approx. 400g		

\* range is limited when using 0.0001 mm gages

### DIMENSIONS

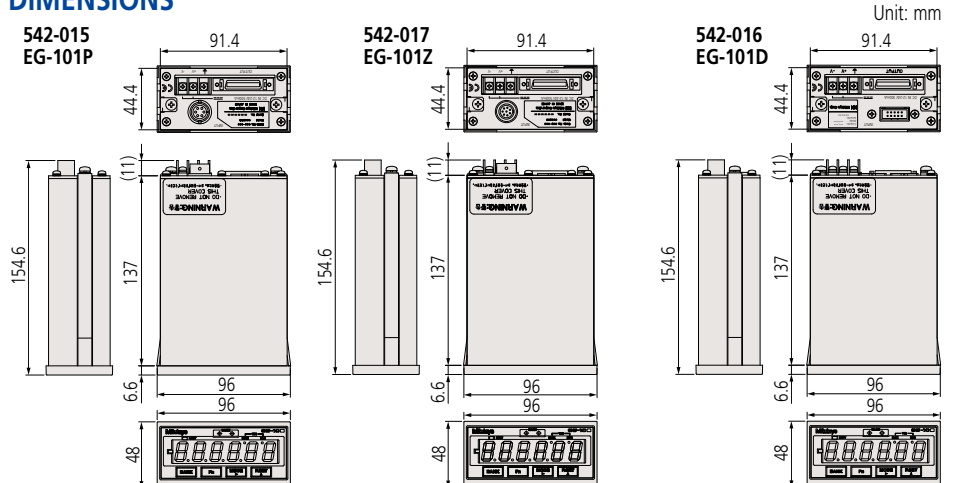

# EB Counter – Single-function Type

## Series 542 — Simple Display, Multi-Step Go/No-Go Judgment, BCD Output and Analog Output

- Produces 3-step/5-step, 7 types of tolerance output and limit value output independently for each of 7 channels.
- Comes with serial BCD output capability, for connection to a programmable controller or personal computer, etc.
- Dynamic measurement possible with simplified analog output.
- Employs DIN size (96×48mm) and mount-on-panel configuration to facilitate system integration.



542-092-2



542-094-2



542-093-2

### SPECIFICATIONS

Order No. (counter only)	542-092-2	542-094-2	542-093-2
Package No. (counter w/AC Adapter)	64PKA134A	64PKA136A	64PKA135A
Applicable gage head	LGF, LGK, LGE, LGB (not compatible with reference point or sine wave output type models)	LGF with reference point mark (LGF-Z)	LGS, LGD, LGD-M
Number of gage inputs	1		
Quantizing error	±1 count		
Maximum input frequency	1.25MHz (2-phase square wave), response speed depends on gage specification.		Response speed depends on gage specification.
Resolution	0.01mm (±9999.99mm) / .0005" (±99.9995") 0.005mm (±9999.995mm) / .00005" (±9.99995") 0.001mm (±999.999mm) / .00005" (±9.99995") 0.0005mm (±99.9995mm) / .000005" (±.999995") 0.0001mm (±99.9999mm) / .000005" (±.999995")*		0.01mm (±9999.99mm) / .0005" (±9.9995") 0.005mm (±9999.995mm) / .00005" (±9.99995") 0.001mm (±999.999mm) / .00005" (±9.99995") 0.0005mm (±99.9995mm) / .000005" (±.999995") 0.0001mm (±99.9999 mm) / .000005" (±.999995")
Display	Sign plus 6 digits (Green LED)		
Tolerance judgment display	LED display (3 steps: Amber, Green, Red / 5 steps: Amber, Amber flashing, Green, Red flashing, Red)		
Input/output	Tolerance judgment output	L1 to L5, open-collector	
	Control output	Normal operation signal (NOM), open-collector	
	Control input	Presetting, display hold, peak value clear, tolerance judgment BANK switch, open-collector or no-voltage contact signal (with/without contact point)	
Interface	Serial BCD	Bit serial format, open-collector	
	Analog output	2.5V+Counting value Voltage resolution (25mV/2.5mV): Full-scale 0 to 5V	
	Digimatic input/output	<ul style="list-style-type: none"> <li>• Connecting to the external switch box (No.02ADF180) makes it easy to enter tolerance limits and preset values. Note: This function is not available when the gage is connected to DP-1VR, Digimatic Mini-Processor.</li> <li>• Can be connected to Digimatic peripherals that have Data (poll) button</li> <li>• Number of tolerance steps can be expanded by assembling EB-D counters.</li> </ul>	
Rating	Power supply voltage	12 - 24V DC	
	Power consumption	6W or less (50mA max.) Ensure at least 1A is available per unit.	
Operating temperature range	0 to 40°C (RH 20 to 80%, no condensation) / -10 to 50°C (RH 20 to 80%, no condensation)		
External dimensions	96(W)×48(H)×156(D)mm		
Applicable input	Differential square-wave	Differential square-wave with origin point mark	Digimatic code (SPC)
Mass	Approx. 400g	Approx. 400g	Approx. 400g

\* range is limited when using 0.0001 mm gages

### Function

- Preset
- Tolerance judgment output (3/5-step, 7 types)
- Limit value output (2 types independently for each of the 7 channels)
- Peak (max., min., runout) measurement
- Diverse data output (Serial BCD, Simplified analog, Digimatic)

### Optional Accessories

- I/O output connector (with cover): No.02ADB440
  - AC adapter: No.357651 \*
  - AC cable (USA): 02ZAA010\*
  - Terminal connecting cable: No.02ADD930\*
- \* Included in package Order No.  
The tolerance values or preset values can be easily input.  
No.02ADF180 (with 2m cable)



### DIMENSIONS

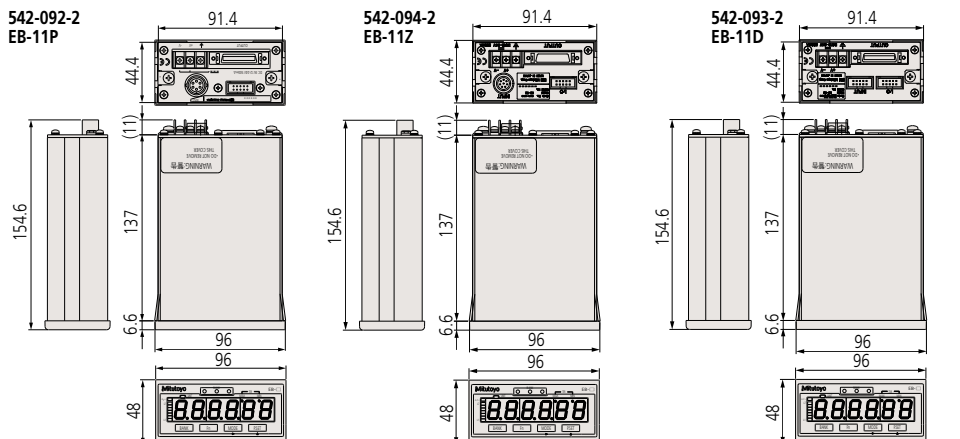



# EV Counter – Multi-function, Multiple Input Type

## Series 542 — Processor (Optional Display), Multi-function/output

- Up to six gages can be connected to one unit, extendable up to 10 units (60 gages at maximum) using the RS Link function\* to facilitate the configuration of a multi-point measurement system.

\* Refer to "Quick Guide to Precision Measuring Instruments" on page G-32 for details of the RS link.

- A range of output modes to choose from: I/O output for tolerance judgment and segment output, BCD data output and RS-232C output are available.
- Other than normal measurement, peak measurement or differential measurement between gages are available.

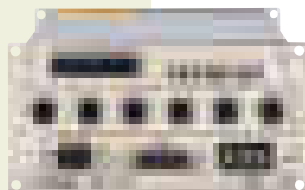

542-063

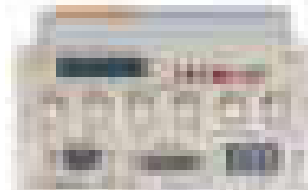

542-067



542-064

### Function

- External Control (Zero-set, Preset etc.)
- Direction switch
- Error display
- Tolerance judgment output
- Diverse data output (RS-232C, BCD, Segment)
- Peak measurement

Maximum value, minimum value, runout, and differential measurement between two gages  
Addition, averaging, maximum value, minimum value, and maximum width

### Optional Accessories

- D-EV External display unit: **No.02ADD400**
  - SPC cable (0.5m): **No.02ADD950**
  - SPC cable (1m): **No.936937**
  - SPC cable (2m): **No.965014**
  - AC adapter: **No.357651** \*
  - AC cable (USA): **02ZAA010** \*
  - Terminal connecting cable: **No.02ADD930** \*
- \* Included in package Order No.

### SPECIFICATIONS

Order No.	542-063	542-067	542-064
Pkg No.(counter w/AC adapter)	<b>64PKA137A</b>	<b>64PKA139A</b>	<b>64PKA138A</b>
Applicable gage head	<b>LGE, LGF, LGK, LGB, LGM, LG</b> not compatible with reference point mark, sine wave output type or 0.1μm resolution models.	<b>LGF with reference point mark (LGF-Z)</b>	<b>LGD, LGS</b>
Number of input channels	6		
Maximum input frequency	1.25MHz (2-phase square wave), response speed depends on gage specification. Max. counting speed: 5MHz	1.25MHz (2-phase square wave), response speed depends on gage specification. Max. counting speed: 5MHz	Response speed depends on gage specification.
Quantizing error	±1 count		
Resolution	10μm (±999999.99mm) / .0005" (±9999.9995") 5μm (±999999.995mm) / .00005" (±999.99995") 0.5μm (±9999.9995mm) / .000005" (±.99999995")*1 [Parameter set]	10μm (±999999.99mm) / .0005" (±9999.9995") 5μm (±999999.995mm) / .00005" (±999.99995") 1μm (±99999.999mm) / .00005" (±999.99995") 0.5μm (±9999.9995mm) / .000005" (±.99999995") [Parameter set]	Depends on gage specification.
LED display	8 digits for parameter display (displays settings), 1 for error display		
Error message	Overspeed, gage error etc.		
External display	Dedicated external display unit D-EV (optional) can be connected.		
Number of input switches	4		
Function of input switches	Measurement mode switching, parameter setting		
Input/output	Tolerance judgment output	1 to 6 channels (L1, L2, L3), open-collector	
	BCD output	Parallel BCD output (positive/negative-true logic), open-collector	
	Segment output	Function to set on only the terminals corresponding to the counting values, open-collector	
	Control output	Normal operation signal (NOM), open-collector	
Interface	Control input	Output channel designation (segment, in the BCD mode), presetting, peak value clear, range changeover (at segment output), holding counting value open-collector or no-voltage contact signal (with/without contact point)	
	RS-232C	Measurement data output and control input EIA RS-232C-compatible Use cross cables for home position, DTE (terminal definition).	
Rating	RS link	Max. connecting unit: 10 (6 when using EF counter) Connecting cable length: Max. 10m (sum of link cable length) Data transfer time: 1sec./60ch (when transmission rate is 19200bps)	
	Power supply voltage	12 - 24V DC, terminal block (M3 screw)	
	Power consumption	8.4W or less (700mA max.) Ensure at least 1A is available per unit.	
Operating temperature (humidity) range	0 to 40°C (RH 20 to 80%, no condensation)		
Storage temperature (humidity) range	-10 to 50°C (RH 20 to 80%, no condensation)		
External dimensions	144 (W) × 72 (H) × 139 (D) mm		
Mass	Approx. 910g	Approx. 910g	Approx. 830g
Standard accessories	Fixing foot (4), connecting bracket (4), fixing screw M4×12 (8)		
Applicable input	Differential square-wave		Digimatic code (SPC)

\*1: Available when using D-EV.

\*2: D-EV is required when selecting 0.1μm resolution.

# EV Counter System Configuration

Series 542 — Processor (Optional Display), Multi-function/output

## System Configuration

A counter system performs output and display for connected Mitutoyo linear gages.

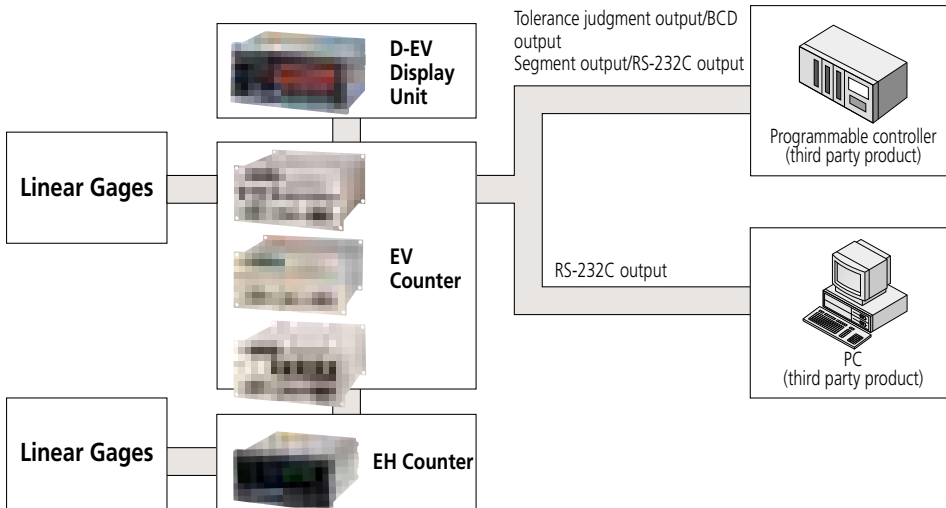

## DIMENSIONS

Unit: mm

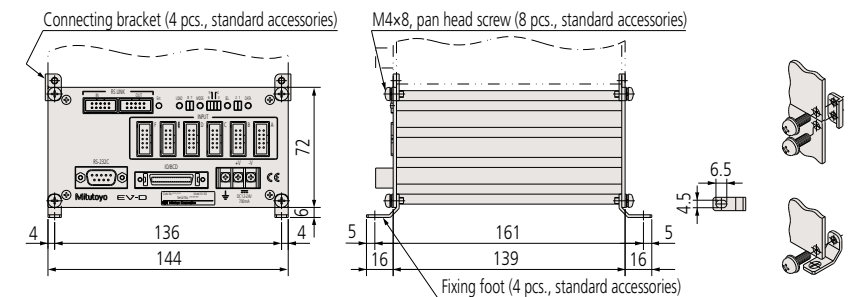
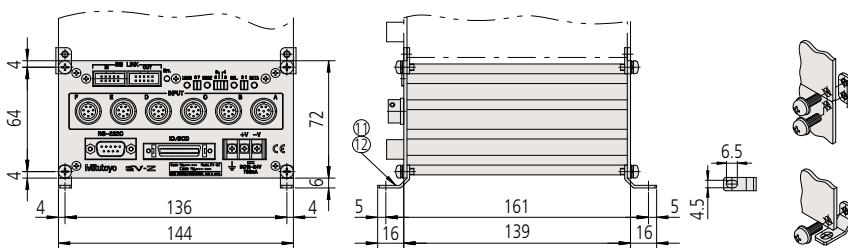
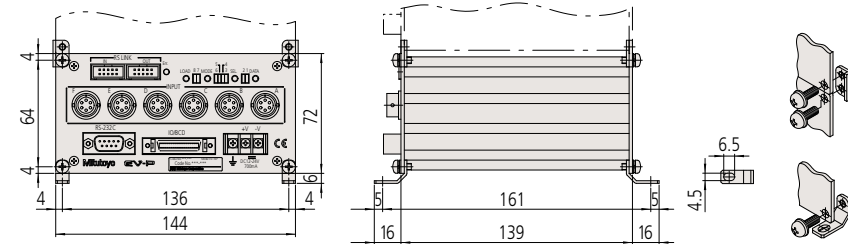

# D-EV Display Unit for EV Counter

## Function

- External Control (Zero-set, Preset etc.)
- Direction switch
- Error display
- Tolerance judgment output
- Data output (RS-232C, BCD, Segment)
- Peak measurement

Maximum value, minimum value, runout, and differential measurement between two gages  
 Addition, averaging, maximum value, minimum value, and maximum width

## Optional Accessories

- SPC cable (0.5m): **No.02ADD950**\*1
- SPC cable (1m): **No.936937**\*1
- SPC cable (2m): **No.965014**\*1
- AC adapter: **No.357651**
- AC cable (USA): **02ZAA010**\*2
- Terminal connecting cable: **02ADD930**\*2

\*1: Required when connecting with **EV-16P/D/Z**.

\*2: Required when using AC adapter.

Note: AC adapters may not be needed if using power from EV counter to power the D-EV.

- Display unit for the EV counter.
- Allows set up of EV counter without a personal computer or other equipment.

- Able to display each gage measurement value and go/no-go judgment result, total go/no-go judgment result for all gages, setting details and errors.



**02ADD400**

## SPECIFICATIONS

Order No.	<b>02ADD400</b>
Number of connections	1 EV counter per unit
Number of digits	Sign plus 6 digits (8 digits internal to EV counter)
LED	Channel display (also for judgment result display): 3 (3-color LED) Measurement mode display (current data, maximum value, minimum value, runout): 2 Status display: 1 (2 colors)
Operation switches	4
Function of operation switch	Channel switching, measurement mode switching (current data, maximum value, minimum value, runout), parameter setting, presetting, tolerance setting
Input/output	RS Link connectors: 1 each for IN, OUT
Error message	Overspeed, gage error etc.
Power supply	Terminal block (M3 screw), 12 - 24V DC, 200mA
Operating temperature (humidity) range	0 to 40°C (RH 20 to 80%, no condensation)
Storage temperature(humidity) range	-10 to 50°C (RH 20 to 80%, no condensation)
External dimensions	96(W)×48(H)×84.6(D)mm

## DIMENSIONS

Unit: mm

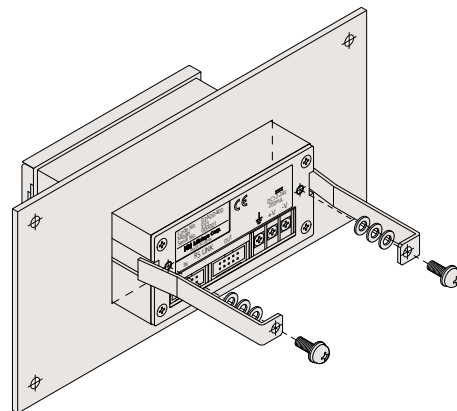
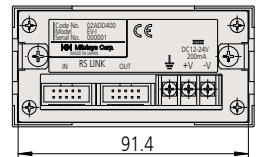
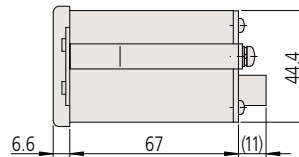
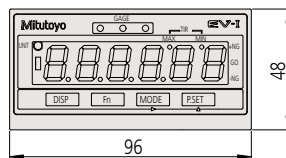

# Sensorpak Software

## Dynamically Displays Positions, Tolerances and Calculations, and Acquires Basic Data from EH, EV Counters and Litematics

- This software facilitates loading measurement data onto a personal computer from a linear gage counter with RS-232C output (EH, EV), with USB output (EH), or from a Litematic display (VL).
- 60 channels (max.) of measurement data can be processed.
- Arithmetical calculations and maximum width calculations can be performed using the measurement data.
- Exporting measurement data into MS-Excel format is supported.
- Real-time graphical display by means of bar-graph or meter is provided.
- Any gage that can be connected to an EH or EV counter can be used in Sensorpak.

**MiCAT**

Mitutoyo Intelligent Computer Aided Technology

the standard in world metrology software

**SENSOR**

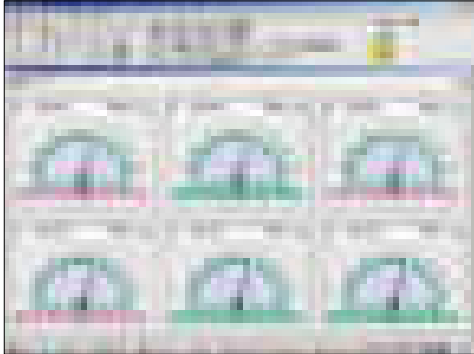

Meter screen

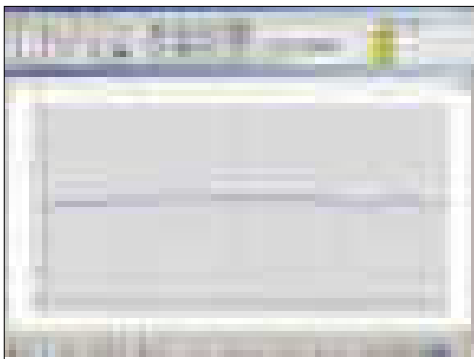
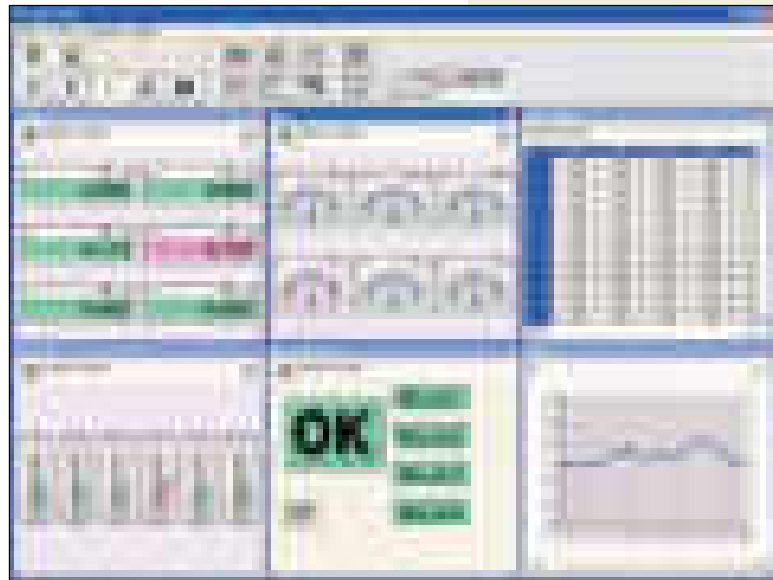

Chart screen



Measurement screen

## SPECIFICATIONS

Order No.	<b>02NGB073</b> (Software v 3.0 plus I/O cable)
Display function	Display type: Counter, bar graph, meter, chart (capable of simultaneous display) Tolerance judgment result: Color display (green/red) Connectable gages: max. 60 gages
Calculation functions	Calculation items: Sum, difference, total, average, maximum, minimum, range (maximum–minimum), calculation with a constant Connectable gages: Max. 30 calculation functions (between two gages)
Total tolerance judgment	Go/No-go judgment (by specifying gages to be used for total tolerance judgment) Go/No-go signal output with optional I/O cable
Input function	Trigger function: by means of key, timer or external TRG (with optional I/O cable) Data input frequency: Max. 9999 times (with 60 gages connected) to 60000 times (with 6 gages connected)
Output function	Direct output to EXCEL spreadsheet, CSV file output (compatible with MeasurLink)
Connectable items	EF, EH, EV, Litematic (RS Link ready products)
System requirements	CPU: DOS/V PC (w/ RS-232C) 2GHz or more OS: Windows 7(32/64 bit), Windows 8.1(32/64 bit), windows 10(64bit) Memory: 2GB or more USB Com: USB 2.0 Display: 1024 x 786 or more Excel: 2007, 2010, 2013

Currently supported languages: English, German, French, Spanish  
User's manual: English

### Optional Accessory

- 21HZA137:** Connecting Cable
- Counter connection (9pin D-SUB)
  - PC connection (9-pin D-SUB)
  - PLC connection (5-pin DIN)

## Optional Stand for VL-50S-B

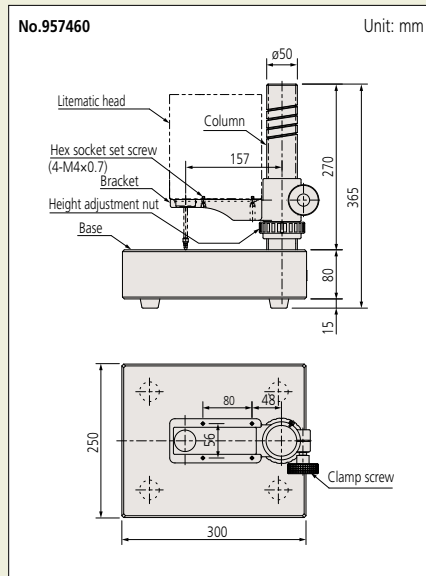

## Optional Accessories

- Foot switch: **No.937179T**
- Dedicated stand: **No.957460**\*4
- SPC cable (1m): **No.936937**\*5
- SPC cable (2m): **No.965014**\*5
- Weight set: **No.02AZE375**\*6
- Recommended contact point:

Shell type

Carbide-tipped spherical contact point,  $\phi 7.5$

Carbide-tipped spherical contact point,  $\phi 10.5$

Carbide-tipped needle contact point,  $\phi 0.45$

\*4: Only available for **VL-50S** models

\*5: Refer to page G-32 for details of the RS link.

\*6: Not applicable to **VL-50-100-B**, **VL-50S-100-B**.

## Measurement Examples



Glass dimensional measurement

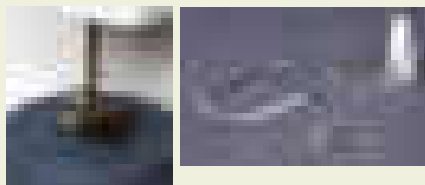

Thin sheet metal thickness



Thickness measurement of non-metallic sheet

## Laser Beam Safety Precautions

This system uses a low-power invisible laser beam (780nm) which corresponds to a CLASS 1 (invisible radiation) of IEC60825-1 for measurement. The CLASS 1 laser warning label as shown below is attached to the main unit.

**CLASS 1 LASER PRODUCT**

# Litematic – Low-Force Measurement

## Series 318 — Low Force, High-resolution, Motorized Measurement of Easily-deformed Parts

- The Litematic is designed for measuring easily deformed workpieces and high-precision parts, with extra-low measuring force of 0.01N.
- 0.15N and 1N types are capable of measuring at a certain measuring force by using a Litematic feature, while the 0.01N type is suitable for measuring delicate workpieces.
- \*0.15N, 1N types are factory-installed option.
- The motor-driven spindle moves up/down and stops when the contact point touches the workpiece. Then the maximum, minimum values and runout value are measured under a constant force.
- High resolution of 0.01 $\mu$ m, and wide measuring range of 50mm.
- Measuring system VL-50-B, integrated display type, and VL-50S-B, a separate display type, are available.
- The measuring table supplied with VL-50-B is ceramic and corrosion-free for easier maintenance and storage.
- The spindle is made of low thermal-expansion material.



318-221A



318-226A

## SPECIFICATIONS

Order No.	318-221A	318-222A	318-223A	318-226A	318-227A	318-228A
Model	VL-50-B	VL-50-15-B	VL-50-100-B	VL-50S-B	VL-50S-15-B	VL-50S-100-B
Measuring range	0 to 50mm (0-2")					
Resolution	0.01/0.1/1.0 $\mu$ m (.000005"/.000005"/.00005")					
Display unit	8 digits/14mm (.6") character height (without signs)					
Detection method	Reflection-type linear encoder					
Stroke	51.5mm (.2") (when using a standard contact point)					
Indication accuracy (20°C)*1	(0.5+L/100) $\mu$ m L=arbitrary measuring length (mm)					
Accuracy guaranteed temperature*2	20 $\pm$ 1°C					
Repeatability*1	$\sigma$ =0.05 $\mu$ m					
Measuring force*1	0.01	0.15N*3	1N*3	0.01N	0.15N*3	1N*3
Feed speed	Approx. 2mm/s (.08"/s) or 4mm/s (.16"/s) (changeable by parameter)					
Fast feed	Approx. 8mm/s (.3"/s)					
Standard contact point	$\phi$ 3mm carbide tipped (fixing screw: M2.5 (P=0.45) $\times$ 5) <b>No.901312</b>					
Measuring table	$\phi$ 100 (ceramic, grooved, removable)					
Input	Foot switch input (when optional foot switch is used) External control					
Output	Digimatic output/RS-232C output (changeable by parameter)					
Rating Power supply	85 - 264V AC (depends on AC adapter)					
Power consumption	Max. 12 W (12V, 1A)					
Standard accessories	AC adapter: <b>No.357651</b> , Power cable/grounding wire: <b>No.02ZAA000</b> , AC cable (USA): <b>No.02ZAA010</b> * Hex wrench (2 pcs, for fixing contact point and for removing fixing bracket)					

\*1: Normal measurement using standard contact point.

\*2: Or less temperature change. Hot or cold direct air flow should be avoided.

\*3: 0.15N, 1N types are factory-installed option.

## DIMENSIONS

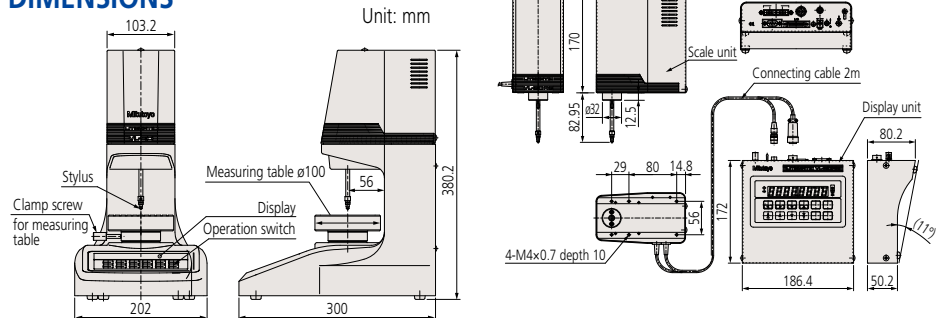

# Quick Guide to Precision Measuring Instruments

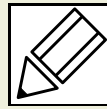

## Linear Gages

### Head

#### Plain Stem and Stem with Clamp Nut

The stem used to mount a linear gage head is classified as a plain type or clamp nut type as illustrated below. The clamp nut stem allows fast and secure clamping of the linear gage head. The plain stem has the advantage of wider application and slight positional adjustment in the axial direction on final installation, although it does require a split-fixture clamping arrangement or adhesive fixing. However, take care so as not to exert excessive force on the stem.

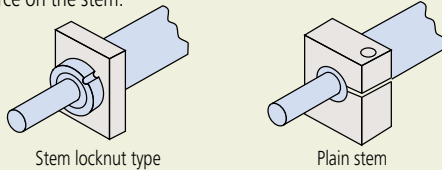

#### Measuring Force

This is the force exerted on a workpiece during measurement by the contact point of a linear gage head, at its stroke end, expressed in newtons.

#### Comparative Measurement

A measurement method where a workpiece dimension is found by measuring the difference in size between the workpiece and a master gage representing the nominal workpiece dimension.

#### Ingress Protection Code

IP54 protection code

Type	Level	Description
Protects the human body and protects against foreign objects	5: Dust protected	Protection against harmful dust
Protects against exposure to water	4: Splash-proof type	Water splashing against the enclosure from any direction shall have no harmful effect.

IP66 protection code

Type	Level	Description
Protection against contact with the human body and foreign objects	6: Dust tight	Protection from dust ingress Complete protection against contact
Protects against exposure to water	6: Water-resistant type	Water jets directed against the enclosure from any direction shall have no harmful effect.

#### Precautions in Mounting a Gage Head

- Insert the stem of the gage into the mounting clamp of a measuring unit or a stand and tighten the clamp screw.
- Notice that excessively tightening the stem can cause problems with spindle operation.
- Never use a mounting method in which the stem is clamped by direct contact with a screw.
- Never mount a linear gage by any part other than the stem.
- Mount the gage head so that it is in line with the intended direction of measurement. Mounting the head at an angle to this direction will cause an error in measurement.
- Exercise care so as not to exert a force on the gage through the cable.

#### Precautions in Mounting a Laser Hologage

To fix the Laser Hologage, insert the stem into the dedicated stand or fixture.

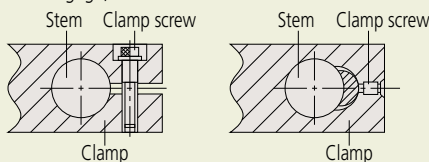

Recommended hole diameter on the fixing side: 15mm +0.034/-0.014

- Machine the clamping hole so that its axis is parallel with the measuring direction. Mounting the gage at an angle will cause a measuring error.
- When fixing the Laser Hologage, do not clamp the stem too tightly. Over-tightening the stem may impair the sliding ability of the spindle.
- If measurement is performed while moving the Laser Hologage, mount it so that the cable will not be strained and no undue force will be exerted on the gage head.

### Display Unit

#### Zero-setting

A display value can be set to 0 (zero) at any position of the spindle.

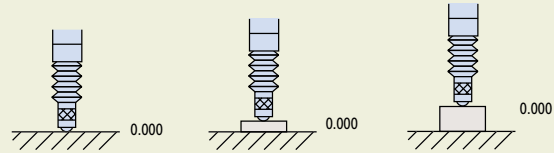

#### Presetting

Any numeric value can be set on the display unit for starting the count from this value.

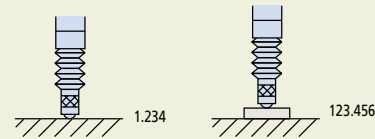

#### Direction Changeover

The measuring direction of the gage spindle can be set to either plus (+) or minus (-) of count.

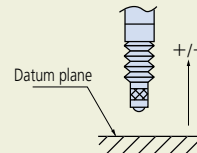

#### MAX, MIN, TIR Settings

The display unit can hold the maximum (MAX) and minimum (MIN) values, and MAX - MIN value during measurement.

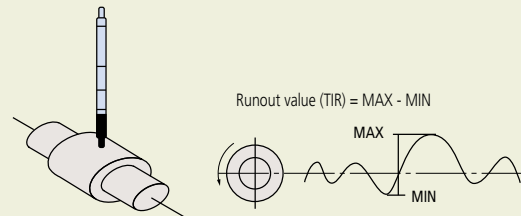

#### Tolerance Setting

Tolerance limits can be set in various display units for automatically indicating if a measurement falls within those limits.

#### Open Collector Output

An external load, such as a relay or a logic circuit, can be driven from the collector output of an internal transistor which is itself controlled by a tolerance judgement result, etc.

#### Relay output

Contact signal that outputs the open/closed status.

#### Digimatic Code

A communication protocol for connecting the output of measuring tools with various Mitutoyo data processing units. This allows output connection to a Digimatic Mini Processor DP-1VR for performing various statistical calculations and creating histograms, etc.

#### BCD Output

A system for outputting data in binary-coded decimal notation.

#### RS-232C Output

A serial communication interface in which data can be transmitted bi-directionally under the EIA Standards. For the transmission procedure, refer to the specifications of each measuring instrument.

**RS Link Function** Multi-point measurement can be performed by connecting multiple EH or EV counters with RS Link cables.

**■ RS Link for EH Counter**

It is possible to connect a maximum of 10 counter units and handle up to 20 channels of multi-point measurement at a time. For this connection use a dedicated RS Link cable **No.02ADD950** (0.5m), **No.936937** (1m) or **No.965014** (2m). (The total length of RS Link cables permitted for the entire system is up to 10m.)

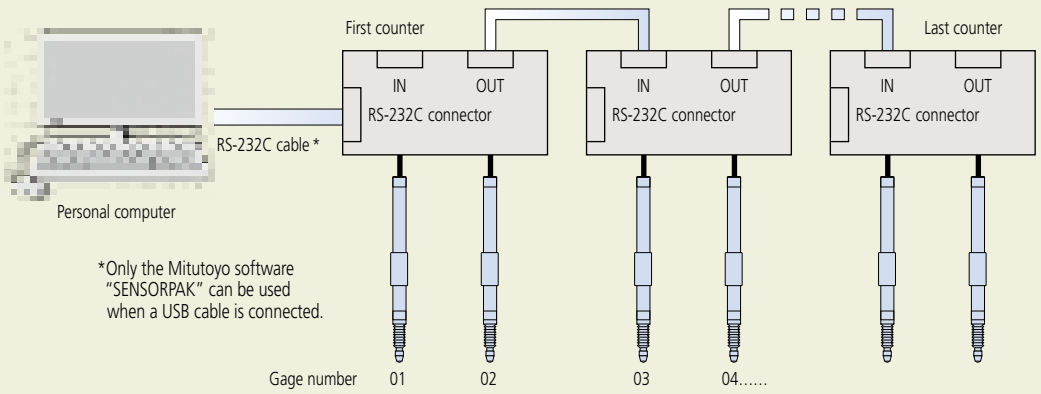

**■ RS Link for EV Counter**

It is possible to connect a maximum of 10\* counter units and handle up to 60 channels of multi-point measurement at a time. For this connection use a dedicated RS Link cable **No.02ADD950** (0.5m), **No.936937** (1m) or **No.965014** (2m). (The total length of RS Link cables permitted for the entire system is up to 10m.)

\* The maximum number of counter units that can be connected is limited to 6 (six) if an EH counter is included in the chain.

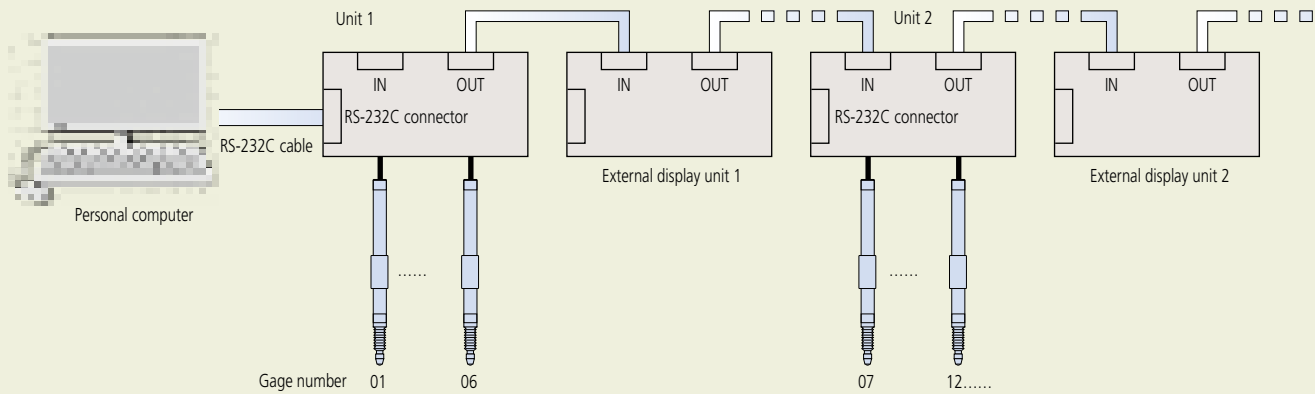

# Mu-checker Probes

## SERIES 519 Mu-checker Probes (Lever head)

### SPECIFICATIONS

#### Lever heads

Order No.	519-521	519-522	519-326*	519-327
Measuring range (mm)	±0.5			
Stroke (mm)	±0.6			±0.65
Measuring force (N)	Approx. 0.2	Approx. 0.02	Approx. 0.15	
Linearity (%)	±0.3			±0.5
Stylus support	Pivot bearing	Pivot bearing	Parallel-leaf spring	Pivot bearing

Note: A  $\varnothing 2\text{mm}$  ball-ended stylus is supplied as standard with all probes.

\* This model is immune to cosine error.

#### 519-521

- Interchangeable styli:  
 $\varnothing 1$ : 520940 (Standard)  
 $\varnothing 2$ : 520939 (Standard)  
 $\varnothing 3$ : 520938 (Standard)

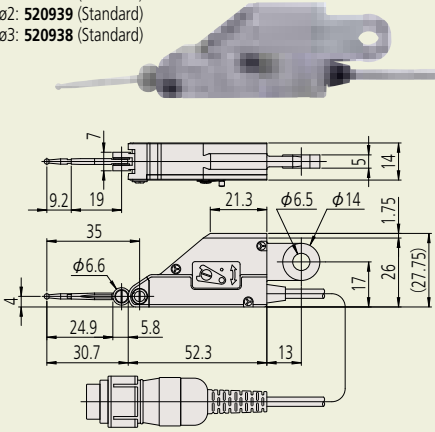

#### 519-522

- Interchangeable styli:  
 $\varnothing 1$ : 520940 (Standard)  
 $\varnothing 2$ : 520939 (Standard)  
 $\varnothing 3$ : 520938 (Standard)

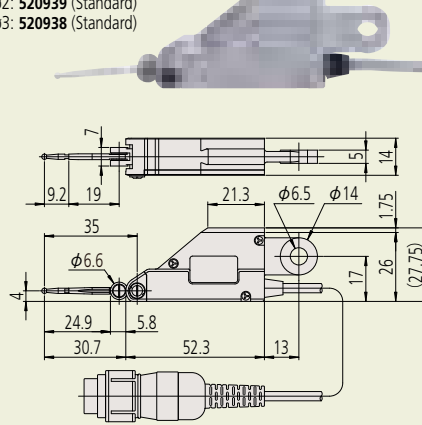

#### 519-326

- Interchangeable styli:  
 $\varnothing 1$ : 102824 (Option)  
 $\varnothing 2$ : 102825 (Standard)  
 $\varnothing 3$ : 102826 (Option)

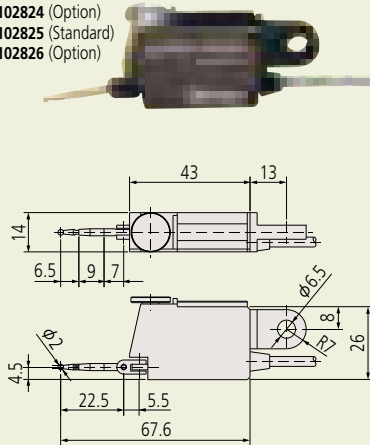

#### 519-327

- Interchangeable styli:  
 $\varnothing 1$ : 102824 (Option)  
 $\varnothing 2$ : 102825 (Standard)  
 $\varnothing 3$ : 102826 (Option)

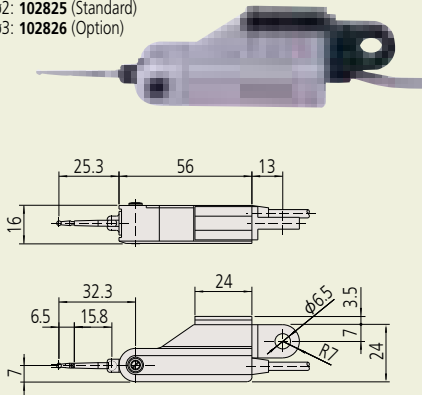

### Common specifications

- Connection: Half-bridge
- Cable length: 2m
- Connector type: MAS-5100 (DIN5P) or equivalent

### ■ Lever probes

Lever probes are available in two types. The most common type uses a pivoted stylus so the contact point moves in a circular arc; this type is subject to cosine effect and, therefore, measurements may require linearity correction if the direction of measurement is much different to the direction of movement of the contact point. The less common type uses a parallel translation leaf-spring mechanism so contact point movement is linear; this type requires no correction.

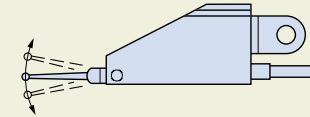

#### Pivoted stylus type

**519-521** (measuring direction can be switched with the up/down lever)

**519-522** (measuring direction is not switchable, low force)

**519-327** (Clutchless)

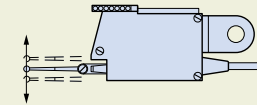

#### Parallel translation type

**519-326** (measuring direction can be switched with the upper dial)

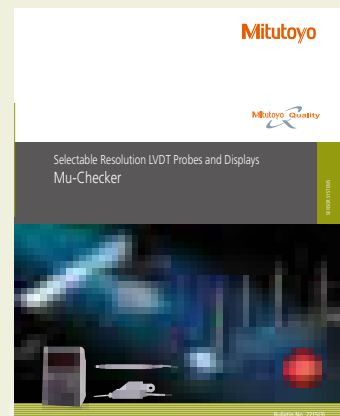

Refer to Bulletin No. (2215) for more details.



## Lever-head mounting brackets (optional)

Optional accessories for Mitutoyo test indicators can be used.

### Stems

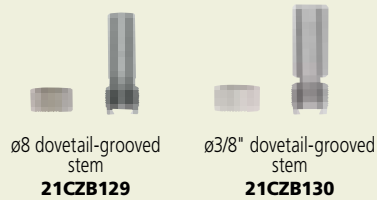
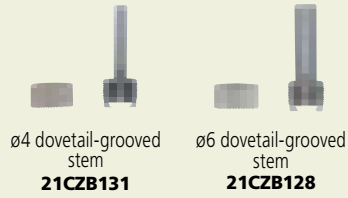

### Clamp

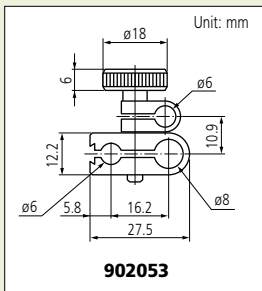

### Holder

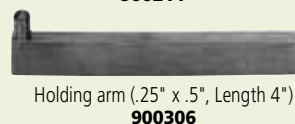
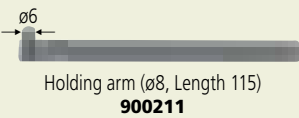
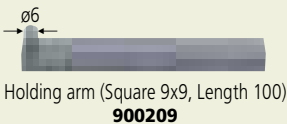

## SERIES 519 Mu-checker Probes (Cartridge head)

### SPECIFICATIONS

#### Cartridge heads

Order No.	519-331	519-332	519-346	519-347	519-385	519-341	519-348
Measuring range (mm)	±0.5	±0.5	±0.25	±0.5	±1.5	±2.5	±1.0
Stroke (mm)	±0.65	±0.65	+0.34 -0.26	+0.85 -0.65	+2.35 -1.65	+3.2 -2.8	+1.35 -1.15
Measuring force (N)	Approx. 0.25	Approx. 0.25	Approx. 0.7	Approx. 0.7	Approx. 0.7	Approx. 0.9	Approx. 0.7
Stem Dia. (mm)	ø8	ø3/8"	ø8	ø8	ø8	ø8	ø8
Linearity (%)	±0.5	±0.5	±0.3	±0.3	±0.3	±0.5	±0.3
Plunger support	Plain bearing			Linear ball-bearing			

519-331/(519-332)

- M2.5x5 (4-48 UNF) interchangeable contact points for dial indicators can be used.

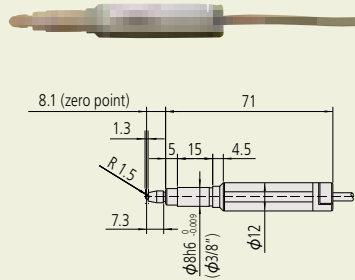

519-346

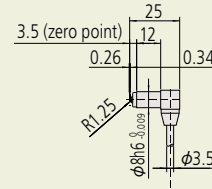

519-347

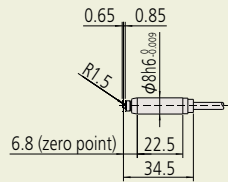

519-385

- M2.5x5 interchangeable contact points for dial indicators can be used.

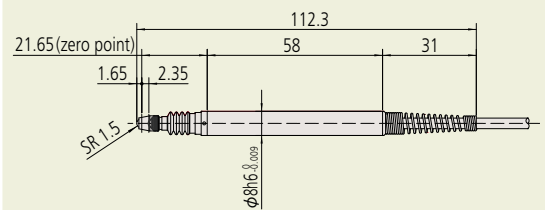

519-341

- M2.5x5 interchangeable contact points for dial indicators can be used.

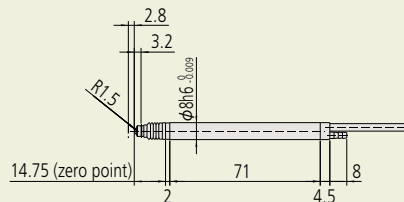

519-348

- M2.5x5 interchangeable contact points for dial indicators can be used.

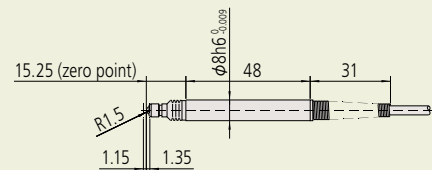

# Mu-checker

## SERIES 519 Mu-checker (Analog/Digital electronic micrometer)

- Single touch zero-set function is standard.
- Switchable measurement ranges make the Mu-checker suitable for a range of applications.

### Analog Mu-checker



Standard type  
519-552A

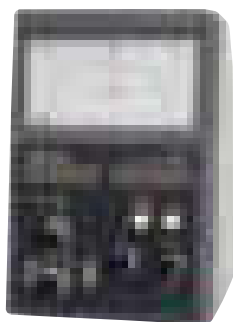

Differential type  
519-554A

### SPECIFICATIONS

Order No.	519-552A	519-554A
Type	Standard type (one probe required)	Differential type (one/two probes required)
Display range	$\pm 5\mu\text{m}/\pm 15\mu\text{m}/\pm 50\mu\text{m}/\pm 150\mu\text{m}/\pm 500\mu\text{m}/\pm 1500\mu\text{m}$ $\pm 0.0015"/\pm 0.0005"/\pm 0.015"/\pm 0.05"/\pm 0.15"/\pm 0.5"$	
Resolution	0.1 $\mu\text{m}/0.5\mu\text{m}/1\mu\text{m}/5\mu\text{m}/10\mu\text{m}/50\mu\text{m}$ 0.000005"/0.00001"/0.00005"/0.0001"/0.0005"/0.001"	
Differential mode	$\pm A$	$\pm A, \pm B, \pm A \pm B$
Display accuracy (linearity)	$\pm 1\%$ / $\pm$ full scale	
Analog output	$\pm 1\text{V}$ $\pm$ full scale	
Analog output accuracy	$\pm 0.1\%$ Within $\pm$ full scale (excluding probe)	
Zero-setting adjustment range	Manual	Instant zero setting: 1/3 of full scale for each range
External dimensions	134(W) x 183(D) x 208(H) mm	
Mass	2.4kg	
Power input	AC adapter 100, 120, 220, 240VAC 50/60Hz	
Probe	Various probes (refer to page G-33 and G-34)	

### Digital Mu-checker

- Single touch zero-set function is standard.
- Switchable measurement ranges make the Mu-checker suitable for a range of applications.
- Dual input.



Digital Mu-checker  
519-562A

### SPECIFICATIONS

Order No.	519-562A
Type	Differential type digital Mu-Checker (2 connecting heads)
Display range	$\pm 2.000\text{mm}/\pm 0.2000\text{mm}/\pm 0.8"/\pm 0.008"$
Resolution	0.001mm/0.0001mm/0.00005"/0.000005"
Differential mode	$\pm A, \pm B, \pm A \pm B$
Measurement mode	ABS/CMP
Analog output	$\pm 1\text{V}$ $\pm$ Full scale
Digital output	Digimatic code out
External dimension	134(W) x 183(D) x 208(H) mm
Mass	Approx. 2.6kg
Power input	AC adapter 100, 120, 220, 240VAC 50/60Hz
Probe	Various probes (refer to page G-33 and G-34)

### Optional Accessories

- SPC Cable for connecting digital Mu-checker (**936937**)  
Used for connecting to the digimatic mini-processor.
- Output cable A (**934795**)  
Used for connecting to external devices, such as data recorders, etc.

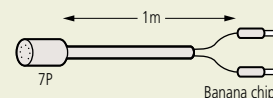

- Analog, limit out (7P) connector (**529035**)  
Used for output to external data recorders, sequencers, etc.

- Foot Switch: **937179T**
  - SPC Cable, 1m: **936937**
  - SPC Cable, 2m: **965014**
- Note: for Digital Mu-Checker only

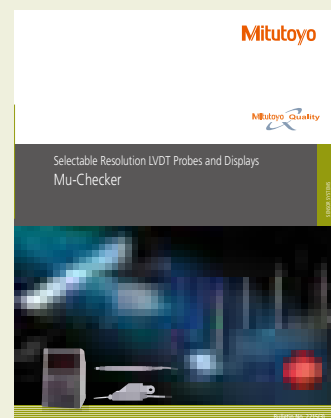

Refer to Bulletin No. (2215) for more details.

## SERIES 519 6CH Mu-checker Counter EV-16A

### Main features

- External control (Zero-set, Preset etc.)
- Direction switching
- Error messaging
- Tolerance judgment output
- Each data output (RS-232C, BCD, segment)
- Peak measurement (maximum value, minimum value, runout) and arithmetic operation (addition, average, maximum value, minimum value, maximum width) between axes

### Optional Accessories

- I/O output connector: **02ADB440**
- D-EV external unit: **02ADD400**
- SPC cable, 0.5m: **02ADD950**
- SPC cable, 1m: **936937**
- SPC cable, 2m: **965014**

- Note 1: To perform calibration a **D-EV (02ADD400)** display unit is required.  
At least one **D-EV (02ADD400)** unit is required when using multiple **EV-16A (519-355)**.
- Note 2: As a power supply is not supplied as standard. An appropriate power supply with a current capacity of 1A or more must be provided for each **EV-16A (519-355)**.

- The EV-16A counter unit provides multi-channel electronic micrometer functionality but without a display of the measurement results, which must be purchased separately. (See below.)
- Up to six probes can be connected to one unit. Up to ten counters can be connected to one personal computer using the RS Link function to enable the configuration of a multi-point measurement system comprising a maximum of 60 gages.
- I/O outputs for RS-232C, BCD, tolerance judgment and segment output are available.
- Maximum, minimum and runout measurement between channels (in the same unit) is possible in addition to normal measurement on individual channels.



### SYSTEM CONFIGURATION

Mitutoyo probes, EV-16A counters and D-EV display units combined with commercial controllers and personal computers enable construction of a powerful, multi-channel system that can be built to meet the needs of almost any measurement application.

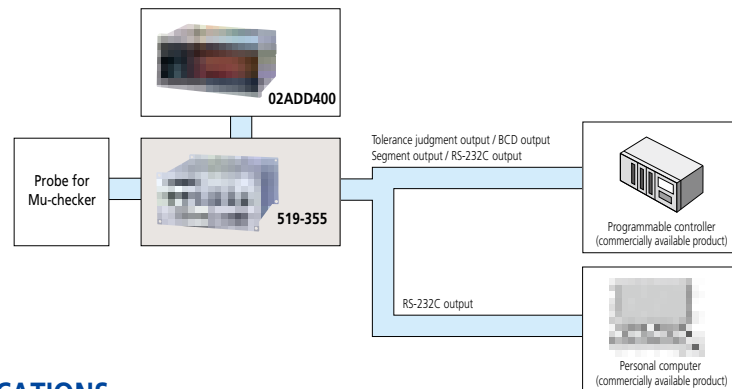

### DIMENSIONS

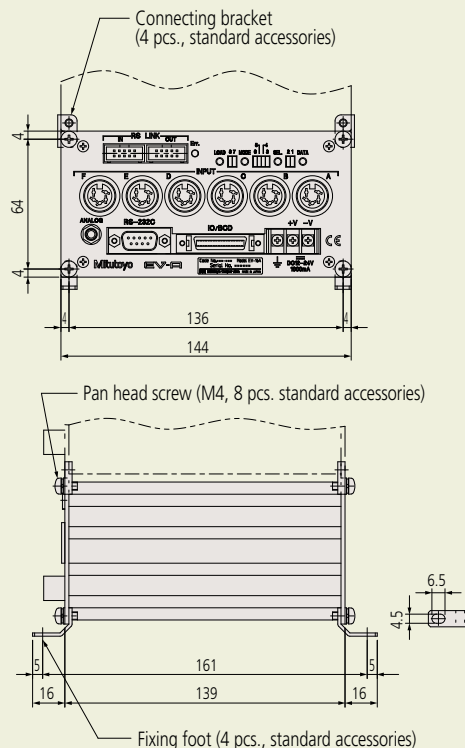

### SPECIFICATIONS

Order No.	519-355	
Number of gage inputs	Six	
Display range (mm)	$\pm 2.000, \pm 0.200$	
Resolution (mm)	0.001, 0.0001	
Display processing	8 digits for parameters (display setting), 1 for error display	
Error messaging	Power supply voltage error, Gage error, etc.	
External display	Dedicated external display unit D-EV (optional) can be connected	
Number of input switches	4	
Input switch function	Measurement mode switching, Parameter settings	
I/O	Tolerance judgment output	1 to 6 gages (L1, L2, L3), open-collector
	BCD output	Parallel BCD output (positive/negative-true logic), open-collector
	Segment output	A function to enable only output from the terminal corresponding to the counting values, open-collector
	Control output	Normal operation signal (NOM), open-collector
	Control input	Output channel designation (segment, in BCD mode), presetting, peak value clear, range changeover (at segment output), holding counting value, open-collector or no-voltage contact signal (with/without contact point)
Interface	RS-232C	Measurement data output and control input, EIA RS-232C-compatible Use cross cables for home position DTE (terminal definition)
	RS link	Max. connected units: 10 (6 when using EF counter) Connecting cable length: Max. 10m (sum of link cable length) Data transfer time: 1.1 sec./60ch (when transmission rate is 19200 bps)
Rating	Power supply voltage	Terminal (M3 screw), 12-24VDC
	Current consumption	1A
Operating temperature (humidity) range	0 to 40 °C (RH 20 to 80%, no condensation)	
Storage temperature (humidity) range	-10 to 50 °C (RH 20 to 80%, no condensation)	
External dimensions	144(W) × 72(H) × 139(D) mm	
Mass	Approx. 1000 g	
Standard accessories	Fixing foot (4), connecting bracket (4), fixing screw M4 × 8 (8)	
Applicable probes	For probes, refer to 519 series Mu-checker probes	

# Laser Scan Micrometer Selection Guide

## MEASURING UNITS

Appearance	Model	Laser Classification	Measuring Range	Resolution (Selectable)
	LSM-6902H*	Visible (650nm), IEC Class 2/ FDA Class II	0.1 - 25mm (.004" - 1.0")	0.01µm - 10µm (.000001" - .0005")
	LSM-500S	Visible (650nm), IEC Class 2/ FDA Class II	0.005 - 2mm (.0002" - .08")	0.01µm - 10µm (.000001" - .0005")
	LSM-501S	Visible (650nm), IEC Class 2/ FDA Class II	0.05 - 10mm (.002" - .4")	0.01µm - 10µm (.000001" - .0005")
	LSM-503S	Visible (650nm), IEC Class 2/ FDA Class II	0.3 - 30mm (.012" - 1.18")	0.02µm - 100µm (.000001" - .005")
	LSM-506S	Visible (650nm), IEC Class 2/ FDA Class II	1 - 60mm (.04" - 2.36")	0.05µm - 100µm (.000002" - .005")
	LSM-512S	Visible (650nm), IEC Class 2/ FDA Class II	1 - 120mm (.04" - 4.72")	0.1µm - 100µm (.000005" - .005")
	LSM-516S	Visible (650nm), IEC Class 2/ FDA Class II	1 - 160mm (.04" - 6.30")	0.1µm - 100µm (.000005" - .005")
 With display unit	LSM-9506 Measuring unit - display unit one-piece structure for bench- top use only	Visible (650nm), IEC Class 2/ FDA Class II	0.5 - 60mm (.02" - 2.36")	0.05µm - 100µm (.000002" - .005")

## DISPLAY UNITS

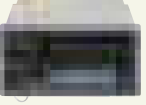
Appearance	Model	Type	Application	Interface Units Equipped
	LSM-6200 LSM-6902H*	Multi-function type	Bench-top use	<ul style="list-style-type: none"> <li>• RS-232C</li> <li>• I/O</li> <li>• Analog output</li> </ul>
	LSM-5200**	Compact type (Low cost)	Assembly/ bench-top use (DIN size)	<ul style="list-style-type: none"> <li>• RS-232C</li> <li>• I/O</li> <li>• Analog output</li> <li>• USB***</li> </ul>

\*LSM-902 and LSM-6902H are factory-set package.

\*\*When connecting with the LSM-500S series, the scanning speed becomes 1600 scans/sec.

\*\*\*USB connectivity for use with Quicktool and LSM Pak.

## ■ Measurement Examples

In-line measurement of glass fiber or fine wire diameter

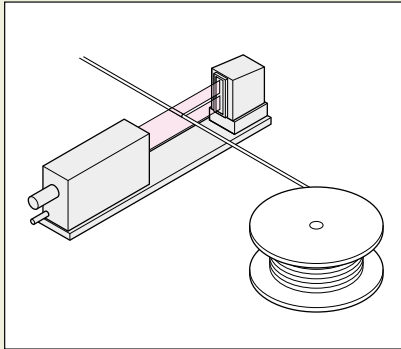

Measurement of outer diameter of cylinder

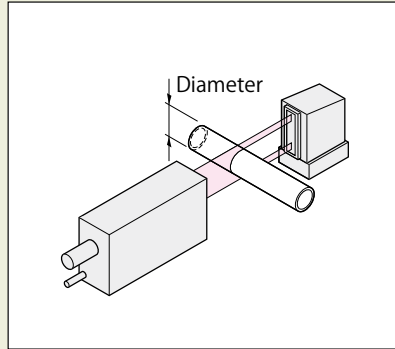

Measurement of outer diameter and roundness of cylinder

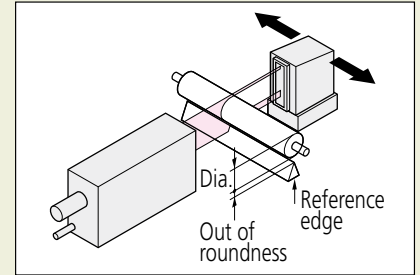

X- and Y-axis measurement of electric cables and fibers

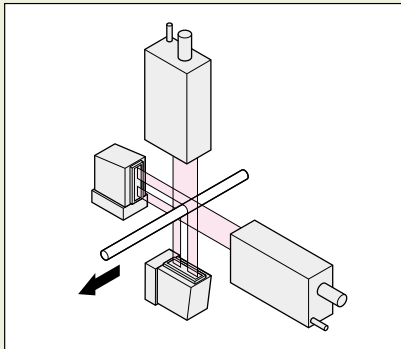

Measurement of thickness of film and sheet

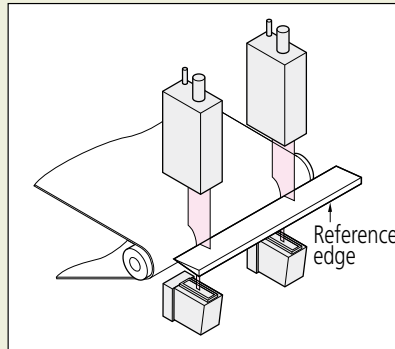

Measurement of spacing of IC chip leads

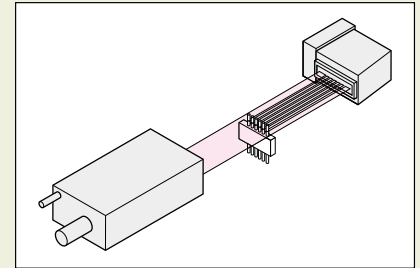

Measurement of film sheet thickness

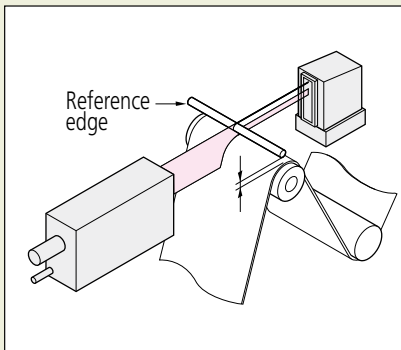

Measurement of laser disk and magnetic disk head movement

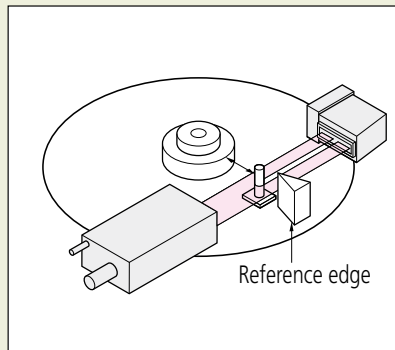

Measurement of gap between rollers

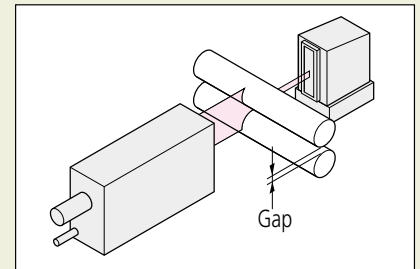

Measurement of tape width

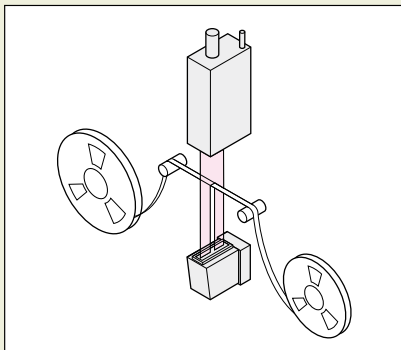

Measurement of outer diameter of optical connector and ferrule

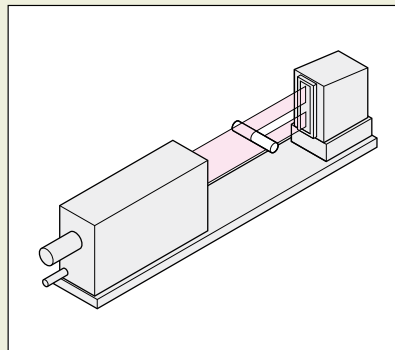

Measurement of form

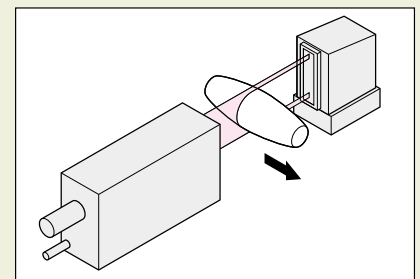

Dual system for measuring a large outside diameter

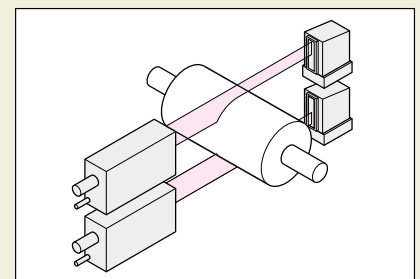

# Laser Scan Micrometer LSM-6902H

## SERIES 544 — Ultra-high Accuracy Non-contact Measuring System

- Non-contact laser-based measuring system, mainly for outside diameter measurement. Suitable for delicate or moving workpieces.
- Accuracy of  $\pm 0.5\mu\text{m}$  in the  $\varnothing 0.1 - \varnothing 25\text{mm}$  range can be achieved. It is suitable for pin gage measurement.
- Narrow range accuracy of  $\pm(0.3+0.1\Delta D)\mu\text{m}$  for high-precision measurement.
- Ultra-high repeatability of  $\pm 0.05\mu\text{m}$ .
- The system consists of a measuring unit and a display unit.



### SPECIFICATIONS

Set Order No.	544-499A	
Measuring unit		
Type	inch/mm	
Measuring range	0.1 to 25mm (.004 - 1.0")	
Resolution	0.01 to 10 $\mu\text{m}$ (selectable) (.00001 - .0005")	
Repeatability*1	Whole range	$\pm 0.045\mu\text{m}$ ( $\pm 0.0000018$ in) ( $\varnothing 25\text{mm}$ )
	Narrow range	$\pm 0.03\mu\text{m}$ ( $\pm 0.0000012$ in) ( $\varnothing 10\text{mm}$ )
Accuracy*2 (20°C)	Whole range	$\pm 0.5\mu\text{m}$ ( $\pm 0.000020$ ")
	Small range	$\pm(0.3+0.1\Delta D)$ [D:mm]*5 $\pm(.000012+.001\Delta D)$ [D:inch]
Positional error*3	$\pm 0.5\mu\text{m}$ ( $\pm 0.000020$ ")	
Measuring area*4	$\pm 1.5 \times 25\text{mm}$ ( $\pm 0.6 \times 1.0$ ")	
Scanning rate	800 scans/s	
Laser wavelength	650nm (Visible)	
Laser scanning speed	56m/s (2240"/sec)	
Operating environment	Temperature	0 to 40°C
	Humidity	RH 35 to 85% (no condensation)

Display unit	
Display	16-digit plus 11-digit fluorescent display, and guide message LED
Segment	1 to 7 (1 to 3, transparent) or 1 to 255 edges
Averaging times	Arithmetic average: per 1 to 2048/ Moving average: per 32 to 2048
Judgment	Selection from target value + tolerance, lower tolerance + upper tolerance, or 7 classes multi-limit tolerance zone.
Measurement mode	Standby, Single measurement, Continuous measurement
Statistical analysis	Maximum, Minimum, Average, Dispersion, $\sigma$ (S.D)
External dimensions	335 (W) $\times$ 134 (H) $\times$ 250 (D)mm
Power supply	120 V AC $\pm 10\%$ , 50W, 60Hz
Standard I/F	RS-232C, Analog I/O
Optional I/F	Digimatic code output unit (2-ch), 2nd I/O analog I/F, BCD I/F
Operating environment	0 to 40°C, RH 35 to 85% (no condensation)
Others	Nominal setting, sample setting, selection of unnecessary digits, transparent object measurement, automatic measurement in edge mode, output timer, abnormal data elimination, SHL change, group judgment, simultaneous measurement, statistical processing, mastering, buzzer function, automatic workpiece detection (dimension/position), zero-set/offset * Measuring unit dual connection, extra-fine line measurement, and some of the communication commands are not available.

- \*1: Determined by the value of  $\pm 2\sigma$  ( $\sigma$ : standard deviation) when measuring  $\varnothing 25\text{mm}$  at the interval of 1.28 sec. (average 1024 times).
- \*2: At the center of the measuring range.
- \*3: An error due to variation in workpiece position either in the optical axis direction or in the scanning direction.
- \*4: The area given by [optical axis direction] $\times$ [scanning direction]
- \*5:  $\Delta D$ =Difference in diameter between the master gage and workpiece (Unit: mm)

### Measuring Unit External Dimensions

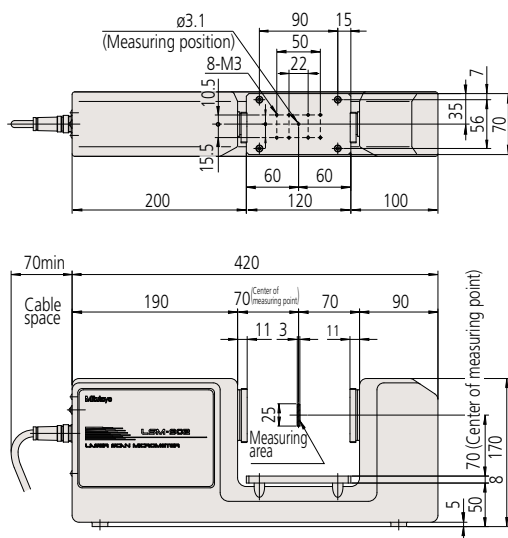

Unit: mm

### Optional Accessories

- (Refer to page G-46 for details.)
- Calibration gage set ( $\varnothing 1.0, \varnothing 25.0$ )

	: No.02AGD180
• Workstage	: No.02AGD270
• Adjustable workstage	: No.02AGD280
• Digimatic code output unit (2-ch)	: No.02AGC840
• 2nd I/O analog interface unit	: No.02AGC880
• BCD interface unit	: No.02AGC910
• Printer & cable set (120V AC C-type plug)	: No.02AGD600B
• Printing paper TP411-28CL / 1Pack = 10pcs	: No.223663
• Foot switch	: No.937179T

### QUICKTOOL

QUICKTOOL is a free downloadable software program that makes programming the LSM-6200 quick and easy. Basic data acquisition is also possible. (Connecting cables to PC are optional)

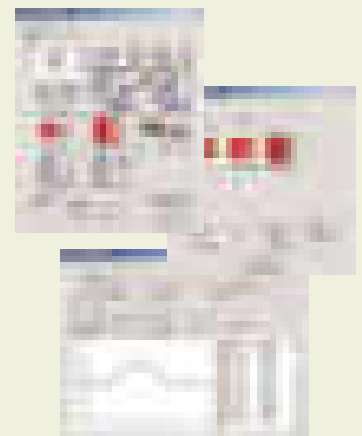

### Laser safety

Mitutoyo Laser Scan Micrometers use a low-power visible laser for measurement. The laser is a CLASS 2 EN/IEC60825-1 (2007) device. Warning and explanation labels, as shown below, are attached to the Laser Scan Micrometers as is appropriate.



# Laser Scan Micrometer LSM-500S

## SERIES 544 — High Accuracy Non-contact Measuring System

### Optional Accessories

- Multifunctional display unit, **LSM-6200\***:

Order No.	Display type	Remarks
<b>544-072A</b>	English mm/inch	English user's manual

\* Included in packages

- Easy-to-operate display unit, **LSM-5200**:

Order No.	Remarks
<b>544-047*</b>	English user's manual

\* AC adapter not included

- Calibration gage set (ø0.1, ø2.0) : **No.02AGD110**
- Guide pulley : **No.02AGD200**
- Air blower/purge : **No.02AGD200**
- Extension signal cables: : **No.02AGD220**

Order No.	Cable length
<b>02AGN780A</b>	5m
<b>02AGN780B</b>	10m
<b>02AGN780C</b>	15m

### QUICKTOOL

QUICKTOOL is a free downloadable software program that makes programming the LSM-6200 quick and easy. Basic data acquisition is also possible. (Connecting cables to PC are optional)

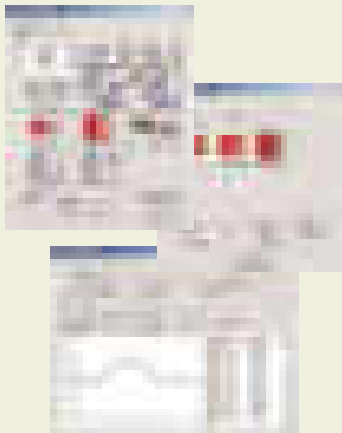

- Capable of measuring down to 5µm outside diameter\*1.
- Provides ultra-high accuracy of ±0.3µm over the entire measuring range (5µm to 2mm).
- Ultra-high speed measurement of 3200 scan/sec. Suitable for high-speed lines or in applications subject to vibration.



### SPECIFICATIONS

Order No. (Laser only)		<b>544-532</b>
Package No. (with LSM 6200 Display)		<b>64PKA117</b>
Applicable laser standards		IEC, FDA
User's manual		English version
Measuring range		.0002" to .080" (0.005 to 2mm)*1
Resolution		.00001" to .0005" (0.01 to 10µm) (selectable)
Repeatability*2		±0.03µm
Accuracy (20°C)*3		±0.3µm
Positional error*4		±0.4µm
Measuring area*5		1×2mm (0.005 to 2mm)
Scanning rate		3200 scans/s
Laser wavelength		650nm (Visible)
Laser scanning speed		76m/s
Operating environment	Temperature	0 to 40°C
	Humidity	RH 35 to 85% (no condensation)
Protection Level		IP64*6

\*1: The measuring range for the transparent object will be 0.05mm to 2mm. Please consult your local Mitutoyo office for objects smaller than 0.05mm.

The measuring range will be 0.1mm to 2mm in the 1 to 255 edge measurement mode or when activating the automatic workpiece detection.

If using the optional dual-connection unit for LSM-6200, the measuring range will be 0.05mm to 2mm.

\*2: Determined by the value of ±2σ (σ: standard deviation) when measuring ø2mm at the interval of 0.32 sec. (average 1024 times).

\*3: Center of the measuring range for cylindrical workpieces outside diameter.

\*4: An error of the outside diameter due to variation in workpiece position either in the optical axis direction or in the scanning direction.

\*5: The area given by [optical axis direction]x[scanning direction].

\*6: If the workpiece or glass of the measuring unit window is soiled by water or dust, the unit may malfunction.

Note: When using extra-fine line measurement function (FINE), guide messages for setting the following will not be displayed: dual-measurement, segment designation, automatic workpiece detection and group judgment.

### DIMENSIONS

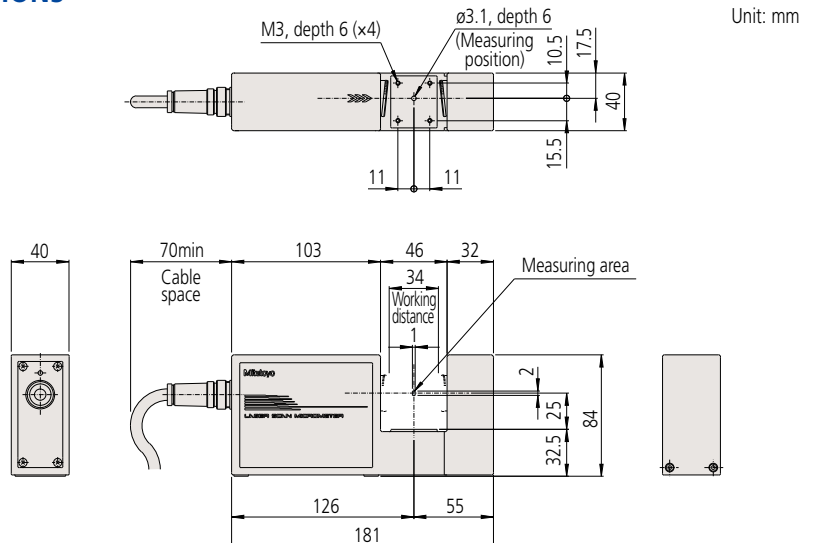

### Laser safety

Mitutoyo Laser Scan Micrometers use a low-power visible laser for measurement. The laser is a CLASS 2 EN/IEC60825-1 (2007) device. Warning and explanation labels, as shown below, are attached to the Laser Scan Micrometers as is appropriate.



# Laser Scan Micrometer LSM-501S

## SERIES 544 — High-accuracy Non-contact Measuring System

- Provides ultra-high accuracy of  $\pm 0.5\mu\text{m}$  over the entire measuring range (0.05 to 10mm).
  - Narrow range accuracy of  $\pm(0.3+0.1\Delta D)\mu\text{m}$  for high-precision measurement.
  - Ultra-high speed measurement of 3200 scan/sec.
- Suitable for high-speed lines or in applications subject to vibration.



### SPECIFICATIONS

Order No. (Laser only)	<b>544-534</b>	
Package No. (Laser w/LSM 6200 display)	<b>64PKA118</b>	
Applicable laser standards	IEC, FDA	
User's manual	English version	
Measuring range	.002" to .4" (0.05 to 10mm)	
Resolution	.00001" to .0005" (0.01 to 10 $\mu\text{m}$ ) (selectable)	
Repeatability*1	$\pm 0.04\mu\text{m}$	
Accuracy*2 (20°C)	Whole range	$\pm 0.5\mu\text{m}$
	Small range	$\pm(0.3+0.1\Delta D)\mu\text{m}^{*3}$
Positional error*4	$\pm 0.5\mu\text{m}$	
Measuring area*5	2x10mm ( $\phi 0.05$ to $\phi 0.1\text{mm}$ ) 4x10mm ( $\phi 0.1$ to $\phi 10\text{mm}$ )	
Scanning rate	3200 scans/s	
Laser wavelength	650nm (Visible)	
Laser scanning speed	113m/s	
Operating environment	Temperature	0 to 40°C
	Humidity	RH 35 to 85% (no condensation)
Protection Level	IP64*6	

\*1: Determined by the value of  $\pm 2\sigma$  ( $\sigma$ : standard deviation) when measuring  $\phi 10\text{mm}$  at the interval of 0.32 sec. (average 1024 times).

\*2: Center of the measuring range for cylindrical workpieces outside diameter.

\*3:  $\Delta D$ =Difference in diameter between the master gage and workpiece (Unit: mm)

\*4: An error of the outside diameter due to variation in workpiece position either in the optical axis direction or in the scanning direction.

\*5: The area given by [optical axis direction]x[scanning direction].

\*6: The protection level provided for the interior. If the workpiece or glass of the measuring unit window is soiled by water or dust, the unit may malfunction.

### DIMENSIONS

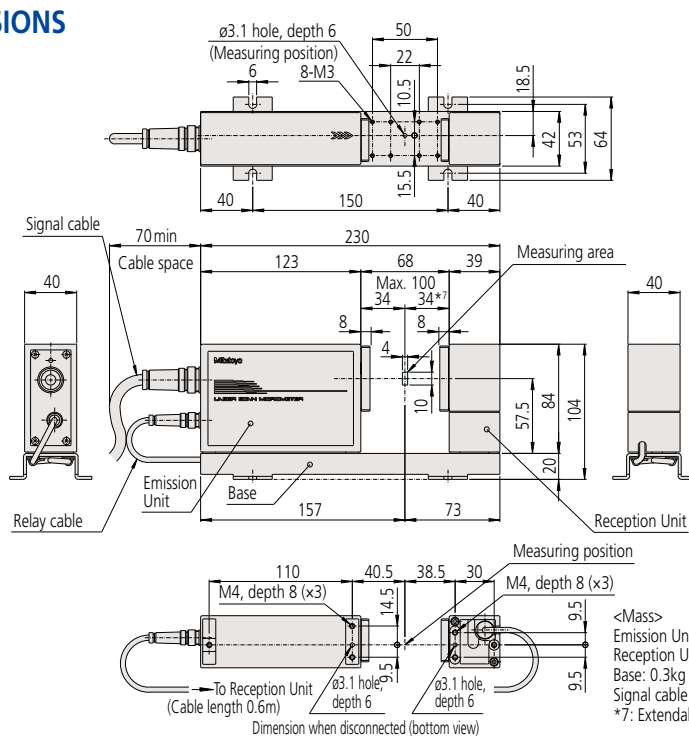

<Mass>  
 Emission Unit: 0.7kg  
 Reception Unit: 0.4kg  
 Base: 0.3kg  
 Signal cable (5m): 0.5kg  
 \*7: Extendable up to 66mm.

### Optional Accessories

- Multifunctional display unit, **LSM-6200\***:

Order No.	Display type	Remarks
<b>544-072A</b>	English mm/inch	English user's manual

\* Included in packages

- Easy-to-operate display unit, **LSM-5200**:

Order No.	Remarks
<b>544-047*</b>	English user's manual

\* AC adapter not included

- Calibration gage set ( $\phi 0.1$ ,  $\phi 10.0$ )

- Wire guiding pulley : **No.02AGD120**
- Adjustable workstage : **No.02AGD210**
- Air blower/purge : **No.02AGD230**
- Workstage : **No.02AGD270**
- Extension signal cables

Order No.	Cable length
<b>02AGN780A</b>	5m
<b>02AGN780B</b>	10m
<b>02AGN780C</b>	15m

- Extension relay cables

Order No.	Cable length
<b>02AGC150A</b>	1m

### QUICKTOOL

QUICKTOOL is a free downloadable software program that makes programming the LSM-6200 quick and easy.

Basic data acquisition is also possible. (Connecting cables to PC are optional)

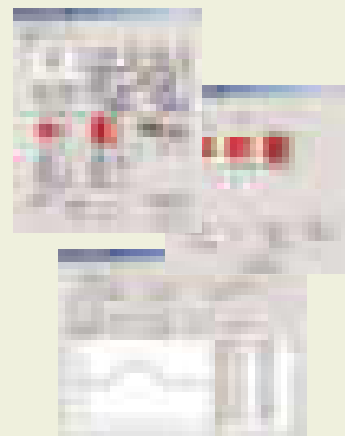

### Laser safety

Mitutoyo Laser Scan Micrometers use a low-power visible laser for measurement. The laser is a CLASS 2 EN/IEC60825-1 (2007) device. Warning and explanation labels, as shown below, are attached to the Laser Scan Micrometers as is appropriate.





# Laser Scan Micrometer LSM-503S

## SERIES 544 — High-accuracy Non-contact Measuring System

### Optional Accessories

- Multifunctional display unit, **LSM-6200\***:

Order No.	Display type	Remarks
<b>544-072A</b>	English mm/inch	English user's manual

\* Included in packages

- Easy-to-operate display unit, **LSM-5200**:

Order No.	Remarks
<b>544-047*</b>	English user's manual

\* AC adapter not included

- Calibration gage set (ø0.1, ø30.0)

: **No.02AGD130**

- Adjustable workstage

: **No.02AGD490**

- Air blower/purge

: **No.02AGD240**

- Workstage

: **No.02AGD270**

- Extension signal cables

Order No.	Cable length
<b>02AGN780A</b>	5m
<b>02AGN780B</b>	10m
<b>02AGN780C</b>	15m
<b>02AGN780D</b>	20m

- Extension relay cables

Order No.	Cable length
<b>02AGC150A</b>	1m
<b>02AGC150B</b>	3m
<b>02AGC150C</b>	5m

### QUICKTOOL

QUICKTOOL is a free downloadable software program that makes programming the LSM-6200 quick and easy.

Basic data acquisition is also possible. (Connecting cables to PC are optional)

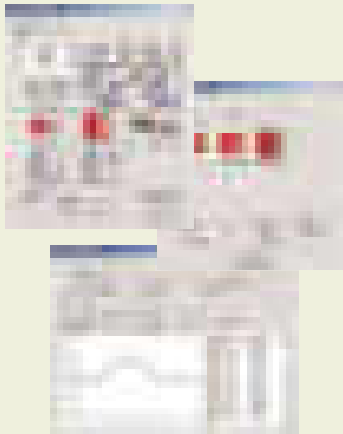

### Laser safety

Mitutoyo Laser Scan Micrometers use a low-power visible laser for measurement. The laser is a CLASS 2 EN/IEC60825-1 (2007) device. Warning and explanation labels, as shown below, are attached to the Laser Scan Micrometers as is appropriate.



- Ensures  $\pm 1.0\mu\text{m}$  accuracy over the entire measuring range (0.3 to 30mm).
- Narrow range accuracy of  $\pm(0.6+0.1\Delta D)\mu\text{m}$  for high-precision measurement.

- Ultra-high speed measurement of 3200 scan/sec. Suitable for high-speed lines or in applications subject to vibration.



### SPECIFICATIONS

Order No. (Laser only)	<b>544-536</b>	
Package No. (Laser w/LSM 6200 display)	<b>64PKA119</b>	
Applicable laser standards	IEC, FDA	
User's manual	English version	
Measuring range	.012" to 1.18" (0.3 to 30mm)	
Resolution	.000001" to .005" (0.02 to 100 $\mu\text{m}$ ) (selectable)	
Repeatability*1	$\pm 0.11\mu\text{m}$	
Accuracy*2 (20°C)	Whole range	$\pm 1.0\mu\text{m}$
	Small range	$\pm(0.6+0.1\Delta D)\mu\text{m}$ *3
Positional error*4	$\pm 1.5\mu\text{m}$	
Measuring area*5	10x30mm (0.3 to 30mm)	
Scanning rate	3200 scans/s	
Laser wavelength	650nm (Visible)	
Laser scanning speed	226m/s	
Operating environment	Temperature	0 to 40°C
	Humidity	RH 35 to 85% (no condensation)
Protection Level	IP64*6	

\*1: Determined by the value of  $\pm 2\sigma$  ( $\sigma$ : standard deviation) when measuring ø30mm at the interval of 0.32 sec. (average 1024 times).

\*2: Center of the measuring range for cylindrical workpieces outside diameter.

\*3:  $\Delta D$ =Difference in diameter between the master gage and workpiece (Unit: mm).

\*4: An error of the outside diameter due to variation in workpiece position either in the optical axis direction or in the scanning direction.

\*5: The area given by [optical axis direction]x[scanning direction].

\*6: The protection level provided for the interior. If the workpiece or glass of the measuring unit window is soiled by water or dust, the unit may malfunction.

### DIMENSIONS

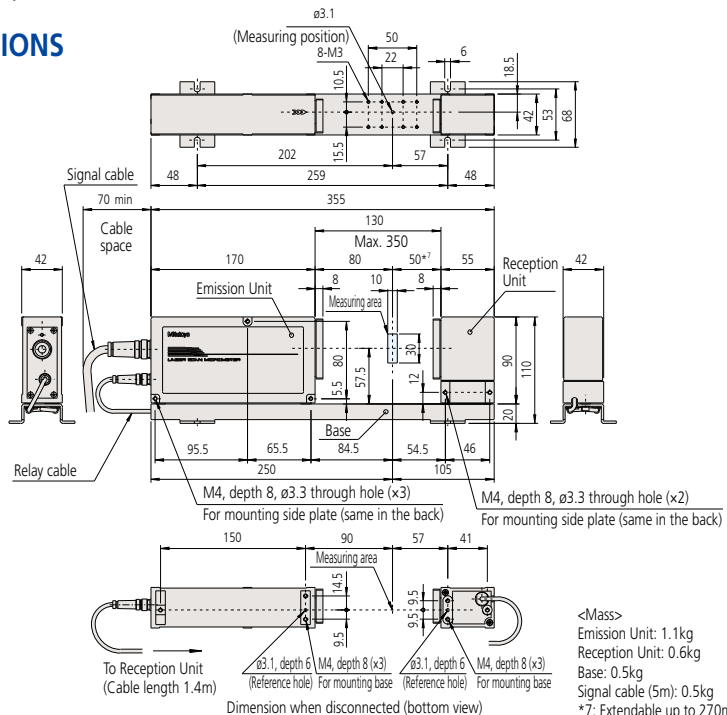

# Laser Scan Micrometer LSM-506S

## SERIES 544 — High-accuracy Non-contact Measuring System

- Ensures  $\pm 3\mu\text{m}$  accuracy over the entire measuring range (1 to 60mm).

- Narrow range accuracy of  $\pm(1.5+0.5\Delta D)\mu\text{m}$  for high precision measurement.
- Ultra-high speed measurement of 3200 scan/sec. Suitable for high-speed lines or in applications subject to vibration.

IP64

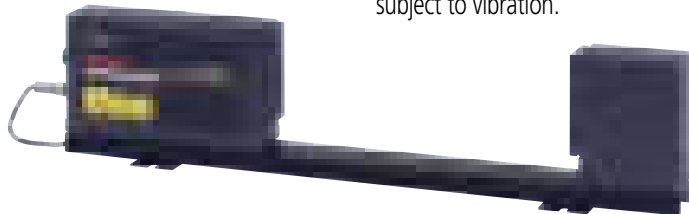

### SPECIFICATIONS

Order No. (Laser only)	544-538	
Package No. (Laser w/ LSM 6200 display)	64PKA120	
Applicable laser standards	IEC, FDA	
User's manual	English version	
Measuring range	.040" to 2.36" (1 to 60mm)	
Resolution	.000002" to .005" (0.05 to 100 $\mu\text{m}$ ) (selectable)	
Repeatability*1	$\pm 0.36\mu\text{m}$	
Accuracy*2 (20°C)	Whole range	$\pm 3\mu\text{m}$
	Small range	$\pm(1.5+0.5\Delta D)\mu\text{m}$ *3
Positional error*4	$\pm 4\mu\text{m}$	
Measuring area*5	20x60mm (1 to 60mm)	
Scanning rate	3200 scans/s	
Laser wavelength	650nm (Visible)	
Laser scanning speed	452m/s	
Operating environment	Temperature	0 to 40°C
	Humidity	RH 35 to 85% (no condensation)
Protection Level	IP64*6	

\*1: Determined by the value of  $\pm 2\sigma$  ( $\sigma$ : standard deviation) when measuring  $\phi 60\text{mm}$  at the interval of 0.32 sec. (average 1024 times).

\*2: Center of the measuring range for cylindrical workpieces outside diameter.

\*3:  $\Delta D$ =Difference in diameter between the master gage and workpiece (Unit: mm)

\*4: An error of the outside diameter due to variation in workpiece position either in the optical axis direction or in the scanning direction.

\*5: The area given by [optical axis direction]x[scanning direction].

\*6: The protection level provided for the interior. If the workpiece or glass of the measuring unit window is soiled by water or dust, the unit may malfunction.

### DIMENSIONS

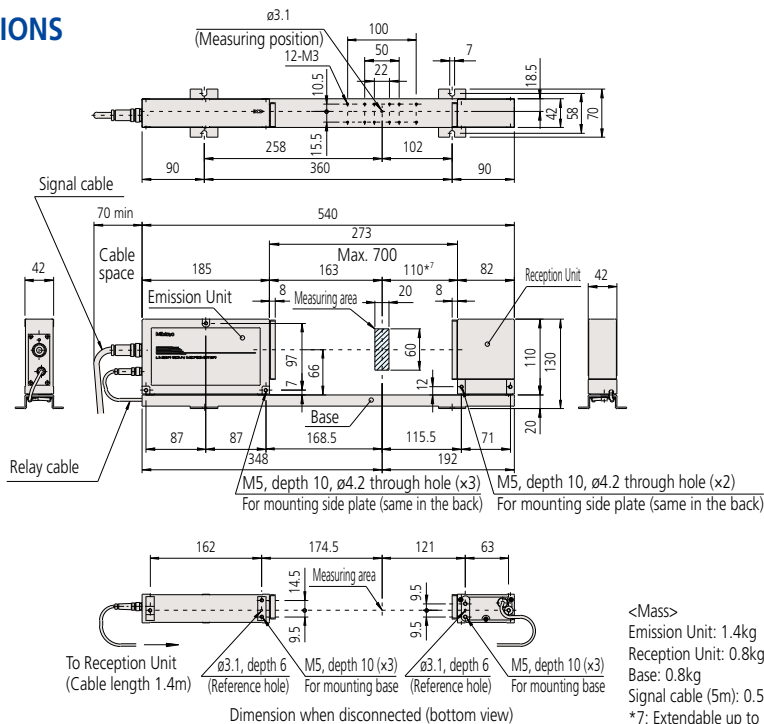

### Optional Accessories

- Multifunctional display unit, LSM-6200\*:

Order No.	Display type	Remarks
544-072A	English mm/inch	English user's manual

\* Included in packages

- Easy-to-operate display unit, LSM-5200:

Order No.	Remarks
544-047*	English user's manual

\* AC adapter not included

- Calibration gage set ( $\phi 1.0, \phi 60.0$ )

: No.02AGD140

: No.02AGD520

: No.02AGD250

- Adjustable workstage
- Air blower/purge
- Extension signal cables

Order No.	Cable length
02AGN780A	5m
02AGN780B	10m
02AGN780C	15m
02AGN780D	20m

- Extension relay cables

Order No.	Cable length
02AGC150A	1m
02AGC150B	3m
02AGC150C	5m

### QUICKTOOL

QUICKTOOL is a free downloadable software program that makes programming the LSM-6200 quick and easy.

Basic data acquisition is also possible. (Connecting cables to PC are optional)

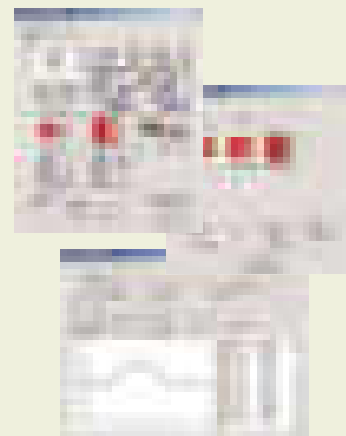

### Laser safety

Mitutoyo Laser Scan Micrometers use a low-power visible laser for measurement. The laser is a CLASS 2 EN/IEC60825-1 (2007) device. Warning and explanation labels, as shown below, are attached to the Laser Scan Micrometers as is appropriate.



# Laser Scan Micrometer LSM-512S

## SERIES 544 — High-accuracy Non-contact Measuring System

### Optional Accessories

- Multifunctional display unit, **LSM-6200\***:

Order No.	Display type	Remarks
<b>544-072A</b>	English mm/inch	English user's manual

\* Included in packages

- Easy-to-operate display unit, **LSM-5200**:

Order No.	Remarks
<b>544-047*</b>	English user's manual

\* AC adapter not included

- Calibration gage set (ø20.0, ø120.0)

: **No.02AGD150**

: **No.02AGD260**

- Air blower/purge
- Extension signal cables

Order No.	Cable length
<b>02AGN780A</b>	5m
<b>02AGN780B</b>	10m
<b>02AGN780C</b>	15m
<b>02AGN780D</b>	20m

- Extension relay cables

Order No.	Cable length
<b>02AGC150A</b>	1m
<b>02AGC150B</b>	3m
<b>02AGC150C</b>	5m

### QUICKTOOL

QUICKTOOL is a free downloadable software program that makes programming the LSM-6200 quick and easy.

Basic data acquisition is also possible. (Connecting cables to PC are optional)

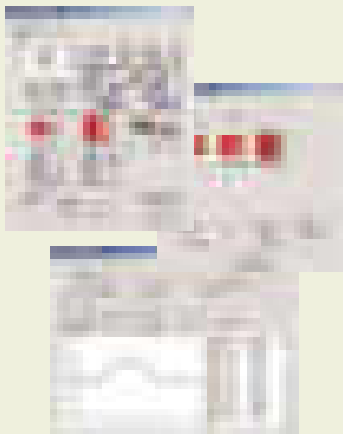

### Laser safety

Mitutoyo Laser Scan Micrometers use a low-power visible laser for measurement. The laser is a CLASS 2 EN/IEC60825-1 (2007) device. Warning and explanation labels, as shown below, are attached to the Laser Scan Micrometers as is appropriate.



- Ensures  $\pm 6\mu\text{m}$  accuracy over the entire measuring range (1 to 120mm).

- Narrow range accuracy of  $\pm(4.0+0.5\Delta D)\mu\text{m}$  for high-precision measurement.
- Ultra-high speed measurement of 3200 scan/sec. Suitable for high speed-lines or in applications subject to vibration.

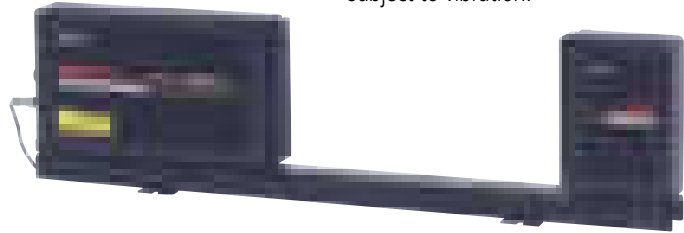

### SPECIFICATIONS

Order No. (Laser only)	544-540
Package No. (Laser w/ LSM 6200 display)	<b>64PKA121</b>
Applicable laser standards	IEC, FDA
User's manual	English version
Measuring range	.040" to 4.72" (1 to 120mm)
Resolution	.000005" to .005" (0.1 to 100 $\mu\text{m}$ ) (selectable)
Repeatability*1	$\pm 0.85\mu\text{m}$
Accuracy*2	$\pm 6\mu\text{m}$
Whole range (20°C)	$\pm(4.0+0.5\Delta D)\mu\text{m}^{*3}$
Small range	$\pm 8\mu\text{m}$
Positional error*4	$\pm 8\mu\text{m}$
Measuring area*5	30x120mm (1 to 120mm)
Scanning rate	3200 scans/s
Laser wavelength	650nm (Visible)
Laser scanning speed	904m/s
Operating environment	Temperature: 0 to 40°C
Humidity	RH 35 to 85% (no condensation)
Protection level	IP64*6

\*1: Determined by the value of  $\pm 2\sigma$  ( $\sigma$ : standard deviation) when measuring ø120mm at the interval of 0.32 sec. (average 1024 times).

\*2: Center of the measuring range for cylindrical workpieces outside diameter.

\*3:  $\Delta D$ =Difference in diameter between the master gage and workpiece (Unit: mm)

\*4: An error of the outside diameter due to variation in workpiece position either in the optical axis direction or in the scanning direction.

\*5: The area given by [optical axis direction]x[scanning direction].

\*6: The protection level provided for the interior. If the workpiece or glass of the measuring unit window is soiled by water or dust, the unit may malfunction.

### DIMENSIONS

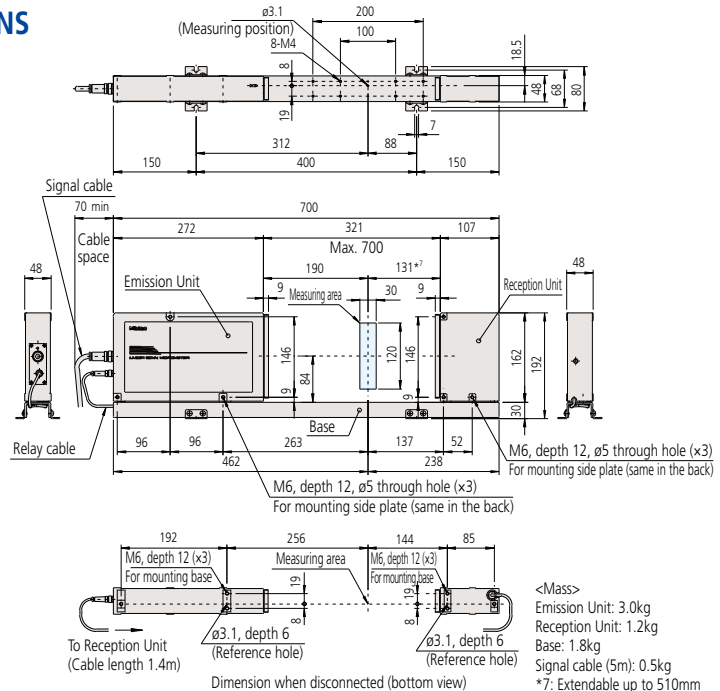

# Laser Scan Micrometer LSM-516S

## SERIES 544 — High-accuracy Non-contact Measuring System

- Ensures  $\pm 7\mu\text{m}$  accuracy over the entire measuring range (1 to 160mm).
- Narrow range accuracy of  $\pm(4.0+2.0\Delta D)\mu\text{m}$  for high-precision measurement.
- Ultra-high speed measurement of 3200 scan/sec.
- Suitable for high-speed lines or in applications subject to vibration.

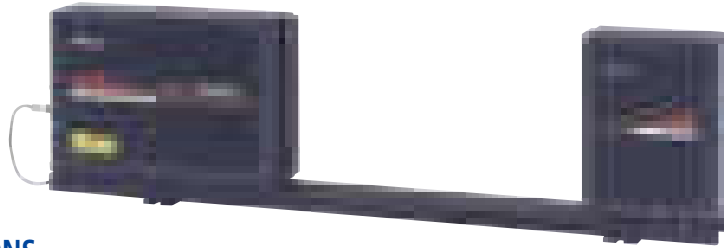

### SPECIFICATIONS

Order No. (Laser only)	<b>544-542</b>	
Package No. (Laser w/ LSM 6200 display)	<b>64PKA122</b>	
Applicable laser standards	IEC, FDA	
User's manual	English version	
Measuring range	.040" to 6.3" (1 to 160mm)	
Resolution	.000005" to .005" (0.1 to 100 $\mu\text{m}$ ) (selectable)	
Repeatability*1	$\pm 1.4\mu\text{m}$	
Accuracy*2 (20°C)	Whole range	$\pm 7\mu\text{m}$
	Small range	$\pm(4.0+2.0\Delta D)\mu\text{m}$ *3
Positional error*4	$\pm 8\mu\text{m}$	
Measuring area*5	40x160mm (1 to 160mm)	
Scanning rate	3200 scans/s	
Laser wavelength	650nm (Visible)	
Laser scanning speed	1206m/s	
Operating environment	Temperature	0 to 40°C
	Humidity	RH 35 to 85% (no condensation)
Protection level	IP64*6	

- \*1: Determined by the value of  $\pm 2\sigma$  ( $\sigma$ : standard deviation) when measuring  $\phi 160\text{mm}$  at the interval of 0.32 sec. (average 1024 times).  
 \*2: Center of the measuring range for cylindrical workpieces outside diameter.  
 \*3:  $\Delta D$ =Difference in diameter between the master gage and workpiece (Unit: mm)  
 \*4: An error of the outside diameter due to variation in cylinder position either in the optical axis direction or in the scanning direction.  
 \*5: The area given by [optical axis direction]x[scanning direction].  
 \*6: The protection level provided for the interior. If the workpiece or glass of the measuring unit window is soiled by water or dust, the unit may malfunction.

### DIMENSIONS

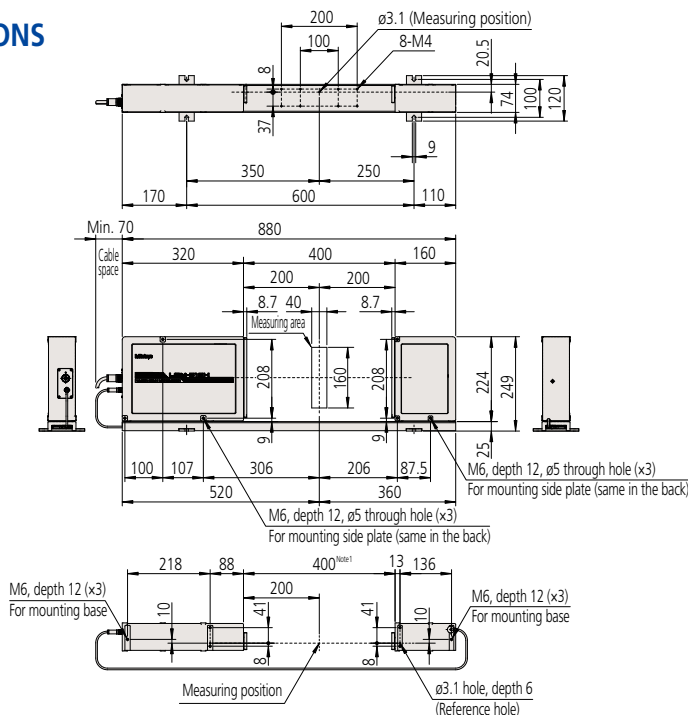

Note 1: Distance between emission unit and reception unit: 400mm to 800mm

### Optional Accessories

- Multifunctional display unit, **LSM-6200\***:

Order No.	Display type	Remarks
<b>544-072A</b>	English mm/inch	English user's manual

\* Included in packages

- Easy-to-operate display unit, **LSM-5200**:

Order No.	Remarks
<b>544-047*</b>	English user's manual

\* AC adapter not included

- Calibration gage set ( $\phi 20, \phi 160$ )

: **No.02AGM300**

- Extension signal cables

Order No.	Cable length
<b>02AGN780A</b>	5m
<b>02AGN780B</b>	10m
<b>02AGN780C</b>	15m
<b>02AGN780D</b>	20m

- Extension relay cables

Order No.	Cable length
<b>02AGC150A</b>	1m
<b>02AGC150B</b>	3m
<b>02AGC150C</b>	5m

### QUICKTOOL

QUICKTOOL is a free downloadable software program that makes programming the LSM-6200 quick and easy. Basic data acquisition is also possible. (Connecting cables to PC are optional)

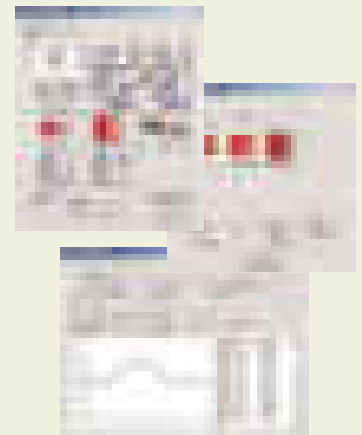

### Laser safety

Mitutoyo Laser Scan Micrometers use a low-power visible laser for measurement. The laser is a CLASS 2 EN/IEC60825-1 (2007) device. Warning and explanation labels, as shown below, are attached to the Laser Scan Micrometers as is appropriate.



# Laser Scan Micrometer LSM-9506

## SERIES 544 — Bench-top Type Non-contact Measuring System

### Optional Accessories

#### 02AGD170

Calibration gage set (ø1.0mm, ø60mm)



**02AGD680** Adjustable workstage

**02AGD580** Center support\*

**02AGD590** Adjustable V-block\*

**936937** SPC output cable (1m)

**937179T** Footswitch

**264-016** USB input tool for spreadsheets  
(SPC cable also required)

\*Use with an adjustable workstage.

\*1: Determined by the value for  $\pm 2\sigma$  at the measurement interval of 0.32 sec.

\*2: At the center of the measuring region.

\*3: An error due to workpiece shift either in the optical axis direction or in the scanning direction. L= Distance between the center of workpiece and the center of optical axis (in mm or inches).

\*4: The area given by measuring range on the optical axis x measuring range in the scanning direction.

\*5: FDA Class II (544-116-1A) semiconductor laser for scanning (Maximum power: 1.0mW)

### QUICKTOOL

QUICKTOOL is a free downloadable software program that makes programming the LSM-6200 quick and easy.

Basic data acquisition is also possible.  
(Connecting cables to PC are optional)

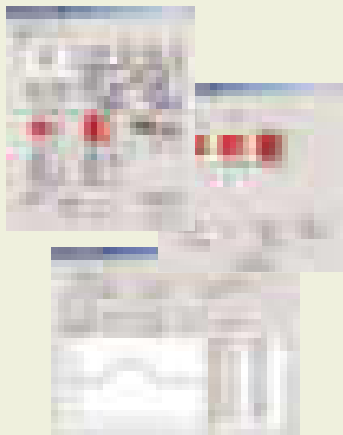

- Bench-top type with integrated display unit includes many functions equivalent to the multi-function display unit.

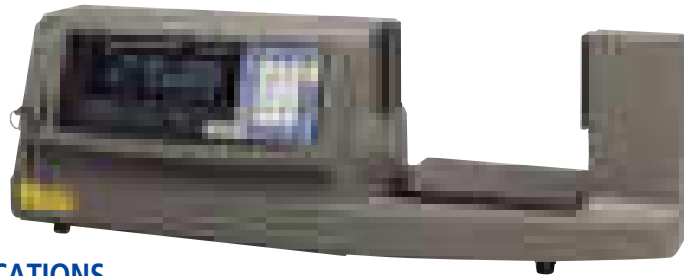

### SPECIFICATIONS

Order No.	544-116-1A
Type	inch/mm
Measuring range	.02" - 2.36"/0.5 - 60mm
Resolution	.000002" - .005"/0.00005 - 0.1mm
Repeatability*1	$\pm 0.6\mu\text{m}$ ( $\pm 0.00003"$ )
Accuracy*2 (20°C)	$\pm 2.5\mu\text{m}$ ( $\pm 0.0001"$ )
Positional error*3 (optical axis/scanning direction)	$\pm 2.5\mu\text{m}$ ( $\pm 0.0001"$ ) L: Displacement between workpiece center and optical axis center
Measuring area*4	$\pm 5 \times 60\text{mm}$ ( $\pm 2 \times 2.36"$ )
Scanning rate	1600 scans/s
Laser wavelength	650nm (Visible)*5
Laser scanning speed	226m/s (8900" / s)
Display unit	16-digit dot matrix (upper column) + 7 segment 11-digit (lower column), guidance LEDs
Standard interface	RS-232C, Digimatic code output unit (1ch)
Optional interface	No
Power supply	120 V AC $\pm 10\%$ , 40VA, 60Hz
Operating environment	0 to 40°C, RH 35 to 85% (no condensation)

\*1: Determined by the value of  $\pm 2\sigma$  ( $\sigma$ : standard deviation) when measuring ø10mm at the interval of 0.32 sec. (average 1024 times).

\*2: Center of the measuring range for cylindrical workpieces outside diameter.

\*3: An error of the outside diameter due to variation in workpiece position either in the optical axis direction or in the scanning direction.

\*4: The area given by [optical axis direction] x [scanning direction].

\*5: FDA Class II (544-116-1A)/IEC Class 2 semiconductor laser for scanning. (Maximum power: 1.0mW)

### DIMENSIONS

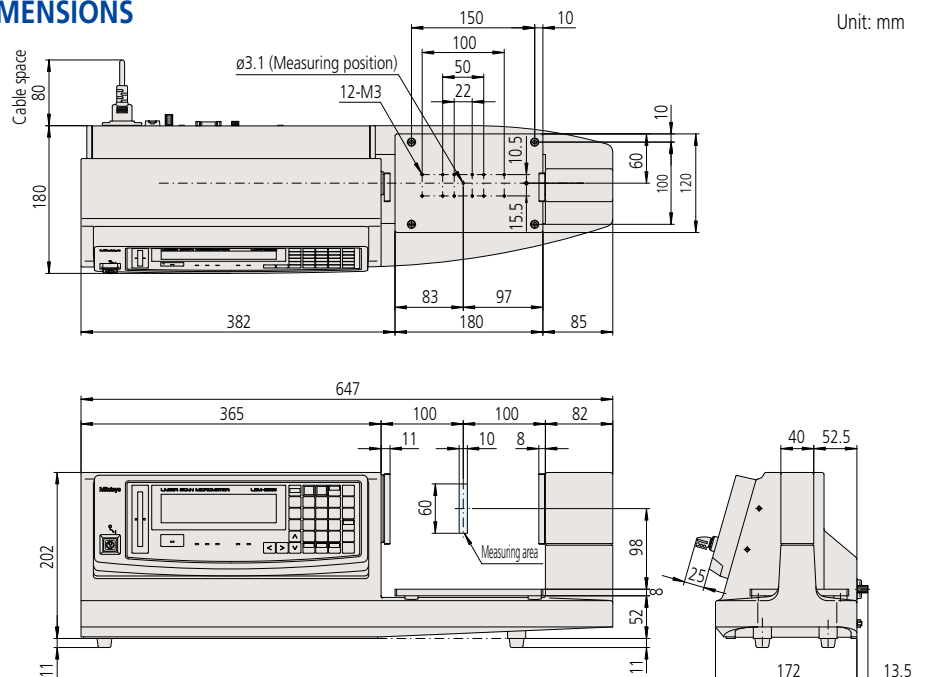

### Laser safety

Mitutoyo Laser Scan Micrometers use a low-power visible laser for measurement. The laser is a CLASS 2 EN/IEC60825-1 (2007) device. Warning and explanation labels, as shown below, are attached to the Laser Scan Micrometers as is appropriate.



# LSM-6200 Display Unit

## SERIES 544 — Standard Display Unit for Laser Scan Micrometer

- 2-axis display unit enables 2 items to be displayed simultaneously.
- Capable of statistical analysis such as: average, maximum value, minimum value, range (max. - min.) and more.
- Segment measurement (7 points) or edge measurement (1 to 255 edge) can be selected.
- A function to eliminate abnormal values is standard.
- 100 tolerance values, preset values or settings can be stored.

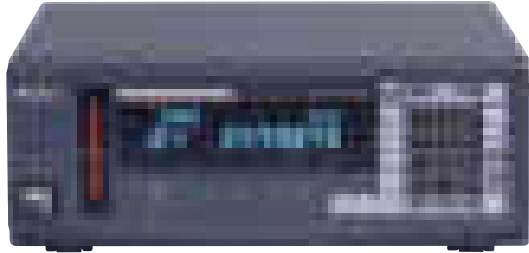

### SPECIFICATIONS

Order No.	<b>544-072A</b>
Type	inch/mm
Display	16-digit plus 11-digit fluorescent display and guide message LED
Segment	1 to 7 (1 to 3, transparent) or 1 to 255 edges* <sup>1</sup>
Averaging method	Arithmetic average: per 8 to 2048/ Moving average: per 32 to 2048 (Arithmetic average is per 16 to 2048 when using <b>544-531, 544-532</b> )
Judgment	Selection from target value + tolerance, lower tolerance + upper tolerance, or 7 classes multi-limit tolerance zone.
Measurement mode	Standby, Single measurement, Continuous measurement
Statistical analysis	Maximum, Minimum, Average, Dispersion, $\sigma$ (S.D)
Size	335 (W) $\times$ 134 (H) $\times$ 250 (D)mm
Power supply	120 V AC $\pm$ 10%, 40VA, 60Hz
Standard I/F	RS-232C, Analog I/O
Optional I/F	Digimatic code output unit (2-ch), 2nd I/O analog I/F, BCD I/F
Operating environment	0 to +45°C, RH 35 to 85% (no condensation)
Others	Nominal setting, sample setting, selection of unnecessary digits, transparent object measurement* <sup>2</sup> , measurement of odd fluted parts, automatic measurement in edge mode, output timer, abnormal data elimination, SHL change, group judgment, simultaneous measurement, statistical processing, mastering, buzzer function, automatic workpiece detection (dimension/position)* <sup>1</sup> , zero-set/offset, dual measurement (optional)

\*1: The measuring range will be 0.1mm to 2mm in the 1 to 255 edge measurement mode or when activating the automatic workpiece detection with **544-531, 544-532**.

Each function has its combination limit.

\*2: The measuring range is 50 $\mu$ m to 2mm when using **544-531, 544-532**. For smaller range, contact your local Mitutoyo sales office.

\*\* Cannot be connected to **544-499A**.

\*\* Previous models such as **544-451** cannot be connected.

### DIMENSIONS

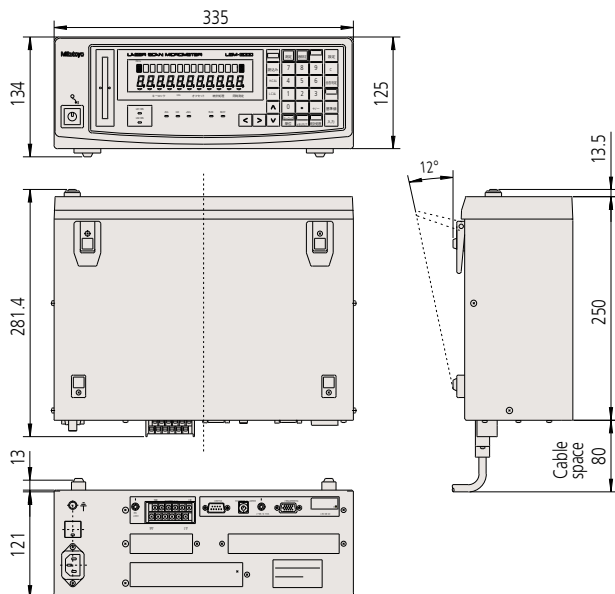

Unit: mm

### Optional Accessories

- 12AAA807** Serial cable (RS-232C null)
- 937179T** Footswitch
- 02AGN780A, B, C, D** Extension Signal Cables
- 02AGC840** Digimatic output card
- 02AGP150** Dual Input Card
- 02AGC910** BCD output
- 02AGC880** 2nd analog output card
- 02AGD600B** Printer

### QUICKTOOL

QUICKTOOL is a free downloadable software program that makes programming the LSM-6200 quick and easy.

Basic data acquisition is also possible. (Connecting cables to PC are optional)

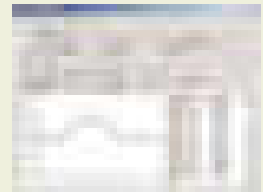
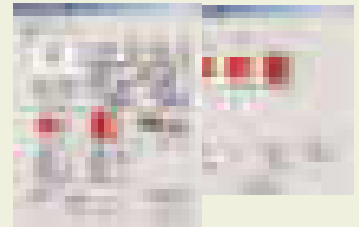

# LSM-5200 Display Unit

## SERIES 544 — Compact Display Unit for Real-time Multi-channel Measurement

- A compact controller which could be used for multi-unit system configurations.
- Capable of simple connection to a PC via USB.
- A panel-mount type display unit designed for the LSM-S series.
- Analog I/O and RS-232C is standard.
- Measurement of odd fluted parts, and simultaneous measurement / 2-program function included.



### QUICKTOOL

QUICKTOOL is a free downloadable software program that makes programming the LSM-6200 quick and easy.

Basic data acquisition is also possible. (Connecting cables to PC are optional)

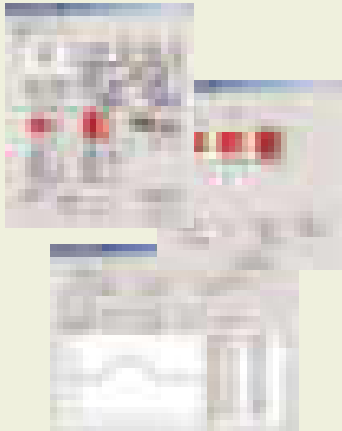

### SPECIFICATIONS

Order No.	544-047
Display	9 digits plus 8 digits LED, guide message LED
Segment	1 to 7 (1 to 3, transparent) or 1 to 255 edges*1
Averaging method	Arithmetic average: from 4 to 2048; Moving average: from 32 to 2048 (Arithmetic average is from 16 to 2048 when using LSM-500S.)
Judgment	Selecting from target value $\pm$ tolerance value or lower limit/upper limit.
Measurement mode	Standby, Single measurement, Continuous measurement
Statistical analysis	Calculation result is output via USB or RS-232C.
External dimensions	144 (W) $\times$ 72 (H) $\times$ 197.1 (D)mm
Power supply*3	24V DC $\pm$ 10%, 1.3A or more (AC adapters are optional)
Standard I/F	USB2.0, RS-232C, I/O analog
Operating environment	0 to 40°C, RH 35 to 85% (no condensation)
Preservation environments	-20 to 70°C, RH 35 to 85% (no condensation)
Others	Measurement of odd fluted parts, simultaneous measurement, nominal setting, sample setting, selection of unnecessary digits, transparent object measurement*2 Automatic workpiece detection (dimension/position detected)*1, abnormal data elimination, mastering, statistical processing (when using USB, RS-232C), output timer, automatic measurement in edge mode, presetting note that every function is limited in its combination possibilities. See the user manual for details.
Mass	1.4 kg

\*1: The measuring range will be 0.1mm to 2mm in the 1 to 255 edge measurement mode or when activating the automatic workpiece detection with **544-531, 544-532**. Each function has its combination limit.

\*2: The measuring range is 50 $\mu$ m to 2mm when using **544-531, 544-532**. For smaller ranges, contact your local Mitutoyo sales office.

\*3: DC24V external power supply (commercial item) is required separately.

Note 1: Cannot be connected to **544-499A**.

Note 2: Previous models such as **544-451** cannot be connected.

Note 3: For USB communication with a PC, a dedicated device driver is required. For details, contact your local Mitutoyo sales office.

### DIMENSIONS

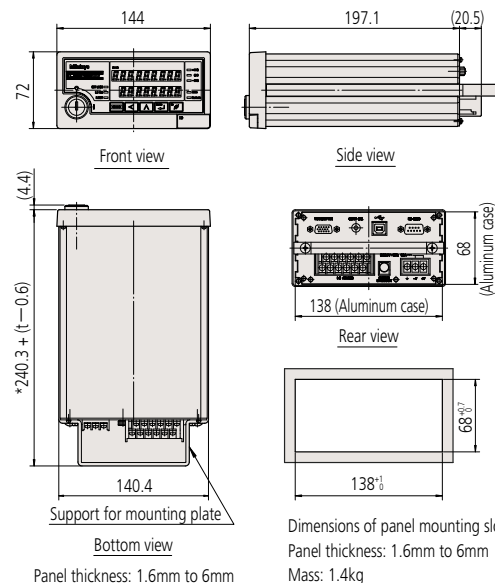

# Laser Scan Micrometer

## SERIES 544 Optional Accessories

### Calibration Gage Set

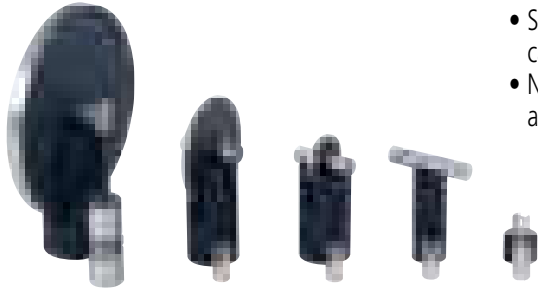

- Standard cylinder gage set suitable for calibration of Laser Scan Micrometers.
- Nominal gage diameters (1 to 160mm) are as given in specifications.



### SPECIFICATIONS

For calibrating models	544-499A	544-532	544-534	544-536	544-538	544-540	544-542	544-116-1A	
	LSM-6902H	LSM-500S	LSM-501S	LSM-503S	LSM-506S	LSM-512S	LSM-516S	LSM-9506	
Set No.	02AGD180	02AGD110	02AGD120	02AGD130	02AGD140	02AGD150	02AGM300	02AGD170	
Configuration (Order No.)	Stand	02AGD181	02AGD111	02AGD121	02AGD131	02AGD141	02AGD151	02AGM320	02AGD171
	Gages	ø1: 02AGD920 ø25: 02AGD963	ø0.1: 958200 ø2: 958202	ø0.1: 958200 ø10: 229317	ø1: 02AGD920 ø30: 02AGD961	ø1: 02AGD920 ø60: 02AGD962	ø20: 229730 ø120: 234072	ø20: 229730 ø160: 02AGM303	ø1: 02AGD920 ø60: 02AGD962
	Carrying case	02AGD190	958203	958203	02AGD980	02AGD980	02AGD990	02AGM310	02AGD970

### Workstage



Installation example



- Easy set-up and height adjustment enables high-precision measurement.

### SPECIFICATIONS

Model	544-534 544-536 544-499A
Order No.	02AGD270

### Adjustable workstage

- Vertical/horizontal slide mechanism enables easy measurement of various workpiece diameters.
- Best suited for quality assurance of high-precision pin gages.

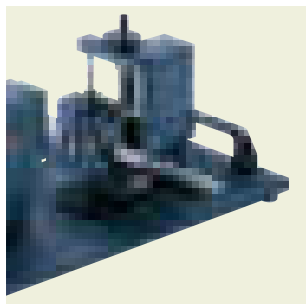

### Measurement Examples

- Roller of copying machine

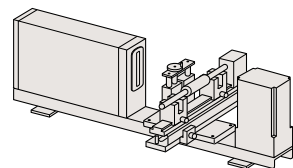

- Pin gage or plug gage

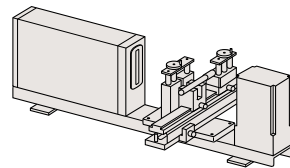

### Basic configuration

Basic set	Order No.	Applicable model	Standard accessories	Measuring range (mm)	Horizontal stroke (mm)	Vertical stroke (mm)
(1) Main unit (2) V-block (3) Stop	02AGD280	544-499A	V-block (02AGD420), 2 pcs Stopper (02AGD430), 1 pc	0.1 - 25	130	47
	02AGD400	544-534		0.05 - 10	130	32
	02AGD490	544-536		0.3 - 30	200	35
	02AGD520	544-538	V-block A (02AGD550), 2 pcs V-block B (02AGD550), 1 pc V-block C (02AGD570), 1 pc	1 - 60	300	45
	02AGD370	544-116-1A		0.5 - 60	200	45
	02AGD680			0.5 - 60	300	45

\* The stop is not included in the basic set for 544-538, 544-116.

- Optional parts for the adjustable workstage, such as center support, adjustable V-block (up/down) etc., are available.



# Laser Scan Micrometer

## SERIES 544 Optional Accessories

### Guide pulley

- Used for supporting measurement of outside diameter of fine wire-like materials such as magnetic wire or fiber.

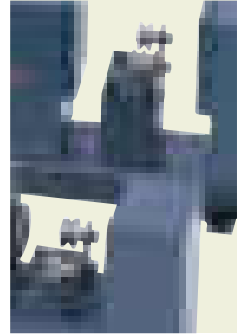

### SPECIFICATIONS

Model	544-532	544-534
Order No.	02AGD200	02AGD210

Each measurement range is as follows:

**544-532:**  $\varnothing 5\mu\text{m}$  to  $\varnothing 1.6\text{mm}$

**544-534:**  $\varnothing 50\mu\text{m}$  to  $\varnothing 2\text{mm}$

For calibration, the calibration gage set for **544-532 (No.02AGD110)** is required.

### Air shield driven by air supply unit

- Air blows from the air outlet installed on the laser section to clear dust from adhering to the laser window.

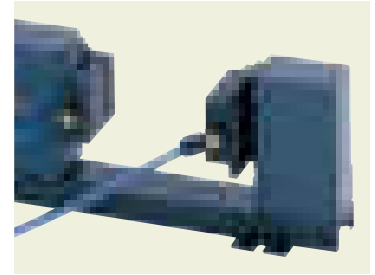

### SPECIFICATIONS

Air supply unit	Air shield	Applicable models
No.957608	No.02AGD220	544-532
	No.02AGD230	544-534
	No.02AGD240	544-536
	No.02AGD250	544-538
	No.02AGD260	544-540

Air shield	Quantity
No.02AGD220/No.02AGD230	6
No.02AGD240	3
No.02AGD250/No.02AGD260	1

\*1: Air shield and air supply unit are sold separately. An air supply unit includes a flow regulating valve and filter. Note, however, that clean air should be supplied.

\*2: Air shield is supplied with 5m air tube (Outside diameter: 6mm).

\*3: Air supply unit is compatible with air tube of 9mm internal diameter.

### Extension Signal Cable / Extension Relay Cable

- Extension signal cables are necessary when the measuring unit and display unit are separated in operation. Extension relay cables are necessary when the optical section is separated in operation.

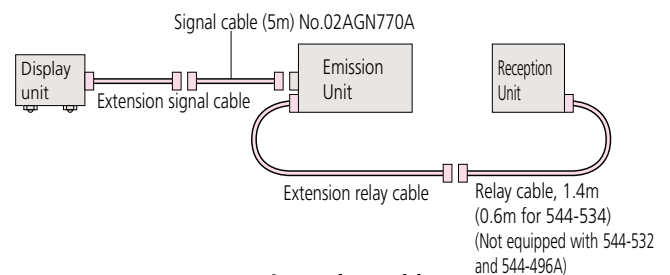

### SPECIFICATIONS

#### Extension Signal Cable

Order No.	Cable length
02AGN780A	5m
02AGN780B	10m
02AGN780C	15m
02AGN780D	20m

#### Extension Relay Cable

Order No.	Cable length
02AGC150A	1m
02AGC150B	3m
02AGC150C	5m

\* For **544-532** and **544-534** the allowable maximum length for signal cable is 20m; relay cable is 2m.

\* For **544-536, 544-538, 544-540** and **544-542** the allowable maximum length for signal cable is 30m; relay cable is 5m.

\* The maximum extension length of the signal cable and relay cable is 32m in total.

\* Cannot be used with **544-499A**.

# Laser Scan Micrometer

## SERIES 544 Optional Accessories

### Thermal printer DPU-414



- Measurement data can be printed.

#### SPECIFICATIONS

Order No.	<b>02AGD600B</b>
Printing method	Thermal dot matrix
Printing capacity	40 Columns (Normal)
Character configuration	9×8 dot matrix
Printing direction	Bidirectional
Interface	RS-232C
Power supply	AC 100-240V 50/60Hz (AC adapter)
Standard accessories	Printer cable 2m ( <b>02AGD620A</b> ), Printer paper 1 roll, AC adapter
Printer paper (optional)	Order <b>No.223663</b> (10-roll set)

### Foot switch



- **937179T**
- For LSM order **544-072A, 544-499A** , **544-116-1A**

## Interface for LSM6200, 6900

### Optional Accessories

#### BCD Interface

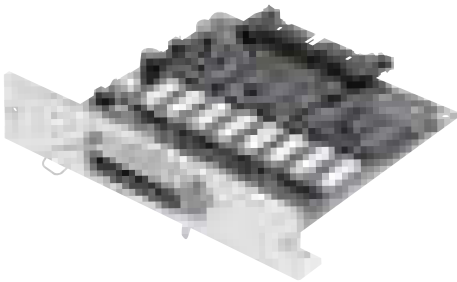

- Outputs measurement data in BCD output (7-digit) or HEX output.
- Data logic can be switched.
- Isolated I/O circuitry
- Available for **544-072A, 544-499A** .

#### SPECIFICATIONS

Order No.	<b>02AGC910</b>
Standard accessories	Connector (DDK) <b>57-30360 (No.214188)</b>

# Laser Scan Micrometer

## SERIES 544 Optional Accessories

### XY Measurement

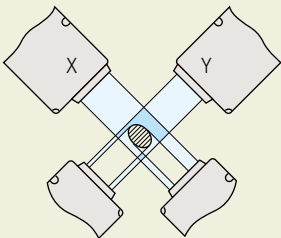

(X-Y): flatness  
(X+Y)/2: average  
\* XY requires 10mm-interval.

### Parallel Measurement

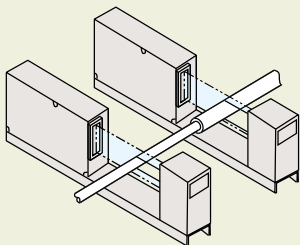

### Large-diameter Measurement

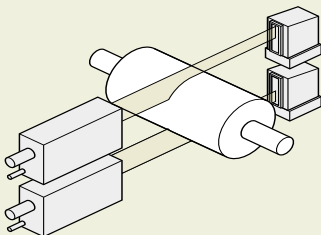

### Digimatic Code Output Unit

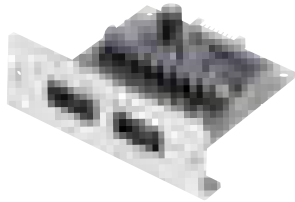

#### SPECIFICATIONS

Order No.	02AGC840
-----------	----------

- 2-channel digimatic code output
- In simultaneous measurement, measurement data are output as follows:  
Program No.0 to No.4 in OUTPUT-1  
Program No.5 - No.9 in OUTPUT-2 (10 programs operated)
- 10 pin MIL type connector.
- Output cable is not supplied.  
Connecting cable (optional) 1m (No.936937)
- Available for **544-072A, 544-499A** .
- \* Output is 6 digits of measurement data.
- \* Displaying 6th and 7th digit after the decimal point is not supported.

### Dual Connection Unit

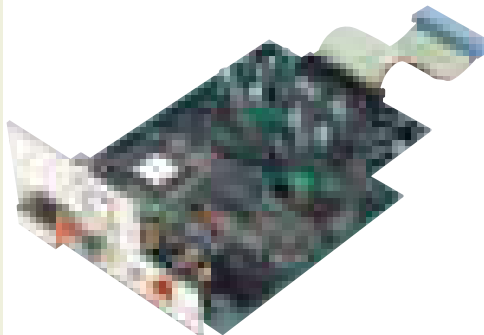

- Enables second unit connection to the **544-072A**. (both units must be the same model)
- \* Cannot be used for **544-499A** .
- Depending on the layout of the two measuring units, large-diameter measurement, XY measurement and parallel measurement are possible.
- Both of the measuring units and display units can be simultaneously operated.

#### SPECIFICATIONS

Order No.	02AGP150
-----------	----------

### 2nd I/O Analog I/F

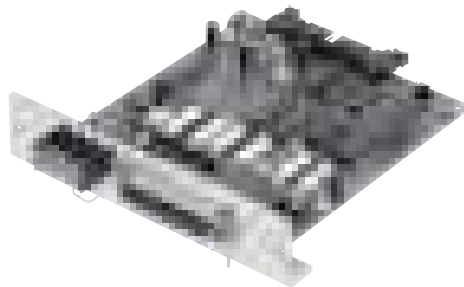

- I/O, analog output.
- Simultaneous measurement is supported by two pairs of go/no-go judgment outputs.
- Available for **544-072A, 544-499A** .

#### SPECIFICATIONS

Order No.	02AGC880
Standard accessories	Connector (DDK) 57-30360 (No.214188)

### Cable for BCD and 2nd I/O Simultaneous Mount

- Both BCD (No.02AGC910) and 2nd I/O analog I/F (No.02AGC880) can be mounted on **544-072A, 544-499A** using this cable.
- \* If using this cable, the dual-connection unit (No.02AGP150) cannot be used.

#### SPECIFICATIONS

Order No.	02AGE060
-----------	----------

#### DIMENSIONS

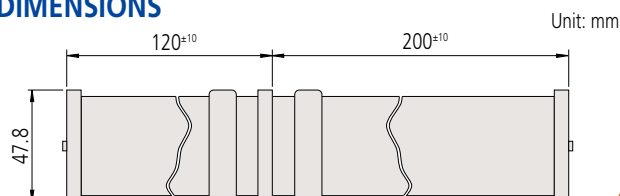

# Quick Guide to Precision Measuring Instruments

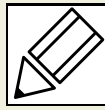

## Laser Scan Micrometers

### Compatibility

Your laser scan micrometer has been adjusted together with the ID unit, which is supplied with the measuring unit. The ID unit, which has the same code number and the same serial number as the measuring unit, must be installed in the display unit. This means that if the ID unit is replaced, the measuring unit can be connected to another corresponding display unit.

### The workpiece and measuring conditions

Depending on whether the laser is visible or invisible, the workpiece shape, and the surface roughness, measurement errors may result. If this is the case, perform calibration with a master workpiece which has dimensions, shape and surface roughness similar to the actual workpiece to be measured. If measurement values show a large degree of dispersion due to the measuring conditions, increase the number of scans for averaging to improve the measurement accuracy.

### Electrical interference

To avoid operational errors, do not route the signal cable and relay cable of the laser scan micrometer alongside a high voltage line or other cables capable of inducing noise current in nearby conductors. Ground all appropriate units and cable shields.

### Connection to a computer

If the laser scan micrometer is to be connected to an external personal computer via the RS-232C interface, ensure that the cable connections conform to the specification.

### Laser safety

Mitutoyo laser scan micrometers use a low-power visible laser for measurement. The laser is a CLASS 2 EN/IEC60825-1 (2007) device. Warning and explanation labels, as shown below, are attached to the laser scan micrometers as appropriate.



### Re-assembly after removal from the base

Observe the following limits when re-assembling the emission unit and reception unit to minimize measurement errors due to misalignment of the laser's optical axis with the reception unit.

#### Alignment within the horizontal plane

- a. Parallel deviation between reference lines C and D: X (in the transverse direction)

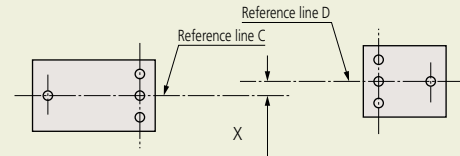

- b. Angle between reference lines C and D:  $\theta_x$  (angle)

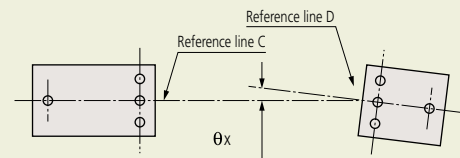

#### Alignment within the vertical plane

- c. Parallel deviation between reference planes A and B: Y (in height)

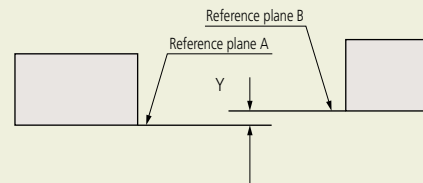

- d. Angle between reference planes A and B:  $\theta_y$  (angle)

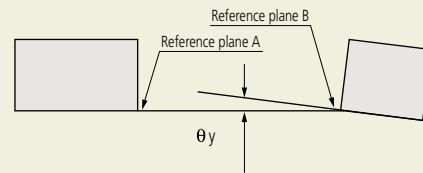

### Allowable limits of optical axis misalignment

Model	Distance between Emission Unit and Reception Unit	X and Y	$\theta_x$ and $\theta_y$
544-533, 544-534	68mm ( 2.68" ) or less	within 0.5mm (.02")	within 0.4' (7mrad)
	100mm ( 3.94" ) or less	within 0.5mm (.02")	within 0.3' (5.2mrad)
544-535, 544-536	130mm ( 5.12" ) or less	within 1mm (.04")	within 0.4' (7mrad)
	350mm (13.78" ) or less	within 1mm (.04")	within 0.16' (2.8mrad)
544-537, 544-538	273mm (10.75" ) or less	within 1mm (.04")	within 0.2' (3.5mrad)
	700mm (27.56" ) or less	within 1mm (.04")	within 0.08' (1.4mrad)
544-539, 544-540	321mm (12.64" ) or less	within 1mm (.04")	within 0.18' (3.6mrad)
	700mm (27.56" ) or less	within 1mm (.04")	within 0.08' (1.4mrad)
544-541, 544-542	800mm (31.50" ) or less	within 1mm (.04")	within 0.09' (1.6mrad)



### Digimatic Scale Units



### Linear Scales



### 2D Image Correlation Encoder

## INDEX

### Digimatic Scale Units

SD ABSOLUTE Digimatic Scale Units	H-2,3
ABSOLUTE Digimatic Scale Units	H-4,5
Quill Kit with Absolute Encoder	H-6
KA-200 Counter	H-7
KLD200 Counter	H-7

### Linear Scales

Linear Scale Counter	H-8
Digital Readout/ DRO packages 2-Axis/3-Axis Travels	H-9
Linear Scales System Diagram	H-10,11
Linear Scales ABS AT1100	H-12
Linear Scales ABS AT300	H-13
Linear Scales ABS AT715	H-14
Linear Scales ABS AT500	H-15
Linear Scales ABS ST700	H-16
Linear Scales ABS ST1300	H-17
MICSYS	H-18
Linear Scales AT103	H-19
Linear Scales AT113	H-20
Linear Scales AT112-F	H-21
Linear Scales AT116	H-22
Linear Scales AT402E	H-23
Linear Scales AT203	H-24
Linear Scales AT216-T / AT217-TL	H-25
AT211-A (Multipoint mounting), AT211-B (Double-end mounting)	H-26
Linear Scales ST422	H-27
Linear Scales ST46-EZA	H-28
Linear Scales ST36	H-29
Fiber Scale ST-F11	H-30,31
Pulse Signal Interface Unit PSU-200	H-32
Signal Conversion Adapter PSU-400E	H-33
Quick Guide to Precision Measuring Instruments - Linear Scales	H-34,35

AT1100

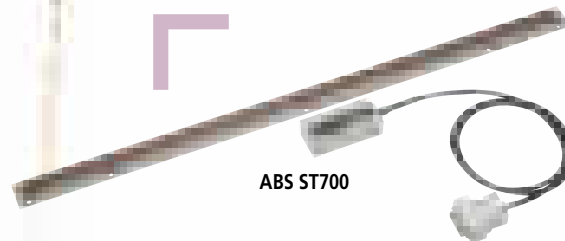

ABS ST700

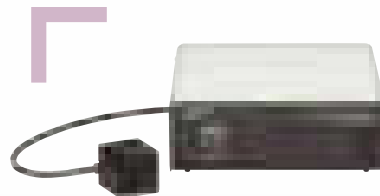

MICSYS-SA1



ST-F11  
Fiber Scale



ABS AT500-S



ABS AT500-H

# SD ABSOLUTE Digimatic Scale Units

SERIES 572

ABSOLUTE™



IP66

Horizontal single-function type (Water-proof type)  
572-602 SD-20G



Horizontal single-function type  
572-202-20 SD-20DX



Horizontal multi-function type  
572-461 SD-15E



Vertical single-function type  
572-303-10 SDV-30D



Vertical multi-function type  
572-561 SDV-15E

- SD series facilitates mounting on jigs, tools and small machine tools to enable accurate positioning.
- Built-in absolute scale including the ABS point requires no zero-set every time the power is turned on. In addition, reliability has improved thanks to elimination of overspeed errors.
- Horizontal or vertical display according to the scale mounting direction.
- The dust resistance and the environmental resistance of the display has improved. The **SD-G** series offers dust/water protection level IP66.
- Long battery life for easier maintenance.
- **EC** counters are available as external display units.
- Equipped with an output port to transfer measurement data. This allows implementation in control systems and gaging systems.

## Applications

Machine table position

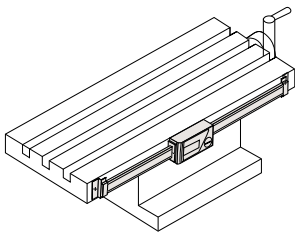

Drilling machine stroke position

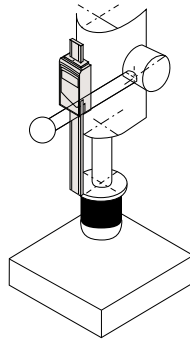

Focus setting on optical instruments

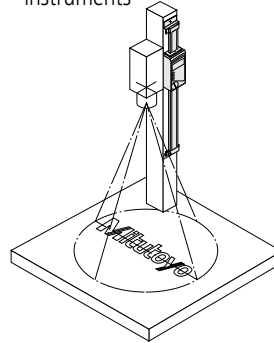

Special applications

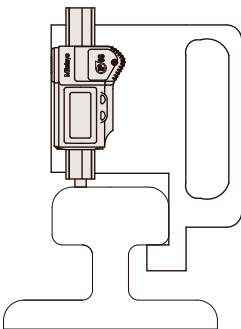

As a measurement jig for outdoor use (SD-G)

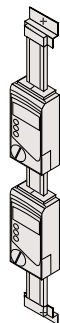

Detector head mechanism

## Functions

- **ABS** (Absolute) measurement function
  - **INC** (Incremental) measurement function
  - Zero-setting function
  - Presetting function (2 preset values can be set. Not available for **SD-G, SD-D, SDV-D**)
  - Double reading function (Available only for **SD-F** or **SDV-F**)
  - Direction switch function  
Not available for **SD-G, SD-D, SDV-D, SD-F, SDV-F**
  - Hold function\*
  - Measurement value composition error alarm
  - Low-battery alarm
  - Output function
- \* To activate the hold function when using **SD-D** or **SDV-D**, an optional hold unit is required. Simultaneous activation with the output function is not available. **SD-G** are also available to special order.
- \* These units use 1.5V silver oxide cells for the power supply. Therefore, when the units are directly fixed to the frame of a machine tool that requires a high voltage, malfunction such as display digit fluctuations and errors may occur. The countermeasure examples are described in the user manuals provided.

Please contact Mitutoyo for other special orders.

## System Diagram

[Scale units]

Single-function type with high dust/water resistance

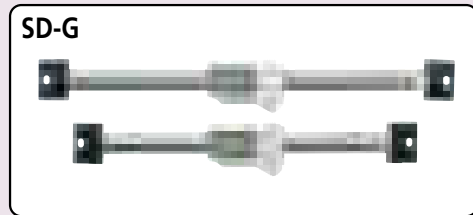

Single-function type

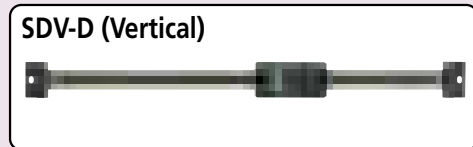
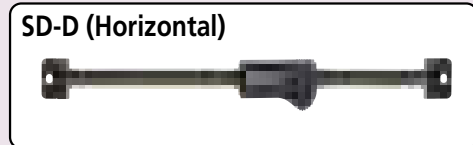

Multi-function type

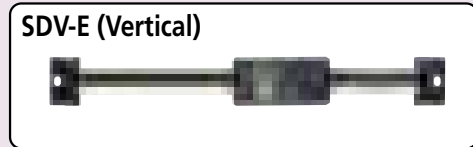
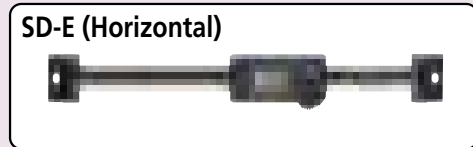

Multi-function type (double reading)

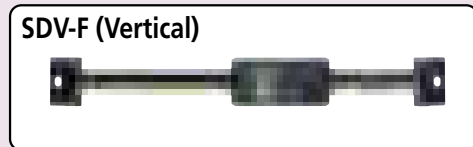
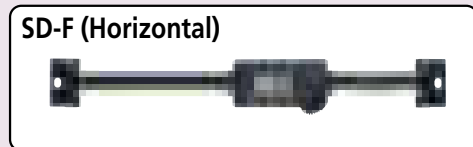

[Display units]

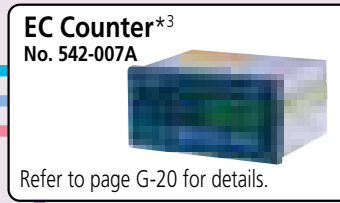

Tolerance judgment output\*<sup>1</sup>

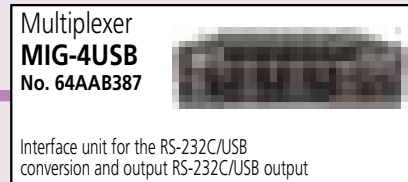
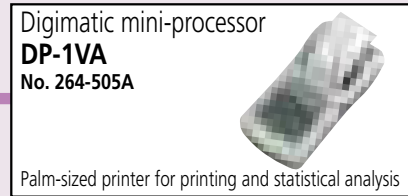

RS-232C/USB output

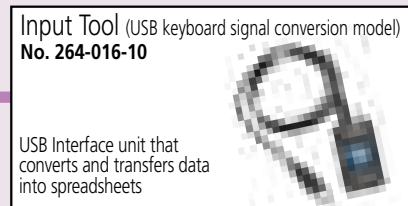

USB keyboard signal conversion

\* Connection to an RS-232C conversion type (**IT-007R**) or a PS/2 keyboard signal conversion type (**IT-005D**) input tool is also available.

Connecting cable with the water-proof type output switch\*<sup>2</sup> 40"/1m : **No.05CZA624**  
80"/2m : **No.05CZA625**

Connecting cable with the output switch 1m : **No.959149**  
2m : **No.959150**

Connecting cable with the output switch



① 40"/1m : **No.905338**  
80"/2m : **No.905409**

② 40"/1m : **No.905689**  
80"/2m : **No.905690**

③ 40"/1m : **No.905691**  
80"/2m : **No.905692**

④ 40"/1m : **No.905693**  
80"/2m : **No.905694**

Connecting cable 40"/1m : **No.936937**  
80"/2m : **No.965014**

- \* 1: Select the tolerance judgment output or digimatic output when setting the parameters.
- \* 2: Connecting cable with the water-proof type output switch can be used only for **SD-G** or Water-proof Digital Caliper **CD-15/20/30PM** equipped with external output function.
- \* 3: Connecting of **SD** series and **DP-1VR/MIG-UUSB/IT-012U** is also available without passing through the EC counter.  
In this case, connect these units and **SD** series with the cables used for the connection with the **EC** counter.

# ABSOLUTE Digimatic Scale Units

SERIES 572

## SPECIFICATIONS

Type	Unit spec.	Order No.	Model	Range	Resolution	Accuracy	Repeatability	Battery life			
Horizontal single-function type (Water-proof type)	Metric	572-600	SD-10G	0-100mm	0.01mm	0.03mm	.0005" / 0.01mm	Approx. 13000 hours			
		572-601	SD-15G	0-150mm							
		572-602	SD-20G	0-200mm							
	Inch/Metric	572-613	SD-4"/10G	0-4"/0-100mm							
		572-614	SD-6"/15G	0-6"/0-150mm							
Horizontal single-function type	Metric	572-200-20	SD-10DX	0-100mm	0.01mm	0.03mm	Approx. 20000 hours				
		572-201-20	SD-15DX	0-150mm		0.04mm					
		572-202-20	SD-20DX	0-200mm							
		572-203-10	SD-30D	0-300mm							
		572-210-20	SD-4"DX	0-4"/0-100mm							
	Inch/Metric	572-211-20	SD-6"DX	0-6"/0-150mm	0.0005"/0.01mm	0.03mm/.001"					
		572-212-20	SD-8"DX	0-8"/0-200mm							
		572-213-10	SD-12"D	0-12"/0-300mm		0.04mm/.002"					
		Horizontal multi-function type	Metric	572-460		SD-10E	0-100mm	0.01mm	0.03mm	Approx. 5000 hours	
				572-461		SD-15E	0-150mm		0.04mm		
572-462	SD-20E			0-200mm							
572-463	SD-30E			0-300mm							
572-464	SD-45E			0-450mm							
572-465	SD-60E			0-600mm							
572-466	SD-80E			0-800mm							
572-467	SD-100E		0-1000mm	0.07mm							
Inch/Metric	572-470		SD-4"E	0-4"/0-100mm	0.0005"/0.01mm	0.03mm/.001"					
	572-471		SD-6"E	0-6"/0-150mm							
	572-472	SD-8"E	0-8"/0-200mm								
Horizontal multi-function type (equipped with double reading function)	Metric	572-473	SD-12"E	0-12"/0-300mm	0.01mm	0.04mm	Approx. 5000 hours				
		572-474	SD-18"E	0-18"/0-450mm		0.05mm					
		572-475	SD-24"E	0-24"/0-600mm							
		572-476	SD-32"E	0-32"/0-800mm							
		572-477	SD-40"E	0-40"/0-1000mm							
		572-480-10	SD-10F	0-100mm		0.01mm		0.03mm			
		572-481-10	SD-15F	0-150mm				0.04mm			
	572-482-10	SD-20F	0-200mm								
	572-483-10	SD-30F	0-300mm								
	572-484-10	SD-45F	0-450mm								
572-485-10	SD-60F	0-600mm									
572-486-10	SD-80F	0-800mm									
572-487-10	SD-100F	0-1000mm	0.07mm								
Vertical single-function type	Metric	572-490-10	SD-4"F	0-4"/0-100mm	0.0005"/0.01mm	0.03mm/.001"	.0005" / 0.01mm				
		572-491-10	SD-6"F	0-6"/0-150mm		0.04mm/.002"					
		572-492-10	SD-8"F	0-8"/0-200mm							
		572-493-10	SD-12"F	0-12"/0-300mm							
		572-494-10	SD-18"F	0-18"/0-450mm							
	Inch/Metric	572-495-10	SD-24"F	0-24"/0-600mm	0.01mm	.002"/0.05mm					
		572-496-10	SD-32"F	0-32"/0-800mm		.0025"/0.06mm					
		572-497-10	SD-40"F	0-40"/0-1000mm		.0025"/0.07mm					
		Vertical multi-function type	Metric	572-300-10		SDV-10D		0-100mm	0.01mm	0.03mm	Approx. 20000 hours
				572-301-10		SDV-15D		0-150mm		0.04mm	
572-302-10	SDV-20D			0-200mm							
572-303-10	SDV-30D			0-300mm							
572-310-10	SD-4"D			0-4"/0-100mm	0.0005"/0.01mm	0.03mm/.001"					
572-311-10	SD-6"D		0-6"/0-150mm								
572-312-10	SD-8"D		0-8"/0-200mm								
572-313-10	SD-12"D		0-12"/0-300mm								
572-560	SDV-10E		0-100mm	0.01mm		0.03mm					
572-561	SDV-15E		0-150mm		0.04mm						
572-562	SDV-20E	0-200mm									
572-563	SDV-30E	0-300mm									
572-564	SDV-45E	0-450mm									
Vertical multi-function type	Metric	572-565	SDV-60E	0-600mm	0.0005"/0.01mm	0.05mm	Approx. 5000 hours				
		572-566	SDV-80E	0-800mm							
		572-567	SDV-100E	0-1000mm							
		572-570	SDV-4"E	0-4"/0-100mm		.001"/0.03mm					
		572-571	SDV-6"E	0-6"/0-150mm							
		572-572	SDV-8"E	0-8"/0-200mm							
		Inch/Metric	572-573	SDV-12"E		0-12"/0-300mm		0.0005"/0.01mm	.002"/0.04mm		
	572-574		SDV-18"E	0-18"/0-450mm							
	572-575		SDV-24"E	0-24"/0-600mm							
	Vertical multi-function type (equipped with double reading function)	Metric	572-576	SDV-32"E	0-32"/0-800mm	0.01mm		.0025"/0.06mm	Approx. 5000 hours		
572-577			SDV-40"E	0-40"/0-1000mm							
572-580-10			SDV-10F	0-100mm	0.0005"/0.01mm		0.03mm				
572-581-10			SDV-15F	0-150mm			0.04mm				
572-582-10			SDV-20F	0-200mm							
572-583-10			SDV-30F	0-300mm							
572-584-10			SDV-45F	0-450mm							
572-585-10		SDV-60F	0-600mm								
572-586-10		SDV-80F	0-800mm								
572-587-10		SDV-100F	0-1000mm	0.07mm							
Inch/Metric	572-590-10	SDV-4"F	0-4"/0-100mm	0.0005"/0.01mm	.001"/0.03mm						
	572-591-10	SDV-6"F	0-6"/0-150mm								
	572-592-10	SDV-8"F	0-8"/0-200mm								
	572-593-10	SDV-12"F	0-12"/0-300mm		.002"/0.04mm						
	572-594-10	SDV-18"F	0-18"/0-450mm								
	572-595-10	SDV-24"F	0-24"/0-600mm								
	572-596-10	SDV-32"F	0-32"/0-800mm		.0025"/0.06mm						
572-597-10	SDV-40"F	0-40"/0-1000mm	.0025"/0.07mm								

Note: Response speed is unlimited





## DIMENSIONS

Unit: mm

Type

Horizontal type example

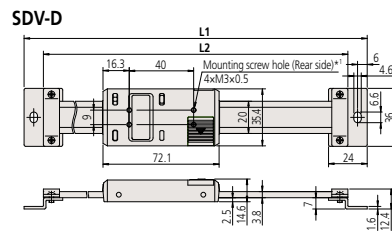
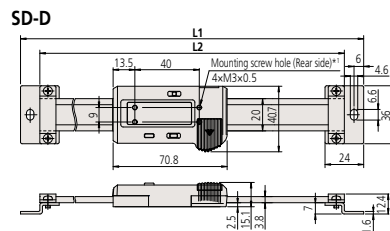
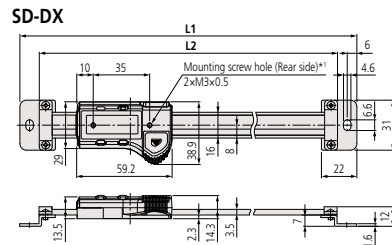
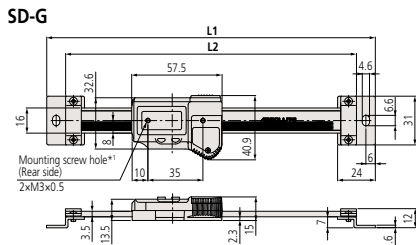

SD-E (to 300mm) / SD-F (to 300mm)

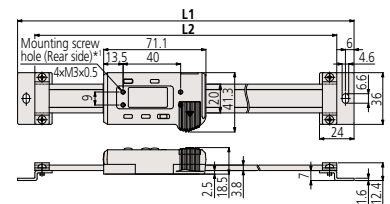

SD-E (450 to 1000mm) / SD-F (450 to 1000mm)

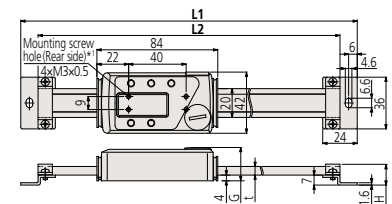

SDV-E (to 300mm) / SDV-F (to 300mm)

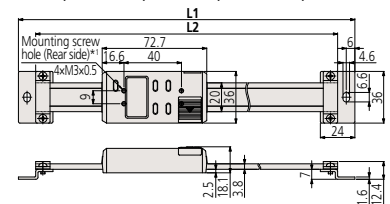

SDV-E (450 to 1000mm) / SDV-F (450 to 1000mm)

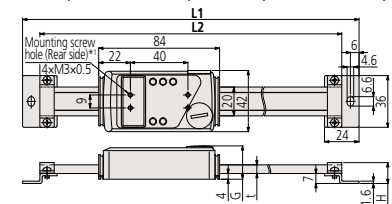

\*1: Inch/Metric models have 5-40 UNC threaded rear holes. Refer to the dimension table for details of the depth including the screw on the rear of the display.

Vertical type example



## SPECIFICATIONS

Model	Range (mm)	Dimensions(mm)					Depth including the screw on the rear of the display	Mass (g)	
		L1	L2	t	G	H			
SD-G	100	209	185	—	—	—	Less than 2mm	390	
	150	259	235	—	—	—		410	
	200	311	287	—	—	—		430	
SD-DX	100	209	185	—	—	—	Less than 2mm	230	
	150	259	235	—	—	—		250	
SD-30D	200	311	287	—	—	—	Less than 2mm	270	
	300	444	420	—	—	—		370	
SD-E SD-F	100	244	220	—	—	—	Less than 3mm	250	
	150	294	270	—	—	—		280	
	200	344	320	—	—	—		310	
	300	444	420	—	—	—		370	
	450	594	570	6	23.2	14.6		760	
	600	774	750	10	27.2	18.6		900	
SDV-D	800	974	950	—	—	—	Less than 2mm	1710	
	1000	1174	1150	—	—	—		2040	
	100	244	220	—	—	—		Less than 2mm	250
	150	294	270	—	—	—			280
200	344	320	—	—	—	310			
300	444	420	—	—	—	370			
SDV-E SDV-F	100	244	220	—	—	—	Less than 3mm	250	
	150	294	270	—	—	—		280	
	200	344	320	—	—	—		310	
	300	444	420	—	—	—		370	
	450	594	570	6	23.2	14.6		760	
	600	774	750	10	27.2	18.6		900	
	800	974	950	—	—	—		1710	
1000	1174	1150	—	—	—	2040			

# Quill Kit with ABSOLUTE Encoder

Easy Installation Fits Most Vertical Knee Mills

## FEATURES

- Easy to read LCD with resolution of .0005"/0.01mm. 0 -5" travel inch/mm
- Push button controls for inch/mm, zero-set and on/off.
- Powered by a single SR-44 battery which lasts about 1 year with normal use.
- SPC Output for data transmission to data processors or a remote display.

## SPECIFICATIONS

Order No.	Description
053906B	Digimatic Quill Kit complete with brackets & scale for Bridgeport-type machines.

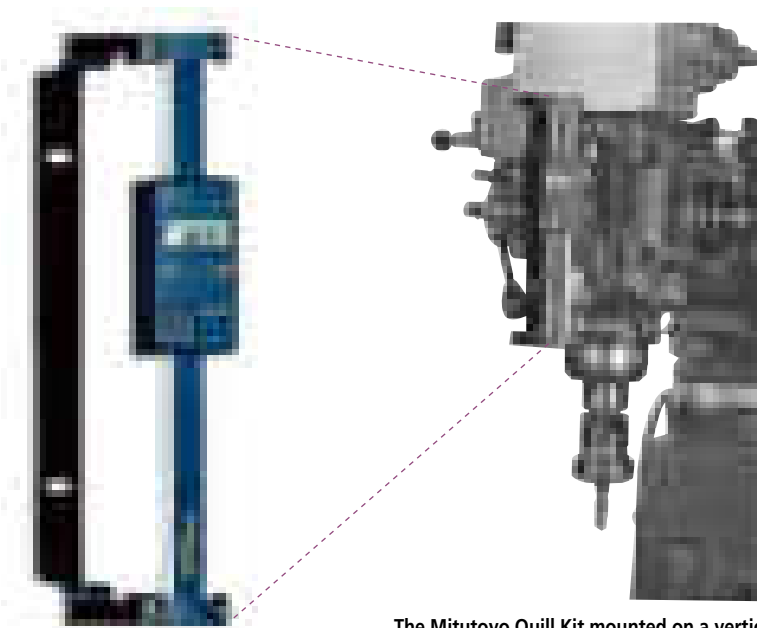

The Mitutoyo Quill Kit mounted on a vertical mill.

## Optional Accessories

- 905338: SPC cable (40" / 1m standard)
- 905409: SPC cable (80" / 2m standard)
- 264-504-5A: DP-1VR data processor, 120V AC
- 02AZD810D: U-Wave-R (wireless receiver)
- 02AZD730D: U-Wave-T/IP67 type (wireless transmitter)
- 02AZD790F: U-Wave connecting cable F
- 02AZE200: U-Wave-T installation brackets kit

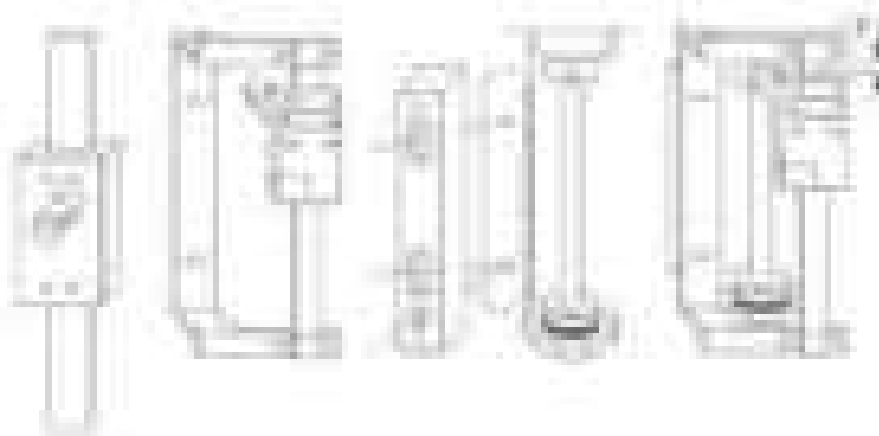

- High performance, low cost 2 & 3 axis counter
- Absolute and incremental modes (10 presets each)
- Non-linear and linear error compensation
- Adjustable high-brightness, high-refresh rate LED displays
- Calculator function
- Outputs data into spreadsheets (optional USB card)

### Optional Accessories

- 06AET993** Code out unit - USB output, RS232C output, Digimatic Input
- 06ACB393** Adapter for Linear gages with origin
- 06ACB913** Adapter for Linear gages without origin
- 06ACB391** Adapter for AT211 Linear Scales
- 06ACB392** Adapter for ST Series
- 09CAB231** Adapter for micrometer head
- 09AAA207** Adapter for previous model 6 pin linear scales
- 937179T** Foot switch to trigger USB output (06AET993 needed)
- 64AAB336** Foot switch to trigger RS-232C output (06AET993 needed)
- 06ACF941** Extension cable for remote load & zero (06AET993 needed)
- 965004** Foot switch to trigger RS-232C output (for 06ACF941 only)
- 937328** External load box (06AET993 & 06ACF941 needed)
- 936553** External zero box (06AET993 & 06ACF941 needed)
- 09EAA094** Counter cable RS232C for DP-1VR
- 64AAB519** RS232C output cable 6-ft. (25-9 pin)

- Counter designed to signal when a linear scale displacement value and a preset limit value coincide.
- Two types of limit settings are available: 2-step (**KLD-212**) and 4-step (**KLD-214**).

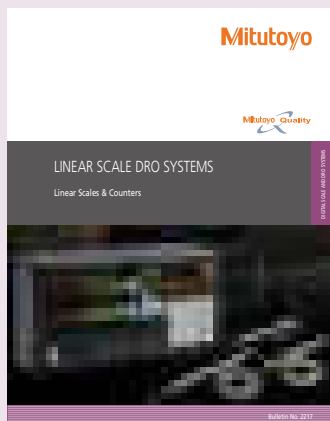

Refer to Bulletin No. (2217) for more details.

# KA-200 Counter

## SERIES 174 — Standard Type



174-183A

### DIMENSIONS

Unit: mm

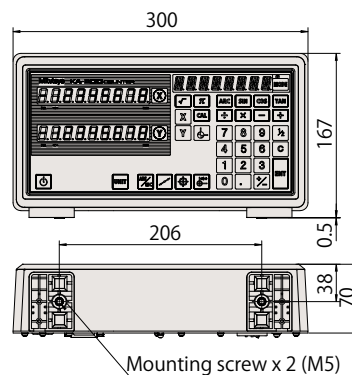

Mounting screw x 2 (M5)

### SPECIFICATIONS

Order No.	174-183A	174-185A
Model	2-axis KA-212 Counter	3-axis KA-213 Counter
Resolution	With AT100 Series: 0.05 - 0.0001 mm, .02" - .000005" With AT715: 0.01 - 0.0005 mm, .02" - .000020"	
Scale input ports	2 or 3*	
Display type / digit	7-segment, 8-digit + sign + 8-character alphabet LED display, 14.2mm character height	
Output (optional)	RS-232C / USB	
Macro functions	Rectangular drilling and round milling newly added	
Main features	Feed speed display; taper machining function; tool data; multi-point compensation; scale check function; calculation function	
Dimensions	Size (WxDxH) 30x168x70mm	

\*2nd and 3rd axis display can be disabled

### Standard Accessories

- Power cable
- Ground lead
- Dust cover
- Alternate button labels for lathe mode
- Connector cap (Dsub-15)
- User's manual
- Warranty card

# KLD200 Counter

## SERIES 174 — Special Purpose Type with Limit Signal Output

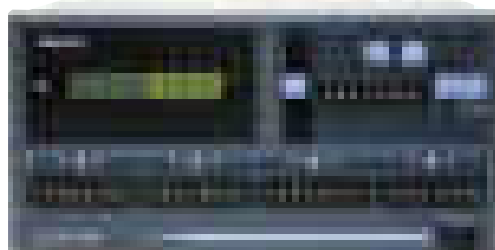

174-147A  
KLD-214

### SPECIFICATIONS

Order No.	174-146A	174-147A
Model	KLD-212	KLD-214
Number of axes to be displayed	1 axis	
Number of limit values to be set	2	4
Resolution	(Changeable according to the parameter) When <b>AT100</b> series is connected: 0.05 to 0.0001mm When <b>AT715</b> is connected: 0.01 to 0.001mm	
Output	RS-232C (provided as standard)	
Display	7-segment LCD/ 7 digit*1	
Power supply voltage	120V AC, 60Hz	
Power consumption	25 VA	
Operating temperature/humidity range	0 to 45°C/ 20 to 80%	
Dimensions	13.1"(W)x6.42"(D)x8.1"(H) / 332 (W)x163 (D)x204 (H) mm	
Mass	6.62 lb. / 3.0kg	6.84 lb. / 3.1kg

\*1: Count range when the minimum reading is 0.001mm: 99999.999 to -9999.999  
Count range when the minimum reading is 0.005mm: 99999.995 to -9999.995

# Linear Scale Counter

## FUNCTIONS

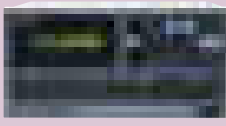
Function	Counter	KA-200 Counter	KLD-200 Counter
			
Zero-setting	ZERO	●	●
Preset	P.SET	●	●
Resolution setting	0.0008 / 0.2	●	●
Measurement direction setting	← / →	●	●
mm/inch conversion	mm / in	●	●
Diameter display	DIA	●	●
Scale reference point setting <sup>1</sup>	▼ Scr	●	●
1/2 calculation	1/2	●	●
Coordinate system switching	N	●	—
Bolt-hole circle machining	⊕	● <sup>2</sup>	—
Pitch machining	↔	●	—
Zero approach machining (INC mode)	⊕	●	—
Addition of 2-scale data	Z1+Z2	● <sup>3</sup>	—
Linearity error compensation	↔	●	●
Pitch error compensation	↔	● <sup>1</sup>	—
Smoothing	1234	●	●
Memory backup	🔋	●	●
Expansion/contraction coefficient setting	↔	—	●
Lower digit blanking out	123	●	●
External zero-setting	ZERO SET INPUT	▲ <sup>4</sup>	●
RS-232C interface unit	RS-232C OUTPUT	▲ <sup>4</sup>	●
USB output	USB	▲ <sup>5</sup>	—
Limit signal output	LIMIT OUTPUT	—	●
Error message	Error	●	●

● Standard function, ▲: Optional function, —: Not available  
<sup>1</sup>: Only available when connecting with AT100 series.

<sup>2</sup>: Not available in single-axis use

<sup>3</sup>: Only available for 3-axis model

<sup>4</sup>: Code out unit (06AET993) is required.

<sup>5</sup>: Text can be output by interface unit and foot switch

## Adapter Cross Reference

(For adapting old linear scales to new counters, or new linear scales to old counters)

	Linear Scale Series No's.	Adapter No.	Counters
Old linear scales with 6 pin round connectors	FOR AT2-N, AT2, AT-11N, AT11, AT12N (529 Series)	09AAA207	All KA, KS, KC, UDR Series Counters with 15 pin connectors. (All 174 Series)
New linear scales w/15 pin D-Sub connectors	FOR AT102, AT103, AT111, AT112, AT113, AT115, AT116, AT181	09AAA181	For all .0001" resolution counters with seven pin round connectors
		09AAA181V*	APL Counter 164-660*, 164-661*, 164-662* MPK-2L 983-352
		09AAA198	For all .0005" resolution counters with six pin round connectors
		09AAA198V*	APL Counter 164-660*, 164-661*, 164-662*, 164-563*, 164-664*, 164-665* PL and PL Zero Output Counter 164-252A, 164-254A, 164-295A

\* V = Vertical type

When only replacing one linear scale, you can use either horizontal or vertical type adapter.

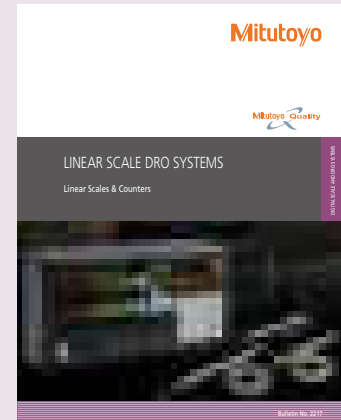

Refer to Bulletin No. (2217) for more details.

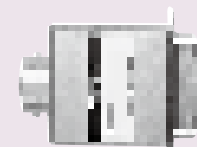

09AAA207

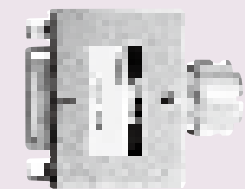

09AAA198

# Digital Readout/DRO packages 2-Axis/3-Axis Travels

For Milling, Lathes & Surface Grinding Systems

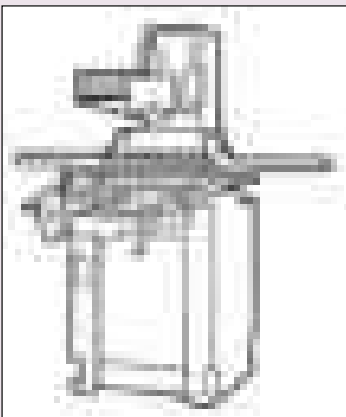
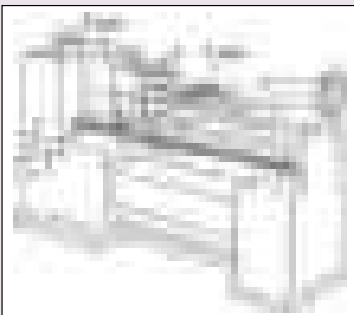
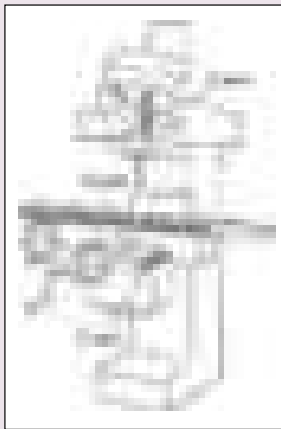
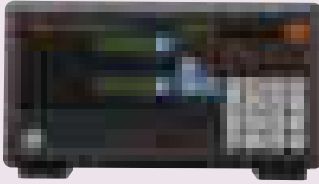

## 2-Axis, KA Counter Milling System

### Package includes:

- KA-200 counter
- AT715 electromagnetic absolute linear scales
- Brackets for linear scales
- Display arm kit



X Axis Travel (AT715 Slim Electromagnetic)	Y Axis Travel (AT715 Slim Electromagnetic)			
	12" (539-805)	14" (539-806)	16" (539-807)	18" (539-808)
30" (539-814)	<b>64PKA058A</b>	<b>64PKA060A</b>	-	-
36" (539-816)	<b>64PKA059A</b>	-	<b>64PKA062A</b>	-
40" (539-817)	-	<b>64PKA061A</b>	<b>64PKA063A</b>	<b>64PKA064A</b>

## 3-Axis Milling Package (Z Axis: 6" Travel AT715)

Order No.	Description
<b>64PKA065A</b>	MILL pkg, 3-axis, ABS Scales, 12" x 30" x 6", w/3 axis KA Counter (174-185A)
<b>64PKA066A</b>	MILL pkg, 3-axis, ABS Scales, 12" x 36" x 6", w/3 axis KA Counter (174-185A)
<b>64PKA067A</b>	MILL pkg, 3-axis, ABS Scales, 16" x 36" x 6", w/3 axis KA Counter (174-185A)

## 2-Axis Lathe Package

### Package includes:

- KA-200 counter
- AT116 and AT715 linear scale combinations (with cables)
- Mounting bracket kit
- Counter tray
- Additional extension cable (2m) included in 60" and 72" packages

Z-axis travel	X Axis Travel (AT116 Slim Glass Scale)					
	6"(539-272-30)	8"(539-273-30)	10"(539-274-30)	12"(539-275-30)	14"(539-276-30)	16"(539-277-30)
28" (539-813)	<b>64PKA035A</b>	-	-	-	-	-
30" (539-814)	<b>64PKA036A</b>	-	-	-	-	-
36" (539-816)	<b>64PKA037A</b>	-	-	-	-	-
40" (539-817)	<b>64PKA038A</b>	<b>64PKA039A</b>	<b>64PKA042A</b>	<b>64PKA046A</b>	<b>64PKA052A</b>	-
44" (539-818)	-	<b>64PKA040A</b>	<b>64PKA043A</b>	<b>64PKA047A</b>	<b>64PKA053A</b>	-
48" (539-819)	-	<b>64PKA041A</b>	<b>64PKA044A</b>	<b>64PKA048A</b>	<b>64PKA054A</b>	-
52" (539-820)	-	-	-	<b>64PKA049A</b>	<b>64PKA055A</b>	-
60" (539-822)	-	-	<b>64PKA045A</b>	<b>64PKA050A</b>	<b>64PKA056A</b>	<b>64PKA057A</b>
72" (539-825)	-	-	-	<b>64PKA051A</b>	-	-

## 2-Axis, KA Counter Grinder System

### Package includes:

- KA-200 counter
- AT116 glass linear scales
- Mounting bracket kit
- Display arm kit

Vertical	Cross Side (AT116 Slim Glass Scale)			
	6" (539-272-30)	8" (539-273-30)	10" (539-274-30)	12" (539-275-30)
12" (539-275-30)	<b>64PKA026A</b>	<b>64PKA028A</b>	-	-
14" (539-276-30)	<b>64PKA027A</b>	<b>64PKA029A</b>	-	-
16" (539-277-30)	-	<b>64PKA030A</b>	-	-
18" (539-278-30)	-	-	<b>64PKA031A</b>	<b>64PKA033A</b>
20" (539-279-30)	-	-	-	<b>64PKA034A</b>
24" (539-281-30)	-	-	<b>64PKA032A</b>	-

# Linear Scales

## Linear Scale System Diagram

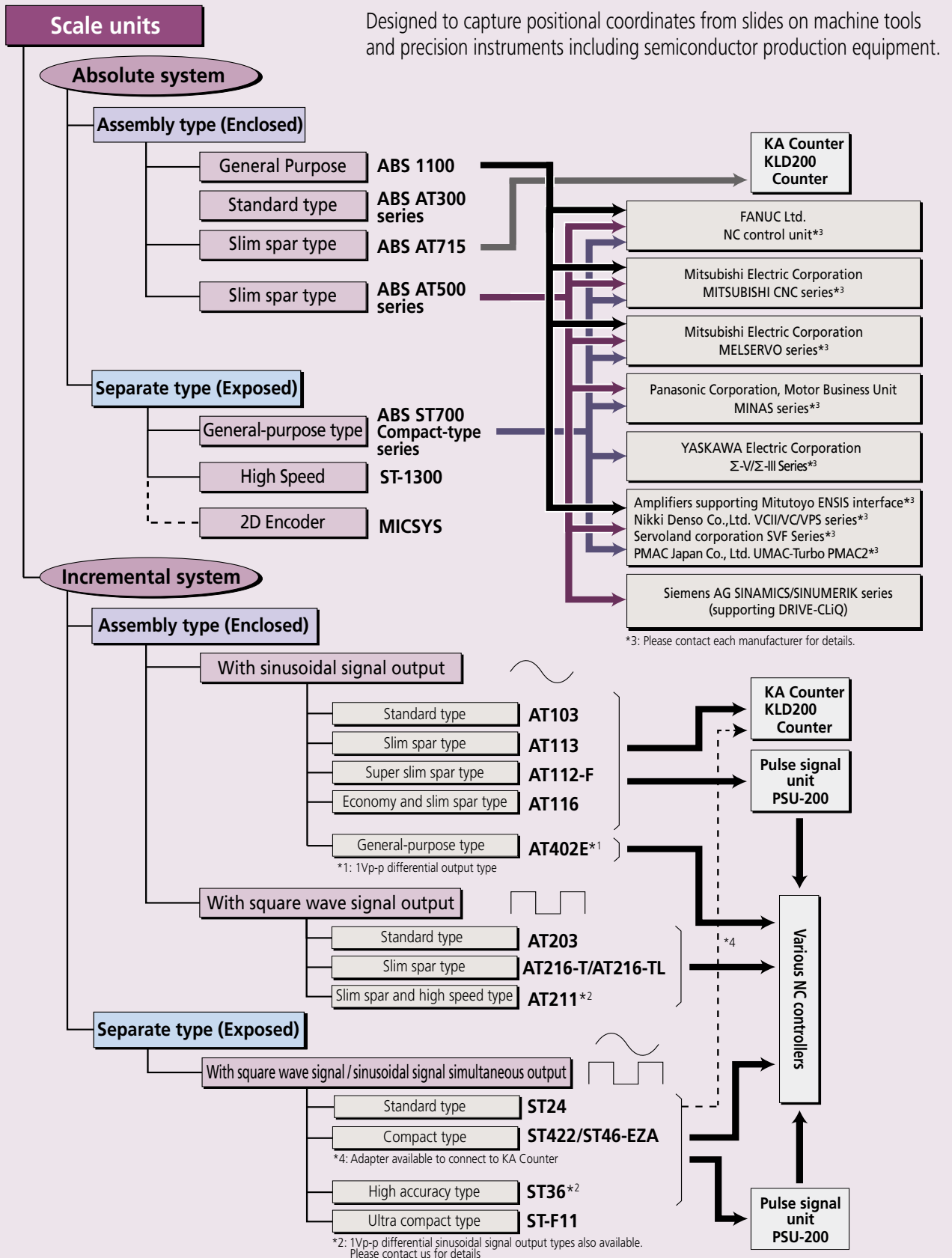

Name	Type	Page
AT1100	General-purpose Spar	H-12
AT300	Standard Spar	H-13
AT-715	Slim Spar (IP67)	H-14
AT500	Slim Spar	H-15
ABS ST700	General Purpose Compact type (Exposed)	H-16
ST1300	High Seep High Accuracy (Exposed)	H-17
MICSYS	2D Image Encoder (Exposed)	H-18
AT103	Standard	H-19
AT113	Slim Spar type	H-20
AT112-F	Super Slim part type	H-21
AT116	Economy and Slim Spar	H-22
AT402E	General-purpose	H-23
AT203	Standard type	H-24
AT216T/AT217-TL	Slim Spar	H-25
AT211	Slim spar type high speed	H-26
ST24	Standard Type (Exposed)	H-27
ST422/ST46-EZA	Compact type (Exposed)	H-28-29
ST36	High Accuracy type (Exposed)	H-30
ST-F11	Ultra Compact-Fiber scale (Exposed)	H-31-32

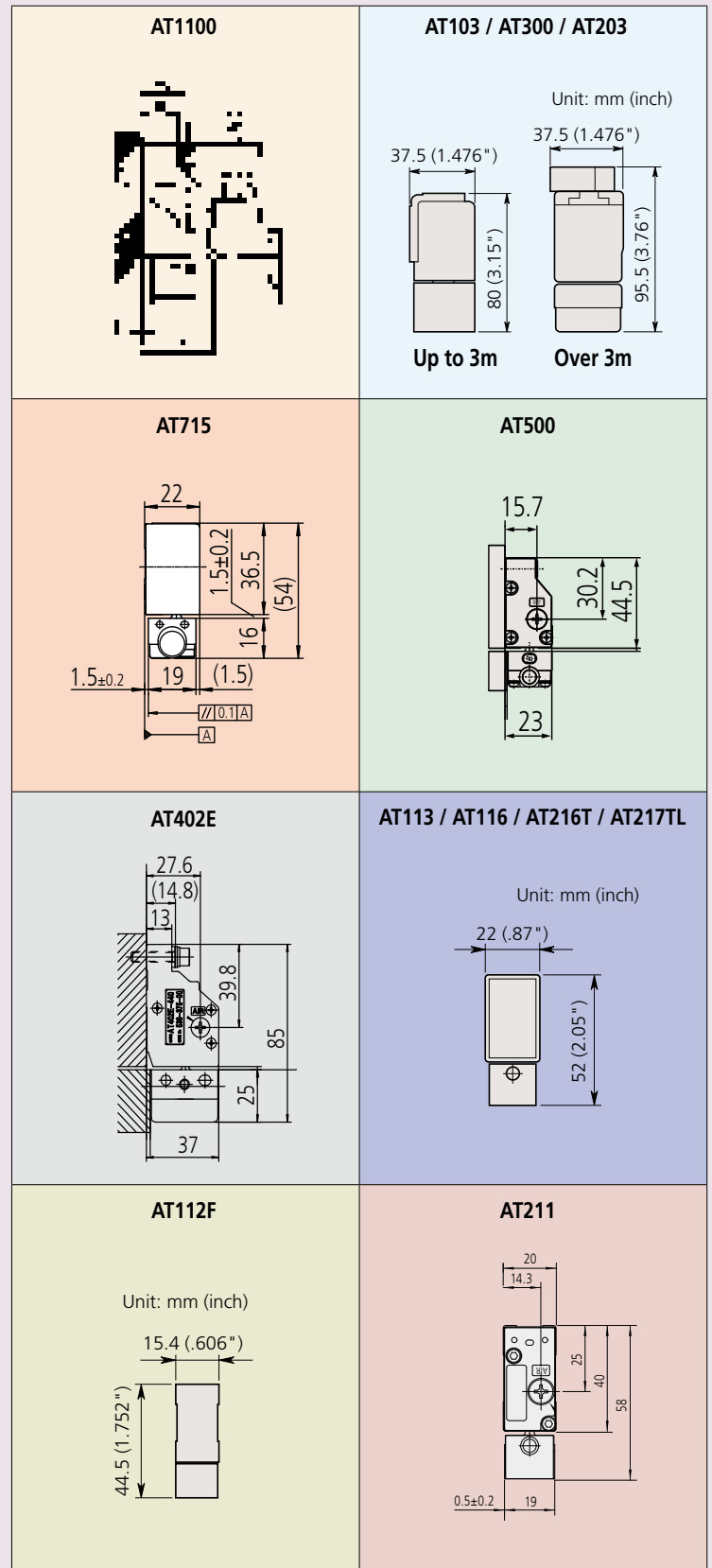

# Linear Scales ABS AT1100

**SERIES 539 — General Mount Type, robust dustproof / waterproof structure**



**ABSOLUTE™**

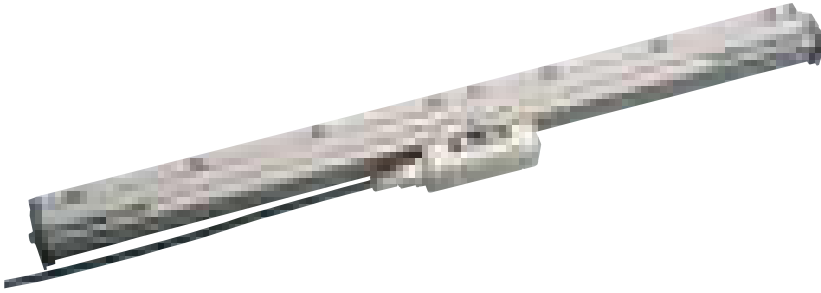

## SPECIFICATIONS

Model	ABS AT1100
Detection method	Electromagnetic induction
Maximum effective range	3040mm
Resolution	0.05μm
Accuracy (at 20 °C)	(3+5L/1000)μm L= 140 to 2040mm (5+5L/1000)μm L= 2240 to 3040mm
Maximum response speed	3 m/s
Cross-section size	85x37 (mm)
Thermal expansion coefficient	≈ 8±1.5x10 <sup>-6</sup> / K
Vibration resistance (at 55 to 2000Hz)	20g
Impact resistance (at 11ms, 1/2sin)	35g L=140 to 2040mm 30g L=2240 to 3040mm
Compatible interfaces *1	FANUC Corporation's Serial α Interface (AT1153) Mitsubishi Electric Corporation's High-speed Serial Interface (AT1143)

\*1: For details about connection of any applicable system, please be sure to contact each manufacturer for confirmation.

- Electromagnetic induction principle means scales are unaffected by most contamination.
- Absolute scales have eliminated the need for origin restoration and drastically reduced power consumption.
- Drawings are available on request.

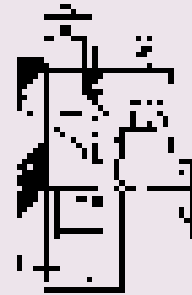

AT1100 Mounting Dimensions						
FANUC		Mitsubishi		Siemens		Effective Range (mm)
Order No.	Model	Order No.	Model	Order No.	Model	
559-100-53	AT1153-140	559-100-43	AT1143-140	559-100-23	AT1123-140	140
559-101-53	AT1153-240	559-101-43	AT1143-240	559-101-23	AT1123-240	240
559-102-53	AT1153-340	559-102-43	AT1143-340	559-102-23	AT1123-340	340
559-103-53	AT1153-440	559-103-43	AT1143-440	559-103-23	AT1123-440	440
559-104-53	AT1153-540	559-104-43	AT1143-540	559-104-23	AT1123-540	540
559-105-53	AT1153-640	559-105-43	AT1143-640	559-105-23	AT1123-640	640
559-106-53	AT1153-740	559-106-43	AT1143-740	559-106-23	AT1123-740	740
559-107-53	AT1153-840	559-107-43	AT1143-840	559-107-23	AT1123-840	840
559-108-53	AT1153-940	559-108-43	AT1143-940	559-108-23	AT1123-940	940
559-109-53	AT1153-1040	559-109-43	AT1143-1040	559-109-23	AT1123-1040	1040
559-110-53	AT1153-1140	559-110-43	AT1143-1140	559-110-23	AT1123-1140	1140
559-111-53	AT1153-1240	559-111-43	AT1143-1240	559-111-23	AT1123-1240	1240
559-112-53	AT1153-1340	559-112-43	AT1143-1340	559-112-23	AT1123-1340	1340
559-113-53	AT1153-1440	559-113-43	AT1143-1440	559-113-23	AT1123-1440	1440
559-114-53	AT1153-1540	559-114-43	AT1143-1540	559-114-23	AT1123-1540	1540
559-115-53	AT1153-1640	559-115-43	AT1143-1640	559-115-23	AT1123-1640	1640
559-116-53	AT1153-1740	559-116-43	AT1143-1740	559-116-23	AT1123-1740	1740
559-117-53	AT1153-1840	559-117-43	AT1143-1840	559-117-23	AT1123-1840	1840
559-118-53	AT1153-2040	559-118-43	AT1143-2040	559-118-23	AT1123-2040	2040
559-119-53	AT1153-2240	559-119-43	AT1143-2240	559-119-23	AT1123-2240	2240
559-120-53	AT1153-2440	559-120-43	AT1143-2440	559-120-23	AT1123-2440	2440
559-121-53	AT1153-2640	559-121-43	AT1143-2640	559-121-23	AT1123-2640	2640
559-122-53	AT1153-2840	559-122-43	AT1143-2840	559-122-23	AT1123-2840	2840
559-123-53	AT1153-3040	559-123-43	AT1143-3040	559-123-23	AT1123-3040	3040





**ABSOLUTE™**

# Linear Scales ABS AT300

SERIES 539 — Standard Type

- ABSOLUTE linear encoder incorporates both our unique electrostatic capacity and photoelectric technology.
- \* Refer to page H-34 "Quick Guide to Precision Measuring Instruments" for details of the principle of the absolute linear scale.
- Drastically reduced power consumption since there are no backup batteries.
- Easy operation because no recalibration is required at startup or after a power failure.
- Suitable for position feedback in machinery requiring high-accuracy, high-speed control.
- Improved environmental resistance against mechanical vibration and noise.



## SPECIFICATIONS

Model	ABS AT353	ABS AT343	ABS AT343A	ABS AT303	ABS AT303A
Applicable system	FANUC Ltd. NC Control unit	Mitsubishi Electric Corporation MITSUBISHI CNC series	Mitsubishi Electric Corporation MR-J3	Amplifiers supporting Mitutoyo ENSIS interface	
Resolution	0.05µm				
Maximum response speed	120m/min				
Effective range	4 to 120* / 100 to 3000mm				
Accuracy (20°C)*	(3+3L <sub>o</sub> /1000)µm, (5+5L <sub>o</sub> /1000)µm when the effective range is 1600mm or more				
Protection level	IP53				

\* The indication accuracy does not include quantizing error. L<sub>o</sub>: Effective range (mm)

\* A wide variety of special orders are available.

## Dimensions

Effective range L <sub>o</sub> (mm)	Maximum travel length L <sub>t</sub> (mm)	Overall length L <sub>z</sub> (mm)	Mounting block pitch		No. of mounting blocks
			L <sub>3</sub> (mm)	L <sub>4</sub> (mm)	
100	120	230	65	100	2
150	170	280	65	150	
200	220	330	65	200	
250	270	380	65	250	
300	330	440	220	150	
350	380	490	245	175	
400	430	540	270	200	3
450	480	590	295	225	
500	540	650	325	250	
600	650	760	380	300	
700	760	870	435	350	
750	810	920	460	375	
800	860	970	485	400	5
900	960	1070	535	450	
1000	1060	1170	585	500	

Effective range L <sub>o</sub> (mm)	Maximum travel length L <sub>t</sub> (mm)	Overall length L <sub>z</sub> (mm)	Mounting block pitch		No. of mounting blocks
			L <sub>3</sub> (mm)	L <sub>4</sub> (mm)	
1100	1160	1270	635	275	7
1200	1260	1370	685	300	
1300	1360	1470	735	325	
1400	1460	1570	785	350	
1500	1560	1670	835	375	
1600	1690	1800	900	400	
1700	1790	1900	950	425	9
1800	1890	2000	1000	450	
2000	2100	2210	1105	335	
2200	2300	2410	1205	370	
2400	2500	2610	1305	400	
2500	2600	2710	1355	315	
2600	2700	2810	1405	325	9
2800	2900	3010	1505	350	
3000	3050	3210	1605	375	

## Mounting dimensions [ABS AT353/AT343(A)/AT303(A)]

### • Effective range 100 mm to 250mm

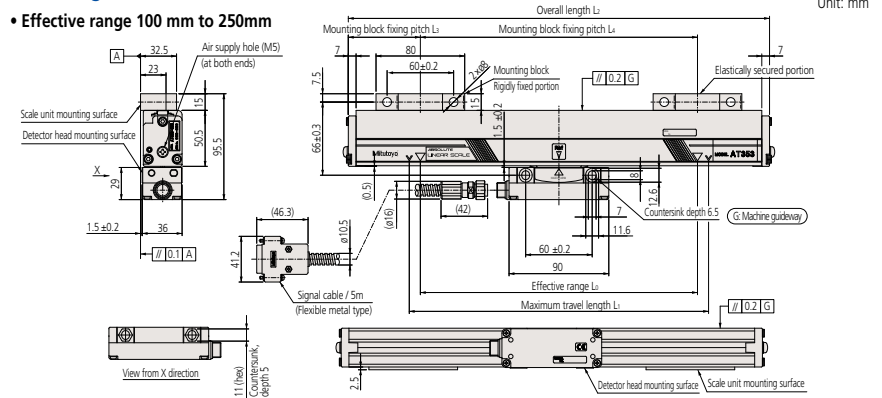

### • ABS AT343A signal cable

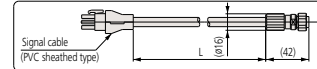

\* The signal cable has set options.  
(Part No.098AA598A - C: 0.2m, 2m, 3m)

### • Effective range 300mm to 3000mm

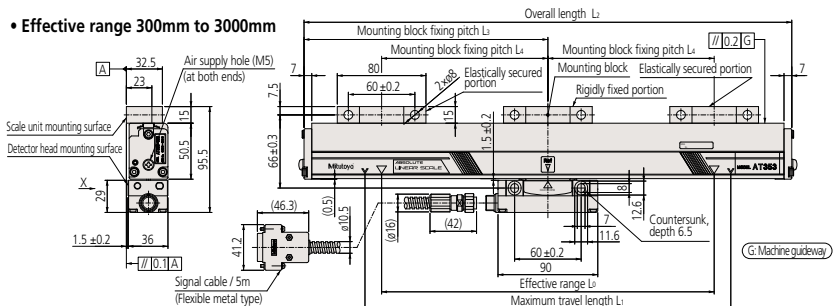

# Linear Scales ABS AT715

SERIES 539 — Slim Spar Type



## SPECIFICATIONS

Model	ABS AT715	
Detection method	Electromagnetic induction	
Resolution	.000020" - .001" (0.0005mm to 0.01mm) (on the KA/KLD200 counter)	
Effective range	100 to 3000mm	
Accuracy (20°C)	±5µm (Lo: 100 to 500mm), ±7µm (Lo: 600 to 1800mm), ±10µm (Lo: 2000 to 3000mm) Lo: Effective range (mm)	
Maximum response speed	50m/min	
Protection level	IP67	
Sliding force	5N or less	
Signal cable	Standard accessory Refer to the dimension table shown below for the length.	
Extension cable (optional)	Length	Order No.
	2m	09AAB674A
	5m	09AAB674B
7m	09AAB674C	
Connectable counter	KA Counter/ KLD200 Counter	

AT715		Effective range Lo inch/mm	Signal cable length (m)
Order No.	Model		
539-801	ABS AT715-100	4" /100mm	3.5
539-802	ABS AT715-150	6" /150mm	
539-803	ABS AT715-200	8" /200mm	
539-804	ABS AT715-250	10" /250mm	
539-805	ABS AT715-300	12" /300mm	
539-806	ABS AT715-350	14" /350mm	
539-807	ABS AT715-400	16" /400mm	
539-808	ABS AT715-450	18" /450mm	
539-809	ABS AT715-500	20" /500mm	
539-811	ABS AT715-600	24" /600mm	
539-813	ABS AT715-700	28" /700mm	
539-814	ABS AT715-750	30" /750mm	5
539-815	ABS AT715-800	32" /800mm	
539-816	ABS AT715-900	36" /900mm	
539-817	ABS AT715-1000	40" /1000mm	
539-818	ABS AT715-1100	44" /1100mm	
539-819	ABS AT715-1200	48" /1200mm	
539-820	ABS AT715-1300	52" /1300mm	
539-821	ABS AT715-1400	56" /1400mm	
539-822	ABS AT715-1500	60" /1500mm	
539-823	ABS AT715-1600	64" /1600mm	
539-824	ABS AT715-1700	68" /1700mm	
539-825	ABS AT715-1800	72" /1800mm	7*1
539-860	ABS AT715-2000	80" /2000mm	
539-861	ABS AT715-2200	88" /2200mm	
539-862	ABS AT715-2400	96" /2400mm	
539-863	ABS AT715-2500	100" /2500mm	
539-864	ABS AT715-2600	104" /2600mm	
539-865	ABS AT715-2800	112" /2800mm	
539-866	ABS AT715-3000	120" /3000mm	

\*1: Combination of a 5m signal cable and a 2m extension cable

ABSOLUTE™



- Electromagnetic induction principle means scales are unaffected by contamination.
- Absolute scales have eliminated the need for origin restoration and drastically reduced power consumption.
- Suitable for milling machines, XY tables, jigs, etc.

## Optional Accessories

- 09AAB674A Extension cable 2m
- 09AAB674B Extension cable 5m
- 09AAB674C Extension cable 7m
- 174-183A 2-Axis KA Counter
- 174-185A 3-Axis KA Counter



174-183A

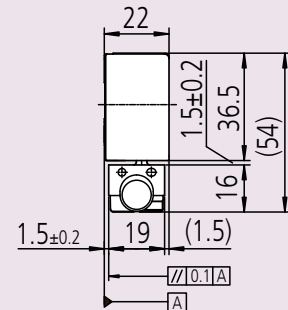



# Linear Scales ABS AT500

## SERIES 539 — Slim Spar Type

- Slim shape is suitable for space-saving designs.
- The high-rigidity **ABS AT500-S** series has vibration resistance, shock resistance and temperature control. The **ABS AT500-H** series offers excellent temperature control and high accuracy.
- Scale alarm display LED allows for easy maintenance.
- Supports the interfaces of various manufacturers, allowing a variety of system configurations.

### SC Type

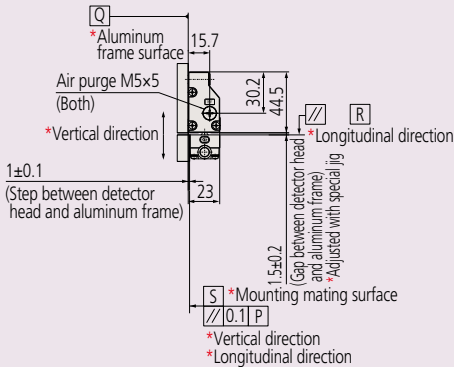

### SPECIFICATIONS

	High-rigidity type	High-accuracy type	
Model	ABS AT500-SC	ABS AT500-HC	ABS AT500-HL/HR
Resolution	0.005μm*1/0.05μm		
Maximum response speed	150m/min (72m/min for the H series whose resolution is 0.005μm)		
Effective range	100 to 2200mm	100 to 1000mm	100 to 350mm
Accuracy (20°C)*2	(3+3L <sub>a</sub> /1000)μm		(2+2L <sub>a</sub> /1000)μm
Reference point of expansion influenced by the temperature fluctuation	Center of the effective measuring length		Edge of the effective measuring length HL: "+" side of the absolute value HR: "-" side of the absolute value
Protection level	IP53		

\*1: The exact value is 0.0048828125μm since the 20μm signal is divided by 4096.

### Meaning of Model No.

ABS AT5□□□ - □□□ - □□

Resolution/Applicable system

Effective range

Model	Resolution	Applicable system
ABS AT553	0.05μm	FANUC Ltd.
ABS AT555	0.005μm	NC Control unit
ABS AT543	0.05μm	Mitsubishi Electric Corporation MITSUBISHI CNC series
ABS AT545	0.005μm	Mitsubishi Electric Corporation MITSUBISHI CNC series
ABS AT543A	0.05μm	Mitsubishi Electric Corporation MELSERVO series
ABS AT545A	0.005μm	Mitsubishi Electric Corporation MELSERVO series
ABS AT573A	0.05μm	Panasonic Corporation, Motor Business Unit MINAS series*1
ABS AT503	0.05μm	Amplifiers supporting Mitutoyo ENSIS interface*1 (Nikki Denso Co., Ltd., Servoland corporation, PMAC Japan Co., Ltd.)
ABS AT503A	0.05μm	
ABS AT505	0.005μm	
ABS AT505A	0.005μm	
ABS AT524	0.01μm	Siemens AG SINAMICS/SINUMERIK series (supporting DRIVE-CLiQ)
ABS AT527	0.001μm	

Reference point of expansion on the scale unit influenced by temperature fluctuation\*  
C: Center of the effective range  
L: "+" side of the absolute value  
R: "-" side of the absolute value  
\* "L" or "R" is marked only for the high accuracy type.

Type of the scale unit  
S: High rigidity type  
H: High accuracy type  
Note: "Reference point of expansion"  
The scale unit expands or contracts influenced by the temperature fluctuation.  
The mechanical reference point of expansion is defined as the reference point.

\*ABS AT5□□□

Transmission method  
Nothing: Full duplex communication  
A: Half-duplex communication

\*1: Please contact each manufacturer for details.

# Linear Scales ABS ST700

SERIES 579 — General-purpose Type

ABSOLUTE™

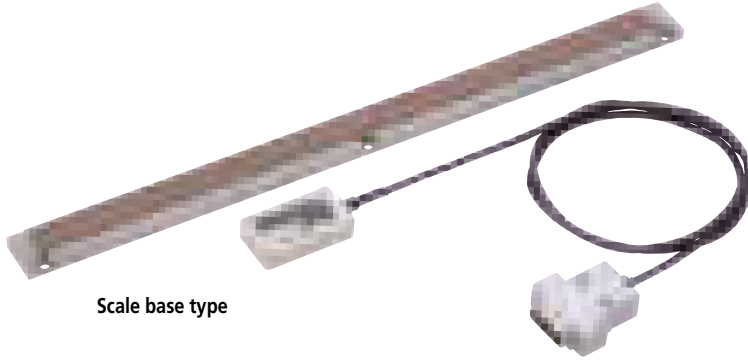

Scale base type

## SPECIFICATIONS

Model	ABS ST700
Scale type	Scale base type
Resolution	0.1μm (0.05μm to special order)
Detection method	Electromagnetic induction ABS linear encoder
Max. effective range	6000mm
Accuracy (20°C)	5+(5L/1000)μm L: Effective range (mm)
Maximum response speed	5m/s
Linear expansion coefficient	(12.0±1.5)×10 <sup>-6</sup> /°C (When the material of the mounting components is steel or equivalent.)
Power supply voltage	5V±10% (at the detection head) (Ripple + spike noise component should be less than 100mV.)
Operating temperature/humidity range	0 to 50°C, RH 20 to 80%
Storage temperature/humidity range	-20 to 70°C, RH 20 to 80%

- Absolute measurement with exposed scales.
- Non-contact detection is optimal for high-speed and high-acceleration devices such as linear motors.
- Electromagnetic induction principle means scales are unaffected by water and oil contamination.
- The detector head is approximately 1/3 the previous model size: 50mm (W) × 28mm (D) × 11mm (H).
- Cable outlets can be in four directions, with mounting holes on the top and sides.
- Accuracy (5+5L/1000)μm, glass scale: (3+3L/1000)μm (previous models: (8+5L/1000)μm) L: Effective range (mm).
- Compatible with servo amplifiers from a range of companies (high-speed serial interfaces).
- Signal adjustment at installation is automatically performed with dedicated software.

## Meaning of Model No.

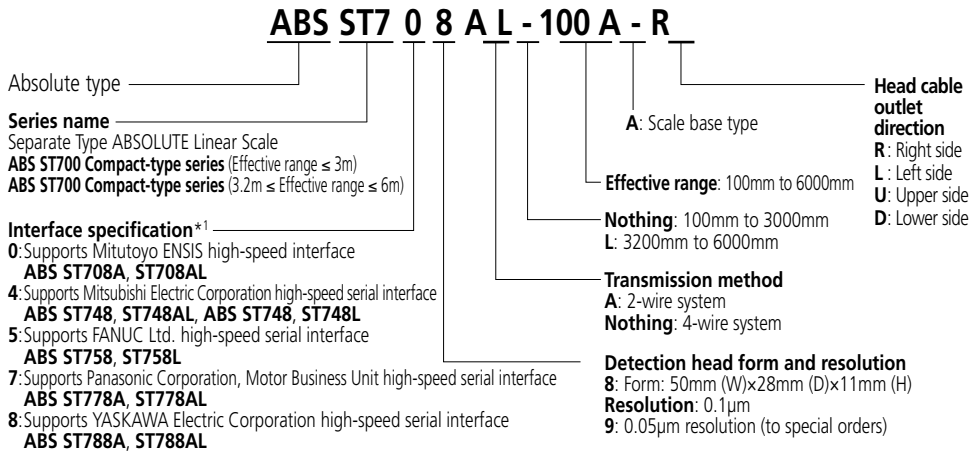

## Feedback cable

- Yaskawa Electric Corporation serial cable can be used as the feedback cable to connect to a Yaskawa Electric Corporation servo amplifier.  
Cable model number : JZSP-CLP- (03, 05, 10, 15, 20)
- For the feedback cable to connect to a Mitsubishi Electric Corporation MR-J2S/MR-J3, contact Mitutoyo with the following code numbers.  
For the MR-J2S 5m : No.06ACF116A  
10m : No.06ACF116B  
For the MR-J3 5m : No.06ACF117A  
10m : No.06ACF117B

## Available Interfaces\*1

FANUC Ltd. FS-i Series, Power Mate i Series
Mitsubishi Electric Corporation MELSERVO MR-J4/MR-J3 Series
Mitsubishi Electric Corporation CNC Series, MDS-D/MDS-DH Series
YASKAWA Electric Corporation Σ-V,Σ-III Series
Panasonic Corporation, Motor Business Unit MINAS-A5, A5L, A5N, A5NL, MINAS-A4, A4P, A4N, A4NL Series
Mitutoyo ENSIS*2
Nikki Denso Co.,Ltd. VCI/VC/PS series
Servoland Corporation SVF Series
PMAC Japan Co. Ltd. UMAC-Turbo PMAC2

\*1 Be sure to contact each manufacturer for details of the applicable systems (availability of connection).

\*2 ENSIS is a registered trademark of Mitutoyo Corporation.

# Linear Scale ABS ST1300

## SERIES 579 — High-speed, High-resolution Absolute Tape Scale

- 12m maximum effective length, 8-m/s max. response speed and 1nm minimum resolution.
- Extensive interface compatibility. See specifications below.
- Outstanding robustness against contamination compared to earlier photoelectric types by using a new detection principle.
- Choice between double-sided tape and tension mounting methods.
- Signal validation program facilitates mounting adjustment and maintenance.
- Applicable Interfaces: FANUC; Mitsubishi Electric; Yaskawa Electric; Panasonic; Mitutoyo ENSIS standard interface

- Any scale size drawings are available on request.

Double-end tension version



Double-sided adhesive mounting version

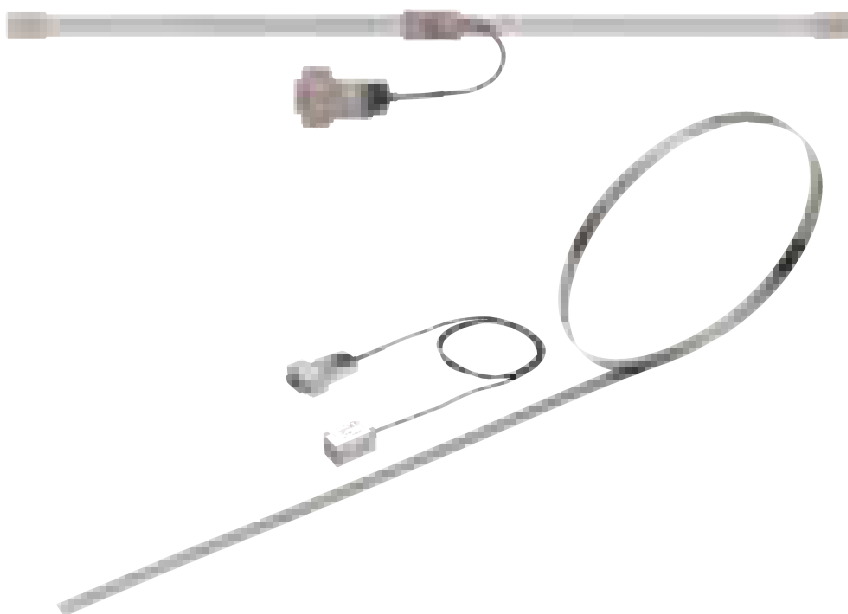

### SPECIFICATIONS

Model	ABS ST1300
Range	max. 12 m
Accuracy	10 μm/m (± 5μm)
Max. Response Speed	8 m/s (Varies according to the interface)
Min. Resolution	1 nm / 10 nm
Scale Specifications	Metal tape
Applicable Interfaces	FANUC; Mitsubishi Electric; Yaskawa Electric; Panasonic; Mitutoyo ENSIS standard Interface

# MICSYS

## SERIES 549 High-accuracy, Non-contact 2D Encoder

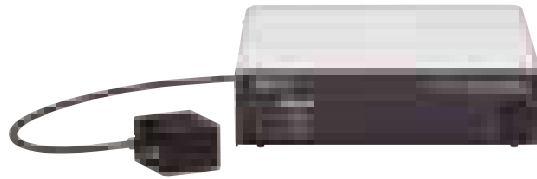

### SPECIFICATIONS

Order No.	549-701A
Model	MICSYS-SA1
Detection method	Laser speckle image correlation
Effective range	±100μm (2D)
Resolution	1 nm
Accuracy (20°C)	±100 nm
Data update period	20Hz

### Applications

#### 1. Evaluation of stages used in manufacturing equipment and inspection systems

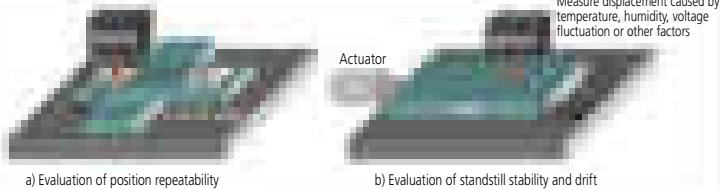

#### 2. Highly accurate positioning of workpieces

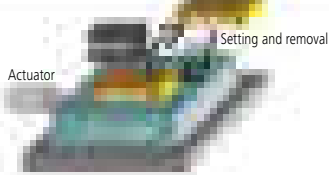

#### 3. Measurement of minute displacement

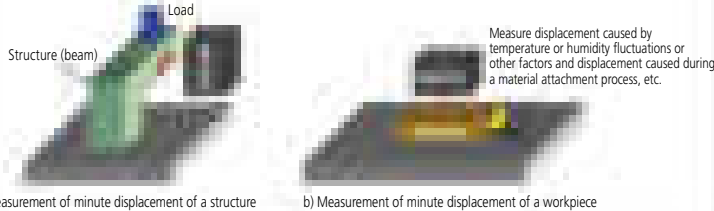

### FEATURES

- Simultaneous, non-contact measurement of X-Y position.
- Nano-resolution measurement.
- Suitable for applications such as stage position repeatability, strain measurement, deflection measurement, etc.
- Applies the image correlation of a speckle pattern.
- No scales needed—can detect on any optically rough surface.
- Detector can be completely removed from surface and replaced to continue reading.
- Drawings are available on request.

### DIMENSIONS

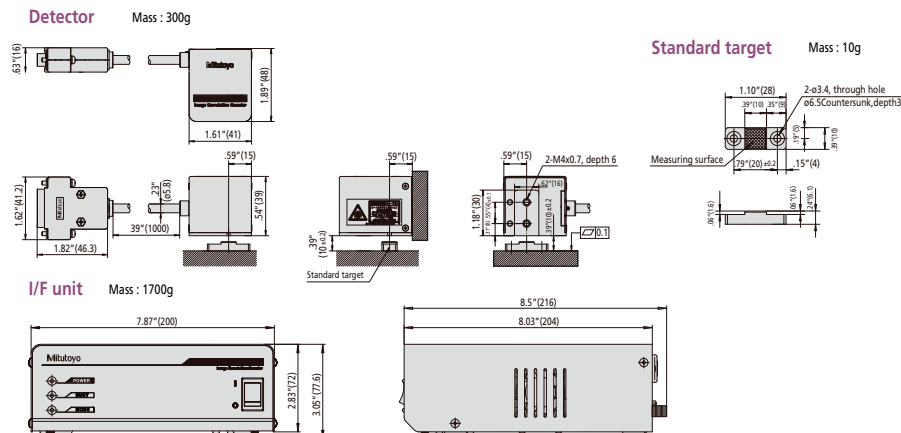



# Linear Scales AT103

SERIES 539 — Standard Type

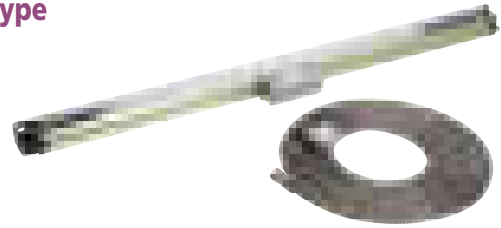

## FEATURES

- Enhanced vibration-resistance and durability.
- The innovative rubber lips keep out contaminants.
- An armored signal cable is used to connect the scale unit to the DRO counter for safe operation in harsh shop environments.
- The signal cable outlet can be positioned on either side of the detector head, allowing the signal cable to be connected from either direction.
- A wide variety of measuring ranges are available in this standard type scale unit.
- Connectable to the **KA** counter, **KLD** counter, or **PSU-200**.

### Optional Accessories

- 09AAA033A:** Extension cable (80" / 2m)
- 09AAA033B:** Extension cable (200" / 5m)
- 09AAA033C:** Extension cable (280" / 7m)

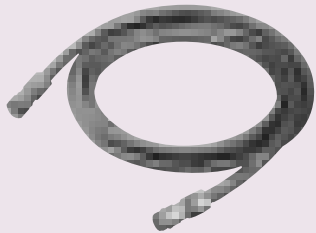

- 174-183A** 2-Axis KA Counter
- 174-185A** 3-Axis KA Counter



174-183A

Unit: mm (inch)

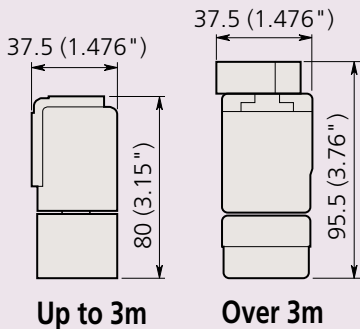

## SPECIFICATIONS

Model	AT103
Effective range	4" to 240" / 100 to 6000mm (42 models)
Resolution	.001" to .000005" / 0.01 to 0.0001mm
Accuracy (20°C)	Effective range 100 to 3000: (5+5L <sub>0</sub> /1000)μm Effective range 3250 to 6000: (5+8L <sub>0</sub> /1000)μm
Output signal	Two 90° phase-shifted sinusoidal signals
Maximum response speed	120m/min (50m/min when the effective measuring length is 3250 to 6000mm)
Signal output pitch	20μm
Scale reference point	Output in 50mm pitch
Protection level	IP53
Operating temperature	0 to 45°C

\* High-precision model **AT103F** (JIS Class 0, (3+3L<sub>0</sub>/1000)μm) is also available to special order for the effective range of 100 to 2000mm.

\* Ultrahigh-precision model **AT103S** (2+2L<sub>0</sub>/1000)μm is also available to special order for the effective range of 100 to 500mm.

AT103				Effective range L <sub>0</sub> inch / mm	Signal cable length (m)
Order No. (standard)	Model (standard)	Order No. (high accuracy)	Model (high accuracy)		
539-111-30	AT103-100	539-111-40	AT103-100F	4" /100mm	3
539-112-30	AT103-150	539-112-40	AT103-150F	6" /150mm	
539-113-30	AT103-200	539-113-40	AT103-200F	8" /200mm	
539-114-30	AT103-250	539-114-40	AT103-250F	10" /250mm	
539-115-30	AT103-300	539-115-40	AT103-300F	12" /300mm	
539-116-30	AT103-350	539-116-40	AT103-350F	14" /350mm	
539-117-30	AT103-400	539-117-40	AT103-400F	16" /400mm	
539-118-30	AT103-450	539-118-40	AT103-450F	18" /450mm	
539-119-30	AT103-500	539-119-40	AT103-500F	20" /500mm	
539-121-30	AT103-600	539-121-40	AT103-600F	24" /600mm	
539-123-30	AT103-700	539-123-40	AT103-700F	28" /700mm	
539-124-30	AT103-750	539-124-40	AT103-750F	30" /750mm	
539-125-30	AT103-800	539-125-40	AT103-800F	32" /800mm	
539-126-30	AT103-900	539-126-40	AT103-900F	36" /900mm	
539-127-30	AT103-1000	539-127-40	AT103-1000F	40" /1000mm	
539-128-30	AT103-1100	539-128-40	AT103-1100F	44" /1100mm	
539-129-30	AT103-1200	539-129-40	AT103-1200F	48" /1200mm	
539-130-30	AT103-1300	539-130-40	AT103-1300F	52" /1300mm	
539-131-30	AT103-1400	539-131-40	AT103-1400F	56" /1400mm	
539-132-30	AT103-1500	539-132-40	AT103-1500F	60" /1500mm	
539-133-30	AT103-1600	539-133-40	AT103-1600F	64" /1600mm	
539-134-30	AT103-1700	539-134-40	AT103-1700F	68" /1700mm	
539-135-30	AT103-1800	539-135-40	AT103-1800F	72" /1800mm	
539-136-30	AT103-2000	539-136-40	AT103-2000F	80" /2000mm	
539-137-30	AT103-2200	—	AT103-2200F	88" /2200mm	
539-138-30	AT103-2400	—	AT103-2400F	96" /2400mm	
539-139-30	AT103-2500	—	AT103-2500F	100" /2500mm	
539-140-30	AT103-2600	—	AT103-2600F	104" /2600mm	
539-141-30	AT103-2800	—	AT103-2800F	112" /2800mm	
539-142-30	AT103-3000	—	AT103-3000F	120" /3000mm	
539-143-30	AT103-3250	—	AT103-3250F	130" /3250mm	
539-144-30	AT103-3500	—	AT103-3500F	140" /3500mm	
539-145-30	AT103-3750	—	AT103-3750F	150" /3750mm	
539-146-30	AT103-4000	—	AT103-4000F	160" /4000mm	
539-147-30	AT103-4250	—	AT103-4250F	170" /4250mm	
539-148-30	AT103-4500	—	AT103-4500F	180" /4500mm	
539-149-30	AT103-4750	—	AT103-4750F	190" /4750mm	
539-150-30	AT103-5000	—	AT103-5000F	200" /5000mm	
539-151-30	AT103-5250	—	AT103-5250F	210" /5250mm	
539-152-30	AT103-5500	—	AT103-5500F	220" /5500mm	
539-153-30	AT103-5750	—	AT103-5750F	230" /5750mm	
539-154-30	AT103-6000	—	AT103-6000F	240" /6000mm	

# Linear Scales AT113

## SERIES 539 — Slim Spar Type

- Slim spar type with unit sectional dimensions of 22×35mm.
- Connectable to the **KA** counter, **KLD** counter or **PSU-200**.
- Dimensionally compatible with **AT116** linear scale units.



### SPECIFICATIONS

Model	AT113
Effective range	4" to 60" / 100 to 1500mm (20 models)
Resolution	.001" to .000005" / 0.01 to 0.0001mm
Accuracy (20°C)	Standard: (5+5L <sub>o</sub> /1000)μm, High accuracy: (3+3L <sub>o</sub> /1000)
Output signal	Two 90° phase-shifted sinusoidal signals
Maximum response speed	120m/min
Signal output pitch	20μm
Scale reference point	Output in 50mm pitch
Protection level	IP53
Operating temperature	0 to 45°C

\* High-precision model **AT113F** (JIS Class 0, 3+3L<sub>o</sub>/1000)μm is also available to special order.

\* Ultrahigh-precision model **AT113S** (2+2L<sub>o</sub>/1000)μm is also available to special order for the effective range 100 to 500mm.

AT113				Effective range L <sub>o</sub> inch / mm	Signal cable length(m)
Order No. (standard)	Model	Order No. (High accuracy)	Model		
539-201-30	AT113-100	539-201-40	AT113-100F	4" /100mm	3
539-202-30	AT113-150	539-202-40	AT113-150F	6" /150mm	
539-203-30	AT113-200	539-203-40	AT113-200F	8" /200mm	
539-204-30	AT113-250	539-204-40	AT113-250F	10" /250mm	
539-205-30	AT113-300	539-205-40	AT113-300F	12" /300mm	
539-206-30	AT113-350	539-206-40	AT113-350F	14" /350mm	
539-207-30	AT113-400	539-207-40	AT113-400F	16" /400mm	
539-208-30	AT113-450	539-208-40	AT113-450F	18" /450mm	
539-209-30	AT113-500	539-209-40	AT113-500F	20" /500mm	
539-211-30	AT113-600	539-211-40	AT113-600F	24" /600mm	
539-213-30	AT113-700	539-213-40	AT113-700F	28" /700mm	
539-214-30	AT113-750	539-214-40	AT113-750F	30" /750mm	
539-215-30	AT113-800	539-215-40	AT113-800F	32" /800mm	
539-216-30	AT113-900	539-216-40	AT113-900F	36" /900mm	
539-217-30	AT113-1000	539-217-40	AT113-1000F	40" /1000mm	
539-218-30	AT113-1100	539-218-40	AT113-1100F	44" /1100mm	
539-219-30	AT113-1200	539-219-40	AT113-1200F	48" /1200mm	
539-220-30	AT113-1300	539-220-40	AT113-1300F	52" /1300mm	
539-221-30	AT113-1400	539-221-40	AT113-1400F	56" /1400mm	
539-222-30	AT113-1500	539-222-40	AT113-1500F	60" /1500mm	



### Optional Accessories

**09AAA033A:** Extension cable (80" / 2m)

**09AAA033B:** Extension cable (200" / 5m)

**09AAA033C:** Extension cable (280" / 7m)

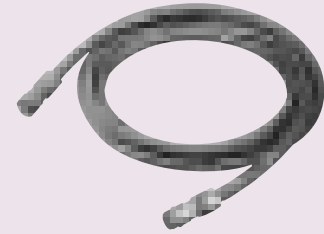

**174-183A** 2-Axis KA Counter

**174-185A** 3-Axis KA Counter



174-183A

Unit: mm (inch)

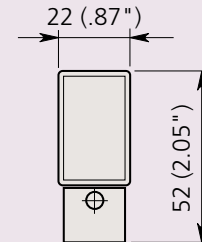





# Linear Scales AT112-F

## SERIES 539 — Super Slim Spar Type

- Super slim spar type with unit sectional dimensions of 15.4x30mm.
- Connectable to the **KA** counter, **KLD** counter or **PSU-200**.

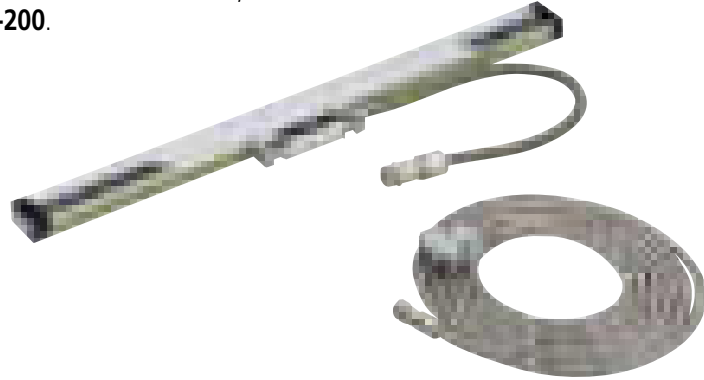

### Optional Accessories

- 09AAA033A: Extension cable (80" / 2m)
- 09AAA033B: Extension cable (200" / 5m)
- 09AAA033C: Extension cable (280" / 7m)

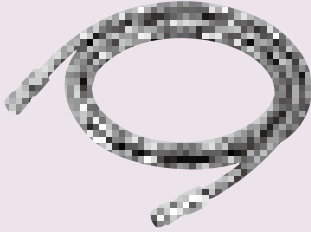

- 174-183A 2-Axis KA Counter
- 174-185A 3-Axis KA Counter



174-183A

Unit: mm (inch)

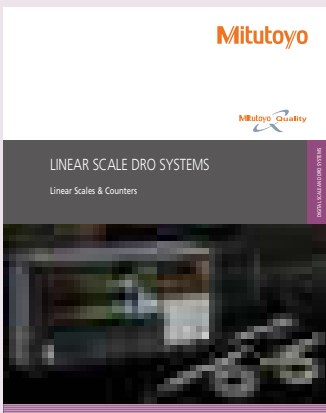
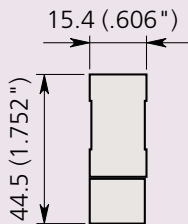

Refer to Bulletin No. (2217) for more details.

### SPECIFICATIONS

Model	AT112-F (High Accuracy)
Effective range	1.5" to 40" / 50 to 1020mm (19 models)
Resolution	.001 to .000005" / 0.01mm to 0.0001mm
Accuracy (20°C)	(3+3L <sub>0</sub> /1000)μm
Output signal	Two 90° phase-shifted sinusoidal signals
Maximum response speed	50m/min
Signal output pitch	20μm
Scale reference point	Output in 50mm pitch*1
Protection level	IP53
Operating temperature	0 to 45°C

\* Ultra-high precision model **AT112S** (2+2L<sub>0</sub>/1000)μm is also available to special order for the effective range 50 to 320mm.

\*1: Models whose effective range is 50mm or 70mm: Center point  
Models whose effective range is 120mm or more: 50mm pitch starting at a point 35mm from the "▼" mark on the left seen from the front.

AT112-F		Effective range L <sub>0</sub> inch / mm	Signal cable length (m)
Order No.	Model		
539-251-10	AT112-50F	1.5" / 50mm	3
539-252-10	AT112-70F	2.5" / 70mm	
539-253-10	AT112-120F	4.5" / 120mm	
539-254-10	AT112-170F	6.5" / 170mm	
539-255-10	AT112-220F	8.5" / 220mm	
539-256-10	AT112-270F	10.5" / 270mm	
539-257-10	AT112-320F	12.5" / 320mm	
539-258-10	AT112-370F	14.5" / 370mm	
539-259-10	AT112-420F	16.5" / 420mm	
539-260-10	AT112-470F	18.5" / 470mm	
539-261-10	AT112-520F	20" / 520mm	
539-262-10	AT112-570F	22" / 570mm	
539-263-10	AT112-620F	24" / 620mm	
539-264-10	AT112-670F	26" / 670mm	
539-265-10	AT112-720F	28" / 720mm	
539-266-10	AT112-770F	30" / 770mm	
539-267-10	AT112-820F	32" / 820mm	
539-268-10	AT112-920F	36" / 920mm	
539-269-10	AT112-1020F	40" / 1020mm	

# Linear Scales AT116

SERIES 539 — Economy and Slim Spar Type

## FEATURES

- Suitable for milling machines, XY tables, jigs, etc.
- Dimensionally compatible with **AT113** linear scale units.
- Connectable to the **KA** counter, **KLD** counter or **PSU-200**.



## SPECIFICATIONS

Model	AT116
Effective range	4" to 60" / 100 to 1500mm (20 models)
Resolution	0.01 to 0.0001mm (.001" to .00005")
Accuracy (20°C)	(5+5L <sub>0</sub> /1000)μm
Output signal	Two 90° phase-shifted sinusoidal signals
Maximum response speed	50m/min
Signal output pitch	20μm
Scale reference point	Output in 50mm pitch
Protection level	IP53
Operating temperature	0 to 45°C

AT116		Effective range L <sub>0</sub> inch / mm	Signal cable length (m)
Order No.	Model		
539-271-30	AT116-100	4" /100mm	3.5
539-272-30	AT116-150	6" /150mm	
539-273-30	AT116-200	8" /200mm	
539-274-30	AT116-250	10" /250mm	
539-275-30	AT116-300	12" /300mm	
539-276-30	AT116-350	14" /350mm	
539-277-30	AT116-400	16" /400mm	
539-278-30	AT116-450	18" /450mm	
539-279-30	AT116-500	20" /500mm	
539-281-30	AT116-600	24" /600mm	
539-283-30	AT116-700	28" /700mm	
539-284-30	AT116-750	30" /750mm	
539-285-30	AT116-800	32" /800mm	
539-286-30	AT116-900	36" /900mm	
539-287-30	AT116-1000	40" /1000mm	
539-288-30	AT116-1100	44" /1100mm	
539-289-30	AT116-1200	48" /1200mm	
539-290-30	AT116-1300	52" /1300mm	
539-291-30	AT116-1400	56" /1400mm	
539-292-30	AT116-1500	60" /1500mm	



## Optional Accessories

- 09AAB674A:** Extension cable (2m / 80")
- 09AAB674B:** Extension cable (5m / 200")
- 09AAB674C:** Extension cable (7m / 280")

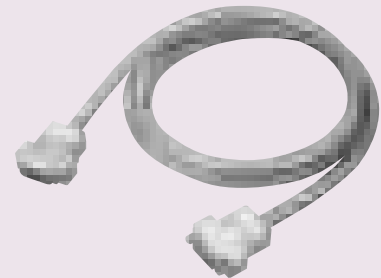

- 174-183A** 2-Axis KA Counter
- 174-185A** 3-Axis KA Counter



174-183A

Unit: mm (inch)

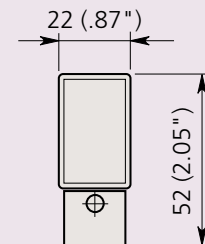



# Linear Scales AT402E

## SERIES 539 — General-purpose Type

- Ideal for machine tools for heavy cutting, as well as linear motors.
- Multi-point elastic fixing for excellent vibration resistance (200m/s<sup>2</sup>), shock resistance (400m/s<sup>2</sup>) and temperature characteristics.
- The Absolute Interval Code allows for a simplified, low-cost ABS system.
- High accuracy of ±2μm (up to 540mm)



### SPECIFICATIONS

Model	AT402E
Effective range	5.6" to 121.6" / 140 to 3040mm (24 models)
Accuracy (20°C)	Effective range: 140 to 540mm: ±2μm Effective range: 640 to 940mm: ±3μm Effective range: 1040 to 3040mm: ±3μm/m
Output signal	Signal: 1Vp-p differential sinusoidal signal Differential reference point pulse: <b>Absolute Interval Code</b> compatible
Maximum response speed	120m/min (With sinusoidal signal amplitude of -3dB)
Signal output pitch	20μm
Protection level	IP53
Operating temperature	0 to 45°C
Cable configuration	Type A: 3m flying lead cable Type B: 3m cable with European CNC connectors Type C: 3m cable with FANUC connectors

Cable A: Lead wires type

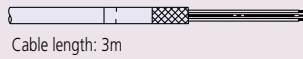

Cable length: 3m

Cable B: Connectable to Euro controller

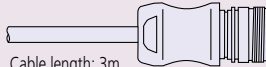

Cable length: 3m

Cable C: Connectable to FANUC serial board C

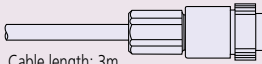

Cable length: 3m

AT402E		Effective range Lo inch / mm	AT402E		Effective range Lo inch / mm
Order No.	Model		Order No.	Model	
539-371-□□	AT402E-140	5.6" / 140mm	539-384-□□	AT402E-1340	53.6" / 1340mm
539-373-□□	AT402E-240	9.6" / 240mm	539-385-□□	AT402E-1440	57.6" / 1440mm
539-374-□□	AT402E-340	13.6" / 340mm	539-386-□□	AT402E-1540	61.6" / 1540mm
539-375-□□	AT402E-440	17.6" / 440mm	539-387-□□	AT402E-1640	65.6" / 1640mm
539-376-□□	AT402E-540	21.6" / 540mm	539-388-□□	AT402E-1740	69.6" / 1740mm
539-377-□□	AT402E-640	25.6" / 640mm	539-389-□□	AT402E-1840	73.6" / 1840mm
539-378-□□	AT402E-740	29.6" / 740mm	539-390-□□	AT402E-2040	81.6" / 2040mm
539-379-□□	AT402E-840	33.6" / 840mm	539-391-□□	AT402E-2240	89.6" / 2240mm
539-380-□□	AT402E-940	37.6" / 940mm	539-392-□□	AT402E-2440	97.6" / 2440mm
539-381-□□	AT402E-1040	41.6" / 1040mm	539-393-□□	AT402E-2640	105.6" / 2640mm
539-382-□□	AT402E-1140	45.6" / 1140mm	539-394-□□	AT402E-2840	113.6" / 2840mm
539-383-□□	AT402E-1240	49.6" / 1240mm	539-395-□□	AT402E-3040	121.6" / 3040mm

Signal cable length: 3m

\* The indication of "□□" in the code numbers will be **01** for Type A, **02** for Type B, **03** for Type C, and **00** for no cable

### DIMENSIONS

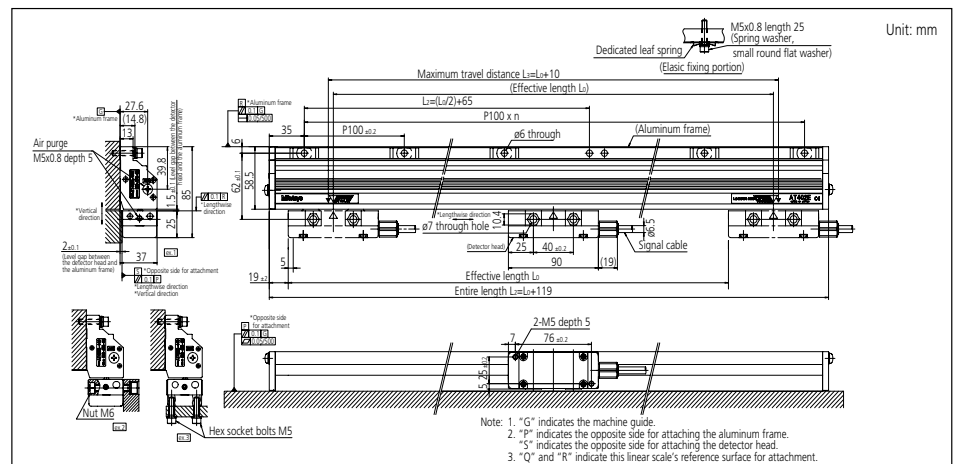

# Linear Scales AT203

SERIES 539 — Standard Type



## SPECIFICATIONS

Model	AT203
Effective range	4" to 240" / 100 to 6000mm (42 models)
Accuracy (20°C)	Effective range: 100 to 1500mm (3+3L <sub>0</sub> /1000)μm Effective range: 1600 to 3000mm (5+5L <sub>0</sub> /1000)μm Effective range: 3250 to 6000mm (5+8L <sub>0</sub> /1000)μm
Output signal	Two 90° phase-shifted square wave signals
Maximum response speed	120m/min (50m/min when the effective range is 3250 to 6000mm)
Resolution	0.1/0.5/1μm (Switchable by the DIP switches)
Scale reference point	Output in 50mm pitch
Protection level	IP53
Operating temperature	0°C to 45°C

AT203		Effective range L <sub>0</sub> inch / mm	Signal cable length (m)
Order No.	Model		
539-411-30	AT203-100	4" /100mm	
539-412-30	AT203-150	6" /150mm	
539-413-30	AT203-200	8" /200mm	
539-414-30	AT203-250	10" /250mm	
539-415-30	AT203-300	12" /300mm	
539-416-30	AT203-350	14" /350mm	
539-417-30	AT203-400	16" /400mm	
539-418-30	AT203-450	18" /450mm	
539-419-30	AT203-500	20" /500mm	
539-421-30	AT203-600	24" /600mm	
539-423-30	AT203-700	28" /700mm	
539-424-30	AT203-750	30" /750mm	
539-425-30	AT203-800	32" /800mm	
539-426-30	AT203-900	36" /900mm	
539-427-30	AT203-1000	40" /1000mm	
539-428-30	AT203-1100	44" /1100mm	
539-429-30	AT203-1200	48" /1200mm	
539-430-30	AT203-1300	52" /1300mm	
539-431-30	AT203-1400	56" /1400mm	
539-432-30	AT203-1500	60" /1500mm	
539-433-30	AT203-1600	64" /1600mm	
539-434-30	AT203-1700	68" /1700mm	
539-435-30	AT203-1800	72" /1800mm	
539-436-30	AT203-2000	80" /2000mm	
539-437-30	AT203-2200	88" /2200mm	
539-438-30	AT203-2400	96" /2400mm	
539-439-30	AT203-2500	100" /2500mm	
539-440-30	AT203-2600	104" /2600mm	
539-441-30	AT203-2800	112" /2800mm	
539-442-30	AT203-3000	120" /3000mm	
539-443-30	AT203-3250	130" /3250mm	
539-444-30	AT203-3500	140" /3500mm	
539-445-30	AT203-3750	150" /3750mm	
539-446-30	AT203-4000	160" /4000mm	
539-447-30	AT203-4250	170" /4250mm	
539-448-30	AT203-4500	180" /4500mm	
539-449-30	AT203-4750	190" /4750mm	
539-450-30	AT203-5000	200" /5000mm	
539-451-30	AT203-5250	210" /5250mm	
539-452-30	AT203-5500	220" /5500mm	
539-453-30	AT203-5750	230" /5750mm	
539-454-30	AT203-6000	240" /6000mm	

- The travel length of the linear scale is output with 2-phase square wave signals, which can be used as a feedback signal for NC machine tools.
- The pulse signal unit (PSU) is no longer needed, and the **AT203** can be directly connected to an NC machine tool.

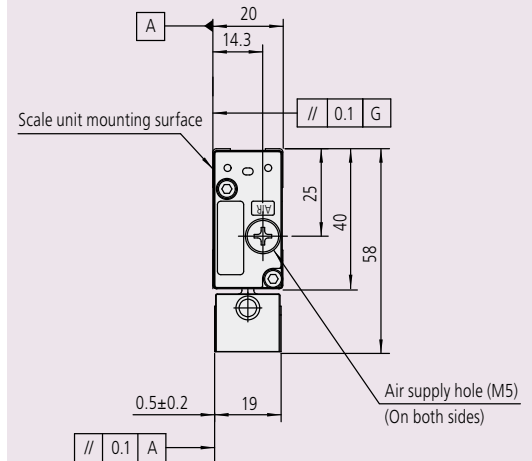

- Any scale size drawings are available on request.



# Linear Scales AT216-T / AT217-TL

## SERIES 529 — Slim, Sealed Type

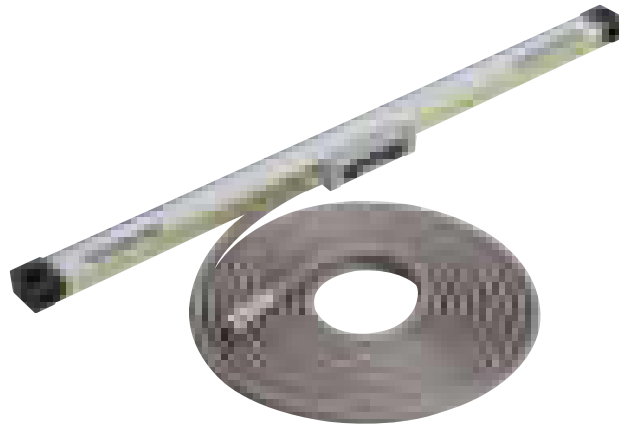

- Slim, sealed type incremental linear scales suitable for feedback systems in NC machine tools.
- Direct connection with NC machine tools is possible.
- Square wave RS-422A, 1µm/0.5µm & 5µm resolution.
- Armored cable included (unless otherwise specified)

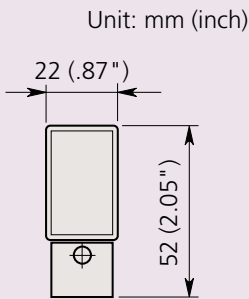

### 5µm resolution

AT216-T		Effective range L <sub>o</sub> inch / mm	Signal cable length (m)
Order No.	Model		
529-431-3	AT216-100T	4" /100mm	5
529-432-3	AT216-150T	6" /150mm	
529-433-3	AT216-200T	8" /200mm	
529-434-3	AT216-250T	10" /250mm	
529-435-3	AT216-300T	12" /300mm	
529-436-3	AT216-350T	14" /350mm	
529-437-3	AT216-400T	16" /400mm	
529-438-3	AT216-450T	18" /450mm	
529-439-3	AT216-500T	20" /500mm	
529-441-3	AT216-600T	24" /600mm	
529-443-3	AT216-700T	28" /700mm	
529-444-3	AT216-750T	30" /750mm	
529-445-3	AT216-800T	32" /800mm	
529-446-3	AT216-900T	36" /900mm	
529-447-3	AT216-1000T	40" /1000mm	
529-448-3	AT216-1100T	44" /1100mm	
529-449-3	AT216-1200T	48" /1200mm	
529-450-3	AT216-1300T	52" /1300mm	
529-451-3	AT216-1400T	56" /1400mm	
529-452-3	AT216-1500T	60" /1500mm	

- Any scale size drawings are available on request.

### 1µm/0.5µm resolution

AT217-TL		Effective range L <sub>o</sub> inch / mm	Signal cable length (m)
Order No.	Model		
529-461-5 (-7)	AT217-100TL	4" /100mm	5
529-462-5 (-7)	AT217-150TL	6" /150mm	
529-463-5 (-7)	AT217-200TL	8" /200mm	
529-464-5 (-7)	AT217-250TL	10" /250mm	
529-465-5 (-7)	AT217-300TL	12" /300mm	
529-466-5 (-7)	AT217-350TL	14" /350mm	
529-467-5 (-7)	AT217-400TL	16" /400mm	
529-468-5 (-7)	AT217-450TL	18" /450mm	
529-469-5 (-7)	AT217-500TL	20" /500mm	
529-471-5 (-7)	AT217-600TL	24" /600mm	
529-473-5 (-7)	AT217-700TL	28" /700mm	
529-474-5 (-7)	AT217-750TL	30" /750mm	
529-475-5 (-7)	AT217-800TL	32" /800mm	
529-476-5 (-7)	AT217-900TL	36" /900mm	
529-477-5 (-7)	AT217-1000TL	40" /1000mm	
529-478-5 (-7)	AT217-1100TL	44" /1100mm	
529-479-5 (-7)	AT217-1200TL	48" /1200mm	
529-480-5 (-7)	AT217-1300TL	52" /1300mm	
529-481-5 (-7)	AT217-1400TL	56" /1400mm	
529-482-5 (-7)	AT217-1500TL	60" /1500mm	

(-7) : option for unarmored cable

# Linear Scales AT211

**AT211-A (Multipoint mounting), AT211-B (Double-end mounting)**  
**SERIES 539 — Slim Spar and High-speed Type**



## FEATURES

- High-resolution, high-accuracy sealed type linear scales. Ideal for feedback control in positioning a semiconductor manufacturing system, CNC machine tool, etc.
- Two types of models are available: the AT211-A, the multiple-point installation type designed for improved resistance against vibration and shock; and the AT211-B, which attaches to a machine at both ends. The AT211-B is compatible with the AT113/AT116 slim type in size.
- This is a slim, sealed, 2-phase, square-wave scale that can be directly connected to a control unit.
- Scale alarm display LED allows for easy maintenance.
- A wide range of specifications to best suit your application.
- Suitable for the control of semiconductor manufacturing systems and NC machine tools.



## Common specification

Model	AT211
Effective range*	4 to 60" / 100 to 1500mm (20 models)
Accuracy (20°C)*	(3+3L <sub>o</sub> /1000)μm L <sub>o</sub> : effective range (mm) (2+2L <sub>o</sub> /1000)μm (L <sub>o</sub> ≤500mm)
Output signal	Two 90° phase-shifted square wave signals
Maximum response speed*	5.4 to 120m/min (varies depending on the resolution or minimum edge interval)
Resolution*	0.1/ 0.2/ 0.5/ 1.0/ 2.5/ 5.0μm
Scale reference point*	50mm/Center point/Left-edge point/Right-edge point
Protection level	IP53
Operating temperature	0 to 45°C

\* Desired specification is selectable.

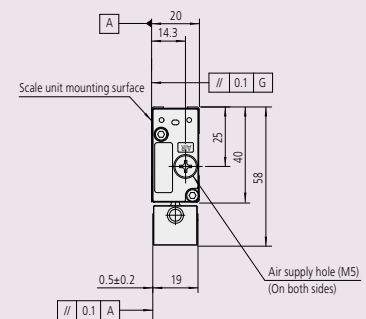

## Meaning of Model No.

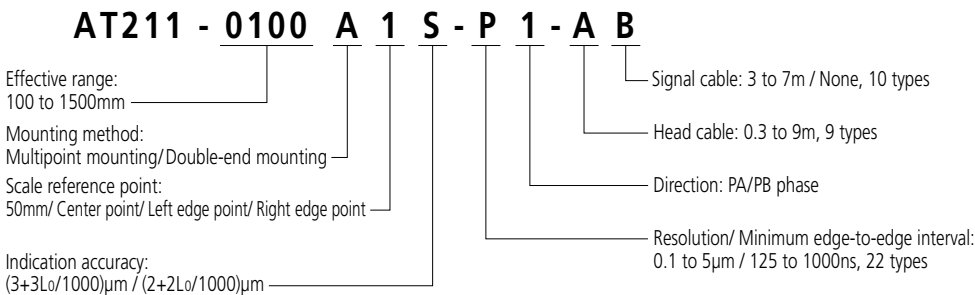

- Any scale size drawings are available on request.



# Linear Scales ST422

## SERIES 579 — Compact Type

### SPECIFICATIONS

Model	ST422
Detection method	Reflective photoelectric linear encoder
Output signal	2-phase sinusoidal signals, 2-phase square wave signals
Main scale grating pitch	40μm
Signal output pitch	40μm
Effective range	10 to 3000mm
Accuracy (20°C)*1	±1μm, ±2μm, ±3μm/(m)
Resolution	0.2μm/ 0.5μm/ 1μm/ 5μm (Selectable with internal switch)
Scale reference point	Center point (10 to 75mm)/ 50mm pitch (100mm or more)
Maximum response speed	5000mm/s (varies depending on the setting)
Minimum edge-to-edge interval	125ns/ 250ns/ 500ns/ 1μs (selectable with internal switch)
Operating temperature/ humidity range	0 to 40°C, RH 20 to 80% (no condensation)
Storage temperature/ humidity range	-20 to 60°C, RH 20 to 80% (no condensation)
Head cable length	1m

\*1:

Effective range	Accuracy
300mm or less	±1μm
500mm or less	±2μm
1000mm or less	±3μm
3000mm or less	±3μm/m

### Dimensions of scale units

Order No.	Code	Effective range L <sub>1</sub> (mm)	Overall length L <sub>2</sub> (mm)	Scale fixing pitch L <sub>3</sub> (mm)	Retaining spring A	Retaining spring B	Order No.	Code	Effective range L <sub>1</sub> (mm)	Overall length L <sub>2</sub> (mm)	Scale fixing pitch L <sub>3</sub> (mm)	Retaining spring A	Retaining spring B
579-631	ST422-10	10	30	—	—	—	579-648	ST422-1000	1000	1040	100	1 pc.	10 pcs.
579-632	ST422-25	25	45	—	—	—	579-649	ST422-1100	1100	1140	90	1 pc.	12 pcs.
579-633	ST422-50	50	70	—	—	—	579-650	ST422-1200	1200	1240	100	1 pc.	12 pcs.
579-634	ST422-75	75	95	—	—	—	579-651	ST422-1300	1300	1340	130	1 pc.	10 pcs.
579-635	ST422-100	100	120	—	—	—	579-652	ST422-1400	1400	1440	100	1 pc.	14 pcs.
579-636	ST422-150	150	170	—	—	—	579-653	ST422-1500	1500	1540	125	1 pc.	12 pcs.
579-637	ST422-200	200	220	—	—	—	579-654	ST422-1600	1600	1640	100	1 pc.	16 pcs.
579-638	ST422-250	250	270	—	—	—	579-655	ST422-1700	1700	1740	120	1 pc.	14 pcs.
579-639	ST422-300	300	320	—	—	—	579-656	ST422-1800	1800	1840	100	1 pc.	18 pcs.
579-640	ST422-350	350	370	—	—	—	579-657	ST422-2000	2000	2040	100	1 pc.	20 pcs.
579-641	ST422-400	400	440	100	1 pc.	4 pcs.	579-658	ST422-2200	2200	2240	100	1 pc.	22 pcs.
579-642	ST422-450	450	490	75	1 pc.	6 pcs.	579-659	ST422-2400	2400	2440	100	1 pc.	24 pcs.
579-643	ST422-500	500	540	80	1 pc.	6 pcs.	579-660	ST422-2500	2500	2540	95	1 pc.	26 pcs.
579-644	ST422-600	600	640	100	1 pc.	6 pcs.	579-661	ST422-2600	2600	2640	100	1 pc.	26 pcs.
579-645	ST422-700	700	740	85	1 pc.	8 pcs.	579-662	ST422-2800	2800	2840	100	1 pc.	28 pcs.
579-646	ST422-800	800	840	100	1 pc.	8 pcs.	579-663	ST422-3000	3000	3040	100	1 pc.	30 pcs.
579-647	ST422-900	900	940	90	1 pc.	10 pcs.							

- The maximum response speed is 5000mm/s. (When resolution is 1μm and the minimum edge interval is 125ns.)
- Ultra-compact detector control unit allows use in applications where space-saving design is important.
- The maximum effective measurement length of 3000mm enables use on large machines.
- Simultaneous output of 2-phase square wave signals (maximum resolution: 0.2μm) and 2-phase sinusoidal wave signals (main signal: 40μm) is available.
- LED function for indicating signal errors.
- Equipped with scale reference point output.

### ST422 Scale unit mounting dimensions

• ST422-10 to 350 (Adhesive fixing type) \*3

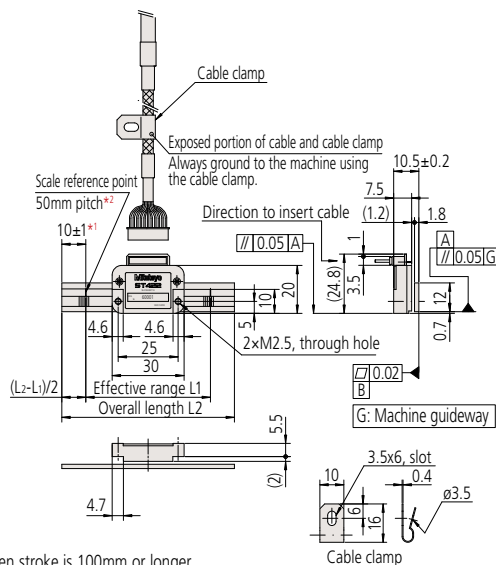

- \*1 When stroke is 100mm or longer
- \*2 One center point when stroke is 10 to 75mm
- \*3 For information on fixing methods for adhesive fixing type

• ST422-400 to 3000

Unit: mm

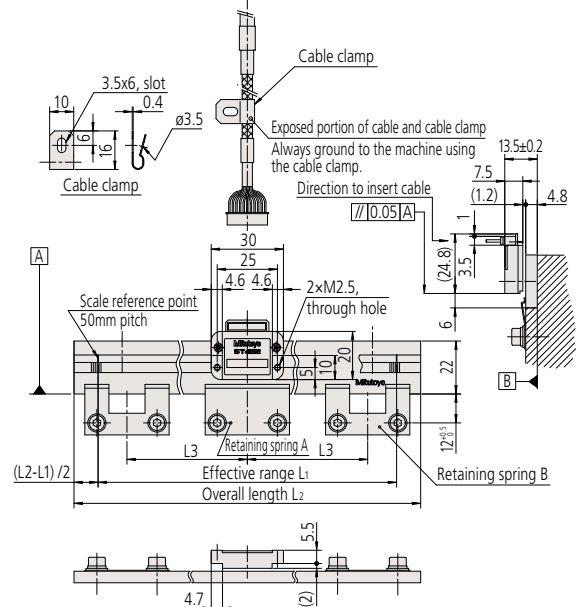

- Any scale size drawings are available on request.

# Linear Scales ST46-EZA

SERIES 579 — Compact Type

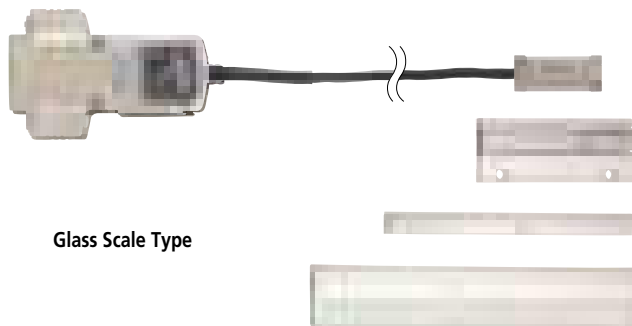

Glass Scale Type

## Metal Tape Scale Type

- Double-end fixing tensioned design

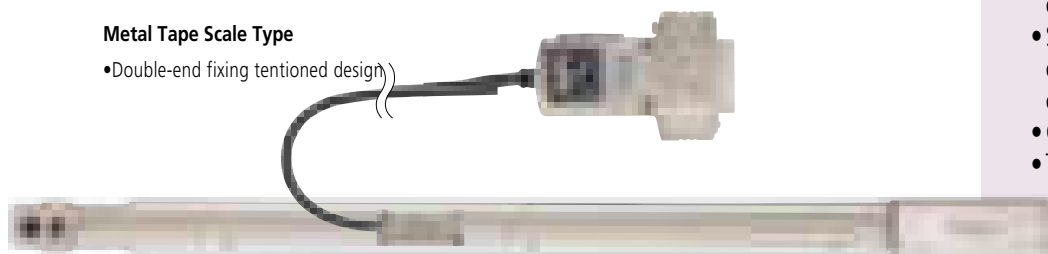

- Double-sided adhesive tape fixing design

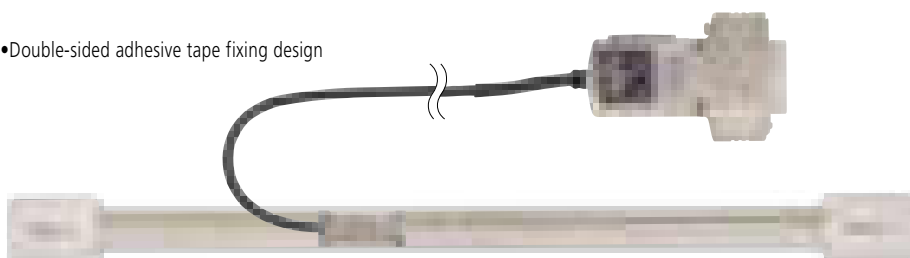

NC side

## SPECIFICATIONS

Model	ST46-EZA	
Detection method	Reflective photoelectric linear encoder	
Scale type	Glass	Metal tape
Main scale grating pitch	20µm	
Output signal	Type B: 2-phase square wave signals, reference point pulse, external reset input. Type C: 2-phase square wave signals, reference point pulse, 2-phase sinusoidal signals.	
Effective range	10 to 3000mm	
Resolution	0.05µm to 5 µm	
Accuracy (20°C)	Effective range 10 to 300mm: ±1µm Effective range 350 to 500mm: ±2µm Effective range 600 to 1000mm: ±3µm Effective range 1100 to 3000mm: ±3µm/m	Effective range 10 to 1000mm: ±5µm Effective range 1100 to 3000mm: ±5µm/m (The above accuracy applies to individual scales. For double-end fixing designs, perform point-to-point correction after ensuring the metal tape is tensioned correctly.)
Maximum response speed	2.6m/s (With sinusoidal signal amplitude of -3dB)	
Scale reference point	50mm pitch, 10 to 80mm: Center point	
Power supply voltage	5VDC±5%	
Operating temperature/humidity range	0 to 40°C, RH 20 to 80% (no condensation)	
Storage temperature/humidity range	-20 to 60°C, RH 20 to 80% (no condensation)	

- Includes an automatic adjusting function for the signal (EZA function) at the push of a button.
- Detector head mounting and signal adjustment possible without oscilloscope or PC.
- A setup indicator for checking signal strength is included.
- I/F circuit integrated in connector shell reduces volume to 60% compared to conventional interface.
- Self-diagnosis function with USB connectivity facilitates signal strength checking and parameter setup.
- Glass and metal tape scales are available.
- The thickness of the detector head is only 7.5 mm. The metal tape scale type has a mounting surface area of 12.5 by 9.325 mm, allowing use in applications where a space-saving design is important.
- Drawings are available on request

Adjustment SW / CAL display / Reference point display

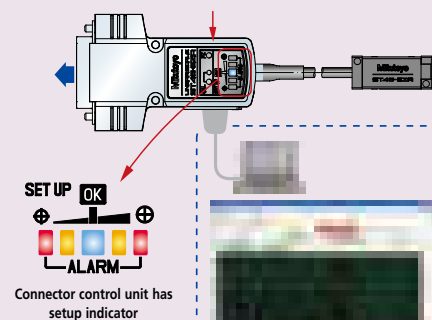

Signal strength checking and parameter setup can be performed on a PC (PC to be prepared by customer)





# Linear Scales ST36

## SERIES 579 — High-accuracy Type



- Outputs two-phase sinusoidal wave signal, two-phase pulse signal, and 1Vp-p at 4μm pitch.
- High-accuracy type, 0.5μm class (effective range up to 300mm)
- Has a thinner detector head (thickness 11.5mm).
- The maximum effective measurement range of 3000mm allows use on large machines.
- Four types available for each signal output specification.
- LED function for indicating signal errors.
- Along with the output specifications of 2-phase sinusoidal wave and 2-phase square wave, the output specification of 1Vp-p wave is available.

### SPECIFICATIONS

Model	ST36
Detection method	Reflective photoelectric linear encoder
Output signal	<b>ST36A:</b> 2-phase sinusoidal signals <b>ST36B:</b> 2-phase square wave signals, alarm reset input <b>ST36C:</b> 2-phase square wave signals, 2-phase sinusoidal signals <b>ST36D:</b> 1Vp-p differential sinusoidal signals
Main scale grating pitch	8μm
Signal output pitch	4μm
Effective range	10 to 3000mm
Resolution	0.01, 0.02, 0.05, 0.1μm
Accuracy (20°C)*1	±0.5μm, ±1μm, ±2μm/m
Maximum response speed*2	1200mm/s
Scale reference point	Center point (10 to 80mm) 50mm pitch (100 to 3000mm)
Power supply voltage	DC5V ±5%
Operating temperature/humidity range	0 to 40°C/ 20 to 80% (no condensation)
Storage temperature/ humidity range	-20 to 60°C/ 20 to 80% (no condensation)
Head cable length	1m (high-flex connecting cable)

*1: Effective range	Accuracy
300mm or less	±0.5μm
500mm or less	±1μm
1000mm or less	±2μm
3000mm or less	±2μm/m

\*2: Maximum response speed when the sinusoidal signals are output

- Any scale size drawings are available on request.

### Mounting dimensions

- 10 to 80mm (Adhesive fixing type)

- 100 to 3000mm

Unit: mm

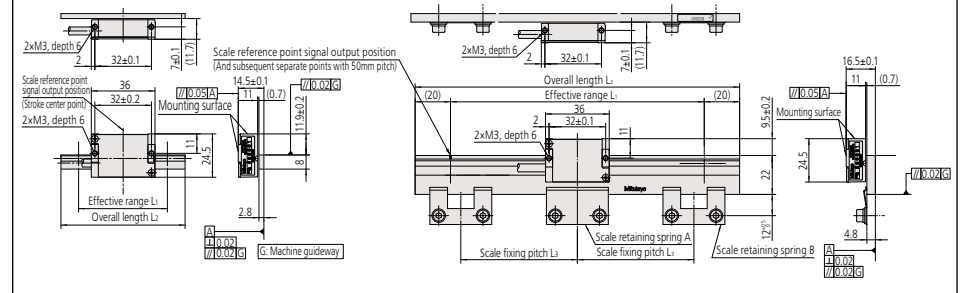

### Dimensions of scale units

Order No.*	Code*	Effective range L1 (mm)	Overall length L2 (mm)	Scale fixing pitch L3 (mm)	Retaining spring A	Retaining spring B	Order No.*	Code*	Effective range L1 (mm)	Overall length L2 (mm)	Scale fixing pitch L3 (mm)	Retaining spring A	Retaining spring B
579-501-0	ST36◇10	10	30	—	—	—	579-518-0	ST36◇900	900	940	90	1 pc.	10 pcs.
579-502-0	ST36◇25	25	45	—	—	—	579-519-0	ST36◇1000	1000	1040	100	1 pc.	10 pcs.
579-503-0	ST36◇50	50	70	—	—	—	579-520-0	ST36◇1100	1100	1140	90	1 pc.	12 pcs.
579-504-0	ST36◇75	75	90	—	—	—	579-521-0	ST36◇1200	1200	1240	100	1 pc.	12 pcs.
579-505-0	ST36◇80	80	100	—	—	—	579-522-0	ST36◇1300	1300	1340	130	1 pc.	10 pcs.
579-506-0	ST36◇100	100	140	50	1 pc.	2 pcs.	579-523-0	ST36◇1400	1400	1440	100	1 pc.	14 pcs.
579-507-0	ST36◇150	150	190	75	1 pc.	2 pcs.	579-524-0	ST36◇1500	1500	1540	125	1 pc.	12 pcs.
579-508-0	ST36◇200	200	240	100	1 pc.	2 pcs.	579-525-0	ST36◇1600	1600	1640	100	1 pc.	16 pcs.
579-509-0	ST36◇250	250	290	60	1 pc.	4 pcs.	579-526-0	ST36◇1700	1700	1740	120	1 pc.	14 pcs.
579-510-0	ST36◇300	300	340	75	1 pc.	4 pcs.	579-527-0	ST36◇1800	1800	1840	100	1 pc.	18 pcs.
579-511-0	ST36◇350	350	390	85	1 pc.	4 pcs.	579-528-0	ST36◇2000	2000	2040	100	1 pc.	20 pcs.
579-512-0	ST36◇400	400	440	100	1 pc.	4 pcs.	579-529-0	ST36◇2200	2200	2240	100	1 pc.	22 pcs.
579-513-0	ST36◇450	450	490	75	1 pc.	6 pcs.	579-530-0	ST36◇2400	2400	2440	100	1 pc.	24 pcs.
579-514-0	ST36◇500	500	540	80	1 pc.	6 pcs.	579-531-0	ST36◇2500	2500	2540	95	1 pc.	26 pcs.
579-515-0	ST36◇600	600	640	100	1 pc.	6 pcs.	579-532-0	ST36◇2600	2600	2640	100	1 pc.	26 pcs.
579-516-0	ST36◇700	700	740	85	1 pc.	8 pcs.	579-533-0	ST36◇2800	2800	2840	100	1 pc.	28 pcs.
579-517-0	ST36◇800	800	840	100	1 pc.	8 pcs.	579-534-0	ST36◇3000	3000	3040	100	1 pc.	30 pcs.

\* The above code numbers are for recommended items marked with ● / ◎ symbols. If recommended specifications meet your requirements, use these code numbers to order.

\* The □ and ◇ symbols in the tables above have the following meanings:  
 ◇→A (2-phase sinusoidal signals): □→1  
 ◇→B (2-phase square wave signals + reset input): □→2  
 ◇→C (2-phase sinusoidal signals + 2-phase square wave signals): □→3  
 ◇→D (1Vp-p differential): □→4

# Fiber Scale ST-F11

SERIES 579 — Ultra Compact Linear Scale

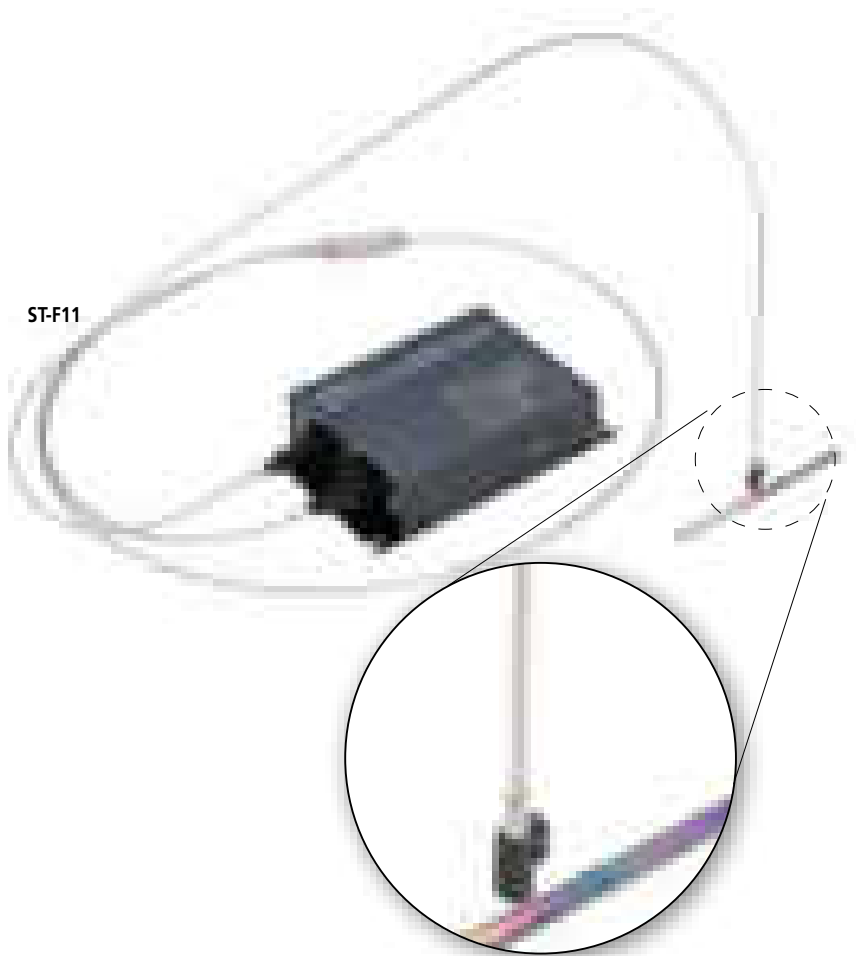

## FEATURES

- Ultra-compact detector head: 5mm width (S-Type)
- High resolution: 100 nm (0.1 $\mu$ m), 50 nm (0.05 $\mu$ m), 10 nm (0.01 $\mu$ m)
- Isolated heat source. No heat source at the detector head.
- Immune to EMI.
- Easy installation. LEDs on the processor indicate which direction to adjust the detector head when mounting.

## Processor LED Indicators



## SPECIFICATIONS

Model	ST- F11B	ST- F11C
Detection method	Diffraction interference , reflection-type linear encoder	
Grating pitch for the main scale	4 $\mu$ m	
Signal output pitch	2 $\mu$ m	
Output signal	2-phase-shifted square wave (+ reset input)	2-phase-shifted square wave 2-phase-shifted sine wave
Resolution	10 nm / 50 nm / 100 nm (switchable)	
Effective length	4" / 100 mm	
Accuracy at 20°C	$\pm 1 \mu$ m, $\pm 2 \mu$ m (custom-holder type)	
Maximum response speed	800 mm/s (For the sine wave)	
Read head size (Selectable)	Perpendicular (S-Type) 5x9.6x12 Parallel (L-Type) 6x17x10	
Main scale material (Selectable)	Quartz glass (expansion coefficient: $0.5 \times 10^{-6}$ ) (LTE) Low thermal expansion glass (expansion coefficient: $0 \pm 0.02 \times 10^{-6}$ )	
Fiber length (Selectable)	2, 3, 5, 10 m (20, 30m: custom-order)	
Maximum consumption current / operating voltage	350 mA / DC5V $\pm 5\%$	
Operating temperature and humidity	0~40°C 20~80%RH (no condensation)	
Storage temperature and humidity	-20~60°C 20~80%RH (no condensation)	
Functions	Alarm output, read-head attitude confirmation, signal-confirmation function	

- Any scale size drawings are available on request.

# Fiber Scale ST-F11

SERIES 579 — Ultra Compact Linear Scale

## Dimensions of Processor

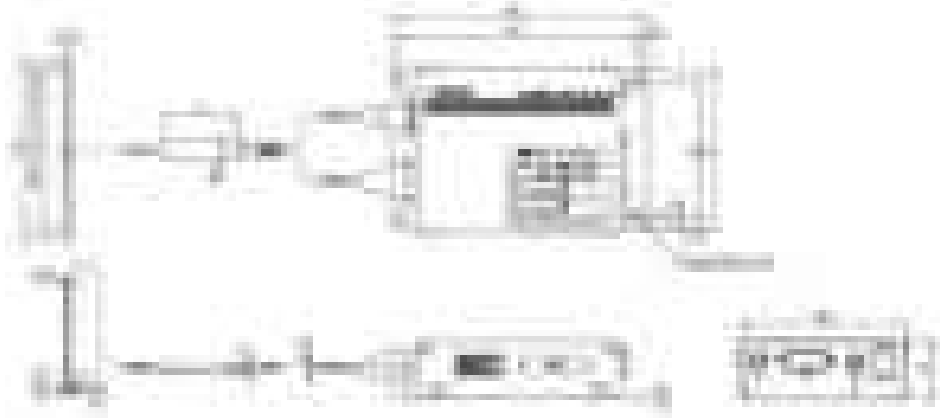

## Dimensions of Detector Heads

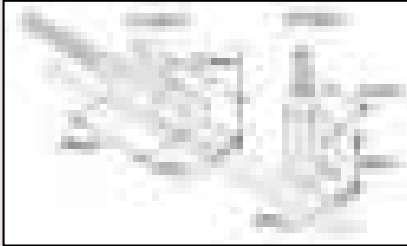

## SPECIFICATIONS

Order Number	Model Number	Output Signal	Scale Material	Detector Orientation to Scale	Fiber Length
579-701-11	ST-F11B-100A-S02	2 Phase Square	Quartz Glass	Parallel	2m
579-702-11	ST-F11B-100A-S03	2 Phase Square	Quartz Glass	Parallel	3m
579-703-11	ST-F11B-100A-S05	2 Phase Square	Quartz Glass	Parallel	5m
579-704-11	ST-F11B-100A-S10	2 Phase Square	Quartz Glass	Parallel	10m
579-701-12	ST-F11B-100B-S02	2 Phase Square	LTE Glass	Parallel	2m
579-702-12	ST-F11B-100B-S03	2 Phase Square	LTE Glass	Parallel	3m
579-703-12	ST-F11B-100B-S05	2 Phase Square	LTE Glass	Parallel	5m
579-704-12	ST-F11B-100B-S10	2 Phase Square	LTE Glass	Parallel	10m
579-701-21	ST-F11C-100A-S02	2 Phase Square / 2 phase sine	Quartz Glass	Parallel	2m
579-702-21	ST-F11C-100A-S03	2 Phase Square / 2 phase sine	Quartz Glass	Parallel	3m
579-703-21	ST-F11C-100A-S05	2 Phase Square / 2 phase sine	Quartz Glass	Parallel	5m
579-704-21	ST-F11C-100A-S10	2 Phase Square / 2 phase sine	Quartz Glass	Parallel	10m
579-701-22	ST-F11C-100B-S02	2 Phase Square / 2 phase sine	LTE Glass	Parallel	2m
579-702-22	ST-F11C-100B-S03	2 Phase Square / 2 phase sine	LTE Glass	Parallel	3m
579-703-22	ST-F11C-100B-S05	2 Phase Square / 2 phase sine	LTE Glass	Parallel	5m
579-704-22	ST-F11C-100B-S10	2 Phase Square / 2 phase sine	LTE Glass	Parallel	10m
579-711-11	ST-F11B-100A-L02	2 Phase Square	Quartz Glass	Perpendicular	2m
579-712-11	ST-F11B-100A-L03	2 Phase Square	Quartz Glass	Perpendicular	3m
579-713-11	ST-F11B-100A-L05	2 Phase Square	Quartz Glass	Perpendicular	5m
579-714-11	ST-F11B-100A-L10	2 Phase Square	Quartz Glass	Perpendicular	10m
579-711-12	ST-F11B-100B-L02	2 Phase Square	LTE Glass	Perpendicular	2m
579-712-12	ST-F11B-100B-L03	2 Phase Square	LTE Glass	Perpendicular	3m
579-713-12	ST-F11B-100B-L05	2 Phase Square	LTE Glass	Perpendicular	5m
579-714-12	ST-F11B-100B-L10	2 Phase Square	LTE Glass	Perpendicular	10m
579-711-21	ST-F11C-100A-L02	2 Phase Square / 2 phase sine	Quartz Glass	Perpendicular	2m
579-712-21	ST-F11C-100A-L03	2 Phase Square / 2 phase sine	Quartz Glass	Perpendicular	3m
579-713-21	ST-F11C-100A-L05	2 Phase Square / 2 phase sine	Quartz Glass	Perpendicular	5m
579-714-21	ST-F11C-100A-L10	2 Phase Square / 2 phase sine	Quartz Glass	Perpendicular	10m
579-711-22	ST-F11C-100B-L02	2 Phase Square / 2 phase sine	LTE Glass	Perpendicular	2m
579-712-22	ST-F11C-100B-L03	2 Phase Square / 2 phase sine	LTE Glass	Perpendicular	3m
579-713-22	ST-F11C-100B-L05	2 Phase Square / 2 phase sine	LTE Glass	Perpendicular	5m
579-714-22	ST-F11C-100B-L10	2 Phase Square / 2 phase sine	LTE Glass	Perpendicular	10m

# Pulse Signal Interface Unit PSU-200

**SERIES 539**

- The **PSU-200** splits the sinusoidal signal output by Mitutoyo linear scales into a minimum of four and a maximum of 200 divisions, and converts the signal to a square-wave signal so that NC feedback systems, measurement control devices, etc., can be used with linear scales in order to achieve highly accurate positioning.



## SPECIFICATIONS

Order No.	539-005
Model	PSU-200
Number of axes	1 axis
Input	Input connector DA-15S-N (JAE) or equivalent Input signal: 2-phase sinusoidal and the reference voltage, reference point, scale alarm
Output	Output connector: MR-20RMA (HONDA TSUSHIN KOGYO CO., LTD.) Output signal: 2-phase square wave signals (PA, PB), reference point (PZ), alarm, alarm reset, photo-coupler
Number of splits	4, 8, 10, 20, 40, 80, 100, 200 (Selectable with the switch)
Function	Setting the number of slits, setting the minimum edge interval, and maximum response speed. Detection of broken wires or short circuits and abnormalities (alarm), detection of signal errors (alarm). Power supply voltage low-alarm (warning light only), switching between high-impedance mode and alarm-signal output mode. Reference position detection light, hysteresis width settings (directly linked to No. of divisions), external alarm reset input (photocoupler), switching directions
Power supply voltage	5VDC $\pm$ 5%
Current consumption	200mA
Storage temperature range	-20°C to 70°C
Operating temperature range	0°C to 40°C
Dimensions	160(W) $\times$ 100(D) $\times$ 28(H)mm
Mass	Approx. 620g

## System configuration

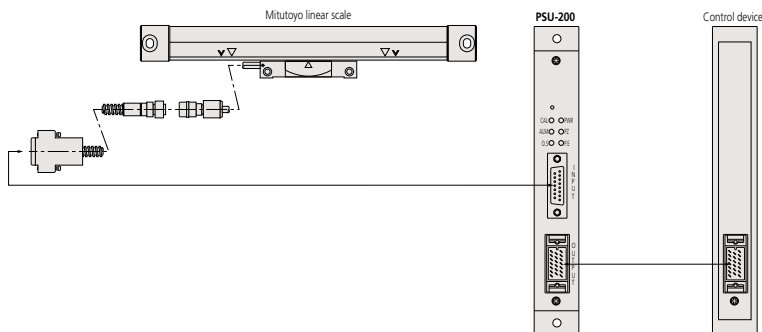

## DIMENSIONS

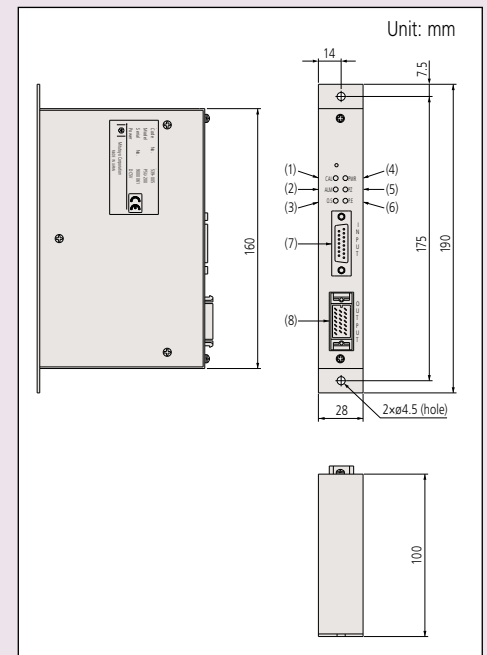

# Signal Conversion Adapter PSU-400E

SERIES 539 — Interface Unit (Optional accessories)

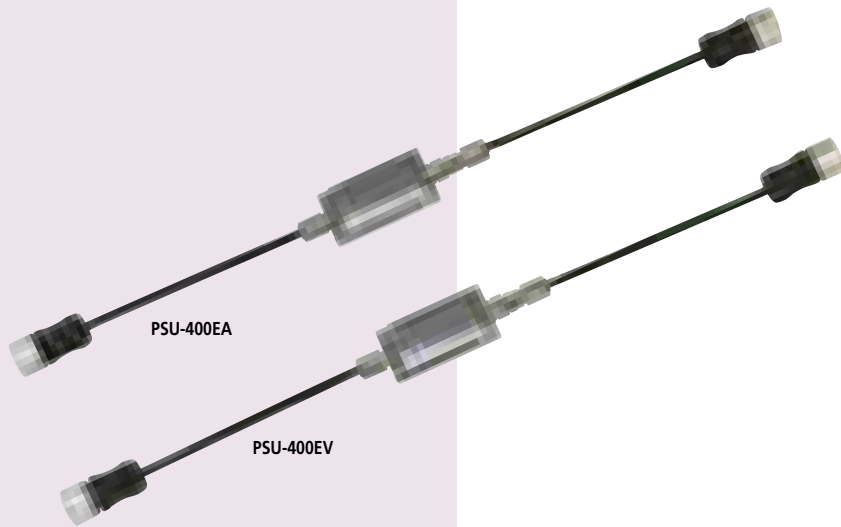

## FEATURES

- The PSU-400E series interface unit converts the 1Vp-p differential signal output by AT402E, so that NC feedback systems or measurement control devices can be used with linear scales in order to achieve highly accurate positioning.
- PSU-400EA interface unit converts the 1Vp-p differential signal output by AT402E to the 11 $\mu$ A differential signal.
- PSU-400EV interface unit splits the 1Vp-p differential signal output by AT402E into a minimum of 20 and a maximum of 4000 divisions, and converts the signal to a square wave.

## SPECIFICATIONS

Order No. Items	539-008 PSU-400EA	539-009 PSU-400EV
Input signal	1Vpp differential Sinusoidal signal (AT402E)	
Output signal	11 $\mu$ A sine wave signal	TTL signal (RS422)
Output signal: Division number (Resolution)	—	TTL X5 (1 $\mu$ m), TTL X10 (0.5 $\mu$ m), TTL X20 (0.25 $\mu$ m), TTL X25 (0.2 $\mu$ m), TTL X50 (0.1 $\mu$ m), TTL X100 (0.05 $\mu$ m), TTL X250 (0.1 $\mu$ m), TTL X500 (0.01 $\mu$ m), TTL X1000 (0.005 $\mu$ m)
Minimum edge intervals	—	62.5, 125, 250, 500, 1000, 2000 [ns]
Maximum current consumption	60mA	130mA
Power supply	DC5V $\pm$ 5%	
Storage temperature	-20 to 70°C 20 to 80%RH	
Operating temperature	0 to 50°C 20 to 80%RH	
External dimension	80(W) $\times$ 40(D) $\times$ 20(H)	
Status LED	Simple error display (without error output)	Error display (with error output)
Response speed	120m/min (100kHz)	It depends on number of interpolation and minimum edge intervals (Max: 100kHz)

TIP: Signal cable Type B is connectable.

## DIMENSIONS

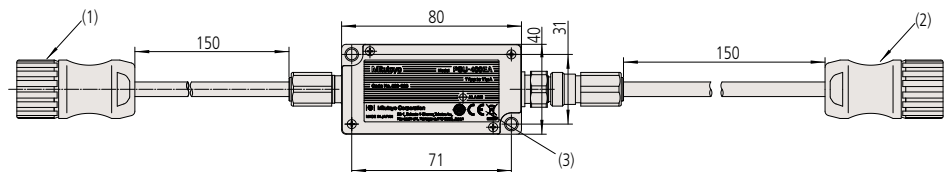

No.	Name	
(1)	INPUT connector	Connector for connecting with Linear Scale AT402E
(2)	OUTPUT connector	Connector for connecting with external device
(3)	ALM lamp	Lights red when alarming (Normally lights green)

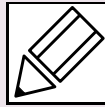

### Tests for Evaluating Linear Scales

#### 1. Testing within the service temperature range

Confirms that there is no performance abnormality of a unit within the service temperature range and that data output is according to the standard.

#### 2. Temperature cycle (dynamic characteristics) test

Confirms that there is no performance abnormality of a unit during temperature cycling while operating and that data output is according to the standard.

#### 3. Vibration test (Sweep test)

Confirms that there is no performance abnormality of a unit while subject to vibrations of a frequency ranging from 30Hz to 300Hz with a maximum acceleration of  $29.42\text{m/s}^2$ .

#### 4. Vibration test (Acceleration test)

Confirms that there is no performance abnormality of a unit subject to vibrations at a specific, non-resonant frequency. (Approx.  $98.07\text{m/s}^2$ )

#### 5. Noise test

The noise test conforms to EMC Directive EN61326-1+A1:1998.

#### 6. Package drop test

This test conforms to JIS Z 0200 (Heavy duty material drop test)

### Glossary

#### ■ Absolute system

A measurement mode in which every point measurement is made relative to a fixed origin point.

#### ■ Incremental system

A measurement mode in which every point measurement is made relative to a certain stored reference point.

#### ■ Origin offset

A function that enables the origin point of a coordinate system to be translated to another point offset from the fixed origin point. For this function to work, a system needs a permanently stored origin point.

#### ■ Restoring the origin point

A function that stops each axis of a machine accurately in position specific to the machine while slowing it with the aid of integrated limit switches.

#### ■ Sequence control

A type of control that sequentially performs control steps according to a prescribed order.

#### ■ Numerical control

A way of controlling the movements of a machine by encoded commands created and implemented with the aid of a computer (CNC). A sequence of commands typically forms a 'part program' that instructs a machine to perform a complete operation on a workpiece.

#### ■ Binary output

Refers to output of data in binary form (ones and zeros) that represent numbers as integer powers of 2.

#### ■ RS-232C

An interface standard that uses an asynchronous method of serial transmission of data over an unbalanced transmission line for data exchange between transmitters located relatively close to each other. It is a means of communication mainly used for connecting a personal computer with peripherals.

#### ■ Line driver output

This output features fast operating speeds of several tens to several hundreds of nanoseconds and a relatively long transmission distance of several hundreds of meters. A differential-voltmeter line driver (RS422A compatible) is used as an I/F to the NC controller in the linear scale system.

#### ■ BCD

A notation of expressing the numerals 0 through 9 for each digit of a decimal number by means of four-bit binary sequence. Data transmission is one-way output by means of TTL or open collector.

#### ■ RS-422

An interface standard that uses serial transmission of bits in differential form over a balanced transmission line. RS-422 is superior in its data transmission characteristics and in its capability of operating with only a single power supply of +5V.

#### ■ Accuracy

The accuracy specification of a scale is given in terms of the maximum error to be expected between the indicated and true positions at any point, within the range of that scale, at a temperature of  $20^{\circ}\text{C}$ . Since there is no international standard defined for scale units, each manufacturer has a specific way of specifying accuracy. The accuracy specifications given in our catalog have been determined using laser interferometry.

#### ■ Narrow range accuracy

Scale gratings on a scale unit normally adopt  $20\mu\text{m}$  pitch though it varies according to the kind of scale. The narrow range accuracy refers to the accuracy determined by measuring one pitch of each grating at the limit of resolution ( $1\mu\text{m}$  for example).

## ■ Principle of the Absolute Linear Scale (Example: ABS AT300, 500-S/H)

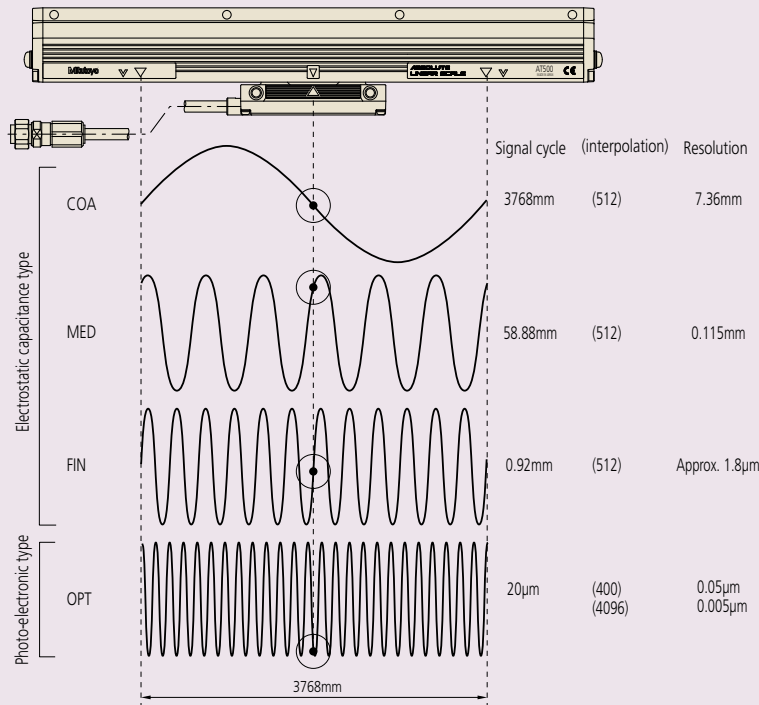

Upon supply of power to a linear scale, position readings from three capacitance-type sub-scales (COArse, MEDium and FINE) and one from a photoelectric sub-scale (OPTical) are taken. These sub-scales use such a combination of pitches, and are so positioned relative to each other, that the readings at any one position form a unique set and allow a microprocessor to calculate the position of the read head on the scale to a resolution of 0.05µm (0.005µm).

## ■ Specifying Linear Scale Accuracy

### Positional Indication accuracy

The accuracy of a linear scale is determined by comparing the positional value indicated by the linear scale with the corresponding value from a laser length measuring machine at regular intervals using the accuracy inspection system as shown in the figure below. As the temperature of the inspection environment is 20°C, the accuracy of the scale applies only in an environment at this temperature. Other inspection temperatures may be used to comply with internal standards.

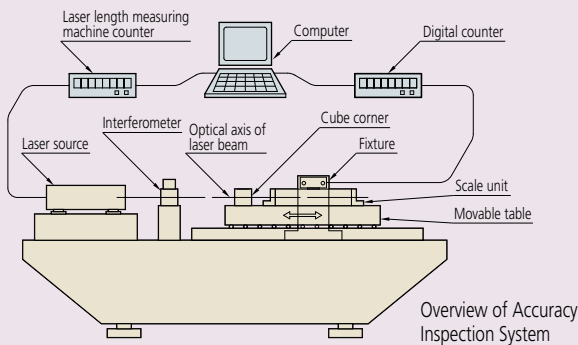

The accuracy of the scale at each point is defined in terms of an error value that is calculated using the following formula:

$$\text{Error} = \text{Value indicated by laser inspection system} - \text{Corresponding value indicated by the linear scale}$$

A graph in which the error at each point in the effective positioning range is plotted is called an accuracy diagram. There are two methods used to specify the accuracy of a scale, unbalanced or balanced, described below.

### (1) Unbalanced accuracy specification - maximum minus minimum error

This method simply specifies the maximum error minus the minimum error from the accuracy graph, as shown below. It is of the form:  $E = (\alpha + \beta L)\mu\text{m}$ .  $L$  is the effective range (mm), and  $\alpha$  and  $\beta$  are factors specified for each model.

For example, if a particular type of scale has an accuracy specification of  $(3 + \frac{3L}{1000})\mu\text{m}$  and an effective range of 1000mm,  $E$  is 6µm.

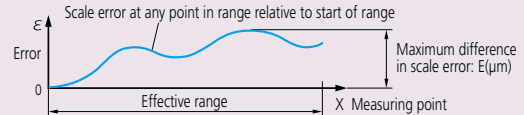

### (2) Balanced accuracy specification - plus and minus about the mean error

This method specifies the maximum error relative to the mean error from the accuracy graph. It is of the form:  $e = \pm \frac{E}{2} (\mu\text{m})$ . This is mainly used in separate-type (retrofit) scale unit specifications.

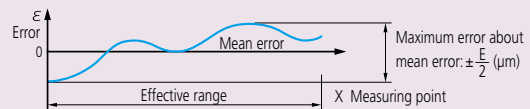

A linear scale detects displacement based on graduations of constant pitch. Two-phase sinusoidal signals with the same pitch as the graduations are obtained by detecting the graduations. Interpolating these signals in the electrical circuit makes it possible to read a value smaller than the graduations by generating pulse signals that correspond to the desired resolution. For example, if the graduation pitch is 20µm, interpolated values can generate a resolution of 1µm. The accuracy of this processing is not error-free and is called interpolation accuracy. The linear scale's overall positional accuracy specification depends both on the pitch error of the graduations and interpolation accuracy.

# MITUTOYO CUSTOM SOLUTIONS

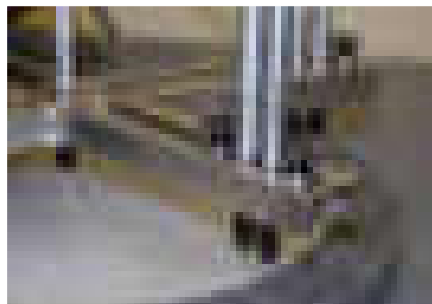
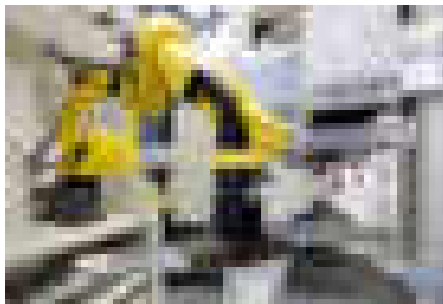
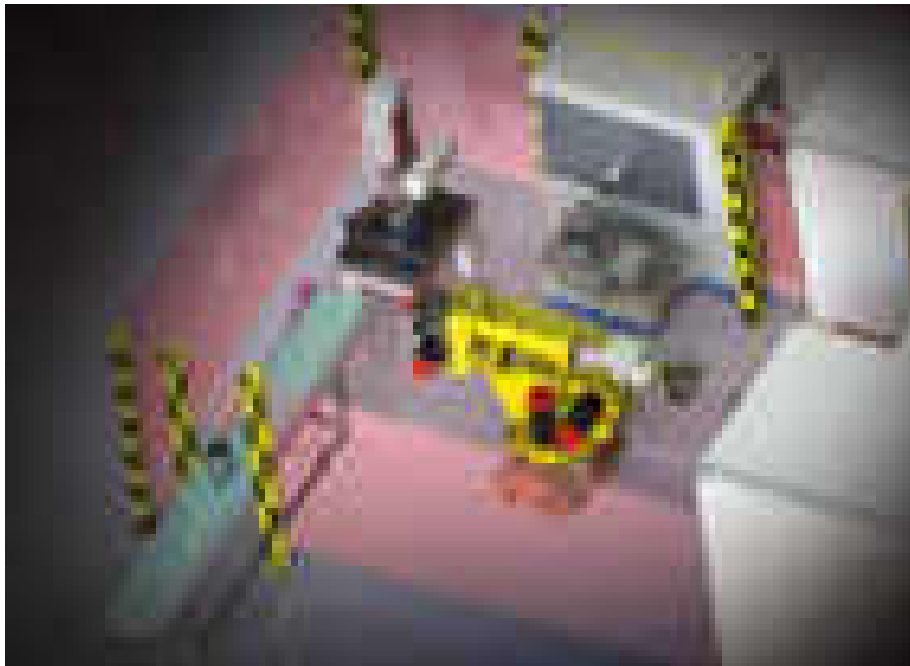

Mitutoyo Custom Solutions helps businesses in a wide range of industries achieve higher quality products, parts and machines with custom precision measurement tools and equipment.

Mitutoyo's highly skilled engineers specialize in designing and building custom measurement systems, applications and software to bring value-added solutions to resolve nearly every measurement need for customers with unique applications.

## Custom Solutions & Services Include:

- Inline/near line part inspection and gaging
- Factory automation
- Data management
- Fixture design/build
- 3D CAD concepts/renderings
- Turnkey capital projects
- Product implementation
- Custom styli/accessories
- "Green button" technology

If you have any questions or would like more information regarding Mitutoyo Custom Solutions, contact: [solutions@mitutoyo.com](mailto:solutions@mitutoyo.com)





## Profile Projectors

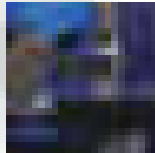

## Microscopes

### INDEX

#### Profile Projectors

PJ-A3000-Vertical	I-2,3
PJ-H30-High Accuracy	I-4,5
PV-5110	I-6,7
PH-A14	I-8,9
PH-3515F	I-10,11
Accessories for Profile Projectors	I-12
Micrometer Heads for Profile Projectors and Toolmakers' Microscopes	I-12
Workpiece Fixtures for Profile Projectors and Measuring Microscopes	I-13
Overlay Chart Set	I-14
Quick Guide to Precision Measuring Instruments - Profile Projectors	I-15

#### Microscopes

TM-505B/1005B Toolmakers' Microscopes	I-16
MF Measuring Microscopes	I-17,18
MF Motorized Type	I-19
MF-U High-power Multi-function	I-20,21
MF-U Motorized Type Universal	I-22
Accessories for Measuring Microscope	I-23,24
QM-Data200 2-D Processing Unit	I-25,26
Vision Unit System Retrofit	I-27
FS-70 For Semiconductor Inspection	I-28
VMU Video Microscope Unit	I-29
Eyepieces	I-30
Objectives	I-30-34
MSM-400 Stereo Microscopes	I-35-38
Pocket Magnifiers	I-39
Pocket Comparators	I-39
Zoom Loupe	I-39
Clear Loupe	I-39
Quick Guide to Precision Measuring Instruments - Microscopes	I-40,41



MF-B3017D

MF-UB4020D



WIDE VMU-V



VMU-LB

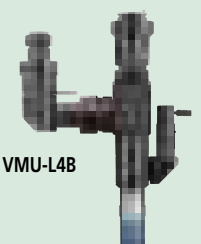

VMU-L4B

# PJ-A3000

## SERIES 302 — Vertical Profile Projectors

### FEATURES

- The PJ-A3000 Series vertical profile projectors are medium-size 11.8" (300mm) models that feature high versatility and easy operation.
- Easy-to-read digital XY counter is located near the projection screen to minimize eye movement.
- Digital readout protractor screen facilitates angle measurement.



PJ-A3010F-200



PJ-A3005D-50



PJ-A3010F-100



PJ-A3005F-150



PJ-A3010F-200

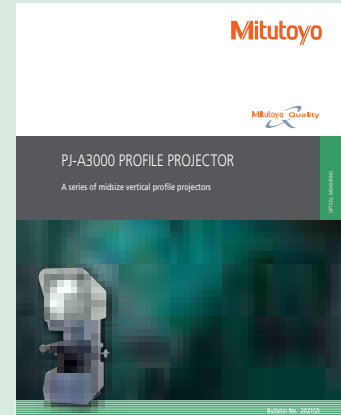

Refer to Bulletin No. (2021) for more details.

### Projection Capacity

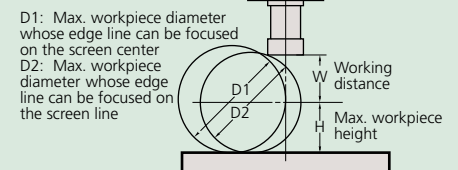

	Magnification			
	10X	20X	50X	100X
View field	ø31.5	ø15.7	ø6.3	ø3.1
W	66 (20)	32.5 (2)	12.6	5
H	-50 models*	123.5	123.5	123.5
	-100 models	91	91	91
	-150 models	103.5	103.5	103.5
	200 models	92.5	92.5	92.5
D1	-50 models*	224 (198)	87 (61)	27
	-100 models	182	87 (61)	27
	-150 models	207 (198)	87 (61)	27
	200 models	185	87 (61)	27
D2		154 (120)	69 (23)	25

( ): When using surface illumination

## Optional Accessories

- 172-202:** 10X projection lens set (Standard accessory)
- 172-203:** 20X projection lens set
- 172-223:** 10X projection lens
- 172-224:** 20X projection lens
- 172-204:** 50X projection lens
- 172-207:** 100X projection lens
- 172-229:** Oblique illumination mirror for 10X lens
- 172-230:** Oblique illumination mirror for 20X lens
- 172-116:** Standard scale (50mm)
- 172-117:** Standard scale (2")
- 172-118:** Reading scale (200mm)
- 172-161:** Reading scale (300mm)
- 172-119:** Reading scale (8")
- 172-162:** Reading scale (12")
- 172-160-2:** Green filter (for PJ-A3000, -50 models)
- 172-160-3:** Green filter (for -100, -150, -200 models)
- 512305:** Halogen bulb (24V, 150W)
- 383876:** Vinyl cover (standard accessory)

## Fixture and Stage Accessories

- 176-106:** Rotary table (Effective diameter: 66mm)
- 172-196:** Rotary table (Effective diameter: 100mm)
- 172-198:** Rotary table with fine feed wheel (Effective diameter: 4" / 100mm)
- 176-105:** Swivel center support (Max. workpiece dia.: 2.7" / 70mm)
- 172-197:** Swivel center support (Max. workpiece dia.: 3.1" / 80mm)
- 176-107:** Holder with clamp
- 172-378:** V-block with clamp (Max. workpiece dia.: 1" / 25mm)
- 176-317:** Stage adapter C
- 64PMI167:** Stand 22.4 x 20 x 32" (WxDxH)

Availability	PJ-A3005D-50	PJ-A3005F-150	PJ-A3010F-100 PJ-A3010F-200
<b>176-106</b>	✓	✓	
<b>172-196</b>		✓	✓*
<b>172-198</b>		✓	✓*
<b>176-105</b>	✓		
<b>172-197</b>		✓	✓*
<b>176-107</b>	✓	✓	✓*
<b>172-378</b>	✓	✓	✓*

\*Stage adapter C (176-317) is required for PJ-3010F-200



### QM-Data200

- 264-155A:** Stand-mount type
- 264-156A:** Arm-mount type
- 2-D data processing unit.
- (Refer to page I-25 for more details.)

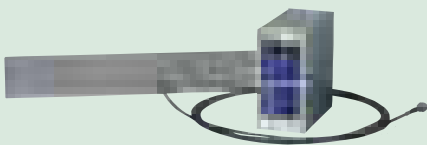

- 332-151:** Optoeye  
Edge detection system for QM-Data200
- 12AAE671:** Detector Attachment

## SPECIFICATIONS

		Model	PJ-A3010F-200	PJ-A3005F-150	PJ-A3010F-100	PJ-A3005D-50
		Order No.	302-701A	302-702A	302-703A	302-704A
Projected image		Inverted image				
Protractor screen	Effective diameter	12.4" / 315mm				
	Screen material	Fine ground glass				
	Reference line	Cross hair line				
	Angle display (LED)	Resolution: 1° or 0.01° (switchable), Range: ±360° Functions: Absolute/incremental mode switching, Zero Set				
Projection lens		Standard Accessory 10X (172-202)				
Magnification accuracy	Contour illumination	±0.1% or less				
	Surface illumination	±0.15% or less				
Contour illumination	Light source	Halogen bulb (24V, 150W)				
	Optical system	Telecentric system				
	Functions	2-stage brightness switch, Heat-absorbing filter				
Surface illumination	Light source	Halogen bulb (24V, 150W)				
	Optical system	Vertical illumination with a half-reflection mirror				
XY range		8" x 4" (200 x 100mm)	6" x 2" (150 x 50mm)	4" x 4" (100x100mm)	2" x 2" (50 x 50mm)	
Resolution		.0001" / 0.001mm	.0001" / 0.001mm	.0001" / 0.001mm	.0001" / 0.001mm	
Measuring Unit		Built-in linear scales	Built-in linear scales	Built-in linear scales	Digimatic mic heads	
Table size		14.96x9.84" (380x250mm)	11.02x5.98" (280x152mm)	9.84x9.84" (250x250mm)	5.98x5.98" (152x152mm)	
Effective table area		10.47x6.69" (266x170mm)	7.24x3.23" (184x82mm)	5.6x5.6" (142x142mm)	3.23x3.23" (82x82mm)	
Max. workpiece height		3.64" (92.5mm)	4.07" (103.5mm)	3.58" (91mm)	4.86" (123.5mm)	
Functions		± direction switching, SPC output zero-setting	Zero-setting, ± direction switching, SPC output	Zero-setting, ± direction switching, SPC output	± direction switching, SPC output zero-setting	
Power supply		120V AC, 50/60Hz				
Mass		308 lbs. (140kg)	255 lbs. (116kg)	246 lbs. (112kg)	235 lbs. (107kg)	
Standard accessories		10X projection lens set, masking shield, power cord, halogen bulb, fuse, grounding wire, allen wrench, vinyl cover				

## DIMENSIONS

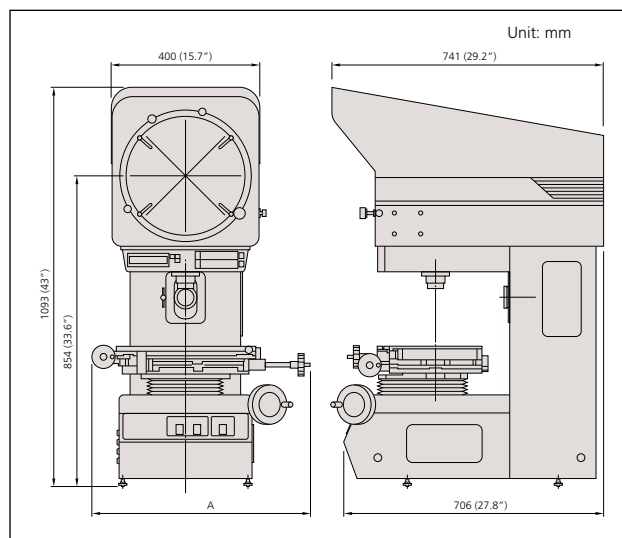

Model	PJ-A3005D-50	PJ-A3010F-100	PJ-A3005F-150	PJ-A3010F-200
<b>A</b>	17.9" / 455mm	16.8" / 427mm	17.6" / 446mm	23.3" / 593mm

# PJ-H30

## SERIES 303 — High-Accuracy Profile Projectors

By separating axial motion, and stabilizing the XY measuring table in the vertical direction, high measuring accuracy of  $(3+0.02L)\mu\text{m}$  has been achieved on the PJ-H30 Series Profile Projectors. Focusing is accomplished by moving the screen head itself up and down with the hand wheel or motorized unit. The power focusing (PJ-H30D type) provides higher performance.

### FEATURES

- Newly designed optical system with high NA lenses provides drastically brighter and clearer screen images during surface illumination.
- The three-lens mounting turret includes a 10X lens as standard. Four types of projection lenses (5X, 20X, 50X, 100X) are available.



Switchable surface illumination: vertical or oblique



Vertical illumination

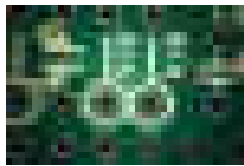

Oblique illumination



### PJ-H30A3017B

XY stage travel range: 12x7" / 300x170mm

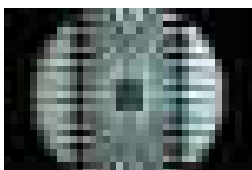
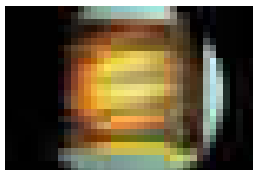
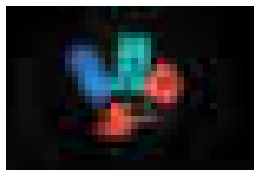
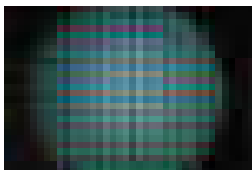

### Projection Capacity

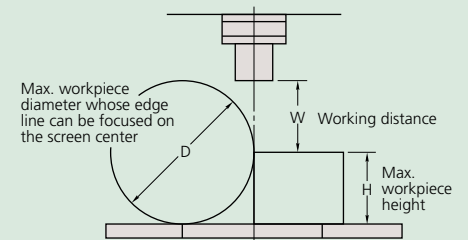

Unit: mm

	Magnification				
	5X	10X	20X	50X	100X
View field	ø61.2	ø30.6	ø15.3	ø6.12	ø3.06
H	105	105	105	105	105
W	66	70.5	56.5	50	50
D	148	197	137	114	114

## Optional Accessories

<b>172-271:</b>	5X projection lens
<b>172-472:</b>	10X projection lens (standard accessory)
<b>172-473:</b>	20X projection lens
<b>172-474:</b>	50X projection lens
<b>172-475:</b>	100X projection lens
<b>172-116:</b>	Standard scale (50mm)
<b>172-117:</b>	Standard scale (2")
<b>172-118:</b>	Reading scale (200mm)
<b>172-161:</b>	Reading scale (300mm)
<b>172-119:</b>	Reading scale (8")
<b>172-162:</b>	Reading scale (12")
<b>12AAG981:</b>	Green filter
<b>172-269:</b>	Machine stand
<b>512305:</b>	Halogen bulb (24V, 150W) (standard accessory)
<b>383876:</b>	Vinyl cover (standard accessory)

## Fixture and Stage Accessories

<b>172-198:</b>	Rotary table (Effective diameter: 4" / 100mm)
<b>176-305:</b>	Rotary table (Effective diameter: 7.2" / 183mm)
<b>176-306:</b>	Rotary table (Effective diameter: 9.4" / 240mm)
<b>176-105:</b>	Swivel center support (Max. workpiece dia.: 2.8" / 70mm)
<b>172-197:</b>	Swivel center support (Max. workpiece dia.: 3.1" / 80mm)
<b>176-107:</b>	Holder with clamp
<b>172-378:</b>	V-block with clamp (Max. workpiece dia.: 1" / 25mm)
<b>176-317:</b>	Fixture mount adapter C
<b>176-304:</b>	Fixture mount adapter A

Availability	Models	
	PJ-H30A1010B	PJ-H30A2017B
	PJ-H30D1010B	PJ-H30D2017B
	PJ-H30A2010B	PJ-H30A3017B
	PJ-H30D2010B	PJ-H30D3017B
<b>172-198</b>	✓**	✓****
<b>176-305</b>	✓**	
<b>176-306</b>		✓****
<b>176-107 *</b>	✓**	✓****
<b>172-378 *</b>	✓**	✓****
<b>172-197 *</b>	✓**	✓****
<b>176-105</b>	✓***	✓****

\*: Able to attach to a Rotary table 172-198 or 176-305 (172-197 can only attach to 176-305).  
 \*\*: Fixture mount adapter C (176-317) is required.  
 \*\*\*: Rotary table (172-198) is required.  
 \*\*\*\*: Fixture mount adapter A (176-304) is required.

## QM-Data200

**264-155A:** Stand-mount type  
**264-156A:** Arm-mount type\*  
 \*Attachment stand (12AAG982) is required.  
 2-D data processing unit.  
 (Refer to page I-25 for more details.)

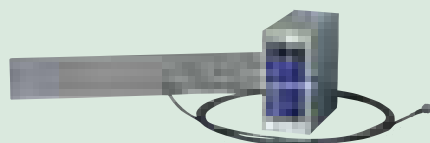

**332-151:** Optoeye  
 Edge detection system for QM-Data200  
**12AAE671:** Detector Attachment

Manual Focus type	Model No.	PJ-H30A1010B	PJ-H30A2010B	PJ-H30A2017B	PJ-H30A3017B
	Order No.	<b>303-712-1A</b>	<b>303-713-1A</b>	<b>303-714-1A</b>	<b>303-715-1A</b>
Power Focus, built-in OPTOEYE type	Model No.	PJ-H30D1010B	PJ-H30D2010B	PJ-H30D2017B	PJ-H30D3017B
	Order No.	<b>303-732-1A</b>	<b>303-733-1A</b>	<b>303-734-1A</b>	<b>303-735-1A</b>
Projected Image		Erect image			
Protractor screen	Effective diameter	12" / 306mm			
	Screen material	Fine ground glass			
	Reference line	Cross hair line			
	Screen rotation	±360°, fine feed and clamp			
	Angle display (LED)	Resolution: 1° or 0.01° (switchable), Range: ±370°, Functions: Absolute/incremental mode switching, Zero set			
Projection lens		Standard accessory: 10x (172-472), Optional accessories: 2X, 5X, 20X, 50X, 100X			
Lens mount		3-lenses mounting turret			
Magnification accuracy	Contour illumination	±0.1% or less			
	Surface illumination	±0.15% or less			
Contour illumination	Light source	Halogen bulb (24V 150W)			
	Optical system	Zoom telecentric system			
	Functions	Brightness adjustment, Heat-absorbing filter, Cooling fan			
Surface illumination	Light source	Halogen bulb (24V 150W)			
	Optical system	Vertical / Oblique illumination with an adjustable condenser lens			
	Functions	Non-stepped brightness adjustment, Heat-absorbing filter, Cooling fan			
	XY Range	4 x 4" 100 x 100mm	8 x 4" 200 x 100mm	8 x 6.7" 200 x 170mm	12 x 6.7" 300 x 170mm
	Resolution	.0001" / 0.001mm			
	Measuring unit	Built-in Linear scale			
Table size		11.8 x 9.4" 300 x 240mm	13.8 x 11" 350 x 280mm	16.1 x 13.5" 410 x 342mm	20 x 13.5" 510 x 342mm
	Effective table area	7.1 x 5.9" 180 x 150mm	9.8 x 5.9" 250 x 150mm	10.6 x 9.4" 270 x 240mm	14.6 x 9.4" 370 x 240mm
Max. workpiece ht.	4.1" / 105mm				
Max. workpiece load	22lbs / 10kg	22lbs / 10kg	44 lbs / 20kg	44 lbs / 20kg	
Power supply	120V AC, 50/60Hz				
Mass	391lbs / 176kg	396lbs / 178kg	556lbs / 205kg	471lbs / 212kg	
Standard accessories	10X projection lens set, masking shield, power cord, halogen bulb, tube fuse, grounding wire, allen wrench, vinyl cover				

## DIMENSIONS

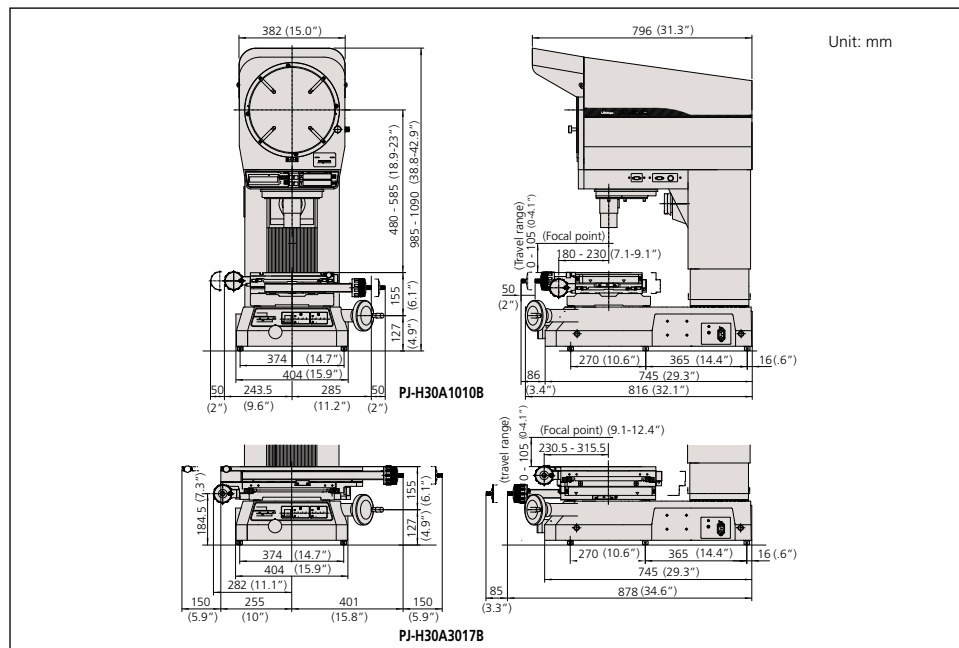

# PV-5110

## SERIES 304 — Profile Projectors

### FEATURES

- Large 500mm screen
- Floor model uses a downward illumination system.
- Digital readout protractor screen (including zero-setting, ABS/INC coordinate switching functions) for easy and error-free angle measurement.
- Angled screen allows projected images to be easily traced or compared with a template.
- The oblique surface illumination system provides clear and bright images, allowing easy inspection of non-reflective workpieces such as plastic parts or printed materials.



PV-5110



PV-5110

### Projection Capacity

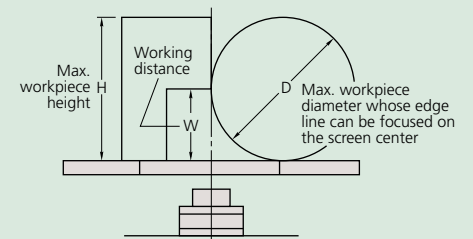

Unit: mm

	Magnification				
	5X	10X	20X	50X	100X
View field	ø101.6	ø50.8	ø25.4	ø10.16	ø5.08
H	125	181	206	87	87
W	60 (27)	60	60	32.4	22.5
D	120	120	120	64.8	45

( ): When using surface illumination

## Optional Accessories

<b>172-401:</b>	5X projection lens set
<b>172-406:</b>	5X projection lens
<b>172-402:</b>	10X projection lens set (standard accessory)
<b>172-409:</b>	10X projection lens
<b>172-403:</b>	20X projection lens set
<b>172-411:</b>	20X projection lens
<b>172-404:</b>	50X projection lens set
<b>172-413:</b>	50X projection lens
<b>172-405:</b>	100X projection lens set
<b>172-415:</b>	100X projection lens
<b>172-422:</b>	Surface illumination unit (standard accessory)
<b>172-116:</b>	Standard scale (50mm)
<b>172-117:</b>	Standard scale (2")
<b>172-118:</b>	Standard scale (200mm)
<b>172-119:</b>	Standard scale (8")
<b>172-161:</b>	Reading scale (300mm)
<b>172-329:</b>	Reading scale (600mm)
<b>172-162:</b>	Reading scale (12")
<b>172-160-2:</b>	Green filter (standard accessory)
<b>172-319:</b>	Canopy
<b>512305:</b>	Halogen bulb (24V, 150W) (standard accessory)
<b>510189:</b>	Vinyl cover

## Fixture and Stage Accessories

<b>172-196:</b>	Rotary table* (Effective diameter: 4" / 100mm)
<b>172-198:</b>	Rotary table with fine feed wheel* (Effective diameter: 4" / 100mm)
<b>172-197:</b>	Swivel center support* (Max. workpiece dia.: 3.1" / 80mm)
<b>176-107:</b>	Holder with clamp*
<b>172-378:</b>	V-block with clamp* (Max. workpiece dia.: 1" / 25mm)

\*Stage adapter C (**176-317**) is required.



**KA Counter (174-183A)**

(Refer to page H-7 for more details.)



## QM-Data200

<b>264-155A:</b>	Stand-mount type
<b>264-156A:</b>	Arm-mount type

2-D data processing unit.  
(Refer to page I-25 for more details.)

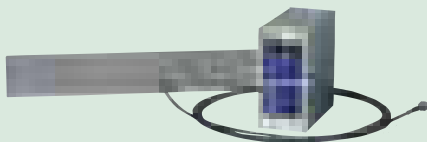

<b>332-151:</b>	<b>Optoeye</b> Edge detection system for QM-Data200
<b>12AAE672:</b>	Detector Attachment (B)

## SPECIFICATIONS

Model No.		PV-5110
Order No.		<b>304-919A*</b>
Projected image		Invert image
Protractor screen	Effective diameter	20" / 508mm
	Screen material	Fine ground glass
	Reference line	Cross hair line
	Screen rotation	±360°, fine feed and clamp
	Angle display (LED)	Resolution: 1" or 0.01"(switchable), Range: ±370°, Functions: Absolute/incremental mode switching, Zero set
Projection lens		Standard accessory: 10x(172-472), Optional accessories: 5X, 20X, 50X, 100X
Magnification accuracy	Contour illumination	±0.1% or less
	Surface illumination	±0.15% or less
Contour illumination	Light source	Halogen bulb (24V 150W)
	Optical system	Telecentric system
	Functions	2-step brightness switch, Heat-absorbing filter, Cooling fan
Surface illumination	Light source	Halogen bulb (24V 150W)
	Optical system	Vertical illumination
	Functions	Adjustable condenser lens. Oblique illumination (for 5X, 10X, and 20X), 2-step brightness switch, Heat-absorbing filter, Cooling fan
	XY Range	8 x 4" / 200 x 100mm
	Resolution	.0001" / 0.001mm*
Measuring unit		Built-in Linear scale
Table size		15 x 9.8" / 380 x 250mm
Effective table area		10.5 x 6.7" / 266 x 170mm
Max. workpiece height		See (H) on page I-6
Max. workpiece load		17.6 lbs / 8kg
Power supply		120V AC, 50/60Hz
Mass		467lbs / 210kg
Standard accessories		200x100mm (8" x 4") stage, 10X projection lens set, Surface illumination unit. Counter stand for KA counter, power cord, halogen bulb, fuse, grounding wire, allen wrench

\* Counter not included

## DIMENSIONS

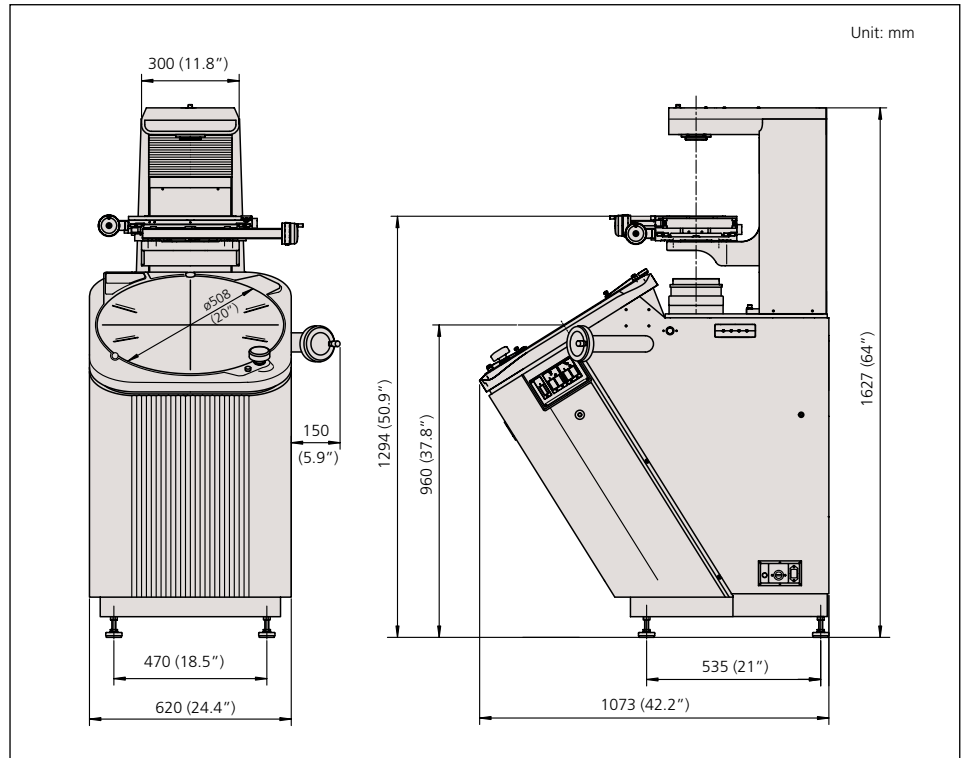

# PH-A14

## SERIES 172 — Profile Projector

### FEATURES

- Benchtop model uses a horizontal optical system.
- Suitable for thread pitch measurements—blurred or distorted images will not be produced when workpiece is angled.
- Inverted image on the day-bright screen.
- 14" (356mm) diameter vernier protractor screen with solid line cross-hairs for easy alignment.
- Heavy-duty workpiece table incorporates linear scales for fast, accurate measurement.



PH-A14



PH-A14 with touch screen M2 geometric measurement display

### Projection Capacity

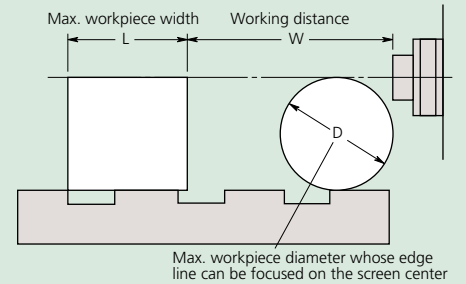

PH-A14

Unit: mm

	Magnification			
	10X	20X	50X	100X
View field	35.6	17.8	7.12	3.56
L	235	235	109	109
W	93	40	14.6	9.5
D	130	116	31.3	19.2



**KA Counter (174-183A)**  
(Refer to page H-7 for more details.)  
**64AAB149:** Counter stand



**QM-Data200**  
2-D data processing unit.  
**264-155A:** Stand mount type  
**264-156A:** Arm mount type  
(Refer to page I-25 for more details.)

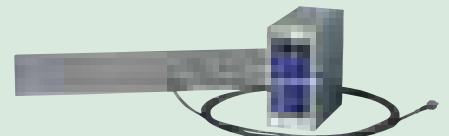

**332-151: Optoeye**  
Edge detection system for QM-Data 200  
**12AAE671:** Detector attachment (A)



## Optional Accessories

172-011:	10X projection lens (standard accessory)
172-012:	20X projection lens
172-013:	50X projection lens set
172-014:	100X projection lens set
172-116:	Standard scale (50mm)
172-117:	Standard scale (2")
172-118:	Reading scale (200mm)
172-161:	Reading scale (300mm)
172-119:	Reading scale (8")
172-162:	Reading scale (12")
172-286:	Green filter
512305:	Halogen bulb (24V, 150W) (standard accessory)

## Fixture and Stage Accessories

172-142:	Center support
172-143:	Center support riser
172-144:	Rotary vise
	(Max. workpiece dia.: 2.4" / 60mm)
172-234:	V-block with clamp
	(Max. workpiece dia.: 2" / 50mm)
172-132:	Vertical holder
64AAA129B:	Machine stand 23"W x 45"D x 20"H

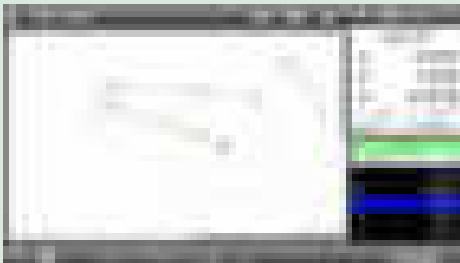

## Graphics-based "Part View" constructions

Generate popular construction types, like Distances and Tangent Lines, from within the graphical part view.



## Geometric tolerancing

Measure features, set nominals, apply tolerances and view deviation results with only a few quick clicks.

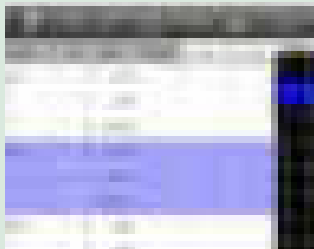

**Reports** Flexibility for report contents and formatting allows for full customization of the data format, header information, and header and footer graphics.

## SPECIFICATIONS

Model No.	PH-A14	
Order No.	172-810-10A*	
Package No.	64PKA087	PH-A14 with QM Data Arm Mount
	64PKA086A	PH-A14 with KA Counter and Tray
Projected image	Inverted image	
Protractor screen	Effective diameter	14" / 356mm
	Screen material	Fine ground glass
	Reference line	Cross hair line
	Screen rotation	±360°, fine feed and clamp
	Angle display	Vernier reading, Resolution: 2'
Projection lens	Standard accessory: 10X (172-011), Optional accessories: 20X, 50X, 100X	
Magnification accuracy	Contour illumination	±0.1% or less
	Surface illumination	±0.15% or less
Contour illumination	Light source	Halogen bulb (24V 150W)
	Optical system	Telecentric system
	Functions	Heat-absorbing filter, Cooling fan
Surface illumination	Light source	Halogen bulb (24V 150W)
	Optical system	Twin fiber optic illumination
XY Stage	Table travel (X-axis)	8" / 203.2mm
	Table size (X, Z)	16 x 6" / 407 x 153mm
	Vertical travel (Y-axis)	4" / 101.6mm
	Resolution	.00005" / 0.001mm*
	Measuring unit	Built in Linear scale
	Max. workpiece width	See (L) on page I-10
	Max. workpiece load	100lbs / 45kg
Power supply	120V AC, 50/60Hz	
Mass	308lbs / 140kg	
Standard accessories	10x projection lens set, work stage, power cord, halogen bulb, fuse, grounding wire, allen wrench	

\*Counter not included

## PH-A14 Packages with M2 Geometric Display

Order No.	Description
64PKA154A	PH-A14 PROFILE PROJECTOR - WITH TOUCH SCREEN M2 GEOMETRIC DISPLAY
64PKA155A	PH-A14 PROFILE PROJECTOR - WITH OPTICAL EDGE DETECTION AND TOUCH SCREEN M2 GEOMETRIC DISPLAY

## M2 Geometric Display Retrofit Packages

Order No.	Description
64PKA156A	M2 2D Data Processing Unit with software and hardware including a tablet PC. Also includes installation and calibration on the customer's existing PH-A14
64PKA157A	M2 2D Data Processing Unit with Edge Detection software and hardware including a tablet PC. Also includes installation and calibration on the customer's existing PH-A14

## DIMENSIONS

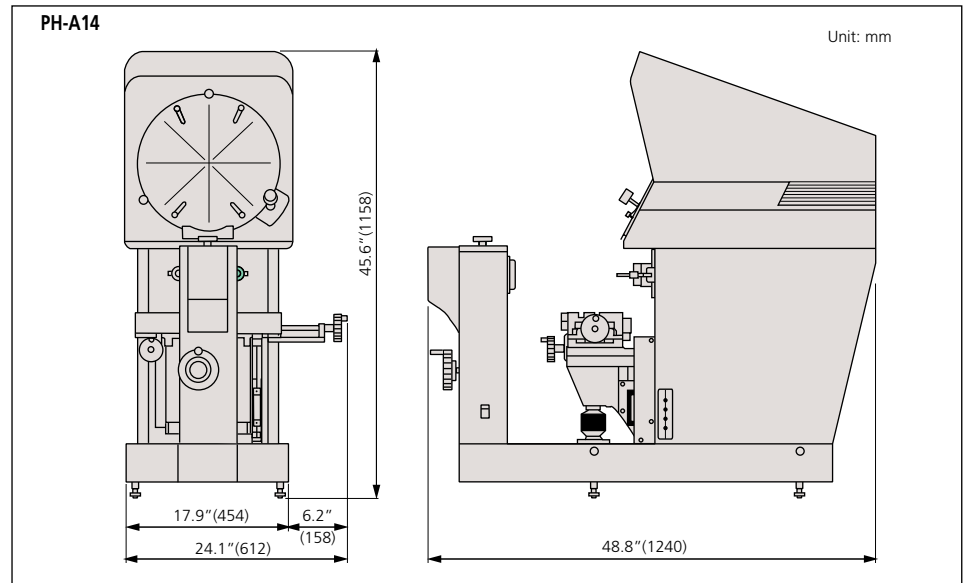

# PH-3515F

## SERIES 172 — Profile Projector

### FEATURES

- Benchtop model uses a horizontal optical system.
- Suitable for thread pitch measurements—blurred or distorted images will not be produced when workpiece is angled.
- Erect image on the day-bright screen.
- Standard twin fiber-optic illumination.
- 14" (353mm) diameter protractor screen with cross-hairs and staggered lines for easy alignment.
- Digital angle measurement to 1' or 0.01°.
- Heavy-duty workpiece table incorporates linear scales for fast, accurate measurement.
- Built-in linear scales for use with optional display counters.



PH-3515F

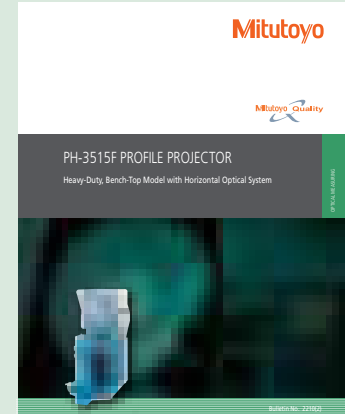

Refer to Bulletin No. (2210) for more details.

### Projection Capacity

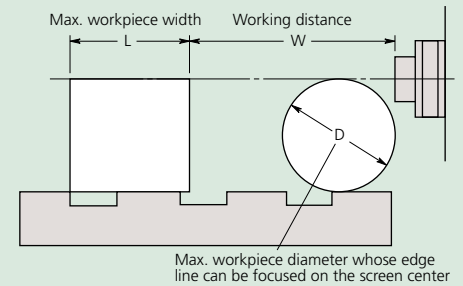

PH-3515F

Unit: mm

	Magnification				
	5X	10X	20X	50X	100X
View field	70.6	35.3	17.65	7.06	3.5
L	175	235	235	80	109
W	160 (64)	93 (41)	40	14.6	9.5
D	152.4	152.4	116	30.4	19

( ) : When using surface illumination

## Optional Accessories

<b>172-145:</b>	5X projection lens set
<b>172-175:</b>	5X projection lens
<b>172-184:</b>	10X projection lens set (standard accessory)
<b>172-011:</b>	10X projection lens
<b>172-173:</b>	20X projection lens set
<b>172-165:</b>	50X projection lens set
<b>172-174:</b>	50X projection lens
<b>172-166:</b>	100X projection lens set
<b>172-116:</b>	Standard scale (50mm)
<b>172-117:</b>	Standard scale (2")
<b>172-118:</b>	Reading scale (200mm)
<b>172-161:</b>	Reading scale (300mm)
<b>172-119:</b>	Reading scale (8")
<b>172-162:</b>	Reading scale (12")
<b>172-286:</b>	Green filter
<b>515530:</b>	Halogen bulb (24V, 150W) (standard accessory)
<b>172-423</b>	Twin surface illumination
<b>12BAA637</b>	Halogen reflector lamp (standard accessory)
<b>64AAB176</b>	Machine stand
<b>383228:</b>	Vinyl cover (standard accessory)

### Fixture and Stage Accessories\*

<b>172-142:</b>	Center support
<b>172-143:</b>	Center support riser
<b>172-144:</b>	Rotary vise (Max. workpiece dia.: 2.3" / 60mm)
<b>172-234:</b>	V-block with clamp (Max. workpiece dia.: 2" / 50mm)
<b>172-132:</b>	Vertical holder
<b>172-001:</b>	Tipped-saw support stand
<b>172-002:</b>	Cutter support stand

\* See page I-13 for details



### KA Counter (174-183A)

(Refer to page H-7 for more details.)  
**64AAB149:** Counter stand



### QM-Data200

2-D data processing unit.  
**264-155A:** Stand mount type  
**264-156A:** Arm mount type  
(Refer to page I-25 for more details.)

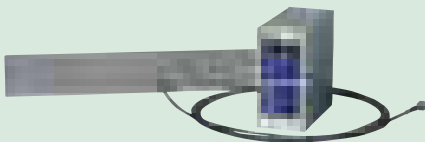

### 332-151: Optoeye

Edge detection system for QM-Data200  
**12AAE671:** Detector attachment (A)

## SPECIFICATIONS

Model No.	PH-3515F	
Order No.	172-868A*	
Projected image	Erect image	
Protractor screen	Effective diameter	14" / 353mm
	Screen material	Fine ground glass
	Reference line	Cross hair line
	Screen rotation	±360°, fine feed and clamp
	Angle display (LED)	Resolution: 1' or 0.01° (switchable), Range: ±370°, Functions: Absolute/incremental mode switching, Zero set
Projection lens	Standard accessory: 10X (172-184), Optional accessories: 5X, 20X, 50X, 100X	
Magnification accuracy	Contour illumination	±0.1% or less
	Surface illumination	±0.15% or less
Contour illumination	Light source	Halogen bulb (24V 150W)
	Optical system	Telecentric system
	Functions	2-step brightness switch, Heat-absorbing filter, Cooling fan
Surface illumination (Optional accessories)	Light source	Halogen bulb (24V 150W)
	Functions	Adjustable condenser lens, Heat-absorbing filter, Cooling fan
XY Stage	Table travel (X-axis)	10" / 254mm
	Table size (X, Z)	17.7" x 5.7" / 450 x 146mm
	Vertical travel (Y-axis)	6" / 152mm
	Resolution	0.001mm / 0.00005"*
	Measuring Unit	Built-in Linear scale
	Max. workpiece width	See (L) on page I-10
	Max. workpiece load	100lbs / 45kg
	Power supply	120V AC, 50/60Hz
Mass	333lbs / 150kg	
Standard accessories	10X projection lens set, work stage, power cord, halogen bulb, tube fuse, grounding wire, allen wrench, Vinyl cover	

\* Counter not included

## DIMENSIONS

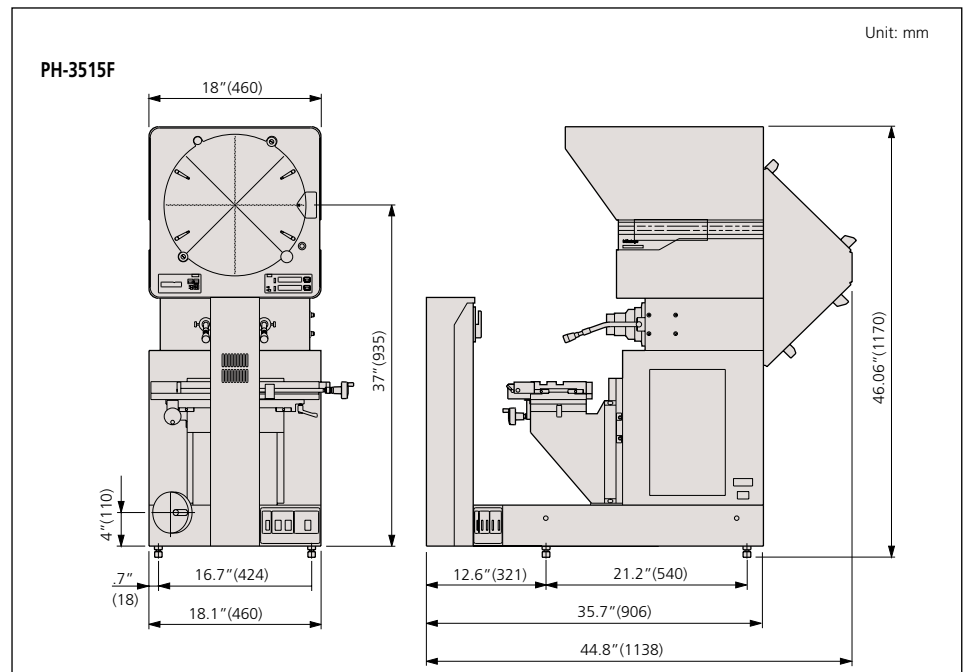

# Accessories for Profile Projectors

## SERIES 172 — Profile Projector

### Standard Scales



172-116

- Used for checking magnification accuracy.

### SPECIFICATIONS

Metric			
Graduation	Range	Order No.	Accuracy (20°C)*
0.1mm	50mm	172-116	(3+5L/1000)µm
0.1mm	80mm	172-330	(3+5L/1000)µm

\*L = Measured length (mm)

Inch			
Graduation	Range	Order No.	Accuracy (20C)
.01"	2"	172-117	.00013"

### Reading Scales

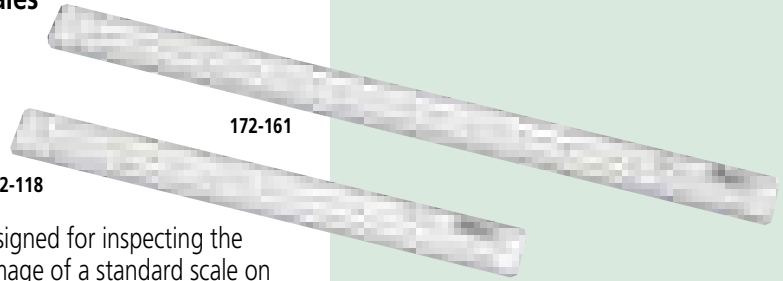

172-118

172-161

- Specially designed for inspecting the magnified image of a standard scale on the projection screen.

### SPECIFICATIONS

Metric			
Graduation	Range	Order No.	Accuracy
0.5mm	200mm	172-118	18µm (15+15L/1000)µm
0.5mm	300mm	172-161	19.5µm (15+15L/1000)µm
0.5mm	600mm	172-329	24µm (15+15L/1000)µm

Inch			
Graduation	Range	Order No.	Accuracy
.02"	8"	172-119	.00071"
.02"	12"	172-162	.00077"

## Micrometer Heads

### for Profile Projectors and Toolmakers' Microscopes

#### Micrometer Heads for XY Stage

##### FEATURES

- Non-rotating device is provided.
- The thimble reading can be zero-set at any spindle position.
- Black and red figures of the bi-directional graduation allow easy reading in both directions.
- Clamping stem diameter: 18mm

##### SPECIFICATIONS

Metric				
Graduation	Range	Order No.	Accuracy	Remarks
0.005mm	25mm	152-390	±2µm	for X-axis
0.005mm	25mm	152-389	±2µm	for Y-axis

Inch				
Graduation	Range	Order No.	Accuracy	Remarks
.0001"	1"	152-391	±.0001"	for X-axis
.0001"	1"	152-392	±.0001"	for Y-axis

#### Adjustable Micrometer Heads for XY Stages

##### FEATURES

- The adjustable spindle can be fed under the thimble clamped at any reading, allowing easy reference point setting.
- The spherical measuring face is carbide-tipped.
- Clamping stem diameter: 18mm

##### SPECIFICATIONS

Metric				
Graduation	Range	Order No.	Accuracy	Remarks
0.001mm*	25mm	152-402	±2µm	for X-axis
0.001mm*	25mm	152-401	±2µm	for Y-axis

\*Obtained using vernier.



152-390

#### Digimatic Micrometer Heads

##### FEATURES

- Large LCD digits for error-free reading.
- The display rotates 330° for easy viewing.
- The spindle does not rotate.
- With SPC data output.

##### SPECIFICATIONS

Inch/Metric			
Resolution	Range	Order No.	Accuracy
.00005"/0.001mm	2" (50mm)	164-164	±.00015"

##### Optional Accessories

- 959149: SPC cable for series 164 (1m)
- 959150: SPC cable for series 164 (2m)



164-164

# Workpiece Fixtures

## for Profile Projectors and Measuring Microscopes

### Rotary Tables

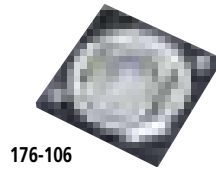

176-106

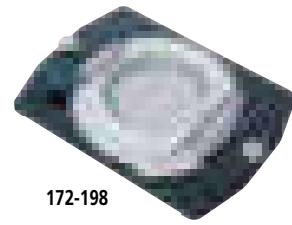

172-198

### SPECIFICATIONS

Order No.	176-106	172-198
Effective glass dia.	66mm	100mm
Angle reading	6'	2' (w/ fine adjustment)
Mass	1.7kg	2.5kg

Note: Holder with clamp (176-107) can be mounted.

### Holder with Clamp

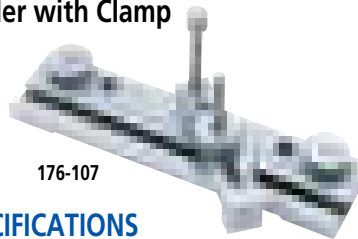

176-107

### SPECIFICATIONS

Order No.	176-107
Max. workpiece height	35mm
Mass	0.42kg

### Center Support

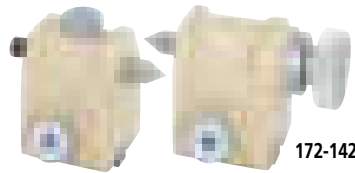

172-142

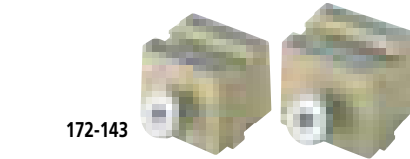

172-143

### SPECIFICATIONS

Order No.	172-142
Max. workpiece height	120mm (240mm)*
Mass	3.3kg

\*When using a center support riser (172-143)

### Rotary Vise

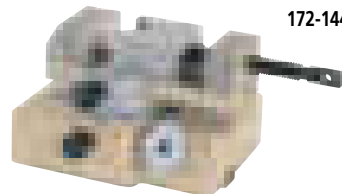

172-144

### SPECIFICATIONS

Order No.	172-144
Max. workpiece height	60mm
Width of jaw	40mm
Angle reading	5°
Mass	2.5kg

### Swivel Center Supports



176-105

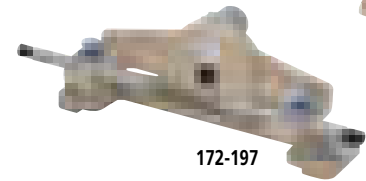

172-197

### SPECIFICATIONS

Order No.	176-105	172-197
Max. workpiece dia.	70mm (45mm)*	80mm (65mm)*
Max. workpiece length	140mm	140mm
Swivel range	±10°	±10°
Mass	2.4kg	2.5kg

\*When swiveled 10°

### V-Block with Clamp



172-234

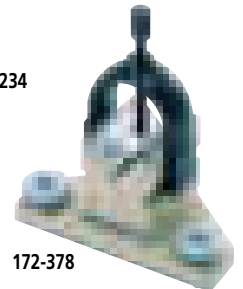

172-378

### SPECIFICATIONS

Order No.	172-234	172-378
Max. workpiece dia.	50mm	25mm
Width of block	60mm	41mm
Mass	1.24kg	0.8kg

### Vertical Holder

172-132



### SPECIFICATIONS

Order No.	172-132
Mass	1.3kg

# Overlay Chart Set

- Makes inspection of projected images an easy process.
- Twelve different patterns are available in the set.
- Designed for use with profile projectors whose screen diameter is 300mm or larger.

## Overlay chart set (12 sheets)

Order No.: 12AAM027

### 12AAM587

Protractor (1°-grad. radial index) and radius (1mm-radius increment concentric semicircles)

### 12AAM588

Radius (0.1cm-reading scales and 5mm-radius increment concentric circles)

### 12AAM589

Radius (1X, 10X, 20X, 50X)

### 12AAM590

1mm-reading scales (20X, 50X)

### 12AAM591

10x10mm sections

### 12AAM592

0.5mm-reading scales

### 12AAM593

1x1mm sections

### 12AAM594

Protractor (1°-grad. diametral index)

### 12AAM595

1mm-reading vertical scale

### 12AAM596

Protractor (1°-grad. diametral index) and radius (1mm-radius increment concentric circles)

### 12AAM597

Metric, Unified, and Whitworth screw threads (20X)

### 12AAM598

Metric screw thread (100X) and 20° and 14.5° gear teeth (20X)

# Quick Guide to Precision Measuring Instruments

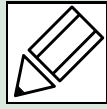

## Profile Projectors

### Erect Image and Inverted Image

An image of an object projected onto a screen is erect if it is orientated the same way as the object on the stage. If the image is reversed top to bottom, left to right and by movement with respect to the object on the stage (as shown in the figure below) it is referred to as an inverted image (also known as a reversed).

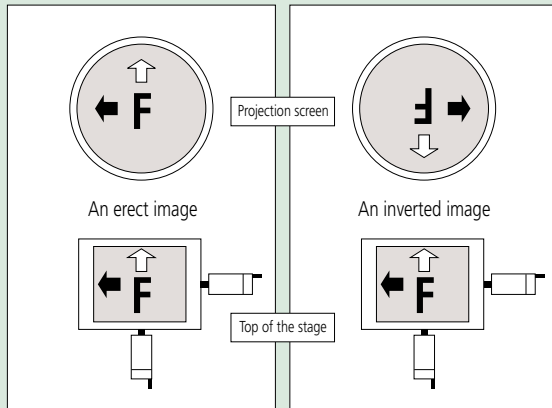

F Workpiece  
 ← X-axis movement  
 ↕ Y-axis movement

### Magnification Accuracy

The magnification accuracy of a projector when using a certain lens is established by projecting an image of a reference object and comparing the size of the image of this object, as measured on the screen, with the expected size (calculated from the lens magnification, as marked) to produce a percentage magnification accuracy figure, as illustrated below. The reference object is often in the form of a small, graduated glass scale called a 'stage micrometer' or 'standard scale', and the projected image of this is measured with a larger glass scale known as a 'reading scale'.

(Note that magnification accuracy is not the same as measuring accuracy.)

$$\Delta M(\%) = \frac{L - \ell M}{\ell M} \times 100$$

$\Delta M(\%)$ : Magnification accuracy expressed as a percentage of the nominal lens magnification  
 L: Length of the projected image of the reference object measured on the screen  
 $\ell$ : Length of the reference object  
 M: Magnification of the projection lens

### Type of Illumination

- **Contour illumination:** An illumination method to observe a workpiece by transmitted light and is used mainly for measuring the magnified contour image of a workpiece.
- **Coaxial surface illumination:** An illumination method whereby a workpiece is illuminated by light transmitted coaxially to the lens for the observation/measurement of the surface. (A half-mirror or a projection lens with a built-in half-mirror is needed.)
- **Oblique surface illumination:** A method of illumination by obliquely illuminating the workpiece surface. This method provides an image of enhanced contrast, allowing it to be observed three-dimensionally and clearly. However, note that an error is apt to occur in dimensional measurement with this method of illumination. (An oblique mirror is needed. Models in the PJ-H30 series are supplied with an oblique mirror.)

### Telecentric Optical System

An optical system based on the principle that the primary ray is aligned parallel to the optical axis by placing a lens stop on the focal point on the image side. Its functional feature is that the image will not vary in size even though the image blurs as the object is shifted along the optical axis. For measuring projectors and measuring microscopes, an identical effect is obtained by placing a lamp filament at the focal point of a condenser lens instead of a lens stop so that the object is illuminated with parallel beams. (See the figure below.)

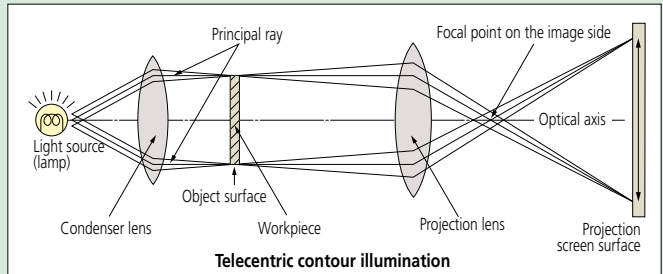

### Working distance

Refers to the distance from the face of the projection lens to the surface of a workpiece in focus. It is represented by L in the diagram below.

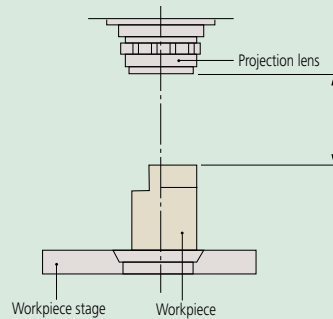

### Parallax error

This is the displacement of an object against a fixed background caused by a change in the observer's position and a finite separation of the object and background planes.

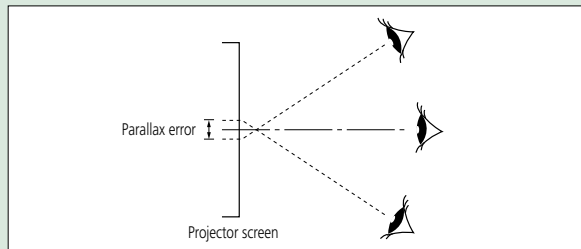

### Field of view diameter

The maximum diameter of the workpiece that can be projected using a particular lens.

$$\text{Field of view diameter (mm)} = \frac{\text{Screen diameter of profile projector}}{\text{Magnification of projection lens used}}$$

Example: If a 5X magnification lens is used for a projector with a screen of  $\phi 500\text{mm}$ :

$$\text{Field of view diameter is given by } \frac{500\text{mm}}{5} = 100\text{mm}$$

# TM-505B/1005B

## SERIES 176 — Toolmakers' Microscopes

The Mitutoyo TM Series is a toolmakers' microscope well suited for measuring dimensions and angles of machined metals. It also can be used to check the shape of screws and gears by attaching an optional reticle. The compact body makes it ideal for use on shop floors with limited space.

### FEATURES

- Angle measurement is performed easily by turning the angle scale disc to align the cross-hair reticle with the workpiece image.

- Illumination intensity can be adjusted.
- Included standard accessories create an overall magnification of 30X. Magnifications can be changed from 20 - 200X by using optional objectives and/or eyepieces.



### SPECIFICATIONS

Model No.	TM-505B	TM-A505B	TM-1005B	TM-A1005B
Order No.	176-818A	176-820A	176-819A	176-821A
Objective lens	Standard accessory: 2X, Options: 5X, 10X			
Microscope head	Maximum height of workpiece	4.53" / 115mm	4.21" / 107mm	
Illumination unit	Transmitted illumination	Stepless brightness adjustment, White LED light source, With green filter		
	Surface illumination	Oblique single-source type, Stepless brightness adjustment, White LED light source		
Cross-travel stage	Measuring range	2" x 2" / 50x50mm	4" x 2" / 100x50mm (An optional 2"/50mm gauge block is required to cover full range. A CERA block is recommended.)	
	Table size	6" x 6" / 152x152mm	9.44" x 6" / 240x152mm	
	Usable area of the stage glass	3.8" x 3.8" / 96x96mm	6" x 3.8" / 154x96mm	
Linear measurement method	Micrometer heads optional	Micrometer heads included	Micrometer heads optional	Micrometer heads included
Resolution	N/A	.00005"/1μm	N/A	.00005"/1μm
Micrometer head travel range	N/A	2"/50mm	N/A	2"/50mm

### DIMENSIONS

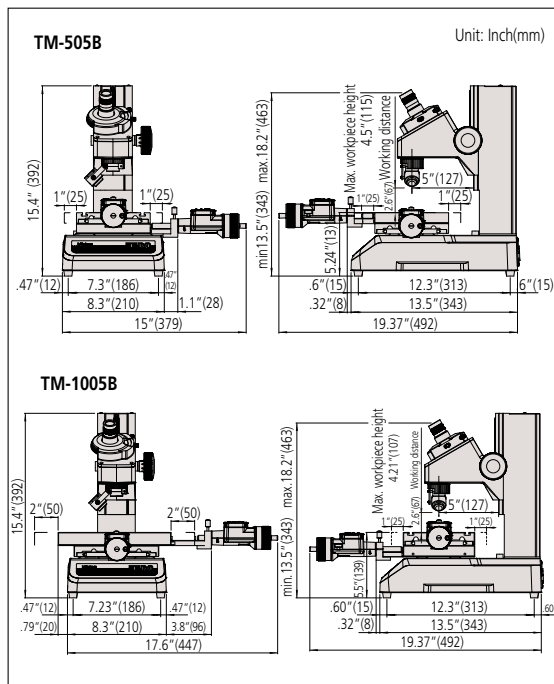

### Technical Data

Optical tube	<ul style="list-style-type: none"> <li>• Monocular with 30° depression angle</li> <li>• 90° broken cross-hair reticle (176-126)</li> <li>• Erect image</li> <li>• Diopter adjustable</li> </ul>
Eyepiece protractor	<ul style="list-style-type: none"> <li>• Graduation: 1°</li> <li>• Protractor range: 360°</li> <li>• Minimum reading by vernier: 6'</li> </ul>
Eyepiece (176-116)	<ul style="list-style-type: none"> <li>• Magnification: 15X</li> <li>• Field number: 13</li> </ul>
Objective (176-138)	<ul style="list-style-type: none"> <li>• Magnification: 2X</li> <li>• Working distance: 2.638" (67mm)</li> <li>• Numerical aperture: 0.07</li> </ul>
Total magnification	• 30X
Transmitted illumination	<ul style="list-style-type: none"> <li>• 3W LED</li> <li>• GIF (green) filter</li> <li>• Stepless intensity adjustment</li> </ul>
Reflected illumination	<ul style="list-style-type: none"> <li>• 3W LED</li> <li>• Stepless intensity adjustment</li> <li>• Adjustable position</li> </ul>
Power supply	120 V AC, 50/60Hz
Power consumption	4.2W
Mass	TM-505B: Approx. 30.8 lbs. (14kg) TM-1005B: Approx. 33 lbs. (15kg)

### Optional Accessories

- 176-115: 10X eyepiece (field number: 13mm)
- 176-116: 15X projection lens set (standard accessory)
- 176-117: 20X eyepiece (field number: 10mm)
- 176-138: Objective, 2X (W.D.: 67mm, N.A.: 0.07) (standard accessory)
- 176-139: Objective, 5X (W.D.: 33mm, N.A.: 0.10)
- 176-137: Objective, 10X (W.D.: 14mm, N.A.: 0.14)
- 164-163: Digimatic micrometer head (range: 50mm, reading: 0.001mm)
- 164-164: Digimatic micrometer head (range: 2"/50mm, reading: .00005"/0.001mm)
- 152-390: Micrometer head for X-axis (range: 25mm, reading: 0.005mm)
- 152-389: Micrometer head for Y-axis (range: 25mm, reading: 0.005mm)
- 152-392: Micrometer head for Y-axis (range: 1", reading: .0001")
- 152-391: Micrometer head for X-axis (range: 1", reading: .0001")
- 611201-531: Rectangular gauge block (1")
- 611202-531: Rectangular gauge block (2")
- 176-204: Dial indicator attachment for Z-axis measurement
- 959149: SPC cable (2m) for Digimatic micrometer head

### Fixture and Stage Accessories

- 990561: Workpiece clip (2pcs/set)
- 176-106: Rotary table for TM-505B (effective dia.: 66mm)
- 172-196: Rotary table for TM-1005B (effective dia.: 100mm)
- 176-105: Swivel center support for TM-505B (max. workpiece dia.: 2.7" / 70mm)
- 172-197: Swivel center support for TM-1005B (max. workpiece dia.: 3.1" / 80mm)
- 172-378: V-block with clamp (max. workpiece dia.: 1" / 25mm)
- 176-107: Holder with clamp

### Illumination Units

- 176-344A: Bifurcated fiber illuminator
- 64AAB214: LED variable ring light
- 176-208A: LED circular illumination

### Reticles

- 176-126: Broken cross-hair (90°) (standard accessory)
- 176-111: Concentric circles (up to ø4mm, 0.05mm increment)
- 176-135: Concentric circle (up to ø.2", .01" increment)
- 176-114: 60° angle

### Protractor eyepiece



### LED ring light 64AAB214

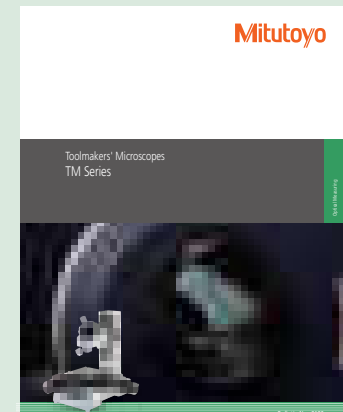

Refer to Bulletin No. (2190) for more details.



# MF

## SERIES 176 — Measuring Microscopes

### Technical Data

Optical tube	<ul style="list-style-type: none"> <li>• Monocular or Binocular (<b>Must Choose</b>)</li> <li>• 25° depression angle</li> <li>• 90° broken cross-hair reticle (12AAG836)</li> <li>• Erect image</li> <li>• TV Mount 50/50</li> </ul>
Observation image	• Erect Image
Observation type	• Bright Field
Eyepiece lens	<ul style="list-style-type: none"> <li>• 10x (Included w/Tube)</li> <li>• 15x (Optional)</li> <li>• 20x (Optional)</li> </ul>
Objective	<ul style="list-style-type: none"> <li>• Magnification: 3X (Included)</li> <li>• W.D.: 3.03" (77mm); N.A.: .09</li> <li>• Optional: 1x, 5x, 10x, 20x, 50x, 100x</li> </ul>
Light source	<ul style="list-style-type: none"> <li>• Halogen or LED (<b>Must Choose</b>)</li> <li>• Adjustable aperture diaphragms</li> <li>• Light intensity infinitely adjustable</li> </ul>
Transmitted illumination	• Telecentric illumination
Reflected illumination	• Koehler illumination
<b>Display Unit</b>	
Number of axis	• 2 axes (MF-A Type) or 3 axes (MF-B Type)
Resolution	• 0.0001" / 0.00005" / 0.00001" (0.001 mm / 0.0005 mm / 0.0001 mm)
Functions	• Data output, Axis linear compensation, Metric or English Units, and more
Stage	<ul style="list-style-type: none"> <li>• Precision travel (2.2+0.02L)µm accuracy</li> <li>• High-accuracy linear glass scales</li> <li>• Quick-release floating mode</li> <li>• Zero-set button</li> </ul>
Power consumption	45W LED, 160W Halogen, 120V AC, 50/60 Hz
Mass	<ul style="list-style-type: none"> <li>• 1010D - 148 lbs. / 67 kg</li> <li>• 2010D - 157 lbs. / 71 kg</li> <li>• 2017D - 326 lbs. / 148 kg</li> <li>• 3017D - 344 lbs. / 156 kg</li> <li>• 4020D - 357 lbs. / 162 kg</li> </ul>

### LED and Halogen Light Options for Transmitted and Reflected Illumination (Common to MF D and MF-U D)



Transmitted LED illumination unit (Common to MF/MF-U Series)    Reflected LED illumination unit (for MF Series)    Reflected LED illumination unit (for MF-U Series)



LED illumination



Halogen illumination

### High Visibility Digital Display (Common to MF D and MF-U D)



Front of display

Rear of display

The MF measuring microscopes can be combined with Mitutoyo's vision unit to boost its performance and data management on a PC, further improving measuring efficiency and productivity.

### FEATURES

- Observation with a crisp and high-resolution erect image and a wide field of view
- Measuring accuracy that is highest in its class (and conforms to JIS B 7153)
- ML series, high-NA objectives that are specially designed for the MF series (long working distance type)
- Illumination unit (reflected/transmitted) selectable from a high-intensity LED or halogen bulb (selection required)
- Variable aperture diaphragm (reflected/transmitted) allows observation measurement while suppressing light diffraction
- Variety of standardized stages in sizes up to 400x200mm
- Quick-release mechanism useful for moving the stage quickly when measuring workpieces that are large in size or quantity
- Coarse/fine feed handles equipped as standard on both sides allow precise focus and observation measurement regardless of handedness
- High-magnification eyepiece observation up to 2000x
- Standard measuring microscope has a wide variety of optional accessories including a vision unit and various digital CCD cameras



**MF-B2017D**  
XY stage travel range: 8 x 6.6" / 200 x 170mm (with optional binocular tube)



Using optional slide-type nosepiece with 2-lens mount (factory set option)

### Selection of XY stage by travel range

**1010D:** 4 x 4" / 100 x 100mm



**2010D:** 8 x 4" / 200 x 100mm



**2017D:** 8 x 6.7" / 200 x 170mm



**3017D:** 12 x 6.6" / 300 x 170mm



**4020D:** 16 x 8" / 400 x 200mm



# MF

## SERIES 176 — Measuring Microscopes

### SPECIFICATIONS

Model No. (XY stage size)	1010D	2010D	2017D	3017D	4020D	
Order No.	MF-A	<b>176-861-10</b>	<b>176-862-10</b>	<b>176-863-10</b>	<b>176-864-10</b>	<b>176-865-10</b>
	MF-B	<b>176-866-10</b>	<b>176-867-10</b>	<b>176-868-10</b>	<b>176-869-10</b>	<b>176-870-10</b>
XY stage travel range	4 x 4" 100 x 100mm	8 x 4" 200 x 100mm	8 x 7" 200 x 170mm	12 x 7" 300 x 170mm	16 x 8" 400 x 200mm	
Z-axis travel range	6" / 150mm		8.7" / 220mm			
Focusing method	Manual focusing (Coarse focusing: 30mm/rev., Fine focusing: 0.2mm/rev.)					
Measurement method	Linear encoder (2-axis model: X / Y-axis, 3-axis model: X / Y / Z-axis)					
Resolution (switchable)	.0001" / .00005" / .00001" (0.001mm / 0.0005mm / 0.0001mm)					
Measuring accuracy (at 20°C)	XY-axis: (2.2+0.02L) $\mu$ m, L = Measuring length (mm) when not loaded, JIS B 7153					
Indication accuracy (at 20°C)	Z-axis: (5+0.04L) $\mu$ m, L = Measuring length (mm), (MF-B type)					
Floating function	X and Y axes with Quick-release mechanism					
XY stage top size	11 x 11" 280 x 280mm	14 x 11" 350 x 280mm	16.1 x 13.4" 410 x 342mm	20.07 x 13.4" 510 x 342mm	24" x 13.4" 610 x 342mm	
Effective glass size	7 x 7" 180 x 180mm	10 x 6" 250 x 150mm	10.6 x 9.4" 270 x 240mm	14.5 x 9.4" 370 x 240mm	17.3 x 9.4" 440 x 240mm	
Swivel function	—		$\pm$ 5° (left)		$\pm$ 3° (left)	
Max. stage loading	22lbs / 10kg		44lbs / 20kg		33lbs / 15kg	
Max. workpiece height	6" / 150mm		8.7" / 220mm			

### MF Selection of Machine Type (must select)

	1010	2010	2017	3017	4020	Counter	Motorized stage	Optics
<b>A</b>	<b>176-861-10</b>	<b>176-862-10</b>	<b>176-863-10</b>	<b>176-864-10</b>	<b>176-865-10</b>	X,Y	Manual	BF
<b>B</b>	<b>176-866-10</b>	<b>176-867-10</b>	<b>176-868-10</b>	<b>176-869-10</b>	<b>176-870-10</b>	X,Y,Z	Manual	BF
<b>J</b>	-	-	<b>176-891A</b>	<b>176-892A</b>	<b>176-893A</b>	X,Y,Z	Z only	BF

Example: MF-A1010D results in part number 176-861-10

### Illumination Unit (must select)

Applicable Illumination Unit	LED	Halogen
Order No.	<b>176-445A</b>	<b>176-447A</b>

### Eye Tube Selection (must select)

Monocular with 10X eyepiece	<b>176-392</b>
Binocular with 10X eyepiece	<b>176-393</b>

### DIMENSIONS

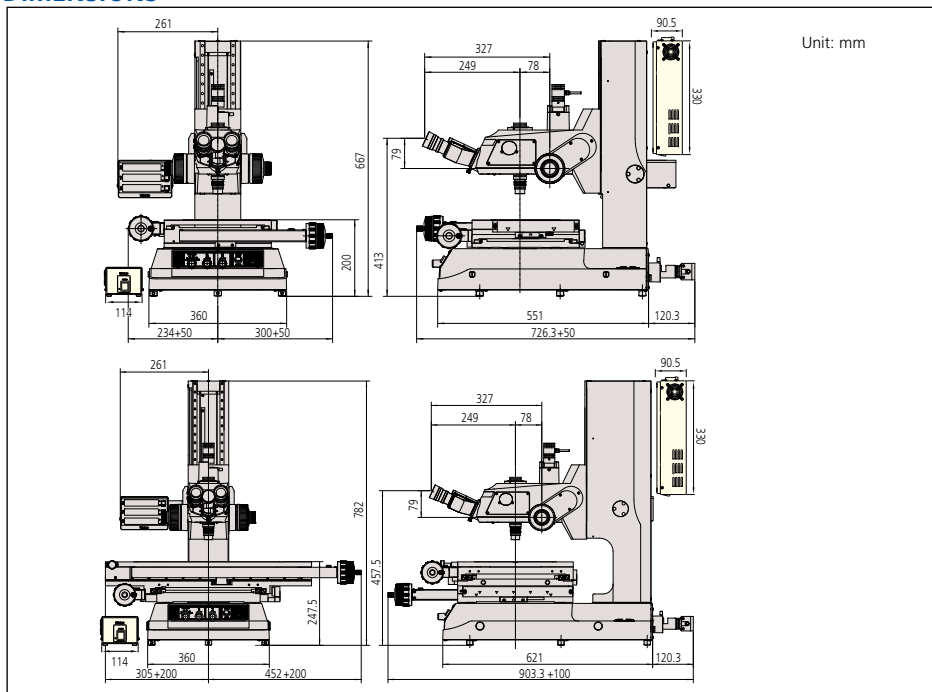

### Optional Accessories

- 176-392:** Monocular tube with 10X eyepiece
- 176-393:** Binocular tube with 10X eyepiece set
- 378-866:** 10X eyepiece set (view field dia.: 24mm)
- 378-857:** 15X eyepiece set (view field dia.: 16mm)
- 378-858:** 20X eyepiece set (view field dia.: 12mm)
- 375-043:** Protractor eyepiece (10X)
- 176-313:** Digital protractor eyepiece (10X)
- 375-036-2:** 1X objective (W.D.: 61mm, N.A.: 0.03)
- 375-037-1:** 3X objective (W.D.: 77mm, N.A.: 0.09) (std. accessory)
- 375-034-1:** 5X objective (W.D.: 61mm, N.A.: 0.13)
- 375-039:** 10X objective (W.D.: 51mm, N.A.: 0.21)
- 375-051:** 20X objective (W.D.: 20mm, N.A.: 0.42)
- 375-052:** 50X objective (W.D.: 13mm, N.A.: 0.55)
- 375-053:** 100X objective (W.D.: 6mm, N.A.: 0.7)
- 176-370-1:** Slide-type nosepiece (2-mount, parfocal)
- 176-370-2:** Slide-type nosepiece (2-mount, mag. adjusted)
- 12AAA643:** ND2 color filter (transmitted / surface)
- 12AAA644:** ND8 color filter (transmitted / surface)
- 12AAA645:** GIF filter (transmitted / surface) (std. accessory)
- 12AAA646:** LB80 color filter (transmitted / surface)
- 375-054:** 0.5X camera adapter (with C-mount adapter)
- 970441:** C-mount adapter
- 513667:** Halogen bulb (12V, 50W)
- 12BAB345:** Halogen bulb (long life type, 12V, 50W)
- 176-308:** Vibration damping stand
- 176-309:** Mounting stand
- 375-056:** Stage micrometer
- 12AAA165:** Lens cleaning kit
- 12AAA846:** Foot switch
- 382951:** Vinyl cover (standard accessory) 2010 or less
- 12BAM841:** Vinyl cover 2017 or greater

### Illumination Units

- 176-367-2A:** LED ring illuminator
- 176-343A:** Twin fiber-optics illuminator
- 176-366A:** Ring fiber-optics illuminator
- 12AAG806:** GIF color filter (for fiber-optics illuminator)
- 12AAG807:** LB80 color filter (for fiber-optics illuminator)

### Fixture and Stage Accessories

- 176-107:** Holder with clamp
- 172-378:** V-block with clamp  
(max. workpiece dia.: 1" / 25mm)
- 172-197:** Swivel center support<sup>1</sup>  
(max. workpiece dia.: 3.1" / 80mm)
- 176-305:** Rotary stage with fine feed knob for 1010D/2010D models
- 176-306:** Rotary stage with fine feed knob for 2017D/3017D/4020D models

<sup>1</sup> Fixture mount adapter (**176-310**) is required for 2010D models. Fixture mount adapter (**176-304**) is required for 2017D/3017D/4020D models.



#### QM-Data200

- 2-D data processing unit
- 264-155A:** Stand-mount type
- 12AAA807:** Connecting cable set

#### Focus pilot FP-05

Focus assisting system



#### Vision Unit

PC-based vision measuring system

**359-763**

# MF Motorized

## SERIES 176 — Motorized Type Measuring Microscopes

- Motorized model of the MF Series.  
The Z-axis is motorized, and the stage can be operated using a remote box.
- Using the optional vision unit enables the image AF function.
- Illumination unit (reflected/transmitted)

- can be selected from a high-intensity LED or halogen bulb (selection required).
- Variable aperture diaphragm (reflected/transmitted) allows observation measurement while suppressing light diffraction.
- A wide variety of optional accessories are offered.
- ML series, high-NA objectives that are specially designed for the MF series (long-working distance type).
- High-magnification observation up to 2000X.

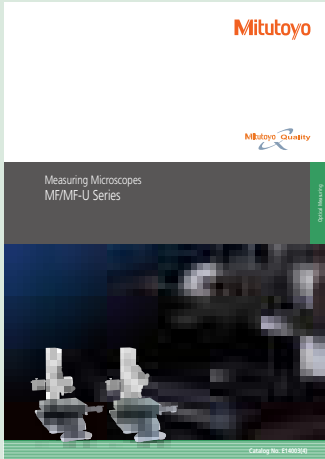

Refer to No. (E14003) for more details.



**MF-J2017D**

\* The binocular tube, eyepieces, and LED illumination unit are optional accessories.

## SPECIFICATIONS

Model No.	MF-J2017D	MF-J3017D	MF-J4017D	
Order No.	176-891A	176-892A	176-893A	
Observation image	BF (Bright field)/Erect image			
Eyepiece	10X (field number: 24), 15X, 20X			
Objective lens	ML series 3X objective lens (standard accessory), 1X, 5X, 10X, 20X, 50X, 100X			
Illumination unit (One of the two options must be selected.)	LED illumination unit	Transmitted illumination: Telecentric system, Built-in aperture diaphragm, White LED light source, stepless light intensity control, with cooling fan Reflected illumination: Koehler illumination, Variable aperture diaphragm mechanism, White LED light source, stepless light intensity control Control unit: Power ON/OFF switch (main switch), 100 - 240V AC power input connector		
	Halogen illumination unit	Transmitted illumination: Telecentric system, Built-in aperture diaphragm, Halogen bulb (12V, 50W), stepless light intensity control, with cooling fan Reflected illumination: Koehler illumination, Variable aperture diaphragm mechanism, Halogen bulb (12V, 50W), stepless light intensity control, with cooling fan Control unit: Power ON/OFF switch (main switch), 100 - 240V AC power input connector		
Vision AF <sup>*1</sup>	Available Option			
XY-axis Vision	Measuring range	200×170mm	300×170mm	400×200mm
Z-axis	Measuring range	220mm		
Measuring accuracy <sup>*2</sup>	(When no load is put on the X- or Y-axis)	(2.2+0.02L) μm L: Measuring length (mm)		
Digital counter	Resolution	1/0.5/0.1μm .0001"/.00005"/.00001" switchable		

\*1: Vision Unit **359-763** and an image AF cable **12AAN358** are sold separately.

\*2: Measuring method complies with JIS B7153.

Bulb replacement for transmitted/reflected illumination Standard: Halogen bulb (12V, 50W) (No.513667)  
Bulb life: 1,100 hours

# MF-U

## SERIES 176 — High-power Multi-function Measuring Microscopes

### FEATURES

- Observation with a clear and flareless erect image and a wide field of view
- Measuring accuracy that is highest in its class (and conforms to JIS B 7153)
- Proven high-NA objectives from the FS optical system (long-working distance type)
- Integration of metallurgical and measurement microscope functions provides high-resolution observation and high-accuracy measurement solution
- Illumination unit (reflected/transmitted) selectable from a high-intensity LED or halogen bulb (required)
- Variable aperture diaphragm (reflected/transmitted) allows for contrast adjustment
- Variety of standardized stages in sizes up to 400 x 200 mm
- Quick-release mechanism useful for moving the stage quickly when measuring workpieces that are large in size or quantity
- High-magnification eyepiece observation up to 4000X



**MF-UB3017D**  
XY stage travel range: 12 x 6.7" / 300 x 170mm  
(with optional turret, objective and fiber illumination)

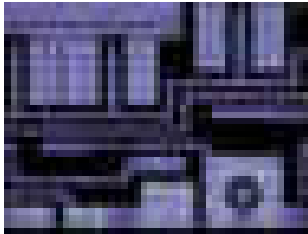

**Polarized light observation:**  
Observing only the filtered light that vibrates in one direction. Used for observing materials with special optical characteristics, such as mineral and liquid crystal.



**Dark field (DF) observation:**  
Observing only the scattered light by shutting down the direct light to the objectives. The scratches and dust that cannot be viewed in the bright view field can be observed by this method in high-contrast.



**Differential interference contrast (DIC) observation:**  
Effective in detecting fine scratches and steps on the surface of metal, liquid crystal, and semiconductors.

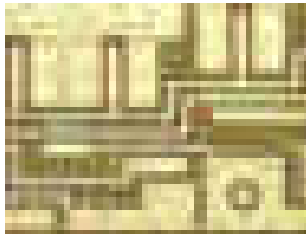

**Bright field (BF) observation:**  
Most common method of observation. Observing directly the light reflected from the surface of the workpiece.

### Technical Data

Observation image:	Erect image
Optical tube:	Siedentoph type (pupil distance adjustment: 51 - 76mm), 1X tube lens, Binocular tube (depression: 30°), Reticle projection method, with TV mount, Optical path ratio (eyepiece/TV mount: 50/50)
Eyepiece lens:	10X (field No.: 24mm), Optional: 15X, 20X
Turret (optional):	Manual or power
Objective (optional):	M / BD Plan Apo objective from 1X to 200X
Transmitted illumination	
• Light source:	Halogen bulb (12V, 50W) or LED
• Optical system:	Telecentric illumination with adjustable aperture diaphragms
• Functions:	Light intensity adjustable, Non-stepped brightness adjustment
Surface illumination	
• Light source:	Optional halogen illumination unit (fiber-optic cold light illumination) or LED
• Optical system:	Koehler illumination with adjustable aperture diaphragms
• Functions:	Light intensity adjustable, Non-stepped brightness adjustment
Display unit:	
• No. of axis:	2 axes or 3 axes
• Resolution:	.0001" / .00005" / .00001" / 0.001mm / 0.0005mm / 0.0001mm
• Functions:	Zero-setting, Direction switching, Data output (via RS-232C interface)
Power supply:	120V AC, 50/60Hz
Mass:	148lbs/67kg (1010D) / 157lbs/71kg (2010D) / 326lbs/148kg (2017D) / 344lbs/156kg (3017D) / 357lbs/162kg (4020D)

### Selection of XY stage by travel range



**1010D:** 4 x 4" / 100 x 100mm



**2010D:** 8 x 4" / 200 x 100mm



**2017D:** 8 x 6.7" / 200 x 170mm



**4020D:** 16" x 8" / 400 x 200mm

## Optional Accessories

- 378-866:** 10X eyepiece set (view field dia.: 24mm)  
(standard accessory)  
**378-857:** 15X eyepiece set (view field dia.: 16mm)  
**378-858:** 20X eyepiece set (view field dia.: 12mm)

## Turret (Nosepiece) **must select**

- 378-018:** Adjustable manual BF turret (4 port)  
**378-216A:** Adjustable power BF turret (5 port)  
**176-211:** Adjustable manual BF/DF turret (4 port)  
**176-212A:** Adjustable power BF/DF turret (4 port)

Objectives  
 See page I-28 for objective selection

## Manual and Power Turrets



- Filters  
**378-092:** Polarization unit  
**378-076:** DIC unit for 100X, SL80X, SL50X objective  
**378-078:** DIC unit for 50X, SL20X objective  
**378-079:** DIC unit for 20X objective  
**378-080:** DIC unit for 10X, 5X objective  
**12AAA643:** ND2 color filter (for halogen illuminator, **176-448A**)  
**12AAA645:** GIF filter (standard accessory)  
**12AAA646:** LB80 color filter (for halogen illuminator, (**176-448A**))

## Camera Mounts

- 375-054:** 0.5X camera adapter  
(with C-mount adapter)  
**970441:** C-mount adapter

## Bulbs

- 513667:** Halogen bulb (12V, 50W)  
**12BAB345:** Halogen bulb (long life type, 12V, 50W)  
**517181:** Halogen bulb (12V, 100W)  
**12BAD602:** High intensity halogen bulb (12V, 100W)

## Illumination Units

- 176-315A:** Halogen illumination unit (12V, 100W)  
**176-316A:** Halogen illumination unit (12V, 150W)  
**176-343A:** Twin fiber-optics illuminator  
**12AAG806:** GIF color filter (for **176-315A** and **176-343A**)  
**12AAG807:** LB80 color filter (for **176-315A** and **176-343A**)

## Fixture and Stage Accessories

- 176-107:** Holder with clamp  
**172-378:** V-block with clamp  
(max. workpiece dia.: 1" / 25mm)  
**172-197:** Swivel center support\*  
(max. workpiece dia.: 3.1" / 80mm)  
**176-305:** Rotary stage with fine feed knob for 1010D/2010D models  
**176-306:** Rotary stage with fine feed knob for 2017D/3017D/4020D models

\*Fixture mount adapter (**176-310**) is required for 2010D models.  
 Fixture mount adapter (**176-304**) is required for 2017D/3017D/4020D models.

## Misc.

- 176-308:** Vibration damping stand  
**176-309:** Mounting stand  
**375-056:** Stage micrometer  
**937179T:** Foot switch  
 Reticle See page I-21

# MF-U

## SERIES 176 — High-Power Multi-Function Measuring Microscopes

### SPECIFICATIONS

Model No. (XY stage size)	1010D	2010D	2017D	3017D	4020D
<b>Order No.</b>	MF-UA	<b>176-871-10</b>	<b>176-872-10</b>	<b>176-873-10</b>	<b>176-874-10</b>
	MF-UB	<b>176-876-10</b>	<b>176-877-10</b>	<b>176-878-10</b>	<b>176-879-10</b>
	MF-UC	<b>176-881-10</b>	<b>176-882-10</b>	<b>176-883-10</b>	<b>176-884-10</b>
	MF-UD	<b>176-886-10</b>	<b>176-887-10</b>	<b>176-888-10</b>	<b>176-889-10</b>
XY stage travel range	4 x 4" 100 x 100mm	8 x 4" 200 x 100mm	8 x 6.7" 200 x 170mm	12 x 6.7" 300 x 170mm	16 x 8" 400 x 200mm
Z-axis travel range	6" / 150mm			8.7" / 220mm	
Focusing method	Manual focusing (coarse focusing: 10mm/rev., fine focusing: 0.1mm/rev.)				
Measurement method	Linear encoder (2-axis model: X / Y-axis, 3-axis model: X / Y / Z-axis)				
Resolution (switchable)	.0001" / .00005" / .00001" (0.001mm / 0.0005mm / 0.0001mm)				
Measuring accuracy (at 20°C)	XY-axis: (2.2+0.02L)µm, L = Measuring length (mm) when not loaded, JIS B 7153				
Indication accuracy (at 20°C)	Z-axis: (5+0.04L)µm, L = Measuring length (mm)				
Floating function	X and Y axes with Quick-release mechanism				
XY stage top size	11 x 11" 280 x 280mm	14 x 11" 350 x 280mm	16 x 13.6" 410 x 342mm	20 x 13.6" 510 x 342mm	24 x 13.6" 610 x 342mm
Effective glass size	7.1 x 7.1" 180 x 180mm	10 x 6" 250 x 150mm	10.6 x 9.6" 270 x 240mm	14.6 x 9.6" 370 x 240mm	17.3 x 9.6" 440 x 240mm
Swivel function	—			±5° (left)	±3° (left)
Max. stage loading	22lbs / 10kg			44lbs / 20kg	33lbs / 15kg

### Selection of machine type

Machine type	MF-UA	MF-UB	MF-UC	MF-UD
Observation type	Bright field (BF)	Bright field (BF)	Bright / Dark field (BF/DF)	Bright / Dark field (BF/DF)
Measurement system	X and Y-axis (2 axes)	X, Y and Z-axis (3 axes)	X and Y-axis (2 axes)	X, Y and Z-axis (3 axes)

### Illumination Unit (**must select LED or Halogen illumination unit**)

Applicable Illumination Unit	LED	Halogen
<b>Order No.</b>	<b>176-446A</b> (transmitted & reflected)	<b>176-448A</b> (transmitted) <b>176-316A</b> (reflected)

Note: illumination unit not included. If halogen transmitted illumination is selected, then either 176-315A or 176-316A must be chosen.

### DIMENSIONS

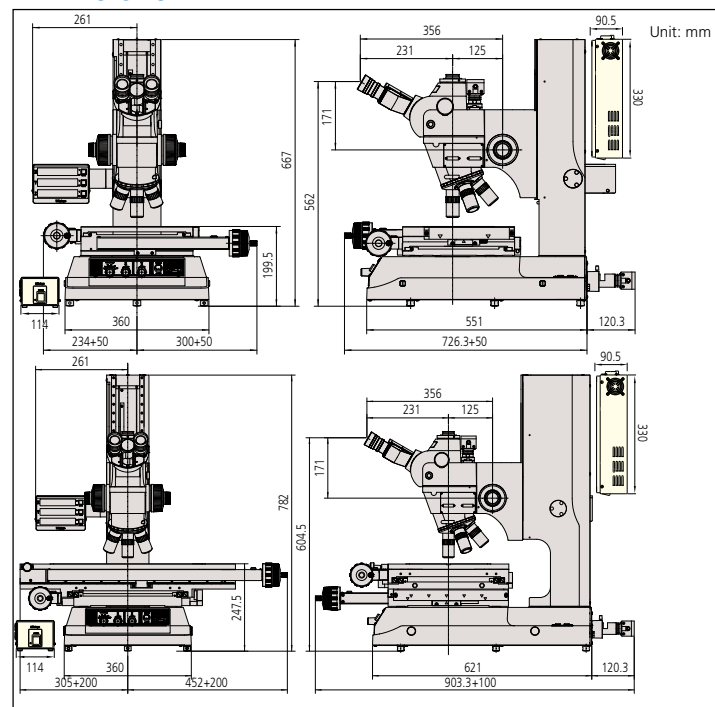

# MF-U Motorized

## SERIES 176 — Motorized-Type Universal Measuring Microscopes

- Motorized model of the MF-U Series. The Z-axis is motorized, and can be operated using a remote box.
- Using the optional vision unit enables the image AF function.
- Illumination unit (reflected/transmitted) can be selected from a high-intensity LED or halogen bulb (required).
- Variable aperture diaphragm (reflected/transmitted) allows observation measurement while suppressing light diffraction.
- A wide variety of optional accessories are offered.
- Proven high-NA objectives from the FS optical system (long working distance type).
- Integration of metallurgical and measurement microscope functions provide high-resolution observation and a high-accuracy measurement solution.
- High-magnification observation up to 4000X.



**MF-UJ2017D**

\* The turret, objectives, and LED illumination unit are sold separately.

### MF-U Selection of Machine Type

↓	2017	3017	4020	Counter	Motorized stage	Optics
<b>J</b>	<b>176-894A</b>	<b>176-895A</b>	<b>176-896A</b>	X,Y,Z	Z only	BF
<b>K</b>	<b>176-897A</b>	<b>176-898A</b>	<b>176-899A</b>	X,Y,Z	Z only	BF/DF

### SPECIFICATIONS

		<b>MF-UJ2017D</b>	<b>MF-UJ3017D</b>	<b>MF-UJ4020D</b>
BF (Bright field)	Model No.	<b>MF-UJ2017D</b>	<b>MF-UJ3017D</b>	<b>MF-UJ4020D</b>
	Order No.	<b>176-894A</b>	<b>176-895A</b>	<b>176-896A</b>
BD (Bright / Dark field)	Model No.	<b>MF-UK2017D</b>	<b>MF-UK3017D</b>	<b>MF-UK4020D</b>
	Order No.	<b>176-897A</b>	<b>176-898A</b>	<b>176-899A</b>
Observation image		BF (Bright field), DF (Dark field), Polarization, Differential Interference Contrast (DIC) / Erect image		
Eyepiece	Diopter adjustment	10X (standard accessory) (Field number: 24), 15X, 20X		
	BF (Bright field)	M Plan Apo, M Plan Apo HR, M Plan Apo SL, G Plan Apo		
Objective lens (optional)	BD (Bright / Dark field)	BD Plan Apo, D Plan Apo HR, BD plan Apo SL		
	LED illumination unit	Transmitted illumination: Telecentric system, Built-in aperture diaphragm, White LED light source, stepless light intensity control, with cooling fan Reflected illumination: Koehler illumination, Variable aperture diaphragm mechanism, White LED light source, Non-step light intensity control Control unit: Power ON/OFF switch (main switch), 100 - 240V AC power input connector		
Illumination unit (One of the two options must be selected.)	Halogen illumination unit	Transmitted illumination: Telecentric system, Built-in aperture diaphragm, Halogen bulb (12V, 50W), stepless light intensity control, with cooling fan Reflected: BF/BD Kohler illumination with adjustable aperture diaphragm, 12V100W or 12V15W halogen lamp (selectable), external fiber illumination, stepless brightness adjustment Control unit: Power ON/OFF switch (main switch), 100 - 240V AC power input connector		
	Vision AF*1	✓		
XY-axis	Measuring range	8×6.7" / 200×170mm	12×6.7" / 300×170mm	16×8" / 400×200mm
Z-axis	Measuring range	8.7" / 220mm		
Measuring accuracy	(When no load is put on the X- or Y-axis)	(2.2+0.02L) μm L: Measuring length (mm)		
Digital counter	Resolution	1/0.5/0.1μm .0001"/.00005"/.00001" switchable		

\*1: Vision unit and an image AF cable are separately required.

\*2: Measuring method complies with JIS B7153.

Bulb replacement for transmitted illumination Standard: Halogen bulb (12V, 50W) (No.513667), Bulb life: 1,100 hours  
For replacement for reflected illumination (from separate light source) Standard: Halogen bulb (12V, 100W) (No.517181),  
High-intensity bulb (12V, 100W) (No.12BAD602)  
\*At the time of purchase, a standard bulb and a high-intensity bulb are provided. (Only for the reflected illumination models.)

# Accessories for Measuring Microscope

## Stage Micrometer

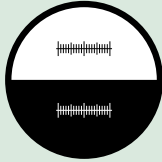
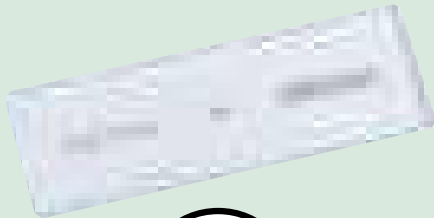

## SPECIFICATIONS

Order No.	375-056
Range	1mm
Graduations	0.01mm
Accuracy (at 20°C)	(1+L)μm, L = Measuring length (mm)
Dimensions (WxD)	3" x 1" / 76 x 26mm
Mass	16g

## Optional Reticles

- 12AAG838 (12AAG878): Cross-hair (7μm width)
- 12AAG836 (12AAG877)\*: Cross-hair (5μm width)
- 12AAG873 (12AAG876): Cross-hair (3μm width)
- 12AAG839 (12AAG879): Cross-hair and 45° angle
- 12AAG840 (12AAG880): Broken cross-hair and 60° angle
- 12AAG841 (12AAG881): Zeiss type chart
- 12AAG842: 20mm scale (0.1mm reading)
- 12AAG843: Concentric circle (ø1.2 - ø18mm)
- 12AAG844: 10mm scale (0.1mm reading)
- 12AAG845: 5mm scale (0.05mm reading)
- 12AAG846: 10x10mm section (1mm min.)
- 12AAG847: Metric screw thread (P = 0.25-1.0)
- 12AAG848: Metric screw thread (P = 1.25-2.0)
- 12AAG849: Involute gear tooth (14.5°), module = 0.1 - 1.0
- 12AAG850: Involute gear tooth (20°), module = 0.1 - 1.0
- 12AAG851: Unified screw thread (80 - 28TPI)
- 12AAG852: Unified screw thread (24 - 14TPI)
- 12AAG853: Unified screw thread (13 - 10TPI)
- 12AAG854: Concentric circle (ø.01" - ø.2")

( ): for MF-U models,  
\* Standard accessory

Reticle mount  
(standard accessory)



for MF models

Cross-hair and 90° angle  
(standard accessory)

## Focus Pilot FP-05

### FEATURES

- By installing this system on the camera mount of an MF series measuring microscope and projecting the focusing chart onto the workpiece surface, the focal point can be detected with high accuracy and high repeatability.
- The brightness of the chart can be adjusted.
- A wide view field observation on the monitor is made possible with the use of a CCD camera (C-mount adapter is included.)

- Four types of chart patterns are available.\* The pattern should be selected in accordance with the type of workpiece surface texture.

\* Factory installed option



Concentric circle

Slit

## SPECIFICATIONS

Order No.	375-057A	375-058A	375-067A	375-068A
Applicable microscopes	MF D models		MF-U D models	
Light source	Green LED	Red LED	Green LED	Red LED
Magnification	0.5X, Accuracy: 0.1%**			
Camera adapter	C-mount (provided)			
Applicable CCD camera	Up to 2/3-inch			
Mass	4lbs / 1.8kg			

\*\* Within 2/3 area from the center of view field



## Manual and Power Turrets

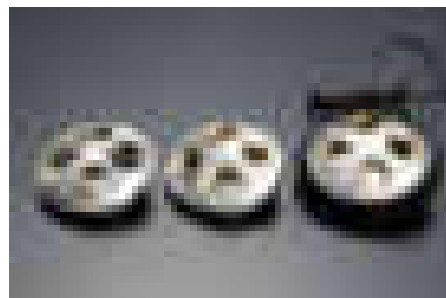

## SPECIFICATIONS

Order No.	176-211	378-018	176-212A	378-016A	378-216A
Observation type	BD	BF	BD	BF	BF
No. of objective mounts	4-mount	4-mount	4-mount	4-mount	5-mount
Driving method	Manual		Motor		
Dimensions (W x D x H)	—		Turret: 6.5 x 2.6 x 5.4"		
	—		164 x 65 x 137		
			Control Box: 4.1 x 3 x 7.6"		
			108 x 72 x 193		

# Accessories for Measuring Microscope

## Twin fiber-optics illuminator



### SPECIFICATIONS

Order No.	176-343A
Applicable microscopes	MF, MF-U models
Length of fiber cable	28" / 700mm
Light source	Halogen bulb (12V, 100W) (517181: halogen bulb)
Dimensions (W x D x H)	Light unit: 9.3 x 3 x 4.7" 235 x 76 x 120mm

## Ring fiber-optics illuminator



### SPECIFICATIONS

Order No.	176-366A
Applicable microscopes	MF models (ML 10X or lower)
Length of fiber cable	40" x 1000mm
Light source	Halogen bulb (12V, 100W) (517181: halogen bulb)
Dimensions (W x D x H)	Light unit: 9.3 x 3 x 4.7" 235 x 76 x 120mm

## LED Ring Illuminator



### SPECIFICATIONS

Order No.	176-367-2A
Applicable microscopes	MF models with 1X/3X/5X/10X objective
Light source	White LED
Length of LED cable	59" / 1500mm

## LED Ring Light (for sliding nosepiece)

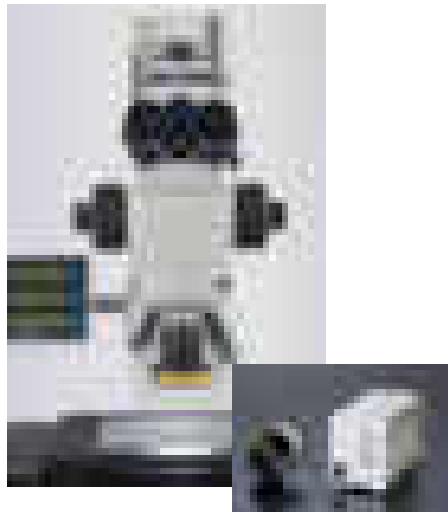

### SPECIFICATIONS

Order No.	176-371A
Applicable microscopes	MF models with 1X/3X/5X/10X objective
Light source	LED

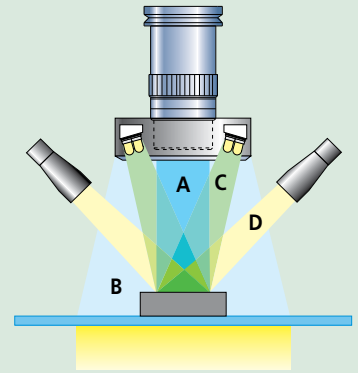

### A: Vertical surface illumination (Halogen)



PCB

HDD suspension



IC circuit

### B: Ring fiber optics illumination



Flexible PCB

PCB

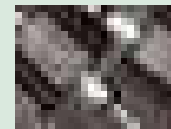

Electric parts

### C: LED ring illumination



HDD suspension

PCB



Black resin molded parts

### D: Twin fiber-optics illumination



IC package

Garnet



PCB



# QM-Data200

## SERIES 264 — 2-D Data Processing Unit

### Technical Data

Resolution:	0.0001mm
Program functions:	Part program creation, execution, editing
Statistical processing:	Number of data, maximum value, minimum value, mean value, standard deviation, range, histogram
Element memory:	Maximum of 1000 elements
Element recall:	Point, line, circle, distance, ellipse, rectangular hole, slotted hole, intersection and intersecting angle
Element key-in:	Point, line, circle
Display system:	Monographic LCD (320 x 240 dots, with back light)
Measurement result file output:	RS-232C/USB output (CSV format, MUX-10F format)
Display language:	Japanese/English/German/French/Italian/Spanish/Portuguese/Swedish/Polish/Dutch/Hungarian
Data input:	RS-232C/USB, XYZ-axis signal, Footswitch
Data output:	RS-232C/USB
Power supply:	120V AC, 50/60Hz
Mass:	2.2kg (stand-mount type) 2.1kg (arm-mount type)

### QM-Data200

Order No.: 264-155A (stand-mount type)  
Order No.: 264-156A (arm-mount type)

### • Graphic display

Measurement information and data are visualized on the back-lit colored LCD with graphical interfaces. The geometric feature selected is displayed with the probing navigator. The measurements map and blink indication show the probing points and sequences. This improves operation accuracy and reduces errors and time.

The QM-Data200 is a geometric readout/analysis unit for optical instruments like profile projectors. This features powerful 2-D coordinate measurement capabilities with unmatched simple key operation. The QM-Data200 improves operator productivity, minimizes errors, and saves measurement time and production cost.

### FEATURES

- Various graphic displays on the large colored LCD screen for easy measurement operations.
- One-key operation for combined measurements that are often used (circle-circle distance, etc.)



QM-Data 200  
Stand-mount type

- The AI measurement function (automatic identification of measuring item) eliminates switching between the measurement command keys.
- Equipped with the measurement procedure teaching function and the measuring position navigation in Repeat mode.
- The user menu function allows user to register measurement commands or part programs to create his own menu.
- Tolerance zone measurement of data processing result and various statistical processing for each item is available.
- Measurement result output to "MS-Excel" in spreadsheet (CSV) format.
- The measurement procedure and measurement result can be saved, using a USB drive.
- Two models available: a stand-alone type with tilt system and a flexible-arm type that can be mounted on a profile projector.

### • Intuitive panel design

The QM-Data200 employs Geometry Keys to accelerate the measurement process. The probing routine of standard geometric features and combinations are designed with Geometry Keys on the front panel. Click the key you need and capture features to complete the measurement quickly and accurately. This improves operator productivity, reduce errors, and saves operation time and cost.

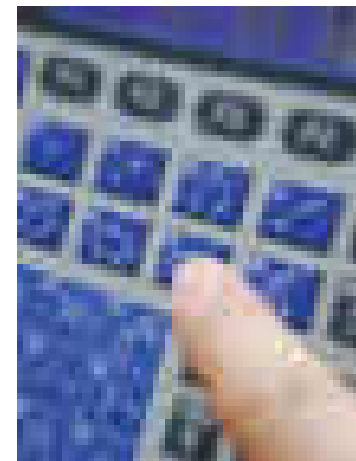
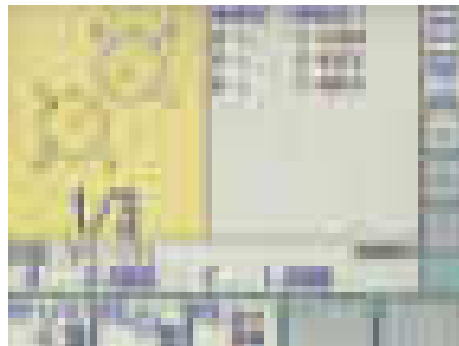

# QM-Data200

## SERIES 264 — 2-D Data Processing Unit

### SYSTEM DIAGRAM

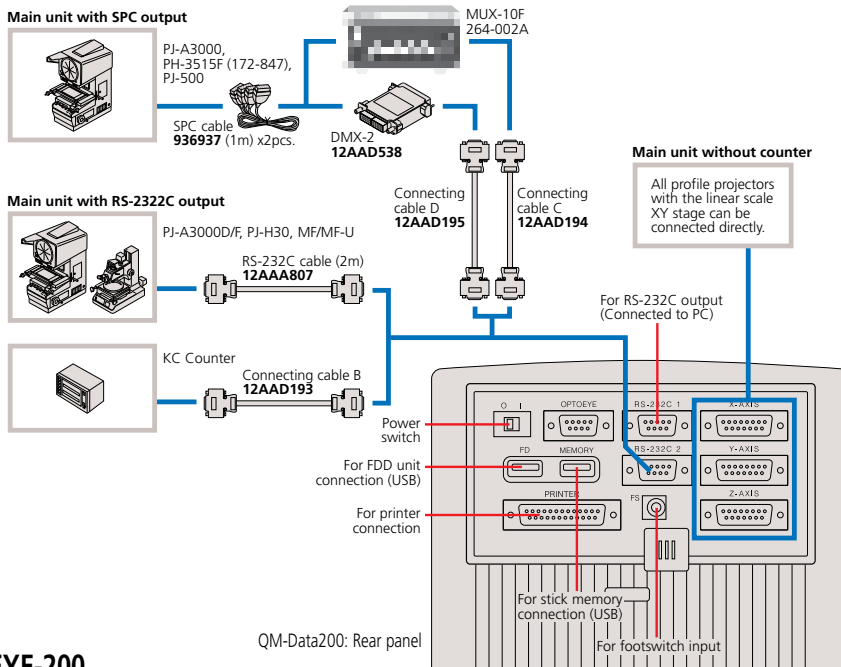

### OPTOEYE-200

The OPTOEYE-200 Image Edge Sensor eliminates human errors, ensuring speedy, accurate and consistent measurements, regardless of operator's skill.

### FEATURES

- OPTOEYE-200 adopts a thin fiber-optic cable for detector connection for easy set-up and smart operation without obstructing your view.

- Bright and dark buttons allow easy calibration.
- OPTOEYE can be powered by QM-Data200 via the connecting cable. No AC adapter is required.
- The brightness of the chart can be adjusted.

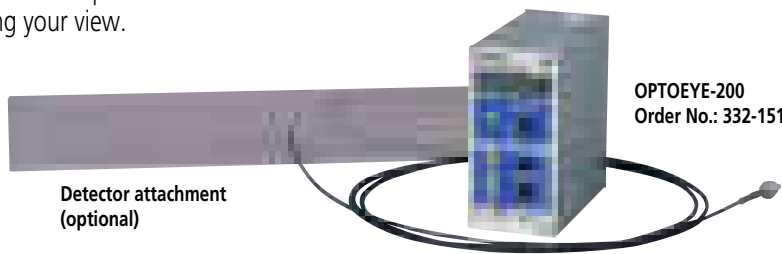

### DIMENSIONS

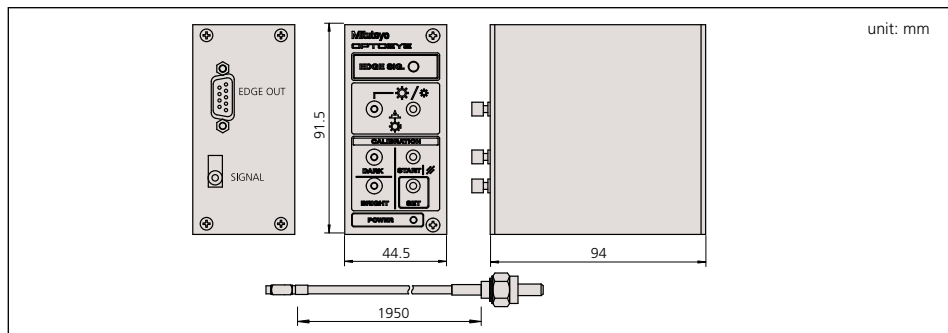

### Optional Accessories

- 12AAD034: Receipt printer (for 120V)
- 223663: Printer paper for receipt printer
- 12AAA804: Printer cable (2m)
- 937179T: Foot switch
- 12AAD193: Connection cable B
- 12AAD194: Connection cable C
- 12AAD195: Connection cable D
- 12AAA807: RS-232C cable (2m)
- 12AAA808: RS-232C cable (4m)

### Technical Data

#### Image detection

- Directivity: Non-direction
- Min. diameter:  $\phi 2\text{mm}$  on the screen
- Min. width: 1mm on the screen
- Max. moving speed: 1000mm/s

#### Applicable illumination

- Type: Surface / Contour illumination
- Range: 30Lx to 1500Lx on the screen
- Bright-Dark field difference: 20Lx
- 1  $\mu\text{m}$  in contour illumination
- Error in detection of illumination change
- Supporting a contour illumination brightness selector switch of projector

#### Repeatability:

#### Function:

### Optional Accessories

#### 12AAE671:

##### Detector attachment (A)

- PJ-A3000, PJ-H30, PH-3515, PH-A14 series
- (Adaptation diameter of a screen: 10" /  $\phi 250$  to 14" /  $\phi 350\text{mm}$ )

#### 12AAE672:

##### Detector attachment (B)

- PJ-500, PV-5110, PV-600A series
- (Adaptation diameter of a screen: 20" /  $\phi 500$  to 24" /  $\phi 600\text{mm}$ )

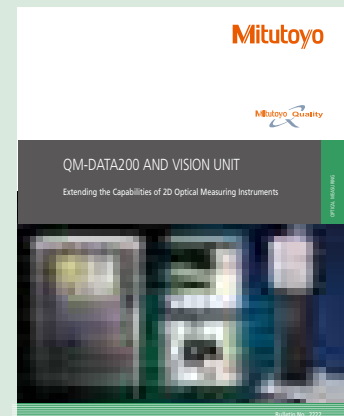
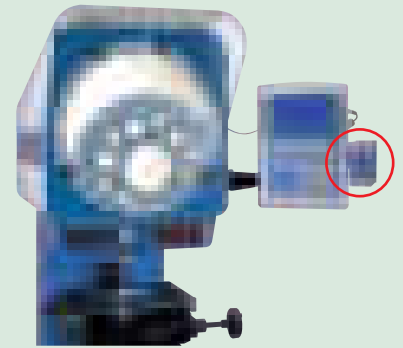

Refer to Bulletin No. (2222) for more details.

# Vision Unit

## SERIES 359 — Vision System Retrofit for MF and MF-U Microscopes

### SPECIFICATIONS

Projected Image	Inverted Image
Onscreen Magnification	19x-1900x (22" Monitor)
<b>Camera Unit</b>	
Image Sensor Size	1/2" Color CMMOS
Image Sensor Resolution	3 MP
Interface	USB 2.0
Dimensions (WxDxH)	2.28 x 2.32 x 3.27" 58 x 59 x 83mm
<b>Adapter Unit</b>	
Measurement Software	QSPak VUE (optional)
Dimensions (DXH)	1.77 x 4.84" / 45 x 123mm
Magnification	0.5x
Optional Accessory:	Foot Switch (12AAJ088)

### QSPAK, optional software

#### For observation/comparison of form

- Template matching function
- Manual pattern matching function

#### For simple measurement

- One-click edge detection tool function
- Smart tool function
- User macro function

#### For repeated measurement/ auto-measurement

- Quick navigation function
- Playback function
- Graphic function
- External data output function
- Statistical calculation function

### One-click Edge Detection

By clicking the mouse near the edge of a workpiece, QSPAK automatically scans the edge and detects it, showing its coordinates. This function also works with the point tool, box tool, circle tool and auto-focus tool.



### Graphic Window

The measurement results and measured elements are plotted in the graphic window in real-time. By using this function, the user can check the current measuring position at a glance. The graphic window can be used for geometrical calculation.

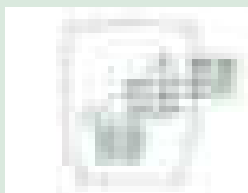

### FEATURES

- The automatic edge-detection tools and various macro icons allow measurement in one easy step.
- The graphics and measurement navigation functions facilitate operation.
- Image data input/storage function.
- Measurement results are output in CVS format. This lets the user generate an inspection table in MS-Excel®.
- Allows the tolerance zone measurement of measurement results and various types of statistical processing for each item.
- Combined use with the focus pilot provides high-accuracy height measurements. (Patent pending)
- A series of measuring operations can be performed using just one screen display.
- The auto-brightness control function reproduces the type and degree of illumination required. (This function is limited to the MF/MF-U series.)

### QSPAK Measurement Window

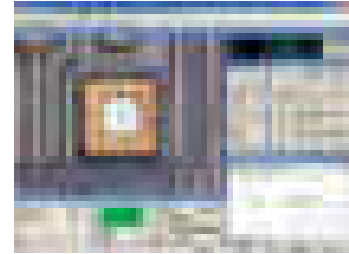

The PC system, QSPAK software and microscope are optional.

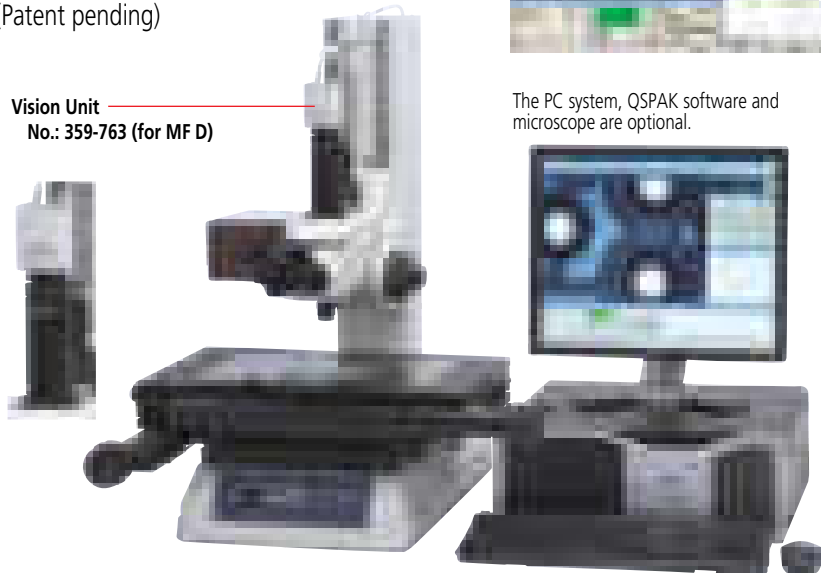

Vision Unit  
No.: 359-763 (for MF D)

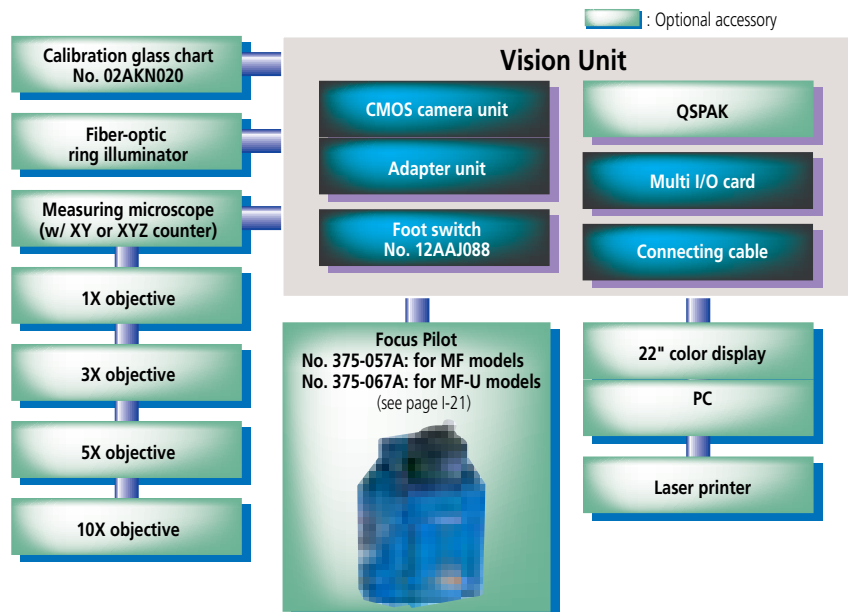

# FS-70

## SERIES 378 — Microscope Unit for Semiconductor Inspection

### FEATURES

- The optical system that was developed for the best-selling FS 60 models was further enhanced for the FS70 models. It is ideal as a microscope unit of a prober station for semiconductors. (All models CE marked.)
- The FS70L supports three types of YAG laser wavelength ranges (1064nm, 532nm and 355nm), while the FS70L4 supports two types of wavelength ranges (532nm and 266nm), thus expanding a scope of laser applications, allowing laser-cutting of thin-films used in semiconductors and liquid crystal substrates. However, Mitutoyo assumes no responsibility for the performance and/or safety of the laser system used with Mitutoyo microscopes. Careful examination is recommended in selecting a laser-emission unit.
- Bright field, differential interference contrast (DIC) and polarized observations are optional with FS70Z and FS70. The FS70L and FS70L4 do not support the DIC method.
- By employing an inward revolver, the long working distance objectives provide excellent operability.
- An ergonomic design with superb operability: the FS70 employs the erect-image optical system (the image in the field of view has the same orientation as the specimen) and enlarged fine focus adjustment wheel with rubber-grip coarse adjustment knob.



FS70Z



FS70L



FS70L4

### SPECIFICATIONS

Model No. Order No.	FS70 378-184-1	FS70-TH 378-184-3	FS70Z 378-185-1	FS70Z-TH 378-185-3	FS70L 378-186-1	FS70L-TH 378-186-3	FS70L4 378-187-1	FS70L4-TH 378-187-3
Short base model No. Order No.	FS70-S 378-184-2	FS70-THS 378-184-4	FS70Z-S 378-185-2	FS70Z-THS 378-185-4	FS70L-S 378-186-2	FS70L-THS 378-186-4	FS70L4-S 378-187-2	FS70L4-THS 378-187-4
Focus adjustment	50mm travel range with concentric coarse (3.8mm/rev) and fine (0.1mm/rev) focusing wheels (right / left)							
Image	Erect image							
Pupil distance	Siedentopf type, adjustment range: 2 - 3" / 51 - 76mm							
Field number	24							
Tilt angle	—	0° - 20°	—	0° - 20°	—	0° - 20°	—	0° - 20°
Optical pass ratio	50/50	100/0 or 0/100	50/50	100/0 or 0/100	100/0 or 0/100	100/0 or 0/100	100/0 or 0/100	100/0 or 0/100
Protective filter	—		—		Built-in laser beam filter		Built-in laser beam filter	
Tube lens	1X	1X - 2X zoom		1X		1X		
Applicable laser	—		—		1064/532/355nm		532/266nm	
Camera mount	C-mount (using optional adapter B)				Use a laser with TV port.		C-mount receptacle (with green filter switch)	
Illumination system, optional	Reflective illumination for bright field (Koehler illumination, with aperture diaphragm) 12V 100W fiber optics, non-stepped adjustment, light guide length: 1.5m, power consumption 150W							
Objective, optional (for observation)	M Plan Apo, M Plan Apo SL, G Plan Apo							
Objective, optional (for laser-cutting)	—				M/LCD Plan NIR, M/LCD Plan NUV		M Plan UV	
Loading weight*	32lbs/14.5kg	30lbs/13.6kg	31lbs/14.1kg	29lbs/13.2kg	31lbs/14.2kg	30lbs/13.5kg	31lbs/13.9kg	29lbs/13.1kg
Mass (main unit)	13lbs/6.1kg	15.5lbs/7.1kg	14.5lbs/6.6kg	16.5lbs/7.5kg	14lbs/6.4kg	15.5lbs/7.2kg	14.5lbs/6.7kg	16.5lbs/7.5kg

\*Loading weight on optical tube excluding weight of objective lenses and eyepieces.

### Technical Data

Focus Adjustment Method:	With concentric coarse and fine focusing wheels (right and left)
Range:	50mm travel range 0.1mm/rev. for fine adjustment, 3.8mm/rev. for coarse adjustment
Trinocular tube Image:	Erect image
Pupil distance:	Siedentopf type, adjustment range: 2-3" / 51-76mm
Field number:	24
Tilt angle:	0° - 20° (only -TH, -THS models)
Illumination system:	Reflective illumination for bright field (Koehler illumination, with aperture diaphragm)
Light source (optional):	12V100W fiber optics, non-stepped adjustment, light guide length 1.5m, power consumption 150W
Objectives (optional):	M Plan Apo, M Plan Apo SL, G Plan Apo

### Optional Accessories

For a complete listing of accessories see Microscope Units and Objectives brochure, E4191-378

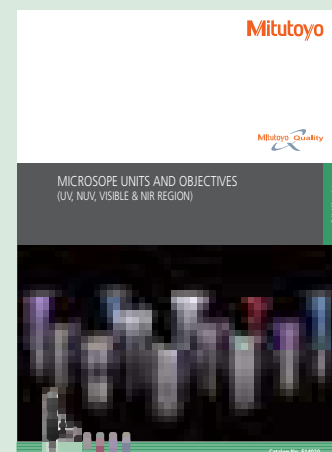

Refer to No. (E14020) for more details.

# VMU

## SERIES 378 — Video Microscope Unit

The VMU is a compact, light-weight, and easy-to-install microscope unit for CCD camera monitoring in semiconductor fabrications.

### FEATURES

- The rigidity and general performance of the VMU-LB & VMU-L4B have been enhanced compared to previous models.
- The optical system features ultra-long working distance objectives and correction for the wide range of radiation.
- The fiber-optic reflected illumination keeps the workpiece free from thermal expansion caused by heat. The fiber-optic illuminator is required for the light source.
- Also available with a laser mount or revolving nosepiece (objective mount).

### SPECIFICATIONS

Magnification of tube	1X
Applicable wavelength	378-505, 378-506 378-507, 378-513 378-508 378-514
Objective	(Optional) see pg. I-28 thru I-32
Reflected illumination	<ul style="list-style-type: none"> <li>• Telecentric system with aperture stop system.</li> <li>• Fiber-optic illuminator (optional) is required.</li> </ul>
Light source	Halogen bulb (21V, 150W) (optional)
Mass	<b>378-505:</b> 570g <b>378-506:</b> 590g <b>378-507:</b> 980g <b>378-508:</b> 1010g <b>378-513:</b> 1300g <b>378-514:</b> 1300g

### Selection Guide of System Configuration

Order No. (Depends on each system configuration)	VMU-V 378-505	VMU-H 378-506	VMU-L 378-507	VMU-L4 378-508	VMU-LB 378-513	VMU-L4B 378-514
Vertical CCD camera mount	●	●	●	●	●	●
Horizontal CCD camera mount		●				
YAG laser mount			●	●	●	●
Fiber-optic illumination unit	▲	▲	▲	▲	▲	▲
M Plan Apo, M Plan Apo SL, G Plan Apo objectives for bright field observation	▲	▲	▲	▲	▲	▲
M Plan Apo NIR, LCD Plan Apo NIR, M Plan Apo NUV and LCD Plan Apo NUV objectives for laser cutting			▲		▲	▲
M Plan UV objectives for laser machining				▲		▲

●: Provided, ▲: Available as optional accessory

### Wide VMU:

#### FEATURES

- Offers approximately 7 times larger inspection area.
- Increases throughput by allowing for batch measurements.
- BD models can accommodate darkfield optics.

- 378-515** WIDE VMU-V
- 378-516** WIDE VMU-H
- 378-517** WIDE VMU-BDV
- 378-518** WIDE VMU-BDH



### Technical Data

FOV in Camera Port	30mm Diameter
Camera Mount	F Mount (with C mount Adapter)
Example Sensor Size	APS-C format (2 inches)

### Wide VMU Accessories

<b>378-724</b>	BF Revolver
<b>378-725</b>	BD Revolver
<b>378-726</b>	BF Motorized Revolver
<b>378-727</b>	BD Motorized Revolver

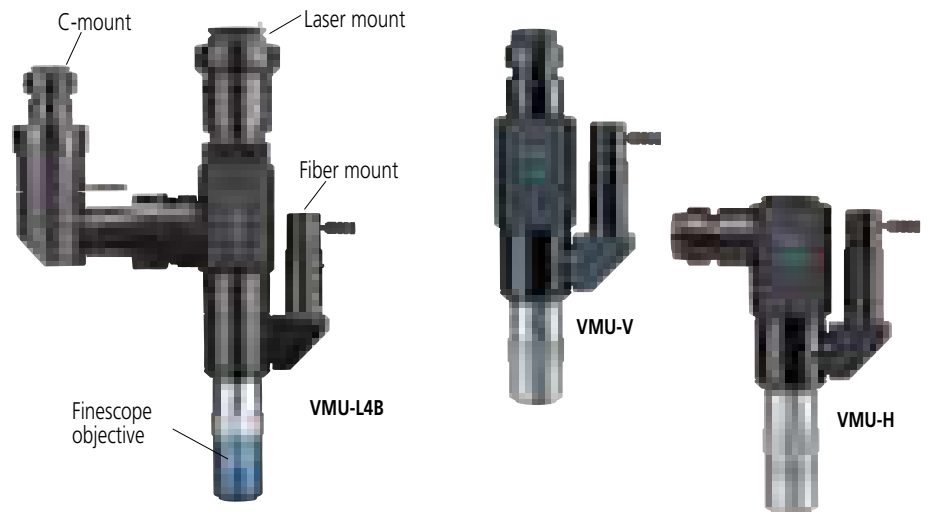
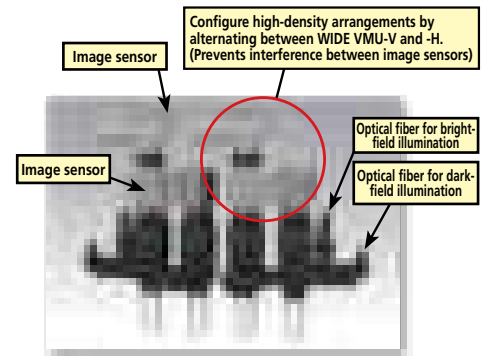
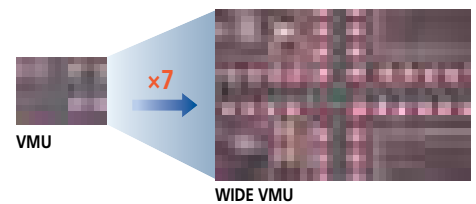

# Eyepieces

## SERIES 378

### FEATURES

- The field of view is extra wide.
- Optional reticles are available.

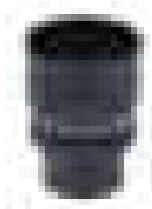

378-866



378-857



378-858

### SPECIFICATIONS

Order No. (2pcs. set)	Magnification	Field number	Mass	Individual order No.
<b>378-866</b>	10X	24	85g	<b>378-856-5</b>
<b>378-857</b>	15X	16	40g	<b>378-857-5</b>
<b>378-858</b>	20X	12	55g	<b>378-858-5</b>

# Objectives

## SERIES 378

The Mitutoyo 378 Series objectives have the world's longest working distance and an infinity correction optical system. These objectives provide flexible observation at high magnifications and independent correction of chromatic aberration.

### FEATURES

- The long working distance objectives provide excellent clearance between the lens surface and the workpiece surface in focus, making it possible to observe workpieces which are usually hard-to-focus because of awkward projections.

- The metallurgical plan apochromatic (M Plan Apo) objective provides a flat, chromatic aberration-free image throughout the field of view, making it suitable for any type of microscope.
- Specially designed objectives also are available with correction for near-infrared radiation, near-ultraviolet radiation, and ultraviolet radiation, or various thicknesses of LCD screen glasses.
- The mounting screw threads of objectives are designed to conform to JIS B-7141-1988.



M Plan Apo and M Plan Apo SL objectives for bright field observation



BD Plan Apo and BD Plan Apo SL objectives for bright/dark field observation

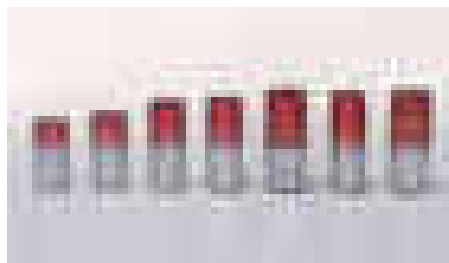

Near-infrared radiation corrected M Plan Apo NIR objectives

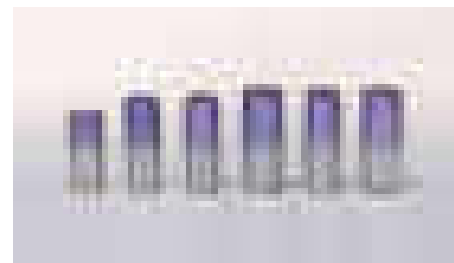

Near-ultraviolet radiation corrected M Plan Apo NUV objectives

### Reticles (optional)

- 516848:** Cross-hair
- 516576:** Broken cross hair (90° and 60°)
- 516578:** Concentric circle (Diametric increment: 1.2mm)
- 516577:** 20mm scale (Minimum reading: 0.1mm) with cross hair
- 516849:** 10mm scale (Minimum reading: 0.1mm)
- 516850:** 5mm scale (Minimum reading: 0.05mm)

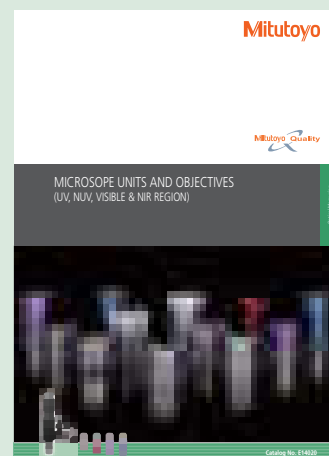

Refer to No. (E14020) for more details.

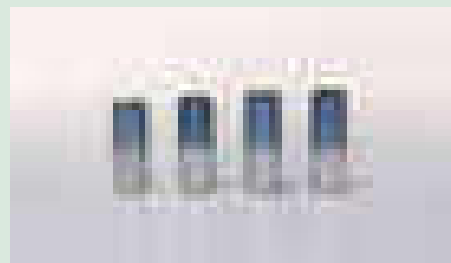

Ultraviolet radiation corrected M Plan UV objectives



### M Plan Apo for Bright Field Observation

Order No.	Mag.	N.A.	W.D.	f	R	D.F.	View field 1	View field 2	Mass
378-800-3	1X	0.025	11.0mm	200mm	11.0μm	440μm	ø24mm	4.8x6.4mm	300g
378-801-6	2X	0.055	34.0mm	100mm	5.0μm	91μm	ø12mm	2.4x3.2mm	220g
378-802-6	5X	0.14	34.0mm	40mm	2.0μm	14.0μm	ø4.8mm	0.96x1.28mm	230g
378-807-3	7.5X	0.21	35.0mm	26.67mm	1.3μm	6.2μm	ø3.6mm	0.64x0.85mm	240g
378-803-3	10X	0.28	34.0mm	20mm	1.0μm	3.5μm	ø2.4mm	0.48x0.64mm	240g
378-804-3	20X	0.42	20.0mm	10mm	0.7μm	1.6μm	ø1.2mm	0.24x0.32mm	270g
378-805-3	50X	0.55	13.0mm	4mm	0.5μm	0.9μm	ø0.48mm	0.10x0.13mm	290g
378-806-3	100X	0.70	6.0mm	2mm	0.4μm	0.6μm	ø0.24mm	0.05x0.06mm	320g

### DIMENSIONS

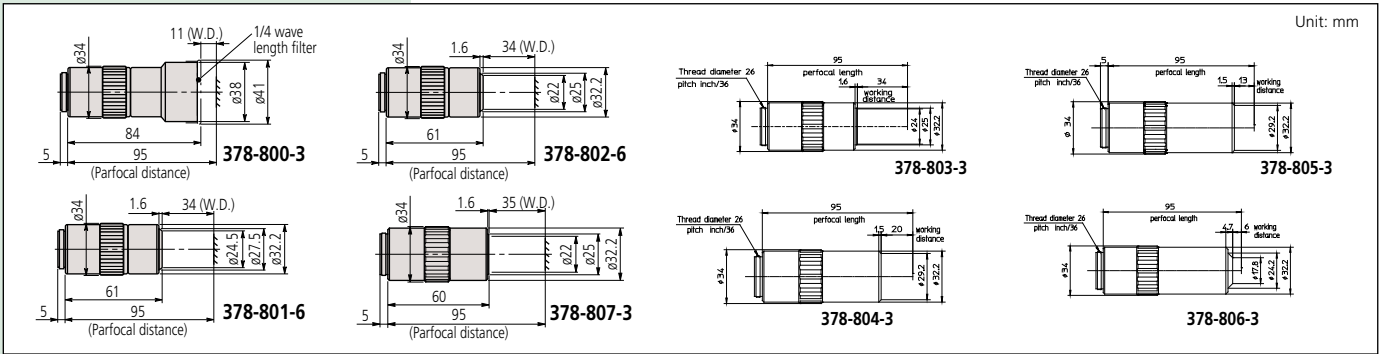

Note:  
These objectives offer extra-long working distance.

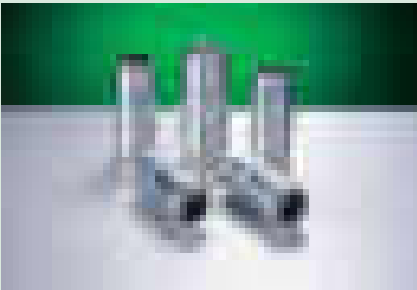

### M Plan Apo SL for Bright Field Observation

Order No.	Mag.	N.A.	W.D.	f	R	D.F.	View field 1	View field 2	Mass
378-810-3	20X	0.28	30.5mm	10mm	1.0μm	3.5μm	ø1.2mm	0.24x0.32mm	240g
378-811-15	50X	0.42	20.5mm	4mm	0.7μm	1.6μm	ø0.48mm	0.10x0.13mm	280g
378-812-3	80X	0.50	15.0mm	2.5mm	0.6μm	1.1μm	ø0.3mm	0.06x0.08mm	280g
378-813-3	100X	0.55	13.0mm	2mm	0.5μm	0.9μm	ø0.24mm	0.05x0.06mm	290g
378-816-3	200X	0.62	13.0mm	1mm	0.4μm	0.7μm	ø0.12mm	0.025x0.03mm	490g

### DIMENSIONS

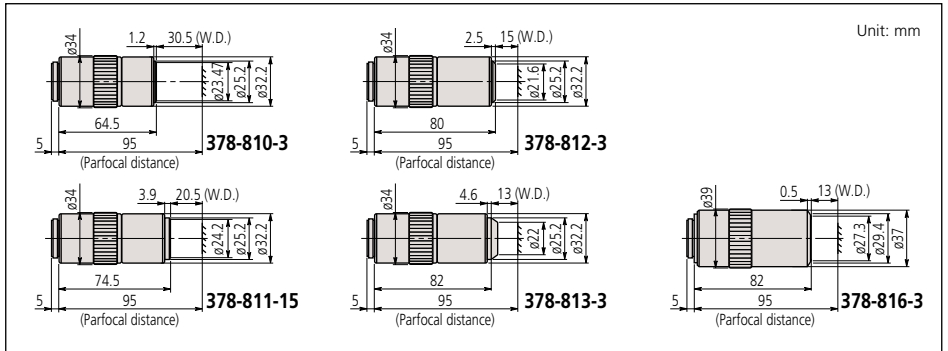

Note:  
These objectives offer extra-high resolving power.

Mag.: Magnification  
N.A.: Numerical aperture  
W.D.: Working distance  
f: Focal distance  
R: Resolving power  
D.F.: Focal depth  
View field 1:  
Field of view when using ø24mm eyepiece  
View field 2:  
Field of view when using 1/2" CCD camera

### M Plan Apo HR for Bright Field Observation

Order No.	Mag.	N.A.	W.D.	f	R	D.F.	View field 1	View field 2	Mass
378-787-4	5X	0.21	25.5mm	40mm	1.3μm	6.2μm	ø4.8mm	0.96x1.28mm	285g
378-788-4	10X	0.42	15mm	20mm	0.7μm	1.6μm	ø2.4mm	0.48x0.64mm	460g
378-814-4	50X	0.75	5.2mm	4mm	0.4μm	0.49μm	ø0.48mm	0.10x0.13mm	400g
378-815-4	100X	0.90	1.3mm	2mm	0.3μm	0.34μm	ø0.24mm	0.05x0.06mm	410g

### DIMENSIONS

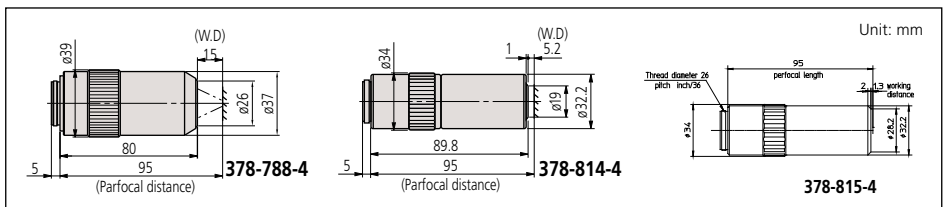

## Glass Thickness (t = 3.5mm) Corrected G Plan Apo for Bright Field Observation

Order No.	Mag.	N.A.	W.D.	f	R	D.F.	View field 1	View field 2	Mass
378-847	20X	0.28	29.42mm*	10mm	1.0μm	3.5μm	ø1.2mm	0.24x0.32mm	270g
378-848-3	50X	0.50	13.89mm*	4mm	0.6μm	1.1μm	ø0.48mm	0.10x0.13mm	320g

\*In air

### DIMENSIONS

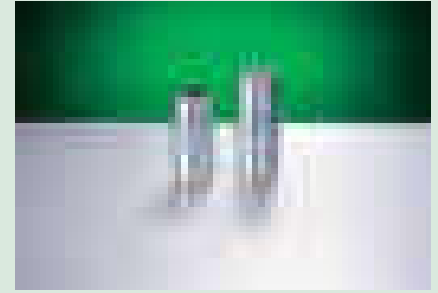
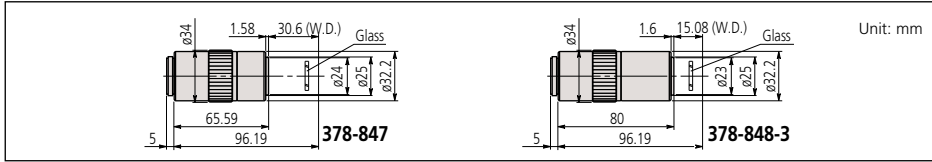

Note:  
The G Plan Apo Series are designed for observing a workpiece through BK-7 glass (thickness = 3.5mm).

## BD Plan Apo for Bright/Dark Field Observation

Order No.	Mag.	N.A.	W.D.	f	R	D.F.	View field 1	View field 2	Mass
378-831-7	2X	0.055	34.0mm	100mm	5.0μm	91μm	ø12mm	2.4x3.2mm	340g
378-832-7	5X	0.14	34.0mm	40mm	2.0μm	14.0μm	ø4.8mm	0.96x1.28mm	350g
378-830-7	7.5X	0.21	34.0mm	26.67mm	1.3μm	6.2μm	ø3.6mm	0.64x0.85mm	350g
378-833-7	10X	0.28	34.0mm	20mm	1.0μm	3.5μm	ø2.4mm	0.48x0.64mm	350g
378-834-7	20X	0.42	20.0mm	10mm	0.7μm	1.6μm	ø1.2mm	0.24x0.32mm	400g
378-835-7	50X	0.55	13.0mm	4mm	0.5μm	0.9μm	ø0.48mm	0.10x0.13mm	440g
378-836-7	100X	0.70	6.0mm	2mm	0.4μm	0.6μm	ø0.24mm	0.05x0.06mm	460g

### DIMENSIONS

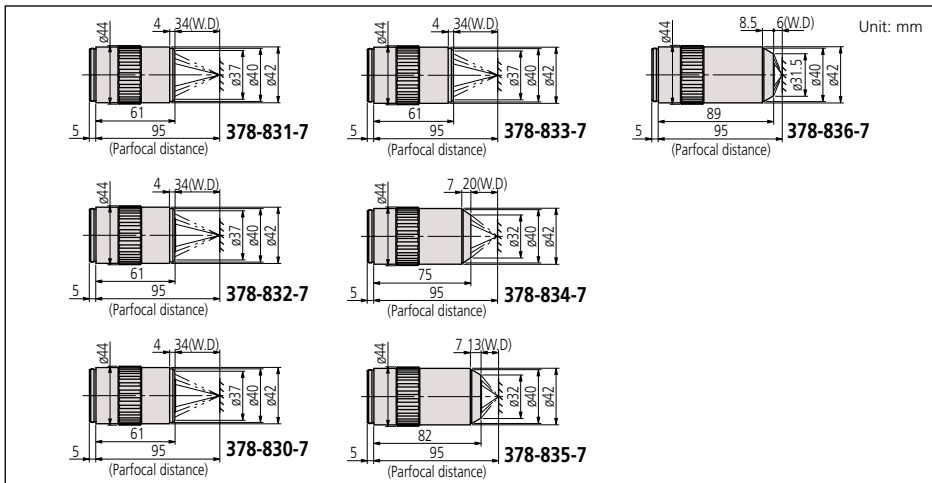

## BD Plan Apo SL for Bright/Dark Field Observation

Order No.	Mag.	N.A.	W.D.	f	R	D.F.	View field 1	View field 2	Mass
378-840-7	20X	0.28	30.5mm	10mm	1.0μm	3.5μm	ø1.2mm	0.24x0.32mm	350g
378-841-7	50X	0.42	20.0mm	4mm	0.7μm	1.6μm	ø0.48mm	0.10x0.13mm	410g
378-842-7	80X	0.50	13.0mm	2.5mm	0.6μm	1.1μm	ø0.3mm	0.06x0.08mm	430g
378-843-7	100X	0.55	13.0mm	2mm	0.5μm	0.9μm	ø0.24mm	0.05x0.06mm	440g

### DIMENSIONS

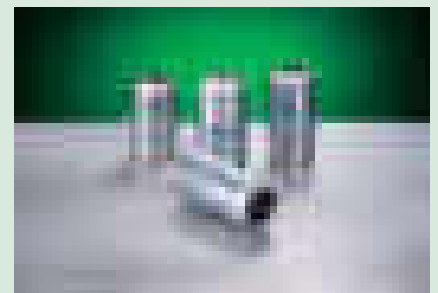
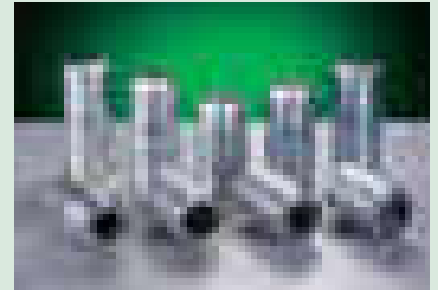
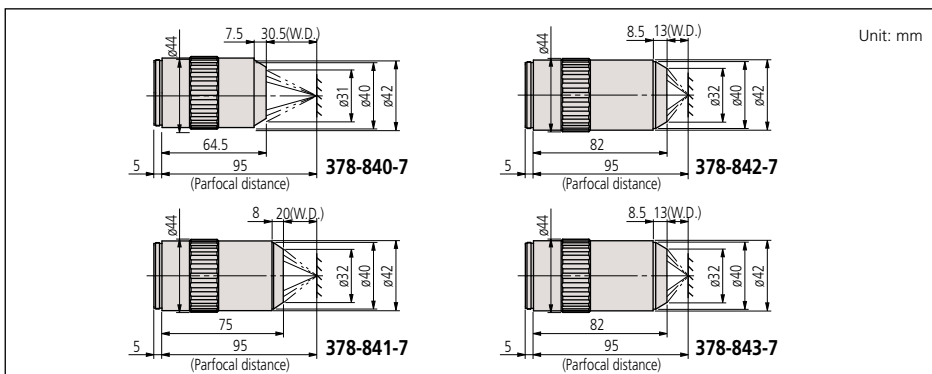

Note:  
These objectives offer extra-long working distance.

Mag.: Magnification  
N.A.: Numerical aperture  
W.D.: Working distance  
f: Focal distance  
R: Resolving power  
D.F.: Focal depth  
View field 1: Field of view when using ø24mm eyepiece  
View field 2: Field of view when using 1/2" CCD camera



## DIMENSIONS

Unit: mm

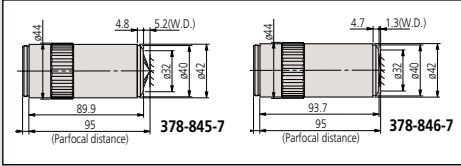

## DIMENSIONS

Unit: mm

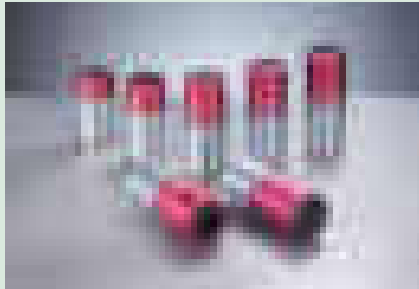
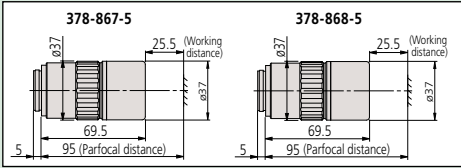

Note:

These objectives are designed so that a workpiece's image can be focused within the focal depth even when the wavelength is changed anywhere from the visible range ( $\lambda = 480\text{nm}$ ) up to near-infrared range ( $\lambda = 1800\text{nm}$ ). Therefore, the M Plan NIR Series are suitable for laser repair. However, when the wavelength used exceeds  $1100\text{nm}$ , the focusing position may slightly deviate from that in the visible range due to changes in glass dispersion and refractive index.



Note:

These objectives are designed so that a workpiece's image can be focused within the focal depth even when the wavelength is changed anywhere from the visible range ( $\lambda = 620\text{nm}$ ) to the near-ultraviolet range ( $\lambda = 355\text{nm}$ ). Therefore The M Plan NUV Series are suitable for laser repair using a high frequency laser beam.

Mag.: Magnification  
N.A.: Numerical aperture  
W.D.: Working distance  
f: Focal distance  
R: Resolving power  
D.F.: Focal depth

View field 1: Field of view when using  $\phi 24\text{mm}$  eyepiece  
View field 2: Field of view when using  $1/2''$  CCD camera

## BD Plan Apo HR for Bright/Dark Field Observation

Order No.	Mag.	N.A.	W.D.	f	R	D.F.	View field 1	View field 2	Mass
378-845-7	50X	0.75	5.2mm	4mm	$0.4\mu\text{m}$	$0.49\mu\text{m}$	$\phi 0.48\text{mm}$	$0.10 \times 0.13\text{mm}$	530g
378-846-7	100X	0.90	1.3mm	2mm	$0.3\mu\text{m}$	$0.34\mu\text{m}$	$\phi 0.24\text{mm}$	$0.05 \times 0.06\text{mm}$	545g

Note: These objectives offer extra-high resolving power.

## M Plan Apo NIR B

Order No.	Mag.	N.A.	W.D. (mm)	f (mm) ( $\lambda = 550\text{nm}$ )	R ( $\mu\text{m}$ ) ( $\lambda = 550\text{nm}$ )	$\pm\text{DOF}$ ( $\mu\text{m}$ )	View field 1	View field 2	Mass (g)
378-867-5	20X	0.40	25.5	10	0.7	1.7	1.2	$0.24 \times 0.32$	350
378-868-5	50X	0.42	25.5	4	0.7	1.6	0.48	$0.10 \times 0.13$	375

> A high-transmission laser type objective suited to the fundamental and second harmonic of the YAG laser. Corrected over the visible ( $420\text{nm}$ ) to near-infrared ( $1064\text{nm}$ ) spectrum.  
> This series of objective has greatly improved in operability thanks to the achievement of an ultra-long working distance of  $25.5\text{mm}$  while maintaining the NA of the NIR series 20X/50X.

## Near-infrared Radiation Corrected M Plan Apo NIR for Bright Field Observation

Order No.	Mag.	N.A.	W.D.	f	R	D.F.	View field 1	View field 2	Mass
378-822-5	5X	0.14	$37.5\text{mm}$	$40\text{mm}$	$2.0\mu\text{m}$	$14.0\mu\text{m}$	$\phi 4.8\text{mm}$	$0.96 \times 1.28\text{mm}$	220g
378-823-5	10X	0.26	$30.5\text{mm}$	$20\text{mm}$	$1.1\mu\text{m}$	$4.1\mu\text{m}$	$\phi 2.4\text{mm}$	$0.48 \times 0.64\text{mm}$	250g
378-824-5	20X	0.40	$20.0\text{mm}$	$10\text{mm}$	$0.7\mu\text{m}$	$1.7\mu\text{m}$	$\phi 1.2\text{mm}$	$0.24 \times 0.32\text{mm}$	300g
378-825-5	50X	0.42	$17.0\text{mm}$	$4\text{mm}$	$0.7\mu\text{m}$	$1.6\mu\text{m}$	$\phi 0.48\text{mm}$	$0.10 \times 0.13\text{mm}$	315g
378-826-15	100X	0.50	$12.0\text{mm}$	$2\text{mm}$	$0.6\mu\text{m}$	$1.1\mu\text{m}$	$\phi 0.24\text{mm}$	$0.05 \times 0.06\text{mm}$	335g
378-863-5*	50X	0.65	$10\text{mm}$	$4\text{mm}$	$0.4\mu\text{m}$	$0.7\mu\text{m}$	$\phi 0.48\text{mm}$	$0.10 \times 0.13\text{mm}$	450g
378-864-5*	100X	0.70	$10\text{mm}$	$2\text{mm}$	$0.4\mu\text{m}$	$0.6\mu\text{m}$	$\phi 0.24\text{mm}$	$0.05 \times 0.06\text{mm}$	450g

\* High Resolution (HR objectives)

## DIMENSIONS

Unit: mm

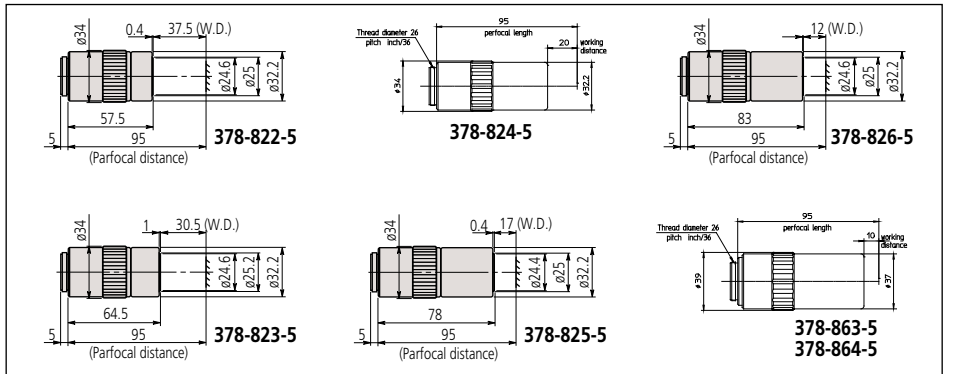

## Near-ultraviolet Radiation Corrected M Plan Apo NUV for Bright Field Observation

Order No.	Mag.	N.A.	W.D.	f	R	D.F.	View field 1	View field 2	Mass
378-809-5	10X	0.28	$30.5\text{mm}$	$20\text{mm}$	$1\mu\text{m}$	$3.5\mu\text{m}$	$\phi 2.4\text{mm}$	$0.48 \times 0.64\text{mm}$	255g
378-817-8	20X	0.42	$17.0\text{mm}$	$10\text{mm}$	$0.7\mu\text{m}$	$1.7\mu\text{m}$	$\phi 1.2\text{mm}$	$0.24 \times 0.32\text{mm}$	340g
378-818-8	50X	0.44	$15.0\text{mm}$	$4\text{mm}$	$0.7\mu\text{m}$	$1.6\mu\text{m}$	$\phi 0.48\text{mm}$	$0.10 \times 0.13\text{mm}$	350g
378-819-4	100X	0.50	$11.0\text{mm}$	$2\text{mm}$	$0.6\mu\text{m}$	$1.1\mu\text{m}$	$\phi 0.24\text{mm}$	$0.05 \times 0.06\text{mm}$	380g
378-888-6*	50X	0.65	$10.00\text{mm}$	$4\text{mm}$	$0.42\mu\text{m}$	$0.65\mu\text{m}$	$\phi 0.48\text{mm}$	$0.10 \times 0.13\text{mm}$	500g

\*High resolution (HR objective)

## DIMENSIONS

Unit: mm

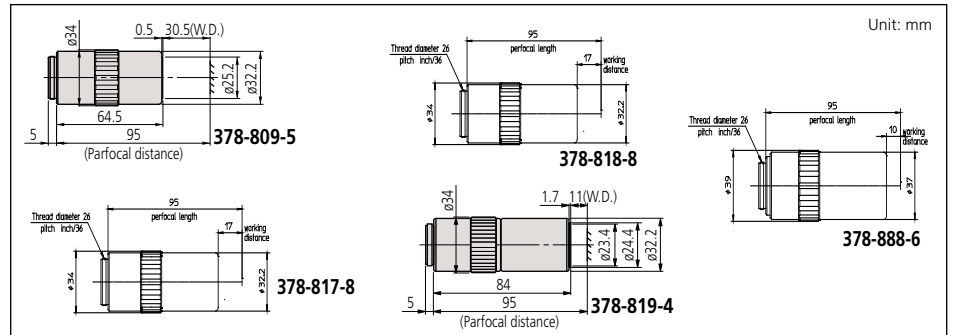

## Near-Infrared Radiation and LCD Glass Thickness (t = 1.1mm or 0.7mm) Corrected LCD Plan Apo NIR for Bright Field Observation

Order No.	Mag.	N.A.	W.D.	f	R	D.F.	View field 1	View field 2	Mass
378-821-5	20X (t0.7)	0.40	19.98mm*	10mm	0.7μm	1.7μm	ø1.2mm	0.24x0.32mm	305g
378-827-5	20X (t1.1)	0.40	19.98mm*	10mm	0.7μm	1.7μm	ø1.2mm	0.24x0.32mm	305g
378-828-5	50X (t1.1)	0.42	17.13mm*	3.9mm	0.7μm	1.6μm	ø0.48mm	0.10x0.13mm	320g
378-829-5	50X (t0.7)	0.42	17.26mm*	3.9mm	0.7μm	1.6μm	ø0.48mm	0.10x0.13mm	320g
378-752-15	100X (t1.1)	0.50	12.13mm*	2mm	0.6μm	1.1μm	ø0.24mm	0.05x0.06mm	335g
378-754-15	100X (t0.7)	0.50	12.06mm*	2mm	0.6μm	1.1μm	ø0.24mm	0.05x0.06mm	335g

\*In air

### DIMENSIONS

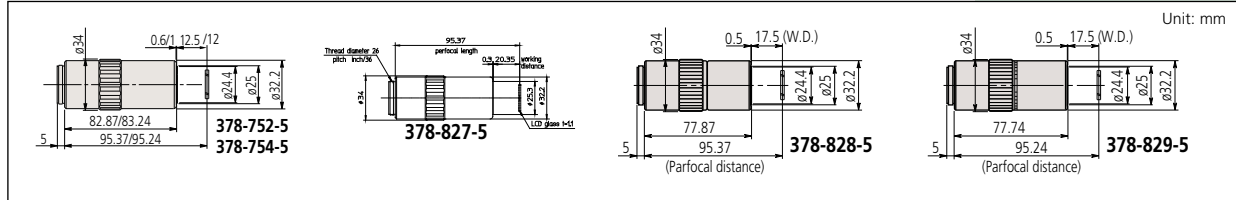

Note:  
These near-infrared (λ = 1800nm) corrected objectives are designed for observing a workpiece through LCD glass (thickness = 1.1mm (378-827-5, 378-828-5, 378-752-5) or 0.7mm (378-829-5, 378-754-5) and for laser repair.

## Near-ultraviolet Radiation and LCD Glass Thickness (t = 0.7mm) Corrected LCD Plan Apo NUV for Bright Field Observation

Order No.	Mag.	N.A.	W.D.	f	R	D.F.	View field 1	View field 2	Mass
378-890-8	20X (t0.7)	0.42	16.96mm*	10mm	0.7μm	1.7μm	ø1.2mm	0.24x0.32mm	340g
378-891-6**	50X (t0.7)	0.65	9.76mm*	4mm	0.42μm	0.65μm	ø0.48mm	0.10x0.13mm	500g
378-820-6	50X (t0.7)	0.44	14.76mm*	4mm	0.7μm	1.6μm	ø0.48mm	0.10x0.13mm	310g
378-753-8	50X (t1.1)	0.42	14.53mm	4mm	0.7μm	1.6μm	ø0.48mm	0.10x0.13mm	310g
378-751-4	100X (t1.1)	0.50	11.03mm	2mm	0.6μm	1.1μm	ø0.24mm	0.05x0.06mm	380g

\* In air  
\*\* High-Resolution (HR Objectives)

### DIMENSIONS

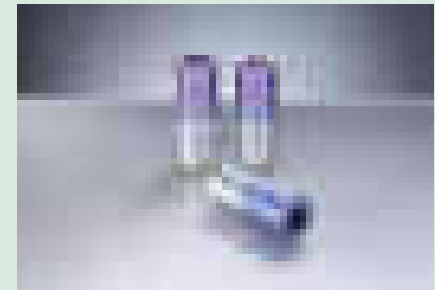
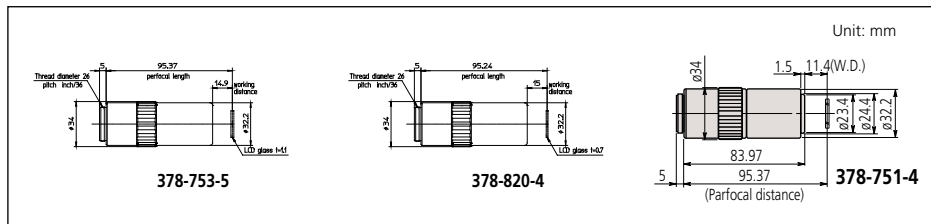

Note:  
These near ultraviolet corrected objectives are designed for observing a workpiece through LCD glass (thickness = 1.1mm (378-753-6, 378-751-4) or 0.7mm (378-820-6) and for laser repair.

## Ultraviolet Radiation Corrected M Plan UV for Bright Field Observation

Order No.	Mag.	N.A.	W.D.	f	R	D.F.	View field 1	View field 2	Mass
378-844-15	10X	0.25	20mm	20mm	1.1μm	4.4μm	ø2.4mm	0.48x0.64mm	310g
378-837-7	20X	0.37	15.0mm	10mm	0.8μm	2.1μm	ø1.2mm	0.24x0.32mm	330g
378-838-8	50X	0.41	12.0mm	4mm	0.7μm	1.7μm	ø0.48mm	0.10x0.13mm	400g
378-839-5	80X	0.55	10.0mm	2.5mm	0.5μm	0.9μm	ø0.3mm	0.06x0.08mm	380g

### DIMENSIONS

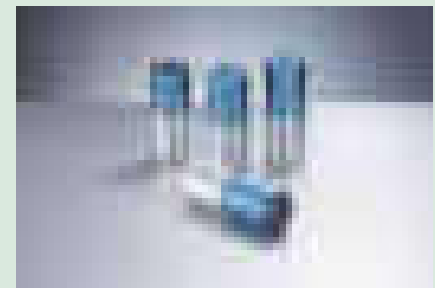
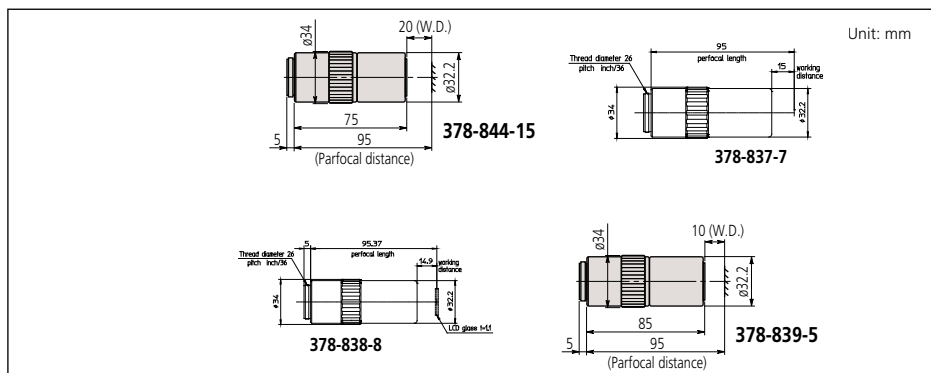

Note:  
These ultraviolet corrected objectives are designed so that a workpiece's image can be focused within the focal depth even when the wavelength is changed anywhere from the visible range (λ = 550nm) to the ultraviolet range (λ = 266nm). Therefore the M Plan UV Series are suitable for laser repair using a high-frequency laser beam.

Mag.: Magnification  
N.A.: Numerical aperture  
W.D.: Working distance  
f: Focal distance  
R: Resolving power  
D.F.: Focal depth  
View field 1: Field of view when using ø24mm eyepiece  
View field 2: Field of view when using 1/2" CCD camera

# MSM-400

## SERIES 377 — Stereo Microscopes

### FEATURES

- Continuous 1X - 4X magnification
- Image always in focus throughout zoom range
- Crisp, erect images with high resolution and excellent stereoscopic effect
- Stereo-tube can be rotated a full 360°, for viewing at any angle
- Bilateral zoom control knob adds convenience and increases operator efficiency
- Diopter adjustment for both eyepieces

- Binocular tube inclination: 45°
- Focusing range: 1.46" (37mm)
- Interpupillary adjustable range: 2.12" - 2.99" (54mm - 76mm)
- Optional zoom ranges from 2.5X - 10X to 30X - 120X

The MSM-414L is a traditional binocular stereo microscope for industrial, medical and classroom applications. It is ideal for electrical small part inspection, assembly, and medical/biological dissection.

### Optional Accessories

#### Illuminated Stand

Order No.	Description
377-412	Pole-Type Stand (top: 12V/10W flat filament tungsten, bottom: 5W fluorescent)
377-413*	Pole-Type Stand (top: 12V/10W flat filament tungsten, bottom: 12V/10W halogen with intensity control)
377-414	Fixed-Arm Stand (top: 12V/10W flat filament tungsten, bottom: 5W fluorescent)
377-415	Fixed-Arm Stand (top: 12V/10W flat filament tungsten, bottom: 12V/10W halogen with intensity control)
377-416	Fixed-Arm Stand (top: 5W fluorescent, bottom: 5W fluorescent)

\*Standard Accessory

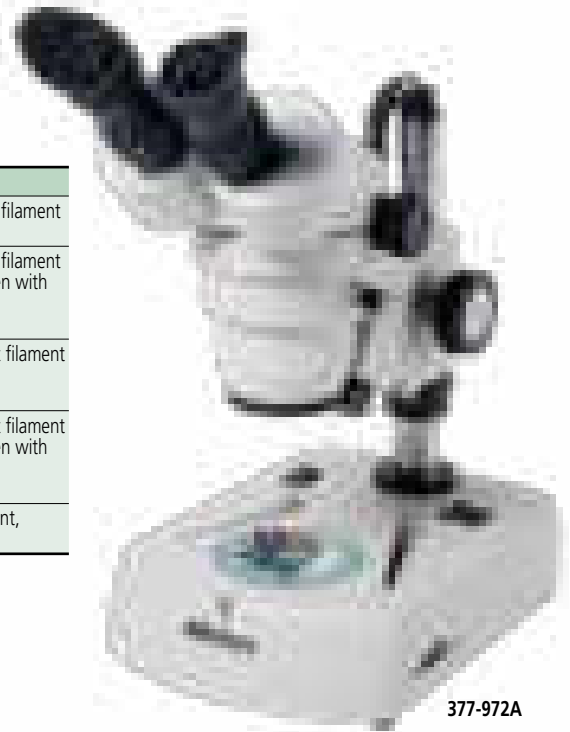

### Digital Imaging with Software

Order No.	Description
64AAB429	MOTICAM 2, 2.0 MEGAPIXEL-1/3" CMOS, USB
64AAB529	MOTICAM 3+, 3.0 MEGAPIXEL-1/2" CMOS, USB
64AAB431	MOTICAM 5, 5.0 MEGAPIXEL-1/2.5" CMOS, USB
64AAB526	MOTICAM 1080, 2.0 MEGAPIXEL-1/2.8" CMOS, USB/HDMI



### Optional Accessories

Order No.	Description
64AAB214	LED Variable Ring Light

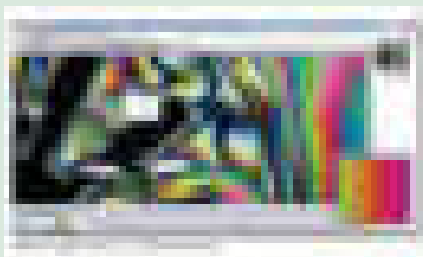

### SPECIFICATIONS

Model.	MSM-414L	MSM-414TL
Order No.	377-972A	377-974A
Optical tube	Binocular	Trinocular
Total magnification	10X - 40X	
Eyeiece	10X (377-016)	
Objective	1X - 4X	
Working distance	80mm	
Field of view	20mm - 5mm	
Dimensions	H=13.2" x W=6.7" x D=9.3"	
Mass	13.2 lbs (6kg)	

# Stereo Microscopes

SERIES 377

## 377-972A/377-974A SYSTEM DIAGRAM

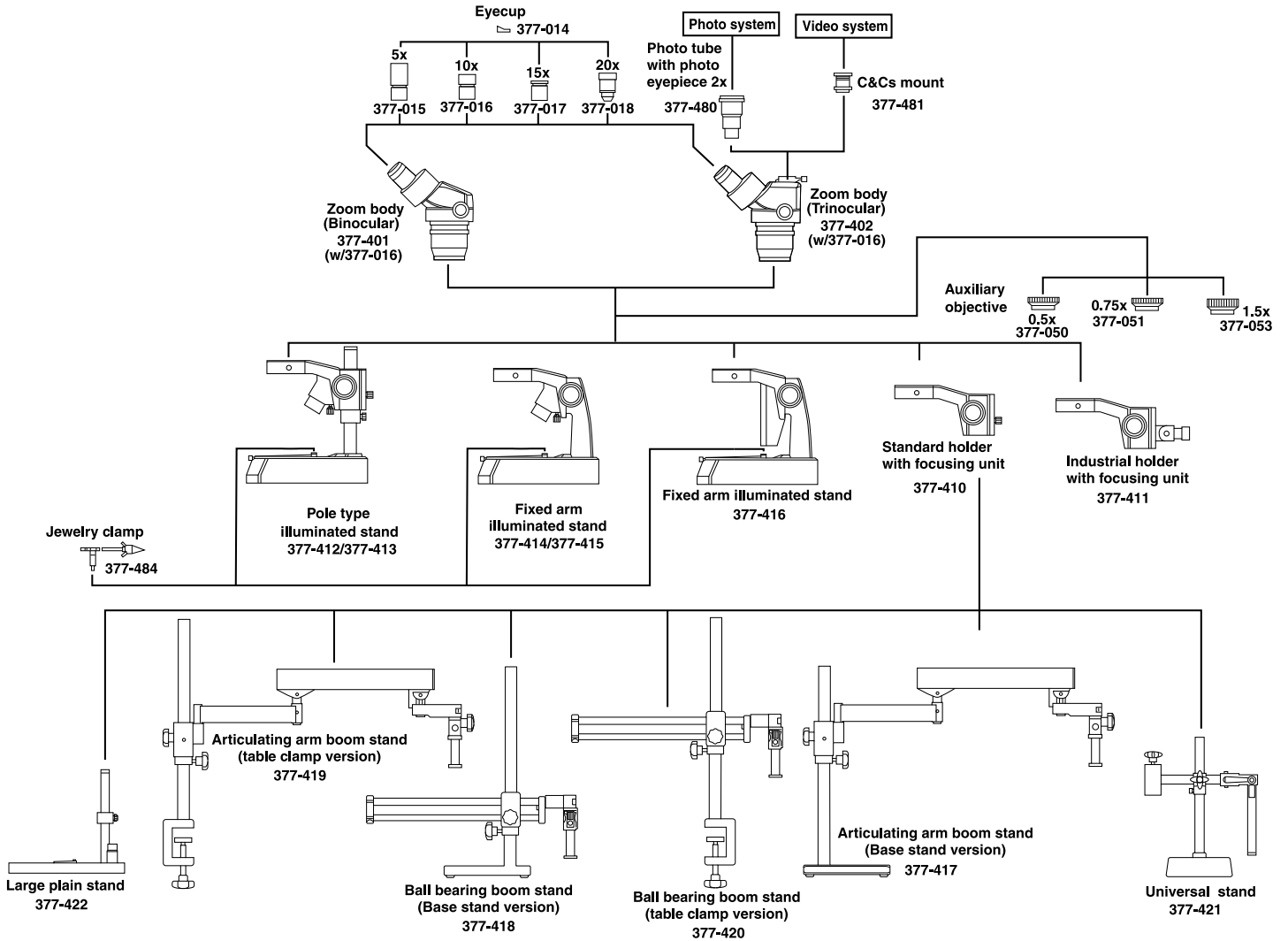

# MSM-400

## SERIES 377 — Stereo Microscopes

### Optional Accessories

#### Video System

Order No.	Description
377-488	Video System* for 377-990A
377-489	Video System* for 377-991A

\* Converts Binocular to Trinocular

### Accessories

Order No.	Description
64AAB214	LED variable ring light

### FEATURES

- Superior quality optics provide high-resolution
- Crystal sharp, high-color contrast image with excellent depth of field
- Always in sharp focus at all magnifications
- The Parfocal Optical System allows relaxed strain-free viewing
- Long working distance
- Extreme large field of view (23mm diameter)

The MSM-465L, Order No. 377-990A, is a high-accuracy four-step magnification stereo microscope. With a horizontal

changer allowing 6X, 12X, 25X, and 50X magnifications with a standard 1X objective and 10X eyepieces, the MSM-465L has limitless capabilities for electrical small part inspection.

The MSM-464L, Order No. 377-991A, with its vertical five-step magnification changer is ideal for small part assembly. This stereo microscope with standard 6.4X, 10X, 16X, 25X, and 40X magnifications, has flexibility from 3.2X to 160X magnifications.



MSM-465L  
377-990A



MSM-464L  
377-991A

### Digital Imaging with Software

Order No.	Description
64AAB429	MOTICAM 2, 2.0 MEGAPIXEL-1/3" CMOS, USB
64AAB529	MOTICAM 3+, 3.0 MEGAPIXEL-1/2" CMOS, USB
64AAB431	MOTICAM 5, 5.0 MEGAPIXEL-1/2.5" CMOS, USB
64AAB526	MOTICAM 1080, 2.0 MEGAPIXEL-1/2.8" CMOS, USB/HDMI

### SPECIFICATIONS

Model. Order No.	MSM-465L 377-990A	MSM-464TL 377-991A
Optical tube	Binocular*	Binocular*
Total magnification	6X - 50X	6.4X - 40X
Eyepiece	10X (377-456)	10X (377-456)
Objective	.6X, 1.2X, 2.5X, 5X	.6X, 1X, 1.6X, 2.5X, 4X
Working distance	89mm	89mm
Field of view	23mm (w/377-456)	23mm (w/377-456)
Dimensions	H=14.6" x W=13" x D=11"	H=14.3" x W=13" x D=11"
Mass	15.5 lbs (7kg)	15.5 lbs (7kg)
Stand	Transmitted Light Stand (377-428)	Transmitted Light Stand (377-428)

\* For Video System, see upper left table (optional accessories)

# Stereo Microscopes

SERIES 377

## 377-990A/377-991A SYSTEM DIAGRAM

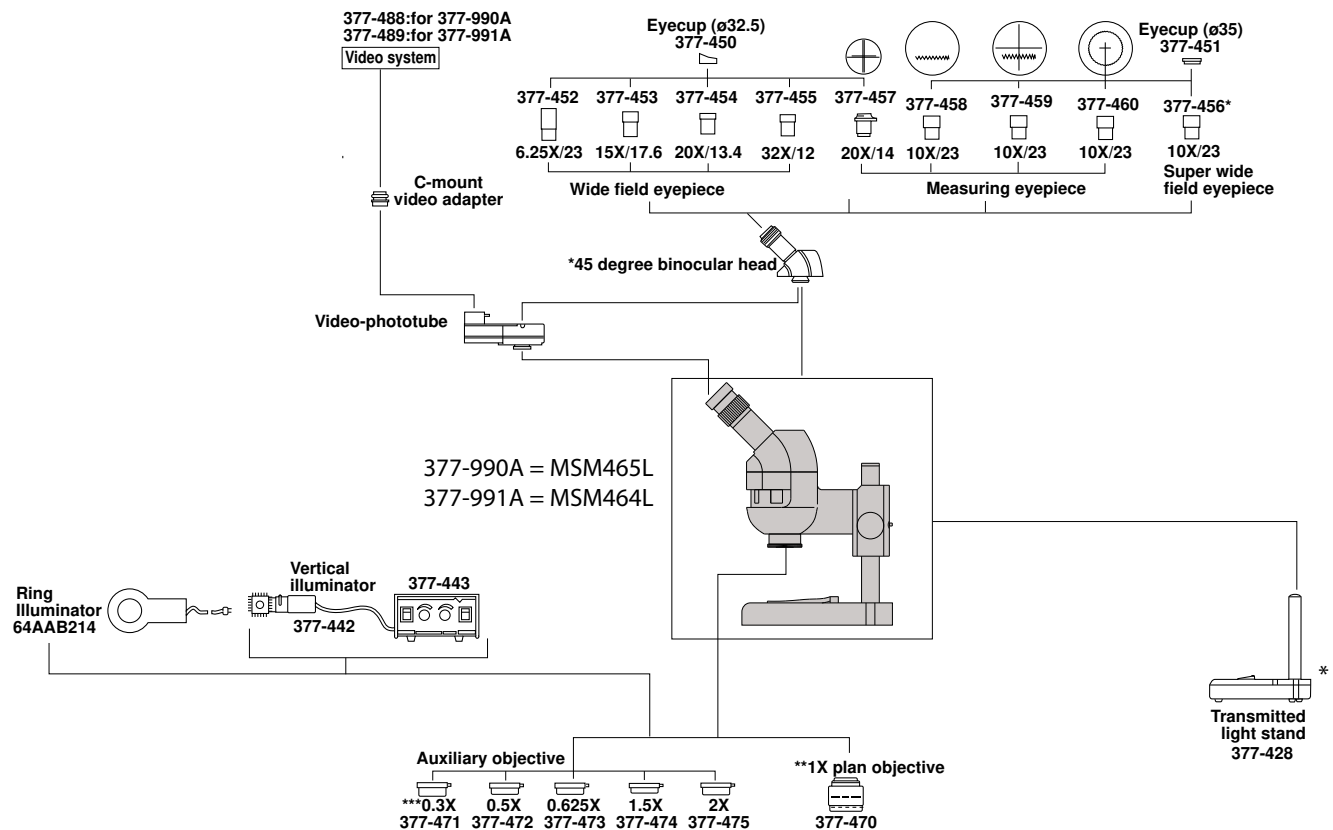

### Optional Stand

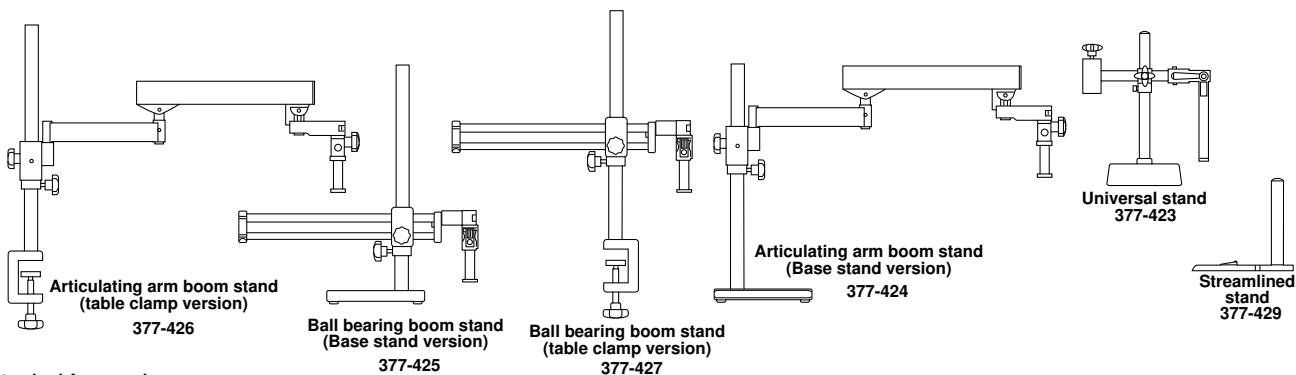

- \* Standard Accessories
- \*\* 1X plan objective can replace 1X standard built-in objective
- \*\*\* 350mm long stand post is required. (377-431)

# Pocket Magnifiers

## SERIES 183

### FEATURES

- Suitable for inspecting metal surfaces.

### SPECIFICATIONS

Magnification	Order No.	Remarks
25X	183-201	Pen type
	183-202	With stand
50X	183-203	With stand



183-201



183-202



183-203

### Optional Reticles for Pocket Comparators



183-102



183-103



183-104

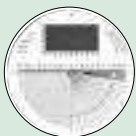

183-105



183-106



183-107

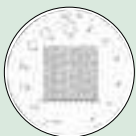

183-108



183-109



183-110



183-111



183-112



183-113



183-114



183-115

### Pocket Comparator 8X with Reticles Set

#### Set No.

183-901 183-101, 183-106

183-902 183-101, 183-102, 183-106, 183-107, 183-112, 183-113, 183-114

183-903 183-101, 183-102, 183-106, 183-107, 183-109, 183-113, 183-115

183-904 183-101, 183-102

# Pocket Comparators

## SERIES 183

### FEATURES

- By replacing optional reticles, dimensional, angle and other types of measurements can be performed.
- Illuminator (950757) is available.

### SPECIFICATIONS

Magnification	Order No.	Remarks
8X	183-101	Optional reticles available
10X	183-131	Optional reticles available



183-101

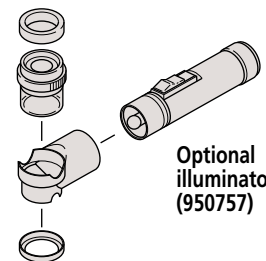

Optional illuminator (950757)

# Zoom Loupe

## SERIES 183

### FEATURES

- Allows the user 8X - 16X zoom observation.
- Magnification indicator is provided for 8X, 10X, 12X, 14X and 16X observation.
- Metric and inch scales are provided for measuring.
- Comes with a carrying case.



183-304

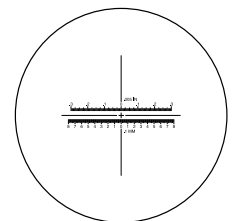

Reticle provided

### SPECIFICATIONS

Magnification	Order No.	Remarks
8X - 16X	183-304	With reticle (Scale graduation: 0.1mm, .005")

# Clear Loupe

## SERIES 183



183-301



183-302



183-303

### SPECIFICATIONS

Magnification	Order No.	Remarks
7X	183-301	Drawtube removable
10X	183-302	Drawtube removable
15X	183-303	Drawtube removable

# Quick Guide to Precision Measuring Instruments

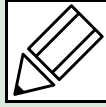

## Microscopes

### Numerical Aperture (NA)

The NA figure is important because it indicates the resolving power of an objective lens. The larger the NA value the finer the detail that can be seen. A lens with a larger NA also collects more light and will normally provide a brighter image with a narrower depth of focus than one with a smaller NA value.

$$NA = n \cdot \sin\theta$$

The formula above shows that NA depends on  $n$ , the refractive index of the medium that exists between the front of an objective and the specimen (for air,  $n=1.0$ ), and angle  $\theta$ , which is the half-angle of the maximum cone of light that can enter the lens.

### Resolving Power (R)

The minimum detectable distance between two image points, representing the limit of resolution. Resolving power (R) is determined by numerical aperture (NA) and wavelength ( $\lambda$ ) of the illumination.

$$R = \frac{\lambda}{2 \cdot NA} \text{ (}\mu\text{m)}$$

$\lambda = 0.55\mu\text{m}$  is often used as the reference wavelength

### Working Distance (W.D.)

The distance between the front end of a microscope objective and the surface of the workpiece at which the sharpest focusing is obtained.

### Parfocal Distance

The distance between the mounting position of a microscope objective and the surface of the workpiece at which the sharpest focusing is obtained. Objective lenses mounted together in the same turret should have the same parfocal distance so that when another objective is brought into use the amount of refocusing needed is minimal.

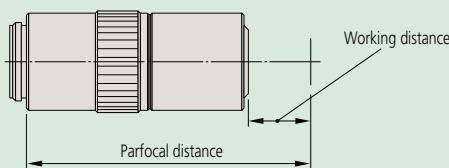

### Infinity Optical System

An optical system where the objective forms its image at infinity and a tube lens is placed within the body tube between the objective and the eyepiece to produce the intermediate image. After passing through the objective the light effectively travels parallel to the optical axis to the tube lens through what is termed the infinity space within which auxiliary components can be placed, such as differential interference contrast (DIC) prisms, polarizers, etc., with minimal effect on focus and aberration corrections.

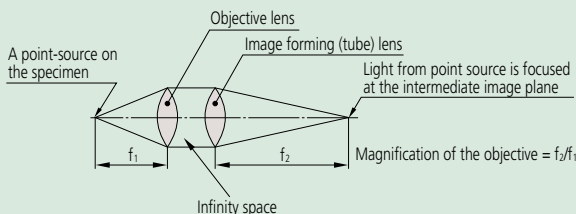

### Finite Optical System

An optical system that uses an objective to form the intermediate image at a finite position. Light from the workpiece passing through the objective is directed toward the intermediate image plane (located at the front focal plane of the eyepiece) and converges in that plane.

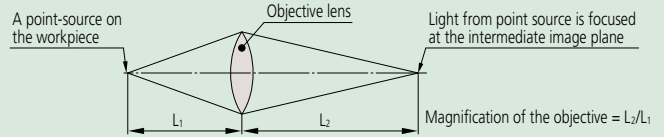

### Focal Length (f)

unit: mm

The distance from the principal point to the focal point of a lens: if  $f_1$  represents the focal length of an objective and  $f_2$  represents the focal length of an image forming (tube) lens then magnification is determined by the ratio between the two. (In the case of the infinity-correction optical system.)

$$\text{Objective magnification} = \frac{\text{Focal length of the image-forming (tube) lens}}{\text{Focal length of the objective}}$$

$$\text{Example: } 1X = \frac{200}{200} \quad \text{Example: } 10X = \frac{200}{20}$$

### Focal Point

Light rays traveling parallel to the optical axis of a converging lens system and passing through that system will converge (or focus) to a point on the axis known as the rear focal point, or image focal point.

### Depth of Focus (DOF)

unit: mm

Also known as depth of field, this is the distance (measured in the direction of the optical axis) between the two planes which define the limits of acceptable image sharpness when the microscope is focused on an object. As the numerical aperture (NA) increases, the depth of focus becomes shallower, as shown by the expression below:

$$DOF = \frac{\lambda}{2 \cdot (NA)^2} \quad \lambda = 0.55\mu\text{m} \text{ is often used as the reference wavelength}$$

Example: For an **M Plan Apo 100X** lens ( $NA = 0.7$ )

The depth of focus of this objective is

$$\frac{0.55\mu\text{m}}{2 \times 0.7^2} = 0.6\mu\text{m}$$

### Bright-field Illumination and Dark-field Illumination

In brightfield illumination a full cone of light is focused by the objective on the specimen surface. This is the normal mode of viewing with an optical microscope. With darkfield illumination, the inner area of the light cone is blocked so that the surface is only illuminated by light from an oblique angle. Darkfield illumination is good for detecting surface scratches and contamination.

### Apochromat and Achromat Objectives

An apochromat objective is a lens corrected for chromatic aberration (color blur) in three colors (red, blue, yellow).

An achromat objective is a lens corrected for chromatic aberration in two colors (red, blue).



## ■ Magnification

The ratio of the size of a magnified object image created by an optical system to that of the object. Magnification commonly refers to lateral magnification although it can mean lateral, vertical, or angular magnification.

## ■ Principal Ray

A ray considered to be emitted from an object point off the optical axis and passing through the center of an aperture diaphragm in a lens system.

## ■ Aperture Diaphragm

An adjustable circular aperture which controls the amount of light passing through a lens system. It is also referred to as an aperture stop and its size affects image brightness and depth of focus.

## ■ Field Stop

A stop which controls the field of view in an optical instrument.

## ■ Telecentric System

An optical system where the light rays are parallel to the optical axis in object and/or image space. This means that magnification is nearly constant over a range of working distances, therefore, almost eliminating perspective error.

## ■ Erect Image

An image in which the orientations of left, right, top, bottom and moving directions are the same as those of a workpiece on the workstage.

## ■ Field number (FN), real field of view, and monitor display magnification

unit: mm

The observation range of the sample surface is determined by the diameter of the eyepiece's field stop. The value of this diameter in millimeters is called the field number (FN). In contrast, the real field of view is the range on the workpiece surface when actually magnified and observed with the objective lens.

The real field of view can be calculated with the following formula:

### (1) The range of the workpiece that can be observed with the microscope (diameter)

$$\text{Real field of view} = \frac{\text{FN of eyepiece}}{\text{Objective lens magnification}}$$

Example: The real field of view of a 1X lens is  $24 = \frac{24}{1}$   
The real field of view of a 10X lens is  $2.4 = \frac{24}{10}$

### (2) Monitor observation range

$$\text{Monitor observation range} = \frac{\text{The size of the camera image sensor (diagonal length)}}{\text{Objective lens magnification}}$$

#### • Size of image sensor

Format	Diagonal length	Length	Height
1/3"	6.0	4.8	3.6
1/2"	8.0	6.4	4.8
2/3"	11.0	8.8	6.6

### (3) Monitor display magnification

Monitor display magnification =

$$\text{Objective lens magnification} \times \frac{\text{Display diagonal length on the monitor}}{\text{Diagonal length of camera image sensor}}$$

# MITUTOYO CALIBRATION SERVICES

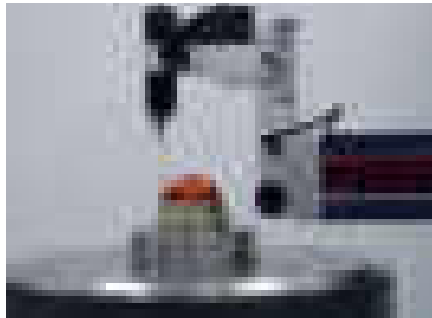

Mitutoyo America has expanded three-dimensional calibration and inspection services at our new precision measurement facility located in our corporate headquarters in Aurora, IL. Equipped with multiple Mitutoyo Legex CMMs, along with high-accuracy vision and form measuring instruments, our laboratory offers accredited dimensional measurement services with uncertainty as low as 0.25  $\mu\text{m}$  (10  $\mu\text{inches}$ ). And for form measurement, our uncertainty goes as low as 5 nanometers (0.2  $\mu\text{inches}$ ).

Our experienced staff is ready for your challenges – we specialize in specialty gage calibration, complex prototype or master parts, specialty and custom-built 3D gages, and long length standards such as ball bars, step gages and gage blocks. We can also assist you in the validation of your measurement processes by providing accredited reference values on your parts.

Mitutoyo America calibration and inspection services are accredited to ISO/IEC 17025 by A2LA (Certificate 0750.01). We welcome customer tours of our laboratory.

If you have any questions or would like more information regarding Mitutoyo Calibration Services, contact: [mim@mitutoyo.com](mailto:mim@mitutoyo.com)





### Surftest

### Formtracer

### Contracer

### Roundtest

### INDEX

<b>Surftest</b>	
Surftest SJ-210	J-2
Surftest SJ-310	J-3
Surftest SJ-210/310 Optional Accessories	J-4,5
Surftest SJ-410	J-6,7
Surftest SJ-500/P, SV-2100	J-8,9
Surftest SV-3200	J-10,11
Surftest Extreme SV-3000CNC	J-12
Surftest Extreme SV-M3000CNC	J-13
<b>Formtracer</b>	
Formtracer SV-C3200 / SV-C4500	J-14,15
Formtracer Extreme SV-C4500CNC	J-16,17
Formtracer CS-3200	J-18,19
Formtracer Extreme CS-5000CNC / CS-H5000CNC	J-20,21
Optional Styli for Surface Roughness Measurement	J-22,23
Optional Accessories for Automatic Measurement	J-24
Optional Accessories for Surftest / Formtracer	J-25
Quick Guide to Precision Measuring Instruments—Surftest	J-26,27
<b>Contracer</b>	
Contracer CV-2100	J-28,29
Contracer CV-3200 / CV-4500	J-30,31
Optional Arms and Styli for Contour Measurement	J-32-34
Optional Accessories for Automatic Measurement	J-35
Optional Accessories for Contracer / Formtracer	J-36
Quick Guide to Precision Measuring Instruments—Contracer	J-37,38
<b>Roundtest</b>	
Roundtest RA-120 / 120P	J-39,40
Roundtest RA-1600 / RA-1600M	J-41,42
Roundtest RA-2200AS / DS / AH / DH	J-43,44
Roundtest RA-H5200AS / AH	J-45,46
Roundtest Extreme RA-2200CNC / RA-H5200CNC	J-47,48
Optional Styli for Roundtest	J-49,50
Optional Accessories for Roundtest	J-51
Eco-Fix Kit Form-S & L	J-52
Quick Guide to Precision Measuring Instruments—Roundtest	J-53,54

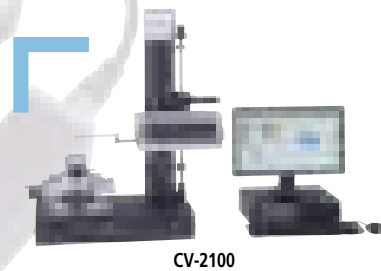
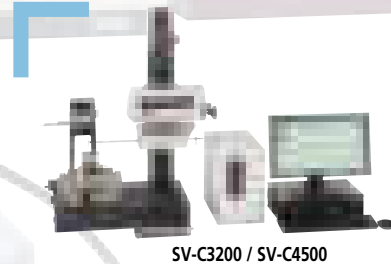

# Surftest SJ-210/SJ-310

## SERIES 178 — Portable Surface Roughness Tester



Surftest SJ-210

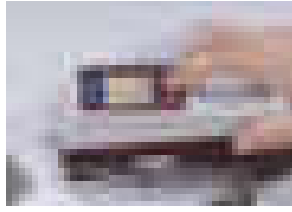

### FEATURES

- The 2.4-inch color graphic LCD provides excellent readability and an intuitive display that is easy to use. The LCD also includes a backlight for improved visibility in dark environments.
- The Surftest SJ-210 can be easily operated using the buttons on the front of the unit and under the sliding cover.
- Up to 10 measurement conditions and one measured profile can be stored in the internal memory.
- An optional memory card can be used as an extended memory to store large quantities of measured profiles and conditions.

- Access to each feature can be password-protected, which prevents unintended operations and allows you to protect your settings.
- The display interface supports 16 languages, which can be freely switched.
- An alarm warns you when the cumulative measurement distance exceeds a preset limit.
- The Surftest SJ-210 complies with the following standards: JIS (JIS-B0601-2001, JIS-B0601-1994, JIS B0601-1982), VDA, ISO-1997, and ANSI.
- In addition to calculation results, the Surftest SJ-210 can display sectional calculation results and assessed profiles, load curves, and amplitude distribution curves.

### SPECIFICATIONS/CONFIGURATION

Model No.	SJ-210					
Order No. (inch/mm)	178-561-01A	178-561-02A	178-563-01A	178-563-02A	178-565-01A	178-565-02A
Drive unit	Standard type (178-230-2)		Retractable type (178-235)		Transverse tracing type (178-233-2)	
Detector	0.75mN type (178-296)	4mN type (178-390)	0.75mN type (178-296)	4mN type (178-390)	0.75mN type (178-387)	4mN type (178-386)
Display unit	Compact type (178-253A)					
Detector: Tip angle	60°	90°	60°	90°	60°	90°
Stylus tip radius	2µm	5µm	2µm	5µm	2µm	5µm
Detector measuring force	0.75mN	4mN	0.75mN	4mN	0.75mN	4mN
Standard accessories	<b>12BAA303</b> Connecting cable <b>178-602</b> Roughness specimen (Ra 3.00µm) <b>12BAK699</b> Carrying case <b>12BAK700</b> Calibration stage <b>12BAK820</b> Protective sheets for display AC Adapter Operation manual Quick reference manual Warranty			<b>12BAA303</b> Connecting cable <b>178-606</b> Roughness specimen (Ra 1.00µm) <b>12AAE643</b> Point-contact adapter <b>12AAE644</b> V-type adapter <b>12BAK699</b> Carrying case <b>12BAK700</b> Calibration stage <b>12BAK820</b> Protective sheets for display AC Adapter, Operation manual Quick reference manual, Warranty		

### DIMENSIONS Display unit, Drive unit

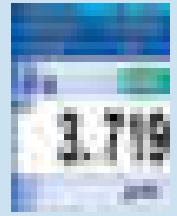
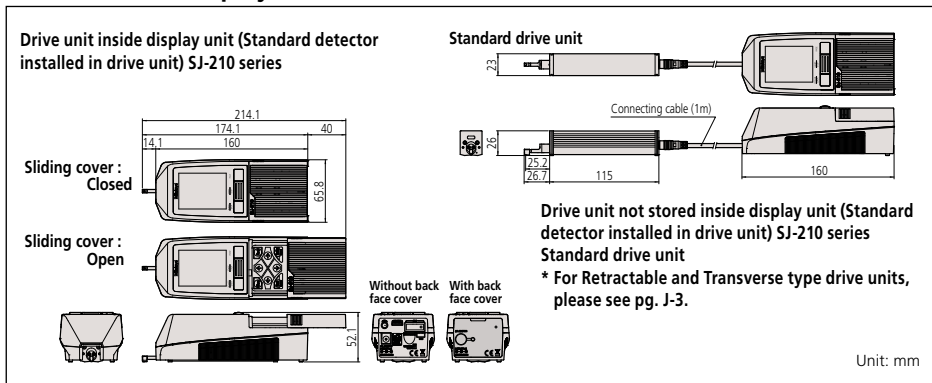

### Technical Data: SJ-210

X axis (drive unit)	Measuring range: .70" (17.5mm)
	.22" (5.6mm) Transverse type
Measuring speed:	.01, .02, .03"/s (0.25, 0.5, 0.75mm/s)
	.039"/s (1mm/s) (Returning)
Detector:	Range / Resolution: Auto / depending on the measurement range
	14400 µin / .8 in (360 µm / 0.02 µm)
	4000 µin / .2 µin (100 µm / 0.006 µm)
	1000 µin / .08 µin (25 µm / 0.002 µm)
Measuring method:	skidded
Measuring force:	4mN (0.75mN)
Stylus tip:	Diamond, 90° / 5µmR (60° / 2µmR)
Skid radius of curvature:	40mm
Skid force:	less than 400mN
Type:	Differential inductance
Power supply:	Two-way power supply: battery (rechargeable Ni-MH battery) and AC adapter
Charging time:	about 4 hours (may vary due to ambient temperature)
Endurance:	about 1000 measurements (differs slightly due to use conditions/environment)
External I/O:	USB I/F, Digimatic Output, Printer Output, RS-232C I/F, Foot SW I/F
Data storage:	Micro SD card w/ adapter (4GB) (option <b>12AAL069</b> )
Dimensions (WxDxH)	Display unit: 2.05x2.59x6.3" (52.1 x 65.8 x 160mm)
	Drive Unit: 4.5x.9x1" (115 x 23 x 26mm)
Mass:	About 1.1lb (0.5kg) (Display unit + Drive unit + Standard detector)

### Evaluation Capability: SJ-210

Applicable standards: JIS'82, JIS'94, JIS'01, ISO'97, ANSI, VDA

Assessed profiles: Primary profile, Roughness profile, DF profile, Roughness profile-Motif

Evaluation parameters: Ra, Rc, Ry, Rz, Rq, Rt, Rmax, Rp, Rv, R3z, Rsk, Rku, Rc, RPC, Rsm, Rz1max, S, HSC, RzJIS, Rppi, RΔa, RΔq, Rlr, Rmr, Rm(c), R&c, Rk, Rpk, Rvk, Mr1, Mr2, A1, A2, Vo, Rpm, tp, Htp, R, Rx, AR, Possible Customize

Analysis graphs: Bearing area curve / Amplitude distribution curve

Digital filters: Gaussian, 2CR75, PC75

Cut off length: λc: .003, .01, .03, .1" (0.08, 0.25, 0.8, 2.5mm)  
λs: .1, .3" (2.5, 8µm)

Sampling length: .003, .01, .03, .1" or arbitrary (0.08, 0.25, 0.8, 2.5mm) or arbitrary

Number of sampling lengths (x n): x1, x2, x3, x4, x5, x6, x7, x8, x9, x10 arbitrary length (0.3 to 16.0mm: 0.01mm interval)  
x1, x2, x3, x4, x5, x6, x7, x8, x9, x10 arbitrary length (0.3 to 5.6mm: 0.01mm interval)\*

\* Only for Transverse tracing drive unit type

### Function: SJ-210

Customization: Desired parameters can be selected for calculation and display.

Go/no-go judgment: By max value / 16% / Standard dev.

Storage of measurement condition: Save the conditions at power OFF

Storage: Internal memory: Measurement condition (10 sets), Measured profile (1set)

Memory card (Option): 500 measurement conditions, 10,000 measured profiles, 500 display images

Text file (Measurement conditions / Measured profile / Assessed profile / Bearing area curve / Amplitude distribution curve)

Calibration: Auto-calibration with the entry of numerical value / Average calibration with multiple measurement (Max.5 times) is available

## Technical Data: SJ-310

X axis (drive unit)	
Measuring range:	.70" (17.5mm) .22" (5.6mm) Transverse type
Measuring speed:	.01, .02, .03"/s (0.25, 0.5, 0.75mm/s) .039"/s (1mm/s) Returning
Detector:	
Range / Resolution:	Auto / depending on the measurement range 14400 µin / .8 in (360 µm / 0.02 µm) 4000 µin / .2 µin (100 µm / 0.006 µm) 1000 µin / .08 µin (25 µm / 0.002 µm)
Measuring method:	skidded
Measuring force:	4mN (0.75mN)
Stylus tip:	Diamond, 90° / 5µmR (60° / 2µmR)
Skid radius of curvature:	40mm
Skid force:	less than 400mN
Type:	Differential inductance
Power supply:	Two-way power supply: battery (rechargeable Ni-MH battery) and AC adapter
Battery	
Charging time:	4 hours maximum
Recharge cycles:	Approximately 1500 times (slightly varies with the usage and environmental conditions)
External I/O:	USB I/F, Digimatic Output, RS-232C I/F, External SW I/F
Data storage:	Micro SD card w/ adapter (4GB) (option <b>12AA4841</b> )
Dimensions (WxDxH)	
Control unit:	10.8x4.29x7.8" (275 x 109 x 198mm)
Drive unit:	4.5x.9x1" (115 x 23 x 26mm)
Mass	
Display unit:	Approx. 3.7lb (1.7kg)
Drive unit:	.4lb (0.2kg)

## Evaluation Capability: SJ-310

Applicable standards:	
JIS'82, JIS'94, JIS'01, ISO'97, ANSI, VDA	
Assessed profiles:	
P (primary profile), R (roughness profile), DIN4776, roughness motif, waviness motif	
Evaluation parameters:	
Ra, Ry, Rz, Rt, Rp, Rq, Rv, Rsk, Rku, Rc, RSm, S, RPs, R3z, Rm(c), Rpk, Rvk, Rdc, Rk, Mr1, Mr2, Lo, Rppi, R, AR, Rx, A1, A2, Vo, HSC, Rmr, SK, Ku, RΔa, RΔq, Rlr, λa, λq, Rpm, RzJIS (JIS'01), tp (ANSI), Htp (ANSI), Wte, Wx, W, AW, Rz1max (ISO), Rmax (VDA, ANSI, JIS'82), Possible Customize	
Analysis graphs:	
Bearing Area Curve (BAC), Amplitude Distribution Curve (ADC)	
Digital filter:	2CR, PC75, Gaussian
Cutoff length:	λc: .003, .01, .03, .1, .3" (0.08, 0.25, 0.8, 2.5, 8mm) λs: .1, .3" (2.5, 8µm)
Sampling length:	.003, .01, .03, .1, .3" or arbitrary (0.08, 0.25, 0.8, 2.5, 8mm) or arbitrary
Number of sampling lengths (x n):	
x1, x2, x3, x4, x5, x6, x7, x8, x9, x10 arbitrary length (0.3 to 16.0mm: 0.01mm interval)	
x1, x2, x3, x4, x5, x6, x7, x8, x9, x10 arbitrary length (0.3 to 5.6mm: 0.01mm interval)*	
* Only for Transverse tracing drive unit type	
Printer:	Thermal type
Printing width:	48mm (paper width: 58mm)
Recording magnification:	
Vertical magnification: 10X to 100,000X, Auto	
Horizontal magnification: 1X to 1,000X, Auto	

## Function: SJ-310

Customization: Desired parameters can be selected for calculation and display.	
Statistical processing: Maximum value, minimum value, mean value, standard deviation, pass rate, histogram of each parameter	
Go/no-go judgment: maximum value rule, 16% rule, average value rule, standard deviation (1σ, 2σ, 3σ)	
Storage: Internal memory: Measurement condition (10 sets)	
Memory card (Option): 500 measurement conditions, 10,000 measured profiles, 500 display images, Text file (Measurement conditions / Measured profile / Assessed profile / Bearing area curve / Amplitude distribution curve), 500 statistical data, etc.	
Calibration: Auto-calibration with the entry of numerical value / Average calibration with multiple measurement (Max.12 times) is available.	
Power-saving function: Auto-sleep-function, Auto light-off of Backlight by ECO mode.	

# Surftest SJ-210/SJ-310

## SERIES 178 — Portable Surface Roughness Tester



Surftest SJ-310

## FEATURES

- The data processing unit offers large 5.7-inch color graphic LCD touch-panel for superior readability and operability. The LCD also includes a backlight for improved visibility in dark environments.
- The excellent user interface provides intuitive and easy-to-understand operability.

- Complies with the following standards: JIS (JIS-B0601-2001, JIS-B0601-1994, JIS B0601-1982), VDA, ISO- 1997, and ANSI.
- The Measure-Start and other frequently used buttons are strengthened to resist wear and the detrimental effects of workshop contaminants.
- Equipped with a large-capacity battery allowing approximately 1500 measurements when fully charged.
- Includes convenient carrying case for protection in the field.
- A high-speed printer is built into the main unit. Either landscape or portfolio mode can be selected according to the application. Paper saving mode is supported.
- The display interface supports 16 languages, which can be easily switched.
- 10 sets of measurement conditions can be saved in the measurement unit—an optional memory card can save measurement conditions and the measured profile.

## SPECIFICATIONS/CONFIGURATION

Model No.	SJ-310					
Order No. (inch/mm)	178-571-01A	178-571-02A	178-573-01A	178-573-02A	178-575-01A	178-575-02A
Drive unit	Standard type (178-230-2)		Retractable type (178-235)		Transverse tracing type (178-233-2)	
Detector	0.75mN type (178-296)	4mN type (178-390)	0.75mN type (178-296)	4mN type (178-390)	0.75mN type (178-387)	4mN type (178-386)
Display unit	Standard type with printer					
Detector: Tip angle	60°	90°	60°	90°	60°	90°
Stylus tip radius	2µm	5µm	2µm	5µm	2µm	5µm
Detector measuring force	0.75mN	4mN	0.75mN	4mN	0.75mN	4mN
Standard accessories	<b>12AAM475</b> Connecting cable <b>12AA217</b> Nosepiece for plane surface <b>12AAA218</b> Nosepiece for cylinder <b>12AAA216</b> Supporting leg <b>12BAK700</b> Calibration stage <b>12BAG834</b> Stylus pen <b>12BAL402</b> Protection sheet <b>270732</b> Printer paper (5 pieces) <b>12BAL400</b> Carrying case <b>178-602</b> Roughness reference specimen (Ra 3µm), AC adapter, Philips screwdriver, Strap for stylus pen, Operation manual, Quick reference manual, Warranty				<b>12AAM475</b> Connecting cable <b>12AAE643</b> Point-contact adapter <b>12AAE644</b> V-type adapter <b>12BAK700</b> Calibration stage <b>12BAG834</b> Stylus pen <b>12BAL402</b> Protection sheet <b>270732</b> Printer paper (5 pieces) <b>12BAL400</b> Carrying case <b>178-606</b> Roughness reference specimen (Ra 1µm), AC adapter, Philips screwdriver, Strap for stylus pen, Operation manual, Quick reference manual, Warranty	

## DIMENSIONS Display unit, Drive unit

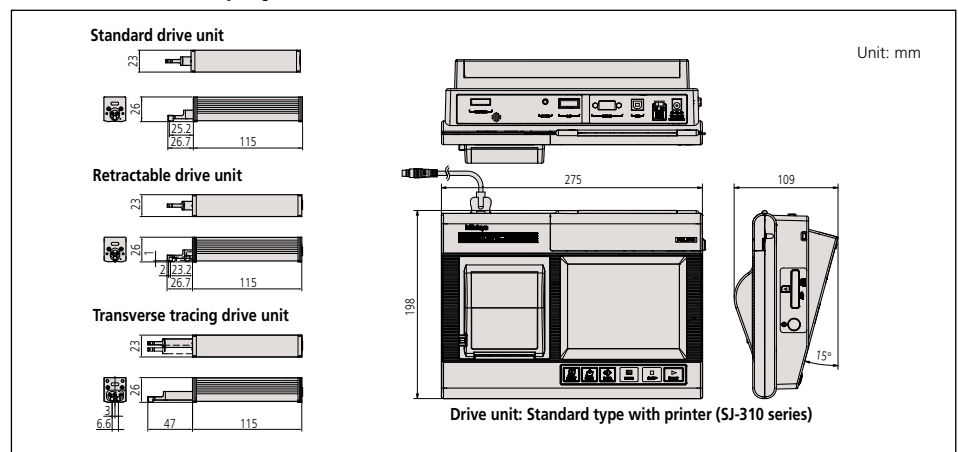

# Surftest SJ-210 / SJ-310

## SERIES 178 — Optional Accessories

### Detectors

#### Standard detectors

Order No.	Measuring force	Stylus profiles*	Remarks column
178-296	0.75mN	2µmR/60°	Dedicated to the standard/retractable drive unit
178-390	4 mN	5µmR/90°	
178-387	0.75mN	2µmR/60°	Dedicated to the transverse tracing drive unit
178-386	4 mN	5µmR/90°	
178-395	0.75mN	2µmR/90°	Dedicated to the standard/retractable drive unit
178-391	4 mN	10µmR/90°	

\* Tip radius / Tip angles

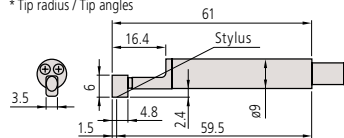

#### Small hole detectors

Order No.	Measuring force	Stylus profiles*	Remarks column
178-383	0.75mN	2µmR/60°	Minimum measurable hole diameter: ø4.5mm
178-392	4 mN	5µmR/90°	

\* Tip radius / Tip angles

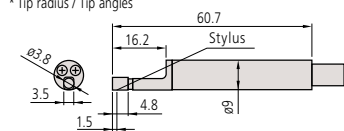

#### Extra small hole detectors

Order No.	Measuring force	Stylus profiles*	Remarks column
178-384	0.75mN	2µmR/60°	Minimum measurable hole diameter: ø2.8mm
178-393	4 mN	5µmR/90°	

\* Tip radius / Tip angles

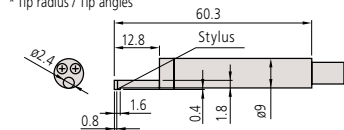

Unit: mm

#### Gear-tooth surface detectors

Order No.	Measuring force	Stylus profiles*
178-388	0.75mN	2µmR/60°
178-398	4 mN	5µmR/60°

\* Tip radius / Tip angles

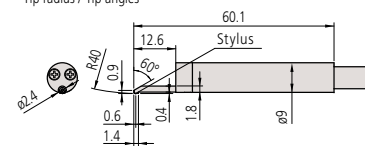

#### Deep groove detectors

Order No.	Measuring force	Stylus profiles*	Remarks column
178-385	0.75mN	2µmR/60°	Not available for the transverse tracing drive unit
178-394	4 mN	5µmR/90°	

\* Tip radius / Tip angles

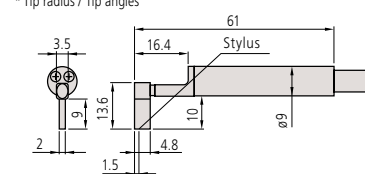

### SJ-Printer for SJ-210

Assessed profiles and calculation results and curves can be printed out by connecting the SJ-210-dedicated printer, which is palm sized (WxDxH: 93x125x70mm) and can run on an internal battery.

- Power supply can be selected. (AC adapter or battery pack)
- Printable items: Measurement conditions, calculation results, assessed profile, bearing area curve (BAC), amplitude distribution curve (ADC), and environment settings.



178-421A

\*Not compatible with older SJ-201 models.



Example of the connection with SJ-210

Durable Printer paper (25m, 5 rolls/set): **12AAA876**

Printer paper (5 packs): **270732**  
RS-232C cable: **12AAL067**

### DP-1VA

It is possible to process Digimatic data output from the Surftest SJ series with the DP-1VA. This compact, hand-held device can provide printouts of measurement data and various statistical analyses results such as histograms, D-charts, and Xbar-R control charts. With optional output cables, DP-1VA is also capable of RS-232C output of measurement data to a PC (cable **09EAA084**) and go/no-go condition output (cable **965516**).



264-505A

Connecting cable: **936937** 40'' (1m)  
Connecting cable: **965014** 80'' (2m)  
AC adapter: **06AEG180JA**  
Printer paper: **09EAA082**

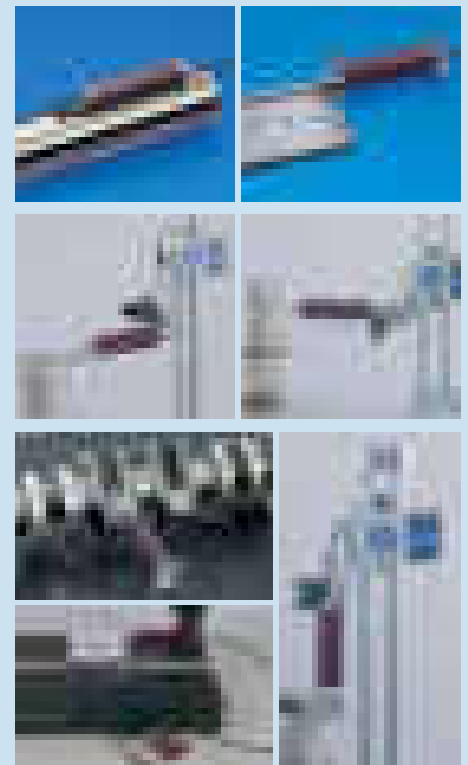

### Free Communication Software

#### SJ-Tools

This program can be downloaded for FREE from the Mitutoyo website. <http://www.mitutoyo.com>

Output software based on Microsoft-Excel\* for controlling the devices and reproducing and storing the measurement data.

\* Microsoft-Excel is not included in the scope of supply. Complete with exclusive accessories.

- Measurement device control
- Definition of measurement variables
- Graphic representation of the profile
- Storage of measurement records
- Documentation of measurement results
- Connecting cable

Optional cables (Required for software communication)

**12AAL068:** USB PC connecting cable(USB cable)for SJ-210

**12AAD510:** USB PC connecting cable(USB cable)for SJ-310/410

**12AAL067:** RS-232C cable for SJ-210

**12AAA882:** RS-232C cable for SJ-310/410

**12AAH490:** USB PC connecting cable for SJ-500/SV-2100

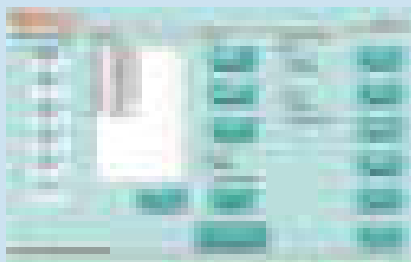

SJ-Tools input mask for SurfTest SJ series

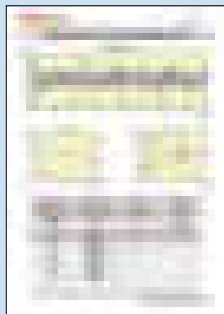

SJ-Tools output record from MS-Excel

Required environment\*:

- OS:  
Windows XP-SP3  
Windows Vista  
Windows 7/8/10
- Spreadsheet software:  
Microsoft Excel 2000/2002/  
2003/2007/2010/2013/2016

\* Windows OS and Microsoft Excel are products of Microsoft Corporation.

### Optional Accessories

**12AAL272:** SJ-210 Replacement Battery Pack

**12AAN046:** SJ-310 Replacement Battery Pack

**12BAK820:** SJ-210 Display Protection Sheet (1pc.)

**12AAL066:** SJ-210 Display Protection Sheet (5pcs.)

**12BAL402:** SJ-310 Display Protection Sheet (1pc.)

**12AAN040:** SJ-310 Display Protection Sheet (10pcs.)

**178-601:** Precision Reference Specimen (Ra 3.00 μm)

**178-602:** Precision Reference Specimen  
(Ra 119 μm / 3.00 μm)

**178-603:** Precision Reference Specimen – 2 values (GAR)

**178-604:** Precision Reference Specimen – 2 Values (MIT)

**178-606:** Precision Reference Specimen for Transverse Drive  
(Ra 39.5 μm / 1.0 μm)

**178-029:** Manual Column Stand, must use adapter  
12AAA221 to mount SJ drive unit.

### Nosepiece, Adapter

#### Nosepiece for flat surfaces

**12AAA217**

- SJ-210/210R optional accessory.
- SJ-310/310R standard accessory.
- Not available for the transverse tracing drive unit.

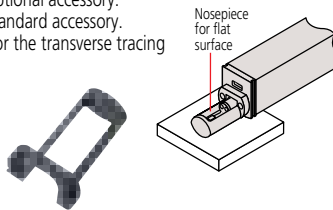

#### V-type adapter

**12AAE644**

- SJ-210/SJ-310 Transverse tracing type standard accessory.
- Dedicated to the transverse tracing drive unit.

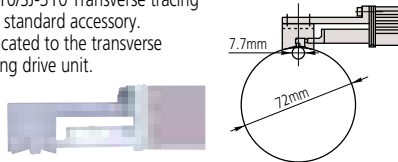

#### Extension rod (50mm)

**12AAA210**

- Not available for the transverse tracing drive unit.

(Note: Only one rod can be used.)

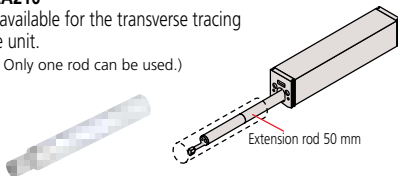

#### Magnetic stand adapter

**12AAA221 (ø8mm)**

**12AAA220 (ø9.5mm)**

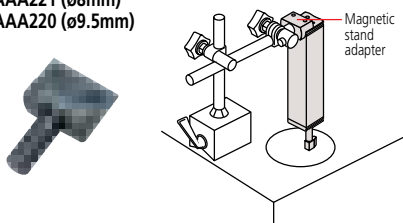

#### Extension cable (1m)

**12BAA303**

- Only one cable can be used.

### Setting attachments

\* Not available for the transverse tracing drive unit

Improves measurement efficiency by allowing the setup of workpieces of the same type and the positioning of hard-to-access features of a workpiece.

**No. 178-033**

V-type for measuring in the cylinder axis direction



The V-width is adjustable to the cylinder diameter facilitating axial measurement of a wide range of cylinder diameters.

- Adjustable range: ø 5 - 150mm

**No. 178-034**

Setting attachment: Magnetic slider type



Best suited for measurement of the flat surface of a workpiece that has partial indentations and steps and that is hard to set the drive unit. Combination use with the magnet type specimen holder (Option No. 12AAA910) further improves the ease of operation.

**No. 178-035**

Setting attachment: Inside diameter type

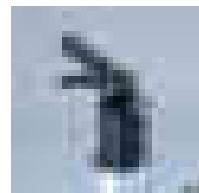

Greatly facilitates measurement of internal wall surfaces of, for example, cylinder-block bores.

- Applicable diameter: ø75 - ø95mm
- Accessible depth: 30 - 135mm

#### Nosepiece for cylindrical surfaces

**12AAA218**

- SJ-210/210R optional accessory.
- SJ-310/310R standard accessory.
- Not available for the transverse tracing drive unit.
- ø30mm or smaller workpiece

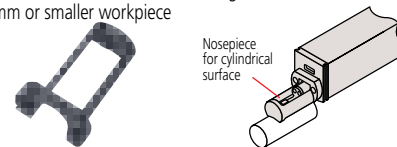

#### Point-contact adapter

**12AAE643**

- SJ-210/SJ-310 Transverse tracing type standard accessory.
- Dedicated to the transverse tracing drive unit.

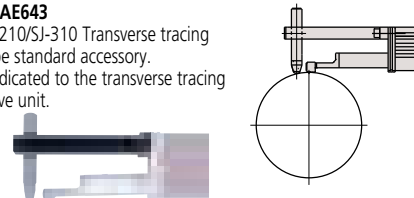

#### Support feet set

**12AAA216**

- SJ-210/210R optional accessory.
- SJ-310/310R standard accessory.
- Not available for the detector side of the transverse tracing drive unit.

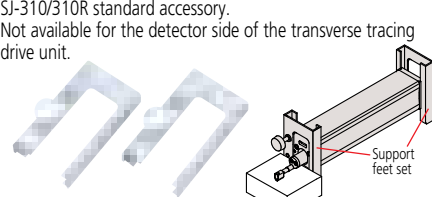

#### Vertical positioning adapter

**12AAA219**

- Not available for the transverse tracing drive unit.

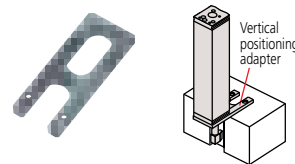

#### Height gage adapter

**12AAA222 (9mm x 9mm)**

**12AAA233 (1/4" x 1/2")**

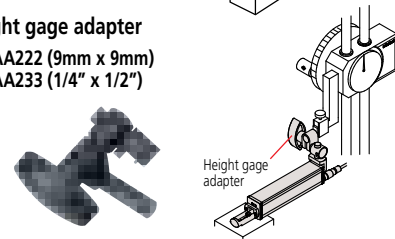

# Surftest SJ-410

## SERIES 178 — Portable Surface Roughness Tester

### FEATURES

- Both skidded and skidless measurement are possible with this series. Equipped with 46 roughness parameters that conform to the latest ISO, DIN, ANSI, and JIS standards.
- A wide-range, high-resolution detector and a drive unit provide superior high-accuracy measurement in its class.

#### Detector

Measuring range: 800µm  
Resolution: 0.000125µm (at 8µm range)

#### Drive unit

Straightness/traverse length  
SJ-411: 0.3µm/25mm  
SJ-412: 0.5µm/50mm

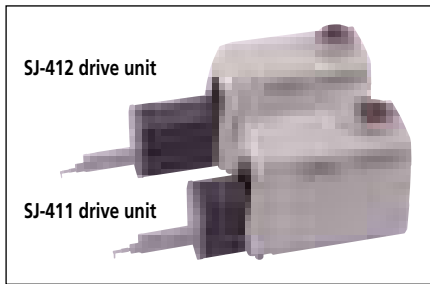

- A skidless detector and a curved surface compensation function provide efficient evaluation of cylinder surface roughness.

### Skidless measurement

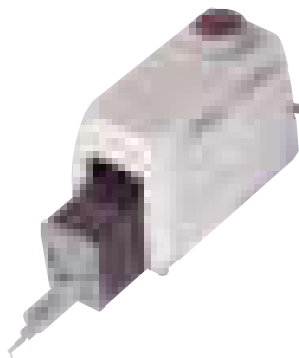
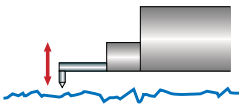

Surftest SJ-411

### SPECIFICATIONS

Model No.	SJ-411	SJ-411	SJ-412	SJ-412
<b>Order No. (inch/mm)</b>	<b>178-581-01A</b>	<b>178-581-02A</b>	<b>178-583-01A</b>	<b>178-583-02A</b>
Detector measuring force	0.75mN	4mN	0.75mN	4mN
Evaluation range	25mm	25mm	50mm	50mm
Stylus tip	Tip angle	60°	90°	60°
	Tip radius	2µm	5µm	2µm

- Ultra-fine steps, straightness and waviness can be measured by using the skidless measurement function.
- The handheld data processing unit and the 5.7-inch color graphic LCD touch-panel provides superior readability and operability. The LCD also includes a backlight for improved visibility in dark environments.
- The excellent user interface provides intuitive and easy-to-understand operability.
- Measured data can be output to a PC with optional RS-232C or USB cable.
- Digital filter function for non-distorted roughness profiles.
- Go/no-go judgment function.
- Auto-calibration function.
- The display interface supports 16 languages, which can be freely switched.
- Simplified contour analysis function supports the four types of measurement: step, level change, area and coordinate difference.
- Access to each feature can be password-protected, which prevents unintended operations and allows you to protect your settings.
- The optional attachments for mounting on a column stand significantly increase the operability.

### Technical Data: X axis (drive unit)

Measuring range:	1" (25mm) (SJ-411), 2" (50mm) (SJ-412)
Measuring speed:	.002, .004, .008, .02, .04"/s (0.05, 0.1, 0.5, 1.0mm/s)
Return speed:	.02, .04, .08"/s (0.5, 1.0, 2.0mm/s)
Traversing direction:	Backward
Traverse linearity:	12 µin / 1" (0.3µm/25mm) (SJ-411), 20 µin / 2" (0.5µm/50mm) (SJ-412)
Positioning:	±1.5° (tilting), 10mm (up/down)
Detector Range / resolution:	800µm / 0.0125µm, 80µm / 0.00125µm, 8µm / 0.000125µm (up to 2400µm with an optional stylus)
Measurement method:	Skidless / skidded
Measuring force:	0.75mN (4mN)
Stylus tip:	Diamond, 60° / 2µmR (90° / 5µmR)
Skid radius of curvature:	40mm
Type:	Differential inductance
Power supply:	Via AC adapter / rechargeable battery
Battery life:	Max. app. 1000 measurements (w/o printing)
Recharge time:	4 hours Data output Via USB interface / RS-232C interface / SPC output
Storage: Internal memory:	Measurement condition (10 sets)
Memory card (Option):	500 measurement conditions, 10,000 measured profiles, 500 display images, Text file (Measurement conditions / Measured profile / Assessed profile / Bearing area curve / Amplitude distribution curve), 500 statistical data, etc.
Dimensions (WxDxH)	
Display unit:	10.8x4.3x7.8" (275x109 x198mm)
Height-tilt adjustment unit:	5.16x2.48x3.9" (131x63x99mm)
Drive unit:	5.04x1.41x1.83" (128x36x47mm) (SJ-411), 6.1x1.41x1.83" (155x36x47mm) (SJ-412)
Mass Control unit:	Approx. 3.75lb (1.7kg)
Height-tilt adjustment unit:	Approx. .9lb (0.4kg)
Drive unit:	1.3lb (0.6kg) (SJ-411), 1.5lb (0.7kg) (SJ-412)

### Evaluation Capability

Applicable standards:	JIS'82, JIS'94, JIS'01, ISO'97, ANSI, VDA, Free
Assessed profiles:	P (primary profile), R (roughness profile), DF (DF profile), W (filtered waviness profile), roughness motif, waviness motif
Evaluation parameters:	Ra, Rq, Rz, Ry, Rp, Rv, Rt, R3z, Rsk, Rku, Rc, Rpc, RSm, Rmax(VDA, ANSI), Rz1max(ISO'97), S, HSC, Rz1S(JIS'01), Rppi, RΔa, RΔq, Rlr, Rmr, Rmr(c), Rδc, Rk, Rpk, Rvk, Mr1, Mr2, A1, A2, Vo, λq, Lo, Rpm, tp(ANSI), Htp(ANSI), R, Rx, AR, W, AW, Wx, Wte
Analysis graphs:	Bearing Area Curve (BAC), Amplitude Distribution Curve (ADC)
Digital filter:	2CR, PC75, Gaussian
Cutoff length:	λc: .003, .01, .03, .1, .3" (0.08, 0.25, 0.8, 2.5, 8mm) λs: 100, 320, 1000µin (2.5, 8, 25µm) (Availability of switching depends of the selected standard.)
Sampling length:	0.08, 0.25, 0.8, 2.5, 8, 25*mm; or arbitrary length in range 0.1 to 25mm (0.1 to 50mm: SJ-412) in 0.01mm increments
Number of sampling lengths:	1, 2, 3, ~20 (limited by traverse range)
Printer:	Thermal type
Printing width:	48mm (paper width: 58mm)
Recording magnification	
Vertical magnification:	10X to 100,000X, Auto
Horizontal magnification:	1X to 1,000X, Auto
Function	
Customize:	Selection of display/evaluation parameter
Data compensation:	R-surface, Tilt compensation
Ruler function:	Step, level change, area and coordinate difference
D.A.T. function:	Helps to level workpiece prior to skidless measurement displacement detection mode enables the stylus displacement to be input while the drive unit is stopped.
Statistical processing:	Max. value, Min. value, Mean value, Standard deviation (s), Pass ratio, Histogram
GO/NG judgement:	Maximum value rule, 16% rule, average value rule, standard deviation (1σ, 2σ, 3σ)
Calibration:	Auto-calibration with the entry of numerical value /average calibration with multiple measurement (Max.12 times) is available.
Power saving function:	Auto-sleep-function, Auto light-off of Backlight by ECO mode.

\* Only for SJ-412



# Surftest SJ-410

## SERIES 178 — Portable Surface Roughness Tester

### DIMENSIONS

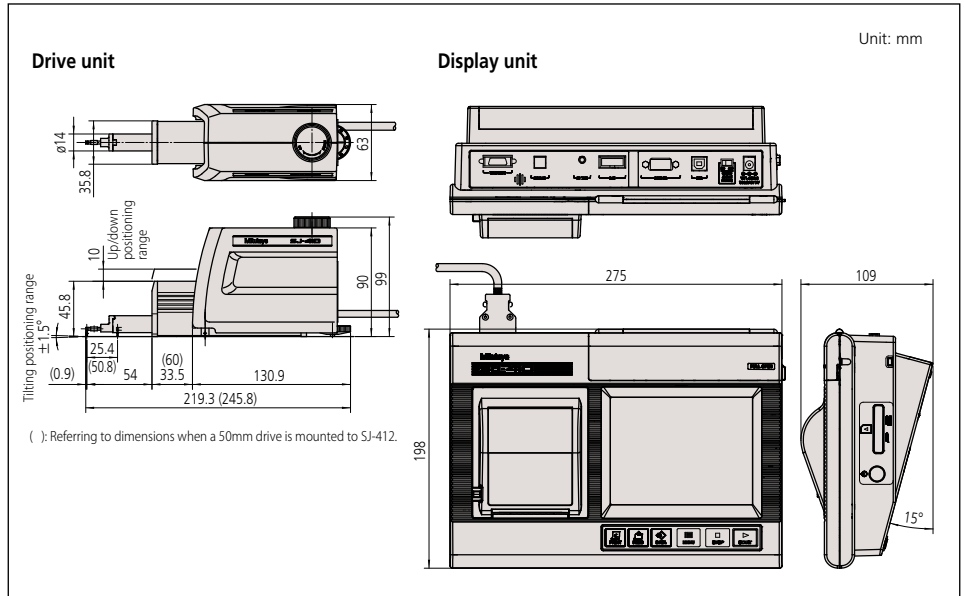

### Free Communication Software SJ-Tools

This program can be downloaded for FREE from the Mitutoyo website. <http://www.mitutoyo.com>

Output software based on Microsoft-Excel\* for controlling the devices and reproducing and storing the measurement data.

\*Microsoft-Excel is not included in the scope of supply.

Complete with exclusive accessories.

- Measurement device control
- Definition of measurement variables
- Graphic representation of the profile
- Storage of measurement results
- Documentation of measurement results

Optional cables (Required for software communication)

**12AAD510:** USB PC connecting cable (USB cable)

**12AAA882:** RS-232C connecting cable

### Optional Accessories

- 178-611:** Step gage (2 $\mu$ m, 10 $\mu$ m)  
**178-612:** Step gage (2 $\mu$ m, 10 $\mu$ m, 79 $\mu$ m, 394 $\mu$ m)  
**178-610:** Step gage (step: 1 $\mu$ m, 2 $\mu$ m, 5 $\mu$ m, 10 $\mu$ m)  
**12AAM556:** Height/tilt adjustment unit for SJ-410  
**178-039:** Manual column stand (granite base) (vertical travel: 250mm)  
**178-010:** Auto-set unit for **178-039**  
**178-020:** X axis adjustment unit for **178-039**  
**178-030:** Tilting adjustment unit (Inclination adjustment unit) for **178-039**  
**12AAB358:** Cylindrical surface adapter (workpiece dia.: 15 - 60mm)  
**178-016:** Leveling table (tilting:  $\pm 1.5^\circ$ , max. loading: 15kg)  
**178-048:** Leveling table with D.A.T function (mm) (tilting:  $\pm 1.5^\circ$ , max. loading: 15kg)  
**178-058:** Leveling table with D.A.T function (inch) (tilting:  $\pm 1.5^\circ$ , max. loading: 15kg)  
**178-043-1:** XY leveling table (25 x 25mm) (tilting:  $\pm 1.5^\circ$ , max. loading: 15kg, swiveling:  $\pm 3^\circ$ )  
**178-053-1:** XY leveling table (1" x 1") (tilting:  $\pm 1.5^\circ$ , max. loading: 15kg, swiveling:  $\pm 3^\circ$ )  
**178-042-1:** Digital XY leveling table (25 x 25mm) (tilting:  $\pm 1.5^\circ$ , max. loading: 15kg, swiveling:  $\pm 3^\circ$ )  
**178-052-1:** Digital XY leveling table (1" x 1") (tilting:  $\pm 1.5^\circ$ , max. loading: 15kg, swiveling:  $\pm 3^\circ$ )  
**178-049:** Digital XY leveling table (25 x 25mm) (max. loading: 15kg)  
**178-059:** Digimatic XY leveling table (1" x 1") (max. loading: 15kg)  
**178-019:** Precision vise for XY leveling table (jaw opening: 36mm)  
**998291:** Precision V-block for XY leveling table (workpiece dia.: 1 - 160mm)  
**12AAL069:** Micro SD card w/adaptor (4GB)  
**965014:** SPC cable (2m)  
**264-012-10:** Input tool (USB type)  
**264-505A:** DP-1VA  
 —: Detectors, Styli, and nosepieces (See pg. J-22/23.)

### Consumables

- 12AAN040:** LCD protective sheet (10 sheets/set)  
**12AAA876:** Durable printer paper (25m, 5 rolls/set)  
**270732:** Printer paper (5 pack)  
**12AAN046:** Replacement battery  
**12AAJ088:** Footswitch

### MEASUREMENT APPLICATIONS

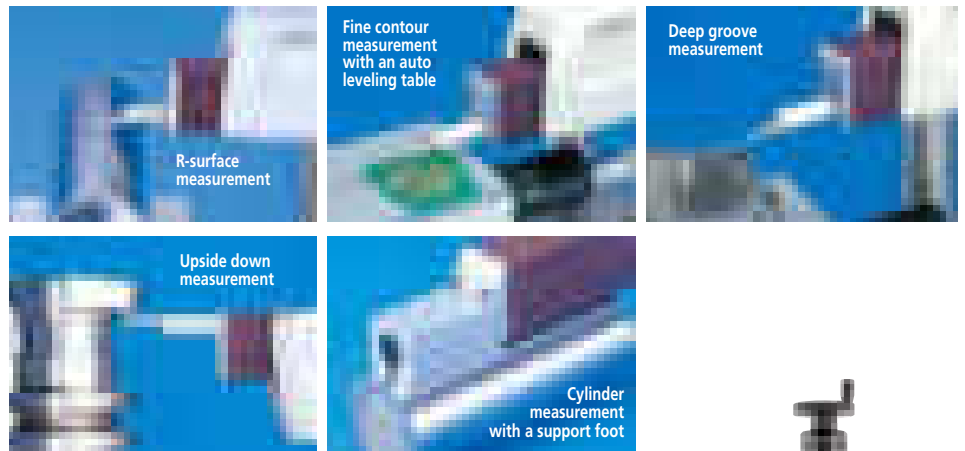

Carrying case is a standard accessory.

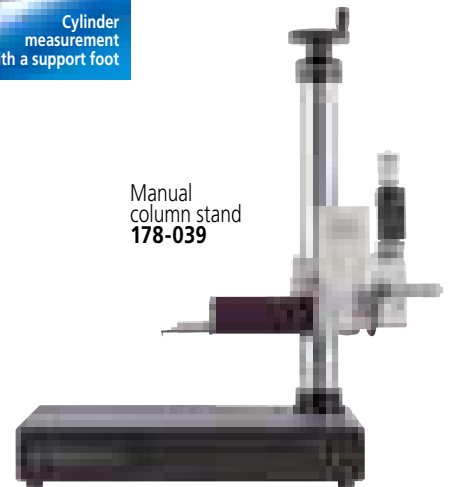

Manual column stand  
**178-039**

With optional accessories.

- 178-010:** Auto-set unit  
**178-020:** X-axis adjustment unit  
**178-030:** Tilting adjustment unit

# Surftest SJ-500/P, SV-2100

**SERIES 178 — with Dedicated Control / PC System / Display Unit**

High-precision and high-performance surface roughness tester with a dedicated control unit, achieving user-friendly display and simple operation.

## FEATURES

- User-friendly display and simple operation equipped with a highly visible color 7.5-inch TFT LCD.
- Easy positioning. A joy stick built in the dedicated control unit allows easy and quick positioning. Fine positioning of a small stylus, required for measuring the inner side of a small hole, easily can be made using the manual knob.

- Easy setting of measuring conditions for surface roughness. Equipped with simple input function allows inputs according to drawing instruction symbols of ISO/JIS roughness standards. Troublesome measuring condition settings can be easily input by directly selecting a drawing instruction symbol for surface roughness from the menu.



SJ-500



SV-2100S4



SJ-500P

## SURFPAK-EZ: Easy-to-use task-focused software

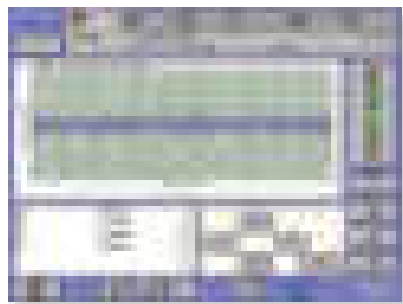

Measurement and results display screen

User-friendly graphical display and button layout allows intuitive operation. Simplified fine-contour analysis provided as standard, including step, area, angle, and circle calculation.

## Technical Data: SJ-500

X-axis (drive unit)	
Measuring range:	1.97" (50mm)
Resolution:	1.97µin (0.05µm)
Measurement method:	Linear encoder
Drive speed:	0 - .78"/s (0 - 20mm/s)
Measuring speed:	.00078 - .2"/s (0.02 - 5mm/s)
Traversing direction:	Backward
Traverse linearity:	7.8µin/1.97" (0.2µm / 50mm)
Positioning:	±1.5° (tilting, with DAT function)
	1.18" (30mm) (up/down)
Detector	
Resolution / Range:	.4µin/32000µin, .04µin/3200µin, .004µin/320µin, 0.01µm (800µm), 0.001µm (80µm), 0.0001µm (8µm)
Detecting method:	Skidless / skid measurement
Measuring force:	4mN (0.75mN) (low force type)
Stylus tip:	Diamond, 90° / 5µmR (60° / 2µmR: low force type)
Skid radius of curvature:	1.57" (40mm)
Detecting method:	Differential inductance
Control unit	
Display:	7.5" color TFT with backlight
Printer:	Built-in thermal printer
Magnification:	Horizontal: X10 to X500,000, Auto Vertical: X0.5 to X10,000, Auto
Drive unit control:	Joystick operation with manual knob

## Technical Data: SV-2100

X-axis (drive unit)	
Measuring range:	3.94" (100mm)
Resolution:	1.97µin (0.05µm)
Measurement method:	Linear encoder
Drive speed:	0 - 1.57"/s (0 - 40mm/s)
Measuring speed:	.00078 - .197"/s (0.02 - 5mm/s)
Traversing direction:	Pull
Traverse linearity:	6µin/4" (0.15µm / 100mm)
Z2-axis (column)	
Type:	Manual operation or power drive
Vertical travel:	13.8" or 21.6" (350mm or 550mm*)
Resolution*:	1µm
Measurement method*:	Rotary encoder
Drive speed*:	0 - .78"/s (0 - 20mm/s)
*Only for power-drive type	
Detector	
Resolution / Range :	.4µin/32000µin, .04µin/3200µin, .004µin/320µin, 0.01µm / 800µm, 0.001µm / 80µm, 0.0001µm / 8µm
Detecting method:	Skidless / skid measurement
Measuring force:	4mN or 0.75mN (low force type)
Stylus tip:	Diamond, 90° / 5µmR (60° / 2µmR: low force type)
Skid radius of curvature:	1.57" (40mm)
Detecting method:	Differential inductance
Control unit	
Display:	7.5" color TFT with backlight
Printer:	Built-in thermal printer
Magnification:	Horizontal: X10 to X500,000, Auto Vertical: X0.5 to X10,000, Auto
Drive unit control:	Joystick operation with manual knob

## Evaluation Capability

Cutoff length	
Is:	0.25µm, 0.8µm, 2.5µm, 8µm, 25µm, 250µm, no filter
Ic*:	0.025mm, 0.08mm, 0.25mm, 0.8mm, 2.5mm, 8mm, 25mm
If:	0.08mm, 0.25mm, 0.8mm, 2.5mm, 8mm, 25mm, no filter
Sampling length (L)*	
	0.025mm, 0.08mm, 0.25mm, 0.8mm, 2.5mm, 8mm, 25mm, 80mm (SV-2100 only)
Data compensation functions	
	Parabola compensation, hyperbola compensation, ellipse compensation, R-plane (curved surface) compensation, conic compensation, tilt compensation

\*Arbitrary length can be specified in the range from 0.02mm to 50mm.

**12AAA876:** High durable printer paper (5 Rolls/set)

**270732:** Standard type printer paper (5pcs.)

**12AAA841:** Compact Flash memory card (128 MB)

# Surftest SJ-500/P, SV-2100

SERIES 178 — with Dedicated Control / PC System / Display Unit

## SPECIFICATIONS

Model no.	SJ-500P	SJ-500	SV-2100M4	SV-2100S4	SV-2100H4	SV-2100W4
Type of Data processing	PC System	Dedicated Data Processor	Dedicated Data Processor			
Order No. (inch)	178-531-02A	178-533-02A	178-637-01A	178-681-01A	178-683-01A	178-685-01A
Measuring force of detector	4mN	4mN	0.75mN			
X-axis measuring range	2" (50mm)		4" (100mm)			
Vertical travel	Optional stand		13.8" (350mm) manual column	13.8" (350mm) power column	21.6" (550mm) power column	
Granite base size (WxD)	Optional stand		23.6 x 17.7" (600 x 450mm)			39.4 x 17.7" (1000 x 450mm)
PC I/F Unit	13.7 x 10.4 x 3.4" (350 x 263 x 86mm)	NA	NA	NA	NA	NA
Dimensions (main unit, WxDxH)	16.7 x 3.7 x 6.3" (425 x 94 x 160mm)		28.2 x 17.7 x 34" (716 x 450 x 863mm)	28.2 x 17.7 x 38" (716 x 450 x 966mm)	28.2 x 17.7 x 46" (716 x 450 x 1166mm)	44 x 17.7 x 46.3" (1116 x 450 x 1176mm)
Main unit Mass	5.9 lbs. (2.7 kg)		308.6 lbs. (140 kg)	308.6 lbs. (140 kg)	330 lbs. (150 kg)	485 lbs (220 kg)
Assessed profiles	Dedicated data processor type: P (primary profile), R (roughness profile), WC, envelope residual profile, roughness motif, waviness motif PC system type: P (primary profile), R (roughness profile), WC, WCA, WE, WEA, DIN4776 profile, E (envelope residual profile), roughness motif, waviness motif					
Evaluation parameters	Dedicated data processor type: Ra, Rc, Ry, Rz, Rq, Rt, Rmax, Rp, Rv, R3z, Sm, S, Pc, mr (c), δc, mr, tp, Htp, Lo, lr, Ppi, HSC, Δa, Δq, Ku, Sk, Rpk, Rvk, Rk, Mr1, Mr2, A1, A2, Vo, λa, λq, R, AR, Rx, W, AW, Wx, Wte, (43 parameters), Customization PC system type: Pa, Pq, Psk, Pku, Pp, Pv, Pz, Pt, Pc, PSm, PΔq, Pmr (c), Pmr, Pδc, Ra, Rq, Rsk, Rku, Rp, Rv, Rz, Rt, Rc, RSm, RΔq, Rmr (c), Rmr, Rδc, Wa, Wq, Wsk, Wku, Wp, Wv, Wz, Wt, Wc, WSm, WΔq, Wmr (c), Wmr, Wδc, Rk, Rpk, Rvk, Mr1, Mr2, A1, A2, Rx, AR, R, Wx, AW, W, Wte, Ry, RyDIN, RzDIN, R3y, R3z, S, HSC, Lo, lr, Δa, λa, λq, Vo, Htp, NR, NCRX, CPM, SR, SAR, NW, SW, SAW					
Analysis graphs	Dedicated data processor type: ADC, BAC, power spectrum graph PC system type: ADC, BAC Graph, power spectrum graph, auto-correlation graph, Walsh power spectrum graph, Walsh auto-correlation graph, slope distribution graph, local peak distribution graph, parameter distribution graph					
Curved surface compensation	Dedicated data processor type: Parabolic compensation, Hyperbolic compensation, Elliptical compensation, Circular compensation Conic compensation, Inclination (Entire, Arbitrary) PC system type: Parabolic compensation, Hyperbolic compensation, Elliptical compensation, Circular compensation, Conic compensation, Inclination (Entire, Arbitrary), Polynomial compensation					
Contour analysis	Dedicated data processor type: Area, Circle, Angle, Coordinate difference, Step, Inclination PC system type (SURFPAK-EZ): Area, Circle, Angle, Coordinate difference, Step, Inclination					
Filters	Dedicated data processor type: 2CR-75%, 2CRPC-75%, Gaussian, Robust-spline PC system type: 2CR-75%, 2CR-50%, 2CRPC-75%, 2CRPC-50%, Gaussian, Robust-spline					

### Manual column stand options: 178-085 and 178-089 (for SJ-500)

Suitable for desktop use in inspection rooms and such.

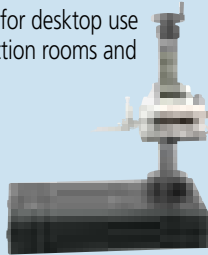

**No.178-085\*** Does not include measuring unit  
Vertical adjustment range: 11.8" (300mm)  
Dimension (W x D x H): 23.6" x 17.7" x 28" (600 x 450 x 710mm)  
Weight: 242 lbs (110kg)  
**No.178-089\*** Does not include measuring unit  
Vertical adjustment range: 9.8" (250mm)  
Dimension (W x D x H): 15.7 x 9.8 x 2.4" (400 x 250 x 60mm)  
Weight: 44 lbs (20kg)

Dimensions of SJ-500 w/ manual column stand 178-085

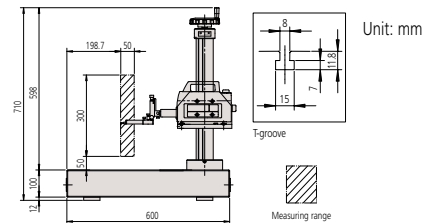

### Auto-leveling table: 178-081 (for SJ-500 / SV-2100M4), 178-083 (for SV-2100S4 / H4 / W4)

This is a stage that performs fully automatic leveling as measurement starts, freeing the user from this tedious operation. Fully automatic leveling can be done quickly by anyone. In addition, the operation is easy and reliable.



Inclination adjustment angle	±2°
Maximum load	15.4 lbs (7kg)
Table dimensions	5.12 x 3.94" (130x100mm)
Mass	7.7lbs (3.5kg)

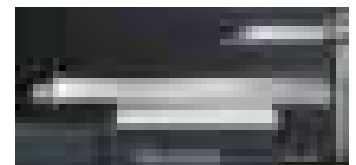

# Surftest SV-3200

## SERIES 178 — Surface Roughness Testers



SV-3200L4 (with options)

**MiCAT**  
Mitutoyo Intelligent Computer Aided Technology  
the standard in world  
metrology software  
**FORM**



\*Shown with optional accessories.

SV-3200H4 with PC

The Surftest SV-3200 Series provide high-accuracy, high-level analysis and multi-functionality in measurement of surface roughness.

### FEATURES

- Mitutoyo's Surftest SV-3200 Series provides high-accuracy, high-level analysis and multi-functionality in three-dimensional analysis and measurement of fine contour, as well as the conventional type surface roughness measurement.
- Peripheral devices such as the auto-leveling table are available to enhance operability and to enable automatic measurement.
- FORMTRACEPAK V5, dedicated data-analyzing software, is installed. This software allows data management in a consistent format, from the work site to the laboratory.
- Ceramic, which is known for its superb anti-abrasive property, is used as the X-axis drive unit guide. No lubrication of the guide is required.
- High-accuracy glass scales are built-in on X-axis (resolution: 1.97 $\mu$ m (0.05 $\mu$ m) and Z2-axis (column, resolution: 39.4 $\mu$ m (1 $\mu$ m) to ensure high-accuracy positioning.

The SV-3200 series manifest high-reliability especially in the horizontal roughness parameters (S, Sm), that require high-accuracy of the X-axis travel.

- When equipped with high accuracy Y-axis table and 3D surface analysis software MCubeMap, this offers CNC type capabilities usually performed on Extreme series machines.
- Various optional detector holders such as Crank Rotary type and Manual Rotary type make this versatile for many different applications.
- New optional Digital Automatic Tilt (DAT) function is best suited for workpieces that are too large for leveling tables.

### Technical Data

#### X-axis

Measuring range: 4" or 8" (100mm or 200mm)  
Resolution: 1.97 $\mu$ m (0.05 $\mu$ m)  
Measurement method: Linear encoder  
Drive speed: 0 - 3.1"/s (0 - 80mm/s)  
Measuring speed: .00078 - .78"/s (0.2 - 20mm/s)\*\*  
Traversing direction: Backward  
Traverse linearity: 4": (2+L) $\mu$ m (0.05+0.001L) $\mu$ m\*  
8": 20 $\mu$ m / 8" (0.5 $\mu$ m/200mm)

#### Z2-axis (column)

Vertical travel: 12", 20" or 27.6"  
(300mm, 500mm or 700mm) power drive  
Resolution: 39.4 $\mu$ m (1 $\mu$ m)  
Measurement method: ABSOLUTE linear encoder  
Drive speed: 0 - 1.2"/s (0 - 30mm/s)

#### Detector

Range / resolution: 32000  $\mu$ m / .4  $\mu$ m, 3200 $\mu$ m / .04 $\mu$ m,  
320  $\mu$ m / .004 $\mu$ m  
(up to 96000  $\mu$ m with an optional stylus)  
{800 $\mu$ m / 0.01 $\mu$ m, 80 $\mu$ m / 0.001 $\mu$ m, 8 $\mu$ m / 0.0001 $\mu$ m)  
(up to 2400 $\mu$ m with an optional stylus)}

Detecting method: Skidless / skid measurement  
Measuring force: 0.75mN (low force type)  
Stylus tip: Diamond, 60°/2 $\mu$ mR (low-force type)  
Skid radius of curvature: 1.57" (40mm)

Detecting method: Differential inductance  
Base size (W x H): 23.6 x 17.7" (600 x 450mm) or  
39.4 x 17.7" (1000 x 450mm)

Base material: Granite

\*L = Measured length inch (mm)

\*\*Recommended speed: under 5mm/s

If using higher speed, stylus tip may be chipped and/or accuracy may be worse, depending on surface condition.

### Evaluation Capability: FORMTRACEPAK V5

#### Assessed profiles

P (primary profile), R (roughness profile), WC, WCA, WE, WEA, DIN4776 profile, envelope residual profile, roughness motif, waviness motif

#### Evaluation parameters

Ra, Rq, Rz, Ry, Rz(JIS), Ry(DIN), Rc, Rp, Rpmax, Rpi, Rv, Rvmax, Rvi, Rt, Rti, R3z, R3zi, R3y, S, Pc (Ppi), Sm, HSC, mr,  $\delta$ c, plateau ratio, mrd, Rk, Rpk, Rvk, Mr1, Mr2,  $\Delta$ a,  $\Delta$ q,  $\lambda$ a,  $\lambda$ q, Sk, Ku, Lo, Lr, A1, A2

Roughness motif parameters: Rx, R, AR, SR, SAR, NR, NCRX, CPM

Waviness motif parameters: Wte, Wx, W, AW SW, SAW, NW

#### Analysis graphs

ADC, BAC1, BAC2, power spectrum chart, auto-correlation chart, Walsh power spectrum chart, Walsh auto-correlation chart, slope distribution chart, local peak distribution chart, parameter distribution chart

Digital filter 2CR-75%, 2CR-50%, 2CR-75% (phase corrected), 2CR-50% (phase corrected), Gaussian-50%

#### Cutoff length\*

$\lambda$ c: .001, .003, .01, .03, .1, .3, 1"  
(0.025mm, 0.08mm, 0.25mm, 0.8mm, 2.5mm, 8mm, 25mm)

fl: .001, .003, .01, .03, .1, .3, 1"  
(0.08mm, 0.25mm, 0.8mm, 2.5mm, 8mm, 25mm)

fh: .001, .003, .01, .03, .1, .3, 1"  
(0.08mm, 0.25mm, 0.8mm, 2.5mm, 8mm)

Sampling length (L)\*.001, .003, .01, .03, .1, .3, 1"  
(0.025mm, 0.08mm, 0.25mm, 0.8mm, 2.5mm, 8mm, 25mm)

#### Data compensation functions

Tilt compensation, R-plane (curved surface) compensation, ellipse compensation, parabola compensation, hyperbola compensation, quadric curve automatic compensation, polynomial compensation, polynomial automatic compensation

\*Arbitrary length can be specified in the range from .001" (0.025mm) to the maximum traverse length.

# Surftest SV-3200

## SERIES 178 — Surface Roughness Testers

### SPECIFICATIONS

 Models without X-axis inclination function

Model No.	SV-3200S4	SV-3200H4	SV-3200W4	SV-3200L4
Order No. (inch)	<b>178-424-11A</b>	<b>178-425-11A</b>	<b>178-426-11A</b>	<b>178-464-11A</b>
Order No. (mm)	<b>178-444-11A</b>	<b>178-445-11A</b>	<b>178-446-11A</b>	<b>178-484-11A</b>
Measuring force of detector	0.75mN	0.75mN	0.75mN	0.75mN
X-axis measuring range	4" (100mm)	4" (100mm)	4" (100mm)	4" (100mm)
Vertical travel	12" (300mm) power column	20" (500mm) power column	20" (500mm) power column	27.6" (700mm) power column
Granite base size (WxD)	23.6 x 17.7" (600 x 450mm)	23.6 x 17.7" (600 x 450mm)	39.4 x 17.7" (1000 x 450mm)	39.4 x 17.7" (1000 x 450mm)
Dimensions (main unit, WxDxH)	29.8 x 19.0 x 38.0" (756 x 482 x 966mm)	29.8 x 19.0 x 45.9" (756 x 482 x 1166mm)	45.5 x 19.0 x 46.3" (1156 x 482 x 1176mm)	45.5 x 19.0 x 56.5" (1156 x 482 x 1436mm)
Mass (main unit)	308 lbs (140kg)	330 lbs (150kg)	485 lbs (220kg)	595 lbs (270kg)

Model No.	SV-3200S8	SV-3200H8	SV-3200W8	SV-3200L8
Order No. (inch)	<b>178-427-11A</b>	<b>178-428-11A</b>	<b>178-429-11A</b>	<b>178-465-11A</b>
Order No. (mm)	<b>178-447-11A</b>	<b>178-448-11A</b>	<b>178-449-11A</b>	<b>178-485-11A</b>
Measuring force of detector	0.75mN	0.75mN	0.75mN	0.75mN
X-axis measuring range	8" (200mm)	8" (200mm)	8" (200mm)	8" (200mm)
Vertical travel	12" (300mm) power column	20" (500mm) power column	20" (500mm) power column	27.6" (700mm) power column
Granite base size (WxD)	23.6 x 17.7" (600 x 450mm)	23.6 x 17.7" (600 x 450mm)	39.4 x 17.7" (1000 x 450mm)	39.4 x 17.7" (1000 x 450mm)
Dimensions (main unit, WxDxH)	30.2 x 19.0 x 38.0" (766 x 482 x 966mm)	30.2 x 19.0 x 45.9" (766 x 482 x 1166mm)	45.9 x 19.0 x 46.3" (1166 x 482 x 1176mm)	45.5 x 19.0 x 56.5" (1156 x 482 x 1436mm)
Mass (main unit)	308 lbs (140kg)	330 lbs (150kg)	485 lbs (220kg)	595 lbs (270kg)

### Optional Accessories

- 178-602-1:** Reference Specimen (Supports ISO)
  - 178-611:** Reference Step Specimen (2µm, 10µm)
  - 178-612:** Reference Step Specimen (2µm, 10µm, 79µin, 394µin)
  - 178-610:** Step gage (1µm, 2µm, 5µm, 10µm)
  - 178-047:** Three-axis adjustment table (including 998291 precision V-block.)
  - 178-016:** Leveling table
  - 178-042-1:** Digimatic XY leveling table (25 x 25mm)
  - 178-052-1:** Digimatic XY leveling table (1 x 1")
  - 178-043-1:** XY leveling table (25 x 25mm)
  - 178-053-1:** XY leveling table (1 x 1")
  - 178-019:** Precision vise\*
  - 998291:** Precision V-block\*
  - 181-902-10:** V-block set with clamp (Max. workpiece dia.: 25mm)
  - 181-901-10:** V-block set with clamp (Max. workpiece dia.: 1")
- (See page J-22/23.) Detectors, styli, and nosepieces  
\*Use with an XY leveling table

### Optional Accessories

A wide range of peripherals are available to support various challenging measurement needs.



Y-axis Table  
**178-097** for multiple workpiece measurement  
**178-096** for 3D measurement  
\*Not a measuring axis, only for positioning.



3D-Auto Leveling Table  
**178-077**  
\*Used together with **178-096**



Digital Advanced Tilting Unit  
**178-040**  
\*Contact Sales Rep for details. Recommend to be installed in manufacturer's facility.  
(See page J-25 for more accessories.)

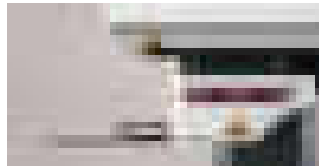

**178-071** (S-3000)  
Standard Detector Holder



**178-075** (S-3000CR)  
Crank Rotary Type Detector Holder

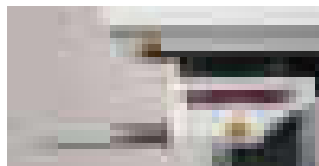

**178-074** (S-3000C)  
Crank Type Detector Holder

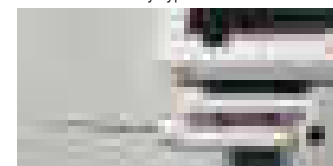

**178-076** (S-3000MR)  
Manual Rotary Type Detector Holder

# Surftest Extreme SV-3000CNC

## SERIES 178 — CNC Surface Measuring Instruments

### FEATURES

- High-accuracy CNC surface roughness measuring instrument allows surface roughness measurement in both axes.
- Each axes has the maximum drive speed of 200 mm/s, which permits high-speed positioning that may result in a large increase in the throughput of multiple-profile/multiple-workpiece measurement tasks.
- For models with the  $\alpha$ -axis, it is possible to perform continuous measurement over horizontal and inclined surfaces by power-tilting the drive unit.
- For models with the Y-axis table, it is possible to expand the measuring range for multiple workpieces, etc., through positioning in the Y-axis direction.
- Using optional rotary table  $\theta 1$  and  $\theta 2$  designed to use with the CNC models enables it to expand the CNC measurement application range.
- Inclined plane measurements is possible through 2-axis simultaneous control in the X- and Y-axis directions.
- Since the detector unit incorporates an anti-collision safety device, the detector unit will automatically stop even if its main body collides with a workpiece or fixture.
- Supplied with an easy-to-operate Remote Box. The user can make any movement by selecting the required axis using the two joysticks. The current axis selection is easily identified by the icon on the key top.
- Communication with the data processing/analysis section is via USB.



SV-3000CNC w/ PC system and software  
PC stand is not included, isolation stand is optional

### SPECIFICATIONS

Model No.	SV-3000CNC		SV-3000CNC	
	178-508-13	178-528-13	178-509-13	178-529-13
Order No. (100V - 120V)	178-508-13	178-528-13	178-509-13	178-529-13
X1-axis measuring range	8" (200mm)	8" (200mm)	8" (200mm)	8" (200mm)
Z2-axis vertical travel	12" (300mm)	20" (500mm)	12" (300mm)	20" (500mm)
Y-axis table unit	Installed	Installed	Installed	Installed
$\alpha$ -axis unit	—	—	Installed	Installed

### Technical Data: SV-3000CNC

X1-axis	Measuring range: 8" (200mm)
	Resolution: 1.97 $\mu$ m (0.05 $\mu$ m)
	Measurement method: Reflective-type linear encoder
	Drive speed: 7.87"/s (200mm/s) (CNC, max.)
	0 - 2.0"/s (0 - 50mm/s) (joystick)
	Measuring speed: .00078 - .078"/s (0.02 - 2mm/s)
	Traversing direction: Backward
	Traverse linearity: 20 $\mu$ m/8" (0.5 $\mu$ m/200mm)
$\alpha$ -axis**	Inclination angle: -45° to +10°
	Resolution: 0.000225°
	Rotating speed: 1rpm
Z2-axis (column)	Vertical travel: 12" (300mm) 20"*(500mm)
	Resolution: 1.97 $\mu$ m (0.05 $\mu$ m)
	Measurement method: Reflective-type linear encoder
	Drive speed: 7.87"/s (200mm/s) (max., CNC)
	0 - 2.4"/s (0 - 60mm/s) (joystick)
	Base size (W x H): 29.5 x 23.6" (750 x 600mm)
	Base material: Granite
Detector	Range / resolution: 32000 $\mu$ m / .4 $\mu$ m, 3200 $\mu$ m / .04 $\mu$ m, 320 $\mu$ m / .004 $\mu$ m (up to 96,000 $\mu$ m with an optional stylus) {800 $\mu$ m / 0.01 $\mu$ m, 80 $\mu$ m / 0.001 $\mu$ m, 8 $\mu$ m / 0.0001 $\mu$ m} (up to 2400 $\mu$ m with an optional stylus)}
	Measuring force: 4mN (0.75mN) (low-force type)
	Stylus tip: Diamond, 90°/5 $\mu$ mR (60°/2 $\mu$ mR: low-force type)
Dimension (W x D x H):	31.5 x 24.4 x 39.4" (800 x 620 x 1000mm)
	31.5 x 24.4 x 47.2" (800 x 620 x 1200mm)*
Mass	529 lbs (240kg) 551lbs (250kg)*
	*High-column model
Y-axis table unit**	Measuring range: 8" (200mm)
	Minimum reading: 1.97 $\mu$ m (0.05 $\mu$ m)
	Scale unit: Reflective-type Linear Encoder
	Drive speed: 7.87"/s (200mm/s) (max., CNC)
	0 - 2.4"/s (0 - 60mm/s) (joystick)
Maximum loading capacity:	44 lbs (20kg)
Traverse linearity	20 $\mu$ m/8" (0.5 $\mu$ m/200mm)
Linear displacement accuracy (at 20°C):	$\pm$ (80+2L/4) $\mu$ m ( $\pm$ (2+2L/100) $\mu$ m)
	L: Dimension between two measured points (mm)
Table size:	7.87 x 7.87" (200 x 200mm)
Dimensions (W x D x H):	12.6 x 25.4 x 4.1" (320 x 646 x 105mm)
Mass:	77 lbs (35kg)
	**Y-axis table included only as a factory installed option.

### Optional Accessories

Vibration isolation stand	Vibration isolation mechanism: Diaphragm air spring
Natural frequency :	2.5 - 3.5Hz
Damping mechanism:	Orifice
Leveling mechanism:	Automatic control with mechanical valves
Air supply pressure:	0.4MPa
Allowable loading capacity:	772 lbs (350kg)
Dimensions (W x D x H):	39.4 x 35.2 x 28.1" (1000 x 895 x 715mm)
Mass:	617 lbs (280kg)

## Technical Data: SV-M3000CNC

### X1-axis

Measuring range: 8" (200mm)  
 Resolution: 1.97µin (0.05µm)  
 Measurement method: Reflective-type linear encoder  
 Drive speed: 7.87"/s (200mm/s) (max., CNC)  
 0 - 1.97"/s (0 - 50mm/s) (joystick)  
 Measuring speed: .00078 - .08"/s (0.02 - 2mm/s)  
 Traverse linearity: 20µin/8" (0.5µm/200mm)  
 28µin/8" (0.7µm/200mm)  
 (long-type detector)  
 20µin/8" (0.5µm/200mm)  
 (rotary-type detector,  
 up/down direction)  
 28µin/8" (0.7µm/200mm)  
 (long-type detector,  
 forward/backward direction)

### α-axis

Inclination angle: -45° to +10°  
 Resolution: 0.000225°  
 Rotating speed: 1rpm

### Z2-axis (column)

Vertical travel: 20" (500mm)  
 Resolution: 1.97µin (0.05µm)  
 Measurement method: Reflective-type linear encoder  
 Drive speed: 7.87"/s (200mm/s) (CNC, max.)  
 0 - 1.97"/s (0 - 50mm/s) (joystick)

### Y-axis

Measuring range: 32" (800mm)  
 Resolution: 1.97µin (0.05µm)  
 Measurement method: Reflective-type linear encoder  
 Drive speed: 7.87"/s (200mm/s) (max., CNC)  
 0 - 1.97"/s (0 - 50mm/s) (joystick)  
 Measuring speed: .00078 - .08"/s (0.02 - 2mm/s)  
 Traverse linearity: 20µin/2" (0.5µm/50mm), 80µin/32"  
 (2µm/800mm) 28µin/2" (0.7µm/50mm),  
 120µin/32" (3µm/800mm)  
 (long-type detector)  
 28µin/2" (0.7µm/50mm),  
 120µin/32" (3µm/800mm)  
 (rotary-type detector, up/down direction)

### Base unit

Size (W x H): 23.6 x 59.1" (600 x 1500mm)  
 Material: Steel  
 Loading capacity: 661 lbs (300kg)

### Detector

Range / resolution: 32000µin / .4µin, 3200µin / .04µin,  
 320µin / .004µin  
 (up to 96,000µin with an optional stylus)  
 {800µm / 0.01µm, 80µm / 0.001µm,  
 8µm / 0.0001µm (up to 2400µm with  
 an optional stylus)}  
 Detecting method: Skidless / skid measurement  
 Measuring force: 4mN or 0.75mN (low-force type)  
 Stylus tip: Diamond, 90°/5µmR  
 (60°/2µmR: low-force type)  
 Skid radius of curvature: 1.57" (40mm)  
 Detecting method: Differential inductance  
 Dimension (W x D x H): 42.7 x 66.7 x 75.7"  
 (1085 x 1695 x 1922mm)  
 Mass: 3527 lbs (1600Kg)  
 (including vibration isolating unit)

**MiCAT**

Mitutoyo Intelligent Computer Aided Technology

the standard in world

metrology software

**FORM**

## Software

### FORMTRACEPAK V5

Enables control of the optional motor-driven Y-axis table and rotary table for realizing efficient measurement automation. You can also perform contour evaluation that allows free analysis of level differences, angle, pitch, area and other characteristics based on surface roughness data. In addition, analysis results can be saved in the "html", "mhtml" or pdf format which allows Internet Explorer or MS-Word compatibility, allowing PC without layout editing programs to view analysis results.



Contour Measurement & Surface Roughness Measurement Screen



Report Layout Screen

# Surftest Extreme SV-M3000CNC

## SERIES 178 — CNC Surface Measuring Instruments



SV-M3000CNC with personal computer system and software

\* PC stand not included

## FEATURES

- CNC Surface Roughness Tester covers measurement of large/heavy workpieces such as engine blocks, crankshafts, etc.
- In combination with the surface roughness detector rotating unit, S-3000AR (optional), it can perform continuous measurement over the bottom, top and side surfaces of a workpiece.
- Compatible with the optional large table for supporting a load of 220 lbs (100 kg) or a large θ2 table. Enables continuous automatic measurement of large-size workpieces.
- Suitable for automatic surface roughness measurement on large and heavy workpieces.
- Employs the column-moving type configuration that is not restricted by workpiece size. This is advantageous for measuring heavy workpieces, such as engine blocks, crankshafts, etc.
- Provides 31.5" (800mm) of Y-axis stroke. This makes it possible to measure multiple profiles on large workpieces.
- Load table has a self-contained structure to ensure that various size workpieces, jigs, auto-feed devices, etc., are easily accommodated and can be specified, if required, by special order.

## SPECIFICATIONS

Model No.	SV-M3000CNC
Order No. (100V - 120V)	178-549-1
X1-axis measuring range	8" (200mm)
Z2-axis column travel range	20" (500mm)
Y-axis travel range	32" (800mm)
α-axis inclination angle	-45° (CCW), +10° (CW)

# Formtracer SV-C3200 / SV-C4500

## SERIES 525 — Surface Roughness / Contour Measuring System

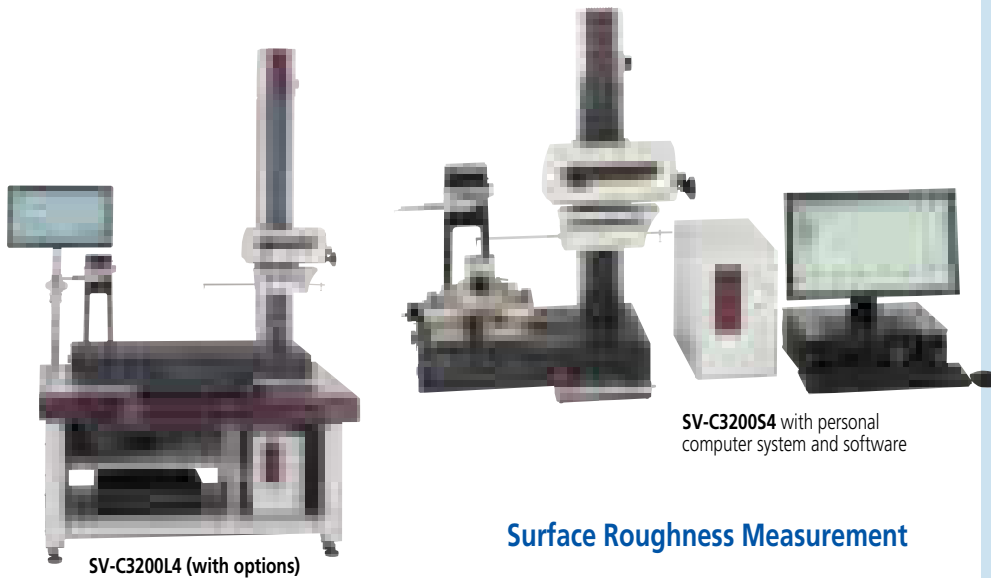

### FEATURES

- Dramatically increased drive speed (X axis: 3.1"/s (80mm/s), Z2 axis column: 1.2"/s (30mm/s) further reduces total measurement time.
- In order to maintain the traverse linearity specification for an extended period of time, Mitutoyo has adopted highly rigid ceramic guides that combine the characteristics of smallest secular change and remarkable resistance to abrasion.
- The drive unit (X-axis) and column (Z2-axis) are equipped with a high-accuracy linear encoder (ABS type on Z2-axis). This improves reproducibility of continuous automatic measurement of small holes in the vertical direction and repeated measurement of parts which are difficult to position.

### Automatic Measurement

- A wide range of optional peripherals are available to support quick and easy CNC operation.

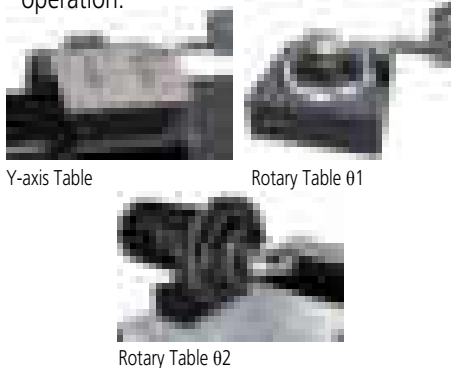

Y-axis Table

Rotary Table 01

Rotary Table 02

SV-C3200S4 with personal computer system and software

### Surface Roughness Measurement



- Traverse linearity:  $(2+1L)\mu\text{m}$  ( $\pm(0.05+0.001L)\mu\text{m}^*$ )  
Designed to handle workpieces calling for high accuracy.  
\*S4, H4, W4 types, L = Drive length inch (mm)
- Compliant with JIS '82/'94/'01, ISO, ANSI, DIN, VDA, and other international surface roughness standards.
- Equipped with a standard high accuracy detector (0.75mN/4mN measuring force) providing a resolution down to 0.004 $\mu\text{m}$  (0.0001 $\mu\text{m}$ ).

### Contour Drive Measurement



- X axis accuracy:  $\pm(31.5+10L)\mu\text{m}$  ( $\pm(0.8+0.01L)\mu\text{m}^*$ )  
Z1-axis accuracy:  $\pm(31.5+120H)\mu\text{m}$  ( $\pm(0.8+12H/100)\mu\text{m}^*$ )  
Designed to handle workpieces calling for high accuracy.  
\*S4, H4, W4 types, L = Drive length, H = Measurement height inch (mm)
- The contour drive unit of SV-C4500 series instruments can continuously measure in the upward and downward directions without the need to change the arm orientation or reset the workpiece, when combined with the double cone-end stylus (a new product with contact points in the upward and downward directions).

### Technical Data: Common

Power supply: 100 - 240VAC  $\pm 10\%$ , 50/60Hz  
Power consumption: 400W (main unit only)

### Technical Data: Contour Measurement

X-axis  
Measuring range: 4" (100mm) or 8" (200mm)  
Resolution: 1.97 $\mu\text{m}$  (0.05 $\mu\text{m}$ )  
Measurement method: Reflective-type linear encoder  
Drive speed: 3.1"/s (80mm/s) and manual  
Measuring speed: .00078 - .78"/s (0.02 - 20mm/s)\*

\*Recommended speed: under 5mm/s  
If using higher speed, stylus tip may be chipped and/or accuracy may be worse, depending on surface condition.

Measuring direction: Forward/backward  
Traverse linearity: 32 $\mu\text{m}/4"$  (0.8 $\mu\text{m}/100\text{mm}$ )  
79 $\mu\text{m}/8"$  (2 $\mu\text{m}/200\text{mm}$ )  
\*with the X axis in horizontal orientation  
Linear displacement:  $\pm(32+10L)\mu\text{m}$  ( $\pm 0.8+0.01L\mu\text{m}$ )  
(SV-C3200S4, H4, W4)  
accuracy (at 20°C)  $\pm(32+10L)\mu\text{m}$  ( $\pm 0.8+0.01L\mu\text{m}$ )  
(SV-C4500S4, H4, W4)  
 $\pm(32+20L)\mu\text{m}$  ( $\pm 0.8+0.02L\mu\text{m}$ )  
(SV-C3200S8, H8, W8)  
 $\pm(32+20L)\mu\text{m}$  ( $\pm 0.8+0.02L\mu\text{m}$ )  
(SV-C4500S8, H8, W8)  
\* L = Drive length inch (mm)

Inclination range:  $\pm 45^\circ$   
Z2-axis (column)  
Vertical travel: 12" (300mm) or 20" (500mm)  
Resolution: 39.4 $\mu\text{m}$  (1 $\mu\text{m}$ )  
Measurement method: ABSOLUTE linear encoder  
Drive speed: 0 - 1.2"/s (0 - 30mm/s) and manual  
Z1-axis (detector unit)  
Measuring range:  $\pm 1.2"$  ( $\pm 30\text{mm}$ )

Resolution: 1.57 $\mu\text{m}$  (0.04 $\mu\text{m}$ ) (SV-C3200 series),  
.78 $\mu\text{m}$  (0.02 $\mu\text{m}$ ) (SV-C4500 series)  
Measurement method: Linear encoder (SV-C3200 series),  
Laser hologage (SV-C4500 series)  
Linear displacement:  $\pm(63+120H)\mu\text{m}$  ( $\pm(1.4+12H/100)\mu\text{m}$ )  
(SV-C3200 series)  
accuracy (at 20°C)  $\pm(31.5+120H)\mu\text{m}$   
( $\pm(0.8+12H/100)\mu\text{m}$ ) (SV-C4500 series)  
\*H: Measurement height from the horizontal position (mm)

Stylus up/down operation: Arc movement  
Face of stylus: Upward/downward (SV-C3200)  
Upward/downward (Direction switch by Formtracepak) (SV-C4500)  
Measuring force: 30mN (SV-C3200)  
10, 20, 30, 40, 50mN (SV-C4500)  
\* As for SV-C4500, set the measurement force with Formtracepak.

Traceable angle: Ascent: 77°, descent: 83°  
(using the standard stylus provided and depending on the surface roughness)  
Stylus tip: Radius: 25 $\mu\text{m}$ , carbide tip

### Technical Data: Surface Roughness Measurement

X1-axis  
Measuring range: 4" (100mm) or 8" (200mm)  
Resolution: 1.97 $\mu\text{m}$  (0.05 $\mu\text{m}$ )  
Measurement method: Linear encoder  
Drive speed: 3.1"/s (80mm/s)  
Traversing direction: Backward  
Traverse linearity:  $(2+1L)\mu\text{m}$  (0.05+1L/1000) $\mu\text{m}$   
(S4, H4, W4 types)  
20 $\mu\text{m}/8"$  (0.5 $\mu\text{m}/200\text{mm}$ )  
(S8, H8, W8 types)

Z2-axis (column)  
Vertical travel: 12" (300mm) or 20" (500mm)  
Resolution: 39.4 $\mu\text{m}$  (1 $\mu\text{m}$ )  
Measurement method: ABSOLUTE linear encoder  
Drive speed: 0 - 1.2"/s (0 - 30mm/s) and manual  
Detector  
Range / resolution: 32000  $\mu\text{m}$  / .4  $\mu\text{m}$ , 3200 $\mu\text{m}$  / .04 $\mu\text{m}$ ,  
320  $\mu\text{m}$  / .004 $\mu\text{m}$   
(up to 96000  $\mu\text{m}$  with an optional stylus)  
(800 $\mu\text{m}$  / 0.01 $\mu\text{m}$ , 80 $\mu\text{m}$  / 0.001 $\mu\text{m}$ ,  
8 $\mu\text{m}$  / 0.0001 $\mu\text{m}$  (up to 2400 $\mu\text{m}$  with an optional stylus))  
Detecting method: Skidless / skid measurement  
Measuring force: 0.75mN (low force type)  
Stylus tip: Diamond  
60°/2 $\mu\text{m}$ R (low force type)  
Skid radius of curvature: 1.57" (40mm)  
Detecting method: Differential inductance



# Formtracer SV-C3200 / SV-C4500

## SERIES 525 — Surface Roughness / Contour Measuring System

### SPECIFICATIONS

Model No.	SV-C3200S4	SV-C3200H4	SV-C3200W4	SV-C3200L4
Order No. (inch)	<b>525-491-11A</b>	<b>525-492-11A</b>	<b>525-493-11A</b>	<b>525-494-11A</b>
Model No.	SV-C4500S4	SV-C4500H4	SV-C4500W4	SV-C4500L4
Order No. (inch)	<b>525-451-11A</b>	<b>525-452-11A</b>	<b>525-453-11A</b>	<b>525-454-11A</b>
X1-axis measuring range	4" (100mm)	4" (100mm)	4" (100mm)	4" (100mm)
Measuring force of detector	0.75mN	0.75mN	0.75mN	0.75mN
Vertical travel	12" (300mm) power column	20" (500mm) power column	20" (500mm) power column	27.6" (700mm) power column
Granite base size (WxD)	23.6 x 17.7" (600 x 450mm)	23.6 x 17.7" (600 x 450mm)	39.4 x 17.7" (1000 x 450mm)	39.4 x 17.7" (1000 x 450mm)
Dimensions (main unit, WxDxH)	39.2 x 22.6 x 38.0" (996 x 575 x 966mm)	39.2 x 22.6 x 46.3" (996 x 575 x 1176mm)	55.4 x 22.6 x 46.3" (1396 x 575 x 1176mm)	55.4 x 22.6 x 56.1" (1396 x 575 x 1426mm)
Mass (main unit)	308 lbs (140kg)	330 lbs (150kg)	485 lbs (220kg)	595 lbs (270kg)
Model No.	SV-C3200S8	SV-C3200H8	SV-C3200W8	SV-C3200WL8
Order No. (inch)	<b>525-496-11A</b>	<b>525-497-11A</b>	<b>525-498-11A</b>	<b>525-499-11A</b>
Model No.	SV-C4500S8	SV-C4500H8	SV-C4500W8	SV-C4500L8
Order No. (inch)	<b>525-456-11A</b>	<b>525-457-11A</b>	<b>525-458-11A</b>	<b>525-459-11A</b>
X1-axis measuring range	8" (200mm)	8" (200mm)	8" (200mm)	4" (100mm)
Measuring force of detector	0.75mN	0.75mN	0.75mN	0.75mN
Vertical travel	12" (300mm) power column	20" (500mm) power column	20" (500mm) power column	27.6" (700mm) power column
Granite base size (WxD)	23.6 x 17.7" (600 x 450mm)	23.6 x 17.7" (600 x 450mm)	39.4 x 17.7" (1000 x 450mm)	39.4 x 17.7" (1000 x 450mm)
Dimensions (main unit, WxDxH)	39.6 x 22.6 x 38.0" (1006 x 575 x 966mm)	39.6 x 22.6 x 46.3" (1006 x 575 x 1176mm)	55.4 x 22.6 x 46.3" (1406 x 575 x 1176mm)	55.4 x 22.6 x 56.1" (1396 x 575 x 1426mm)
Mass (main unit)	308 lbs (140kg)	330 lbs (150kg)	485 lbs (220kg)	595 lbs (270kg)

**MiCAT**  
Mitutoyo Intelligent Computer Aided Technology

the standard in world  
metrology software  
**FORM**

### Software

#### FORMTRACEPAK V5

Enables control of the optional motor-driven Y-axis table and rotary table for realizing efficient measurement automation. You can also perform contour evaluation that allows free analysis of level differences, angle, pitch, area and other characteristics based on surface roughness data. In addition, analysis results can be saved in the "html", "mhtml" or pdf format which allows Internet Explorer or MS-Word compatibility, allowing PC without layout editing programs to view analysis results.

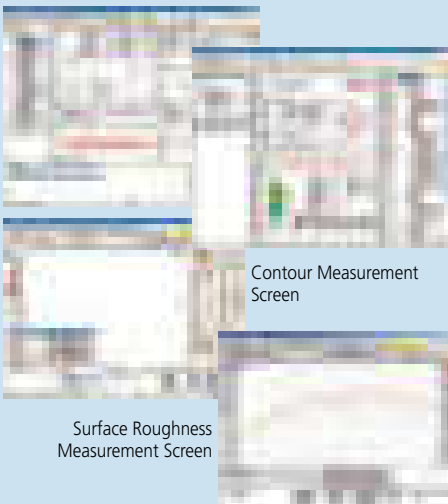

Contour Measurement Screen

Surface Roughness Measurement Screen

### Optional Accessories

A wide range of peripherals are available to support various challenging measurement needs.



Y-axis Table  
**178-097** for multiple workpiece measurement  
**178-096** for 3D measurement  
\*Not a measuring axis, only for positioning.

(See page J-25 for more accessories.)



3D-Auto Leveling Table  
**178-077**  
\*Used together with 178-096



**178-071** (S-3000)  
Standard Detector Holder



**178-091** (S-3000CR)  
Crank Rotary Type Detector Holder



**178-074** (S-3000C)  
Crank Type Detector Holder



**178-092** (S-3000MR)  
Manual Rotary Type Detector Holder

# Formtracer Extreme SV-C4500CNC

## SERIES 525 — Surface Roughness/Form Measuring Instrument



SV-C4500CNC with recommended machine vibration stand

\* PC stand not included

Surface roughness detector



Contour Z-axis detector



### FEATURES

- High-accuracy CNC surface roughness/form measuring instrument allows both measurement of surface roughness and form/contour with one unit.
- Each axes has the maximum drive speed of 7.87"/s (200 mm/s), which permits high-speed positioning that may result in a large increase in the throughput of multiple-profile/multiple-workpiece measurement tasks.
- For models with the  $\alpha$  axis, it is possible to perform continuous measurement over horizontal and inclined surfaces by power-tilting the detector unit.
- For models with the Y-axis table, it is possible to expand the measuring range for multiple workpieces, etc., through positioning in the Y-axis direction.
- When combined with the double cone-end stylus (a new product with diametrically opposed contact points), the instrument can continuously measure in the upward and downward directions without the need to change the arm orientation or reset the workpiece fixturing.
- The measuring force can be switched among five levels (upward and downward) from the data-processing program (Formtracepak).
- Enables inclined plane measurements through 2-axis simultaneous control in the X- and Y-axis directions.
- When the detector for form/contour measurement is replaced with that for surface roughness measurement, or vice versa, it is a simple, one-touch replacement without re-routing of the connecting cables.
- Since the Z1-axis detector incorporates an anti-collision safety device, the detector unit will automatically stop even if its main body collides with a workpiece or fixture.
- Supplied with an easy-to-operate Remote Box. The user can make any movement by selecting the required axis using the two joysticks. The current axis selection is easily identified by the icon on the key top.
- Communication with the Data Processing/Analysis section is via USB.

### Technical Data: Common

Base size (W x H):	31 x 39.4" (800 x 1000mm) Type S 34 x 47.2" (800 x 1200mm) Type H
Base material:	Granite
Mass:	529 lbs (240kg) Type S 551 lbs (250kg) Type H
Power supply:	100 - 120VAC $\pm$ 10%, 50/60Hz
Power consumption:	500W (main unit only)

### Technical Data: Contour Measurement

X1-axis	
Measuring range:	8" (200mm)
Resolution:	1.97 $\mu$ m (0.05 $\mu$ m)
Measurement method:	Reflective-type linear encoder
Drive speed:	7.87"/s (200mm/s) (max., CNC) 0 - 2"/s (0 - 50mm/s) (joystick)
Measuring speed:	.00078 - .08"/s (0.02 - 2mm/s)
Measuring direction:	Forward / Backward
Traverse linearity:	80 $\mu$ m / 8" (2 $\mu$ m/200mm) *with the X axis in horizontal orientation
Linear displacement accuracy (at 20°C):	$\pm$ (0.8+4L/200)mm * L = Drive length (mm)
$\alpha$ -axis* Depends on Code #	
Inclination angle:	-45° to +10°
Resolution:	0.000225°
Rotating speed:	1rpm
Z2-axis (column)	
Vertical travel:	12" or 20" (300mm or 500mm)
Resolution:	1.97 $\mu$ m (0.05 $\mu$ m)
Measurement method:	Reflective-type linear encoder
Drive speed:	7.87"/s (200mm/s) (max., CNC) 0 - 2"/s (0 - 50mm/s) (joystick)
Z1-axis (detector unit)	
Measuring range:	$\pm$ 1.2" ( $\pm$ 30mm)
Resolution:	.787 $\mu$ m (0.02 $\mu$ m)
Measurement method:	Reflective Type detector unit
Linear displacement:	Accuracy (at 20°C) $\pm$ (32+110H) $\mu$ m ( $\pm$ (0.8+12H/100) $\mu$ m) *H: Measurement height from the horizontal position (mm) w/o $\alpha$ -axis: $\pm$ (1.5+10H/1000) $\mu$ m

Stylus up/down operation: Arc movement

Face of stylus: Downward

Measuring force: 10, 20, 30, 40, 50mN

Traceable angle: Ascent: 70°, descent: 70°

(using the standard stylus provided and depending on the surface roughness)

Stylus tip

Radius: 25 $\mu$ m, carbide tip

### Technical Data: Surface Roughness Measurement

X1-axis	
Measuring range:	8" (200mm)
Resolution:	1.97 $\mu$ m (0.05 $\mu$ m)
Measurement method:	Reflective-type linear encoder
Drive speed:	7.87"/s (200mm/s) (max., CNC) 0 - 2"/s (0 - 50mm/s) (joystick)
Measuring speed:	.00078 - .08"/s (0.02 - 2mm/s)
Traversing direction:	Pulling
Traverse linearity:	20 $\mu$ m/8" (0.5 $\mu$ m/200mm)
$\alpha$ -axis* Depends on Code #	
Inclination angle:	-45° to +10°
Resolution:	0.000225°
Rotating speed:	1rpm
Z2-axis (column)	
Vertical travel:	12" or 20" (300mm or 500mm)
Resolution:	1.97 $\mu$ m (0.05 $\mu$ m)
Measurement method:	Reflective-type linear encoder
Drive speed:	7.87"/s (200mm/s) (max., CNC) 0 - 2"/s (0 - 50mm/s) (joystick)
Detector (optional)	
Range / resolution:	32000 $\mu$ m / .4 $\mu$ m, 3200 $\mu$ m / .04 $\mu$ m, 320 $\mu$ m / .004 $\mu$ m (up to 96000 $\mu$ m with an optional stylus) {800 $\mu$ m / 0.01 $\mu$ m, 80 $\mu$ m / 0.001 $\mu$ m, 8 $\mu$ m / 0.0001 $\mu$ m (up to 2400 $\mu$ m with an optional stylus)}
Detecting method:	Skidless / skid measurement
Measuring force:	0.75mN
Stylus tip:	60°/2 $\mu$ mR
Skid radius of curvature:	1.57" (40mm)
Detecting method:	Differential inductance

# Formtracer Extreme SV-C4500CNC

## SERIES 525 — Surface Roughness/Form Measuring Instrument

### Y-axis table unit\*\*

Measuring range: 8" (200mm)  
 Minimum reading : 1.97µin (0.05µm)  
 Scale unit: Reflective-type linear encoder  
 Drive speed: 200mm/s (max., CNC)  
 0 - 2"/s (0 - 50mm/s) (joystick)

Maximum loading capacity: 44 lbs (20kg)  
 Traverse linearity 20µin/8" (0.5µm/200mm) Surface roughness  
 80µin/8" (2µm/200mm) contour

Linear displacement accuracy (at 20°C):  
 ± (80+20L)µin(± (2+2L/100) µm)  
 contour mode  
 L: Dimension between two measured  
 points (mm)

Table size: 7.8 x 7.8" (200 x 200mm)  
 Dimensions (W x D x H): 2.6 x 25.4 x 4.1"  
 (320 x 646 x 105mm)

Mass: 77 lbs (35kg)

\*\*Y-axis table included only as a factory installed option.

### Optional Accessories

#### Machine vibration stand: 12AAE032

Vibration isolation mechanism: Diaphragm air spring  
 Natural frequency : 2.5 - 3.5Hz  
 Damping mechanism: Orifice  
 Leveling mechanism: Automatic control with mechanical  
 valves

Air supply pressure: 0.4Mpa  
 Allowable loading capacity: 772 lbs (350kg)  
 Dimensions (W x D x H): 39.4 x 35.2 x 28.1"  
 (1000 x 895 x 715mm)

Mass: 617 lbs (280kg)



### Software

#### FORMTRACEPAK V5

Enables control of the optional motor-driven Y-axis table and rotary table for realizing efficient measurement automation. You can also perform contour evaluation that allows free analysis of level differences, angle, pitch, area and other characteristics based on surface roughness data. In addition, analysis results can be saved in the "html", "mhtml" or pdf format which allows Internet Explorer or MS-Word compatibility, allowing PC without layout editing programs to view analysis results.

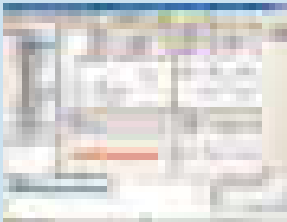

Contour Measurement and Surface Roughness Measurement Screen

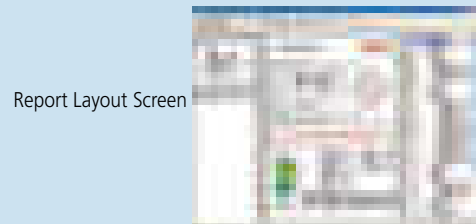

Report Layout Screen

### SPECIFICATIONS

Model No.	SV-C4500S CNC	SV-C4500H CNC
Order No. (100V - 120V)	525-674-1	525-694-1A
X1-axis measuring range	8" (200mm)	8" (200mm)
Z2-axis vertical travel	12" (300mm)	20" (500mm)
Y-axis table unit	Installed	Installed
α-axis unit	Installed	Installed
Granite base size (WxD)	29.5 x 23.6" (750 x 600mm)	29.5 x 23.6" (750 x 600mm)
Dimensions (main unit, WxDxH)	31.5 x 24.4 x 39.4" (800 x 620 x 1000mm)	31.5 x 24.4 x 47.2" (800 x 620 x 1200mm)
Mass (main unit)	529 lbs (240kg)	551 lbs (250kg)

### DIMENSIONS

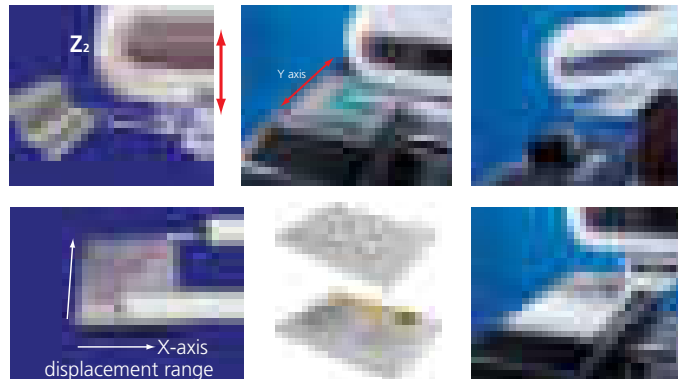
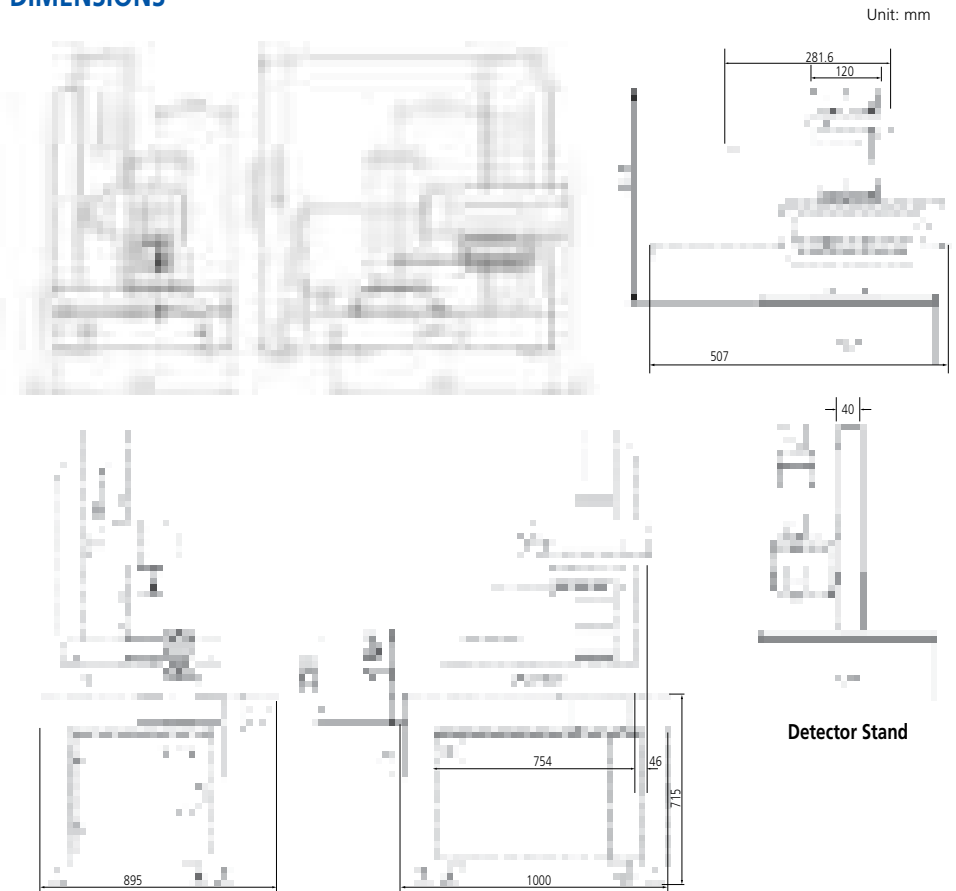

# Formtracer CS-3200

SERIES 525 — Form Measuring Instruments

**ABSOLUTE**<sup>®</sup>  
Absolute System Patented by MITUTOYO



**CS-3200S4 with personal computer system and software**  
\* PC stand not included.

## FEATURES

- Highest measurement accuracy in its class.  
X axis:  $\pm(1+0.01L)\mu\text{m}$   
Z1 axis:  $\pm(1.5+2H/100)\mu\text{m}$
- To detect surface roughness and contour in a single measurement the Z1-axis detector unit of CS-3200S4 has a wide measuring range and high resolution of 5mm / 0.08 $\mu\text{m}$  to 0.05mm / 0.0008 $\mu\text{m}$ .

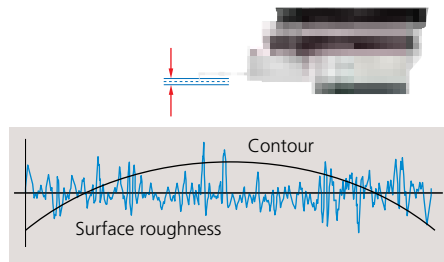

- In order to maintain the traverse linearity specification for an extended period of time, Mitutoyo has adopted highly rigid ceramic guides that combine the characteristics of smallest secular change and remarkable resistance to abrasion.
- Drastically increased drive speed further reduces total measurement time.  
X axis: 80mm/s, Z2 axis: 20mm/s
- To enhance safety during fast traverse, the Z-axis detector unit incorporates a safety device (Automatic Stop-On-Collision Mechanism).

- The detector unit can be extended to avoid interference between the drive unit and workpiece. The measuring range is shifted to the left by 2.76" (70mm).



- Incorporation of an ABS scale in the Z2 axis eliminates the need for origin point re-setting conventionally required for every step of repeated measurements over step or multiple sections.
- Small holes and inclined planes can be efficiently measured using the inclined X-axis drive unit and fine-feed handles on the X and Z2 axes.
- All detector and drive unit cables are housed inside the main unit to eliminate any risk of abrasion and guarantee trouble-free, high-speed operation.
- Orientation of the drive unit can be inclined by  $\pm 45^\circ$ . This allows CS-3200 to measure an inclined surface quickly.

## Technical Data: Contour Measurement

<b>X1-axis</b>	
Measuring range:	4" (100mm)
Resolution:	1.97 $\mu\text{m}$ (0.05 $\mu\text{m}$ )
Measurement method:	Reflective-type linear encoder
Drive speed:	0 - 3.1"/s (0 - 80mm/s) and manual
Measuring speed:	.00078 - .00787"/s (0.02 - 0.2mm/s) (surface roughness) 0.00078 - 0.0787"/s (0.02 - 2mm/s) (contour)
Measuring direction:	Forward / Backward
Traverse linearity:	8 $\mu\text{in}/4"$ (16 $\mu\text{in}/4"$ ) [0.2 $\mu\text{m}/100\text{mm}$ (0.4 $\mu\text{m}/100\text{mm}$ )] ( ) : at the protruded detector position *with the X axis in horizontal orientation
Linear displacement accuracy (at 20°C):	$\pm(32+10L)\mu\text{in}$ ( $\pm(0.8+0.01L)\mu\text{m}$ ) * L = Drive length (mm)
Inclination range:	$\pm 45^\circ$
<b>Z2-axis (column)</b>	
Vertical travel:	12" (300mm)
Resolution:	39.4 $\mu\text{in}$ (1 $\mu\text{m}$ )
Measurement method:	ABSOLUTE linear encoder
Drive speed:	0 - .78"/s (0 - 20mm/s) and manual
<b>Z1-axis (detector unit)</b>	
Measuring resolution / range:	3 $\mu\text{in}/.2"$ , .3 $\mu\text{in}/.02"$ , .03 $\mu\text{in}/.002"$ (0.08 $\mu\text{m}/5\text{mm}$ , 0.008 $\mu\text{m}/0.5\text{mm}$ , 0.0008 $\mu\text{m}/0.05\text{mm}$ )
Measurement method:	Differential inductance method
Linear displacement:	$\pm(60+20H)\mu\text{in}$ ( $\pm(1.5+2H/100)\mu\text{m}$ )
Accuracy (at 20°C):	*H: Measurement height from the horizontal position (mm)
Stylus up/down operation:	Arc movement
Face of stylus:	Downward
Measuring force:	0.75mN
Traceable angle:	Ascent: 65°, descent: 65° (using the standard stylus provided and depending on the surface roughness)
Stylus tip:	Radius: 2 $\mu\text{m}$ , diamond
Base size (W x H):	23.6 x 17.7" (600 x 450mm)
Base material:	Granite
Mass:	309 lbs (140kg) (main unit)
Power supply:	100 - 240VAC $\pm 10\%$ , 50/60Hz
Power consumption:	400W (main unit only)

## Protrusion of Detector Position

**Normal detector position** Unit: mm

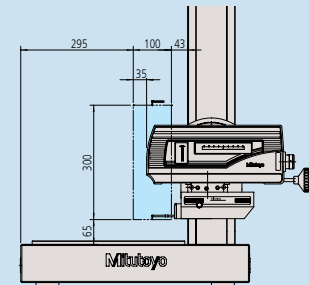

**When detector is maximally extended (Extended by 70mm from normal position)**

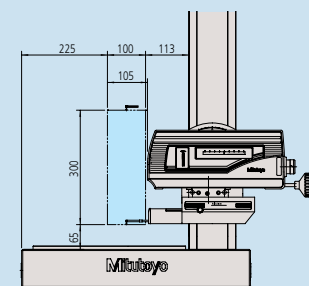

# Formtracer CS-3200

## SERIES 525 — Form Measuring Instruments

**MiCAT**

Mitutoyo Intelligent Computer Aided Technology

the standard in world  
metrology software  
**FORM**

### Software

#### FORMTRACEPAK6000

Enables control of the optional motor-driven Y-axis table and rotary table for realizing efficient measurement automation. You can also perform contour evaluation that allows free analysis of level differences, angle, pitch, area and other characteristics based on surface roughness data. In addition, you can create an original inspection certificate by setting the print format to suit your particular requirements.

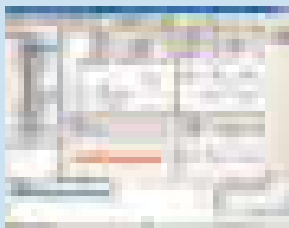

Measuring instrument control

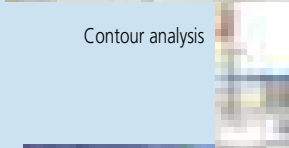

Contour analysis



Surface roughness analysis



Design data creation  
(CAD file import)



Contour verification



Inspection certificate creation

#### Main Unit Startup System

This machine incorporates a startup system (relocation detection system), which disables operation when an unexpected vibration is applied or the machine is relocated. Be sure to contact your nearest Mitutoyo prior to relocating this machine after initial installation.

### SPECIFICATIONS

Model No.	CS-3200S4
Order No. (inch)	525-411A
X1-axis measuring range	4" (100mm)
Z2-axis vertical travel	12" (300mm)

### Stylus

(Unit: inch (mm))

#### Standard stylus: No. 12AAD554

Tip radius: 2  $\mu$ m  
Tip angle: 60° cone  
Tip material: Diamond

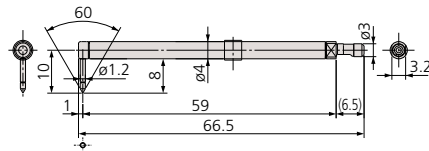

For contour/surface roughness measurement  
Measurable depth: .28" (7mm) max.

#### Eccentric stylus: No. 12AAD558

Tip radius: 2  $\mu$ m  
Tip angle: 60° cone  
Tip material: Diamond

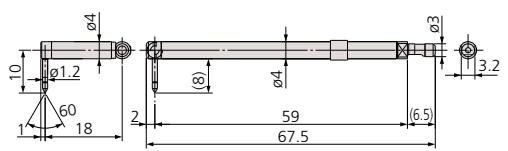

For contour/surface roughness measurement  
Measurable offset length: .60" (15mm)

#### Cone stylus: No. 12AAD552

Tip radius: 25  $\mu$ m  
Tip angle: 30° cone  
Tip material: Sapphire

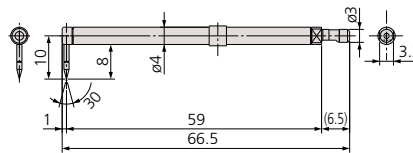

For contour measurement  
Measurable depth: .28" (7mm) max.

#### Deep Groove stylus: No. 12AAD560

Tip radius: 2  $\mu$ m  
Tip angle: 60° cone  
Tip material: Diamond

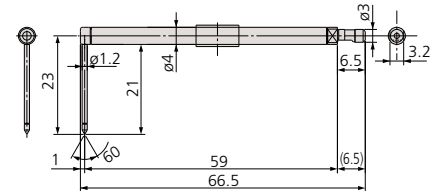

For contour/surface roughness measurement  
Measurable depth: .79" (20mm) max.

#### Small hole stylus: No. 12AAD556

Tip radius: 2  $\mu$ m  
Tip angle: 60° cone  
Tip material: Diamond

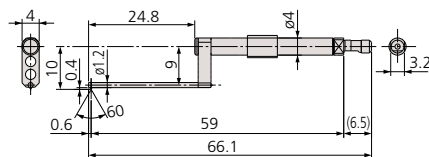

For contour/surface roughness measurement  
Applicable hole:  $\phi$ .08" ( $\phi$ 2mm) min.

#### 2x-long stylus: No. 12AAD562

Tip radius: 5  $\mu$ m  
Tip angle: 40° cone  
Tip material: Diamond

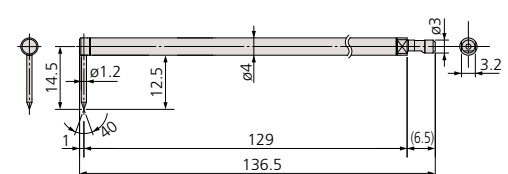

For contour/surface roughness measurement  
Measurable depth: .39" (10mm) max.

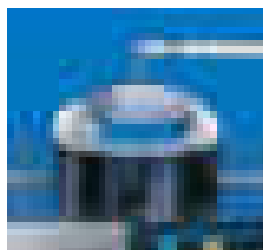

Measuring lens

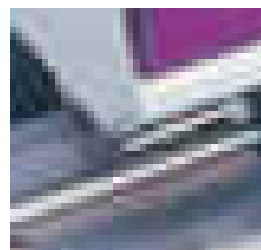

Measuring ball screw

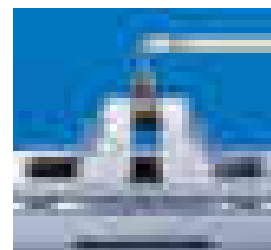

Measuring bearing ring

**Mitutoyo**

# Formtracer Extreme CS-5000CNC / CS-H5000CNC

## SERIES 525 — CNC Form Measuring Instruments



CS-H5000CNC with personal computer system and software

\* PC stand not included



Remote box

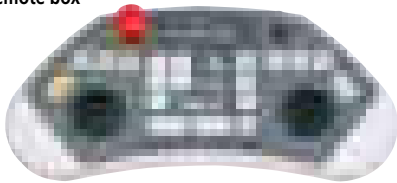

Wide range detector employing active control technology

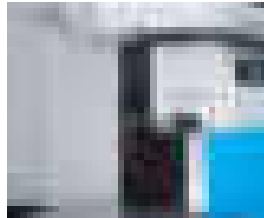

### FEATURES

- High-accuracy stylus-type CNC surface measuring instrument allows simultaneous measurement of surface roughness and form/contour.
- The X1 axis has a maximum drive speed of 1.57"/s (40 mm/s) and Z2 axis has a maximum drive speed of 7.87"/s (200 mm/s). This permits high-speed positioning that may result in a large increase in the throughput of multiple-profile / multiple-workpiece measurement tasks.
- A Mitutoyo Laser Holescale is incorporated in the X1 axis and Z1 axis so that high resolution (X1 axis: 6.25nm, Z1 axis: 4nm/8nm) is achieved and batch measurement of form / contour and surface roughness can be made.
- The active control method is employed for the Z1-axis detector to implement a wide-range measurement capability wherein the variation in dynamic measuring force is restricted.
- Since the Z1-axis detector incorporates an anti-collision safety device, the detector unit will automatically stop even if its main body collides with a workpiece or fixture.
- For models with the  $\alpha$ -axis, it is possible to perform continuous measurement over horizontal and inclined surfaces by power-tilting the X1 axis.
- For models with the Y-axis table, it is possible to expand the measuring range for multiple workpieces, etc., through positioning in the Y-axis direction.
- Supplied with the easy-to-operate Remote Box, the user can make any movement by selecting the required axis using the two joysticks. The current axis selection is easily identified by the icon on the key top.
- Uses USB for communicating with the Data Processing / Analysis Unit (optional).

### Technical Data:

<b>X1 axis</b>	
Measuring range:	8" (200mm)
Resolution:	0.25 $\mu$ m (0.00625 $\mu$ m)
Measurement method:	Laser Holescale
Drive speed:	Max. 1.57"/s (40mm/s) (in CNC mode) 0 - 1.57"/s (0 - 40mm/s) (in joystick control mode)
Measuring speed:	.0008 - .008"/s (0.02 - 0.2mm/s) (surface roughness) .0008 - .08"/s (0.02 - 2mm/s) (form/contour)
Measuring direction:	Forward / Backward
Traverse linearity:	(4+1.5L) $\mu$ m {(0.1+0.0015L) $\mu$ m} with standard stylus (8+1.5L) $\mu$ m {(0.2+0.0015L) $\mu$ m} with 2X-long stylus
*Traverse linearity:	(2+3L) $\mu$ m {(0.05+0.0003L) $\mu$ m} with standard stylus (4+1.5L) $\mu$ m {(0.1+0.0015L) $\mu$ m} with 2X-long stylus
Linear displacement accuracy $\pm$ (20°C):	$\pm$ (12+2L) $\mu$ m { $\pm$ (0.3+0.002L) $\mu$ m}
*Linear displacement accuracy $\pm$ (20°C):	$\pm$ (2.8+6.3+L) $\mu$ m { $\pm$ (0.16+0.001L) $\mu$ m}
	L = Measured length inch (mm)
<b>Z1 axis</b>	
Measuring range:	.47" (12mm) (with standard stylus) .94" (24mm) (with 2X-long stylus)
Resolution:	.16 $\mu$ m (0.004 $\mu$ m) (with standard stylus) .32 $\mu$ m (0.008 $\mu$ m) (with 2X-long stylus)
*Resolution:	.03 $\mu$ m (0.0008 $\mu$ m) (with standard stylus) .06 $\mu$ m (0.0016 $\mu$ m) (with 2X-long stylus)
Stylus up/down:	Arc movement
Measurement method:	Transmission-type laser linear encoder
Linear displacement accuracy (20°C):	$\pm$ (12+120H) $\mu$ m { $\pm$ (0.3+10.02H) $\mu$ m}
*Linear displacement accuracy (20°C):	$\pm$ (2.8+120H) $\mu$ m { $\pm$ (0.07+10.02H) $\mu$ m}
	H = Measured height inch (mm)
Measuring force:	4mN (with standard stylus) 0.75mN (with 2X-long stylus)
Traceable angle:	60° for ascent, 60° for descent (Depending on the workpiece surface condition)
Stylus tip:	Radius: 5 $\mu$ m, angle: 40°, diamond
(ball stylus)	(Radius: 0.25mm, sapphire)
Face of stylus:	Downward
<b>Z2 axis (column type)</b>	
Measuring range:	12" (300mm) (20" (500mm) high column type)
Resolution:	1.97 $\mu$ m (0.05 $\mu$ m)
Measurement method:	Reflective-type linear encoder
Drive speed:	Max. 7.87"/s (200mm/s) (in CNC mode) 0 - 1.97"/s (0 - 50mm/s) (in joystick control mode)
Base size (W x D):	29.5 x 23.6" (750 x 600mm)
Base material:	Granite
Dimension (W x D x H):	31.5 x 24.4 x 39.4" (800 x 620 x 1000mm) 31.5 x 24.4 x 47.2" (800 x 620 x 1200mm: high column type)
Mass:	529 lbs (240kg) 551 lbs (250kg): high column type)

\*CS-H5000CNC model in red.

# Formtracer Extreme CS-5000CNC / CS-H5000CNC

## SERIES 525 — CNC Form Measuring Instruments

### SPECIFICATIONS

Model No.	CS-5000CNC	CS-5000CNC
Order No. (100V - 120V)	<b>525-727-13</b>	<b>525-729-13</b>
X1-axis measuring range	8" (200mm)	8" (200mm)
Z2-axis vertical travel	12" (300mm)	12" (300mm)
Y-axis table unit	—	Installed
α-axis unit	Installed	Installed

Model No.	CS-5000CNC	CS-5000CNC
Order No. (100V - 120V)	<b>525-747-13</b>	<b>525-749-13</b>
X1-axis measuring range	8" (200mm)	8" (200mm)
Z2-axis vertical travel	20" (500mm)	20" (500mm)
Y-axis table unit	—	Installed
α-axis unit	Installed	Installed

Model No.	CS-H5000CNC	CS-H5000CNC	CS-H5000HCNC	CS-H5000HCNC
Order No. (100V - 120V)	<b>525-776-13</b>	<b>525-777-13</b>	<b>525-706-13</b>	<b>525-707-13</b>
X1-axis measuring range	8" (200mm)	8" (200mm)	8" (200mm)	8" (200mm)
Z2-axis vertical travel	12" (300mm)	12" (300mm)	20" (500mm)	20" (500mm)
Y-axis table unit	—	Installed	—	Installed

### Stylus

**12AAD543\*1:** Standard-length stylus (tip radius: 5μm)

**12AAJ037\*2:** For CS-H5000CNC (tip radius: 5μm)

Tip material: Diamond

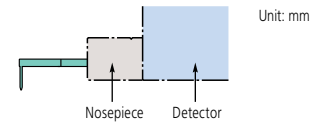
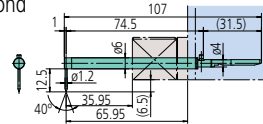

**12AAD544\*1\*2:** Standard-length ball stylus (tip radius: 5μm)

Tip material: Sapphire

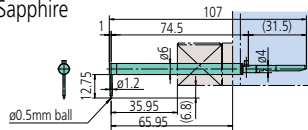

**12AAD651:** Standard-length stylus for small hole

Tip radius: 5μm

Tip material: Diamond

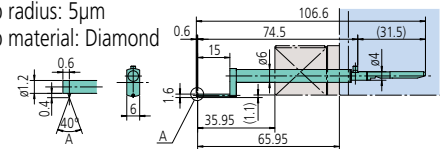

**12AAD652:** Standard-length stylus for extra-small hole

Tip radius: 5μm

Tip material: Diamond

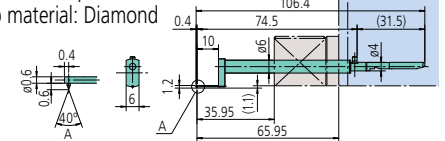

**12AAD545\*1:** Double-length stylus (tip radius: 5μm)

**12AAJ039\*2:** For CS-H5000CNC (tip radius: 5μm)

Tip material: Diamond

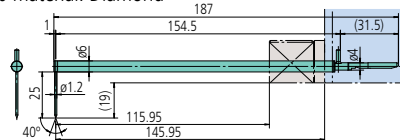

**12AAD653:** Standard-length eccentric stylus

Tip radius: 5μm

Tip material: Diamond

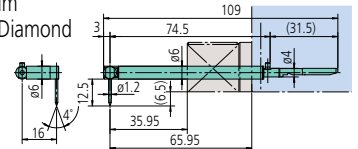

**12AAD546\*1\*2:** Double-length ball stylus

Tip material: Sapphire

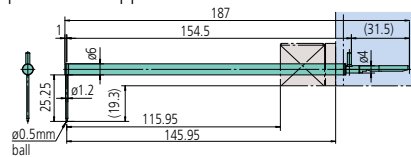

**12AAJ041\*2:** Double-length stylus (tip radius: 2μm)

Tip material: Diamond

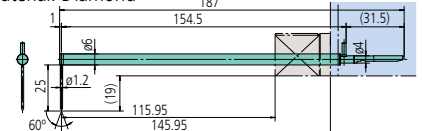

\*1: Standard accessory of CS-5000CNC

\*2: Standard accessory of CS-H5000CNC

### Software

#### FORMTRACEPAK V5

Enables control of the optional motor-driven Y-axis table and rotary table for realizing efficient measurement automation. You can also perform contour evaluation that allows free analysis of level differences, angle, pitch, area and other characteristics based on surface roughness data. In addition, analysis results can be saved in the "html", "mhtml" or pdf format which allows Internet Explorer or MS-Word compatibility, allowing PC without layout editing programs to view analysis results.

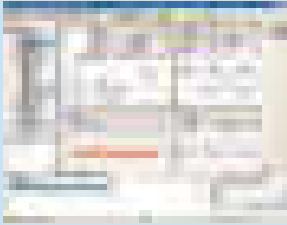

Contour Measurement and Surface Roughness Measurement Screen

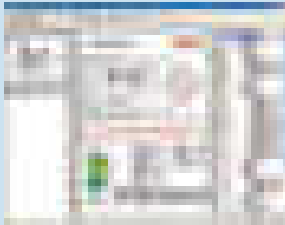

Report Layout Screen

#### ASLPAK (optional software)

Spherical lens analysis program recommended to be used with CS-H5000CNC and CS-5000CNC models. To make full use of software functions, optional accessories such as y-axis table, 3DALT and theta θ-1 table are required. The functions can be restricted without the optional accessories.



# Optional Styli for Surface Roughness Measurement

Compatible with SJ-410, SJ-500, SV-2100, SV-3100, SV-3000CNC, SV-M3000CNC, SV-C3200, SV-C4500 Series

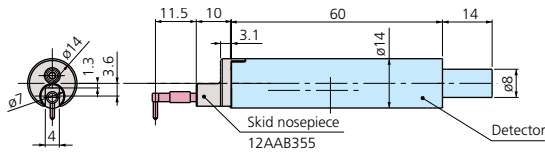

Detector (0.75mN): **178-396-2**  
 Detector (4mN): **178-397-2**

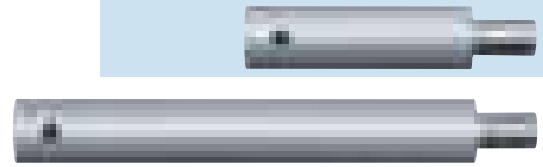

Extension rods  
 (12AAG202: 50mm, 12AAG203: 100mm)

## Styli

Unit: mm

### Standard stylus

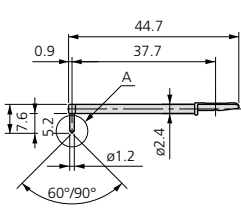
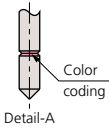

**12AAE882** (1µm)\*  
**12AAE924** (1µm)\*\*  
**12AAC731** (2µm)\*  
**12AAB331** (2µm)\*\*  
**12AAB403** (5µm)\*\*  
**12AAB415** (10µm)\*\*  
**12AAE883** (250µm)  
 ( ) : Tip radius  
 \*Tip angle: 60° \*\*Tip angle: 90°

### 2X long for deep hole

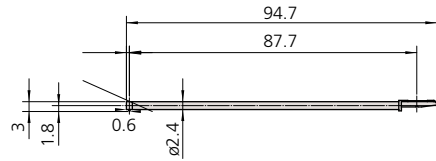

**12AAE898** (2µm)\*  
**12AAE914** (5µm)\*\*  
 ( ) : Tip radius  
 \*Tip angle: 60° \*\*Tip angle: 90°

### For small hole

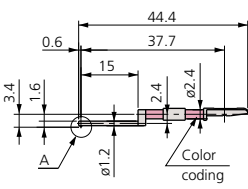
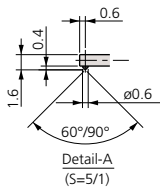

**12AAC732** (2µm)\*  
**12AAB404** (5µm)\*\*  
**12AAB416** (10µm)\*\*  
 ( ) : Tip radius  
 \*Tip angle: 60° \*\*Tip angle: 90°

### For small hole/2X long for deep hole

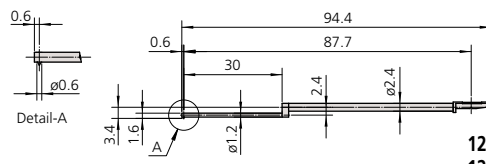

**12AAE892** (2µm)\*  
**12AAE908** (5µm)\*\*  
 ( ) : Tip radius  
 \*Tip angle: 60° \*\*Tip angle: 90°

### For extra-small hole

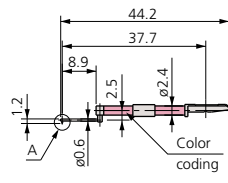
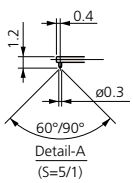

**12AAC733** (2µm)\*  
**12AAB405** (5µm)\*\*  
**12AAB417** (10µm)\*\*  
 ( ) : Tip radius  
 \*Tip angle: 60° \*\*Tip angle: 90°

### For small hole\*2

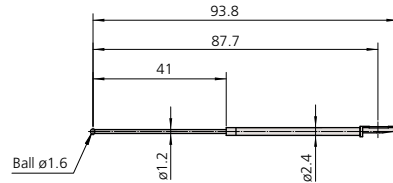

**12AAE884** (0.8mm)  
 ( ) : Tip radius

### For extra-minute hole

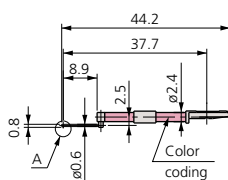
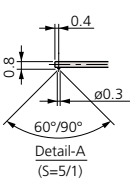

**12AAC734** (2µm)\*  
**12AAB406** (5µm)\*\*  
**12AAB418** (10µm)\*\*  
 ( ) : Tip radius  
 \*Tip angle: 60° \*\*Tip angle: 90°

### For ultra-small hole\*1\*2



**12AAJ662** (0.25mm)  
 ( ) : Tip radius

### For deep hole (2X long and 3X long)

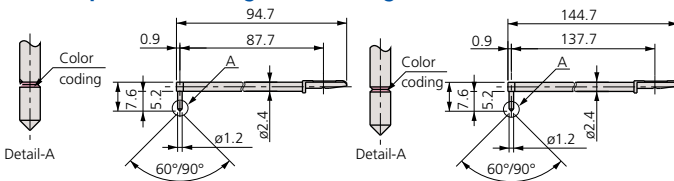

2X stylus  
**12AAC740** (2µm)\*  
**12AAB413** (5µm)\*\*  
**12AAB425** (10µm)\*\*  
 ( ) : Tip radius  
 \*Tip angle: 60° \*\*Tip angle: 90°

3X stylus  
**12AAC741** (2µm)\*  
**12AAB414** (5µm)\*\*  
**12AAB426** (10µm)\*\*  
 ( ) : Tip radius  
 \*Tip angle: 60° \*\*Tip angle: 90°

### For small-slotted hole

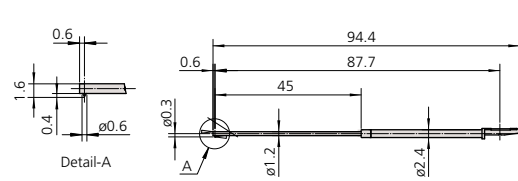

**12AAE938** (2µm)\*  
**12AAE940** (5µm)\*\*  
 ( ) : Tip radius  
 \*Tip angle: 60° \*\*Tip angle: 90°

\*1: For downward-facing measurement only

\*2: Used for calibration, a standard step gauge (No.178-611, option) is also required.

Tip radius	1µm	2µm	5µm	10µm	250µm
Color coding	White	Black	No color	Yellow	No notch or color



# Optional Styli for Surface Roughness Measurement

Compatible with SJ-410, SJ-500, SV-2100, SV-3200, SV-3000CNC,  
SV-M3000CNC, SV-C3200, SV-C4500 Series

## Styli

Unit: mm

### For deep groove (10mm)

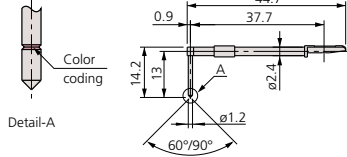

**12AAC735** (2μm)\*  
**12AAB409** (5μm)\*\*  
**12AAB421** (10μm)\*\*  
( ) : Tip radius  
\*Tip angle: 60° \*\*Tip angle: 90°

### For deep groove (20mm)<sup>\*1</sup>/2X Long for deep hole

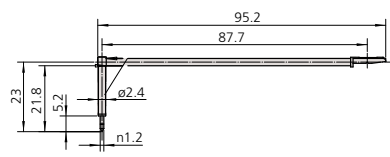

**12AAE893** (2μm)\*  
**12AAE909** (5μm)\*\*  
( ) : Tip radius  
\*Tip angle: 60° \*\*Tip angle: 90°

### For deep groove (20mm)

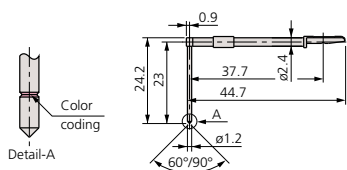

**12AAC736** (2μm)\*  
**12AAB408** (5μm)\*\*  
**12AAB420** (10μm)\*\*  
( ) : Tip radius  
\*Tip angle: 60° \*\*Tip angle: 90°

### For deep groove (40mm)<sup>\*1</sup>

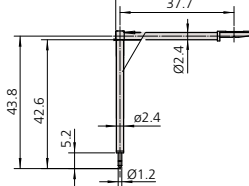

**12AAE895** (2μm)\*  
**12AAE911** (5μm)\*\*  
( ) : Tip radius  
\*Tip angle: 60° \*\*Tip angle: 90°

### For deep groove (30mm)

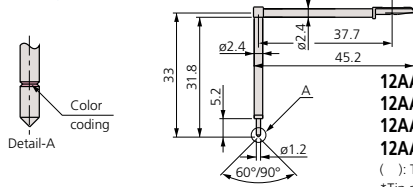

**12AAC737** (2μm)\*  
**12AAB335** (2μm)\*\*  
**12AAB407** (5μm)\*\*  
**12AAB419** (10μm)\*\*  
( ) : Tip radius  
\*Tip angle: 60° \*\*Tip angle: 90°

### For deep groove (30mm)<sup>\*1</sup>/2X Long for deep hole

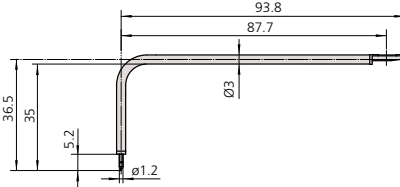

**12AAE894** (2μm)\*  
**12AAE910** (5μm)\*\*  
( ) : Tip radius  
\*Tip angle: 60° \*\*Tip angle: 90°

### For gear tooth

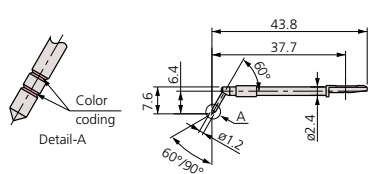

**12AAB339** (2μm)\*  
**12AAB410** (5μm)\*\*  
**12AAB422** (10μm)\*\*  
( ) : Tip radius  
\*Tip angle: 60° \*\*Tip angle: 90°

### For gear tooth<sup>\*1</sup>/2X Long for deep hole

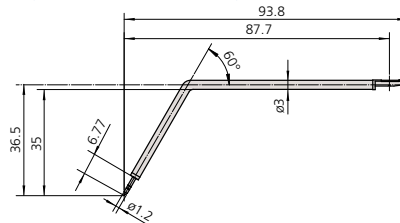

**12AAE896** (2μm)\*  
**12AAE912** (5μm)\*\*  
( ) : Tip radius  
\*Tip angle: 60° \*\*Tip angle: 90°

### For rolling circle waviness surface<sup>\*2</sup>

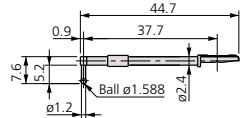

**12AAB338** (0.8mm)  
( ) : Tip radius

### For rolling circle waviness<sup>\*1</sup>/2X Long for deep hole<sup>\*2</sup>

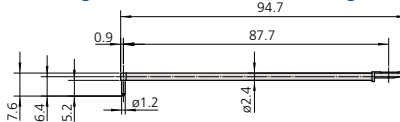

**12AAE886** (0.25mm)  
( ) : Tip radius

### For knife-edge detector

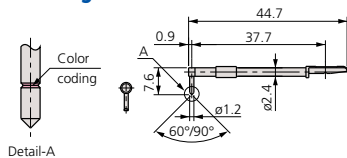

**12AAC738** (2μm)\*  
**12AAB411** (5μm)\*\*  
**12AAB423** (10μm)\*\*  
( ) : Tip radius  
\*Tip angle: 60° \*\*Tip angle: 90°

### For corner hole<sup>\*1</sup>/2X Long for deep hole

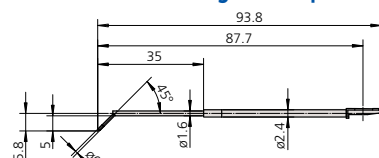

**12AAM601** (2μm)\*  
**12AAM603** (5μm)\*\*  
( ) : Tip radius  
\*Tip angle: 60° \*\*Tip angle: 90°

### For eccentric arm<sup>\*1</sup>

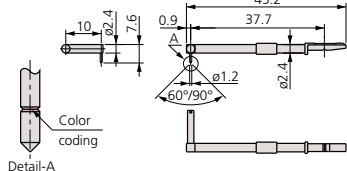

**12AAC739** (2μm)\*  
**12AAB412** (5μm)\*\*  
**12AAB424** (10μm)\*\*  
( ) : Tip radius  
\*Tip angle: 60° \*\*Tip angle: 90°

### For bottom surface

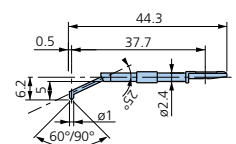

**12AAE899** (2μm)\*  
**12AAE915** (5μm)\*\*  
( ) : Tip radius  
\*Tip angle: 60° \*\*Tip angle: 90°

Tip radius	1μm	2μm	5μm	10μm	250μm
Color coding	White	Black	No color	Yellow	No notch or color

\*1: For downward-facing measurement only

\*2: Used for calibration, a standard step gauge (No.178-611, option) is also required.

# Optional Accessories for Automatic Measurement

Compatible with SV-3200, SV-C3200, SV-C4500, CS-3200 and CNC Models

## Y-axis table\*: 178-097

A Y-axis table for both positioning and capable of 3D surface roughness measurement when used with optional software FTPK-PRO or MCubeMap.\*\*  
\* Not supporting Y-axis measurements. \*\* Only for 178-096



	178-097	178-096
Travel range	8" (200mm)	4" (100mm)
Resolution	1.97µin (0.05µm)	1.97µin (0.05µm)
Positioning accuracy	±3µm	±1µm
Drive speed	Max. 3.15"/s (80mm/s)	Max. .78"/s (20mm/s)
Maximum load	110 lbs (50kg)	33 lbs (50kg)
Mass	62 lbs (28kg)	68 lbs (31kg)

## θ2-axis table: 178-078\*

You can measure multiple points on a cylindrical workpiece and automate front/rear-side measurement.

\* θ2-axis mounting plate (12AAE718) is required when directly installing on the base of the SV-3100.



Displacement	360°
Resolution	0.0072°
Maximum load (loading moment)	8.8 lbs (4kg) (343 N·cm or less)
Rotational speed	Max. 18°/s
Mass	11 lbs (5kg)

## Quick chuck: 211-032

This chuck is useful when measuring small workpieces. You can easily clamp them with its knurled ring.



Retention range	Inner latch	OD: ø.04 - 1.42" (1 - 36mm)
	Inner latch	ID: ø.55 - 2.76" (14 - 70mm)
	Outer latch	OD: ø.04 - 2.95" (1 - 75mm)
Dimensions	ø 4.65 x 1.61" (118 x 41mm)	
Mass	2.6 lbs (1.2kg)	

## θ1-axis table: 12AAD975\*

For efficient measurement in the axial/transverse directions. When measuring a cylindrical workpiece, automatic alignment can be performed in combination with the Y-axis table.

\* θ1-axis mounting plate (12AAE630) is required when directly installing on the base of the SV-3100.

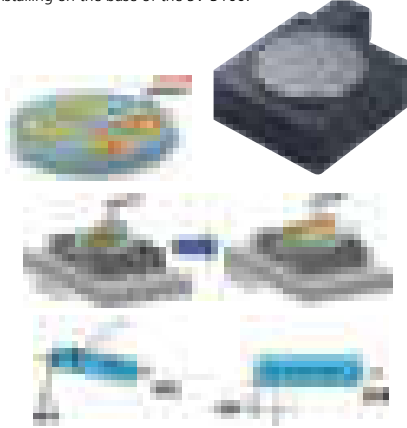

Displacement	360°
Resolution	0.004°
Maximum load	26.5 lbs (12kg)
Rotational speed	Max. 10°/s
Mass	15 lbs (7kg)

## Auto-leveling table: 178-087

This is a stage that performs fully automatic leveling as measurement starts, freeing the user from this troublesome operation. Fully automatic leveling can be done quickly by anyone. In addition, the operation is easy and reliable.



Inclination adjustment angle	±2°
Maximum load	15 lbs (7kg)
Table dimensions	5.1 x 3.9" (130 x 100mm)
Mass	7.7 lbs (3.5kg)

## Micro-chuck: 211-031

This chuck is suitable for clamping extra-small diameter workpieces (ø1mm or less), which cannot be retained with the centering chuck.



Retention range	OD: ø 0 - .06" (0 - 1.5mm)
Dimensions	ø 4.65 x 1.9" (118 x 48.5mm)
Mass	1.3 lbs (0.6kg)

## Examples of optimal combinations of accessories for CNC models

Optional accessory \ Function	Y-axis Table	θ1 Table	θ2 Table
Automatic leveling	—	—	—
Automatic alignment (Patent registered: Japan)	●	●	—
Multiple workpiece batch measurement	▲	—	—
Measurement in the Y-axis direction	●	—	—
Oblique measurement of XY plane **	●	—	—
Outside 3D surface roughness measurement/evaluation **	●	—	—
Multiple-piece measurement in the Y-axis direction (Positioning in the Y-axis direction)	●	—	—
Multiple-piece measurement in the radius direction (Positioning in the rotating direction of XY plane)	▲	●	—
Tracking measurement in the Z-axis direction *	—	—	—
Inclined surface measurement in the X-axis direction	▲	—	—
Inclined hole inside measurement in the X-axis direction	▲	—	—
Multiple cylinder generatrix line measurement	▲	—	●
Measurement of both top and bottom surfaces	▲	—	●
Rotary positioning of large workpiece ***	—	—	—
Upward/downward and frontward/backward measurement of large workpiece ***	—	—	—

\* : Applicable only to form/contour measurement

\*\* : Applicable only to surface roughness measurement

\*\*\* : Applicable only for SV-M3000CNC

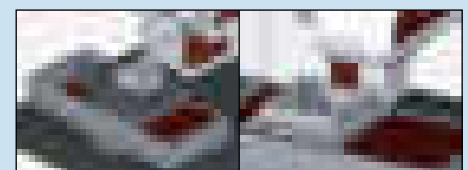
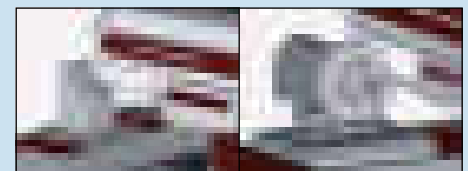



# Quick Guide to Precision Measuring Instruments

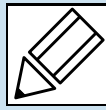

## Surftest (Surface Roughness Testers)

- JIS B 0601: 2001 Geometric Product Specifications (GPS)–Surface Texture: Profile method– Terms, definitions, and surface texture parameters
- JIS B 0632: 2001 Geometric Product Specifications (GPS)–Surface Texture: Profile method– Metrological characterization of phase-correct filters
- JIS B 0633: 2001 Geometric Product Specifications (GPS)–Surface Texture: Profile method– Rules and procedures for the assessment of surface texture
- JIS B 0651: 2001 Geometric Product Specifications (GPS)–Surface Texture: Profile method– Nominal characteristics of contact (stylus) instruments

### Nominal Characteristics of Contact (Stylus) Instruments

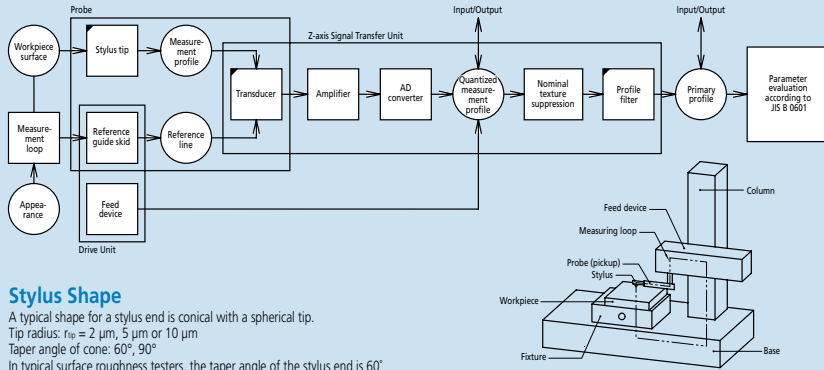

#### Stylus Shape

A typical shape for a stylus end is conical with a spherical tip.  
 Tip radius:  $r_{tp} = 2 \mu\text{m}, 5 \mu\text{m}$  or  $10 \mu\text{m}$   
 Taper angle of cone:  $60^\circ, 90^\circ$   
 In typical surface roughness testers, the taper angle of the stylus end is  $60^\circ$  unless otherwise specified.

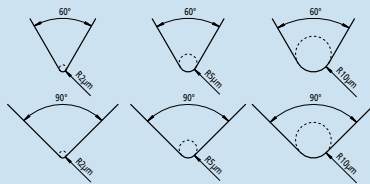

#### Static Measuring Force

Nominal radius of curvature of stylus tip: $\mu\text{m}$	Static measuring force at the mean position of stylus: mN	Tolerance on static measuring force variations: mN/ $\mu\text{m}$
2	0.75	0.035
5	0.75 (4.0) Note 1	0.2
10		

Note 1: The maximum value of static measuring force at the average position of a stylus is to be  $4.0\text{mN}$  for a special structured probe including a replaceable stylus.

### Relationship between Cutoff Value and Stylus Tip Radius

The following table lists the relationship between the roughness profile cutoff value  $\lambda_c$ , stylus tip radius  $r_{tp}$ , and cutoff ratio  $\lambda_c/\lambda_s$ .

$\lambda_c$ mm	$\lambda_s$ $\mu\text{m}$	$\lambda_c/\lambda_s$	Maximum $r_{tp}$ $\mu\text{m}$	Maximum sampling length $\mu\text{m}$
0.08	2.5	30	2	0.5
0.25	2.5	100	2	0.5
0.8	2.5	300	2 Note 1	0.5
2.5	8	300	5 Note 2	1.5
8	25	300	10 Note 2	5

Note 1: For a surface with  $Ra > 0.5 \mu\text{m}$  or  $Rz > 3 \mu\text{m}$ , a significant error will not usually occur in a measurement even if  $r_{tp} = 5 \mu\text{m}$ .  
 Note 2: If a cutoff value  $\lambda_c$  is  $\geq 2.5 \text{ mm}$  or  $8 \text{ mm}$ , attenuation of the signal due to the mechanical filtering effect of a stylus with the recommended tip radius appears outside the roughness profile pass band. Therefore, a small error in stylus tip radius or shape does not affect parameter values calculated from measurements. If a specific cutoff ratio is required, the ratio must be defined.

### Metrological Characterization of Phase Correct Filters

A profile filter is a phase-correct filter without phase delay (cause of profile distortion dependent on wavelength). The weight function of a phase-correct filter shows a normal (Gaussian) distribution in which the amplitude transmission is 50% at the cutoff wavelength.

JIS B 0632: 2001 (ISO 11562: 1996)

### Surface Profiles

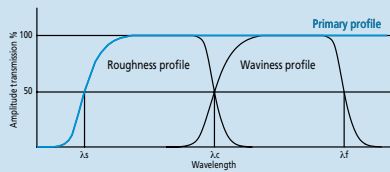

JIS B 0601: 2001 (ISO 4287: 1997)

#### Primary Profile

Profile obtained from the measured profile by applying a low-pass filter with cutoff value  $\lambda_s$ .

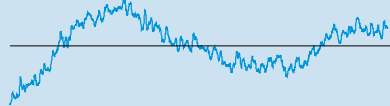

#### Roughness Profile

Profile obtained from the primary profile by suppressing the longer wavelength components using a high-pass filter of cutoff value  $\lambda_c$ .



#### Waviness Profile

Profile obtained by applying a band-pass filter to the primary profile to remove the longer wavelengths above  $\lambda_l$  and the shorter wavelengths below  $\lambda_c$ .

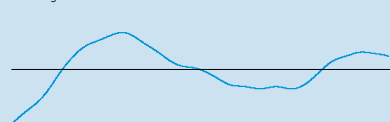

### Definition of Parameters

JIS B 0601: 2001 (ISO 4287: 1997)

#### Amplitude Parameters (peak and valley)

- Maximum peak height of the primary profile  $P_p$
- Maximum peak height of the roughness profile  $R_p$
- Maximum peak height of the waviness profile  $W_p$
- Largest profile peak height  $Z_p$  within a sampling length

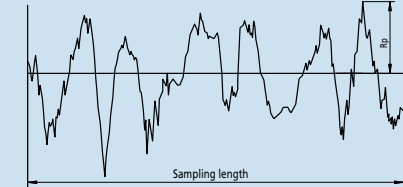

- Maximum valley depth of the primary profile  $P_v$
- Maximum valley depth of the roughness profile  $R_v$
- Maximum valley depth of the waviness profile  $W_v$
- Largest profile valley depth  $Z_v$  within a sampling length

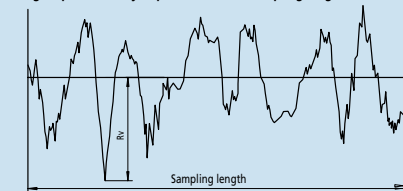

- Maximum height of the primary profile  $P_z$
- Maximum height of the roughness profile  $R_z$
- Maximum height of the waviness profile  $W_z$

Sum of height of the largest profile peak height  $Z_p$  and the largest profile valley depth  $Z_v$  within a sampling length

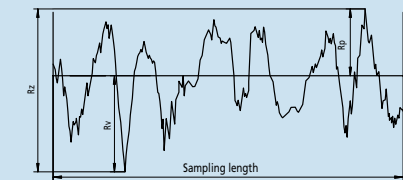

In Old JIS and ISO 4287-1: 1984,  $R_z$  was used to indicate the "ten point height of irregularities." Care must be taken because differences between results obtained according to the existing and old standards are not always negligibly small. (Be sure to check whether the drawing instructions conform to existing or old standards.)

- Mean height of the primary profile elements  $P_c$
- Mean height of the roughness profile elements  $R_c$
- Mean height of the waviness profile elements  $W_c$

Mean value of the profile element heights  $Z_t$  within a sampling length

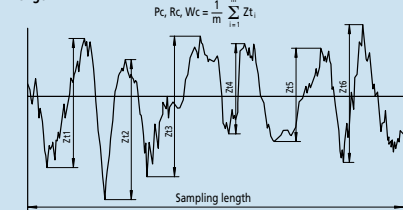

- Total height of the primary profile  $P_t$
- Total height of the roughness profile  $R_t$
- Total height of the waviness profile  $W_t$

Sum of the height of the largest profile peak height  $Z_p$  and the largest profile valley depth  $Z_v$  within the evaluation length

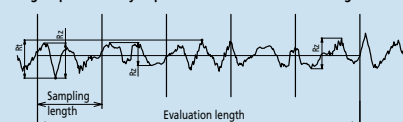

### Data Processing Flow

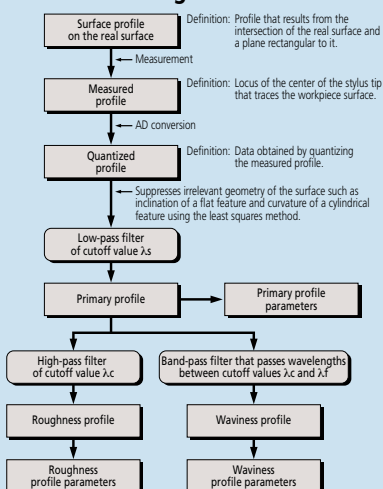

## Amplitude Parameters (average of ordinates)

Arithmetical mean deviation of the primary profile  $P_a$   
 Arithmetical mean deviation of the roughness profile  $R_a$   
 Arithmetical mean deviation of the waviness profile  $W_a$   
 Arithmetic mean of the absolute ordinate values  $Z(x)$  within a sampling length

$$P_a, R_a, W_a = \frac{1}{l} \int_0^l |Z(x)| dx$$

with  $l$  as  $l_p, l_r$  or  $l_w$  according to the case.

Root mean square deviation of the primary profile  $P_q$   
 Root mean square deviation of the roughness profile  $R_q$   
 Root mean square deviation of the waviness profile  $W_q$   
 Root mean square value of the ordinate values  $Z(x)$  within a sampling length

$$P_q, R_q, W_q = \sqrt{\frac{1}{l} \int_0^l Z^2(x) dx}$$

with  $l$  as  $l_p, l_r$  or  $l_w$  according to the case.

Skewness of the primary profile  $P_{sk}$   
 Skewness of the roughness profile  $R_{sk}$   
 Skewness of the waviness profile  $W_{sk}$

Quotient of the mean cube value of the ordinate values  $Z(x)$  and the cube of  $P_q, R_q$ , or  $W_q$ , respectively, within a sampling length

$$R_{sk} = \frac{1}{R_q^3} \left[ \frac{1}{l_r} \int_0^{l_r} Z^3(x) dx \right]$$

The above equation defines  $R_{sk}$ .  $P_{sk}$  and  $W_{sk}$  are defined in a similar manner.  $P_{sk}, R_{sk}$ , and  $W_{sk}$  are measures of the asymmetry of the probability density function of the ordinate values.

Kurtosis of the primary profile  $P_{ku}$   
 Kurtosis of the roughness profile  $R_{ku}$   
 Kurtosis of the waviness profile  $W_{ku}$

Quotient of the mean quartic value of the ordinate values  $Z(x)$  and the fourth power of  $P_q, R_q$ , or  $W_q$ , respectively, within a sampling length

$$R_{ku} = \frac{1}{R_q^4} \left[ \frac{1}{l_r} \int_0^{l_r} Z^4(x) dx \right]$$

The above equation defines  $R_{ku}$ .  $P_{ku}$  and  $W_{ku}$  are defined in a similar manner.  $P_{ku}, R_{ku}$ , and  $W_{ku}$  are measures of the sharpness of the probability density function of the ordinate values.

## Spacing Parameters

Mean width of the primary profile elements  $P_{sm}$   
 Mean width of the roughness profile elements  $R_{sm}$   
 Mean width of the waviness profile elements  $W_{sm}$

Mean value of the profile element widths  $X_s$  within a sampling length

$$P_{sm}, R_{sm}, W_{sm} = \frac{1}{m} \sum_{i=1}^m X_{s_i}$$

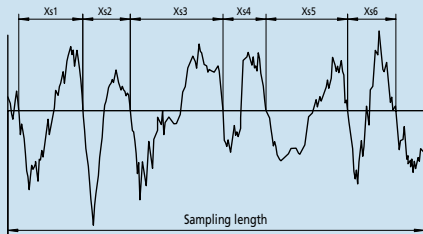

## Hybrid Parameters

Root mean square slope of the primary profile  $P_{\Delta q}$   
 Root mean square slope of the roughness profile  $R_{\Delta q}$   
 Root mean square slope of the waviness profile  $W_{\Delta q}$

Root mean square value of the ordinate slopes  $dZ/dX$  within a sampling length

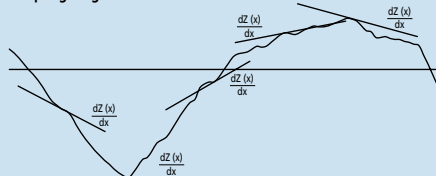

## Curves, Probability Density Function, and Related Parameters

Material ratio curve of the profile (Abbott-Firestone curve)

Curve representing the material ratio of the profile as a function of section level  $c$

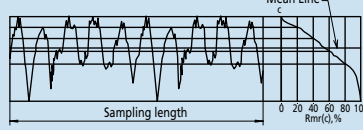

Material ratio of the primary profile  $P_{mr}(c)$   
 Material ratio of the roughness profile  $R_{mr}(c)$   
 Material ratio of the waviness profile  $W_{mr}(c)$

Ratio of the material length of the profile elements  $MI(c)$  at a given level  $c$  to the evaluation length

$$P_{mr}(c), R_{mr}(c), W_{mr}(c) = \frac{MI(c)}{l_n}$$

Section height difference of the primary profile  $P_{dc}$   
 Section height difference of the roughness profile  $R_{dc}$   
 Section height difference of the waviness profile  $W_{dc}$

Vertical distance between two section levels of a given material ratio

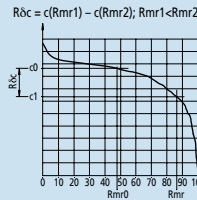

Relative material ratio of the primary profile  $P_{mr}$   
 Relative material ratio of the roughness profile  $R_{mr}$   
 Relative material ratio of the waviness profile  $W_{mr}$

Material ratio determined at a profile section level  $R_0c$  (or  $P_0c$  or  $W_0c$ ), related to the reference section level  $c_0$

$$P_{mr}, R_{mr}, W_{mr} = P_{mr}(c_1), R_{mr}(c_1), W_{mr}(c_1)$$

where  $c_1 = c_0 - R_0c$  ( $P_0c, W_0c$ )  
 $c_0 = c(P_{m0}, R_{m0}, W_{m0})$

Probability density function (profile height amplitude distribution curve)

Sample probability density function of the ordinate  $Z(x)$  within the evaluation length

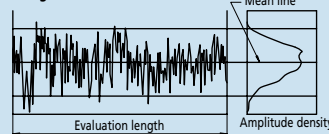

## JIS Specific Parameters

Ten-point height of irregularities,  $Rz_{15}$

Sum of the absolute mean height of the five highest profile peaks and the absolute mean depth of the five deepest profile valleys, measured from the mean line within the sampling length of a roughness profile. This profile is obtained from the primary profile using a phase-correct band-pass filter with cutoff values of  $f_c$  and  $f_s$ .

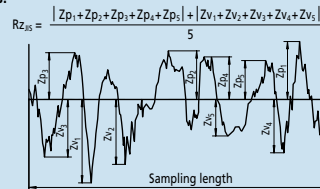

Symbol	Used profile
$Rz_{15S2}$	Surface profile as measured
$Rz_{15S4}$	Roughness profile derived from the primary profile using a phase-correct high-pass filter

Arithmetic mean deviation of the profile  $Ra_{15}$

Arithmetic mean of the absolute values of the profile deviations from the mean line within the sampling length of the roughness profile (75%). This profile is obtained from a measurement profile using an analog high-pass filter with an attenuation factor of 12db/octave and a cutoff value of  $f_c$ .

$$Ra_{15} = \frac{1}{l_n} \int_0^{l_n} |Z(x)| dx$$

## Sampling Length for Surface Roughness Parameters

JIS B 0633: 2001 (ISO 4288: 1996)

Table 1: Sampling lengths for aperiodic profile roughness parameters ( $R_a, R_q, R_{sk}, R_{ku}, R_{\Delta q}$ ), material ratio curve, probability density function, and related parameters

$R_a$ $\mu m$	Sampling length $l_r$ mm	Evaluation length $l_n$ mm
$(0.006) < R_a \leq 0.02$	0.08	0.4
$0.02 < R_a \leq 0.1$	0.25	1.25
$0.1 < R_a \leq 2$	0.8	4
$2 < R_a \leq 10$	2.5	12.5
$10 < R_a \leq 80$	8	40

Table 2: Sampling lengths for aperiodic profile roughness parameters ( $R_z, R_v, R_p, R_c, R_t$ )

$R_z$ $R_{z1max}$ $\mu m$	Sampling length $l_r$ mm	Evaluation length $l_n$ mm
$(0.025) < R_z, R_{z1max} \leq 0.1$	0.08	0.4
$0.1 < R_z, R_{z1max} \leq 0.5$	0.25	1.25
$0.5 < R_z, R_{z1max} \leq 10$	0.8	4
$10 < R_z, R_{z1max} \leq 50$	2.5	12.5
$50 < R_z, R_{z1max} \leq 200$	8	40

1)  $R_z$  is used for measurement of  $R_z, R_v, R_p, R_c$ , and  $R_t$ .  
 2)  $R_{z1max}$  only used for measurement of  $R_{z1max}, R_{v1max}, R_{p1max}$ , and  $R_{c1max}$ .

Table 3: Sampling lengths for measurement of periodic roughness profile roughness parameters and periodic or aperiodic profile parameter  $R_{sm}$

$R_{sm}$ mm	Sampling length $l_r$ mm	Evaluation length $l_n$ mm
$0.013 < R_{sm} \leq 0.04$	0.08	0.4
$0.04 < R_{sm} \leq 0.13$	0.25	1.25
$0.13 < R_{sm} \leq 0.4$	0.8	4
$0.4 < R_{sm} \leq 1.3$	2.5	12.5
$1.3 < R_{sm} \leq 4$	8	40

## Procedure for determining a sampling length if it is not specified

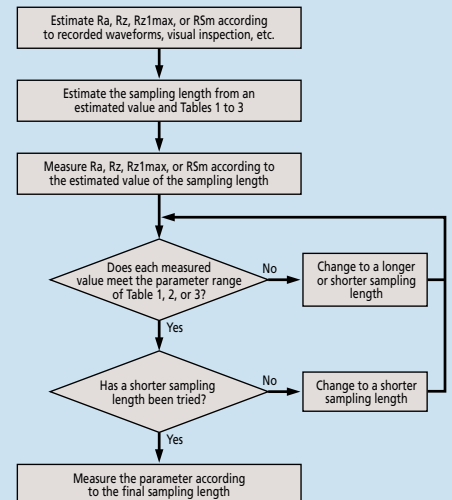

Table 1. Procedure for determining the sampling length of an aperiodic profile if it is not specified.

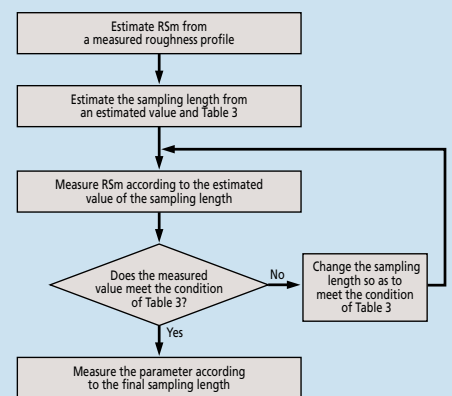

Table 2. Procedure for determining the sampling length of a periodic profile if it is not specified.

# Contracer CV-2100

## SERIES 218 — Contour Measuring Instruments

### FEATURES

- Newly designed high-precision digital ARC scale improves the Z-axis accuracy and resolution.
- Quick-release grip handle allows for rapid traverse in column Z-axis for CV-2100M4.
- Key operation buttons are now mounted onto the X-axis drive unit, eliminating wired remote box.
- X-axis traverse speed has been greatly improved to 20mm/s allowing quick positioning and set-up time.
- New added function for automatic stylus up/down means high-volume repetitive measurements are now capable with part programming.
- Z-axis detector measuring range has been improved to 50mm for both models.
- CV-2100N4 model can be mounted to optional manual column stand or custom fixture supplied by end user.

CV-2100M4 with personal computer system and software



Connected to a personal computer, the FORMTRACEPAK V5 contour analysis program provides various modes of measurement and analysis.  
\*Printer not included

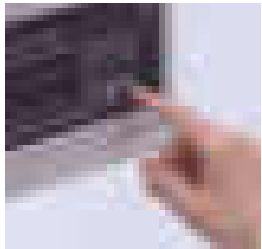

Centralized front control panel

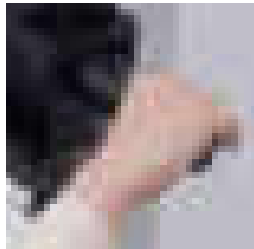

Quick-vertical motion handle

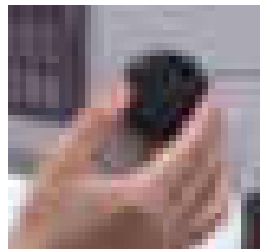

X-axis jog shuttle

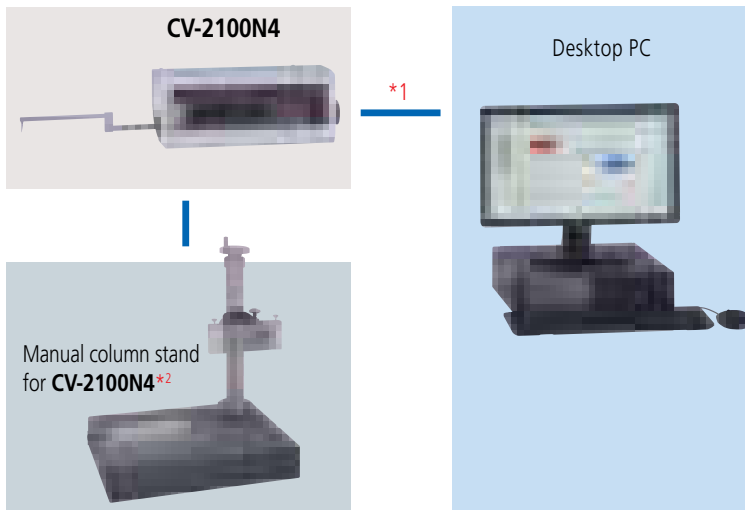

\*1: If the CV-2100N4 is operated without the dedicated manual stand, the measuring range of the Z-axis might be reduced, depending on the installation conditions. If you are considering using the CV-2100N4 without the stand, contact your local Mitutoyo sales office for advice.

\*2: Optional accessory 218-042 manual column stand

### Technical Data

X1-axis	
Measuring range:	4" (100mm) (CV-2100)
Resolution:	3.93µin (0.1µm)
Measurement method:	STVC-10Z
Drive speed:	0-.79"/s (0-20mm/s)
Measuring speed:	.000787"/s, .2"/s (.02, 5mm/s)
Measuring direction:	Forward / Backward
Traverse linearity:	98.4µin/4" (2.5µm/100mm) (CV-2100)
Linear displacement:	±(100+20L)µin ±(2.5+2L/100)µm
	* L = Drive length (mm)
Inclining range:	±45°
Z2-axis (column)	
Column type:	Manual (M4 type)
Vertical travel:	13.8" (350mm) (M4 type)

Z1-axis (detector unit)	
Measuring range:	2" (50mm)
Resolution:	3.93µin (0.1µm)
Measurement method:	Digital arc scale
Linear displacement:	±(100+100h)µin ±(2.5+10.1H)µm
Accuracy (at 20°C)	*H: Measurement height from the horizontal position within ±1" (±25mm)
Stylus up/down operation:	Arc movement
Face of stylus:	Downward
Measuring force:	30±10mN (3gf)
Traceable angle:	Ascent: 77°, descent: 87° (using the standard stylus provided and depending on the surface roughness)

Stylus tip	Radius: 25µm, carbide tip
Base size (W x H):	23.6 x 17.7" (600 x 450mm)
Base material:	Granite
Mass:	321 lbs (145.8kg) (CV-2100M4),
Power supply:	100 – 240VAC ±10%, 50/60Hz
Power consumption:	30W (main unit only)

### Highly accurate arc scale



This scale directly tracks the arc trajectory of the stylus tip so that the most accurate compensation can be applied to the scale output, which leads to higher accuracy and resolution.

# Contracer CV-2100

## SERIES 218 — Contour Measuring Instruments

### Optional Accessories

- 218-042:** Column stand for CV-2100N4  
(vertical travel: 250mm, inclination:  $\pm 45^\circ$ )
- 218-001:** Cross-travel table (XY range: 100 x 50mm)
- 218-011:** Cross-travel table (XY range: 4" x 2")
- 218-041:** Cross-travel table (XY range: 50 x 25mm)
- 218-051:** Cross-travel table (XY range: 2" x 1")
- 218-002:** Rugged table
- 176-107:** Holder with clamp
- 218-003:** Rotary vise (heavy-duty type)
- 172-144:** Rotary vise
- 172-234:** V-block with clamp  
(Max. workpiece dia.: 50mm)
- 172-378:** V-block with clamp  
(Max. workpiece dia.: 25mm)
- 172-197:** Swivel center support
- 172-142:** Center support
- 172-143:** Center support riser
- 998862:** Pin gage unit for calibration (mm)
- 998861:** Pin gage unit for calibration (inch)
- :** Arms and styli (See page J-32/33.)
- 12AAG175:** Calibration table
- 178-047:** 3-axis adjustment table

### SPECIFICATIONS

Model		CV-2100M4	CV-2100N4
Order No.		218-643A	218-623A
Measurement range	X-axis	4" (100mm)	
	Z1-axis (detector unit)	2" (50mm)	
Z2-axis (column) travel range		13.8" (350mm)	—
X-axis inclination angle		$\pm 45^\circ$	—
Resolution	X-axis	3.93 $\mu$ m (0.1 $\mu$ m)	
	Z1-axis	3.93 $\mu$ m (0.1 $\mu$ m)	
Drive method	X-axis	Motorized drive 0 - 0.79in/s (0 - 20mm/s)	
	Z2-axis (column)	Manual (quick up-and-down motion, fine feed)	—
Measuring speed		.00078 - .2"/sec (0.02 - 5mm/s)	
Linearity accuracy (X-axis horizontal orientation)		98.4 $\mu$ m/4in (2.5 $\mu$ m/100mm)	
Accuracy (20°C)	X-axis	$\pm(100+20L)\mu$ m [ $\pm(2.5+0.02L)\mu$ m] L = Measurement Length (mm)	
	Z1-axis	$\pm(100+ 100H )\mu$ m [ $\pm(2.5+ 0.1H )\mu$ m] H = Measurement height from horizontal position within 1" ( $\pm 25$ mm)	
Measurement direction		Forward / Backward	
Measurement surface direction		Downward	
Measuring force		(3gf) (30 $\pm$ 10mN)	
Stylus traceable angle (Standard accessory stylus)		Ascent 77°, Descent 87° (Depends on the surface condition)	
External dimensions (WxDxH)		29.3 x 17.7 x 34.8" (745x450x885mm)	25.6 x 5.63 x 5.45" (651x143x138.5mm)
Mass		321.43 lbs (145.8 kg)	12.78 lbs (5.8 kg)

### DIMENSIONS

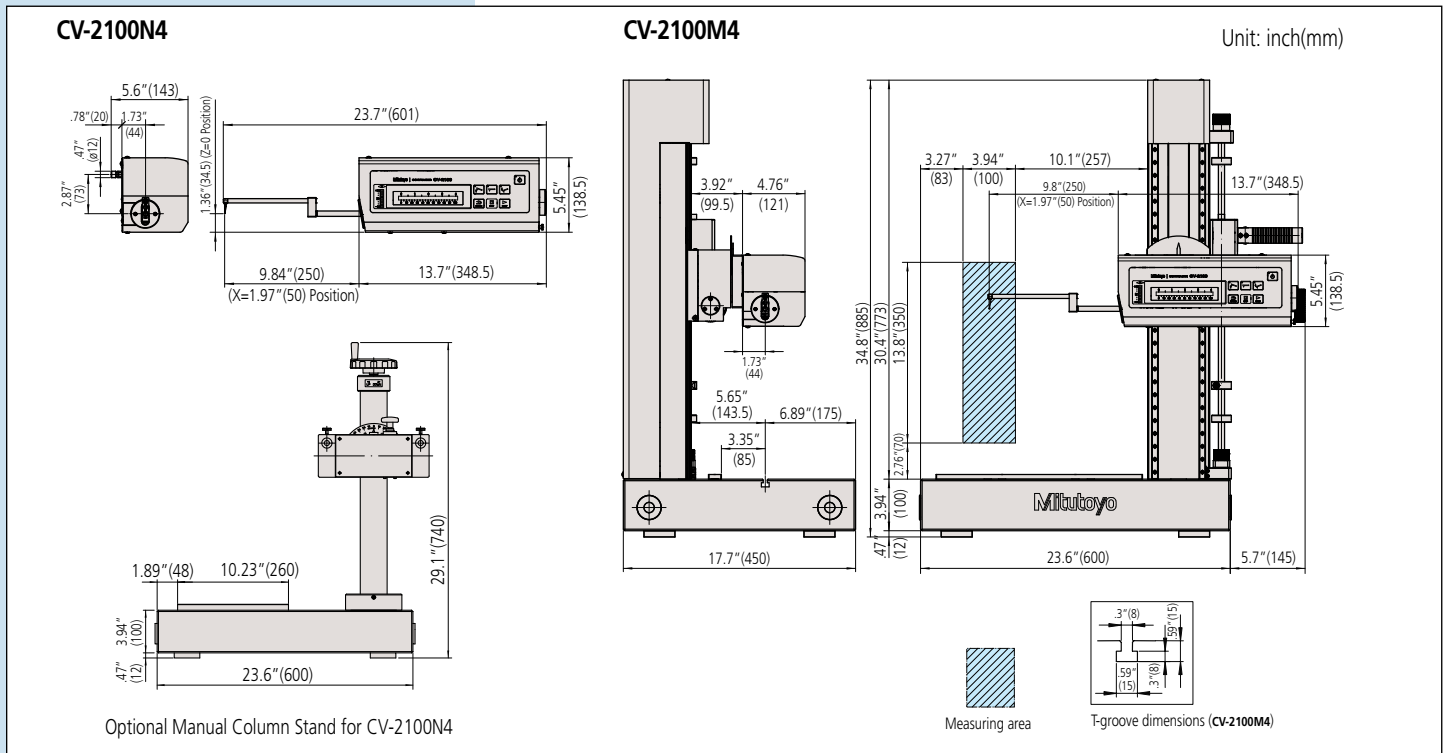

# Contracer CV-3200 / CV-4500

SERIES 218 — Contour Measuring Instruments



CV-3200L4 (with options)



CV-3200S4 with personal computer system and software

## CV-3200 FEATURES

- Dramatically increased drive speed (X axis: 80 mm/s, Z2 axis: 20 mm/s) further reduces total measurement time.
- In order to maintain the traverse linearity specification for an extended period of time, Mitutoyo has adopted highly rigid ceramic guides that combine the characteristics of smallest secular change and remarkable resistance to abrasion.
- With the support for a wide range of optional peripherals designed for use with the CNC models enables simplified CNC measurement.
- The drive unit (X-axis) and column (Z2-axis) are equipped with a high-accuracy linear encoders (ABS type on Z2-axis). This improves reproducibility of continuous automatic measurement of small holes in the vertical direction and repeated measurement of parts which are difficult to position.
- A newly designed straight arm reduces interference on the workpiece and expands the measurement range in the Z1 axis (height) direction.
- One-touch mounting and removal of the arm.
- X1-axis accuracy:  $\pm(0.8+0.01L)\mu\text{m}^*$   
Z1-axis accuracy:  $\pm(1.6+12HI/100)\mu\text{m}$   
Designed to handle workpieces calling for high accuracy.

\* CV-3200S4, H4, W4 types, L = Drive length, H = Measurement height (mm)

With the addition of a new function for continuously measuring top and bottom faces, the variable measuring force function has become more useful, enabling a wide variety of efficient, high-precision measurements.

## CV-4500 FEATURES

- When combined with the double cone-end stylus (a new product with diametrically opposed contact points), the instrument can continuously measure in the upward and downward directions without the need to change the arm orientation or reset the workpiece fixturing.
- The measuring force can be switched among five levels (upward and downward) from the data-processing program (Formtracepak).
- High-precision and high-speed drive has been achieved, significantly improving measurement efficiency.
- A newly designed straight arm has reduced interference on the workpiece and expanded the measurement range in the Z1 axis (height) direction.
- One-touch mounting and removal of the arm.



## Technical Data

### X-axis

Measuring range: 4" (100mm) or 8" (200mm)  
Resolution: 1.97 $\mu\text{m}$  (0.05 $\mu\text{m}$ )  
Measurement method: Reflective-type linear encoder  
Drive speed: 3.15"/s (80mm/s) and manual  
Measuring speed: .0008 - .79"/s (0.02 - 20mm/s)\*

\*Recommended speed: under 5mm/s  
If using higher speed, stylus tip may be chipped and/or accuracy may be worse, depending on surface condition.

Measuring direction: Forward / Backward  
Traverse linearity: 32 $\mu\text{m}/4"$ , 80 $\mu\text{m}/8"$   
(0.8 $\mu\text{m}/100\text{mm}$ , 2 $\mu\text{m}/200\text{mm}$ )  
\*with the X axis in horizontal orientation

Linear displacement accuracy (at 20°C): (31.5+10L) $\mu\text{m}$   
{ $\pm(0.8+0.01L)\mu\text{m}$ } (CV-3200S4, H4, W4, L4)  
(32+10L) $\mu\text{m}$   
{ $\pm(0.8+0.01L)\mu\text{m}$ } (CV-4500S4, H4, W4, L4)  
(31.5+20L) $\mu\text{m}$   
{ $\pm(0.8+0.02L)\mu\text{m}$ } (CV-3200S8, H8, W8, L8)  
(32+20L) $\mu\text{m}$   
{ $\pm(0.8+0.02L)\mu\text{m}$ } (CV-4500S8, H8, W8, L8)  
\* L = Drive length (mm)

Inclining range:  $\pm 45^\circ$   
Z2-axis (column)  
Vertical travel: 10" (300mm) or 20" (500mm)  
Resolution: 39.4 $\mu\text{m}$  (1 $\mu\text{m}$ )  
Measurement method: ABSOLUTE linear encoder  
Drive speed: 0 - 1.2"/s (0 - 30mm/s) and manual

### Z1-axis (detector unit)

Measuring range:  $\pm 1.2"$  ( $\pm 30\text{mm}$ )  
Resolution: 1.57 $\mu\text{m}$  (0.04 $\mu\text{m}$ ) (CV-3200 series),  
.78 $\mu\text{m}$  (0.02 $\mu\text{m}$ ) (CV-4500 series)

Measurement method: Rotary arc encoder (CV-3200 series),  
(CV-4500 series)

Linear displacement Accuracy (at 20°C):  $\pm(63+120HI)\mu\text{m}$  ( $\pm(1.4+12HI/100)\mu\text{m}$ ) (CV-3200 series)  
 $\pm(32+120HI)\mu\text{m}$  ( $\pm(0.8+12HI/100)\mu\text{m}$ ) (CV-4500 series)  
\*H: Measurement height from the horizontal position (mm)

Stylus up/down operation: Arc movement  
Face of stylus: Upward/downward  
Measuring force: 30mN (CV-3200)  
Measuring force: 10, 20, 30, 40, 50mN (CV-4500)  
(Specified from the data-processing program)

Formtracepak  
Traceable angle: Ascent: 77°, descent: 83°  
(using the standard stylus provided and depending on the surface roughness)

Stylus tip Radius: 25 $\mu\text{m}$ , carbide tip  
Base size (W x H): 17.7 x 23.6" (450 x 600mm) or  
39.4 x 17.7" (1000 x 450mm)

Base material: Granite  
Power supply: 100 - 240VAC  $\pm 10\%$ , 50/60Hz  
Power consumption: 400W (main unit only)

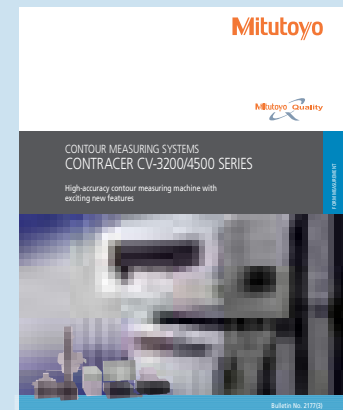

Refer to Bulletin No. (2177) for more details.



# Contracer CV-3200 / CV-4500

## SERIES 218 — Contour Measuring Instruments

### SPECIFICATIONS

Model No.	CV-3200S4	CV-3200H4	CV-3200W4	CV-3200L4
Order No. (inch)	<b>218-491-10A</b>	<b>218-492-10A</b>	<b>218-493-10A</b>	<b>218-494-10A</b>
Model No.	CV-4500S4	CV-4500H4	CV-4500W4	CV-4500L4
Order No. (inch)	<b>218-451-10A</b>	<b>218-452-10A</b>	<b>218-453-10A</b>	<b>218-454-10A</b>
X1-axis measuring range	4" (100mm)	4" (100mm)	4" (100mm)	4" (100mm)
Vertical travel	12" (300mm) power column	20" (500mm) power column	20" (500mm) power column	27.6" (700mm) power column
Granite base size (WxD)	23.6 x 17.7" (600 x 450mm)	23.6 x 17.7" (600 x 450mm)	39.4 x 17.7" (1000 x 450mm)	39.4 x 17.7" (1000 x 450mm)
Dimensions (main unit, WxDxH)	29.2 x 17.7 x 35.6" (741 x 450 x 905mm)	29.2 x 17.7 x 43.5" (741 x 450 x 1105mm)	45.5 x 19 x 46.3" (1156 x 482 x 1176mm)	45.5 x 19.4 x 56.5" (1156 x 492 x 1436mm)
Mass (main unit)	309 lbs (140kg)	331 lbs (150kg)	485 lbs (220kg)	595 lbs (270kg)
Model No.	CV-3200S8	CV-3200H8	CV-3200W8	CV-3200L8
Order No. (inch)	<b>218-496-10A</b>	<b>218-497-10A</b>	<b>218-498-10A</b>	<b>218-499-10A</b>
Model No.	CV-4500S8	CV-4500H8	CV-4500W8	CV-4500L8
Order No. (inch)	<b>218-456-10A</b>	<b>218-457-10A</b>	<b>218-458-10A</b>	<b>218-459-10A</b>
X1-axis measuring range	8" (200mm)	8" (200mm)	8" (200mm)	8" (200mm)
Vertical travel	12" (300mm) power column	20" (500mm) power column	20" (500mm) power column	27.6" (700mm) power column
Granite base size (WxD)	23.6 x 17.7" (600 x 450mm)	23.6 x 17.7" (600 x 450mm)	39.4 x 17.7" (1000 x 450mm)	39.4 x 17.7" (1000 x 450mm)
Dimensions (main unit, WxDxH)	30.2 x 19 x 38" (767 x 482 x 966mm)	30.2 x 19 x 46" (767 x 482 x 1166mm)	45.9 x 19 x 46.3" (1166 x 482 x 1176mm)	45.9 x 19.4 x 56.5" (1166 x 492 x 1436mm)
Mass (main unit)	309 lbs (140kg)	331 lbs (150kg)	485 lbs (220kg)	595 lbs (270kg)

### Collective Calibration Function

- A dedicated calibration gage enables the user to calibrate the instrument for Z-axis gain, symmetry, stylus-tip radius, etc., in a single procedure.

Calibration kit for CV-4500 series

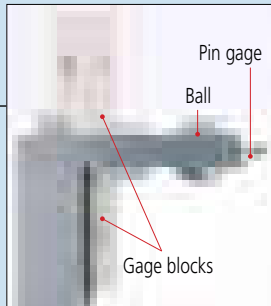

Calibration Kit:  
CV-4500: **12AAQ491**  
CV-3200: **12AAQ489** (not shown)

### Software

#### FORMTRACEPAK V5

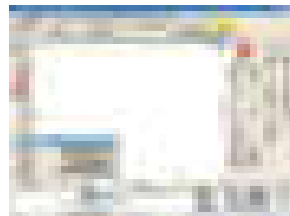

Measurement Control Screen

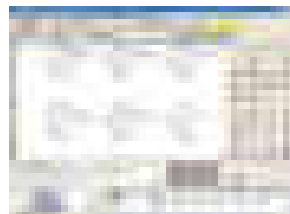

Profile Analysis Screen

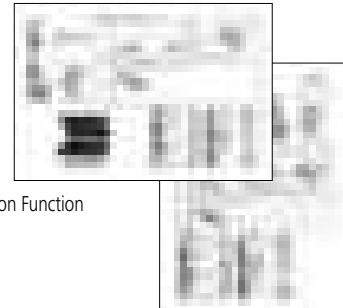

Report Creation Function

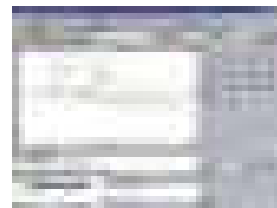

Automatic Circle/Line Application Function

Data Composition Function

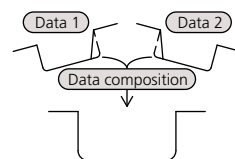

**MiCAT**

Mitutoyo-Intelligent Computer Aided Technology

the standard in world  
metrology software

**FORM**

# Optional Arms and Styli for Contour Measurement

For CV-2100

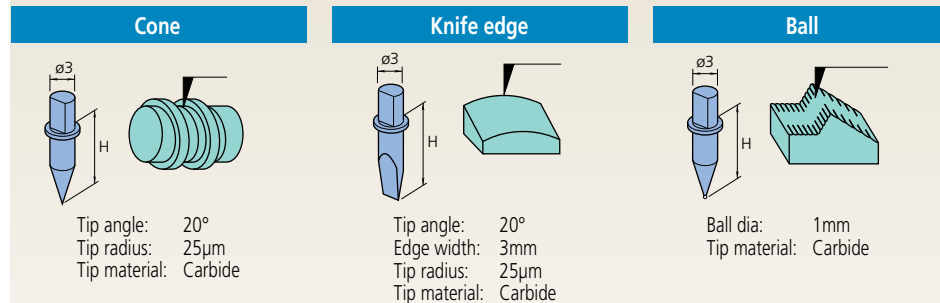
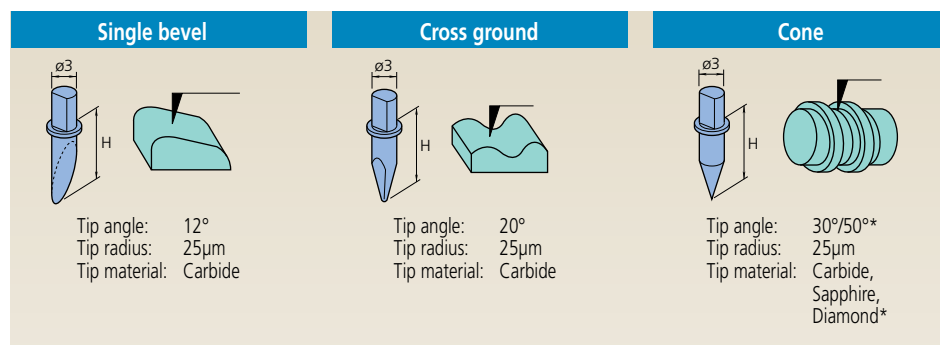
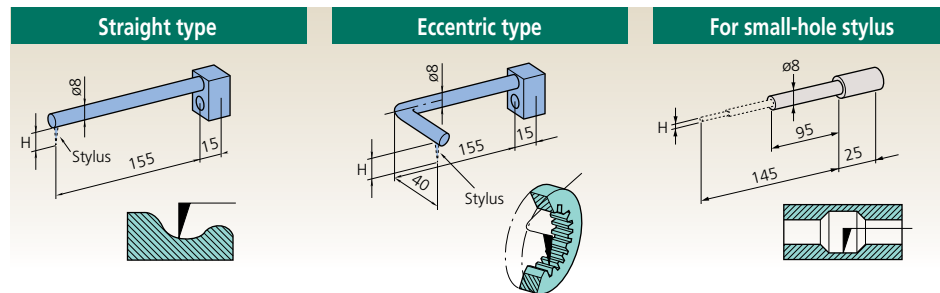

Small hole: 932693 / 12AAE873

Small hole: 932694 / 12AAE874

Small hole: 932695 / 12AAE875

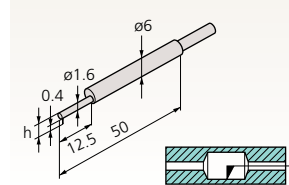

**932693** **12AAE873**  
 Tip shape: Single bevel Cone  
 Tip angle: 20° 30°  
 Tip radius: 25 $\mu$ m 25 $\mu$ m  
 Tip material: Carbide Carbide

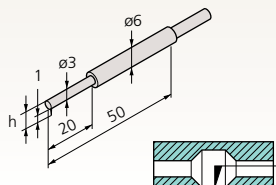

**932694** **12AAE874**  
 Tip shape: Single bevel Cone  
 Tip angle: 20° 30°  
 Tip radius: 25 $\mu$ m 25 $\mu$ m  
 Tip material: Carbide Carbide

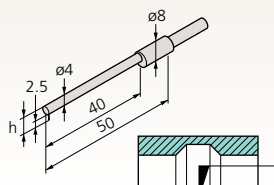

**932695** **12AAE875**  
 Tip shape: Single bevel Cone  
 Tip angle: 20° 30°  
 Tip radius: 25 $\mu$ m 25 $\mu$ m  
 Tip material: Carbide Carbide

## List of Applicable Arms

Arm name	Order No.	Compatible stylus height
Straight type	935111	H = 6mm
	935112	H = 12mm
	935113	H = 20mm
	935114	H = 30mm
	935115	H = 42mm
Eccentric type	935116	H = 6mm
	935117	H = 12mm
	935118	H = 20mm
	935119	H = 30mm
	935120	H = 42mm
Small hole	935110	H = 0.4, 1, 2.5mm

## List of Applicable Styli

Stylus name	Order No.	Stylus height
Single-bevel stylus carbide-tipped	354882	H = 6mm
	354883	H = 12mm
	354884	H = 20mm
	354885	H = 30mm
Cross-ground stylus carbide-tipped	354886	H = 42mm
	354887	H = 6mm
	354888	H = 12mm
	354889	H = 20mm
Cone stylus carbide-tipped tip angle 20°	354890	H = 30mm
	354891	H = 42mm
	12AAE865	H = 6mm
	12AAE866	H = 12mm
Cone stylus sapphire tipped tip angle 30° *Diamond tipped *tip angle 50°	12AAE867	H = 20mm
	12AAE868	H = 30mm
	12AAE869	H = 42mm
	354892	H = 6mm
Cone stylus carbide-tipped tip angle 30°	354893	H = 12mm
	354894	H = 20mm
	355129*	H = 20mm
	354895	H = 30mm
Cone stylus carbide-tipped tip angle 20°	354896	H = 42mm
	12AAA566	H = 6mm
	12AAA567	H = 12mm
	12AAA568	H = 20mm
Knife-edge stylus carbide-tipped	12AAA569	H = 30mm
	12AAA570	H = 42mm
	354897	H = 6mm
	354898	H = 12mm
Ball stylus carbide-tipped	354899	H = 20mm
	354900	H = 30mm
	354901	H = 42mm
	354902	H = 6mm
Small-hole stylus carbide-tipped single bevel	354904	H = 20mm
	354905	H = 30mm
	354906	H = 42mm
Small-hole stylus carbide-tipped cone	932693	H = 2mm
	932694	H = 4mm
	932695	H = 6.5mm
Small-hole stylus carbide-tipped cone	12AAE873	H = 2mm
	12AAE874	H = 4mm
	12AAE875	H = 6.5mm

# Optional Styli for Contour Measurement

CV-2100, CV-3200, CV-4500, SV-C3200, SV-C4500 and SV-C4500CNC

## List of Applicable Styli

Stylus name	Order No.	Stylus height
Single-bevel cut stylus carbide-tipped	354882	H = 6mm
	354883	H = 12mm
	354884	H = 20mm
	354885	H = 30mm
	354886	H = 42mm
Cross-ground stylus carbide-tipped	354887	H = 6mm
	354888	H = 12mm
	354889	H = 20mm
	354890	H = 30mm
	354891	H = 42mm
Cone stylus carbide-tipped tip angle 20°	12AAE865	H = 6mm
	12AAE866	H = 12mm
	12AAE867	H = 20mm
	12AAE868	H = 30mm
	12AAE869	H = 42mm
Cone stylus sapphire tipped tip angle 30° *Diamond tipped *tip angle 50°	354892	H = 6mm
	354893	H = 12mm
	354894	H = 20mm
	355129*	H = 20mm
	354895	H = 30mm
	354896	H = 42mm
Cone stylus carbide-tipped tip angle 30°	12AAA566	H = 6mm
	12AAA567	H = 12mm
	12AAA568	H = 20mm
	12AAA569	H = 30mm
	12AAA570	H = 42mm
Knife-edge stylus carbide-tipped	354897	H = 6mm
	354898	H = 12mm
	354899	H = 20mm
	354900	H = 30mm
	354901	H = 42mm
Ball stylus carbide-tipped	354902	H = 6mm
	354904	H = 20mm
	354905	H = 30mm
	354906	H = 42mm

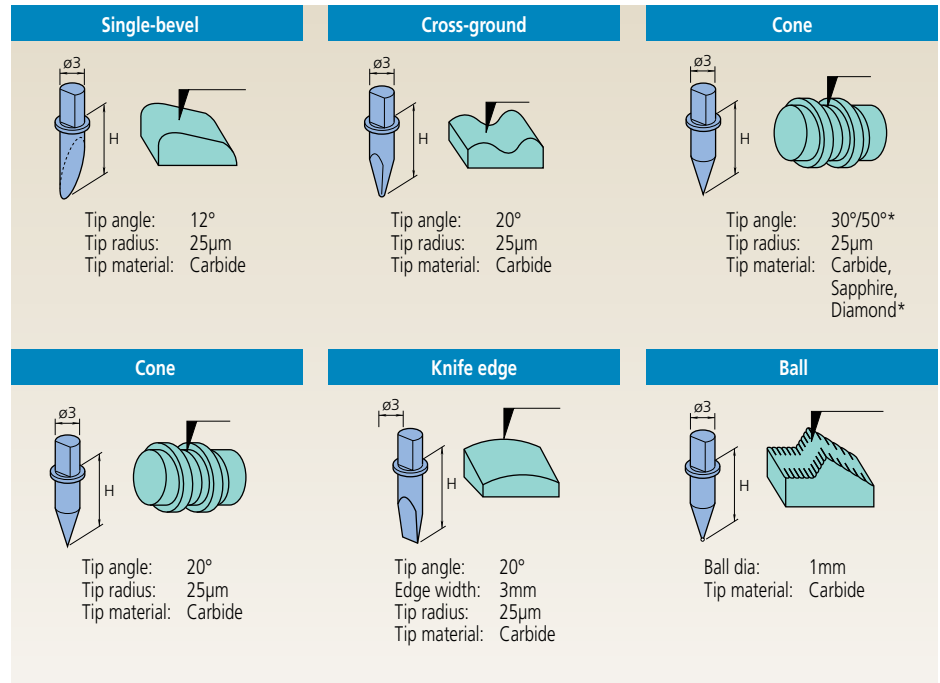

• Any specified arm and stylus other than above listed can be custom-made for special order.

### Arm and Stylus set: 12AAR588

Set for CV-4500 / SV-C4500 / SV-C4500CNC

Part	Part No.	Part Description
Arm	12AAQ762	Eccentric arm
	12AAM103	Small-hole arm
Stylus	354889	Cross-ground stylus
	354882	Single-bevel cut stylus
	12AAA568	Cone stylus
	12AAM104	Small hole stylus
	12AAM106	Small hole stylus
	12AAM096	Double-sided cone stylus
	12AAM097	Double-sided cone stylus
Integrated arm and stylus	12AAM109	Double-sided small hole arm stylus

### Arm and Stylus set: 12AAR587

Set for CV-3200 / CV-4500 / SV-C3200 / SV-C4500 / SV-C4500CNC

Part	Part No.	Part Description
Arm	12AAQ762	Eccentric arm
	12AAM103	Small-hole arm
Stylus	354889	Cross-ground stylus
	354882	Single-bevel cut stylus
	12AAA568	Cone stylus
	12AAM104	Small hole stylus
	12AAM106	Small hole stylus

# Optional Arms and Styli for Contour Measurement For CV-3200, CV-4500, SV-C3200, SV-C4500 and SV-C4500CNC

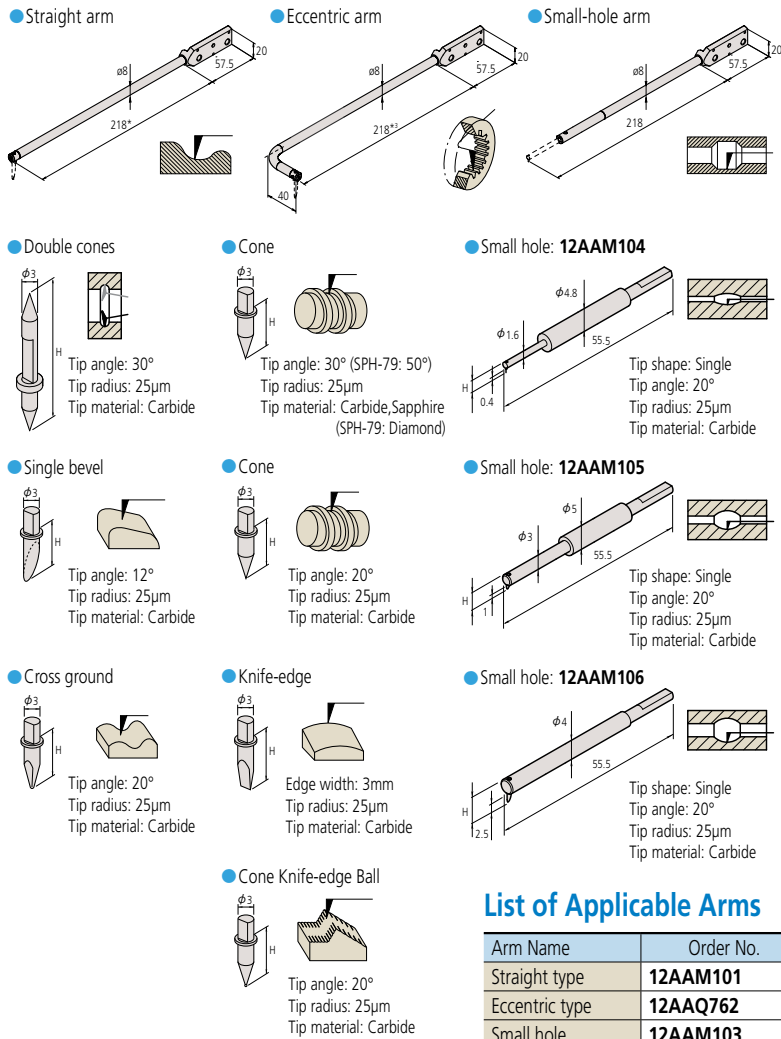

## List of Applicable Arms

Arm Name	Order No.
Straight type	<b>12AAM101</b>
Eccentric type	<b>12AAQ762</b>
Small hole	<b>12AAM103</b>

\*1: Standard accessory  
\*2: Stylus for CV-4500 series  
\*3: One-sided cut stylus SPH-71 (standard accessory) mounting

## List of Applicable Styli

Stylus Name	Order No.	H (mm)
Double cones stylus *4	<b>12AAM095</b> *5	20
	<b>12AAM096</b>	32
	<b>12AAM097</b>	48
Single-bevel stylus carbide-tipped	<b>354882</b>	6
	<b>354883</b>	12
	<b>354884</b> *6	20
	<b>354885</b>	30
	<b>354886</b>	42
Cross-ground stylus carbide-tipped	<b>354887</b>	6
	<b>354888</b>	12
	<b>354889</b>	20
	<b>354890</b>	30
	<b>354891</b>	42
Cone stylus sapphire-tipped tip angle 30°	<b>354892</b>	6
	<b>354893</b>	12
	<b>354894</b>	20
	<b>354895</b>	30
Cone stylus carbide-tipped tip angle 30°	<b>354896</b>	42
	<b>12AAA566</b>	6
	<b>12AAA567</b>	12
	<b>12AAA568</b>	20
Cone stylus carbide-tipped tip angle 20°	<b>12AAA569</b>	30
	<b>12AAA570</b>	42
	<b>12AAE865</b>	6
	<b>12AAE866</b>	12
Cone stylus carbide-tipped tip angle 20°	<b>12AAE867</b>	20
	<b>12AAE868</b>	30
	<b>12AAE869</b>	42
	Cone stylus diamond-tipped tip angle 50°	<b>355129</b>
Knife-edge stylus carbide-tipped	<b>354897</b>	6
	<b>354898</b>	12
	<b>354899</b>	20
	<b>354900</b>	30
Ball stylus carbide-tipped	<b>354901</b>	42
	<b>354902</b>	6
	<b>354904</b>	20
	<b>354905</b>	30
Small-hole stylus *7	<b>354906</b>	42
	<b>12AAM104</b>	2
	<b>12AAM105</b>	4
	<b>12AAM106</b>	6.5

\*4: Stylus for CV-4500 series  
\*5: Standard accessory of CV-4500 series  
\*6: Standard accessory of CV-3200 series  
\*7: Styli SPH-21, 22, and 23 for CV-3100/4100 series are not available.

## Arm stylus (integrated arm and stylus) only for CV-4500

Arm stylus name	Order No.	H (mm)	Tip angle
Double small-hole arm stylus *8	<b>12AAT469</b>	2.4	20°
	<b>12AAT470</b>	5	20°
	<b>12AAM108</b>	2.4	30°
	<b>12AAM109</b>	5	30°
	<b>12AAM110</b>	9	30°

\*8: Arm Stylus for CV-4500, SV-C4500 and SV-C4500CNC series. series

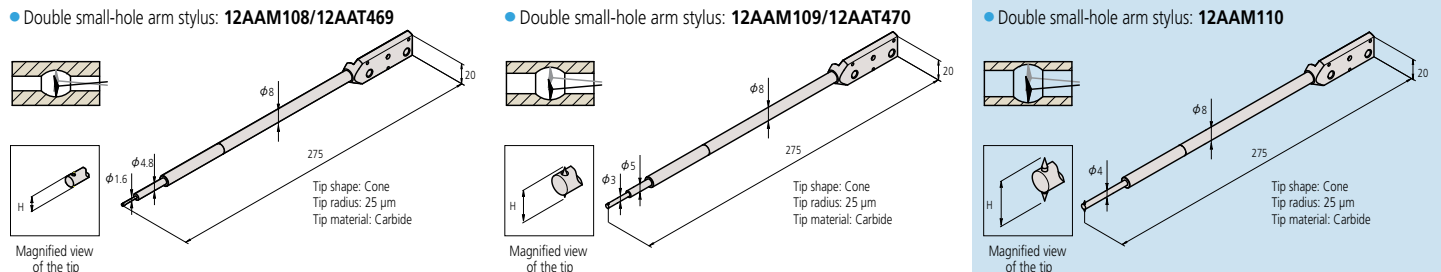

# Optional Accessories for Automatic Measurement

Compatible with CV-3200, CV-4500 and CNC Models

## Y-axis table\*: 178-097

A Y-axis table for both positioning and capable of 3D surface roughness measurement when used with optional software FTPK-PRO or MCubeMap.\*\*  
\*Not supporting Y-axis measurements. \*\* Only for 178-096



	178-097	178-096
Travel range	8" (200mm)	4" (100mm)
Resolution	1.97µin (0.05µm)	1.97µin (0.05µm)
Positioning accuracy	±3µm	±1µm
Drive speed	Max. 3.15"/s (80mm/s)	Max. .78"/s (20mm/s)
Maximum load	110 lbs (50kg)	33 lbs (50kg)
Mass	62 lbs (28kg)	68 lbs (31kg)

## θ2-axis table: 178-078\*

You can measure multiple points on a cylindrical workpiece and automate front/rear-side measurement.  
\*θ2-axis mounting plate (12AAE718) is required when directly installing on the base of the SV-3100.



Displacement	360°
Resolution	0.0072°
Maximum load (loading moment)	4kg (343N•cm or less)
Rotational speed	Max. 18°/s
Mass	11 lbs (5kg)

## Quick chuck: 211-032

This chuck is useful when measuring small workpieces. You can easily clamp them with its knurled ring.



Retention range	Inner latch	OD: ø .04 - 1.42" (1 - 36mm)
	Inner latch	ID: ø .55 - 2.76" (14 - 70mm)
	Outer latch	OD: ø .04 - 2.95" (1 - 75mm)
Dimensions		ø 4.65 x 1.61" (118 x 41mm)
Mass		2.65 lbs (1.2kg)

## θ1-axis table: 12AAD975\*

For efficient measurement in the axial/transverse directions. When measuring a cylindrical workpiece, automatic alignment can be performed in combination with the Y-axis table.

\*θ1-axis mounting plate (12AAE630) is required when directly installing on the base of the SV-3100.

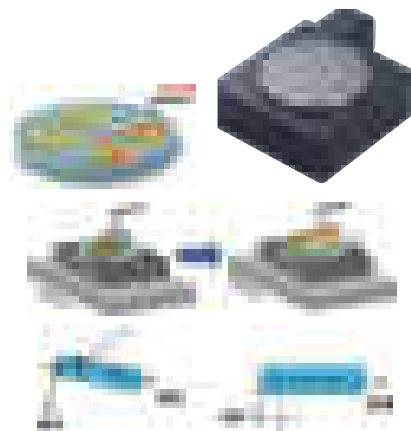

Displacement	360°
Resolution	0.004°
Maximum load	26.5 lbs (12kg)
Rotational speed	Max. 10°/s
Mass	15 lbs (7kg)

## Automatic-leveling table:178-087 (SV, CV, CS3200)

## Automatic-leveling table:178-037 (CNC Models)

This is a stage that performs fully automatic leveling as measurement starts, freeing the user from this troublesome operation. Fully automatic leveling can be done quickly by anyone. In addition, the operation is easy and reliable.



Inclination adjustment angle	±2°
Maximum load	7kg
Table dimensions	130 x 100mm
Mass	7.7lbs (3.5kg)

## Micro-chuck: 211-031

This chuck is suitable for clamping extra-small diameter workpieces (ø1 mm or less), which cannot be retained with the centering chuck.



Retention range	OD: ø 0 - .06" (0 - 1.5mm)
Dimensions	ø 4.65" x 1.9" (118 x 48.5mm)
Mass	1.32 lbs (0.6kg)

## Examples of optimal combinations of accessories for CNC models

Optional accessory	Y-axis Table	θ1 Table	θ2 Table
Function			
Automatic alignment (Patented: Japan)	●	●	—
Multiple workpiece batch measurement	▲	—	—
Multiple-piece measurement in the Y-axis direction (Positioning in the Y-axis direction)	●	—	—
Multiple-piece measurement in the radius direction (Positioning in the rotating direction of XY plane)	▲	●	—
Tracking measurement in the Z-axis direction *	—	—	—
Inclined surface measurement in the X-axis direction	▲	—	—
Inclined hole inside measurement in the X-axis direction	▲	—	—
Multiple cylinder generatrix line measurement	▲	—	●
Measurement of both top and bottom surfaces	▲	—	●
Rotary positioning of large workpiece **	—	—	—
Upward/downward and forward/backward measurement of large workpiece **	—	—	—

\* : Applicable only to form/contour measurement  
\*\* : Applicable only for SV-M3000CNC

▲ Recommended ● Essential — Not necessary





# Quick Guide to Precision Measuring Instruments



## Contracer (Contour Measuring Instruments)

### Traceable Angle

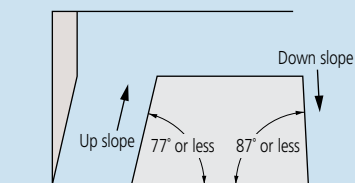

The maximum angle at which a stylus can trace upward or downward along the contour of a workpiece, in the stylus travel direction, is referred to as the traceable angle. A one-sided sharp stylus with a tip angle of  $12^\circ$  (as in the above figure) can trace a maximum  $77^\circ$  of up slope and a maximum  $87^\circ$  of down slope. For a conical stylus ( $30^\circ$  cone), the traceable angle is smaller. An up slope with an angle of  $77^\circ$  or less overall may actually include an angle of more than  $77^\circ$  due to the effect of surface roughness. Surface roughness also affects the measuring force.

For model CV-3200/4500, the same type of stylus (SPH-71: one-sided sharp stylus with a tip angle of  $12^\circ$ ) can trace a maximum  $77^\circ$  of up slope and a maximum  $83^\circ$  of down slope.

### Compensating for Stylus Tip Radius

A recorded profile represents the locus of the center of the ball tip rolling on a workpiece surface. (A typical radius is 0.025mm.) Obviously this is not the same as the true surface profile so, in order to obtain an accurate profile record, it is necessary to compensate for the effect of the tip radius through data processing.

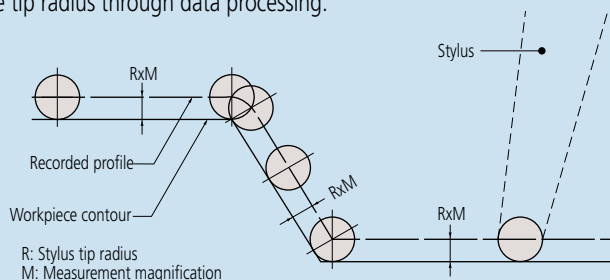

If a profile is read from the recorder through a template or scale, it is necessary to compensate for the stylus tip radius beforehand, according to the applied measurement magnification.

### Compensating for Arm Rotation

The stylus is carried on a pivoted arm so it rotates as the surface is traced and the contact tip does not track purely in the Z direction. Therefore, it is necessary to apply compensation in the X direction to ensure accuracy. There are three methods of compensating for arm rotation.

- 1: Mechanical compensation
- 2: Electrical compensation
- 3: Software processing. To measure a workpiece contour that involves a large displacement in the vertical direction with high accuracy, one of these compensation methods needs to be implemented.

### Accuracy

As the detector units of the X and Z axes incorporate scales, the magnification accuracy is displayed not as a percentage but as the linear displacement accuracy for each axis.

### Overload Safety Cutout

If an excessive force (overload) is exerted on the stylus tip due, perhaps, to the tip encountering a too-steep slope on a workpiece feature, or a burr, etc., a safety device automatically stops operation and sounds an alarm buzzer. This type of instrument is commonly equipped with separate safety devices for the tracing direction (X axis) load and vertical direction (Y axis) load.

For model CV-3200/4500 a safety device functions if the arm comes off the detector mount.

### Simple or Complex Arm Guidance

In the case of a simple pivoted arm, the locus that the stylus tip traces during vertical movement (Z direction) is a circular arc that results in an unwanted offset in X, for which compensation has to be made. The larger the arc movement, the larger the unwanted X displacement ( $\delta$ ) that has to be compensated. (See figure below.) The alternative is to use a complex mechanical linkage arrangement to obtain a linear translation locus in Z, and, therefore, avoid the need to compensate in X.

### Z-axis Measurement Methods

Though the X axis measurement method commonly adopted is by means of a digital scale, the Z axis measurement divides into analog methods (using a differential transformer, etc.) and digital scale methods.

Analog methods vary in Z-axis resolution depending on the measurement magnification and measuring range. Digital scale methods have fixed resolution.

Generally, a digital scale method provides higher accuracy than an analog method.

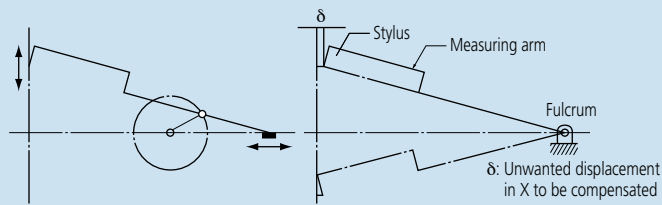

## ■ Contour Analysis Methods

You can analyze the contour with one of the following two methods after completing the measurement operation.

### 1. Data processing section

The measured contour is input into the data processing section in real time and a dedicated program performs the analysis using the mouse and/or keyboard. The angle, radius, step, pitch and other data are directly displayed as numerical values.

### 2. Analysis program

Analysis combining coordinate systems can be easily performed. The graph that goes through stylus radius correction is output to the printer as the recorded profile.

## ■ Tolerancing with Design Data

Measured workpiece contour data can be compared with design data in terms of actual and designed shapes rather than just analysis of individual dimensions. In this technique each deviation of the measured contour from the intended contour is displayed and recorded. Also, data from one workpiece example can be processed so as to become the master design data to which other workpieces are compared. This function is particularly useful when the shape of a section greatly affects product performance, or when its shape has an influence on the relationship between mating or assembled parts.

## ■ Best-fitting

If there is a standard for surface profile data, tolerancing with design data is performed according to the standard. If there is no standard, or if tolerancing only with shape is desired, best-fitting between design data and measurement data can be performed.

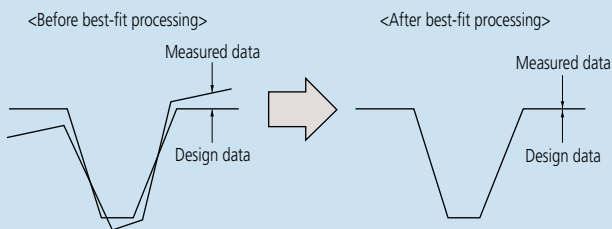

The best-fit processing algorithm searches for deviations between both sets of data and derives a coordinate system in which the sum of squares of the deviations is a minimum when the measured data is overlaid on the design data.

## ■ Data Combination

Conventionally, if tracing a complete contour is prevented by stylus traceable-angle restrictions then it has to be divided into several sections that are then measured and evaluated separately. This function avoids this undesirable situation by combining the separate sections into one contour by overlaying common elements (lines, points) onto each other. With this function the complete contour can be displayed and various analyses performed in the usual way.

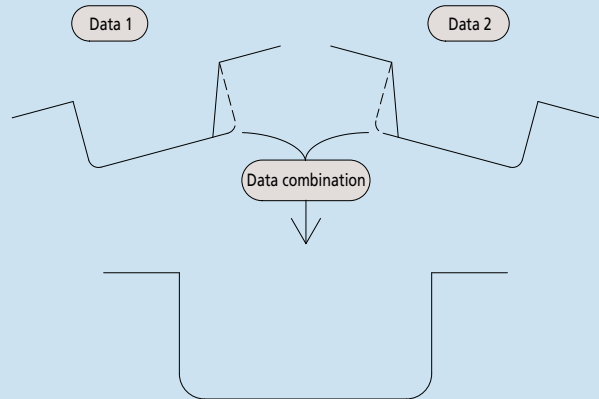

## ■ Measurement Examples



Aspheric lens contour

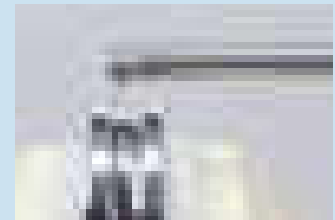

Inner/outer ring contour of a bearing



Internal gear teeth

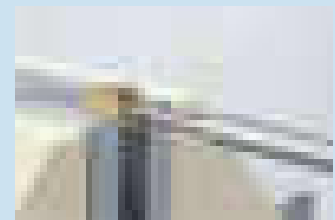

Female thread form



Male thread form



Gage contour



# Roundtest RA-120 / 120P

## SERIES 211 — Roundness Measuring Instruments

### Technical Data

Turntable  
 Rotational accuracy: Radial:  $(0.04+6H/10000)\mu\text{m}$   
H: Probing height (mm)  
 Axial:  $(0.04+6X/10000)\mu\text{m}$   
X: Distance from rotation center

Rotating speed: 6rpm  
 Table top diameter:  $\varnothing 1.96''$  (150mm)  
 Centering range:  $\pm 12''$  (3mm)  
 Leveling range:  $\pm 1^\circ$   
 Maximum probing diameter:  $\varnothing 11''$  (280mm)  
 Maximum workpiece diameter:  $\varnothing 17.3''$  (440mm)  
 Maximum workpiece weight: 55 lbs (25kg)

Vertical column (Z-axis)  
 Vertical travel: 11" (280mm)  
 Feeding: 1.18" (30mm)/rev. (coarse),  
 0.039" (1mm)/rev. (fine)

Maximum probing height: 11" (280mm) from the turntable top  
 Maximum probing depth: 3.94" (100mm) (min. ID: 1.18"/30mm)

Horizontal arm (X-axis)  
 Horizontal travel: 65" (165mm) (Including a protrusion  
 of 1" (25mm) the turntable rotation center)

Probe and stylus  
 Measuring range:  $\pm 1000\mu\text{m}$   
 Measuring force: 100mN $\pm$ 30mN  
 Standard stylus: 12AAL021, carbide ball,  $\varnothing 1.6\text{mm}$   
 Measuring direction: Two directional  
 Stylus angle adjustment:  $\pm 45^\circ$  (with graduations)

Data analysis unit:  
 Processing unit: Built-in (PC with Roundpak)\*  
 Data sampling points: 3,600 points/rotation  
 Data analysis items:  
 Roundness, Coaxiality, Concentricity, Flatness, Circular  
 runout (radial), Circular runout (axial), Squareness (against  
 axis), Squareness (against plane), Thickness deviation,  
 Parallelism

Reference circles for roundness evaluation:  
 LSC, MZC, MIC, MCC

Recording device:  
 Built-in thermal line printer (optional external printer)\*

Recording magnification:  
 X5 to X200,000, Auto (X1 to X500,000)\*

Roughness component reduction:  
 Low pass filter, band pass filter

Filter type:  
 2CR-75%, 2CR-50%, 2CRPC-75% (phase corrected),  
 2CRPC-50% (phase corrected), Gaussian, filter OFF

Cutoff value;  
 15 $\mu\text{r}$ , 50 $\mu\text{r}$ , 150 $\mu\text{r}$ , 500 $\mu\text{r}$ , 15-150 $\mu\text{r}$ , 15-500 $\mu\text{r}$ ,  
 50-500 $\mu\text{r}$ , Manual setting\*

Number of measuring sections  
 Max. 5-section (100-section)\*

\*RA-120P

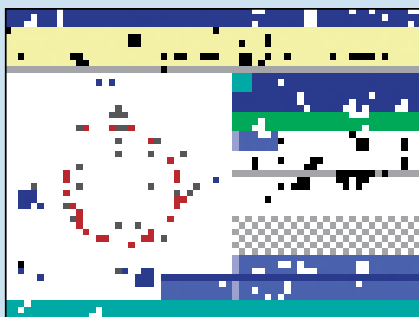

Large color LCD display for RA-120 models

The Roundtest RA-120 / 120P are a compact, affordable, and simple-to-use device for measuring part geometry on the shop floor. It also provides such superb data analysis capabilities as required with laboratory roundness measuring instruments and has a  $\pm 1000\mu\text{m}$  wide range detector and precision turntable with excellent rotation accuracy.

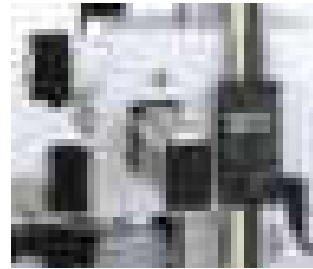

Z-axis scale unit

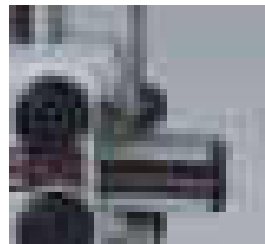

Optional X-axis stop



RA-120

Order No.: 211-544A (with mechanical mic-heads)  
 Order No.: 211-543A (with DAT function, inch/mm)

### SPECIFICATIONS

Model No.	RA-120*	RA-120D	RA-120P	RA-120PD
Order No.	211-544A	211-543A	211-547A	211-546A

\* Does not include Z-axis scale unit.

The RA-120P is a PC-based model which controls all operations via ROUNDPAK software (optional).



RA-120P

Order No.: 211-547A (with mechanical mic-heads)  
 Order No.: 211-546A (with DAT function, inch/mm)

**MiCAT**

Mitutoyo Intelligent Computer Aided Technology

the standard in world  
metrology software

**FORM**

**Mitutoyo**

# Roundtest RA-120 / 120P

## SERIES 211 — Roundness Measuring Instruments

### DAT (Digital Adjustment Table) function

The turntable digitally displays the centering and leveling adjustments, turning what used to be a difficult task into one that is simple enough for even new operators to perform.

1. Preliminary measurement of two cross sections: A and B.

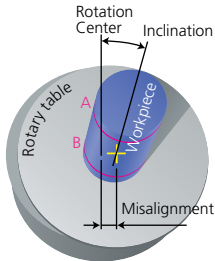

2. Following preliminary measurement, the centering and leveling adjustment values are displayed on the monitor.

3. Manipulate the digital micrometer heads of the rotary table so that the adjustment values displayed on the monitor are realized.

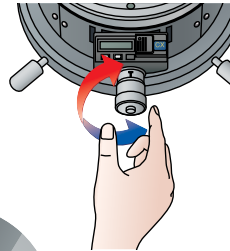

4. Centering and leveling are complete. Centering range:  $\pm 3\text{mm}$  Leveling (inclination) range:  $\pm 1^\circ$

## DIMENSIONS

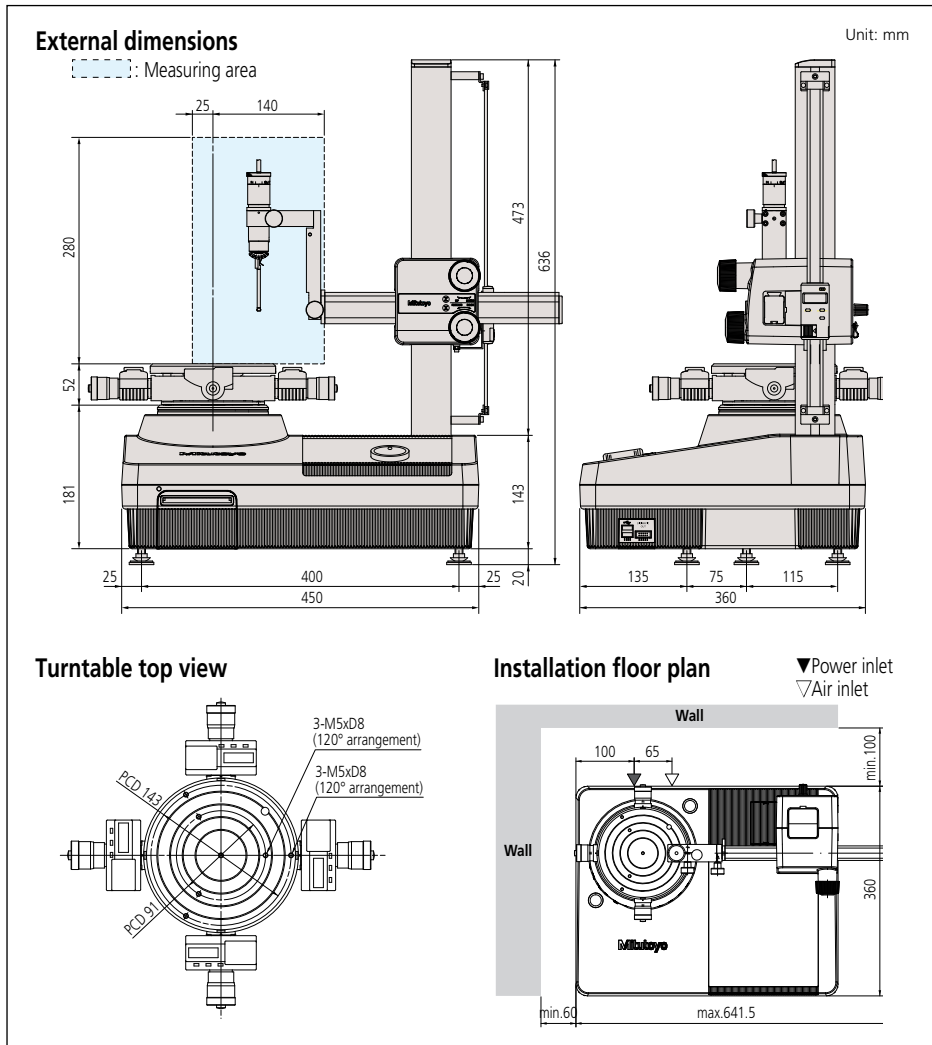

### Functions

- Notched workpiece measurement
- Recalculation of datum/measured data
- Limaçon function compensates for eccentricity
- Rotation of 3D display\*\*
- Real-time display\*\*
- Simplified layout (divided layout)\*\*
- Hair line, auxiliary line, hidden line, fill line\*\*
- Color setting of measured data\*\*
- Offsetting of recorded profile generation\*\*
- Zooming of recorded profile\*\*
- Data deletion\*\*
- Graph analysis (displacement/angle between measured points)\*\*
- Power spectrum analysis\*\*
- Gear tooth analysis\*\*
- Harmonic analysis\*\*
- Text data output (via CSV format)\*\*

\*\*Function of ROUNDPAK software

### Air supply

- Air pressure: 390kPa
- Air consumption: 30L/min.
- Power supply: 100V AC – 240V AC, 50/60Hz
- Dimensions (W x D x H): 17.7" x 14.2" x 25" (450 x 360 x 636mm)
- Mass: 70.5 lbs (32kg) (main unit), 4.4 lbs (2kg) (air regulator)

### Optional Accessories

- **211-032:** Quick chuck (OD: 1 - 79mm, ID: 16 - 69mm)
- **211-014:** Three-jaw chuck (OD: 2 - 78mm, ID: 25 - 68mm)
- **211-031:** Micro-chuck (OD: 1.5mm max.)
- **356038:** Auxiliary stage for a low-height workpiece
- **211-016:** Reference hemisphere
- **211-045:** Magnification checking gage
- **997090:** Gage block set for calibration
- **12AAH320:** X-axis stop
- **211-013:** Vibration damping stand
- **12AAH433:** Z-axis scale unit for RA-120
- —: Interchangeable styli (See page J-49.)



### CONSUMABLE PARTS

- **12AAH181:** Printer paper 10 rolls/set
- **358592:** Element for air filter 1 pc./set
- **358593:** Element for air regulator 10 pcs./set

# Roundtest RA-1600 / RA-1600M

## SERIES 211 — Roundness/Cylindricity Measuring System

### Technical Data

#### Turntable

Rotational accuracy (radial):  $(0.02+6H/10000)\mu\text{m}$  (RA-1600)  
 Rotational accuracy (axial):  $(0.02+6X/10000)\mu\text{m}$  (RA-1600)  
 Rotational accuracy (radial):  $(0.03+6H/10000)\mu\text{m}$  (RA-1600M)  
 Rotational accuracy (axial):  $(0.03+6X/10000)\mu\text{m}$  (RA-1600M)  
 H: Probing height (mm), X: Probing radius (mm)

Rotational speed: 4, 6, 10rpm  
 Table top diameter:  $\phi 5.9"$  (150mm)  
 Centering range:  $\pm 3\text{mm}$  (with DAT function)  
 Leveling range:  $\pm 1^\circ$  (with DAT function)  
 Maximum probing diameter:  $\phi 11"$  ( $\phi 280\text{mm}$ )  
 Maximum workpiece diameter:  $\phi 22"$  ( $\phi 560\text{mm}$ )  
 Maximum table loading: 55lbs (25kg)

#### Vertical column (Z-axis)

Vertical travel: 11.8" (300mm)  
 Straightness (in narrow range):  $0.20\mu\text{m} / 100\text{mm}$  (RA-1600)  
 Straightness (in entire range):  $0.30\mu\text{m} / 300\text{mm}$  (RA-1600)  
 Straightness (in narrow range):  $0.40\mu\text{m} / 100\text{mm}$  (RA-1600M)  
 Straightness (in entire range):  $0.80\mu\text{m} / 100\text{mm}$  (RA-1600M)  
 Parallelism with turntable axis:  $1.5\mu\text{m} / 300\text{mm}$   
 Positioning speed: Max. 15mm/s  
 Measuring speed: 0.5, 1, 2, 5mm/s  
 Maximum probing height (ID/OD): 11.8" (300mm)\*1  
 Maximum probing depth: 91mm (over  $\phi 32$ )  
 3.6" (over  $\phi 1.26"$ ) (91mm (over  $\phi 32$ ))  
 1.97" (over  $\phi 0.27"$ ) (50mm (over  $\phi 7$ ))

#### Horizontal arm (X-axis)

Horizontal travel: 6.5" (165mm) (From table axis -1~ $\pm 5.5"$   
 (-25mm -  $\pm 140\text{mm}$ )  
 Positioning speed: Max. 15mm/s  
 Measuring speed: 0.5, 1, 2, 5mm/s  
 X-axis straightness:  $2.7\mu\text{m} / 140\text{mm}$  (RA-1600)  
 X-axis parallelism to turntable axis:  
 1.6 $\mu\text{m} / 140\text{mm}$  (RA-1600)

#### Probe and stylus

Measuring range:  $\pm 400\mu\text{m} / \pm 40\mu\text{m} / \pm 4\mu\text{m}$   
 Measuring force: 10–50mN (5 level switching)  
 Standard stylus: **12AAL021**, carbide ball,  $\phi 1.6\text{mm}$   
 Measuring direction: Bi-directional  
 Stylus angle adjustment:  $\pm 45^\circ$  (with graduations)

#### Air supply

Air pressure: 0.39MPa (4kgf/cm<sup>2</sup>)  
 Air consumption: 22L/min.

Power supply: 100V AC – 240V AC, 50/60Hz  
 Dimensions (W x D x H): 35 x 19.3 x 33" (890 x 490 x 840mm)  
 Mass: 375lbs (170kg)

\*1 Use an optional auxiliary stage for measuring a workpiece whose height is 20mm or less.

### ROUNDPAK

The latest roundness/cylindrical form analysis program

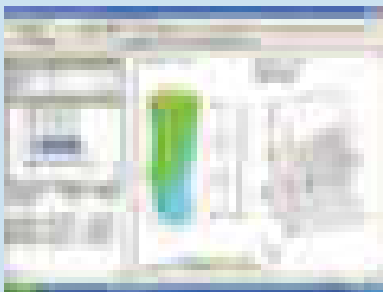

**MiCAT**  
 Mitutoyo Intelligent Computer Aided Technology

the standard in world  
 metrology software  
**FORM**

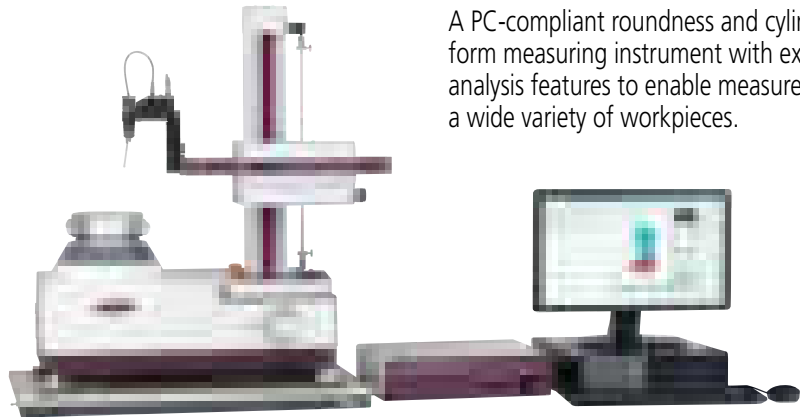

RA-1600 / RA-1600M  
 with personal computer system and software

A PC-compliant roundness and cylindrical-form measuring instrument with extensive analysis features to enable measurement of a wide variety of workpieces.

### Spiral Measurement/Analysis

The spiral-mode measurement function combines table rotation and rectilinear action allowing table cylindrical, coaxiality, and other measurement data to be loaded as a continuous data set.

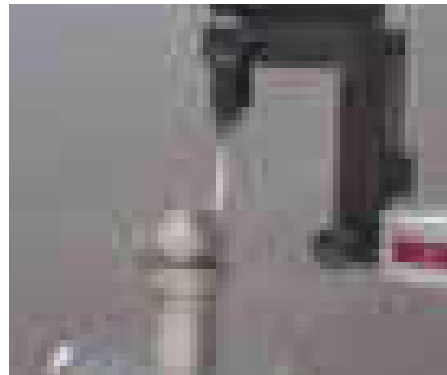

Spiral-mode cylinder measurement



### Safety mechanism provided as a standard feature

A collision-sensing function has been added to the detector unit (when it is in the vertical orientation) to prevent collision in the Z-axis direction. Additionally, an accidental collision prevention function, which stops the system when the detector displacement exceeds its range, has been added. When an accidental touch is detected, the dedicated analysis software (ROUNDPAK) senses the error and automatically stops the system.

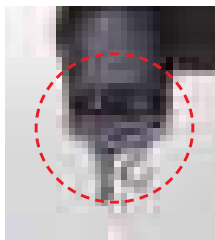

### Measurement Through X-axis Tracking

Measurement while tracing is possible through a built-in linear scale in the X-axis. This type of measurement is useful when displacement due to form variation exceeds the measuring range of the detector, and X-axis motion is necessary to maintain contact with the workpiece surface.



### Continuous Internal/External Diameter Measurement

Continuous internal/external diameter measurement is possible without changing the detector position.

- 1), 2) : External diameter measurement
- 3) : Internal diameter measurement
- : Displacement
- 3) = inner diameter: Up to  $\phi 50\text{mm}$



# Roundtest RA-1600 / RA-1600M

## SERIES 211 — Roundness/Cylindricity Measuring System

### Centering and Leveling Function

The turntable displays centering and leveling adjustments digitally, making this challenging task simple enough for even a new operator to perform.

1. Preliminary measurement of two cross sections: A and B.
2. Following preliminary measurement, the centering and leveling adjustment values are displayed on the monitor.

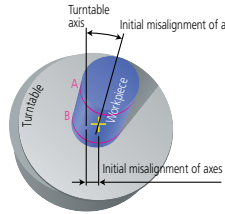

#### For RA-1600

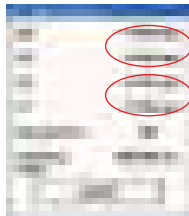

Centering adjustment value

Leveling adjustment value

#### For RA-1600M



3. By adjusting the micrometer heads for the rotary table, the adjustment values or level meter displayed on the monitor can be achieved.

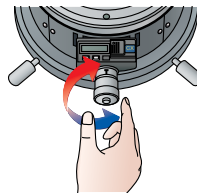

4. Centering and leveling are complete.  
Centering range:  $\pm 3\text{mm}$   
Leveling (inclination) range:  $\pm 1^\circ$

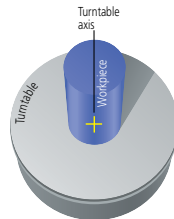

### SPECIFICATIONS

Model No.	RA-1600	RA-1600M
Order No. (inch/mm)	211-733A	211-724A
Mic Heads	Digimatic	Mechanical

### DIMENSIONS

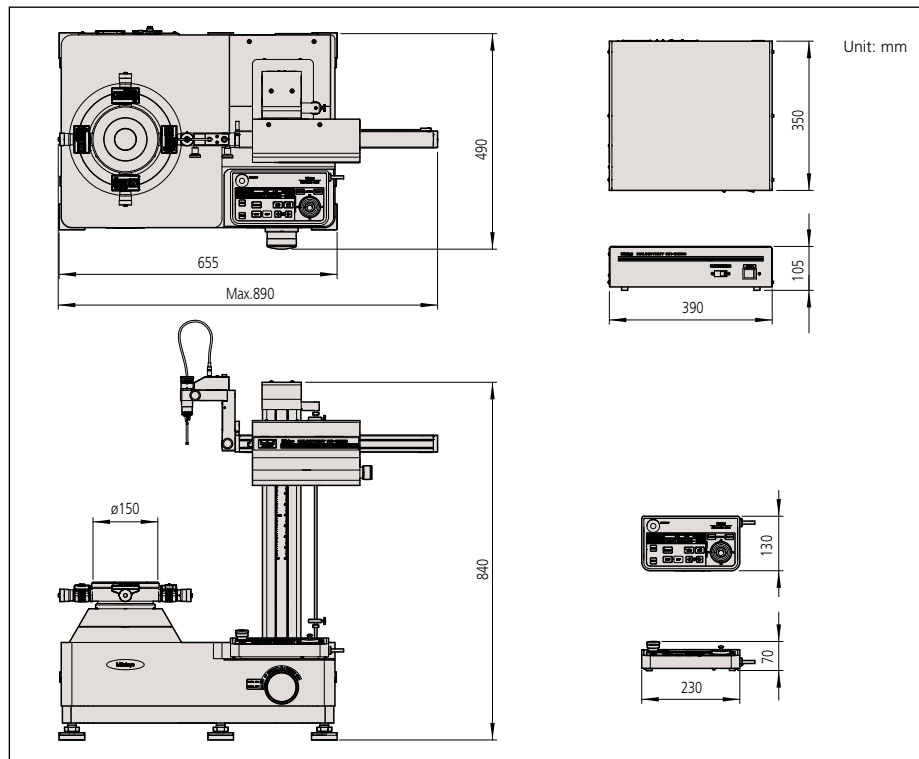

### Optional Accessories

- 350850: Cylindrical square
- 356038: Auxiliary stage for a low-height workpiece
- 12AAF203: 2x extension detector holder
- 12AAF204: Auxiliary detector holder for a large-diameter workpiece
- 12AAL090: Sliding detector holder
- 211-045: Magnification checking gage
- 211-014: Chuck (OD:  $\phi 2 - 78\text{mm}$ , ID:  $\phi 25 - 68\text{mm}$ )
- 211-032: Quick chuck (OD:  $\phi 1 - 79\text{mm}$ , ID:  $16 - 69\text{mm}$ )
- 211-031: Micro-chuck (OD:  $\phi 0.1 - 1.5\text{mm max.}$ )
- 178-025: Vibration isolator (Desktop type)
- 64AAB213: Vibration isolation workstation
- 12AAL019: Side table for PC
- : Interchangeable styli (See page J-49.)



### Sliding detector-unit holder (Option) 12AAL090

The detector-unit holder is equipped with a sliding mechanism, enabling one-touch measurement of a workpiece with a deep hole having a thick wall, which has been difficult with the conventional standard arm.

Sliding distance: 4.4" (112mm)

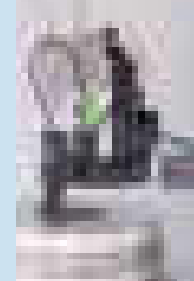

The detector-unit holder can be stopped at a position sufficiently higher than the workpiece and then lowered and positioned to make measurements. Furthermore, internal/external diameters can be easily measured with the continuous internal/external diameter measurement function\*.

\*: See page 41 for details about the continuous ID and OD measuring function.

## Technical Data

Turntable  
 Rotational accuracy (radial):  $\{(0.02+3.5H/10000)\mu\text{m}\}$   
 Rotational accuracy (axial):  $\{(0.02+3.5R/10000)\mu\text{m}\}$   
H: Probing height (mm), R: Probing radius (mm)  
 Rotating speed: 2, 4, 6, 10rpm  
 Tabletop diameter:  $\varnothing 9.2''$  (235mm) AS / AH models  
 $\varnothing 7.9''$  (200mm) DS / DH models  
 Centering range:  $\pm 3\text{mm}$  ( $\pm 5\text{mm}$ : DS / DH models)  
 Leveling range:  $\pm 1^\circ$   
 Maximum probing diameter:  $\varnothing 11.8''$  (300mm)  
 Maximum workpiece diameter:  $\varnothing 22.8''$  (580mm)  
 Maximum workpiece weight: 66 lbs (30kg)  
 Vertical column (Z-axis)  
 Vertical travel: 11.8" (300mm) (22.8" (500mm): AH/DH models)  
 Straightness ( $\lambda c 2.5$ ): 0.10 $\mu\text{m}$  / 100mm, 0.15 $\mu\text{m}$  / 300mm  
 (0.25 $\mu\text{m}$  / 500mm: AH / DH models)  
 Parallelism with rotating axis: 0.7 $\mu\text{m}$  / 300mm  
 (1.2 $\mu\text{m}$  / 500mm: AH / DH models)  
 Positioning speed: Max. 50mm/s  
 Measuring speed: 0.5, 1, 2, 5mm/s  
 Maximum probing height: 11.8" (300mm) (OD / ID)  
 [22.8" (500mm): AH / DH models]  
 Maximum probing depth: over  $\varnothing 32$ : 85mm (w/standard stylus)  
 over  $\varnothing 7$ : 50mm (w/standard stylus)  
 Horizontal arm (X-axis)  
 Horizontal travel: 6.9" (175mm) (Including a protrusion of  
 1" (25mm) the turntable rotation center)  
 Straightness ( $\lambda c 2.5$ ): 0.7 $\mu\text{m}$  / 150mm  
 Squareness with rotating axis: 1.0 $\mu\text{m}$  / 150mm  
 Positioning speed: Max. 30mm/s with joystick operation  
 Measuring speed: 0.5, 1, 2, 5mm/s  
 Probe and stylus  
 Measuring range:  $\pm 400\mu\text{m}/\pm 40\mu\text{m}/\pm 4\mu\text{m}$   
 ( $\pm 5\text{mm}$ : tracking range)  
 Measuring force: 10mN-50mN (in 5 steps)  
 Standard stylus: **12AAL021**, carbide ball,  $\varnothing 1.6\text{mm}$   
 Measuring direction: Two directional  
 Stylus angle adjustment:  $\pm 45^\circ$  (with graduations)  
 Data analysis system  
 Analysis software: Roundpak  
 Filter type:  
 2CRPC-75%, 2CRPC-50%, 2CR-75% (non-phase  
 corrected), 2CR-50% (non-phase corrected), Gaussian,  
 filter OFF  
 Cutoff value;  
 15upr, 50upr, 150upr, 500upr, 1500upr,  
 15-150upr, 15-500upr, 15-1500upr, 50-500upr,  
 50-1500upr, 150-1500upr, Manual setting  
 Reference circles for roundness evaluation:  
 LSC, MZC, MIC, MCC  
 Air supply  
 Air pressure: 390kPa (4kgf/cm<sup>2</sup>)  
 Air consumption: 30L/min.  
 Power supply: 100V AC - 240V AC, 50/60Hz  
 Dimensions (W x D x H): 26.3 x 20 x 35.4"  
 (667 x 510 x 900mm)  
 26.3 x 20 x 43.3"  
 (667 x 510 x 1100mm: AH / DH models)  
 Mass:  
 396 lbs (180kg)  
 440 lbs (200kg) AH / DH models

## Printout



# Roundtest RA-2200AS / DS / AH / DH

## SERIES 211 — Roundness / Cylindricity Measuring System

The RA-2200 provides high accuracy, high speed and high performance in roundness measurement. The fully-automatic, or DAT (Digital Adjustment Table), function-aided manual workpiece centering and leveling turns what used to be a difficult task into one that is simple enough for even new users to

perform. This facilitates substantial reductions in overall measurement time. The RA-2200 system comes complete with powerful data analysis software ROUNDPAK, which requires only simple manipulation using a mouse and icons, achieving enhanced functionality and ease of operation.

### RA-2200AS with personal computer system and software

\* Shown with optional  
vibration isolator and side  
table for PC



### Highly accurate and easy-to-use turntable

With extremely high rotational accuracy, both in the radial and axial directions, the turntable allows high accuracy flatness testing to be performed in addition to roundness and cylindricity measurements.

Incorporating an automatic centering/leveling turntable (A.A.T.), the top-of-the-line RA-2200AS/AH models relieve the operator of the bothersome task of workpiece centering and leveling.

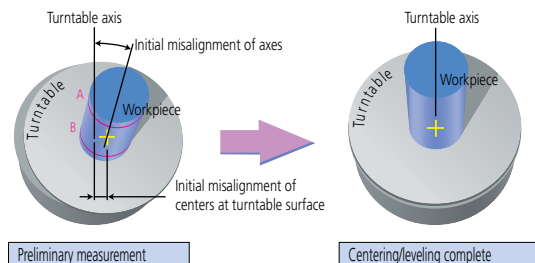

A guidance system (D.A.T.) is incorporated into the turntables on the RA-2200DS/DH models to help the operator perform manual centering and leveling smoothly and simply.

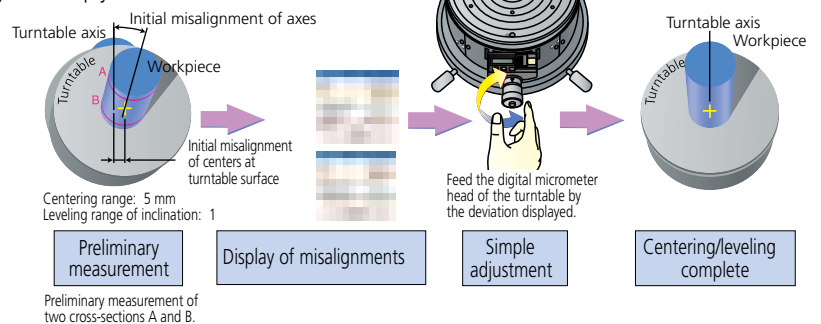

# Roundtest RA-2200AS / DS / AH / DH

## SERIES 211 — Roundness / Cylindricity Measuring System

### Greater productivity by continuous measurement

Both the OD and ID of a workpiece\* can be measured in succession without the need for changing the traverse direction of the stylus.

\*Inside diameter up to 50 mm.

Continuous measurement is possible as shown in steps (1) through (3) on the figure at the left, without having to switch the probe direction.

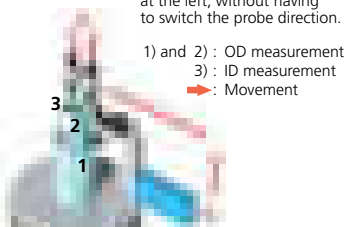

Highly repeatable measurements with high-accuracy scales Mitutoyo linear scales are used in the X/Z drive unit to guarantee the high precision positioning so vital for repetitive measurement.

### Surface roughness measurement function (Surface roughness unit: option)

A surface roughness detector, compliant with the relevant International Standards, can be mounted in place of the roundness measuring detector. This creates a multiple sensor system that can not only test the geometrical roundness/cylindricity of a surface but also the roughness of that surface as well.



## SPECIFICATIONS

Model No.	RA-2200AS	RA-2200DS	RA-2200AH	RA-2200DH
<b>Order No.</b>	<b>211-511A</b> (mm/inch)	<b>211-514A</b> (inch)	<b>211-512A</b> (mm/inch)	<b>211-516A</b> (inch)
Effective table diameter	9.25" (235mm)	8" (200mm)	9.25" (235mm)	8" (200mm)
Centering/leveling adjustment	A.A.T.	D.A.T.	A.A.T.	D.A.T.
Centering range	±0.118" (±3mm)	±0.197" (±5mm)	±0.118" (±3mm)	±0.197" (±5mm)
Column travel	12" (300mm) (standard column)		20" (500mm) (high column)	
Basic unit mass	396 lbs. (180kg)		440 lbs. (200kg)	

## DIMENSIONS

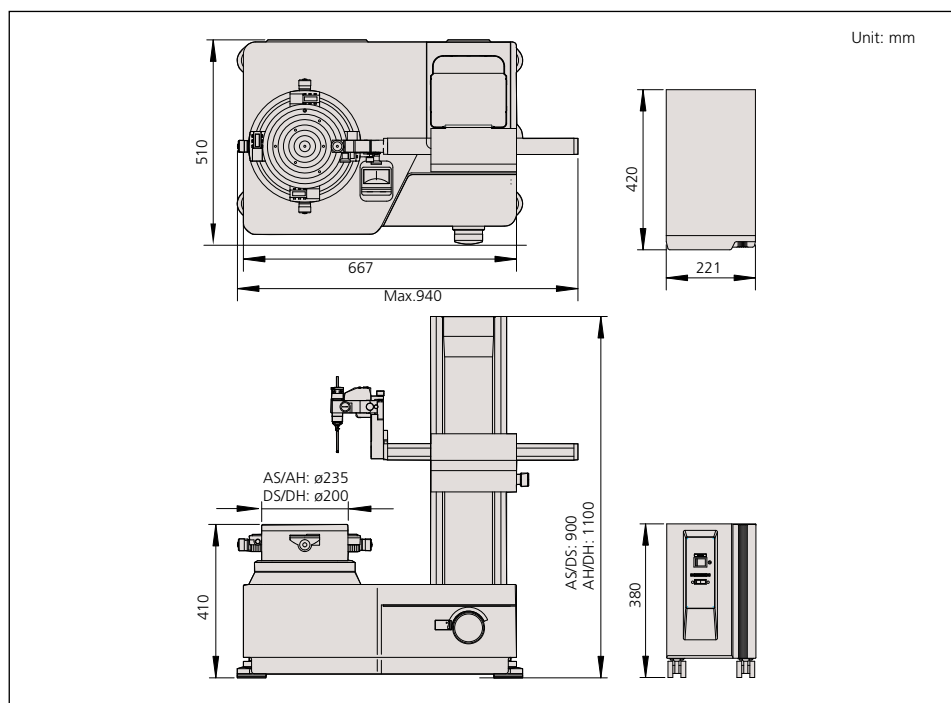

## Optional Accessories

- 350850:** Cylindrical square
- 356038:** Auxiliary stage for a low-height workpiece
- 12AAF203:** Extension probe holder (2X higher)
- 12AAF204:** Auxiliary probe holder for a large diameter workpiece
- 211-045:** Magnification checking gage
- 211-014:** Chuck (OD: 1 - 85mm, ID: 33 - 85mm)
- 211-032:** Quick chuck (OD: 1 - 75mm, ID: 14 - 70mm)
- 211-031:** Micro-chuck (OD: 1.5mm max.)
- 178-025:** Vibration isolator
- 178-024:** Stand for vibration isolator
- Interchangeable styli (See page J-49.)
- 12AAK110:** Vibration isolator
- 12AAK120:** Monitor arm
- 12AAL019:** Side table for PC
- 12AAF353:** Surface roughness detector holder



### Sliding detector-unit holder (Standard) 12AAL090

The detector-unit holder is equipped with a sliding mechanism, enabling one-touch measurement of a workpiece with a deep hole having a thick wall, which has been difficult with the conventional standard arm.

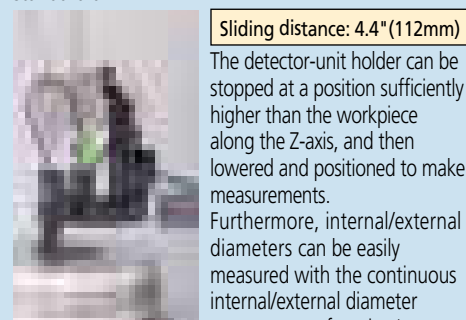

\*: See page 41 for details about the continuous ID and OD measuring function.

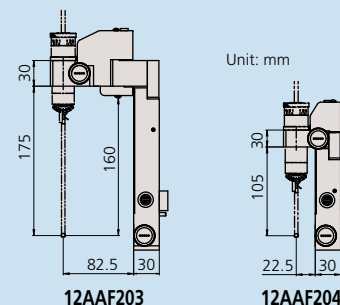

# Roundtest RA-H5200AS / AH

## SERIES 211 — Roundness / Cylindricity Measuring System

### Technical Data

Turntable  
 Rotational accuracy (radial):  $\{(0.02+3.5H/10000)\mu\text{m}\}$   
 Rotational accuracy (axial):  $\{(0.02+3.5X/10000)\mu\text{m}\}$   
H: Probing height (mm), X: Distance from the turntable axis (mm)  
 Rotating speed: 2, 4, 6, 10rpm (20rpm: auto-centering)  
 Table top diameter:  $\varnothing 11.8"$  (300mm)  
 Centering range:  $\pm 5\text{mm}$   
 Leveling range:  $\pm 1^\circ$   
 Maximum probing diameter:  $\varnothing 15.7"$  (400mm)  
 Maximum workpiece diameter:  $\varnothing 26.8"$  (680mm)  
 Maximum workpiece weight: 176 lbs (80kg)  
 143 lbs (65kg): auto-centering

Vertical column (Z-axis)  
 Vertical travel: 13.8" (350mm), (21.7" (550mm): AH model)  
 Straightness ( $\lambda c2.5$ ):  $0.05\mu\text{m} / 100\text{mm}$ ,  $0.14\mu\text{m} / 350\text{mm}$   
 (0.2 $\mu\text{m} / 550\text{mm}$ : AH model)  
 Parallelism with rotating axis:  $0.2\mu\text{m} / 350\text{mm}$   
 (0.32 $\mu\text{m} / 550\text{mm}$ : AH model)  
 Positioning speed: Max. 60mm/s  
 Measuring speed: 0.5, 1, 2, 5mm/s  
 Maximum probing height: 13.8" (350mm) (OD / ID)  
 [21.7" (550mm) (OD / ID): AH model]  
 Maximum probing depth: over  $\varnothing 32$ : 85mm (w/standard stylus)  
 over  $\varnothing 7$ : 50mm (w/standard stylus)

Horizontal arm (X-axis)  
 Horizontal travel: 8.9" (225mm)  
 Straightness ( $\lambda c2.5$ ):  $0.4\mu\text{m} / 200\text{mm}$   
 Squareness with rotating axis:  $0.5\mu\text{m} / 200\text{mm}$   
 Positioning speed: Max. 50mm/s  
 Measuring speed: 0.5, 1, 2, 5mm/s

Probe and stylus  
 Measuring range:  $\pm 400\mu\text{m}$  ( $\pm 5\text{mm}$ : tracking range)  
 Measuring force: 10mN~50mN (in 5 steps)  
 Standard stylus: **12AAL021**, carbide ball,  $\varnothing 1.6\text{mm}$   
 Measuring direction: Two directional  
 Stylus angle adjustment:  $\pm 45^\circ$  (with graduations)

Data analysis system  
 Analysis software: Roundpak  
 Filter type:  
 2CRPC-75%, 2CRPC-50%, 2CR-75% (non-phase corrected), 2CR-50% (non-phase corrected), Gaussian, filter OFF  
 Cutoff value:  
 15upr, 50upr, 150upr, 500upr, 1500upr,  
 15-150upr, 15-500upr, 15-1500upr, 50-500upr, 50-1500upr, 150-1500upr, Manual setting  
 Reference circles for roundness evaluation:  
 LSC, MZC, MIC, MCC

Air supply  
 Air pressure: 390kPa (4kgf/cm<sup>2</sup>)  
 Air consumption: 45L/min.  
 Power supply: 100V AC – 240V AC, 50/60Hz  
 Dimensions (W x D x H): 49.6 x 28.0 x 66.9"  
 (1260 x 710 x 1700mm)  
 49.6 x 28.0 x 74.8"  
 (1260 x 710 x 1900mm: AH model)

Mass: Main unit: 1433lbs. (650kg)  
 1477lbs. (670kg): AH model  
 Vibration isolator: 375 lbs (170kg)

RA-H5200AS / AH, a roundness/cylindricity measuring system developed to combine world-class accuracy with maneuverability/high-analysis capability.

Enhanced detector safety functions, such as accidental touch and collision detection, is installed to minimize damage to both machine and workpieces.



RA-H5200AS  
with personal computer  
system and software

\* Shown with optional  
side table for PC.

### High-accuracy automatic centering/leveling turntable

A highly accurate, highly rigid turntable has been achieved through exceptional manufacturing accuracy of the critical components, such as the rotor and stator, in addition to an air-bearing incorporating a complex aperture that provides superior rigidity and uniform pressure distribution. As a result, the rotational accuracy (radial), which is the heart of the roundness/cylindricity measuring system, is a world-class (0.02 +3.5H/10000) $\mu\text{m}$ .

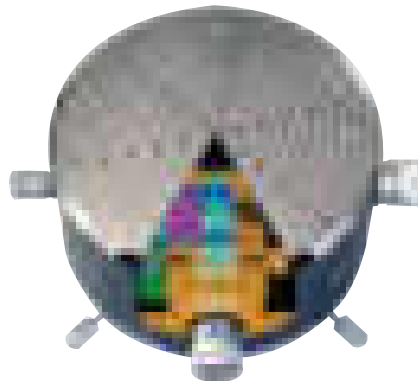

### Automatic continuous OD/ID measurement

Automatic measurement can be performed continuously from external diameter to internal diameter without having to change the probe position. This not only reduces measurement time, but eliminates the error factors otherwise involved in changing the probe position, greatly facilitating high-accuracy measurement.

The automatic centering/leveling mechanism incorporates a high-precision glass scale on each axis of the turntable. This allows feedback to be generated that prevents positioning errors from affecting centering/leveling adjustments. The high-speed, automatic, centering/leveling capability achieved greatly contributes to reducing the total measurement time from workpiece setting to workpiece measurement.

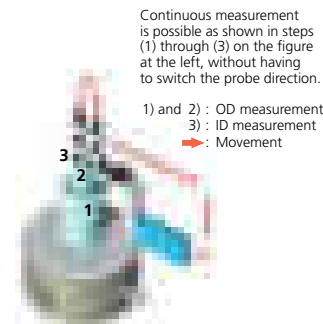

Continuous measurement is possible as shown in steps (1) through (3) on the figure at the left, without having to switch the probe direction.

1) and 2) : OD measurement  
 3) : ID measurement  
 → : Movement

# Roundtest RA-H5200AS / AH

## SERIES 211 — Roundness / Cylindricity Measuring System

### X-axis tracking measurement

Because of the linear scale incorporated into the X-axis, measurement can be performed by tracking the workpiece surface (tracking range:  $\pm 5\text{mm}$ ). This function is effective for measuring a workpiece with a displacement that exceeds the detection range of the probe in measuring roundness/cylindricity or a taper that is determined with slider/column movement.

### Surface roughness measurement function (Surface roughness unit: option)

A surface roughness detector, compliant with the relevant international standards, can be mounted in place of the roundness measuring detector. This creates a multiple sensor system that can not only test the geometrical roundness/cylindricity of a surface, but also the roughness of that surface.

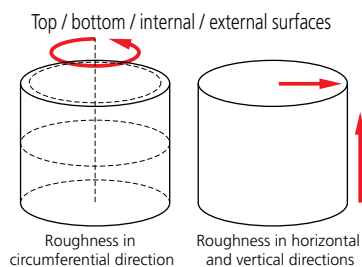
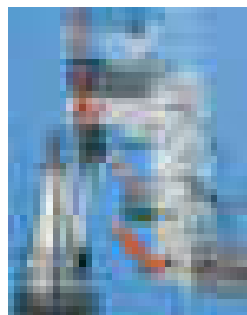

## SPECIFICATIONS

Model No.	RA-H5200AS	RA-H5200AH
Order No. * with vibration isolating stand	211-531A	211-532A
Column travel	13.77" (350mm) (standard column)	21.65" (550mm) (high column)

## DIMENSIONS

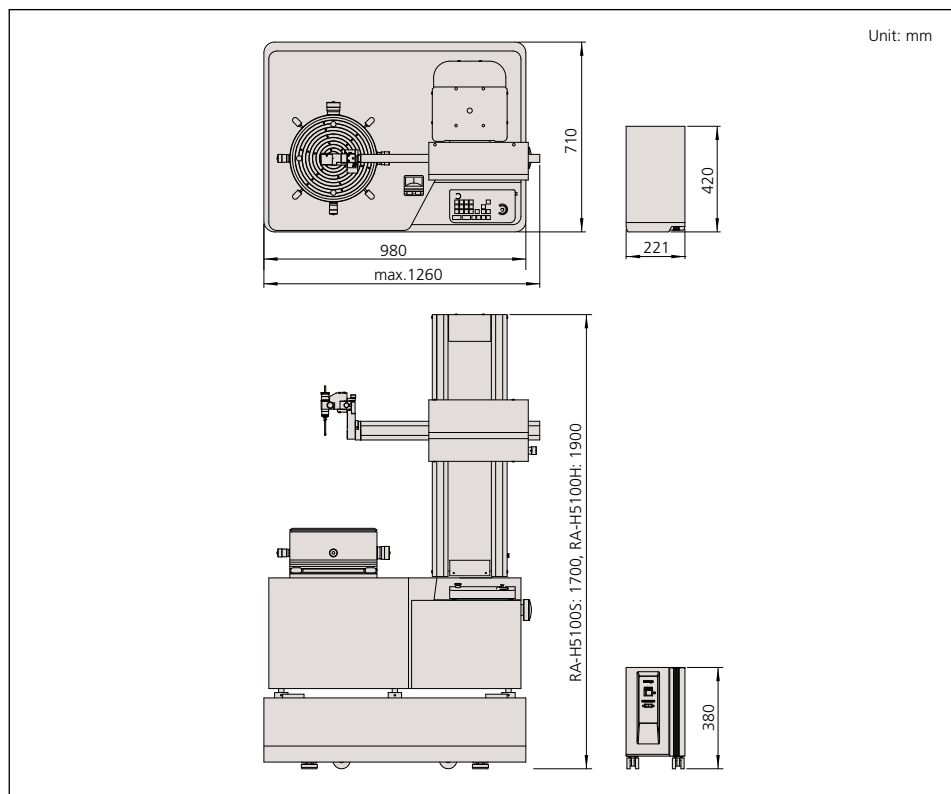

## Optional Accessories

- 350850: Cylindrical square
- 12AAF203: Extension probe holder (2X higher)
- 12AAF205: Extension probe holder (3X higher)
- 12AAF204: Auxiliary probe holder for a large diameter workpiece
- 211-045: Magnification calibration gage
- 211-014: Chuck (OD: 2 - 78mm, ID: 25 - 68mm)
- 211-032: Quick chuck (OD: 1 - 79mm, ID: 16 - 69mm)
- 211-031: Micro-chuck (OD: 0.1~1.5mm max.)
- 12AAB598: Protective shield
- : Interchangeable styli (See page J-49.)
- 12AAL019: Side table for PC



### Sliding detector-unit holder (Standard) 12AAL090

The detector-unit holder is equipped with a sliding mechanism, enabling one-touch measurement of a workpiece with a deep hole having a thick wall, which has been difficult with the conventional standard arm.

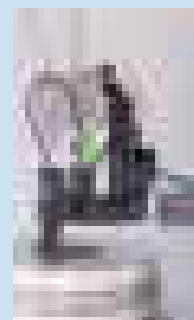

Sliding distance: 4.4" (112mm)

The detector-unit holder can be stopped at a position sufficiently higher than the workpiece along the Z-axis, and then lowered and positioned to make measurements. Furthermore, internal/external diameters can be easily measured with the continuous internal/external diameter measurement function\*.

\*: See page 41 for details about the continuous ID and OD measuring function.

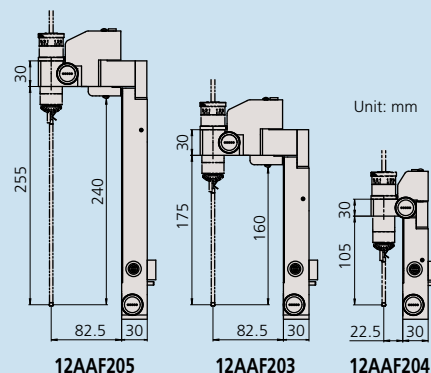



## Technical Data: RA-2200CNC

### Turntable

Rotational accuracy (radial):  $\{(0.02+3.5H/10000)\mu\text{m}\}$   
Rotational accuracy (axial):  $\{(0.02+3.5X/10000)\mu\text{m}\}$   
H: Probing height (mm), X: Distance from the turntable axis (mm)  
Rotating speed: 2, 4, 6, 10rpm  
Tabletop diameter:  $\varnothing 9.25"$  (235mm)  
Centering range:  $\pm 3\text{mm}$   
Leveling range:  $\pm 1^\circ$   
Maximum probing diameter:  $\varnothing 10.1"$  (256mm)  
Maximum workpiece diameter:  $\varnothing 22.8"$  (580mm)  
Maximum workpiece weight: 66 lbs (30kg)

### Vertical column (Z-axis)

Vertical travel: 11.8" (300mm) 19.7" (500mm: 2200H model)  
Straightness (c2.5): 0.10 $\mu\text{m}$  / 100mm, 0.15 $\mu\text{m}$  / 300mm  
(0.25 $\mu\text{m}$  / 500mm: 2200H model)  
Parallelism with rotating axis: 0.7 $\mu\text{m}$  / 300mm  
(1.2 $\mu\text{m}$  / 500mm: 2200H model)  
Positioning speed: Max. 50mm/s  
Measuring speed: 0.5, 1, 2, 5mm/s  
Maximum probing height: 11.8" (300mm) (OD / ID)  
[19.7" (500mm) (OD / ID): 2200H model]  
Maximum probing depth: over  $\varnothing 32$ : 104mm (w/standard stylus)  
over  $\varnothing 12.7$ : 26mm (w/standard stylus)

### Horizontal arm (X-axis)

Horizontal travel: 6.9" (175mm) (Including a protrusion of  
1" (25mm) the turntable rotation center)  
Straightness (c2.5): 0.7 $\mu\text{m}$  / 150mm  
Squareness with rotating axis: 1.0 $\mu\text{m}$  / 150mm  
Positioning speed: Max. 30mm/s  
Measuring speed: 0.5, 1, 2, 5mm/s

### Probe and stylus

Measuring range:  $\pm 400\mu\text{m}/\pm 40\mu\text{m}/\pm 4\mu\text{m}$  ( $\pm 5\text{mm}$ : tracking range)  
Measuring force: 40mN (not adjustable)  
Standard stylus: **12AAE301**, carbide ball,  $\varnothing 1.6\text{mm}$   
Measuring direction: one direction  
Stylus angle adjustment:  $\pm 45^\circ$  (with graduations)

### Air supply

Air pressure: 390kPa (4kgf/cm<sup>2</sup>)  
Air consumption: 30L/min.

### Power supply:

100V AC – 240V AC, 50/60Hz

### Dimensions (W x D x H):

26.3 x 20 x 35.4"  
(667 x 510 x 900mm)  
(26.3 x 20 x 43.3"  
(667 x 510 x 1100mm): 2200H model)

### Mass:

397 lbs (180kg) (441 lbs (200kg): 2200H model)

## Technical Data: RA-H5200CNC

### Turntable

Rotational accuracy (radial):  $\{(8+35H)\mu\text{in}\}$   $\{(0.02+3.5H/10000)\mu\text{m}\}$   
Rotational accuracy (axial):  $\{(8+35X)\mu\text{in}\}$   $\{(0.02+3.5X/10000)\mu\text{m}\}$   
H: Probing height (mm), X: Distance from the turntable axis (mm)  
Rotating speed: 2, 4, 6, 10rpm (20rpm: auto-centering)  
Table top diameter:  $\varnothing 300\text{mm}$   
Centering range:  $\pm 5\text{mm}$   
Leveling range:  $\pm 1^\circ$   
Maximum probing diameter:  $\varnothing 14"$  (356mm)  
Maximum workpiece diameter:  $\varnothing 26.8"$  (680mm)  
Maximum workpiece weight: 176 lbs (80kg)  
143 lbs (65kg): auto-centering

### Vertical column (Z-axis)

Vertical travel: 13.7" (350mm) 21.7" (550mm): H5200H model  
Straightness ( $\lambda$ c2.5): 0.05 $\mu\text{m}$  / 100mm, 0.14 $\mu\text{m}$  / 350mm  
(0.2 $\mu\text{m}$  / 550mm: H5200H model)  
Parallelism with rotating axis: 0.2 $\mu\text{m}$  / 350mm  
(0.32 $\mu\text{m}$  / 550mm: H5200H model)  
Positioning speed: Max. 60mm/s  
Measuring speed: 0.5, 1, 2, 5mm/s  
Maximum probing height: 13.7" (350mm) (OD / ID)  
[21.7" (550mm) (OD / ID): H5200H model]  
Maximum probing depth: over  $\varnothing 32$ : 104mm (w/standard stylus)  
over  $\varnothing 12.7$ : 26mm (w/standard stylus)

### Horizontal arm (X-axis)

Horizontal travel: 8.8" (225mm)  
Straightness ( $\lambda$ c2.5): 0.4 $\mu\text{m}$  / 200mm  
Squareness with rotating axis: 0.5 $\mu\text{m}$  / 200mm  
Positioning speed: Max. 50mm/s  
Measuring speed: 0.5, 1, 2, 5mm/s

### Probe and stylus

Measuring range:  $\pm 400\mu\text{m}$  ( $\pm 5\text{mm}$ : tracking range)  
Measuring force: 40mN (not adjustable)  
Standard stylus: **12AAE301**, carbide ball,  $\varnothing 1.6\text{mm}$   
Measuring direction: one direction  
Stylus angle adjustment:  $\pm 45^\circ$  (with graduations)

### Air supply

Air pressure: 390kPa (4kgf/cm<sup>2</sup>)  
Air consumption: 45L/min.

### Power supply:

100V AC – 240V AC, 50/60Hz

### Dimensions (W x D x H):

49.6 x 28.0 x 66.9"  
(1260 x 710 x 1700mm)  
49.6 x 28.0 x 74.8"  
(1260 x 710 x 1900mm: H5200H model)

### Mass:

Main unit: 1433 lbs (650kg)  
1477 lbs (670kg): H5200H (model)

### Vibration isolator:

375 lbs (170kg)

# Roundtest Extreme RA-2200CNC / RA-H5200CNC

## SERIES 211 — CNC Roundness, Cylindricity and Surface Roughness Measuring System

Mitutoyo offers innovative roundness/ cylindricity measuring systems capable of automated measurement with independent/ simultaneous multi-axis CNC control. In addition to high measuring accuracy and reliability, these CNC models provide excellent inspection productivity. Roundness and surface roughness measurements are both available from a single measuring system so workpiece resetting for roughness measurement is not required. Roughness measurement is possible in the axial and circumferential directions.

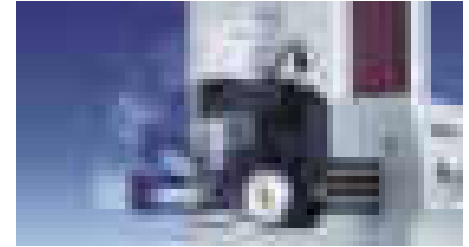

Holder-arm orientation switching (vertical position - horizontal position)

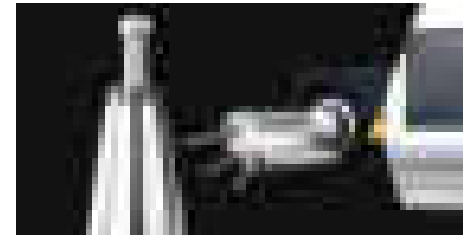

Detector rotation mechanism (0 to 290°, in increments of 1°)



**RA-2200H CNC**  
with personal computer  
system and software

\* Shown with optional  
vibration isolator and side  
table for PC.



**RA-H5200H CNC**  
with personal computer system  
and software

\* Shown with optional  
side table for PC.

# Mitutoyo

# Roundtest Extreme RA-2200CNC / RA-H5200CNC

## SERIES 211 — CNC Roundness, Cylindricity and Surface Roughness Measuring System

### ROUNDPAK

#### Off-line measurement procedure programming function

On-screen virtual 3D simulation measurements can be performed with the incorporated off-line teaching function that allows a part program (measurement procedure) to be created without an objective workpiece. The probe and the holder unit of the Roundtest Extreme can be precisely represented and an alarm can be raised to indicate that there is a collision risk predicted by the simulation.



3D simulation screens (work-view windows) can be generated after entering CAD data (in IGES, DXF form) and text data.

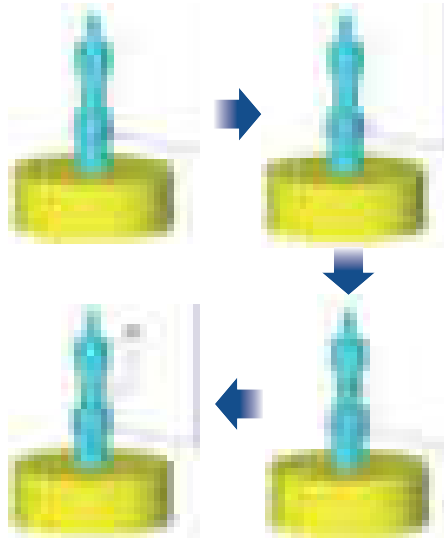

### SPECIFICATIONS

Model No.	EXTREME RA-2200S CNC	EXTREME RA-2200H CNC
Order No.	<b>211-517A</b>	<b>211-518A</b>
Column travel	11.8" (300mm) (standard column)	19.7" (500mm) (high column)

Model No.	EXTREME RA-H5200S CNC	EXTREME RA-H5200H CNC
Order No. with vibration isolating stand	<b>211-533A</b>	<b>211-534A</b>
Column travel	13.77" (350mm) (standard column)	21.65" (550mm) (high column)

### DIMENSIONS

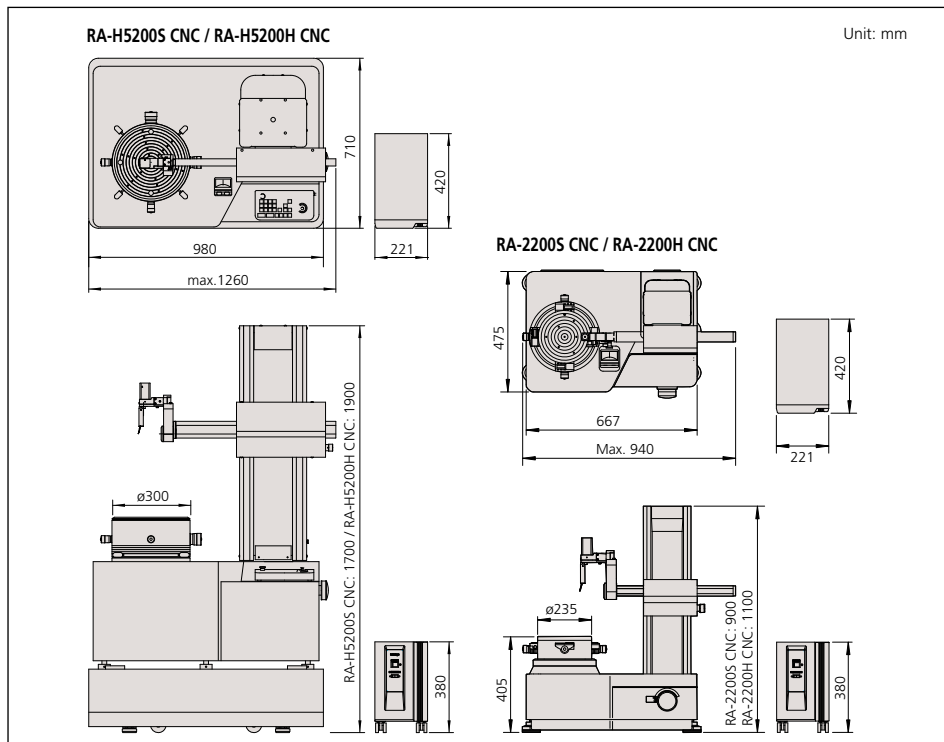

### Optional Accessories

- 350850:** Cylindrical square
- 211-045:** Magnification calibration gage
- 211-014:** Chuck (OD: 1 - 78mm, ID: 25 - 68mm)
- 211-032:** Quick chuck (OD: 1 - 79mm, ID: 16 - 69mm)
- 211-031:** Micro-chuck (OD: 0.1-1.5mm max.)
- 12AAB598:** Protective shield (RA-H5200 only)
- Interchangeable styli (See page J-49.)
- 12AAK110:** Vibration isolator (RA-2200 only)
- 12AAK120:** Monitor arm (RA-2200 only)
- 12AAL019:** Side table for PC
- 12AAG419:** Surface roughness detector for RA-CNC



### Dimensions

Overall: 36 x 30 x 24-32" (W x D x H)  
 Cord Bin: 4" h x 5-3/8" d (width is 10" less than table width)  
 Distance From Front Edge to Cord Bin: 30" d table - 15-1/2" d  
 Distance Between Legs: 10" less than the overall table width

Work surface feature a 1", 45 lb density, furniture board substrate with attractive Gray laminate tabletop brimmed with bullnose edge band in Quartz gray color. Work surface is height adjustable in one inch increments from 24" to 32".

Tabletop incorporates metal threaded inserts on the underside to affix the leg assemblies for added strength and durability. Table comes with 4" casters with two as locking type for stationary placement.

\*Laptop PC not included with table.

# Optional Styli for Roundtest

## Interchangeable Styli for RA-120, RA-120P, RA-1600/M, RA-2200, RA-H5200

Application/Type	Standard (Standard accessory)	Notch	Deep groove	Corner	Cutter mark
Order No.	<b>12AAL021*</b>	<b>12AAL022</b>	<b>12AAL023</b>	<b>12AAL024</b>	<b>12AAL025</b>
Stylus tip	ø1.6 mm tungsten carbide	ø3 mm tungsten carbide	SR0.25mm sapphire	SR0.25mm sapphire	tungsten carbide
Dimensions (mm)					
Application/Type	Small hole (ø0.8)	Small hole (ø1.0)	Small hole (ø1.6)	Extra small hole (Depth 3mm)	ø1.6 mm ball
Order No.	<b>12AAL026</b>	<b>12AAL027</b>	<b>12AAL028</b>	<b>12AAL029</b>	<b>12AAL030</b>
Stylus tip	ø0.8 mm tungsten carbide	ø1 mm tungsten carbide	ø1.6 mm tungsten carbide	ø0.5 mm tungsten carbide	ø1.6 mm tungsten carbide
Dimensions (mm)					
Application/Type	Disk	Crank (ø0.5)	Crank (ø1.0)	Flat surface	2X-long type**
Order No.	<b>12AAL031</b>	<b>12AAL032</b>	<b>12AAL033</b>	<b>12AAL034</b>	<b>12AAL035</b>
Stylus tip	ø12 mm tungsten carbide	ø0.5 mm tungsten carbide (Depth 2.5 mm)	ø1 mm tungsten carbide (Depth 5.5 mm)	tungsten carbide	ø1.6 mm tungsten carbide
Dimensions (mm)					
Application/Type	2X-long type notch**	2X-long type deep groove**	2X-long type corner**	2X-long type cutter mark**	2X-long type Small hole**
Order No.	<b>12AAL036</b>	<b>12AAL037</b>	<b>12AAL038</b>	<b>12AAL039</b>	<b>12AAL040</b>
Stylus tip	ø3 mm tungsten carbide	SR0.25 mm sapphire	SR0.25 mm sapphire	tungsten carbide	ø1 mm tungsten carbide
Dimensions (mm)					
Application/Type	3X-long type**	3X-long type deep groove**	Stylus shank	Stylus shank (standard groove)	Stylus shank (2X-long groove)**
Order No.	<b>12AAL041</b>	<b>12AAL042</b>	<b>12AAL043</b>	<b>12AAL044</b>	<b>12AAL045</b>
Stylus tip	ø1.6 mm tungsten carbide	SR0.25 mm sapphire	For mounting CMM stylus (mounting thread M2)	For mounting CMM stylus (mounting thread M2)	For mounting CMM stylus (mounting thread M2)
Dimensions (mm)					

\* 12AAL021 is a standard accessory for all Roundtest models.

\*\* Not available for RA-10, RA-120P and RA-220

Measuring is only in the vertical direction. Measuring magnification of 20000X is available using the 2X-long stylus.

Customized special interchangeable styli are available on request. Please contact any Mitutoyo office for more information.

† New design for holding styli is not shown in above illustrations.

New styli for RA-2200 / H5200 are compatible with old RA-2100 / H5100 detectors.

Old styli for RA-2100 / H5100 are NOT compatible with new RA-2200 / H5200 detectors.

### 5 pc. Stylus set: 12AAL020

Part No.	Part Description
12AAL022	Stylus for notched workpiece
12AAL023	Stylus for deep groove
12AAL027	Stylus for small hole (1.0mm)
12AAL030	1.6mm ball stylus
12AAL035	2X-long type stylus

### M2 CMM stylus with ruby ball tip

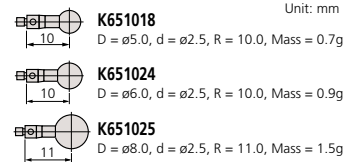
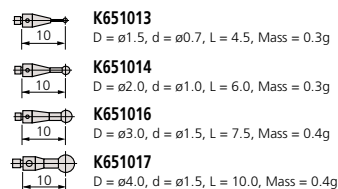
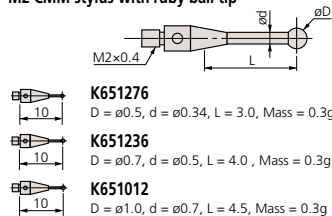

# Optional Styli for Roundtest

## Interchangeable Styli for RA-2200 CNC, RA-H5200 CNC

Application/Type	Groove	Flat surface	General purpose	Notch
Order No.	<b>12AAE310</b>	<b>12AAE302</b>	<b>12AAE301</b>	<b>12AAE309</b>
Stylus tip	ø1.6 mm tungsten carbide	ø1.6 mm tungsten carbide	ø1.6 mm tungsten carbide	ø3 mm tungsten carbide
Dimensions (mm)				
Application/Type	ø1.6 mm ball	ø0.8 mm ball	ø0.5 mm ball	Deep groove
Order No.	<b>12AAE303</b>	<b>12AAE304</b>	<b>12AAE305</b>	<b>12AAE308</b>
Stylus tip	ø1.6 mm tungsten carbide	ø0.8 mm tungsten carbide	ø0.5 mm tungsten carbide	ø1.6 mm tungsten carbide
Dimensions (mm)				
Application/Type	Deep hole A		Deep hole B	
Order No.	<b>12AAE306</b>		<b>12AAE307</b>	
Stylus tip	ø1.6 mm tungsten carbide		ø1.6 mm tungsten carbide	
Dimensions (mm)				

Analysis options		RA-H5200CNC/ RA-H5200	RA-2200CNC/ RA-2200	RA-1600	RA-1600M	RA-120P	RA-120
Roundness	○	●	●	●	●	●	●
Cylindricity	∅	●	●	●	●	—	—
Concentricity	◎	●	●	●	●	●	●
Coaxiality	axis-element	●	●	●	●	●	●
	Axis-axis	●	●	●	●	●	—
Flatness	□	●	●	●	▲	●	●
Parallelism	//	●	●	●	▲	●	●
Perpendicularity	⊥	●	●	●	●	●	●
Runout	↗	●	●	●	●	●	●
Total runout	↗↖	●	●	●	▲	—	—
Straightness	—	●	●	●	▲	—	—
Inclination	/	●	●	●	▲	—	—
Taper	/\	●	●	●	▲	—	—

● Full measurement capability

▲ Limited measurement capability; R-Axis must be stationary.

### Usage examples of styli

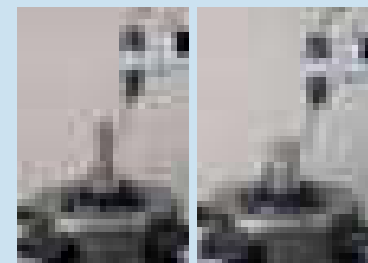

Cutter mark

Corner

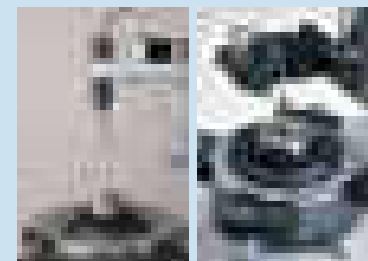

Small hole

Small hole

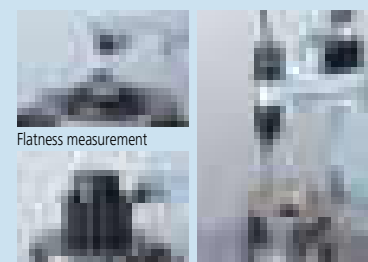

Flatness measurement

ID measurement

# Optional Accessories for Roundtest

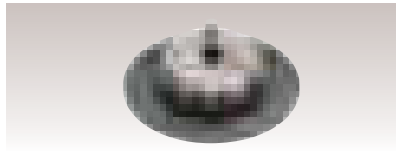

## Centering chuck (ring operated) 211-032

Suitable for holding small parts with easy-to-operate knurled-ring clamping.

- Holding capacity:  
Internal jaws: OD = 1-36 mm, ID = 14-70 mm.  
External jaws: OD = 1-75 mm.
- External dimensions:  $\phi 118 \times 41$  mm
- Mass: 1.2kg

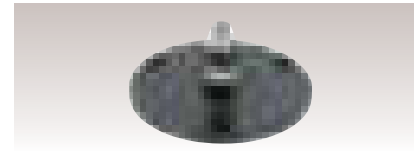

## Micro-chuck 211-031

Used for clamping a workpiece (less than  $\phi 1$  mm dia.) that the centering chuck cannot handle.

- Holding capacity: up to  $\phi 1.5$  mm
- External dimensions:  $\phi 118 \times 48.5$  mm
- Mass: 0.8kg

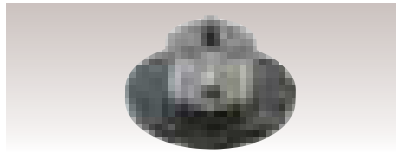

## Centering chuck (key operated) 211-014

Suitable for holding longer parts and those requiring a relatively powerful clamp.

- Holding capacity:  
Internal jaws: OD = 1 - 35mm, ID = 33 - 85mm  
External jaws: OD = 30-80mm.
- External dimensions:  $\phi 157 \times 76$ mm
- Mass: 3.8kg

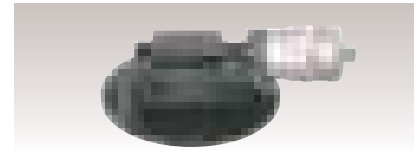

## Magnification calibration gage 211-045

Used for normalizing detector magnification by calibrating detector travel against displacement of a micrometer spindle.

- Maximum calibration range: 400 $\mu$ m
- Graduation: 0.2 $\mu$ m
- Mass: 4kg

## Vibration Isolated frame with work surface

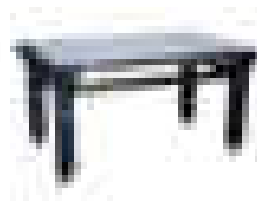

Code No.	Dimensions	Load Capacity
64AAB357	30 x 48 x 30"	1300 lbs



## Auxiliary workpiece stand 356038

- Used for measuring a workpiece whose diameter is 20mm or shorter and whose height is 20mm or lower.



211-016  
Reference Hemisphere



## Cylindrical square 350850

- Used for checking and aligning table rotation axis parallel to the Z-axis column.
- Squareness: 3 $\mu$ m
- Straightness: 1 $\mu$ m
- Cylindricity: 2 $\mu$ m
- Roundness: 0.5 $\mu$ m
- Mass: 7.5kg

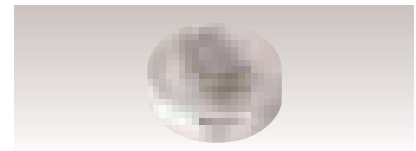

## Magnification checking kit\* 997090

- A combination of gage blocks and an optical flat.
- \* Standard accessory for RA-2200, RA-2200CNC, RA-H5200 and RA-H5200CNC

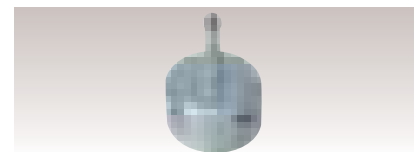

## Origin-point gage\* 998382

- A gage for zero setting of the R-axis and Z-axis.
- \* Standard accessory for RA-2200 and RA-H5200

# Eco-Fix Kit Form-S

## Mitutoyo ECO-FIX Kit Fixture Systems



Part No.	Qty.	Part name	Part No.	Qty.	Part name
K551038	1	Adaptor plate $\varnothing$ 150mm	K551069	1	Flat top $\varnothing$ 12mm
K551024	1	Location pin $\varnothing$ 12 X 13mm	K550262	1	V-block mini
K551025	1	Location pin $\varnothing$ 12 X 25mm	K550261	2	Cone receiver mini
K551026	1	Location pin $\varnothing$ 12 X 50mm	K550250	1	Stopper element mini
K551027	1	Location pin $\varnothing$ 12 X 100mm	K550247	1	Back square mini
K551028	1	Location pin $\varnothing$ 20 X 13mm	K550888	2	Straight pin $\varnothing$ 6mm x 20mm
K551029	1	Location pin $\varnothing$ 20 X 25mm	K550889	2	Straight pin $\varnothing$ 6mm x 30mm
K551030	1	Location pin $\varnothing$ 20 X 50mm	K550890	2	Straight pin $\varnothing$ 6mm x 40mm
K551031	1	Location pin $\varnothing$ 20 X 100mm	K551046	1	Slotted nut for receiver bracket h=12mm
K551035	1	Receiver bracket small	K551050	1	Allen key 2mm
K551036	1	Receiver bracket large	K551051	1	Allen key 3mm
K551040	1	Adjustable location pin $\varnothing$ 20mm	K551052	1	Allen key 4mm
K551041	1	Adjustable location pin $\varnothing$ 12mm	K551053	1	Allen key 5mm
K551042	3	Location pin $\varnothing$ 12mm with bore $\varnothing$ 6mm	K551054	1	Double open ended spanner 10-17
K551044	1	Receiver bracket L=90; $\varnothing$ 12mm	K550591	1	Washer $\varnothing$ 6,4mm / $\varnothing$ 17mm
K550716	1	Straight pin with thread	K550110	8	Cylinder head screw M6 x 20mm
K550279	1	Spring clip, d= 8mm, L= 60mm	K550563	6	Cylinder head screw M6 x 25mm
Kit Part No.			K551133		

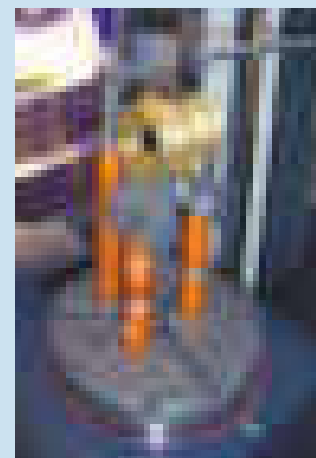

# Eco-Fix Kit Form-L

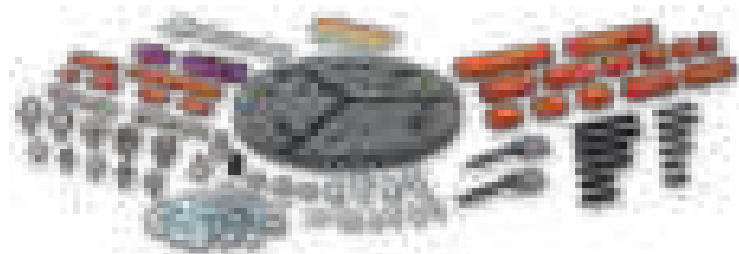

Part No.	Qty.	Part name	Part No.	Qty.	Part name
K551039	1	Adaptor plate $\varnothing$ 200mm	K550247	1	Back square mini
K551024	1	Location pin $\varnothing$ 12 X 13mm	K550058	1	V-block
K551025	1	Location pin $\varnothing$ 12 X 25mm	K550365	2	Cone receiver
K551026	1	Location pin $\varnothing$ 12 X 50mm	K550982	1	Stopper element
K551027	2	Location pin $\varnothing$ 12 X 100mm	K550248	1	Back square
K551028	2	Location pin $\varnothing$ 20 X 13mm	K550888	2	Straight pin $\varnothing$ 6mm x 20mm
K551029	2	Location pin $\varnothing$ 20 X 25mm	K550889	2	Straight pin $\varnothing$ 6mm x 30mm
K551030	2	Location pin $\varnothing$ 20 X 50mm	K550890	2	Straight pin $\varnothing$ 6mm x 40mm
K551031	1	Location pin $\varnothing$ 20 X 100mm	K550000	2	Straight pin $\varnothing$ 8mm x 30mm
K551035	1	Receiver bracket small	K550001	2	Straight pin $\varnothing$ 8mm x 50mm
K551036	1	Receiver bracket large	K550002	2	Straight pin $\varnothing$ 8mm x 95mm
K551040	2	Adjustable location pin $\varnothing$ 20mm	K551046	1	Slotted Nut for receiver bracket h= 12mm
K551041	1	Adjustable location pin $\varnothing$ 12mm	K551047	1	Slotted Nut for receiver bracket h= 15mm
K551042	2	Location pin $\varnothing$ 12mm with bore $\varnothing$ 6mm	K551050	1	Allen key 2mm
K551043	3	Location pin $\varnothing$ 20mm with bore $\varnothing$ 8mm	K551051	1	Allen key 3mm
K551044	1	Receiver bracket L=90; $\varnothing$ 12mm	K551052	1	Allen key 4mm
K551045	1	Receiver bracket L=120; $\varnothing$ 20mm	K551053	1	Allen key 5mm
K550279	2	Spring clip, d= 8mm, L= 60mm	K550591	1	Washer $\varnothing$ 6,4mm / $\varnothing$ 17mm
K550262	1	V-block mini	K550110	12	Cylinder head screw M6 x 20mm
K550261	2	Cone receiver mini	K550563	6	Cylinder head screw M6 x 25mm
K550250	1	Stopper element mini			
Kit Part No.			K551134		

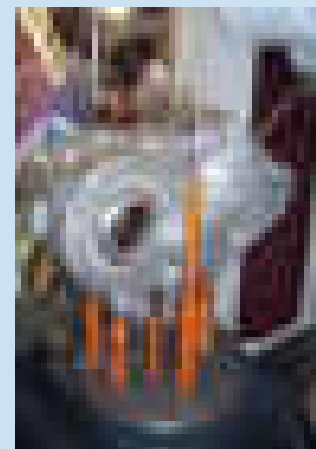

# Quick Guide to Precision Measuring Instruments

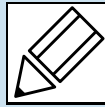

## Roundtest (Roundform Measuring Instruments)

- JIS B 7451-1997: Roundness measuring instruments
- JIS B 0621-1984: Definition and notation of geometric deviations
- JIS B 0021-1998: Geometric property specifications touching of products – Geometric tolerance Roundness Testing

### ○ Roundness

Any circumferential line must be contained within the tolerance zone formed between two coplanar circles with a difference in radii of  $t$

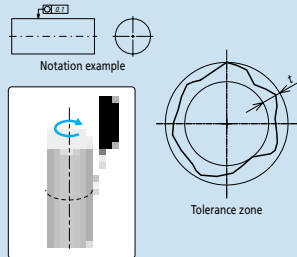

Verification example using a roundness measuring instrument

### — Straightness

Any line on the surface must lie within the tolerance zone formed between two parallel straight lines a distance  $t$  apart and in the direction specified

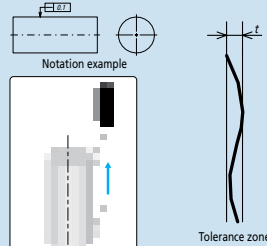

Verification example using a roundness measuring instrument

### □ Flatness

The surface must be contained within the tolerance zone formed between two parallel planes a distance  $t$  apart

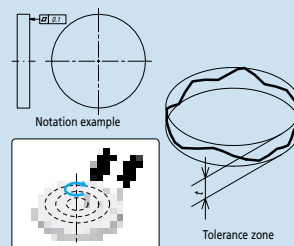

Verification example using a roundness measuring instrument

### ○/○ Cylindricity

The surface must be contained within the tolerance zone formed between two coaxial cylinders with a difference in radii of  $t$

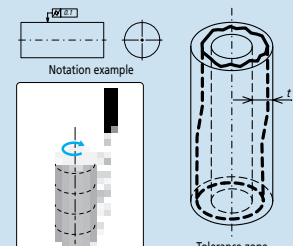

Verification example using a roundness measuring instrument

### ◎ Concentricity

The center point must be contained within the tolerance zone formed by a circle of diameter  $t$  concentric with the datum

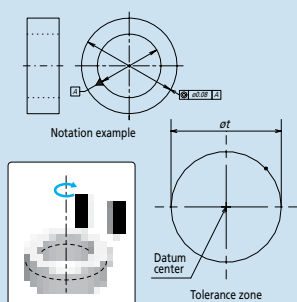

Verification example using a roundness measuring instrument

### ◎ Coaxiality

The axis must be contained within the tolerance zone formed by a cylinder of diameter  $t$  concentric with the datum

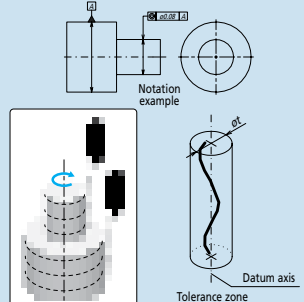

Verification example using a roundness measuring instrument

### ⊥ Perpendicularity

The line or surface must be contained within the tolerance zone formed between two planes a distance  $t$  apart and perpendicular to the datum

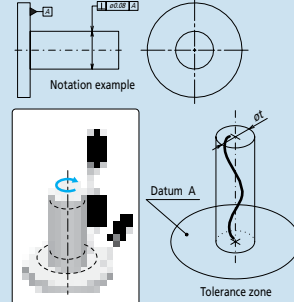

Verification example using a roundness measuring instrument

### ⊥ Perpendicularity

The line or surface must be contained within the tolerance zone formed between two planes a distance  $t$  apart and perpendicular to the datum

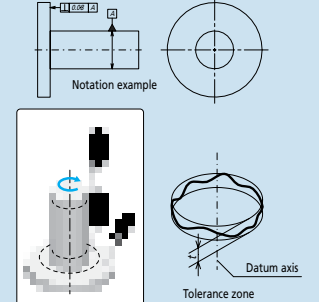

Verification example using a roundness measuring instrument

### ↻ Circular Runout

The line must be contained within the tolerance zone formed between two coplanar and/or concentric circles a distance  $t$  apart concentric with or perpendicular to the datum

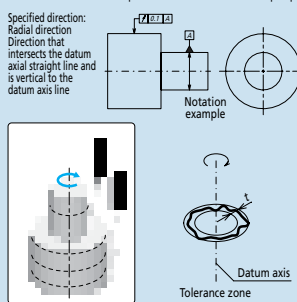

Verification example using a roundness measuring instrument

### ↻ Total Runout

The surface must be contained within the tolerance zone formed between two coaxial cylinders with a difference in radii of  $t$ , or planes a distance  $t$  apart, concentric with or perpendicular to the datum

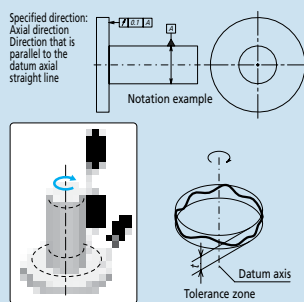

Verification example using a roundness measuring instrument

### ↻ Total Runout

The surface must be contained within the tolerance zone formed between two coaxial cylinders with a difference in radii of  $t$ , or planes a distance  $t$  apart, concentric with or perpendicular to the datum

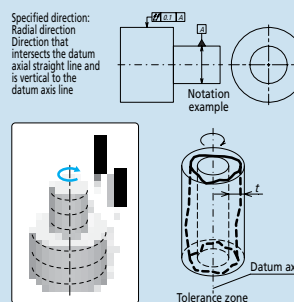

Verification example using a roundness measuring instrument

### ↻ Total Runout

The surface must be contained within the tolerance zone formed between two coaxial cylinders with a difference in radii of  $t$ , or planes a distance  $t$  apart, concentric with or perpendicular to the datum

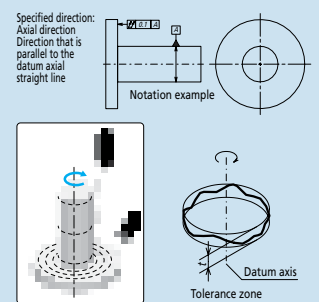

Verification example using a roundness measuring instrument

## ■ Adjustment prior to Measurement

### Centering

A displacement offset (eccentricity) between the Roundtest's rotary table axis and that of the workpiece results in distortion of the measured form (limaçon error) and consequentially produces an error in the calculated roundness value. The larger the eccentricity, the larger is the error in calculated roundness. Therefore the workpiece should be centered (axes made coincident) before measurement. Some roundness testers support accurate measurement with a limaçon error correction function. The effectiveness of this function can be seen in the graph below.

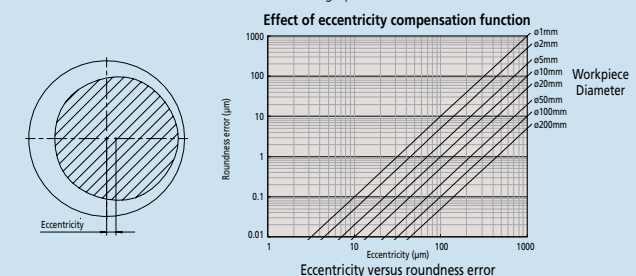

### Leveling

Any inclination of the axis of a workpiece with respect to the rotational axis of the measuring instrument will cause an elliptic error. Leveling must be performed so that these axes are sufficiently parallel.

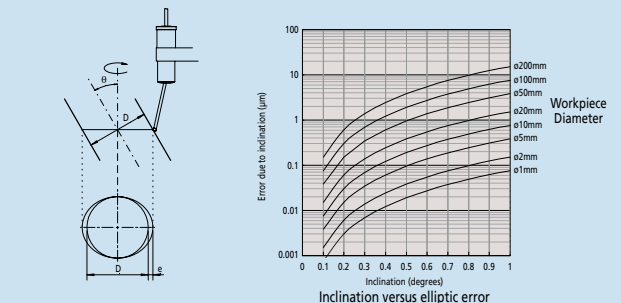

## Effect of Filter Settings on the Measured Profile

Roundness values as measured are greatly affected by variation of filter cutoff value. It is necessary to set the filter appropriately for the evaluation required.



## Evaluating the Measured Profile Roundness

Roundness testers use the measurement data to generate reference circles whose dimensions define the roundness value. There are four methods of generating these circles, as shown below, and each method has individual characteristics so the method that best matches the function of the workpiece should be chosen.

### Least Square Circle (LSC) Method

A circle is fitted to the measured profile such that the sum of the squares of the departure of the profile data from this circle is a minimum. The roundness figure is then defined as the difference between the maximum departures of the profile from this circle (highest peak to the lowest valley).

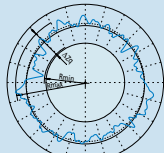

$$\Delta Zq = R_{max} - R_{min}$$

### Minimum Zone Circles (MZC) Method

Two concentric circles are positioned to enclose the measured profile such that their radial difference is a minimum. The roundness figure is then defined as the radial separation of these two circles.

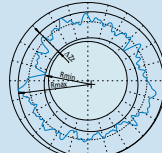

$$\Delta Zq = R_{max} - R_{min}$$

### Minimum Circumscribed Circle (MCC) Method

The smallest circle that can enclose the measured profile is created. The roundness figure is then defined as the maximum departure of the profile from this circle. This circle is sometimes referred to as the 'ring gage' circle.

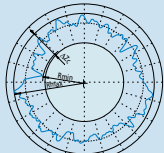

$$\Delta Zc = R_{max} - R_{min}$$

### Maximum Inscribed Circle (MIC) Method

The largest circle that can be enclosed by the profile data is created. The roundness figure is then defined as the maximum departure of the profile from this circle. This circle is sometimes referred to as the 'plug gage' circle.

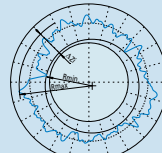

$$\Delta Zi = R_{max} - R_{min}$$

## Undulations Per Revolution (UPR) data in the roundness graphs

### Measurement result graphs

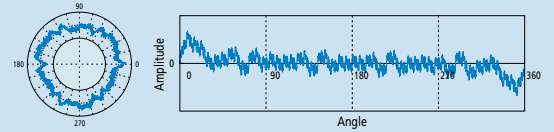

A 1 UPR condition indicates eccentricity of the workpiece relative to the rotational axis of the measuring instrument. The amplitude of undulation components depends on the leveling adjustment.

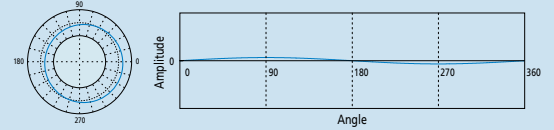

A 2 UPR condition may indicate: (1) insufficient leveling adjustment on the measuring instrument; (2) circular runout due to incorrect mounting of the workpiece on the machine tool that created its shape; (3) the form of the workpiece is elliptical by design as in, for example, an IC-engine piston.

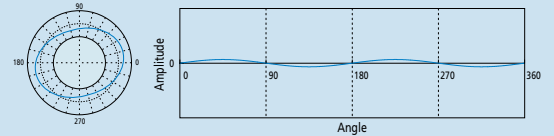

A 3 to 5 UPR condition may indicate: (1) Deformation due to over-tightening of the holding chuck on the measuring instrument; (2) Relaxation deformation due to stress release after unloading from the holding chuck on the machine tool that created its shape.

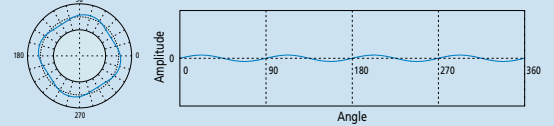
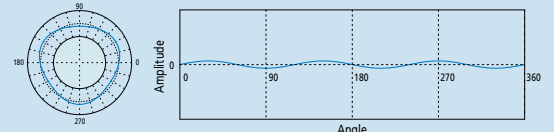

A 5 to 15 UPR condition often indicates unbalance factors in the machining method or processes used to produce the workpiece.

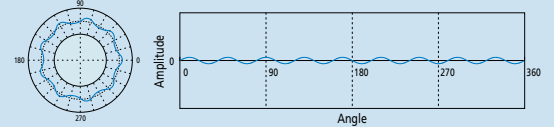
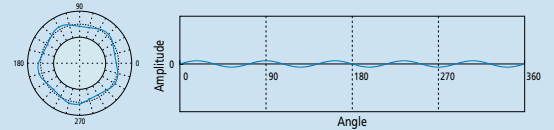

A 15 (or more) UPR condition is usually caused by tool chatter, machine vibration, coolant delivery effects, material non-homogeneity, etc., and is generally more important to the function than to the fit of a workpiece.

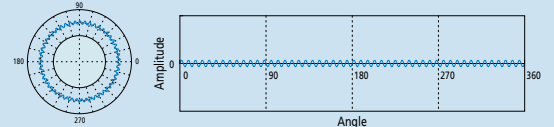
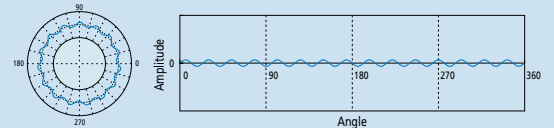



# K

## Test Equipment

### INDEX

#### Test Equipment

##### Micro Hardness Testing Machines

Lineup of Hardness Testing Machines	K-2
HM-210 / 220 Type A	K-3
HM-200 Series with AVPAK Software	K-4
MZT-500	K-5
HV-110 / 120	K-6, 7
Optional Accessories Micro-Vickers/Vickers Hardness Testing Machine	K-8

##### Rockwell Hardness Testing Machines

HR-530/530L	K-9
HR-523/523L	K-10
Optional Accessories For Rockwell/Rockwell Superficial Hardness Testing Machine	K-11, 12

##### Portable Hardness Testing Machines

Hardmatic HH-411	K-13
Hardmatic HH-300	K-14
Hardmatic HH-300 Test Block Set	K-15
Quick Guide to Precision Measuring Instruments - Hardness Testing Machines	K-16, 17



### Micro Hardness Testing Machines

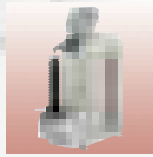

### Rockwell Hardness Testing Machines



### Micro Zone Test System



### Portable Hardness Testing Instruments



Hardmatic HH-411



HM-210D/220D



HV110 Type B



HH-300 Durometers

# Lineup of Hardness Testing Machines

Hardness testing machines provide the simplest and most economical testing methods among many material testing machines, playing an important role in research activities, production activities, and commercial transactions. Mitutoyo offers a choice of standard hardness testing machines that are optimal for hard materials such as metals to soft materials such as plastic and rubber, as well as custom-designed testers such as in line-type automatic machines and labor-saving machines required on the shop floor.



## Technical Data

Test force range:

HM-210A: 9 steps + arbitrary test force

HM-220A: 19 steps + arbitrary test force

Load dwell time: 0 - 999s

Manual XY stage unit

Stage size: 100x100mm

Travel range: 25x25mm

with Digimatic in/mm micrometer heads

Resolution: 0.001mm

Max. specimen height: 133mm (Stage size: 25 x 25mm)

Max. specimen height: 121mm (Stage size: 50 x 50mm)

Max. specimen depth: 160mm (from the center of indenter)

Optical path: 4-port objectives switching system of

Infinity-correction optical system

Resolution: 0.01µm (When using objectives of X40 or more)

Data output: Serial interface (RS-232),

Digimatic interface, USB 2.0

Power supply: 39VA 100-125/220-240V AC, 50/60Hz

Dimensions: (W x D x H): 315x671x595mm

Mass: 43kg

## Optional Accessories (Factory-installed option)

**11AAC104:** Objective lens unit 2X

**11AAC105:** Objective lens unit 5X

**11AAC106:** Objective lens unit 10X

**11AAC107:** Objective lens unit 20X

**11AAC108:** Objective lens unit 100X

**11AAC129:** Measuring microscope (Digital ocular)

**11AAC109:** Knoop Indenter Assembly (HM-210 Series)

**11AAC110:** Knoop Indenter Assembly (HM-220 Series)

## Optional Accessories

**810-454A:** TV camera unit (8.4 inch LCD)

**19BAA058:** Diamond indenter for Vickers (HM210 Series standard test force)

**19BAA059:** Diamond indenter for Vickers (HM220 Series low test force)

**19BAA061:** Diamond indenter for Knoop (HM210 Series)

**19BAA062:** Diamond indenter for Knoop (HM220 Series)

**810-013:** Specimen (thin plate) holder

**810-014-1:** Specimen (wire) holder

**810-015-1:** Specimen (wire or ball) holder

**810-016:** 50 mm Vise

**810-017:** 100 mm Vise

**810-019:** Specimen tilting holder

**810-020:** Universal specimen holder

**810-018:** Rotary table

**810-084:** Rotatable universal specimen holder

**810-085:** Adjustable specimen (thin plate) holder

**810-095:** Rotatable specimen stage

**375-056:** Stage Micrometer (glass) Micro-scale

**810-650-1:** Resin mold specimen stage ø25.4

**810-650-2:** Resin mold specimen stage ø30

**810-650-3:** Resin mold specimen stage ø31.75

**810-650-4:** Resin mold specimen stage ø38.1

**810-650-5:** Resin mold specimen stage ø40

**810-641:** Vibration Isolator

**810-870A:** Sample Heating Device HST-250

**810-420:** 25x25mm stage (metric only)

**810-423:** 50x50mm stage (metric only)

**810-424:** 1"x1" in/mm stage (standard)

**810-427:** 2"x2" in/mm stage



Power turret with up to 2 indenter mounts and 4 objective mounts (manual operation possible)

Touch-screen type control panel

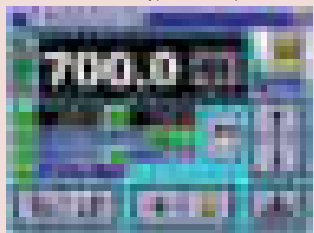

# HM-210 / 220 Type A

## SERIES 810 — Micro Vickers Hardness Testing Machines

### FEATURES

- The electromagnetic force motor used in the loading mechanism enables the test force to be freely selected (see test force specifications) over the wide range of 0.4903mN to 19610mN (0.05gf to 2 kgf). It is also possible to freely set load dwell times. Now your desire for absolute control over the indentation size in Vickers hardness testing can be satisfied. The HM-200 series always offers the test force most appropriate for the specimen material and shape.
- The long working distance objectives used enable a comfortable working distance between the objective and the specimen surface. This greatly reduces the possibility of collision between the specimen and the objective during focusing operations. (e.g. for 50X objectives: 1.1mm for conventional models, 2.5mm for HM-200 series)
- Newly-designed 'MH Plan' objectives are optimized for measuring indentation images. The lineup includes 6 types of long working distance objectives: 10X, 20X, 50X and 100X for measuring indentation images, and 2X and 5X for enabling wide-range measurement around indentations.
- LEDs, which have a longer life, produce less heat, consume less power and are more energy efficient than incandescent bulbs, are employed for the illumination system.
- The motorized turret allows for up to 4 objective lenses and 2 indenter assemblies to be mounted at the same time.



Observation image of the indentation (50X)



Stray light reduction around the indentation



HM-210A

### SPECIFICATIONS TYPE A Digital Hardness Tester

Model No.	HM-210 Type A	HM-210 Type A V/K	HM-220 Type A	HM-220 Type A V/K
<b>Part No.</b>	<b>64AAB305P</b>	<b>64AAB306P</b>	<b>64AAB307P</b>	<b>64AAB308P</b>
Fixed test force (mN)	98.07, 196.1, 294.2, 490.3, 980.7, 1961, 2942, 4903, 9807 (10gf-1000gf)		0.4903, 0.9807, 1.961, 2.942, 4.903, 9.807, 19.61, 29.42, 49.03, 98.07, 196.1, 294.2, 490.3, 980.7, 1961, 2942, 4903, 9807, 19610 (0.05 gf-2kgf)	
Arbitrary test force	≤100 gf in 1 gram increments, > 100gf in 10 gram increments		< 1 gf in .1 gf increments, ≤100 gf in 1 gram increments, > 100gf in 10 gram increments	
Test force control	Force generation by electromagnetic and automatic control (load, dwell, unload)			
Control unit	Color LCD Touch Screen			
Loading rate	60 µ/sec		60µm/s, Variable between 2 and 60µm/s. ≤ 30 gf.	
Load dwell time	0-999 sec			
Indenter	Vickers	Vickers and Knoop	Vickers	Vickers and Knoop
Objective lenses	10x, 50x	10x, 20x, 50x	10x, 50x, 100x	10x, 50x, 100x
Objective turret	Motor driven and manual operation			
Filar eye piece	Dual Line, 10X, .01µ min			

### With TV camera unit 810-454A (selectable with HM-210A/220A)

Measurement of indentation dimensions on a TV monitor reduces eye fatigue, which leads to improvement in operation efficiency in multi-point testing.



# HM-200 Series with AVPAK software

For semi and fully automatic Type B and D Systems



## System B (HM-210B/220B)

System B is equipped with **AVPAK-10**, a the software package that automatically measures the diagonal length of an indentation and calculates the corresponding hardness value. This means that measurement error caused by variation in operator interpretation is eliminated, thereby reducing costs.

Automatic measurement of indentation/ manual stage



AVPAK Software

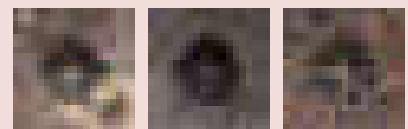

Indentation-reading example



## System D (HM-210D/220D)

In addition to the functions of System B, System D is equipped with the autofocus function and motorized x-y stage. This function allows for automatic hardness testing, thereby increasing efficiency and reducing labor costs.

Automatic measurement of indentation / motorized XY stage / Autofocusing

## System D Technical Data

Motorized X-Y Stage	Travel Max	50 x 50 mm*
	Travel Min	1μ
	Table Size	130 x 130mm
Motorized Focusing Stage	Speed Max	25mm/ sec
	Max Range	1.4mm
	Min Unit	.1μ
Joystick Controller Functions	Max Speed	1mm/ sec
	Functions	X and Y Lock out
	Axis	X, Y and Z (Focus)
	Speed Control	Adjustable H,M,L
	Tester Control	Indent, Turret Position
	Other	Emergency Stop

\*Optional 100 x 100 mm

## SPECIFICATIONS

**TYPE B** PC-Driven Test System    **TYPE D** PC-Driven Test System with motorized stage and auto focus

Model No.	HM-210 Type B	HM-210 Type B V/K	HM-220 Type B	HM-220 Type B V/K
Part No.	64AAB323P	64AAB324P	64AAB325P	64AAB326P
Model No.	HM-210 Type D	HM-210 Type D V/K	HM-220 Type D	HM-220 Type D V/K
Part No.	64AAB380P	64AAB381P	64AAB382P	64AAB383P
Fixed test force (mN)	98.07, 196.1, 294.2, 490.3, 980.7, 1961, 2942, 4903, 9807 (10gf-1000gf)		0.4903, 0.9807, 1.961, 2.942, 4.903, 9.807, 19.61, 29.42, 49.03, 98.07, 196.1, 294.2, 490.3, 980.7, 1961, 2942, 4903, 9807, 19610 (0.05 gf-2kgf)	
Arbitrary test force	≤100 gf in 1 gram increments, > 100gf in 10 gram increments		< 1 gf in .1 gf increments, ≤100 gf in 1 gram increments, > 100gf in 10 gram increments	
Test force control	Force generation by electromagnetic and automatic control (load, dwell, unload)			
Control unit	None, By PC*			
Loading rate	60 μ/ sec		60μm/s, Variable between 2 and 60μm/s. ≤ 30 gf.	
Load dwell time	0-999 sec			
Indenter	Vickers	Vickers and Knoop	Vickers	Vickers and Knoop
Objective lenses	10x, 50x	10x, 20x, 50x	10x, 50x, 100x	10x, 50x, 100x
Objective turret	Motor-driven and manual operation			
Filar eye piece	None			
CCTV camera	3 megapixel, 1/2"		3 megapixel, 1/2"	
Software	AV Pak		AV Pak	

\*Must use specified PC

# MZT-500

## SERIES 810 — Micro Zone Test System

### FEATURES

When it comes to evaluating mechanical properties of ultra-small regions of ultra-fine specimens, the MZT-500 Series models are exceptionally powerful tools in the fields of research and development and quality control. The MZT-500 can evaluate mechanical properties, which conventional

hardness testing machines for fine specimens cannot measure, such as various CVD and PVD-deposited or generated films, including ion-plated films; hardness of ultra-fine cross-sections; bonding mechanical properties; and mechanical wear properties of carbon fibers, glass fibers, whiskers, etc.

- Test data  
The indentation factor can be obtained, which is related to the hardness value (partially) shown in Martens hardness test (ISO14577) and Young's modulus. Deformation characteristics in the load, dwell, and unload phases are also obtainable for use in determining properties of the specimen material.
- Hardness tests such as Vickers and Knoop hardness tests are supported.
- The balance lever vibration isolation mechanism reduces the effect of external vibrations on measurements.
- Indenter indentation depth can be measured up to a maximum of 20 $\mu$ m with a resolution of 0.1nm.
- Test forces between 0.1mN and 1000mN can be applied electromagnetically for evaluation of material properties in submicroscopic areas.
- Field-compatible form with cover for protection against dust and wind.

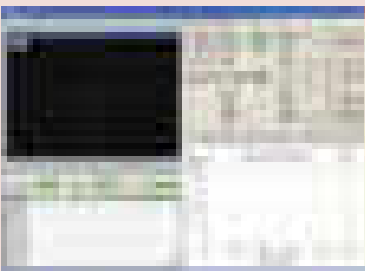
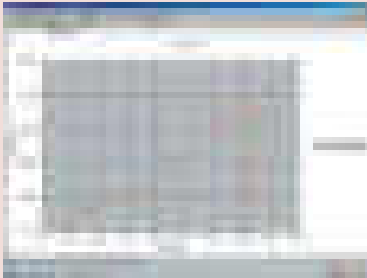

### SPECIFICATIONS

Model No.	MZT-500L	MZT-500P
<b>Order No.</b>	<b>810-813A</b>	<b>810-814A</b>
Basic system	✓	✓
Data analysis / control device	✓	✓
Manual type XY stage (Travel range 25x25mm)	✓	—
Automatic XY stage (Travel range: 50x50mm)	—	✓

Test force loading device	Test force range: 0.1 to 1000mN
	Control resolution: 0.916 $\mu$ N
	Loading speed: 0.01 to 100mN/s
Indentation depth measurement	Range: 0 to 20 $\mu$ m
	Resolution: 0.1nm
Indenter	Type: Bercovich triangular pyramid indenter
Sample surface observation method	Camera: 1/3 inch black and white (410,000 pixels)
	Objective (monitor magnification): 100X (2500X), Optional: 10X (250X), 40X (1000X)
Specimen dimensions	Maximum height: 90mm
	Maximum depth: 90mm (From the center of the indenter axis)
Test type	Indentation test (with preliminary test force)
	Indentation test (without preliminary test force)
	Indentation depth setting test, continuous indentation test, repeated indentation test

# HV110 / HV120

## Series 810—Vickers Hardness Testing Machines – Type A

### FEATURES

- Heavy load Vickers testing machines feature motorized force selection from 1-50kgf or .3 to 30kgf. Fully adjustable long-life LED illumination runs cool.
- A dual-line filar eyepiece combines with a color touch-screen LCD to create accurate measurements with the touch of a button.
- The motorized turret can accommodate up to 3 long working distance objective lenses for an even wider range of materials and a wide variety of anvils and x-y stages are also available.



HV120 show with optional  
810-454A CCTV Camera

### SPECIFICATIONS

Model	HV110	HV120
Order No.	810-441A	810-446A
Test force	9.807N (1kgf), 19.61N (2kgf), 29.42N (3kgf), 49.03N (5kgf), 98.07N (10kgf), 196.1N (20kgf), 294.2N (30kgf), 490.3N (50kgf)	2.942N (0.3kgf), 4.903N (0.5kgf), 9.807N (1kgf), 24.51N (2.5kgf), 49.03N (5kgf), 98.07N (10kgf), 196.1N (20kgf), 294.2N (30kgf)
Supported test method	HV, HK, HB (Light Force*), Kc	
Test force selection	Motorized	
Loading accuracy	±1%	
Load control	60µ/s, 150µ/s Automatic (loading, duration, unloading)	
Load rate	5~999 sec.	
Objective lens	2X, 5X, 10X (standard), 20X, 50X, 100X	
Measuring microscope	10X Dual-line filar	
Total magnification	20-1000X (100X Standard)	
Field of view	1,400µ (10X Lens) Type A	
Minimum reading	< 50x = 0.1µm, ≥50x = 0.01µm	
Display	Color LCD touch-screen	
Scaled conversion:	8 Types (ASTM, ISO, JIS, SAE and BS)	
Statistics:	N, Max., Min., Average, Range, High, Low, Good, Over, Under, SD(n-1), SD(n-1), SD(n) go/no-go judgment,	
Curvature correction;	0.01 to 200.00mm	
Maximum sample height	210mm Type A	
Maximum sample depth	160mm	
Maximum sample weight	20 Kg Anvil, 10 Kg with x-y Stage	
Optical path	100% Eyetube or Camera	
Output	Rs232, SPC, USB2.0	
Power supply	120 Volt AC/ 60 Hz	
Dimensions main unit (WxDxH)	9.9" x 24.7" x 30.7" (252x627x781mm)	
Mass	110lbs. (50kg)	

\* Optional test forces may be required.

### Optional Accessories

#### Lens:

- 11AAC712 OBJECTIVE LENS 2X
- 11AAC713 OBJECTIVE LENS 5X
- 11AAC714 OBJECTIVE LENS 20X
- 11AAC715 OBJECTIVE LENS 50X
- 11AAC716 OBJECTIVE LENS 100X

#### Stage

- 810-423 MANUAL STAGE 50X50
- 810-427 MANUAL STAGE 2" X 2" (In/mm)

- 959149 SPC cable (1m / 40")

#### Optical

- 11AAC711 "C" mount CAMERA ADAPTER
- 810-454A CCTV System

#### Indenters

- 19BAA060 DIAMOND INDENTER (VICKERS TYPE)
- 19BAA063 KNOOP DIAMOND INDENTER
- 19BAA281 CARBIDE-ALLOY BALL 1MM DIA.
- 11AAD469 CARBIDE-ALLOY INDENTER, 1MM DIA.
- 19BAA283 CARBIDE-ALLOY BALL, 2.5MM DIA.
- 11AAD470 CARBIDE-ALLOY INDENTER, 2.5MM DIA.

#### Additional Test Force

- 11AAC697 0.5 kg Brinell Weight
- 11AAC698 1.25 kg Brinell Weight
- 11AAC699 5.625 kg Brinell Weight
- 11AAC700 12.5 kg Brinell Weight

# HV110 / HV120

## Series 810—Vickers Hardness Testing Machines – Type B / D

### FEATURES

- The Type B HV110/ HV120 Vickers hardness testers add computer control to make measurements even more repeatable.
- A high-resolution 3 mega-pixel camera produces crisp images that are automatically measured in less than .3 seconds.
- Various software functions such as automatic light intensity, simple to use report generator and programming wizards make tedious and repetitive testing requirements more accurate than manual testing and eliminates common operator errors.
- The Type D HV110 / 120 adds a motorized X-Y stage with up to 100mm x 100mm of travel for large samples. A motorized focusing platform is also utilized for a complete walk away system.

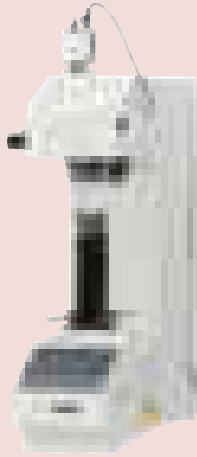

**Type B System**  
show with optional PC



**Type D System**  
show with optional PC



### SPECIFICATIONS

Model	HV110 Main Unit Only	HV120 Main Unit Only
<b>Order No.</b>	<b>810-443A</b>	<b>810-448A</b>
Test force	9.807N (1kgf), 19.61N (2kgf), 29.42N (3kgf), 49.03N (5kgf), 98.07N (10kgf), 196.1N (20kgf) 294.2N (30kgf), 490.3N (50kgf)	2.942N (0.3kgf), 4.903N (0.5kgf), 9.807N (1kgf), 24.51N (2.5kgf), 49.03N (5kgf), 98.07N (10kgf), 196.1N (20kgf) 294.2N (30kgf)
Supported test method	HV, HK, HB (Light Force**), Kc	
Measuring microscope	Optional	
Field of View w/ 10X Lens	590 x 443 μm	
Display	Via PC	
Curvature correction;	0.01 to 200.00mm	
Maximum sample height	172mm Type B, 132mm Type D	
Maximum sample depth	160mm	
Maximum sample weight	10 Kg Type B, 3 kg Type D	
Optical path	100% Eyetube or Camera	
Output	USB2.0	
Mass	110lbs. (50kg)	

\*Other specifications as Type A testers

\*\* Optional test forces may be required

Basic Configuration	Type B	Type D
Main Unit	810-443A or 810-448A	810-443A or 810-448A
AVPak-10 Software	11AAC664	11AAC664
PC***	***	***
Automatic Focus Stage		810-465
Motorized X-Y Stage 50x50		810-461A
Motorized X-Y Stage 100x100		810-462A

\*\*\* PC not included

# Optional Accessories

## Micro-Vickers/Vickers Hardness Testing Machine

### Test Blocks

Order No.	Description	Load
64BAA173	Vickers 100HV Test Block	100gf
64BAA174	Vickers 200HV Test Block	100gf
64BAA175	Vickers 300HV Test Block	100gf
64BAA176	Vickers 400HV Test Block	100gf
64BAA177	Vickers 500HV Test Block	100gf
64BAA178	Vickers 600HV Test Block	100gf
64BAA179	Vickers 700HV Test Block	100gf
64BAA180	Vickers 800HV Test Block	100gf
64BAA181	Vickers 900HV Test Block	100gf
64BAA182	Vickers 100HV Test Block	500gf
64BAA183	Vickers 200HV Test Block	500gf
64BAA184	Vickers 300HV Test Block	500gf
64BAA185	Vickers 400HV Test Block	500gf
64BAA186	Vickers 500HV Test Block	500gf
64BAA187	Vickers 600HV Test Block	500gf
64BAA188	Vickers 700HV Test Block	500gf
64BAA189	Vickers 800HV Test Block	500gf
64BAA190	Vickers 900HV Test Block	500gf
64BAA191	Vickers 100HV Test Block	1000gf
64BAA192	Vickers 200HV Test Block	1000gf
64BAA193	Vickers 300HV Test Block	1000gf
64BAA194	Vickers 400HV Test Block	1000gf
64BAA195	Vickers 500HV Test Block	1000gf
64BAA196	Vickers 600HV Test Block	1000gf
64BAA197	Vickers 700HV Test Block	1000gf
64BAA198	Vickers 800HV Test Block	1000gf
64BAA199	Vickers 900HV Test Block	1000gf
64BAA200	Knoop 200HK Test Block	100gf
64BAA201	Knoop 300HK Test Block	100gf
64BAA202	Knoop 400HK Test Block	100gf
64BAA203	Knoop 500HK Test Block	100gf
64BAA204	Knoop 600HK Test Block	100gf
64BAA205	Knoop 700HK Test Block	100gf
64BAA206	Knoop 800HK Test Block	100gf
64BAA207	Knoop 250HK Test Block	500gf
64BAA208	Knoop 300HK Test Block	500gf
64BAA209	Knoop 400HK Test Block	500gf
64BAA210	Knoop 500HK Test Block	500gf
64BAA211	Knoop 600HK Test Block	500gf
64BAA212	Knoop 700HK Test Block	500gf
64BAA213	Knoop 800HK Test Block	500gf
64BAA214	Knoop 250HK Test Block	1000gf
64BAA215	Knoop 300HK Test Block	1000gf
64BAA216	Knoop 400HK Test Block	1000gf
64BAA217	Knoop 500HK Test Block	1000gf
64BAA218	Knoop 600HK Test Block	1000gf
64BAA219	Knoop 700HK Test Block	1000gf
64BAA220	Knoop 800HK Test Block	1000gf

\*Other hardness ranges and test forces available

### Bulbs

Order No.	Description
513667	Bulb, 12v/50w, halogen double pin type, HM series with box style illuminators
19BAA219	Bulb, 6v/20w, halogen double pin type, Later H series
19BAA095	Bulb, 6v/15w, halogen bayonet type, all E, G and early H series testers

### Indenters

Order No.	Type	Model
19BAA058	Vickers Indenter	H, HM Standard Series
19BAA059	Vickers Indenter	MVK-H2, H3, HM114, HM220
19BAA061	Knoop Indenter	H, HM Standard Series
19BAA062	Knoop Indenter	MVK-H2, H3, HM114, HM220
19BAA060	Vickers Indenter	HV, AVK-C Series
19BAA063	Knoop Indenter	HV, AVK-C Series

### Universal Specimen Holder

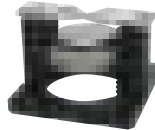

Used to secure a specimen that has a measuring surface that is hard to stabilize, perpendicular to the indenter axis.

810-020

### Mounted Specimen Vise



1.5" (39mm) Max Height

810-650-1

810-650-2

810-650-3

810-650-4

810-650-5

Diameter

1" 25.4mm

30mm

1.25" 31.75mm

1.5" 38.1mm

40mm

### 50x50mm travel stage

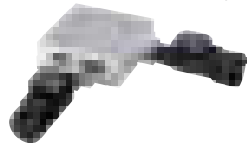

Manual XY Stage Unit 50 x 50

Manual XY Stage Unit 2"x 2"

810-423 Metric

810-427 Inch/Metric

### Clamping devices (Vises)



Vise

Max. opening: 3.94"(100mm)

810-017

Vise

Max. opening: 2"(51mm)

810-016

### Rotary Table



Rotary Table

810-018

### Round Tables



Dimensions: 7.08"(180mm)

810-037

### Specimen (thin plate) Holder



Secures a plate with a thickness of .197"(5mm) or less, or foil-like specimens.

810-013

### Specimen (wire) Holder

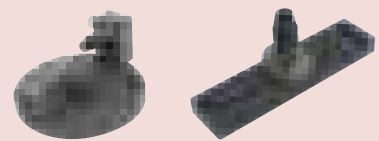

Used to horizontally or vertically secure a wire or needle specimen that has a diameter of .126"(3.2mm) or less.

810-014-1 horizontal

810-015-1 vertical



# HR-530/530L

## SERIES 810 — Rockwell Type Hardness Testing Machines

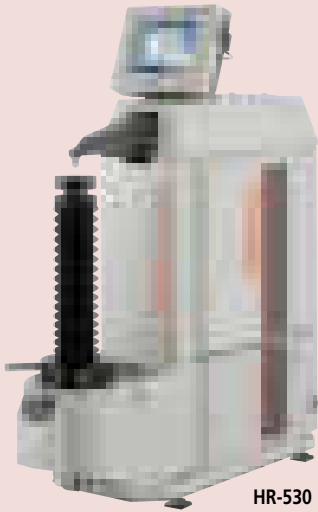

HR-530  
(810-237)



Standard operating display

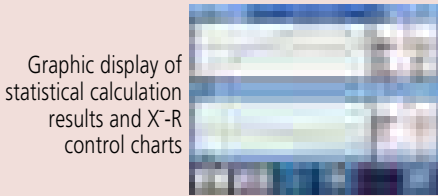

Graphic display of statistical calculation results and X-R control charts



5.7-inch color LCD

### FEATURES

- Closed Loop Test Force Control allows for a wide variety of hardness testing including Rockwell, Superficial and Light Force Brinell (6.25 to 187.5 kgf).
- Hardness testing of plastics according to ASTM D785 (Procedure A and B) and ISO2039-2 are also possible.
- Projected nose type tester allows testing of interior parts down to 40mm or 22mm with optional 19BAA292 indenter
- 5 display formats are possible to show you the information you need. Statistics and graphs can also be displayed on the color touch screen control panel.
- Simple to use automatic brake-start system begins the test automatically when initial force is reached
- The HR-530 is available in 9.8" (250mm) or 15.5" (395mm) height capacity models.
- Complete with a combination diamond indenter, a 1/16" carbide ball indenter, one flat and one V anvil, 2 HRC, 1 HRBW, 1 HR30TW and 1 HR30N test block.

### SPECIFICATIONS

Order No.	810-237	810-337
Model	HR-530	HR-530L
Hardness testing methods	Rockwell/Rockwell Superficial/Brinell/Plastics hardness	
Initial test force (N)	29.42N (3kgf), 98.07N (10kgf)	
Test force (N)	Rockwell Superficial	147.1N (15kgf), 294.2N (30kgf), 441.3N (45kgf)
	Rockwell	588.4N (60kgf), 980.7N (100kgf), 1471N (150kgf)
Test force (N)	Light Force Brinell	61.29 (6.25kgf), 98.07 (10kgf), 153.2 (15.625kgf), 245.2 (25kgf), 294.2 (30kgf), 306.5 (31.25kgf), 612.9 (62.5kgf), 980.7 (100kgf), 1226 (125kgf), 1839 (187.5kgf)
	Test force control	Automatic (load/hold/unload)
Table up/down mechanism	Manual (automatic braking and load sequencing)	
Control unit	Color touch-panel	
Test force switching	Operated with the display unit	
Test force hold time	1 to 120s (Selectable in units of 1s)	
Maximum specimen size	Height: 9.8" (250 mm)	Height: 15.5" (395 mm)
	Depth: 5.9" (150 mm)	Depth: 5.9" (150 mm)
Permissible inside diameter of a tube specimen	Minimum hole diameter: 1.38" (35 mm) (when using the special indenter: .87" (22 mm))	
Maximum table loading	45 lb (20 kg)	
Ball indenter	Tungsten carbide ball indenter	
Unit (display unit)	inch	
Display	Hardness value, test condition, go/no-go judgment result, statistical calculation result, X-R control chart, hardness conversion value	
	Conversion function [HV, HK, HR (Rockwell hardness A, B, C, D, F, G / Rockwell Superficial 15T, 30T, 45T, 15N, 30N, 45N), HS, HB, tensile strength]	
	Go/no-go judgment function	
	Continuous test function (for specimens with the same thickness)	
	Cylindrical correction, spherical correction, offset correction, multi-point correction functions	
	Statistical calculation function (maximum value, minimum value, mean value, standard deviation, upper limit value, lower limit value, go count, range, no-go count)	
Language support	Graph generation function (X-R control chart)	
	Japanese, English, German, French, Italian, Spanish, Korean, Chinese (simplified characters/traditional characters), Turkish, Portuguese, Hungarian, Polish, Dutch and Czech	
External data output	RS-232C, SPC, USB2.0	
Power supply	AC120V	
External dimensions	Main unit	9.84" x 26.38" x 23.82" (250(W)x667(D)x621(H) mm)
	Touch-panel display	11.8" x 26.2" x 30.1" (300(W)x667(D)x766(H) mm)
Mass	Approx. 60 kg	Approx. 69 kg

Note: Plastic testing may not be enabled, depending on the material.

### Fine-adjustment table for Jominy testing 810-700



Optional Accessories: See page K-11, 12

### Function: Touch-screen type

- Touch-screen operation with a back-lit LCD graphic display.
- Remote selection of the test force linked to the hardness scale selection.
- Choice of message language in English, German, French, Spanish, Italian and Japanese.
- Cylindrical and spherical surface compensation.
- Data offset.
- Conversion to other hardness scales.
- Powerful statistical processing with flexible data point editing and 1024 data memory.
- Measured data editing
- Go/no-go tolerance judgment.
- Statistical processing, histogram and X-R chart

# HR-523/523(L)

## SERIES 810 — Rockwell Type Hardness Testing Machines

### FEATURES

- Multiple test force generation for Rockwell, Rockwell Superficial and Light Force Brinell hardness.
- Dolphin-nose indenter arm for easy reach of interior (min.  $\varnothing 40\text{mm}/\varnothing 22\text{mm}^*$ ) and exterior surfaces.
- \*When using an optional diamond indenter (19BAA292).
- Real-time electronic test force control for accurate loading. This eliminates load force overshooting.
- Indenter escape function for continuous testing at fixed table position. This eliminates instability caused by the table retraction.
- Auto-stop elevation table and automatic preliminary test force loading to provide stable test force generation.
- Complete with one flat and V anvil, diamond and 1/16" carbide ball indenters, 2 HRC and 1 HRBW Rockwell test blocks and an HR30N and HR30TW test block.



### SPECIFICATIONS

Model	HR-523	HR-523L
Order No.	810-204-03A	810-207-03A
Preliminary Test Force	29.42N (3kgf), 98.07N (10kgf)	
Test Force	Rockwell	588.4N (60kgf), 980.7N (100kgf), 1471N (150kgf)
	Rockwell Superficial	147.1N (15kgf), 294.2N (30kgf), 441.3N (45kgf)
	Light Force Brinell	61.29 (6.25kgf), 98.07 (10kgf), 153.2 (15.625kgf), 245.2 (25kgf), 294.2 (30kgf), 306.5 (31.25kgf), 612.9 (62.5kgf), 980.7 (100kgf), 1226 (125kgf), 1839 (187.5kgf)
Force Control	Automatic control (unloading/duration/unloading) with closed-loop feed back	
Console/Display Unit	Touch-screen operation with back-lit LCD graphic display	
Test Force Selection	By touch screen	
Table up/down drive	Power-Drive (for full-automatic measurement)	
Load Duration	0 to 120 sec. (1 sec. step)	
Maximum Specimen Height	8.1" (205mm)	15.5" (395mm)
Maximum Specimen Depth	5.9" (150mm)	
Display Indication Functions	Hardness value, Converted hardness value, Test conditions, go/no-go tolerance judgment, statistical processing result Rockwell/Rockwell superficial hardness testing. Continuous testing. Cylindrical/spherical surface compensation, data offset. Hardness conversion (HV, HK, HRA/B/C/D/F/G/15T/30T/45T/15N/30N/45N, HS, HB, HBW, tensile strength) Go/no-go tolerance judgment, measured data editing, data memory (max 1024 data) SPC calculation (No. of data, max/min/mean values, range, upper/lower limit values, standard deviation, No. of passing/defective) Histogram, x-R chart	
Data Output	RS-232C, SPC, Centronics	
Dimensions (W x D x H)	9.84" x 26.38" x 23.82" (250 x 670 x 605mm)	
Mass	60kg (133lb)	63kg (139lb)

### Technical Data

Preliminary test force:	29.42N, 98.07N
Test force	
Rockwell superficial:	147.1, 294.2, 441.3N
Rockwell:	588.4, 980.7, 1471N
Brinell*:	
Test force setting:	By control unit
Load control:	Automatic (loading, duration, unloading)
Load duration:	0s - 120s (1s increments)
Max. specimen height:	205mm (for standard flat anvil)
Max. specimen depth:	150mm (from the center of indenter shaft)
Stage elevation:	Manual or power drive
Control unit:	Sheetswitch type or touch-screen type
Data output:	RS-232C, Digimatic code (SPC) and Centronics
Power supply:	120V AC, 50/60Hz
Dimensions (W x D x H)	
Main unit:	250 x 670 x 605mm
Control unit:	165 x 260 x 105mm

**Optional Accessories:** See page K-11, 12

**Various shapes of specimen can be measured. (Nose-type indenter axis mechanism has been adopted.)**

The nose-type indenter mechanism allows measurement of pipe samples as well as the top surface of a flat sample.

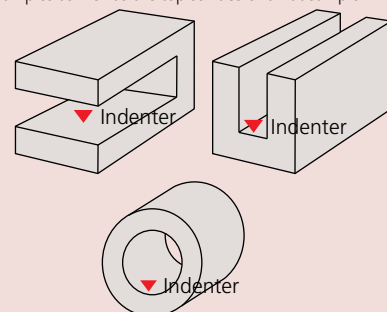

### Function: Touch-screen type

- Touch-screen operation with a back-lit LCD graphic display.
- Remote selection of the test force linked to the hardness scale selection.
- Choice of message language in English, German, French, Spanish, Italian and Japanese.
- Cylindrical and spherical surface compensation.
- Data offset.
- Conversion to other hardness scales.
- Powerful statistical processing with flexible data point editing and 1024 data memory.
- Measured data editing
- Go/no-go tolerance judgment.
- Statistical processing, histogram and x-R chart

# Optional Accessories

For Rockwell/Rockwell Superficial Type Hardness Testing machine



## Calibration Set

Order No.	Order No.
<b>64BAA241</b>	<b>64BAA242</b>
C Scale Set	B Scale Set
Test Blocks	Test Blocks
64BAA125	64BAA126
64BAA124	64BAA132
64BAA158	64BAA135
Indenter	Indenter
64BAA072	64BAA078
Order No.	Order No.
<b>64BAA243</b>	<b>64BAA244</b>
30N Scale Set	30T Scale Set
Test Blocks	Test Blocks
64BAA128	64BAA129
64BAA165	64BAA140
64BAA167	64BAA130
Indenter	Indenter
64BAA073	64BAA078

## Rockwell Type Diamond Indenters

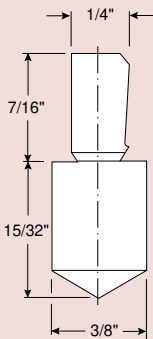

Order No.	Scale
<b>64BAA072</b>	C
<b>64BAA073</b>	N
<b>64BAA086</b>	A
<b>64BAA071</b>	C & N

Order No.	Hardness
<b>64BAA159</b>	HRA81/86 Rockwell Test Block
<b>64BAA160</b>	HRA75/79 Rockwell Test Block
<b>64BAA161</b>	HRA70/73 Rockwell Test Block
<b>64BAA162</b>	HRA65/68 Rockwell Test Block
<b>64BAA163</b>	HRA60/62 Rockwell Test Block
<b>64BAA249</b>	HRBW95/100 Rockwell Test Block
<b>64BAA126</b>	HRBW90/95 Rockwell Test Block
<b>64BAA131</b>	HRBW80/85 Rockwell Test Block
<b>64BAA132</b>	HRBW70/75 Rockwell Test Block
<b>64BAA133</b>	HRBW60/65 Rockwell Test Block
<b>64BAA134</b>	HRBW50/55 Rockwell Test Block
<b>64BAA135</b>	HRBW40/45 Rockwell Test Block
<b>64BAA127</b>	HRBW30/35 Rockwell Test Block
<b>64BAA136</b>	HRBW20/25 Rockwell Test Block
<b>64BAA137</b>	HRBW10/15 Rockwell Test Block
<b>64BAA138</b>	HRBW0/5 Rockwell Test Block
<b>64BAA125</b>	HRC60/65 Rockwell Test Block
<b>64BAA157</b>	HRC50/55 Rockwell Test Block
<b>64BAA124</b>	HRC40/45 Rockwell Test Block
<b>64BAA123</b>	HRC30/35 Rockwell Test Block
<b>64BAA158</b>	HRC20/25 Rockwell Test Block

Order No.	Hardness
<b>64BAA129</b>	HR30T74/79 Rockwell Test Block
<b>64BAA139</b>	HR30T70/73 Rockwell Test Block
<b>64BAA140</b>	HR30T63/67 Rockwell Test Block
<b>64BAA141</b>	HR30T56/60 Rockwell Test Block
<b>64BAA142</b>	HR30T49/53 Rockwell Test Block
<b>64BAA130</b>	HR30T43/47 Rockwell Test Block
<b>64BAA143</b>	HR30T36/39 Rockwell Test Block
<b>64BAA144</b>	HR30T29/33 Rockwell Test Block
<b>64BAA145</b>	HR30T22/26 Rockwell Test Block
<b>64BAA146</b>	HR30T15/18 Rockwell Test Block
<b>64BAA147</b>	HR15T90/92 Rockwell Test Block
<b>64BAA148</b>	HR15T86/69 Rockwell Test Block
<b>64BAA149</b>	HR15T83/85 Rockwell Test Block
<b>64BAA150</b>	HR15T80/82 Rockwell Test Block
<b>64BAA151</b>	HR15T77/79 Rockwell Test Block
<b>64BAA152</b>	HR15T72/74 Rockwell Test Block
<b>64BAA153</b>	HR15T70/72 Rockwell Test Block
<b>64BAA154</b>	HR15T68/69 Rockwell Test Block
<b>64BAA155</b>	HR15T64/66 Rockwell Test Block
<b>64BAA156</b>	HR15T61/63 Rockwell Test Block

Order No.	Hardness
<b>64BAA222</b>	HR45N65/70 Rockwell Test Block
<b>64BAA223</b>	HR45N55/60 Rockwell Test Block
<b>64BAA224</b>	HR45N45/50 Rockwell Test Block
<b>64BAA225</b>	HR45N35/40 Rockwell Test Block
<b>64BAA226</b>	HR45N25/30 Rockwell Test Block
<b>64BAA128</b>	HR30N64/69 Rockwell Test Block
<b>64BAA164</b>	HR30N68/73 Rockwell Test Block
<b>64BAA165</b>	HR30N59/64 Rockwell Test Block
<b>64BAA166</b>	HR30N50/55 Rockwell Test Block
<b>64BAA167</b>	HR30N40/45 Rockwell Test Block
<b>64BAA168</b>	HR15N90/93 Rockwell Test Block
<b>64BAA169</b>	HR15N85/88 Rockwell Test Block
<b>64BAA170</b>	HR15N80/83 Rockwell Test Block
<b>64BAA171</b>	HR15N75/77 Rockwell Test Block
<b>64BAA172</b>	HR15N69/72 Rockwell Test Block

## Carbide Ball Indenters

Order No.	Description
<b>11AAD465</b>	1/16" Carbide ball indenter
<b>11AAD466</b>	1/8" Carbide ball indenter
<b>11AAD467</b>	1/4" Carbide ball indenter
<b>11AAD468</b>	1/2" Carbide ball indenter
<b>19BAA507</b>	1/16" Carbide ball (1pc.)
<b>19BAA508</b>	1/8" Carbide ball (1pc.)
<b>19BAA509</b>	1/4" Carbide ball (1pc.)
<b>19BAA510</b>	1/2" Carbide ball (1pc.)

## Steel Ball Indenters

Order No.	Description
<b>11AAD461</b>	1/16" diameter steel ball indenter
<b>19BAA078</b>	1/16" diameter steel ball indenter (auto-discrimination type)
<b>11AAD462</b>	1/8" diameter steel ball indenter
<b>64BAA079</b>	1/8" diameter steel ball indenter (auto-discrimination type)
<b>11AAD463</b>	1/4" diameter steel ball indenter
<b>64BAA080</b>	1/4" diameter steel ball indenter (auto-discrimination type)
<b>11AAD464</b>	1/2" diameter steel ball indenter
<b>64BAA081</b>	1/2" diameter steel ball indenter (auto-discrimination type)
<b>64BAA082</b>	1/16" diameter spare steel ball (10 pcs)
<b>64BAA083</b>	1/8" diameter spare steel ball (10 pcs)
<b>64BAA084</b>	1/4" diameter spare steel ball (10 pcs)
<b>64BAA085</b>	1/2" diameter spare steel ball (10 pcs)

# Optional Accessories

For Rockwell/Rockwell Superficial Type Hardness Testing machine

## Round table

**810-038** Outside ø250 mm



For large specimens such as molded items

## Round table

**810-037** Outside ø180 mm



For large specimens such as molded items

## V-anvil (large)

**810-040**

(Outside ø40 mm,  
Groove width 30 mm)

For round specimens (max. ø60 mm)



## V-anvil (small)

**810-041**

(Outside ø40 mm,  
Groove width 6 mm)

For shaft materials (max. ø8.4 mm)



## Spot anvil

**810-043**

(Outside ø12 mm)



## Spot anvil

**810-044**

(Outside ø5.5 mm)

For sheet specimens



## Jack rest

**810-028**

For supporting long specimens  
(Used with anvil or round table)

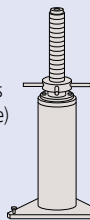

## EXPAK Data processing software

**11AAC236** HR530 and HM200 Series

**11AAC237** HR523 Series

## VARI-REST

**810-027**

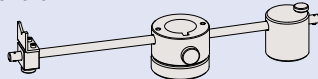

For testing long specimens (commonly used  
for the anvil)

## Special V-anvil

**810-029**

(Length 400 mm,  
Groove width 50 mm)

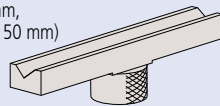

For round specimens ø14-98 mm

## Diamond-spot anvil

**810-030**

(Outside ø10 mm)

For sheet specimens



\*Dedicated to the Rockwell Superficial hardness test

## Small V-anvil

**810-042**

(Outside ø10 mm)

For round specimens (max. ø16 mm)



## Testing machine table

**11AAD186**

Supplied with  
stability bracket

Testing machine table

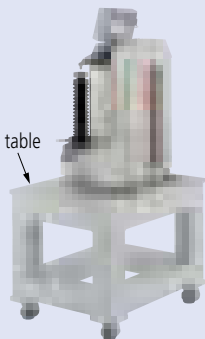

## Vibration isolator

**810-643**

Only for mounting hardness testing machines

## Foot switch

**11AAD537**

## Printer

**DPU-414**

**02AGD600B**

with connection cable

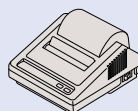

## Digimatic mini-processor

**DP-1VA**

**264-505A**

Connection cable not supplied. (To be ordered separately.)



937386

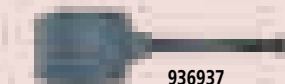

936937

## Optional Accessories

**HR523 and most older models:**

**06AFM380E:** USB input tool – Tester to PC

**937386:** Tester to DP1-VA Printer

**HM200 and HR-530 Series:**

**06AFM380D:** USB input tool – Tester to PC

**936937:** Tester to DP1-VA Printer



Refer to Bulletin No. (2255) for more details.

# Hardmatic HH-411

## SERIES 810 — Impact Type Hardness Testing Unit

### Technical Data

Impactor:	Impact hammer with integrated detector and carbide-ball tip (D type: conforming to ASTM A 956)
Display unit:	7-segment LCD
Functions:	Auto angle compensation, Offset, go/no-go judgment, Hardness scale conversion Data storage (1800 data entries) Statistical analysis (Average, Maximum, Minimum, Dispersion) Auto sleep function Impact counter display function
Testable workpiece	
Thickness:	Minimum 5mm or more
Mass:	5kg or more in mass
Test points:	5mm or more from the edge of the sample, 3mm or more to each of the tested points.
Surface roughness:	Ra 10µm or less
Power supply:	Lithium AA battery 2pcs or optional AC adapter (battery life: 70 hours)

### Standard Accessories

<b>19BAA265</b>	Test Block HLD800
<b>810-291-10</b>	Display Unit
<b>810-287-10</b>	Detector
<b>19BAA460</b>	Cable Battery AA (Lithium) 2pcs.

### Optional Accessories

<b>264-505A:</b>	Digimatic Mini-Processor DP-1VR
<b>937387:</b>	Connecting cable for Printer paper (10 rolls/set)
<b>09EAA082:</b>	Thermal printer DUP-414
<b>810-622A:</b>	Thermal printer connecting cable
<b>19BAA285:</b>	Thermal printer paper
<b>19BAA157:</b>	RS-232C connecting cable for PC
<b>19BAA238:</b>	AC adapter of display unit
<b>06AEG302JA:</b>	Hardness test block (880HLD)
<b>19BAA243:</b>	Hardness test block (830HLD)
<b>19BAA244:</b>	Hardness test block (730HLD)
<b>19BAA245:</b>	Hardness test block (620HLD)
<b>19BAA246:</b>	Hardness test block (520HLD)
<b>19BAA247:</b>	Support ring for convex surface of cylinder (R10 - R20)
<b>19BAA248:</b>	Support ring for convex surface of cylinder (R14 - R20)
<b>19BAA249:</b>	Support ring for convex surface of sphere (R10 - R27.5)
<b>19BAA250:</b>	Support ring for concave surface of sphere (R10 - R27.5)
<b>19BAA251:</b>	Support ring for concave surface of sphere (R13.5 - R20)
<b>19BAA457:</b>	Carbide ball for D, DC, D+15 type impactors
<b>19BAA458:</b>	Ball shaft for DL type impactor
<b>810-287-10:</b>	D type impactor UD-411
<b>810-288-10:</b>	DC type impactor UD-412
<b>810-289-10:</b>	D+15 type impactor UD-413
<b>810-290-10:</b>	DL type impactor UD-414

HH-411 is a rebound-type portable hardness tester for metal with a compact body and high operability. It allows anyone to perform hardness testing easily at the touch of a key, so it can be used widely on various components in the field.

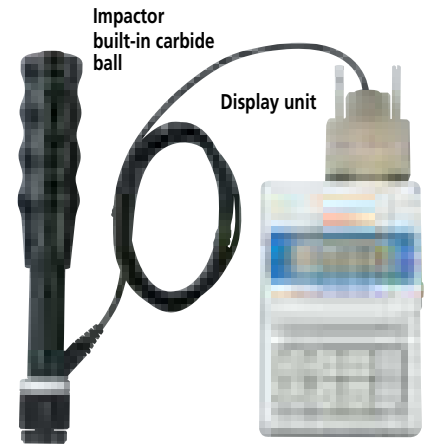

**810-298-10:** ASTM standard  
Including the display unit, D type impactor (**810-287-10**) and carbide ball (**19BAA457**).

### SPECIFICATIONS

Model	HH-411		
Order No.	810-298-10		
Hardness Range	L-Value (ASTM A956)		
Detector	Input device D (carbide ball)		
Display	<b>Hardness</b>	<b>Range</b>	<b>Resolution</b>
	HL	1-999 HL	1 HL
	HV	43-950 HV	1 HV
	HB	20-894 HB	1 HB
	HRC	19.3-68.2 HRC	0.1 HRC
	HRB	13.5 - 101.7 HRB	0.1 HRB
Functions	HTN	13.2 - 99.3 HS	0.1 HS
	HTN	499 - 1996 Mpa	1 Mpa
Conversions:	HL, HV, HB, HRC, HRB, HS, HTN		
Judgment:	go/no go		
Offsetting	Memory: 1,800 data		
Indentation Direction	Any direction		
Output	RS-232C, SPC		
Power supply	Lithium AA Battery 2pcs.		
Dimensions	Detector: (Dia. X H) 1.10" x 6.89"		
	(28 x 175mm)		
Mass	Display: (W x D x H) 2.76" x 4.33" x 1.38"		
	(70 x 110 x 35mm)		
Mass	Detector: .26lbs (120g)		
	Display: .44lbs (200g)		

### Impactors (Optional accessories)

Various impactors can be connected to the display unit.



**810-288-10**  
Use for inner walls of cylinders. The grip is short to allow easy positioning within a cylinder.



**810-289-10**  
Use for concave workpieces such as gear teeth, ball bearing races, etc.



**810-290-10**  
Use for gear teeth, welded corners, etc.

# Hardmatic HH-300

## SERIES 811 — Durometers for Rubber and Plastics Hardness Testing

### FEATURES

Digital / Dial Durometers are suitable for testing the nature of the following materials — natural rubber, neoprene, polyesters, P.V.C., leather, nitrile rubber, wax, vinyl, cellulose acetates, glass polystyrene, etc.



**Compact Digital**  
**Compact Dial**

**811-336-10**  
**811-335-10**



**Long Leg Digital**  
**Long Leg Dial**

**811-332-10**  
**811-331-10**

### Technical Data

- Designed in accordance with the ASTM D 2240, ISO868, ISO 7619, DIN 53 505, JIS K 6253, and JIS K 7215 specifications.
- Units are available in both Shore A and Shore D scales, and will test a wide variety of applications.
- The Digital Durometer is provided with data hold function, permitting the operator to make an error-free reading on the LCD screen.
- The Dial Durometer is provided with a peak retaining hand for error-free reading.

### SPECIFICATIONS

Order No.	Digital	811-330-10	811-336-10	811-336-11	811-332-10	811-338-10	811-338-11	811-334-10
	Dial	811-329-10	811-335-10	811-335-11	811-331-10	811-337-10	811-337-11	811-333-10
Model No.	Digital	HH-330	HH-336	HH-336	HH-332	HH-338	HH-338	HH-334
	Dial	HH-329	HH-335	HH-335	HH-331	HH-337	HH-337	HH-333
Scale		Shore E	Shore A			Shore D		
Applications		Soft Rubber, Sponge, Felt, Hard Foam	Natural rubber, soft elastomers, etc.			Hard elastomers, plastics, hard rubber, ebonite, etc.		
Resolution		0.1 (digital) or 1 (dial)				0.1 (digital) or 1 (dial)		
Range		HA: 10 - 90				HD: 20 - 90		
Standards	ASTM D 2240	—	✓	✓	✓	✓	✓	✓
	ISO 868	—	✓	✓	✓	✓	✓	✓
	ISO 7619	—	✓	✓	✓	✓	✓	✓
	DIN 53 505	—	—	✓	—	—	✓	✓
	JIS K 6253	✓	✓	✓	✓	✓	✓	✓
	JIS K 7215	—	✓	✓	✓	✓	✓	✓
Pressure foot		44 x 18mm	44 x 18mm	ø18mm	44 x 18mm	ø18mm		
Spring force (mN)		WE=550+HE	WA=550+75HD (HA:Reading 10-90)			WD=444.5HD (HD:Reading 20-90)		
Indenter		Sphere (Tip diameter: 0.79mm)	Blunt taper (Tip diameter: 0.79mm)			Sharp point (Tip curvature: 0.1±0.01mm)		
Tip angle		—	35°±0.25°			30°±0.5°		
Indenter diameter		5mm	1.25mm					
Indenter protrusion		2.5mm						
Functions		Digital: Data hold, Zero -setting, SPC output, Power ON/OFF (Power supply: SR44 x 1pc.) Analog Durometer: Peak retaining hand						
Type		Compact	Compact	Long-leg	Compact	Long-leg		
Dimensions (WxDxH)	Digital	60 x 28.5 x 151	60 x 28.5 x 151mm	60 x 28.5 x 193mm	60 x 28.5 x 151mm	60 x 28.5 x 193mm		
	Dial	56 x 33.5 x 144mm	56 x 33.5 x 144mm	56 x 33.5 x 186mm	56 x 33.5 x 144mm	56 x 33.5 x 186mm		
Mass	Digital	290g	290g	310g	290g	310g		
	Dial	300g	300g	320g	300g	320g		

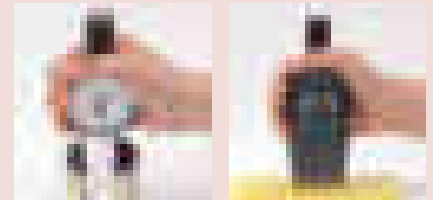

# Hardmatic HH-300

## Test Block Set



64AAA964



64AAA963



905693

811-332-10

264-505A

### Testing stand applications

These stands are used to mount Durometers. They allow constant-pressure hardness measurement by pressing the Durometer vertically on a workpiece.

- Anyone can perform repeatable hardness measurement due to fewer possibilities of human error and measurement variations.
- The supplied weights can be attached directly to a Durometer and allow constant-pressure hardness measurement of large samples for which a stand cannot be used.
- The supplied weights are used for calibrating the spring tension of Durometers.

Item No.	Description
64AAA964	Calibration Set (Shore A Scale)
	Test Block 30* DURO (Blue)
	Test Block 60* DURO (Yellow)
	Test Block 90* DURO (Gray)
	Mahogany Box
64AAA590	Calibration Set (Shore D Scale)
	Test Block 20* DURO (Blue)
	Test Block 40* DURO (Gray)
	Test Block 80* DURO (Black)
64AAA962	"A" Scale Durometer Stand
64AAA794	"A" Scale Durometer Stand with Air Damper
64AAA796	Combination "D" & "A" Scale Durometer Stand
64AAA963	O-Ring Fixture Set 1/16", 3/32", 1/8", 3/16" and 1/4"
	O-Ring cross sections
264-505A	Digimatic Miniprocessor with printer
905693	Connecting Cable 40" (1m) for Durometer and Digimatic Miniprocessor

\* Values shown are nominal only. Test Block Size 2" x 2" x 1/4"

# Quick Guide to Precision Measuring Instruments

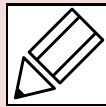

## Hardness Testing Machines

### ■ Hardness Test Methods and Guidelines for Selection of a Hardness Testing Machine

Test Method	Micro Vickers	Micro surface material characteristics	Vickers	Rockwell	Rockwell Superficial	Durometer	Rebound type portable	Brinell	Shore
<b>Material</b>									
IC wafer	●	●							
Carbide, ceramics (cutting tool)		▲	●	●					
Steel (heat-treated material, raw material)	●	▲	●	●	●		●		●
Non-ferrous metal	●	▲	●	●	●		●		
Plastic		▲		●		●			
Grinding wheel				●					
Casting								●	
Sponge, rubber						●			
<b>Shape</b>									
Thin metal sheet (safety razor, metal foil)	●	●	●		●				
Thin film, plating, painting, surface layer (nitrided layer)	●	●							
Small parts, acicular parts (clock hand, sewing-machine needle)	●	▲							
Large specimen (structure)							●	●	●
Metallic material configuration (hardness for each phase of multilayer alloy)	●	●							
Plastic plate	▲	▲		●		●			
Sponge, rubber plate						●			
<b>Inspection, judgment</b>									
Strength or physical property of materials	●	●	●	●	●	●	▲	●	●
Heat treatment process	●		●	●	●		▲		▲
Carburized case depth	●		●						
Decarburized layer depth	●		●		●				
Flame or high-frequency hardening layer depth	●		●	●					
Hardenability test			●	●					
Maximum hardness of a welded spot			●						
Weld hardness			●	●					
High-temperature hardness (high-temperature characteristics, hot-workability)			●						
Fracture toughness (ceramics)	●		●						

Key: ● Well-suited ▲ Reasonably suited

### ■ Methods of Hardness Measurement

#### (1) Vickers

Vickers hardness is a test method that has the widest application range, allowing hardness inspection with an arbitrary test force. This test has an extremely large number of application fields particularly for hardness tests conducted with a test force less than 9.807N (1kgf). As shown in the following formula, Vickers hardness is a value determined by dividing test force  $F$  (N) by contact area  $S$  ( $\text{mm}^2$ ) between a specimen and an indenter, which is calculated from diagonal length  $d$  (mm, mean of two directional lengths) of an indentation formed by the indenter (a square pyramidal diamond, opposing face angle  $\theta=136^\circ$ ) in the specimen using a test force  $F$  (N).  $k$  is a constant ( $1/g=1/9.80665$ ).

$$HV=k \frac{F}{S}=0.102 \frac{F}{S}=0.102 \frac{2F \sin \frac{\theta}{2}}{d^2}=0.1891 \frac{F}{d^2} \quad \begin{matrix} F:\text{N} \\ d:\text{mm} \end{matrix}$$

The error in the calculated Vickers hardness is given by the following formula. Here,  $\Delta d_1$ ,  $\Delta d_2$ , and 'a' represent the measurement error that is due to the microscope, an error in reading an indentation, and the length of an edge line generated by opposing faces of an indenter tip, respectively. The unit of  $\Delta \theta$  is degrees.

$$\frac{\Delta HV}{HV} \approx \frac{\Delta F}{F} - 2 \frac{\Delta d_1}{d} - 2 \frac{\Delta d_2}{d} - \frac{a^2}{d^2} 3.5 \times 10^{-3} \Delta \theta$$

#### (2) Knoop

As shown in the following formula, Knoop hardness is a value obtained by dividing test force by the projected area  $A$  ( $\text{mm}^2$ ) of an indentation, which is calculated from the longer diagonal length  $d$  (mm) of the indentation formed by pressing a rhomboidal diamond indenter (opposing edge angles of  $172^\circ 30'$  and  $130^\circ$ ) into a specimen with test force  $F$  applied. Knoop hardness can also be measured by replacing the Vickers indenter of a microhardness testing machine with a Knoop indenter.

$$HK=k \frac{F}{A}=0.102 \frac{F}{A}=0.102 \frac{F}{cd^2}=1.451 \frac{F}{d^2} \quad \begin{matrix} F:\text{N} \\ d:\text{mm} \\ c:\text{Constant} \end{matrix}$$

#### (3) Rockwell and Rockwell Superficial

To measure Rockwell or Rockwell Superficial hardness, first apply a preload force and then the test force to a specimen and return to the preload force using a diamond indenter (tip cone angle:  $120^\circ$ , tip radius: 0.2mm) or a sphere indenter (steel ball or carbide ball). This hardness value is obtained from the hardness formula expressed by the difference in indentation depth  $h$  ( $\mu\text{m}$ ) between the preload and test forces. Rockwell uses a preload force of 98.07N, and Rockwell Superficial 29.42N. A specific symbol provided in combination with a type of indenter, test force, and hardness formula is known as a scale. Japanese Industrial Standards (JIS) define various scales of related hardness.



## Relationship Between Vickers Hardness and the Minimum Allowable Thickness of a Specimen

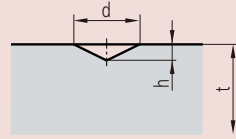

$$HV = 0.1891 \frac{F}{d^2}$$

$$t > 1.5d$$

$$h = d/7$$

t: Thickness of specimen (mm)  
d: Diagonal length (mm)  
h: Depth of indentation (mm)

Vickers hardness HV

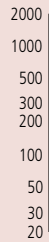

[Example]  
Specimen thickness t: 0.15mm  
Specimen hardness: 185HV1  
Test force F: 9.807N (1kgf)  
Diagonal length d: 0.1mm

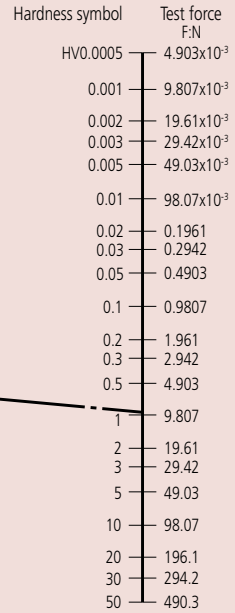
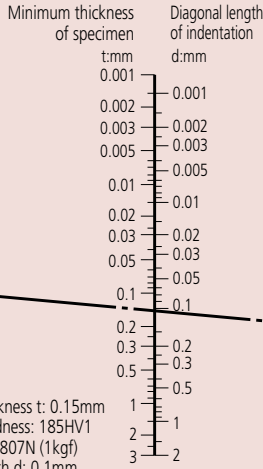

## Relationship Between Rockwell/Rockwell Superficial Hardness and the Minimum Thickness of a Specimen

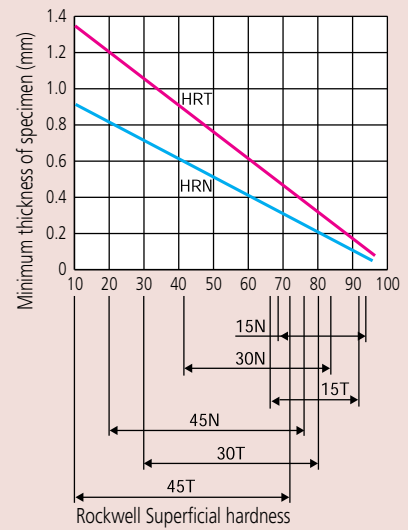
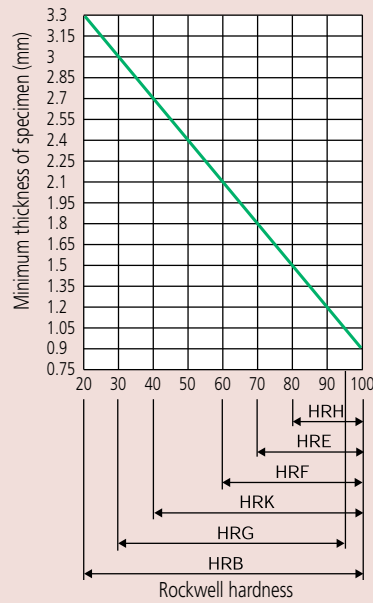
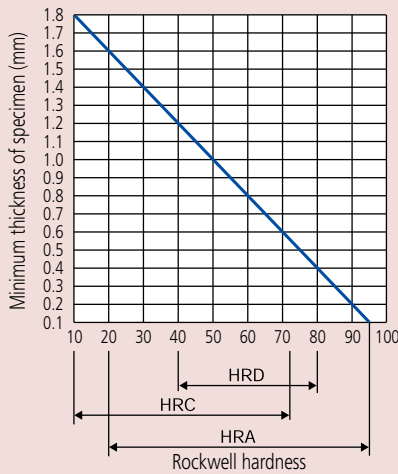

### Rockwell Hardness Scales

Scale	Indenter	Test force	Application
A	Diamond	588.4N	Carbide, sheet steel
D		980.7N	Case-hardened steel
C		1471N	Steel (100HRB or more to 70HRC or less)
F	Sphere of 1.5875mm diameter	588.4N	Bearing metal, annealed copper
B		980.7N	Brass
G		1471N	Hard aluminum alloy, beryllium copper, phosphor bronze
H	Sphere of 3.175mm diameter	588.4N	Bearing metal, grinding wheel
E		980.7N	Bearing metal
K		1471N	Bearing metal
L	Sphere of 6.35mm diameter	588.4N	Plastic, lead
M		980.7N	
P		1471N	
R	Sphere of 12.7mm diameter	588.4N	Plastic, lead
S		980.7N	
V		1471N	

### Rockwell Superficial Hardness Scales

Scale	Indenter	Test force	Application
15-N	Diamond	147.1N	Thin surface-hardened layer on steel such as carburized or nitrided
30-N		294.2N	
45-N		441.3N	
15-T	Sphere of 1.5875mm diameter	147.1N	Sheet of mild steel, brass, bronze, etc.
30-T		294.2N	
45-T		441.3N	
15-W	Sphere of 3.175mm diameter	147.1N	Plastic, zinc, bearing alloy
30-W		294.2N	
45-W		441.3N	
15-X	Sphere of 6.35mm diameter	147.1N	Plastic, zinc, bearing alloy
30-X		294.2N	
45-X		441.3N	
15-Y	Sphere of 12.7mm diameter	147.1N	Plastic, zinc, bearing alloy
30-Y		294.2N	
45-Y		441.3N	

# MITUTOYO INSTITUTE OF METROLOGY

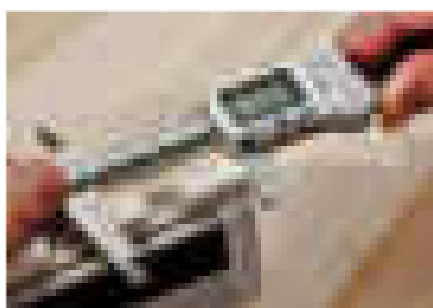
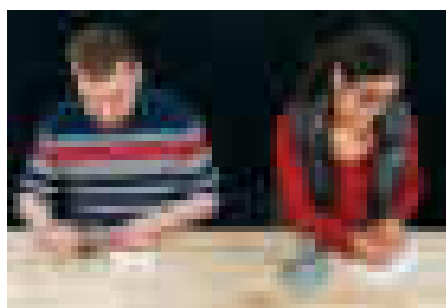
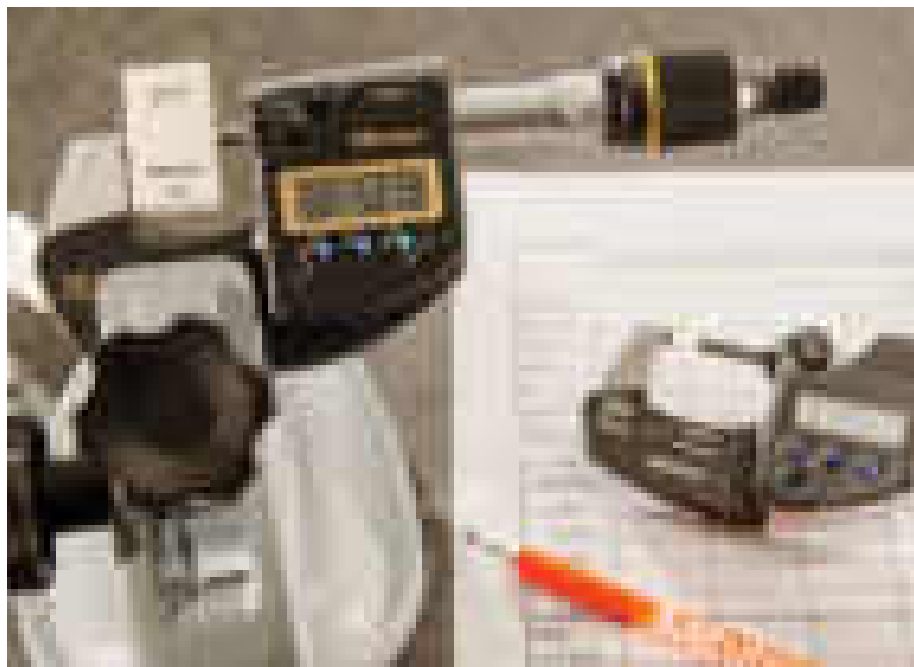

The Mitutoyo Institute of Metrology, the educational department of Mitutoyo America, provides unrivaled educational seminars, courses and on-demand resources for a wide variety of metrology and measurement-related topics such as basic inspection techniques, principles of dimensional metrology, calibration methods and GD&T. This comprehensive curriculum meets the educational needs of manufacturing, quality and measurement professionals. These popular courses are scheduled regularly throughout the year.

The calibration expertise of Mitutoyo America is now available on-demand for anybody through our On-Demand Portal. Here, you can access metrology educational materials that leverages the available American National Standards in dimensional metrology.

Mitutoyo now offers online courses introducing important concepts in general calibration of micrometers and calipers. Mitutoyo also offers the first certified credentials in dimensional calibration in the United States, addressing both theory (Level 1 credential) and hands-on performance skills (Level 2 credential). These credentials satisfy auditors' requirements.

If you have any questions or would like more information regarding Mitutoyo Institute of Metrology, contact: [MIM@Mitutoyo.com](mailto:MIM@Mitutoyo.com)



## Coordinate Measuring Machines

### INDEX

#### Coordinate Measuring Machines

Mitutoyo CMM Accuracy Statements	L-2
CrystaPlus M Series 196 — Manual Floating CMM	L-3
CRYSTA-Apex S 500/700/900/1200 Series 191 — Standard CNC	L-4, 5
CRYSTA-Apex EX 500T/700T/900T Series PH20-Equipped 5-Axis CNC CMM	L-6
CRYSTA-Apex EX 1200R Series — REVO-Equipped 5-Axis CNC CMM	L-7
CRYSTA-Apex S 1600/2000 Series 191 — Standard CNC CMM	L-8
STRATO-Apex 500/700/900 Series 355 — High-Accuracy CNC CMM	L-9
STRATO-Apex 1600 Series 355 — High-Accuracy CNC CMM	L-10
FALCIO-Apex 2000/3000 Series 355 — High-Accuracy Large CNC CMM	L-11
LEGEX 500/700/900 Series 356 — Ultra-High Accuracy CNC CMM	L-12
MACH-V 9106 Series 360 — Inline CNC CMM	L-13
MACH-3A 653 Series 360 — Inline CNC CMM	L-13
MACH KO-GA-ME Series 360 — Inline CNC CMM	L-14
CARBapex / CARBstrato Series — Car Body Measuring System CNC CMM	L-15

#### Software and Probes

MCOSMOS Software for Manual / CNC Coordinate Measuring Machines	L-16, 17
MiCAT Planner — Automatic Measurement Program Generation Software	L-18, 19
CMM Probe & Change Rack Options — Touch-Trigger Probe System	L-20
CMM Probe & Change Rack Options — Motorized Probe Heads	L-21
Non-Contact CMM Probe Options — SurfaceMeasure 606/610/1010/606T/201FS	L-22, 23
MSURF Software for Manual / CNC Coordinate Measuring Machines	L-24, 25
Non-Contact CMM Probe Options — QVP Quick Vision Probe	L-26
CMM Surface Roughness Measuring — CMM SurfTest Probe	L-27

#### Accessories

Mitutoyo Styli Kits	L-28
Mitutoyo ECO-FIX Kit Fixture Systems	L-29
Mitutoyo ECO-FIX Kit Fixture Systems	L-29

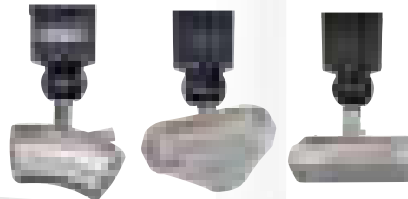

**SurfaceMeasure Probes**  
(Laser scanning probes—non-contact)



**CRYSTA-Apex EX 500T w/PH-20 Probe**

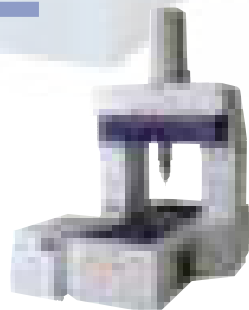

**LEGEX 574**



**MiCAT Planner**

**SurfTest Probe**  
(surface finish)



**MACH Kogame**



# Mitutoyo CMM Accuracy Statements

The accuracy statements specified on the following pages for Mitutoyo CMM's are based on ISO standards. The following is a brief description of these standards.

## ■ Performance Assessment Method of Coordinate Measuring Machines

CMM accuracy is specified in accordance to international standards, the ISO 10360 series of standards, and entitled "Acceptance and Reverification Test for CMMs." ISO 10360 consists of multiple parts, with each part describing tests that apply to various configuration and components of CMMs.

Table 1 JIS B 7440 (2003) Series

	Item	JIS Standard No.	Year of issue
1	Terms	ISO 10360-1	2000
2	Dimensional measurement	ISO 10360-2	2009
3	Rotary table-equipped CMM	ISO 10360-3	2000
4	Scanning measurement	ISO 10360-4	2000
5	Probing systems	ISO 10360-5	2010

## ■ Maximum Permissible Measuring Error $E_{0,MPE}$ ISO 10360-2:2009

This volumetric test procedure requires that a coordinate measuring machine (CMM) is made to perform a series of five different length measurements in each of seven directions, as shown in Figure 1, to produce a set of 35 measurements. This sequence is then repeated twice more to produce 105 measurements in all. If these test values are equal to or less than the limits specified by the manufacturer, then the performance of the CMM has been determined to meet its specification. This test procedure is a part of Mitutoyo America Corporation's A2LA-accredited calibration of Mitutoyo CMMs.

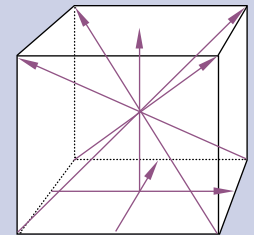

Figure 1 Typical test measurement directions within the CMM measuring volume

## ■ Maximum Permissible Measuring Error $E_{150,MPE}$ ISO 10360-2:2009

This test is an extension of the E0 test but uses a probe tip that is offset a default length of 150 mm perpendicular to the ram axis of the CMM (typically the Z-axis). Five different lengths are measured along two different planar diagonals to produce 10 measurements. This sequence is then repeated twice more to produce 30 measurements in all. If these test values are equal to or less than the specified limits, then the performance of the CMM has been determined to meet its specification.

*This test is not part of Mitutoyo America's standard A2LA-accredited CMM calibration procedure and is quoted upon request.*

## ■ Maximum Permissible Limit Repeatability of the Range $R_{0,MPL}$ ISO 10360-2:2009

This test of repeatability is not a separate test but is determined directly from the E0 test values. For each of the 35 sets of three repeated length measurements, the difference between the maximum and minimum of the three test values is calculated. If these 35 calculated test values are equal to or less than the specified limits, then the CMM has been determined to meet its specification.

*This test is not part of Mitutoyo America's standard A2LA-accredited CMM calibration procedure and is quoted upon request.*

## ■ Maximum Permissible Scanning Probing Error $MPE_{THP}$ ISO 10360-4:2000

This is the accuracy standard for a CMM if equipped with a scanning probe. The test procedure under this standard is to perform a scanning measurement of 4 planes on the standard sphere and then, for the least squares sphere center calculated using all the measurement points, calculate the range (dimension 'A' in Figure 2) in which all measurement points exist. Based on the least squares sphere center calculated above, calculate the distance between the calibrated standard sphere radius and the maximum measurement point or minimum measurement point, and take the larger distance (dimension 'B' in Figure 2). If both calculated values are less than the specified limits, this scanning probe test is passed.



Figure 2 Target measurement planes for the maximum permissible scanning probing error and its evaluation concept

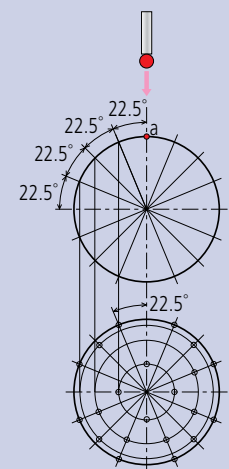

Figure 3 Target points on standard sphere for determining the Maximum Permissible Probing Error

## ■ Maximum Permissible Probing Error $P_{FTU,MPE}$ ISO 10360-5:2010

The test procedure under this standard is that a probe is used to measure defined target points on a standard sphere (25 points, as in Figure 3) and the result used to calculate the position of the sphere center by a least squares method. Then the distance R from the sphere center for each of the 25 measurement points is calculated, and the radius difference  $R_{max} - R_{min}$  is computed. If this final calculated value is equal to or less than the specified value, the probe has passed the test.

# CRYSTA-Plus M

## SERIES 196 — Manual Floating CMM

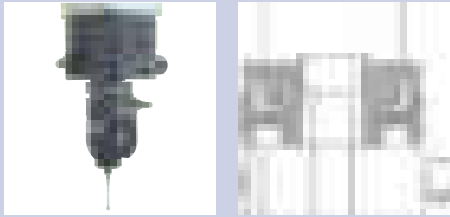

Ergonomically designed guide grip on Z-axis for reliable measurement  
(only for Crysta-Plus M776 and M7106)

One-touch air clamp and fine feed for rapid and easy positioning

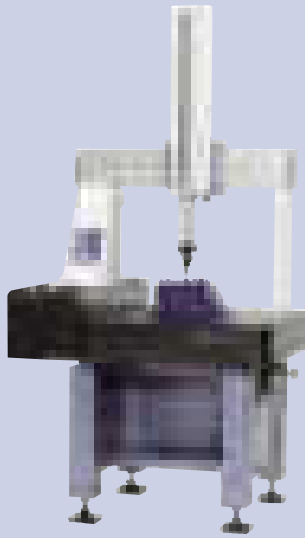
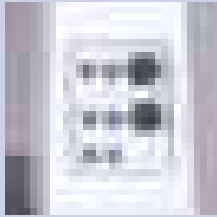

Crysta-Plus M443

Manual floating CMMs were developed in quest for high-accuracy, low-cost and easy operation. The Crysta-Plus M is suitable to measure a wide range of applications from a simple dimension to a complex form. The scale systems on Mitutoyo high-precision models use a high-performance linear encoder (manufactured by Mitutoyo) for detecting axis position. In addition, various technologies have been used in the structure, part processing and assembly to provide high-accuracy measurement.

The Crysta-Plus M700 series has a large main unit and is equipped with a mobile clamp so that one-touch clamping on each axis can be performed by hand. Continuous fine feed over the entire measuring range can be performed.

### FEATURES

- Smooth operation utilizing high-precision air bearings and lightweight moving members.
- Continuous fine feed over the entire measuring range.
- One-touch air clamp for each axis.

Crysta-Plus M574



MH20i  
see page L-20



Crysta-Plus M7106

### SPECIFICATIONS

Type: Bridge	Model No.	Crysta-Plus M443	Crysta-Plus M574	Crysta-Plus M7106	
Range	X axis	15.74" (400mm)	19.68" (500mm)	27.55" (700mm)	
	Y axis	15.74" (400mm)	27.55" (700mm)	39.36" (1000mm)	
	Z axis	11.81" (300mm)	15.74" (400mm)	23.62" (600mm)	
Resolution		0.000019" (0.0005mm)			
Work table	Material	Granite			
	Size	24.56" x 31.69" (624mm x 805mm)	30.07" x 46.25" (764mm x 1175mm)	35.43" x 68.50" (900mm x 1740mm)	
	Tapped insert	M8 x 1.25mm			
Workpiece	Max. height	18.89" (480mm)	23.22" (590mm)	31.49" (800mm)	
	Max. load	396 lbs. (180kg)		1,763 lbs. (800kg)	
Mass (incl. stand)		793 lbs. (360kg)	1,424 lbs. (646kg)	3,968 lbs. (1800kg)	
Dimensions W x D x H		38.62 x 41.22 x 77.44" (981 x 1047 x 1967mm)	56.45 x 44.17 x 89.25" (1434 x 1122 x 2267mm)	57.48 x 79.40 x 111.81" (1460 x 2017 x 2840mm)	
Air Supply	Pressure	50.7 PSI (0.35MPa)		58.0 PSI (0.4MPa)	
	Consumption	1.76CFM (50L/min)			
	Source	3.53CFM (100L/min)			
ISO-10360-2: 2001					
19-21°C (66.2-69.8°F)	TP20:	E	(3.0+4.0L/1000)µm	(3.5+4.0L/1000)µm	(4.5+4.5L/1000)µm
		R	4µm		5µm

Stylus Configurations for ISO Tests
TP20:  Ø4mm x L10mm

Environment	19-21°C (66.2-69.8°F)
Rate of change	2.0C° or less per hour 5.0C° or less per day
Gradient	1.0C° or less per meter vertical & horizontal

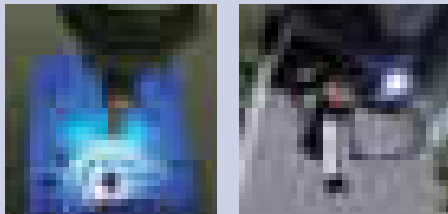

Probe illumination (optional) to illuminate the probe and styli directly and brighten the working field

See page L-2 for explanation of ISO accuracy statements

# CRYSTA-Apex S 500/700/900/1200

High-performance, low-price CNC Coordinate Measuring Machine that meets global standards

## SERIES 191 — Standard CNC CMM

### High accuracy in the 1.7µm class

The CRYSTA-Apex S is a high-accuracy CNC coordinate measuring machine that guarantees a maximum permissible error of  $*E_{0,MPE} = (1.7+3L/1000)\mu\text{m}$  [500/700/900 Series]. Comparing the CRYSTA-Apex S with CMMs offering  $*E_{0,MPE}$  of approximately  $(2.5+4L/1000)\mu\text{m}$  where a required tolerance on a dimension is  $\pm 0.02\text{ mm}$ , then the measuring machine uncertainty should be no more than one-fifth (ideally one-tenth) of that, i.e.  $4\mu\text{m}$ . This means that with a general purpose CMM, when the measured length exceeds 14.8" (375mm), machine uncertainty exceeds one-fifth of the dimension tolerance in this case. In contrast, as shown in the figure on the right, with the CRYSTA-Apex S the measurement uncertainty remains within one-fifth of the dimension tolerance up to 30.2" (766mm). The higher accuracy specification of the CRYSTA-Apex S, therefore, gives it more than double the effective measuring range in terms of accuracy-guarantee capability in this case.

\*ISO 10360-2:2009

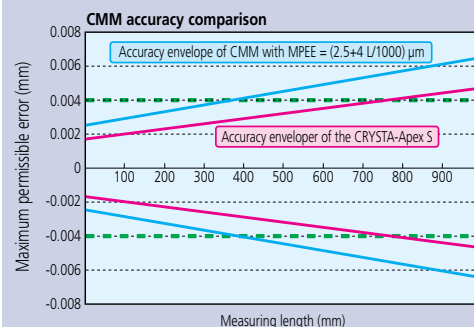

CRYSTA-Apex S 544



CRYSTA-Apex S 776

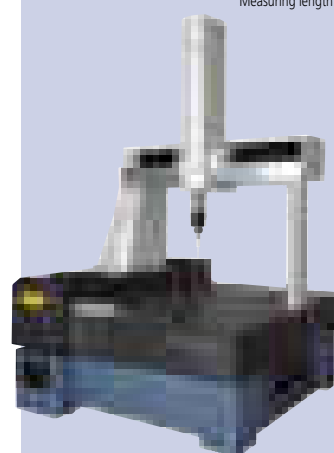

CRYSTA-Apex S 9106

## SPECIFICATIONS

Type: BRIDGE	Model No.	CRYSTA-Apex S 544	CRYSTA-Apex S 574	CRYSTA-Apex S 776	CRYSTA-Apex S 7106	CRYSTA-Apex S 9106	CRYSTA-Apex S 9166	CRYSTA-Apex S 9206	
	X axis	19.68" (500mm)		27.55" (700mm)		35.43" (900mm)			
Range	Y axis	15.74" (400mm)	27.55" (700mm)	39.36" (1000mm)		62.99" (1600mm)	78.73" (2000mm)		
	Z axis	15.74" (400mm)		23.62" (600mm)					
Resolution		0.000004" (0.0001mm)							
Guide Method		Air bearing on each axis							
Maximum Drive Speed 3D		20.43"/s (519mm/s)							
Maximum Acceleration 3D		0.23G (2,309mm/s <sup>2</sup> )							
Work table	Material	Granite							
	Size	25.11 x 33.86" (638 x 860mm)	25.11 x 45.67" (638 x 1160mm)	34.64 x 55.90" (880 x 1420mm)	34.64 x 67.71" (880 x 1720mm)	42.51 x 67.71" (1080 x 1720mm)	42.51 x 91.33" (1080 x 2320mm)	42.51 x 107.08" (1080 x 2720mm)	
Workpiece	Tapped insert	M8 x 1.25mm							
	Max. height	21.45" (545mm)		31.49" (800mm)					
	Max. load	396 lbs. (180kg)	1,763 lbs. (800kg)	2,204 lbs. (1000kg)	2,645 lbs. (1200kg)	3,306 lbs. (1500kg)	3,968 lbs. (1800kg)		
Mass (incl. stand & controller)		1,135 lbs. (515kg)	1,377 lbs. (625kg)	3,692 lbs. (1675kg)	4,301 lbs. (1951kg)	4,918 lbs. (2231kg)	6,322 lbs. (2868kg)	8,624 lbs. (3912kg)	
Dimensions W x D x H		42.60x46.88x86.02" (1082x1191x2185mm)	42.60x60.94x86.02" (1082x1548x2185mm)	57.87x66.92x107.48" (1470x1700x2730mm)	57.87x78.73x107.48" (1470x2000x2730mm)	65.74x78.73x107.48" (1670x2000x2730mm)	65.74x107.87x107.48" (1670x2740x2730mm)	65.74x126.77x107.48" (1670x3220x2730mm)	
ISO-10360-2:2009 E <sub>0,MPE</sub>	18-22°C (64.4-71.6°F) TP200:				(1.9+3L/1000)µm				
	MPP310/SP25:				(1.7+3L/1000)µm				
	16-26°C (60.8-78.8°F) TP200:				(1.9+4L/1000)µm				
	MPP310/SP25:				(1.7+4L/1000)µm				
ISO-10360-2:2009 E <sub>10,MPE</sub> †	18-22°C (64.4-71.6°F) TP200:				(2.4+3L/1000)µm				
	MPP310/SP25:				(1.7+3L/1000)µm				
	16-26°C (60.8-78.8°F) TP200:				(2.4+4L/1000)µm				
	MPP310/SP25:				(1.7+4L/1000)µm				
ISO-10360-2:2009 R <sub>0,MPL</sub> †	TP200:	1.5µm		1.9µm					
	MPP310/SP25:				1.3µm				
ISO-10360-4 MPE <sub>THP</sub> /MPT <sub>THP</sub> †	SP25:	2.3µm/50sec							
	SP80:	N/A		2.0µm/50sec					
	MPP310:	1.8mm/90sec			1.8mm/80sec				
ISO-10360-5: 2010 P <sub>FTU,MPE</sub>	TP200:				1.9µm				
	SP25:				1.7µm				
	MPP310:	1.5µm			1.7µm				

Stylus Configurations for ISO Tests	
TP200:	Ø4mm x L10mm
SP25/SP80:	Ø4mm x L50mm
MPP310Q:	Ø4mm x L18mm

Air Supply	500	700/900
Pressure	58.0 PSI (0.4MPa)	
Consumption	1.76CFM (50L/min)	2.11CFM (60L/min)
Source	3.53CFM (100L/min)	

Environment	18-22°C (64.4-71.6°F)	16-26°C (60.8-78.8°F)
Rate of change	2.0°C or less per hour	2.0°C or less per hour
	2.0°C or less per day	5.0°C or less per day
Gradient	1.0°C or less per meter vertical & horizontal	

† This test is not part of Mitutoyo America's standard A2LA-accredited CMM calibration procedure and is quoted upon request.

See page L-2 for explanation of ISO accuracy statements

# CRYSTA-Apex S 500/700/900/1200

## SERIES 191 — Standard CNC CMM



Integrated Y-Axis in Granite Table

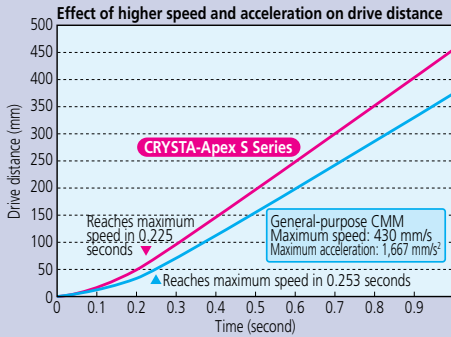

### Designed for high rigidity

As is the case with Mitutoyo's conventional CMMs, various structures are employed in the CRYSTA-Apex S in order to give the body higher rigidity. The Y-axis guide rail, which is attached to one side of the granite surface plate, shows very little deterioration with use, and thus promises to maintain high accuracy for a long time. The air bearings located on the bottom face, in addition to those at the front, rear, and upper surfaces of the slider unit of the X-axis, minimize vibration even during high-speed, high-acceleration movement, thus ensuring stable linear motion.



CRYSTA-Apex S 122010



SP25 Probe (Scanning)  
See page L-21



Quick Vision Probe (Optical probe-non-contact)  
See page L-26

Supported Probe Systems			
Type	Probe	AS500	AS700/900/1200
TOUCH TRIGGER PROBES	MH20i	●	●
	TP20	●	●
	TP200	●	●
	TP7	●	●
SCANNING PROBES	SP25	●	●
	MPP	●	●
	SP80	—	●
LASER PROBES	SM606	▲	●
	SM606T	▲	●
	SM610	▲	●
	SM1010	▲	●
SURFACE FINISH	SurfTest	●	●
OPTICAL	QVP	▲	●
	CF20	●	●

● Supported ▲ Not Recommended — Not supported

See page L-20 through L-27 for probe system information

## SPECIFICATIONS

Type: BRIDGE	Model No.	CRYSTA-Apex S 9108	CRYSTA-Apex S 9168	CRYSTA-Apex S 9208	CRYSTA-Apex S 121210	CRYSTA-Apex S 122010	CRYSTA-Apex S 123010
Range	X axis	35.43" (900mm)			47.24" (1200mm)		
	Y axis	39.36" (1000mm)	62.99" (1600mm)	78.73" (2000mm)	47.24" (1200mm)	78.73" (2000mm)	118.1" (3000mm)
	Z axis	31.49" (800mm)			39.36" (1000mm)		
Resolution		0.000004" (0.0001mm)					
Guide Method		Air bearing on each axis					
Maximum Drive Speed 3D		20.43"/s (519mm/s)			27.28"/s (693mm/s)		
Maximum Acceleration 3D		0.17G (1732mm/s <sup>2</sup> )					
Work table	Material	Granite					
	Size	42.51 x 67.71" (1080 x 1720mm)	42.51 x 91.33" (1080 x 2320mm)	42.51 x 107.08" (1080 x 2720mm)	55.90 x 67.71" (1420 x 2165mm)	55.90 x 116.73" (1420 x 2965mm)	55.90 x 156.10" (1420 x 3965mm)
	Tapped insert	M8 x 1.25mm					
Workpiece	Max. height	39.36" (1000mm)			47.24" (1200mm)		
	Max. load	2,645 lbs. (1200kg)	3,306 lbs. (1500kg)	3,968 lbs. (1800kg)	4,409 lbs. (2000kg)	5,511 lbs. (2500kg)	6,613 lbs. (3000kg)
Mass (incl. stand & controller)		4,985 lbs. (2261kg)	6,389 lbs. (2898kg)	8,691 lbs. (3942kg)	8,928 lbs. (4050kg)	13,558 lbs. (6150kg)	20,084 lbs. (9110kg)
Dimensions W x D x H		65.74x78.73x123.22" (1670x2000x3130mm)	65.74x107.87x123.22" (1670x2740x3130mm)	65.74x126.77x123.22" (1670x3220x3130mm)	86.61x102.16x143.50" (2200x2595x3645mm)	86.61x133.66x143.50" (2200x3395x3645mm)	86.61x173.03x143.50" (2200x4395x3645mm)
ISO-10360-2:2009 E <sub>Q,MPE</sub>	18-22°C TP200:	(1.9+3L/1000)µm			(2.5+3L/1000)µm		
	(64.4-71.6°F) MPP310/SP25/SP80:	(1.7+3L/1000)µm			(2.3+3L/1000)µm		
	16-26°C TP200:	(1.9+4L/1000)µm			(2.5+4L/1000)µm		
	(60.8-78.8°F) MPP310/SP25/SP80:	(1.7+4L/1000)µm			(2.3+4L/1000)µm		
ISO-10360-2:2009 E <sub>ISO,MPE</sub> †	18-22°C TP200:	(2.4+3L/1000)µm			(3.0+3L/1000)µm		
	(64.4-71.6°F) MPP310/SP25/SP80:	(1.7+3L/1000)µm			(2.3+3L/1000)µm		
	16-26°C TP200:	(2.4+4L/1000)µm			(3.0+4L/1000)µm		
	(60.8-78.8°F) MPP310/SP25/SP80:	(1.7+4L/1000)µm			(2.3+4L/1000)µm		
ISO-10360-2:2009 R <sub>Q,MPL</sub> †	TP200:	1.9µm			2.0µm		
	MPP310/SP25/SP80:	1.3µm			1.9µm		
ISO-10360-4 MPE <sub>THP</sub> /MPT <sub>THP</sub> †	SP25:	2.3µm/60sec			2.8µm/50sec		
	SP80:	2.3µm/60sec			2.5µm/50sec		
	MPP310:	1.8µm/80sec			2.3µm/80sec		
ISO-10360-5: 2010 P <sub>FTU,MPE</sub>	TP200:	1.9µm			2.2µm		
	MPP310/SP25/SP80:	1.7µm			2.0µm		

Stylus Configurations for ISO Tests	
TP200:	Ø4mm x L10mm
SP25/SP80:	Ø4mm x L50mm
MPP310Q:	Ø4mm x L18mm

Air Supply	900	1200
Pressure	58.0 PSI (0.4MPa)	
Consumption	2.11CFM (60L/min)	3.53CFM (100L/min)
Source	4.23CFM (120L/min)	5.29CFM (150L/min)

Environment	18-22°C (64.4-71.6°F)	16-26°C (60.8-78.8°F)
Rate of change	2.0°C or less per hour 2.0°C or less per day	2.0°C or less per hour 5.0°C or less per day
Gradient	1.0°C or less per meter vertical & horizontal	

† This test is not part of Mitutoyo America's standard A2LA accredited CMM calibration procedure and is quoted upon request.

See page L-2 for explanation of ISO accuracy statements

# CRYSTA-Apex EX 500T/700T/900T

## SERIES 191 — PH20 Equipped 5-Axis CNC CMM

The CRYSTA-Apex EX 500T/700T/900T series are CNC CMMs equipped with the PH20 5-axis control touch-trigger probe. The 5-axis operation reduces the time required for probe rotational movements and allows more flexible positioning. This also ensures easy access to complex workpieces and saves time both during programming and measurement.

In addition to 3-axis point measurement similar to conventional coordinate measuring machines, the PH20 probe head also supports head-touch operation for quick point measurement using the two rotational axes of the probe only, with no movement required along the CMM axes.

The PH20 incorporates a TP20 probe and allows use of modules designed for the TP20. Automatic probe changes with a module changer is also supported with the use of the TCR20 change rack (option).

### FEATURES

- Incorporates PH20 5-axis touch-trigger probe
- Ultra-high speed 5-axis control touch-trigger probe
- Smooth 5-axis control drastically reduces measurement time (typically 40-65%) for probe rotation
- 5-axis design provides highly efficient measurement method of head touch for point measurement by moving the probe head only in two axes



CRYSTA-Apex EX 544T

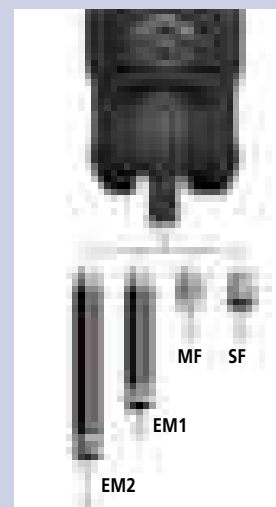
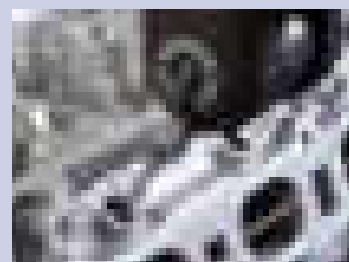

### Specifications PH20

Rotation angle (Pitch angle)	Vertical (A-axis)	-115° to +115° (0.08sec)
	Horizontal (B-axis)	∞ (0.08sec)
Stylus	Maximum length	50mm

### SPECIFICATIONS

Type: BRIDGE	Model No.	CRYSTA-Apex EX 544T	CRYSTA-Apex EX 574T	CRYSTA-Apex EX 776T	CRYSTA-Apex EX 7106T	CRYSTA-Apex EX 9106T	CRYSTA-Apex EX 9166T	CRYSTA-Apex EX 9206T
Range	X axis	19.68" (500mm)		27.55" (700mm)		35.43" (900mm)		78.73" (2000mm)
	Y axis	15.74" (400mm)	27.55" (700mm)		39.36" (1000mm)		62.99" (1600mm)	78.73" (2000mm)
	Z axis	15.74" (400mm)		23.62" (600mm)				
Resolution		0.000004" (0.0001mm)						
Guide Method		Air bearing on each axis						
Work table	Material	Granite						
	Size	25.11 x 33.86" (638 x 860mm)	25.11 x 45.67" (638 x 1160mm)	34.64 x 55.90" (880 x 1420mm)	34.64 x 67.71" (880 x 1720mm)	42.51 x 67.71" (1080 x 1720mm)	42.51 x 91.33" (1080 x 2320mm)	42.51 x 107.0" (1080 x 2720mm)
	Tapped insert	M8 x 1.25mm						
Workpiece	Max. height	21.45" (545mm)		31.49" (800mm)				
	Max. load	396 lbs. (180kg)		1,763 lbs. (800kg)	2,204 lbs. (1000kg)	2,645 lbs. (1200kg)	3,306 lbs. (1500kg)	3,968 lbs. (1800kg)
Mass (incl. stand & controller)		1,181 lbs. (536kg)	1,424 lbs. (646kg)	3,739 lbs. (1696kg)	4,347 lbs. (1972kg)	4,964 lbs. (2252kg)	6,369 lbs. (2889kg)	8,670 lbs. (3933kg)
Dimensions W x D x H		42.60x46.88x86.02" (1082x1191x2185mm)	42.60x60.94x86.02" (1082x1548x2185mm)	57.87x66.92x107.48" (1470x1700x2730mm)	57.87x78.73x107.48" (1470x2000x2730mm)	65.74x78.73x107.48" (1670x2000x2730mm)	65.74x107.87x107.48" (1670x2740x2730mm)	65.74x126.77x107.48" (1670x3220x2730mm)
ISO-10360-2:2009 E <sub>0,MPE</sub>	18-22°C (64.4-71.6°F)	(2.2+3L/1000)µm						
	16-26°C (60.8-78.8°F)	(2.2+4L/1000)µm						
ISO-10360-2:2009†	R <sub>0,MPL</sub>	1.8µm		2.2µm				
ISO-10360-5: 2010	P <sub>FTU,MPE</sub>	2.2µm						

Stylus Configurations for ISO Tests	Air Supply	500	700/900	Environment	18-22°C (64.4-71.6°F)	16-26°C (60.8-78.8°F)
TP20: Ø4mm x L12mm	Pressure	58.0 PSI (0.4MPa)		Rate of change	2.0C° or less per hour	2.0C° or less per hour
	Consumption	1.76CFM (50L/min)	2.11CFM (60L/min)		2.0C° or less per day	5.0C° or less per day
	Source	3.53CFM (100L/min)	4.23CFM (120L/min)	Gradient	1.0C° or less per meter vertical & horizontal	

† This test is not part of Mitutoyo America's standard A2LA-accredited CMM calibration procedure and is quoted upon request.

See page L-2 for explanation of ISO accuracy statements.



# CRYSTA-Apex EX 1200R

## SERIES 191 — REVO-Equipped 5-Axis CNC CMM

The CRYSTA-Apex EX 1200R series is advanced CNC CMMs equipped with the REVO 5-axis scanning probe head. The 5-axis operation reduces the time required for probe repositioning movements and allows for more flexible positioning. This also facilitates access to complex workpieces and saves time both during programming and measurement.

The ultra-high speed 5-axis scanning (max. 500mm/s) surpasses conventional 3-axis control, supporting high-speed sampling of up to 4,000 points per second and allowing data acquisition of densely spaced measurement points, even during high-speed scanning.

The internal implementation of laser sensing technology ensures high-accuracy measurement, even with long styli (up to 500 mm as measured from probe rotation center to stylus tip). Two types of scanning probes are supported:

- RSP2 for 5-axis scanning
- RSP3 probe (SP25M type), allowing the use of a cranked stylus

Automatic changeover of these probes with an auto probe changer is possible, enabling fully automated measurement of parts with diverse shapes. Probe calibration of RSP2 requires only about 20 minutes to enable use of the full angular range. Compared to conventional scanning probes, this reduces preparation time.

### FEATURES

- Equipped with REVO 5-axis scanning probe head
- Ultra-high speed 5-axis scanning



### SPECIFICATIONS

Type: BRIDGE	Model No.	Crysta-Apex EX 121210R	Crysta-Apex EX 122010R	Crysta-Apex EX 123010R
Range	X axis		47.24" (1200mm)	
	Y axis	47.24" (1200mm)	78.73" (2000mm)	118.10" (3000mm)
	Z axis		39.36" (1000mm)	
Resolution		0.000004" (0.0001mm)		
Guide Method		Air bearing on each axis		
Work table	Material	Granite		
	Size	55.11" x 85.23" (1400mm x 2165mm)	55.11" x 116.73" (1400mm x 2965mm)	55.11" x 156.10" (1400mm x 3965mm)
	Tapped insert	M8 x 1.25mm		
Workpiece	Max. height	45.66" (1160mm)		
	Max. load	4,409 lbs. (2000kg)	5,511 lbs. (2500kg)	6,613 lbs. (3000kg)
Mass (incl. stand & controller)		8,928 lbs. (4050kg)	13,558 lbs. (6150kg)	20,084 lbs. (9110kg)
Dimensions W x D x H		86.61 x 102.16 x 143.50" (2200 x 2595 x 3645mm)	86.61 x 133.66 x 143.50" (2200 x 3395 x 3645mm)	86.61 x 173.03 x 143.50" (2200 x 4395 x 3645mm)
ISO-10360-2:2009 E <sub>h</sub> MPE	18-22°C (64.4-71.6°F)	(2.9+4L/1000)µm		
	16-26°C (60.8-78.8°F)	(2.9+5L/1000)µm		
ISO-10360-5: 2010	P <sub>ETU,MPE</sub>	3.2µm		

Configuration for ISO Tests	Air Supply		Environment	18-22°C (64.4-71.6°F)	16-26°C (60.8-78.8°F)
RSP2+RSH250 Ø6mm x L10mm	Pressure	72.5 PSI (0.5MPa)	Rate of change	1.0C° or less per hour 2.0C° or less per day	1.0C° or less per hour 5.0C° or less per day
	Consumption	5.29CFM (150L/min)	Gradient	1.0C° or less per meter vertical & horizontal	
	Source	8.12CFM (230L/min)			

### Specification of REVO Scanning Probe

Rotation angle	Vertical (A-axis)	-5° to +120° (0.08 sec)
(Pitch angle)	Horizontal (B-axis)	∞ (0.08sec)
Stylus	Maximum length	50mm (Distance from probe rotation center to stylus tip)

See page L-2 for explanation of ISO accuracy statements.

# CRYSTA-Apex S 1600/2000

## SERIES 191 — Standard CNC CMM

Crysta-Apex S1600/2000 series are large-sized CNC CMMs developed for supporting quality evaluation of large parts. The scale systems on Mitutoyo high-precision models utilize a high-performance linear encoder (manufactured by Mitutoyo) for detecting axis position. In addition, various technologies have been utilized in the structure, part processing and assembly to provide high-accuracy measurement.

Floor vibration at the installation location can be a source of variations in measured values. The auto-leveling air spring vibration isolators is available as an option for Crysta-Apex S1600/2000 series. The vibration isolators insulates the main unit from floor vibrations and can quickly level the CMM main unit using a sensor that detects load fluctuations caused by axis movement of the CMM or workpiece loading. Build to order.



CRYSTA-Apex S 163016

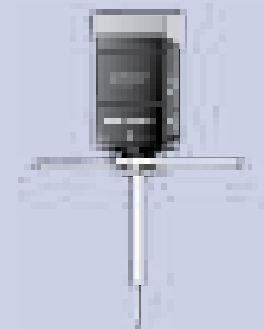

SP80 Probe  
(Extended reach scanning)  
See page L-21

Supported Probe Systems			
Type	Probe	AS1600	AS2000
TOUCH-TRIGGER PROBES	MH20i	●	●
	TP20	●	●
	TP200	●	●
	TP7	●	●
SCANNING PROBES	SP25	●	●
	MPP	●	●
	SP80	●	●
LASER PROBES	SM606	●	●
	SM606T	●	●
	SM610	●	●
	SM1010	●	●
SURFACE FINISH	SurfTest	●	▲
OPTICAL	QVP	●	●
	CF20	●	●

● Supported ▲ Not Recommended

See page L-20 thru L-27 for probe system information.

## SPECIFICATIONS

Type: BRIDGE	Model No.	CRYSTA-Apex S 162012 [CRYSTA-Apex S 162016]	CRYSTA-Apex S 163012 [CRYSTA-Apex S 163016]	CRYSTA-Apex S 164012 [CRYSTA-Apex S 164016]	CRYSTA-Apex S 203016	CRYSTA-Apex S 204016
Range	X axis	62.99" (1600mm)			78.73" (2000mm)	
	Y axis	78.73" (2000mm)	118.10" (3000mm)	157.47" (4000mm)	118.10" (3000mm)	157.47" (4000mm)
	Z axis	47.24" (1200mm) [62.99" (1600mm)]			62.99" (1600mm)	
Resolution		0.000004" (0.0001mm)				
Guide Method		Air bearing on each axis				
Maximum Drive Speed 3D		27.28"/s (693mm/s)				
Maximum Acceleration 3D		0.14G (1,390mm/s <sup>2</sup> )				
Work table	Material	Granite				
	Size	70.86" x 126.18" (1800mm x 3205mm)	70.86" x 165.55" (1800mm x 4205mm)	70.86" x 204.92" (1800mm x 5205mm)	86.61" x 165.55" (2200mm x 4205mm)	86.61" x 204.92" (2200mm x 5205mm)
	Tapped insert	M8 x 1.25mm				
Workpiece	Max. height	55.11" (1400mm) [70.86" (1800mm)]			70.86" (1800mm)	
	Max. load	6,613 lbs. (3000kg)	7,716 lbs. (3500kg)	9,920 lbs. (4500kg)	8,818 lbs. (4000kg)	11,023 lbs. (5000kg)
Mass (incl. stand & controller)		20,502 lbs. (9300kg) [20,613 lbs. (9350kg)]	23,368 lbs. (10600kg) [23,479 lbs. (10650kg)]	32,628 lbs. (14800kg) [37,738 lbs. (14850kg)]	31,085 lbs. (14100kg)	42,769 lbs. (19400kg)
Dimensions W x D x H		106.29 x 141.73 x 162.99" (2700 x 3600 x 4140mm) [106.29 x 141.73 x 194.48"] [(2700 x 3600 x 4940mm)]	106.29 x 181.10 x 162.99" (2700 x 4600 x 4140mm) [106.29 x 181.10 x 194.48"] [(2700 x 4600 x 4940mm)]	106.29 x 220.47 x 164.96" (2700 x 5600 x 4190mm) [106.29 x 220.47 x 196.45"] [(2700 x 5600 x 4990mm)]	122.04 x 183.07 x 196.45" (3100 x 4650 x 4990mm)	122.04 x 222.44 x 198.42" (3100 x 5650 x 5040mm)
ISO-10360-2:2009 E <sub>0,MPE</sub>	18-22°C (64.4-71.6°F)	TP200:	(6+4.5L/1000)µm [(7+5.5L/1000)µm]		(9+8L/1000)µm	
		MPP310/SP25:	(3.3+4.5L/1000)µm [(4.5+5.5L/1000)µm]		(4.5+8L/1000)µm	
	16-24°C (60.8-75.2°F)	TP200:	(6+5.5L/1000)µm [(7+6.5L/1000)µm]		(9+9L/1000)µm	
		MPP310/SP25:	(3.3+5.5L/1000)µm [(4.5+6.5L/1000)µm]		(4.5+8L/1000)µm	
ISO-10360-4 MPE <sub>THP</sub> /MPT <sub>THP</sub> †		MPP310/SP25:	5µm/60sec		6µm/60sec	
		TP200:	6.5µm [7.5 µm]		9.5µm	
ISO-10360-5: 2010 P <sub>FTU,MPE</sub>		MPP310/SP25:	5µm [6µm]		6µm	
		TP200:	6.5µm [7.5 µm]		9.5µm	

Stylus Configurations for ISO Tests	
TP200:	Ø4mm x L10mm
SP25/SP80:	Ø4mm x L50mm
MPP310Q:	Ø4mm x L18mm

Air Supply	
Pressure	58.0 PSI (0.4MPa)
Consumption	5.29CFM (150L/min)
Source	7.06CFM (200L/min)

Environment	
18-22°C (64.4-71.6°F)	16-24°C (60.8-75.2°F)
Rate of change	1.0C° or less per hour 2.0C° or less per day 5.0C° or less per day
Gradient	1.0C° or less per meter vertical & horizontal

† This test is not part of Mitutoyo America's standard A2LA-accredited CMM calibration procedure and is quoted upon request.

See page L-2 for explanation of ISO accuracy statements.

Supported Probe Systems			
Type	Probe	STRATO Apex 500	STRATO Apex 700/900
TOUCH-TRIGGER PROBES	MH20i	●	●
	TP20	●	●
	TP200	●	●
	TP7	●	●
SCANNING PROBES	SP25	●	●
	MPP	●	●
	SP80	▲	●
LASER PROBES	SM606	▲	●
	SM606T	▲	●
	SM610	▲	●
	SM1010	▲	●
SURFACE FINISH	SurfTest	—	●
OPTICAL	QVP	▲	●
	CF20	●	●

● Supported ▲ Not Recommended — Not supported

See page L-20 thru L-27 for probe system information.



Ultra-high precision glass scales

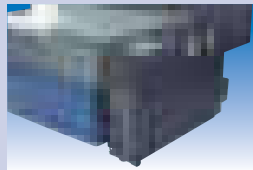

Internal heat generation minimized

# STRATO-Apex 500/700/900

## SERIES 355 — High-Accuracy CNC CMM

The STRATO-Apex series is high-accuracy CNC CMMs achieving 0.9µm for the first term. The series guarantees high accuracy and also high-moving speed and acceleration achieved with improved rigid air bearings on all axial guideways. The scale systems on Mitutoyo high-precision models utilize a high-performance linear encoder (manufactured by Mitutoyo), for detecting axis position. In addition, various technologies have been utilized in the structure, part processing and assembly to provide high-accuracy measurement.



TP7 Probe  
(High-precision touch trigger)  
See page L-20



STRATO-Apex 574

STRATO-Apex 776

STRATO-Apex 9106

## SPECIFICATIONS

Type: BRIDGE	Model No.	STRATO-Apex 574	STRATO-Apex 776	STRATO-Apex 7106	STRATO-Apex 9106	STRATO-Apex 9166
Range	X axis	19.68" (500mm)	27.55" (700mm)		35.43" (900mm)	
	Y axis	27.55" (700mm)		39.36" (1000mm)	62.99" (1600mm)	
	Z axis	15.74" (400mm)	23.62" (600mm)			
Resolution		0.0000019" (0.00005mm)		0.0000078" (0.00002mm)		
Guide Method		Air bearing on each axis				
Maximum Drive Speed 3D		20.43"/s (519mm/s)				
Maximum Acceleration 3D		0.17G (2,309mm/s <sup>2</sup> )	0.26G (2,598mm/s <sup>2</sup> )			
Work table	Material	Granite				
	Size	26.61 x 55.90" (676 x 1420mm)	33.93 x 55.90" (862 x 1420mm)	33.93 x 67.71" (862 x 1720mm)	41.81 x 67.71" (1062 x 1720mm)	41.81 x 91.33" (1062 x 2320mm)
	Tapped insert	M8 x 1.25mm				
Workpiece	Max. height	22.04" (560mm)	30.31" (770mm)			
	Max. load	396 lbs. (180kg)	1,102 lbs. (500kg)	1,763 lbs. (800kg)	1,763 lbs. (800kg)	2,645 lbs. (1200kg)
Mass (incl. stand & controller)		3,373 lbs. (1530kg)	4,177 lbs. (1895kg)	4,806 lbs. (2180kg)	5,313 lbs. (2410kg)	6,801 lbs. (3085kg)
Dimensions W x D x H		49.99x66.92x94.88" (1270x1700x2410mm)	57.48x75.19x111.41" (1460x1910x2830mm)	57.48x87.00x111.41" (1460x2210x2830mm)	65.35x87.00x111.41" (1660x2210x2830mm)	65.35x110.62x111.41" (1660x2810x2830mm)
ISO-10360-2:2009 E <sub>0,MPE</sub>	TP200:	(1.4+2.5L/1000)µm*	(1.4+2.5L/1000)µm**		(1.5+2.5L/1000)µm**	
	SP25:	(0.7+2.5L/1000)µm*	(0.9+2.5L/1000)µm**			
ISO-10360-2:2009 E <sub>150,MPE</sub>	TP200:	(1.9+2.5L/1000)µm*	(1.9+2.5L/1000)µm**		(2.0+2.5L/1000)µm**	
	SP25:	(0.7+2.5L/1000)µm*	(0.9+2.5L/1000)µm**			
ISO-10360-2:2009 R <sub>0,MPL</sub>	TP200:	1.2µm*	1.2µm**			
	SP25:	0.7µm*	0.8µm**			
ISO-10360-4 MPE <sub>LTHP</sub> /MPT <sub>LTHP</sub>	SP25:	1.3µm/40sec*	1.8µm/45sec**			
	TP200:	1.8µm*	1.8µm**			
ISO-10360-5: 2010 P <sub>FTU,MPE</sub>	TP200:	1.8µm*	1.8µm**			
	SP25:	0.7µm*	0.9µm**			

\* 18-22°C (64.4-71.6°F - Strato Apex 574

\*\* 19-21°C (66.2-69.8°F) - Strato Apex 776/7106/9106/9166

Stylus Configurations for ISO Tests	
TP200:	Ø4mm x L10mm
SP25/SP80:	Ø4mm x L50mm

Air Supply	
Pressure	58.0 PSI (0.4MPa)
Consumption	2.11CFM (60L/min)
Source	4.23CFM (120L/min)

Environment		18-22°C (64.4-71.6°F)	19-21°C (66.2-69.8°F)
Rate of change		1.0°C or less per hour	2.0°C or less per day
	Gradient	1.0°C or less per meter vertical & horizontal	

See page L-2 for explanation of ISO accuracy statements.

# STRATO-Apex 1600

## SERIES 355 — High-Accuracy CNC CMM

The STRATO-Apex 1600 series is a large-sized CNC CMM developed for supporting quality evaluation and assembly of large parts. The scale systems on Mitutoyo high-precision models utilize a high-performance linear encoder (manufactured by Mitutoyo) for detecting axis position. In addition, various technologies have been utilized in the structure, part processing and assembly to provide high-accuracy measurement. Floor vibration at the installation location can be a source of variation in measured values. The auto-leveling air spring vibration isolator is available as an option for STRATO-Apex 1600 series. The vibration isolator insulates the main unit from floor vibrations and can quickly level the CMM main unit using a sensor that detects load fluctuations caused by axis movement of the CMM or workpiece loading. All STRATO-Apex high-precision series CMMs are equipped with temperature compensation and therefore do not require a temperature-controlled room. Accuracy is guaranteed within the range of 16 to 26°C.



STRATO-Apex 1600

Supported Probe Systems		
Type	Probe	STRATO Apex 1600
TOUCH TRIGGER PROBES	MH20i	●
	TP20	●
	TP200	●
	TP7	●
SCANNING PROBES	SP25	●
	MPP	●
	SP80	●
LASER PROBES	SM606	●
	SM606T	●
	SM610	●
	SM1010	●
SURFACE FINISH	SurfTest	●

● Supported ▲ Not Recommended

See page L-20 thru L-27 for probe system information

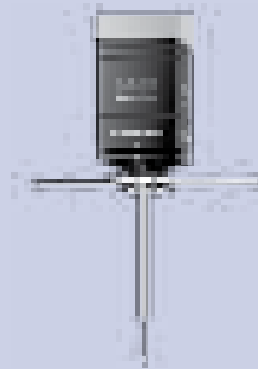

SP80 Probe  
(Extended reach scanning)  
See page L-21

## SPECIFICATIONS

Type: BRIDGE	Model	STRATO-Apex 162012	STRATO-Apex 162016	STRATO-Apex 163012	STRATO-Apex 163016
Range	X axis	62.99" (1600mm)			
	Y axis	78.73" (2000mm)		118.10" (3000mm)	
	Z axis	47.24" (1200mm)	62.99" (1600mm)	47.24" (1200mm)	62.99" (1600mm)
Resolution		0.0000019" (0.00005mm)			
Guide Method		Air bearing on each axis			
Maximum Drive Speed 3D		23.85"/s (606mm/s)			
Maximum Acceleration 3D		0.13G (1,350mm/s <sup>2</sup> )			
Work table	Material	Granite			
	Size	72.83 x 129.13" (1850mm x 3280mm)		72.83 x 168.50" (1850mm x 4280mm)	
	Tapped insert	M8 x 1.25mm			
Workpiece	Max. height	53.14" (1350mm)	368.89" (1750mm)	53.14" (1350mm)	68.89" (1750mm)
	Max. load	7,716 lbs. (3500kg)		8,818 lbs. (4000kg)	
Mass (incl. stand & controller)		24,582 lbs. (11150kg)	24,692 lbs. (11200kg)	33,730 lbs. (15300kg)	33,841 lbs. (15350kg)
Dimensions W x D x H		110.43x147.24x170.86" (2805x3740x4340mm)	110.43x147.24x202.36" (2805x3740x5140mm)	110.43x186.61x172.83" (2805x4740x4390mm)	110.43x186.61x204.33" (2805x4740x5190mm)
ISO-10360-2:2009 E <sub>0,MPE</sub> 18-22°C (64.4-71.6°F)	TP200:	(3.5+4L/1000)μm	(4.0+4L/1000)μm	(3.5+4L/1000)μm	(4.0+4L/1000)μm
	SP25/SP80:	(2.5+4L/1000)μm	(3.0+4L/1000)μm	(2.5+4L/1000)μm	(3.0+4L/1000)μm
ISO-10360-2:2009 E <sub>150,MPE</sub> † 18-22°C (64.4-71.6°F)	TP200:	(3.5+4L/1000)μm	(4.0+4L/1000)μm	(3.5+4L/1000)μm	(4.0+4L/1000)μm
	SP25/SP80:	(2.5+4L/1000)μm	(3.0+4L/1000)μm	(2.5+4L/1000)μm	(3.0+4L/1000)μm
ISO-10360-2:2009 R <sub>0,MPL</sub> †	TP200:	3.5μm	4.0μm	3.5μm	4.0μm
	SP25:	2.5μm			
ISO-10360-4 MPE <sub>THP</sub> /MPT <sub>THP</sub> †	SP25/SP80:	2.5μm/60sec	3.0μm/60sec	2.5μm/60sec	3.0μm/60sec
	TP200:	3.5μm	4.0μm	3.5μm	4.0μm
ISO-10360-5: 2010 P <sub>FTU,MPE</sub>	TP200:	3.5μm	4.0μm	3.5μm	4.0μm
	SP25/SP80:	2.3μm	2.8μm	2.3μm	2.8μm

Stylus Configurations for ISO Tests	
TP200:	Ø4mm x L10mm
SP25/SP80:	Ø4mm x L50mm

Air Supply	
Pressure	58.0 PSI (0.4MPa)
Consumption	3.53CFM (100L/min)
Source	8.82CFM (250L/min)

Environment	18-22°C (64.4-71.6°F)
Rate of change	1.0°C or less per hour 2.0°C or less per day
Gradient	1.0°C or less per meter vertical & horizontal

† This test is not part of Mitutoyo America's standard A2LA-accredited CMM calibration procedure and is quoted upon request. See page L-2 for explanation of ISO accuracy statements.

# FALCIO-Apex 2000/3000

## SERIES 355 — High-Accuracy Large CNC CMM

The FALCIO-Apex 2000/3000 series CNC CMMs use Mitutoyo's standard structure for large machines, which are designed for measuring large and heavy workpieces with high accuracy. The measuring accuracy and drive speed are the highest level in the X-axis measuring range of 2000mm and 3000mm for CNC CMMs worldwide. Units are equipped with a system (MOVAC) to automatically restore accuracy deterioration caused by foundation deformation as a standard feature. Safety devices such as Z-axis beam sensor, tape switch and area sensor are available as options. Built to order.

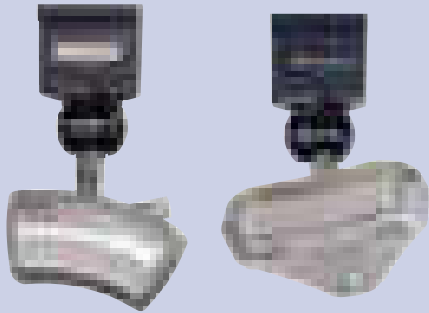

**SurfaceMeasure Probes**  
(Laser scanning probes—non-contact)  
See page L-22



FALCIO Apex 305015G

### SPECIFICATIONS

Type: SEPARATE GUIDE	Model No.	FALCIO-Apex 203015	FALCIO-Apex 204015	FALCIO-Apex 205015	FALCIO-Apex 305015
Range	X axis	78.73" (2000mm)			118.10" (3000mm)
	Y axis	118.10" (3000mm)	157.47" (4000mm)	196.84" (5000mm)	
	Z axis	59.05" (1500mm)			
Resolution		0.0000039" (0.0001mm)			
Mass (incl. stand & controller)		23,368 lbs. (10600kg)	27,557 lbs. (12500kg)	34,392 lbs. (15600kg)	35,273 lbs. (16000kg)
Dimensions W x D x H		174.40x234.25x184.64" (4430x5950x4690mm)	174.40x273.62x184.64" (4430x6950x4690mm)	174.40x312.99x184.64" (4430x7950x4690mm)	213.77x312.99x184.64" (5430x7950x4690mm)
ISO-10360-2:2009 E <sub>0,MPE</sub> 18-22°C (64.4-71.6°F)	TP200:	3.5+4L/1000µm			

Supported Probe Systems		
Type	Probe	FALCIO Apex
TOUCH-TRIGGER PROBES	MH20i	●
	TP20	●
	TP200	●
	TP7	●
SCANNING PROBES	SP25	●
	MPP	▲
	SP80	●
LASER PROBES	SM606	●
	SM606T	●
	SM610	●
	SM1010	●
SURFACE FINISH	SurfTest	●

● Supported ▲ Not Recommended

See page L-20 thru L-27 for probe system information.

Stylus Configurations for ISO Tests
TP200: Ø4mm x L10mm

See page L-2 for explanation of ISO accuracy statements.

#### Main Unit Startup System

This machine incorporates a startup system (relocation detection system), which disables operation when an unexpected vibration is applied or the machine is relocated. Be sure to contact your nearest Mitutoyo prior to relocating this machine after initial installation. Refer to page VIII for details.



**TP200 Probe**  
(Touch trigger)  
See page L-20

# LEGEX 500/700/900

## SERIES 356 — Ultra-high Accuracy CNC CMM

Achieving premium performance, the LEGEX series with its fixed bridge structure and precision air bearings resting on rigid guideways ensures superior stability of motion and ultra-high measuring accuracy. Thorough testing, using FEM structure analysis simulation, guarantees geometric motion accuracy has minimal errors from fluctuations in the load and other variables. LEGEX series CNC CMMs are suitable for complex small- to medium-size workpieces, such as gears, bearings, lens, precision dies or other high-precision workpieces requiring dimensional accuracies with small tolerances.

The LEGEX series incorporates an ultra-high accuracy scale unit with crystallized glass scales (thermal expansion coefficient of  $0.01 \times 10^{-6}/K$ ), and a high-resolution, high-performance reflection linear encoder providing premium positioning performance. All LEGEX Ultra-accuracy series CMM's are equipped with temperature compensation and therefore do not require a temperature controlled room. Accuracy is guaranteed within the range of 18 to 22°C.



### MPP-310Q

Mitutoyo's MPP-310Q probe can be used for point-to-point measuring and continuous scanning applications. If the workpiece requires the maximum accuracy, the MPP-310Q offers zero-point data acquisition for statistical measurement. In this mode the MPP-310Q obtains the measurement data after all the CMM slides have come to a complete standstill. This statistical measurement is intended to eliminate dynamic effects on measurement. See page L-21 for MPP-310Q system information.

### MPP-310Q Specs

- Resolution: 0.01µm
- Measuring Force: 0.20N/mm
- Maximum Stylus Length: 200mm
- Maximum Stylus Weight: 75g

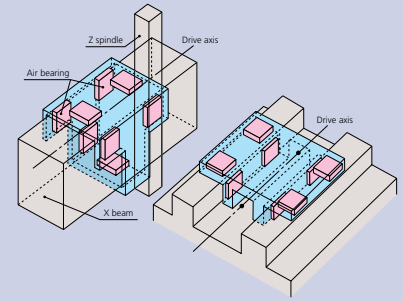
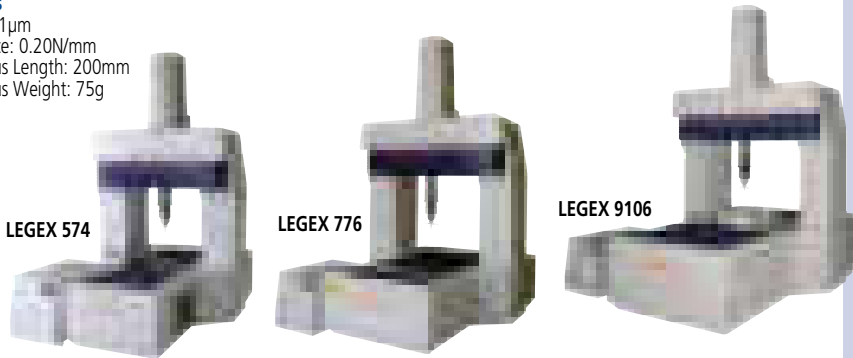

**XY axis independence and center-of-gravity drive system.** The fixed-bridge design of the LEGEX allows the axes to operate independently. Movement of the X-axis slide does not change the loading on the Y-axis slide and therefore does not cause deformation. In addition, the center-of-gravity drive system places the drive units near the center of gravity of each slide, allowing high speed and highly accurate measurements by reducing inertia-induced deflections during acceleration and deceleration.



### Vibration Control

The LEGEX is hardened against floor-induced vibration by use of air-damped spring isolators with an auto-leveling function, virtually eliminating factory-floor vibrations from the entire machine structure.

### Ceramic-coated worktable

Standard feature for corrosion resistance and long life.



## SPECIFICATIONS

Type: FIXED BRIDGE	Model No.	LEGEX 574	LEGEX 774	LEGEX 776	LEGEX 9106
Range	X axis	19.68" (500mm)	27.55" (700mm)		35.43" (900mm)
	Y axis	27.55" (700mm)			39.36" (1000mm)
	Z axis	15.74" (400mm)		23.62" (600mm)	
Resolution		0.00000039" (0.01µm)			
Guide Method		Air bearing on each axis			
Maximum Drive Speed 3D		7.8"/s (200mm/s)			
Maximum Acceleration 3D		0.1G (980mm/s <sup>2</sup> )			
Work table	Material	Cast Iron with Ceramic Coating			
	Size	21.65" x 29.52" (550mm x 750mm)	29.52" x 29.52" (750mm x 750mm)	37.40" x 41.33" (950mm x 1050mm)	
	Tapped insert	M8 x 1.25mm			
Workpiece	Max. height	27.55" (700mm)		33.46" (850mm)	
	Max. load	551 lbs. (250kg)	1,102 lbs. (500kg)		1,763 lbs. (800kg)
Mass (incl. stand & controller)		7,716 lbs. (3500kg)	11,023 lbs. (5000kg)	11,243 lbs. (5100kg)	14,330 lbs. (6500kg)
Dimensions W x D x H		62.44 x 95.66 x 103.54" (1470 x 2430 x 2630mm)	65.74 x 95.66 x 103.54" (1670 x 2430 x 2630mm)	65.74 x 94.48 x 115.35" (1670 x 2430 x 2930mm)	73.62 x 119.29 x 120.07" (1870 x 3030 x 3050mm)
ISO-10360-2:2009 E <sub>0,MPE</sub>	19-21°C (66.2-69.8°F)	MPP310Q:	(0.28+L/1000)µm		(0.30+L/1000)µm
		SP25M:	(0.38+L/1000)µm		(0.40+L/1000)µm
			19-21°C (66.2-69.8°F)		18-22°C (64.4-71.6°F)
ISO-10360-4 MPE <sub>THP</sub> /MPT <sub>THP</sub> †	MPP310Q/SP25M:	1.1µm/60sec			
ISO-10360-5: 2010 P <sub>FTU,MPE</sub>	MPP310Q:	0.40µm			
		SP25M:	0.45µm		

Stylus Configurations for ISO Tests	
MPP310Q:	Ø4mm x L18mm
SP25M:	Ø4mm x L50mm

Air Supply	500/700/1200	900
Pressure	58.0 PSI (0.5MPa)	72.5 PSI (0.4MPa)
Consumption	4.23CFM (120L/min)	
Source	5.65CFM (160L/min)	

Environment	19-21°C (66.2-69.8°F) / 18-22°C (64.4-71.6°F)	
Rate of change	0.5°C or less per hour 1.0°C or less per day	
Gradient	1.0°C or less per meter vertical & horizontal	

† This test is not part of Mitutoyo America's standard A2LA-accredited CMM calibration procedure and is quoted upon request.

See page L-2 for explanation of ISO accuracy statements.

# MACH-V 9106

## SERIES 360 — Inline CNC CMM

The MACH-3A and MACH-V maximize machining operations by performing in-line or near-line high-speed coordinate measuring in conjunction with your CNC machine tools. These high-throughput machines can be incorporated right into the manufacturing line and can provide pre/post machining feedback to your machine tool for machining adjustments.

### SPECIFICATIONS

Type: INLINE	Model No.	MACH-V 9106	
Range	X axis	35.43" (900mm)	
	Y axis	39.36" (1000mm)	
	Z axis	23.62" (600mm)	
Resolution		0.0000039" (0.0001mm)	
Guide Method		Mechanical bearing on each axis	
Maximum Drive Speed 3D		34.09"/s (866mm/s)	
Maximum Acceleration 3D		0.88g (8660mm/s <sup>2</sup> )	
Work table	Material	Steel	
	Size	35.62" x 41.96" (905mm x 1066mm)	
	Tapped insert	M8 x 1.25mm	
Workpiece	Max. height	31.49" (800mm)	
	Max. load	330 lbs. (150kg)	
Mass (including controller)		9,105 lbs. (4130kg)	
Dimensions W x D x H		58.14 x 115.82 x 114.17" (1477 x 2942 x 2900mm)	
ISO-10360-2:2009 E <sub>0,MPE</sub>	TP7/SP25:	19-21°C (66.2-69.8°F)	(2.5+3.5L/1000)µm
		18-22°C (64.4-71.6°F)	(2.7+3.8L/1000)µm
		15-25°C (59.0-77.0°F)	(2.9+4.3L/1000)µm
		5-35°C (41.0-95.0°F)	(3.6+5.8L/1000)µm
		ISO-10360-4 MPE <sub>THP</sub> /MPT <sub>THP</sub> †	SP25:
ISO-10360-5: 2010 P <sub>FTU,MPE</sub>	TP7:	2.2µm	
	SP25:	2.2µm	

† This test is not part of Mitutoyo America's standard A2LA-accredited CMM calibration procedure and is quoted upon request.



MACH-V 9106



See page L-21.

Stylus Configurations for ISO Tests	
TP7:	Ø4mm x L20mm
SP25:	Ø4mm x L50mm

Environment	5-35°C (71.6-64.4°F)
Rate of change	2.0C° or less per hour 10.0C° or less per day
Gradient	1.0C° or less per meter vertical & horizontal

# MACH-3A 653

## SERIES 360 — Inline CNC CMM

Inline CNC CMM (horizontal type) incorporating the CMM controller and host computer in the main unit results in a compact spacing-saving footprint for the shop floor. This series is designed for 24-hour operation, resulting in stable operation.

### SPECIFICATIONS

Type: INLINE	Model No.	MACH-3A 653	
Range	X axis	23.62" (600mm)	
	Y axis	19.68" (500mm)	
	Z axis	11.02" (280mm)	
Resolution		0.0000039" (0.0001mm)	
Guide Method		Mechanical bearing on each axis	
Maximum Drive Speed 3D		47.71"/s (1,212mm/s)	
Maximum Acceleration 3D		1.21G (11,882mm/s <sup>2</sup> )	
Mass		8,818 lbs. (4000kg)	
Dimensions W x D x H		73.62 x 50.39 x 75.59" (1870 x 1280 x 1920mm)	
ISO-10360-2:2009 E <sub>0,MPE</sub>	SP25:	19-21°C (66.2-69.8°F)	(2.2+3.5L/1000)µm
		15-25°C (66.2-69.8°F)	(2.5+4.2L/1000)µm
		10-30°C (50.0-86.0°F)	(2.9+5.0L/1000)µm
		5-35°C (66.2-95.0°F)	(3.2+5.7L/1000)µm
		19-21°C (66.2-69.8°F)	(2.5+3.5L/1000)µm
TP7:	15-25°C (66.2-69.8°F)	(2.8+4.2L/1000)µm	
	10-30°C (50.0-86.0°F)	(3.2+5.0L/1000)µm	
	5-35°C (66.2-95.0°F)	(3.5+5.7L/1000)µm	
ISO-10360-4 MPE <sub>THP</sub> /MPT <sub>THP</sub> †	SP25:	4.0µm/40sec	
ISO-10360-5: 2010 P <sub>FTU,MPE</sub>	SP25:	2.2µm	
	TP7:	2.5µm	

† This test is not part of Mitutoyo America's standard A2LA-accredited CMM calibration procedure and is quoted upon request.

See page L-2 for explanation of ISO accuracy statements.

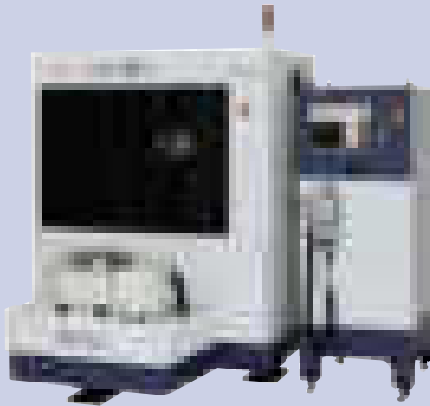

MACH-3A 653



TP7 Probe  
(High-precision tough-trigger)  
See page L-20.

Stylus Configurations for ISO Tests	
TP7:	Ø4mm x L20mm
SP25:	Ø4mm x L50mm

Environment	5-35°C (71.6-64.4°F)
Rate of change	2.0C° per hour 10.0C° per day
Gradient	1.0C° or less per meter vertical & horizontal

# MACH KO-GA-ME

## SERIES 360 — Inline CNC CMM

Mitutoyo MACH Ko-ga-me is a compact, 3D CNC measuring system that can be configured to almost any process. Use for stand-alone applications or integrate into cells. If required, the system can measure workpiece features that exceed the Ko-ga-me's X stroke by mounting the workpiece, or the Ko-ga-me, on an auxiliary X axis. Ideal for inspection of large or small workpieces and offers a wide choice of measuring probes including touch-trigger, optical and scanning types. (Note: Probe choice may be restricted, depending on the application.)

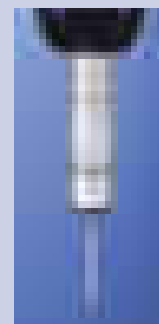

**SP25 Scanning Probe**  
See page L-21.

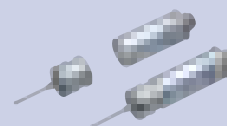

**TP200 Touch-Trigger Probe**  
See page L-20.

### SPECIFICATIONS

Type: INLINE	Model No.	KGM888-B	KGM12128-B
Range	X axis	3.14" (80mm)	4.72" (120mm)
	Y axis	3.14" (80mm)	4.72" (120mm)
	Z axis	3.14" (80mm)	
Resolution		0.0000078" (0.02µm)	
Guide Method		Straight-motion hard bearing	
Maximum Drive Speed 3D		13.38"/s (340mm/s)	
Maximum Acceleration 3D		0.68G (6,750mm/s <sup>2</sup> )	
Mass: main unit		61.7 lbs. (28kg)	
Dimensions*		15.03 x 14.68 x 30.90"	
W x D x H: (height includes Z measuring range)		(382 x 373 x 785mm)	
Measuring Accuracy (ISO 10360-2:2009)			
TP200/SP25:	19-21°C (66.2-69.8°F)	(2.4+5.7L/1000)µm	
	15-25°C (66.2-69.8°F)	(2.7+6.4L/1000)µm	
	10-30°C (50.0-86.0°F)	(3.1+7.2L/1000)µm	
	10-35°C (50.0-95.0°F)	(3.4+7.9L/1000)µm	
Probing Error (ISO 10360-2:2009)			
	TP200/SP25:	2.0µm	
Scanning probing error (ISO 10360-4:2000)			
	SP25:	2.7µm(30s)	
Stylus Configurations for Accuracy Tests		Environment	10-35°C (50.0-95.0°F)
TP200: Ø3mm x L10mm		Rate of Change	2.0C° or less per hour 10.0C° or less per day
SP25: Ø4mm x L50mm		Gradient	1.0C° or less per meter vertical & horizontal

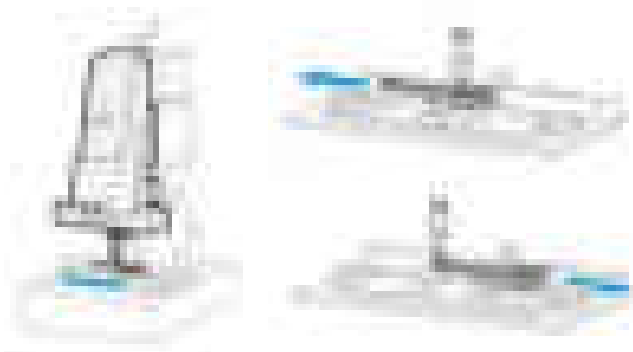

See page L-2 for explanation of ISO accuracy statements.



# CARBapex / CARBstrato

## SERIES 355 — Car Body Measuring System CNC CMM

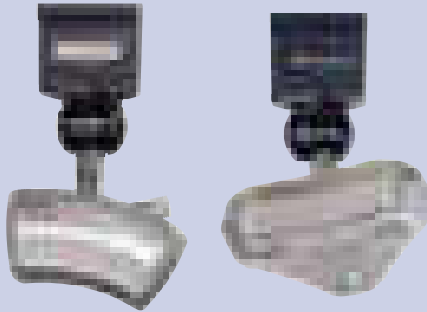

### SurfaceMeasure Probes

(Laser scanning probes—non-contact)

See page L-22 for probe system information.

### The world's largest class

The CARBapex and CARBstrato series is a lineup of cost-effective horizontal, large CNC CMMs and offers the world's largest class measurement range, making it possible to measure car bodies.

### Single & Dual

Single- and dual-types are available to fit the intended use.

Single type: Measure a workpiece with a single CMM from the CARBstrato series.

Dual type: Measure a workpiece placed between two simultaneously controlled CMMs from the CARBstrato series.

Because the height of the X-axis base of both the single- and the dual-type is set lower, the required depth for the foundation before the installation is relatively shallow.

### Remarkable usability

The CARBapex series not only has remarkable usability, but also has the ability to enhance the safety operation by performing the procedures on the shop floor. The Y-axis spindle in the vertical direction is set lower in order to perform measurements at a lower workpiece setting height. In addition, the small cross-section of the Y-axis spindle reduces interference during measurement and expands the measurement area inside a car body.

### Safety after installation

Since the height of the X-axis base is set lower, the required depth for the foundation before installation is comparatively shallow. The structure is designed to avoid both long- and short-term problems, such as an aging of the foundation (concrete) or accuracy deterioration resulting in the bimetal phenomenon caused by deformation of the foundation or the X-axis base due to common environmental changes.

### Options

- Line laser probe for non-contact measurement (SurfaceMeasure).
- Measurement point search function, a necessity for car body measuring, is included in the metrology software.
- A variety of optional safety devices enhance operator safety. Built to order.

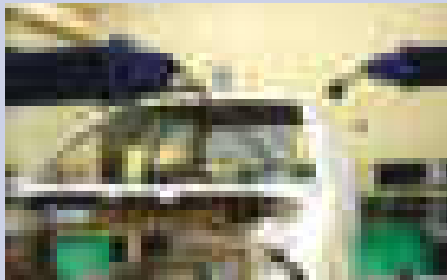
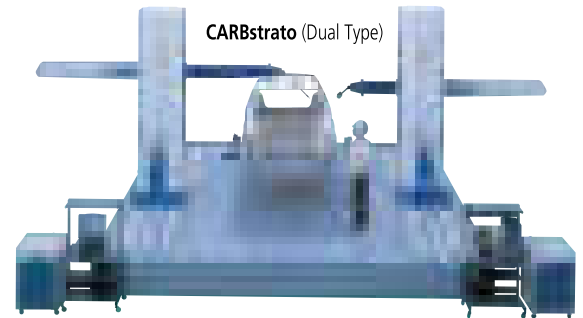
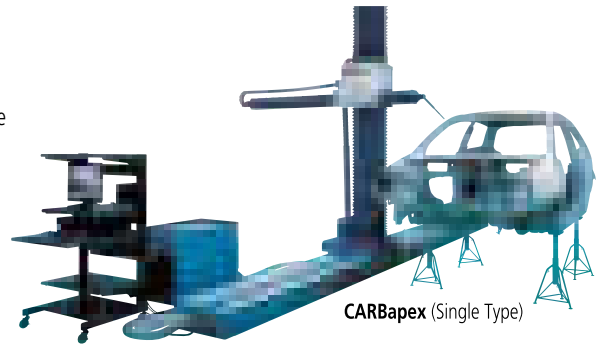

### Main Unit Startup System

This machine incorporates a startup system (relocation detection system), which disables operation when an unexpected vibration is applied or the machine is relocated. Be sure to contact your nearest Mitutoyo prior to relocating this machine after initial installation.

## SPECIFICATIONS

Type: HORIZONTAL ARM	Model No.	CARBapex 601624	CARBstrato 601624	
Range	X axis	236.21" (6000mm)		
	Y axis (Single)	62.99" (1600mm)		
	Y axis (Dual)	153.54" (3900mm)		
	Z axis	94.48" (2400mm)		
Resolution		0.0000039" (0.0001mm)		
Mass	Single Arm	4,982 lbs. (2260kg)	13,845 lbs. (6280kg)	
	Dual Arm	9,964 lbs. (4520kg)	27,690 lbs. (12560kg)	
Dimensions W x D x H	Single Arm	163.18 x 275.58 x 144.33" (4145 x 7000 x 3666mm)	176.10 x 238.34 x 155.62" (4473 x 7324 x 3953mm)	
	Dual Arm	322.79 x 275.58 x 144.33" (8190 x 7000 x 3666mm)	348.26 x 238.34 x 155.62" (8846 x 7324 x 3953mm)	
ISO-10360-2:2009 E <sub>0,MPE</sub> 16-26°C (60.8-78.8°F)	Single Arm	TP20:	(25+28L/1000≤95)μm	(18+20L/1000≤70)μm
		SP25:	(20+28L/1000≤95)μm	(15+20L/1000≤70)μm
	Dual Arm	TP20:	(50+35L/1000≤120)μm	(38+30L/1000≤90)μm
		SP25:	(45+35L/1000≤120)μm	(35+30L/1000≤90)μm
ISO-10360-5: 2010 P <sub>FTU,MPE</sub>	Single Arm	TP20:	20μm	15μm
		SP25:	15μm	13μm
	Dual Arm	TP20:	20μm	15μm
		SP25:	15μm	13μm

### Stylus Configurations for ISO Tests

TP20: Ø3mm x L10mm

SP25: Ø4mm x L50mm

See page L-2 for explanation of ISO accuracy statements.

# MCOSMOS

## Software for Manual / CNC Coordinate Measuring Machines

### Three levels of module configuration

MCOSMOS has three choices of module configuration. From the basic MCOSMOS-1 to the advanced MCOSMOS-3, choose a configuration for your measurement applications.

	MCOSMOS Coordinate Measuring Machine Software			
	CNC			Manual
	MCOSMOS-1	MCOSMOS-2	MCOSMOS-3	MCOSMOS-M
GEOPAK	●	●	●	●
CAT1000P	▲	●	●	—
CAT1000S	▲	●	●	▲
Scanpak	▲	▲	●	▲
Gearpak	▲	▲	●	—
MAFIS*	▲	▲	▲	—

● Standard ▲ Option — Not supported \* Requires Scanpak

#### GEOPAK (Basic Geometry Module)

Geopak provides an easy graphical console through the use of tool bars and windows which can be personalized to the operator's preference. Geographically enhanced displays provide step-by-step on-screen wizards that prompt the operator, allowing even inexperienced users to create routines to measure parts. The entry-level MCOSMOS-1 software includes flexible advanced tools demanded by the most experienced operators; e.g. looping, formula calculations or expressions that use variables, libraries of day-to-day subroutines and conditional statements, which can add logic for a variety of applications.

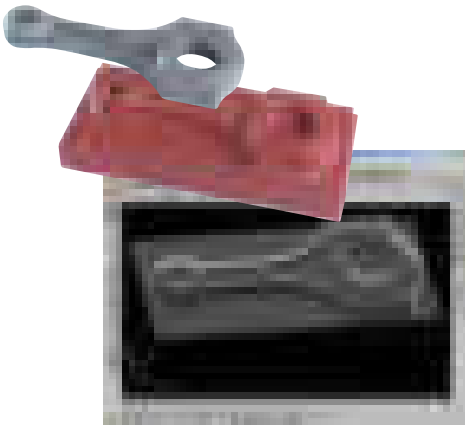

#### SCANPAK (2D Profile Evaluation Module)

For the scanning and evaluation of workpiece contours (2D), and data transfer to CAD system.

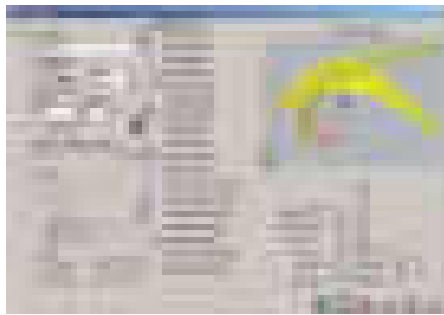

#### MAFIS (Mitutoyo Airfoil Inspection System)

Evaluation and analysis of airfoil shapes such as turbine blades that require special calculations according to the particular design specifications. The MAFIS system uses cross sectional data of the shape obtained by Scanpak to perform these calculations and outputs the result via the standard geometry program.



#### GEARPAK (Gear Measurement and Analysis Module)

Advances in CMM controller techniques make the measurement of gears feasible, and the Gearpak module takes advantage of this to bring sophisticated measurement capabilities within reach.



**MiCAT**

Mitutoyo Intelligent Computer Aided Technology

the standard in world  
metrology software

**CMM**

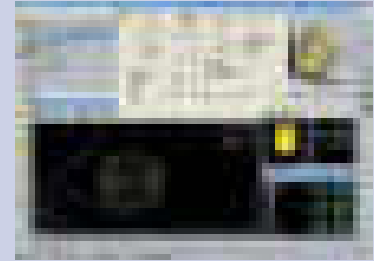

## Mitutoyo Controlled Open Systems for Modular Operation Support

MCOSMOS by Mitutoyo is a proprietary metrology suite of inter-related modules and dedicated expansion modules for the Microsoft Windows 7 operating system. The world's standard in metrology software, MCOSMOS is supported in 37 locations worldwide and in 12 languages. (A proud Microsoft Gold Partner.)

Developed with MiCAT (Mitutoyo Intelligent Computer Aided Technology), your Mitutoyo CMM is streamlined with intuitive user interfaces that provide a familiar look and feel to operate multiple modules. They work together seamlessly for applications throughout the entire production process to put reliable metrology at you fingertips.

MCOSMOS allows integration among a whole series of applications, improving the efficiency of your CMM and the productivity of your quality control functions. Specific expansion modules are available including GEOPAK or for specific applications such as gear measurement, airfoil analysis, reverse engineering and integrating CAD with metrology.



### CAT-1000P (Prismatic)

Not available for manual CMMs

CAT1000P significantly facilitates the programming of measurement tasks during the GEOPAK learn mode. All data for measuring parts and tolerance evaluations are taken from the CAD model via pointing device (mouse, trackball, etc.). The same principles apply for programming probe paths (clearance and measurement), while at the same time using the nominal directly from the CAD model for tolerance comparison.

Spatial's 3D InterOp delivers the highest quality data exchange between CAD formats, enabling superior CAD file translation.

Standard with CAT-1000 is ACIS (\*.sat) and STEP AP203, which are both licensed copies from Spatial InterOp. CATIA V5, SolidWorks, NX Siemens (Unigraphics), Parasolids, AutoDesk Inventor, Pro-Engineer and IGES or VDAFS exchange formats are available as an option.

The comprehensive suite of translators provides import/export for all applications, including ACIS, CGM and Parasolid-based applications.

3D InterOp is embedded in many of today's leading design, engineering and manufacturing applications.

CAT-1000 uses 3D ACIS® Modeler, Spatial's prominent modeling component used in more than 350 customer applications with more than 2 million seats worldwide.

CAT-1000 fully supports and reads PMI (Product Manufacturing Information), which is embedded in the model for datum alignment and GD&T (Geometric Dimensioning and Tolerancing).

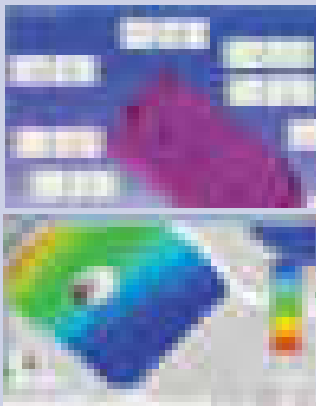
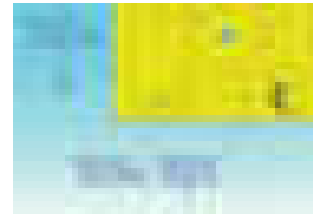
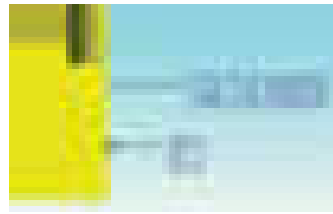
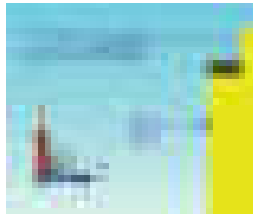

### CAT-1000S (Free-form Sculpted)

CAT-1000S is a highly versatile tool that can be used on a manual CMM or a CNC CMM. A coordinate system in GEOPAK is compared to the CAD model. Real-time surface disposition is displayed by showing a color class to determine if there is material to remove or replace.

Surface deviation can be displayed as spherical points or as a gradient surface. Cones also can be used to show the direction of the deviation.

GEOPAK CNC can create grid pattern to verify the surface points. A one-click tool calculates a collision-free probe path to measure a grid of surface points offset from the edge.



If the CAD model has specific points, GEOPAK-CNC can drive the machine to the defined points or vertices.



In addition to the online/offline part program creation, CAD model-based generation of surface measurement points, and comparison of actual/nominal data, with graphical output is available.



# MiCAT Planner

## Automatic Measurement Program Generation Software

MiCAT Planner is Mitutoyo's latest software development for fast and efficient CMM part programming. Operation of MiCAT Planner is easy and intuitive. Programs are made with a few mouse clicks in jminutes instead of hours or days.

### WORKFLOW:

- 1) Load design model
- 2) Select target CMM
- 3) Part placement via virtual alignment
- 4) Measurement program creation
- 5) Translate to Geopak MCOSMOS



MiCAT Planner toolbar is workflow based.

In order to generate a measurement plan, GD&T information attached to the 3D Design Model is needed. Design Model formats marked "w/PMI" will read GD&T information created in the CAD system and stored in the Design Model file. Design Model formats without PMI can be annotated with GD&T in MiCAT Planner.

### Design Model Support:

- Siemens NX w/PMI
- CATIA v5 w/PMI
- PRO/E w/PMI
- SOLIDWORKS w/PMI
- ACIS (SAT)

If the Design Model does not contain GD&T information, or the information is incomplete, GD&T information can be added or edited with MiCAT Planner with the following:

- Add new GD&T to an existing feature
- Add GD&T to a new feature
- Edit exiting GD&T information
- Modify display of GD&T in 3D view

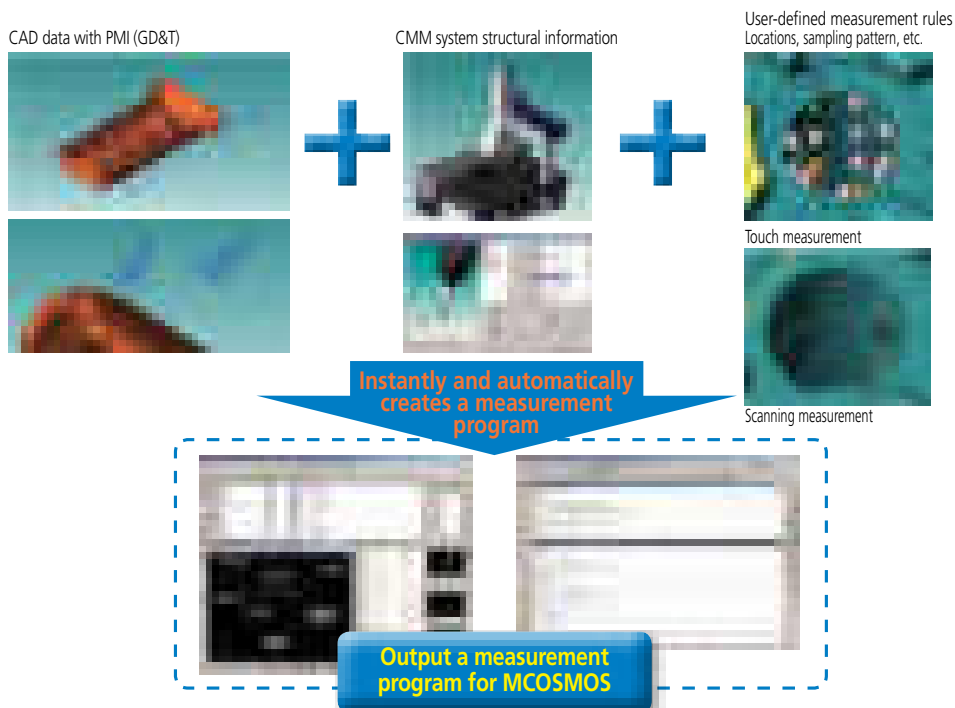

# MiCAT



### Feature/Benefits of MiCAT Planner:

#### Automatic part program generation

- Up to 90% time savings in CMM part program creation

#### Collision control

- Minimize potential costly and damaging probe collisions

#### Program simulation

- Virtual pre-run of measurement program ensures maxim efficiency

#### Rule editor

- Automatically apply individual or global measurement strategies for all part programs or specific programs

#### Plan view

- Easy selection of characteristics, features and measurement point sets to include or exclude from the measurement plan

#### Property pane

- Feature parameter settings for the current selected item can be an exception to a user-defined rule

#### Direct Help

- Clear, concise explanation for features that can't be measured (missing GD&T, probe angle not defined, etc.)

#### GD&T Wizard

- The GD&T Wizard enables the use of Design Models that do not include any PMI by allowing the user to add, edit or delete PMI information without modifying the original CAD file. All additions, changes or deletions reside solely within the MiCAT Planner project database. (See Design Model Support above left for the current list)



[www.mitutoyo.com/MiCAT](http://www.mitutoyo.com/MiCAT)

## Measurement Plan

The measurement plan is synchronized with the 3D view and Program View. For example, a feature can be selected in any of the views (Plan View, 3D View, Program View) and is highlighted in the other views. Manual reordering of the feature measurement order is possible by drag and drop of the features in the Plan View. Users can select a feature, characteristic or point set in the Plan View to modify the corresponding properties in the Property View.

### Load and Use MCOSMOS DME Configurations:

(DME: Dimensional Measuring Equipment)

- Load predefined DME configurations from CMM SystemManager
- Default DME is read directly from the MCOSMOS settings
- MiCAT Planner generates a program specifically for the selected DME
- Align DME and Design Model by mating, dragging, center of table or volume, or by direct numerical input
- Import PCS (part coordinate system) information from MCOSMOS



## Rules Editor

The Rules Editor allows users to create rules to define measurement approaches, such as number of points per feature, sensor type, fitting method and automatic sensor selection.

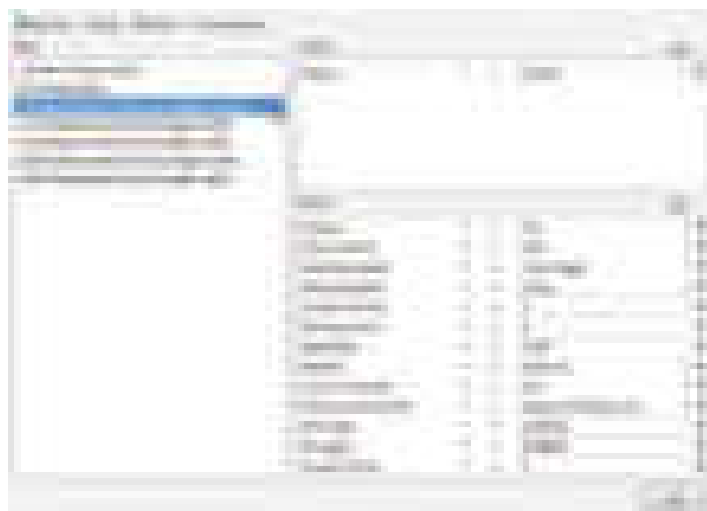

Rules are applied during CAD import and can be re-applied after design model import. The Run Selected command automatically updates the measurement plan with the current defined rules and updates changes in the Plan and Program views.

# CMM Probe & Change Rack Options

## Touch-trigger Probe System



### MH20i - Manual head

MH20i is a manually adjustable probe head with an integral TP20 kinematic stylus module mount with two-axis indexing. The A-axis rotates through  $\pm 180^\circ$  in the X-Y plane. The B-axis rotates through  $90^\circ$  in the Z plane. A lever locks the head in one of up to 168 repeatable positions, set at  $15^\circ$  increments. Capable of carrying the full range of TP20 modules, which can be changed without re-qualification, providing qualification has taken place in each position with each stylus/module combination.

**CMM:MANUAL | CNC**

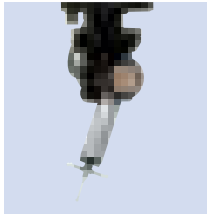

### PH1 - Manual probe head

The PH1 is a general purpose, swivel-type probe head. Its compact design makes it ideally suited to a CMM where manual orientation of an M8 thread-mounted touch-trigger probe is required (TP20, TP200). The PH1 provides two axes of movement. The A-axis allows probe orientation in the vertical plane; the B-axis allows rotational probe orientation. Axis rotation is in relation to the shank mount. Probe re-qualification is required after each re-orientation of the PH1. TP200 not supported on manual CMM..

**CMM:MANUAL | CNC**

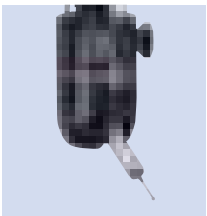

### MIH - Manual indexable probe head

The manually indexable head (MIH) has 720 repeatable positions and features an autojoint probe mount for fast, repeatable probe changing. This probe head is compatible with the TP6A touch probe directly and supports the TP20, and TP200 probe with the use of the autojoint extension bars (e.g. PAA1). An integral LCD enables easy programming with the facility to memorize up to 20 probe positions. Not for use with multi-wire probes.

**CMM:MANUAL | CNC**

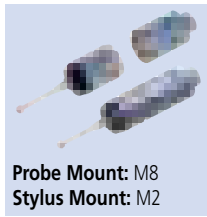

### TP20 - Touch-trigger probe

The TP20 is a compact kinematic touch-trigger probe system featuring a two-piece design, comprising probe body and detachable stylus module(s), connected using a highly repeatable magnetic kinematic coupling. This provides the facility to change stylus configurations either manually or automatically without the need for requalification of the stylus tips. Modules offering a range of trigger forces allow the probe performance to be best matched to the measurement task.

**CMM:MANUAL | CNC**

Probe Mount: M8  
Stylus Mount: M2

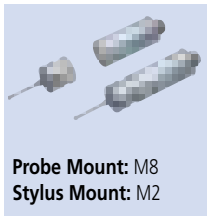

### TP200 - Touch-trigger probe

The TP200 features quick-change stylus configurations without the need for requalification, utilizing electronic strain sensing techniques to improve on the form measuring accuracy and operating life that can be achieved when compared with kinematic touch-trigger probes. The TP200 probe is a two-piece design comprising the probe body and a detachable stylus module that holds the stylus assembly.

**CMM:CNC**

Probe Mount: M8  
Stylus Mount: M2

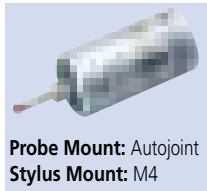

### TP7 - High-accuracy, touch-trigger probe

The TP7M is a high-accuracy touch-trigger probe with a maximum repeatability of  $2\sigma \leq 0.25\mu\text{m}$ . The TP7M can mount a long stylus up to 150mm. In combination with the longest autojoint probe extension of 200mm for direct mounting to the PH10M or PH10MQ, gives the TP7M a maximum access distance of 350mm.

**CMM:CNC**

Probe Mount: Autojoint  
Stylus Mount: M4



### UMAP-CMM - Micro-touch probe

A stylus with an ultra-small diameter of  $\varnothing 0.1\text{mm}$  or  $\varnothing 0.3\text{mm}$  can be used. Measurement of miniscule form and dimensions from practically any direction is possible by mounting on the PH10MQ.

**CMM:CNC**

### MCR20 - Module Change Rack (TP20)



The MCR20 is designed to securely hold the stored TP20 probe modules for automatic changing (CNC CMM only) and to protect from airborne contaminants.

### SCR200 - Module Change Rack (TP200)



The SCR200 provides automatic, high-speed changing between up to six TP200 stylus modules (CNC CMM only). The SCR200 is powered by the separate probe interface, PI 200, and provides features to facilitate safe stylus changing.

### MSR - Manual Storage Rack (TP20/TP200)



The MSR1 manual storage rack holds up to 6 pre-qualified stylus assemblies fitted to TP20 or TP200 probe modules to simplify manual module changing. The MSR1 can be mounted on the CMM table or on a vertical surface.

### MAP - Manual Autojoint Probe (TP6A/TP7)



The MAP (manual autojoint probe) stand is a low-cost storage rack capable of holding up to six autojoint mounted probes and extension bars. The MAP stand can be mounted directly on the table of a CMM, cabinet, wall or any vertical surface.

See page L-28 for stylus information.

# CMM Probe & Change Rack Options

## Motorized Probe Heads

The range of PH10 PLUS motorized probe heads increases throughput by giving CNC CMMs the added capability of program controlled probe re-orientation. This enables the inspection of features at different angles without the need for frequent, time-consuming stylus cluster changes.

SC6 - Stylus Changer (MPP-310Q)



ACR3 - Autojoint Change Rack (SP25M)



FCR25 - Flexible Change Rack (SP25M)

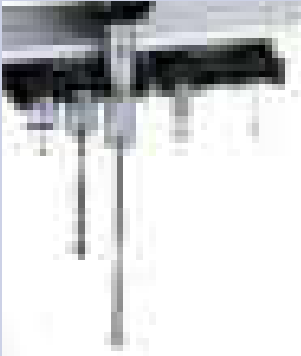

FCR25-L3 - Flexible Change Rack (SP25M)



FCR25-L6 - Flexible Change Rack (SP25M)



SCP80 - Stylus Change Port (SP80)



### PH10T

Shank-mounted head with two-wired probe capability and an M8 thread supporting TP20, TP200 and TP6 touch-trigger probes.

### PH10M/10MQ

The PH10M PLUS can carry long extension bars and multi-wire probes such as QVP, SP25M, SurfaceMeasure, SurfTest, UMAP-CMM or TP7M. The highly repeatable autojoint allows rapid probe or extension bar changing without the need for re-qualification. The PH10MQ PLUS is a variant of the PH10M PLUS that allows the motorized head to be attached directly to the quill with the B-axis of the head inside the quill itself. This option provides a neater and shorter probe mount, with only the A-axis protruding from the quill.

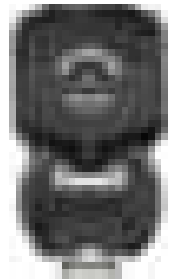

PH10M



PH10MQ

## Scanning Probe Systems



### MPP-310Q Ultra-High Accuracy Scanning

The MPP310Q is a multifunctional measuring head for CNC CMMs. It not only performs continuous contact scanning measurements at  $V2 \leq 0.3 \mu\text{m}$ , it also allows highly precise point measurements and self-centering measurements. The MPP-310Q incorporates  $0.01 \mu\text{m}$  resolution high-precision scales for each axis (XYZ). Air bearings on all axes ensures smooth measuring with minimal measuring force. Software-controlled clamps in each axis eliminate probe deflection while scanning slanted or arched surfaces to reduce measurement errors. The MPP-310Q allows for contact force as low as 0.03 Newtons for sensitive workpieces or when using very small stylus tips. Scanning speed up to 120mm/second can be achieved on known path geometry. Stylus holder changing is supported with the SCR6.

### SP25M Compact High-Accuracy Scanning Probe

The SP25 is a compact high-accuracy scanning probe with an outside diameter of  $\varnothing 25 \text{ mm}$ . This multi-functional probe is suitable for CNC coordinate measuring machines that perform not only scanning measurement, but also high-accuracy point measurement, as well as data collection from a centering-point measurement. The SP25M measuring head is extremely flexible, in addition to its measuring accuracy at very low contact forces, the SP25M can be used with probe systems ranging in lengths from 20mm (SP25-1) up to 400mm (SP25-4). The SP25M can be used on a fixed probe head (PH6M), or a motorized probe head (PH10M/10MQ). Probe systems, probe module and stylus holder changing is supported with the ACR3 and FCR25 rack changing systems.

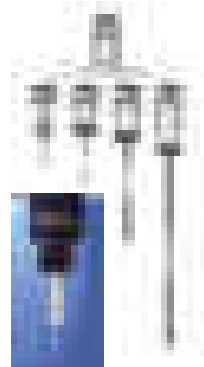

### SP80 Extended-Length High-Accuracy Scanning

The SP80 scanning measuring head is specially designed for extended length stylus with high-accuracy measurement for lengths up to 500mm (measured in the vertical and horizontal directions). The multifunctional head for CNC CMM' allows not only scanning measurements but also high-precision point measurements and self-centering measurements. Stylus holder changing is supported with the SCP80.

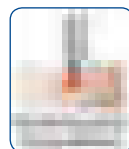

See page L-28 for stylus information.

# Non-Contact CMM Probe Options

SurfaceMeasure 606/610/1010/606T/201FS

## FEATURES

Mitutoyo's line of laser scanning probes automatically adjusts to workpiece surface characteristics to deliver highly efficient measurements. With a conventional laser probe, laser intensity and camera sensitivity must be adjusted according to the environment and workpiece material. In contrast, the SurfaceMeasure line laser probes, which automatically adjust for these factors, enable hassle-free and more reliable laser scanning results.

The SurfaceMeasure makes it possible to use coordinate measuring machines as production systems that can be used throughout the entire process, from development and prototyping to production.

## Development phase

Optimized design utilizing measurement point cloud data significantly improves the efficiency of the development process, even when no master model or CAD data is available.



## Prototyping phase

Shortens the entire process from prototyping to mass production because simulations can be used to compare prototypes with CAD data, check for part interference and set clearances, and optimize machine settings.

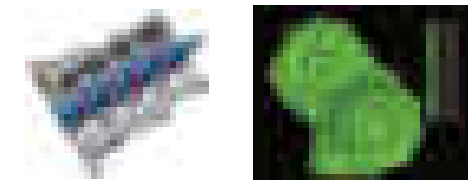

## Production phase

Allows the obtained data to be used for correcting dies, for example, by controlling the variability in mass-produced products, and feeding analysis data back to the preceding process step.



With a conventional laser probe, laser intensity and camera sensitivity must be adjusted according to the environment and the workpiece material. In contrast, the **SurfaceMeasure Series**, which automatically adjusts for these factors, enables simpler and more comfortable laser scanning.



Measuring a color sample plate

Measuring a glossy object

Because the laser intensity and camera sensitivity are automatically adjusted, stable shape data can be obtained even when the workpiece has multiple colors and varying degrees of reflectance.

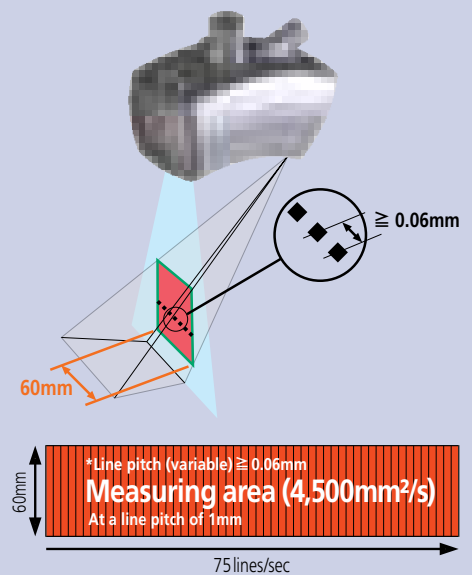
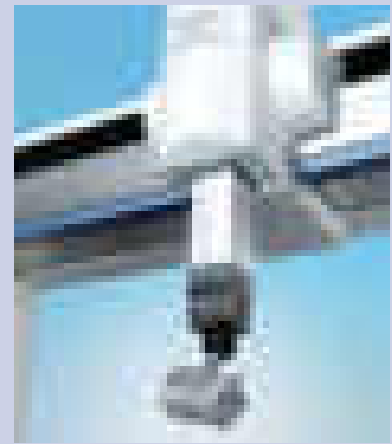

Improvement in measurement efficiency by reducing the frequency of probe attitude change.

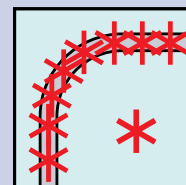

No change of probe attitude

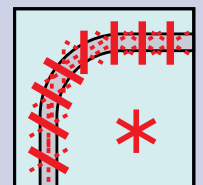

Individual beam selectable

Simultaneous measurement of top and side by concurrently scanning 3-directional laser beams

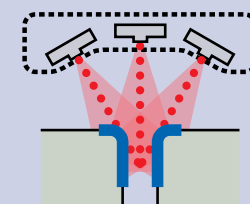

The laser beams converge from 3 directions toward a central point.

The line-laser crossing enables simultaneous scanning by 3 laser beams, thus allowing efficient measurement of complicated shapes.

(Applies to **SurfaceMeasure 606T**)



# Non-Contact CMM Probe Options

SurfaceMeasure 606/610/1010/606T/201FS



## Features of Non-contact CMM

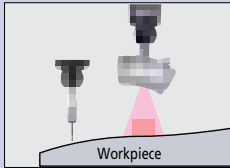

### Reliability

- Based on a CMM that supports quality assurance operations.
- Allows the verification of non-contact measurement data with a contact probe.



### Hybrid measurement

- Visualizes a shape that was previously invisible by establishing a cutting plane from measured points.
- Allows interchange between contact and non-contact probes according to the required measuring accuracy or workpiece shape.



### Fully automatic measurement

- Automatic probe change with a probe changing rack.
- Allows programming a series of jobs from measurement to report creation.

### Ultra-high speed data collection

- SurfaceMeasure is a laser probe that collects coordinate values of the surface of the workpiece by moving and irradiating laser light over the workpiece.

\* When using SurfaceMeasure 606/610/1010

### Advantages of non-contact type

- Non-contact measurement enables measurement of materials that can be easily-deformed by contact measurement, including resin or thin, elastic parts.

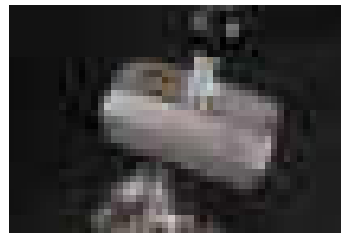

606/610/1010

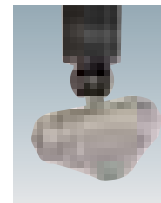

606T

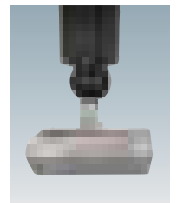

201FS

### Powder-less measurement

- Automatic configuration of the camera sensitivity and the laser intensity settings according to the environment and materials enable establishing a simple and comfortable laser-scanning environment since measurement is now powder and spray free.

### Evaluation cases

- The collected point cloud data can be used by various optional software in a wide range of applications, such as editing, plane creation, comparison using CAD data and more.

## SPECIFICATIONS

Item / Model	SurfaceMeasure 606	SurfaceMeasure 610	SurfaceMeasure 1010	SurfaceMeasure 606T	SurfaceMeasure 201FS
Laser irradiation method	Line Laser (single)			Line Laser (cross)	Flying spot
Max. scan width	2.36" (60mm)	2.36" (60mm)	3.94" (100mm)	.2"×2.56" (3×65mm)	Max. 23mm
Max. scan depth	2.36" (60mm)	3.94" (100mm)	3.94" (100mm)	2.56" (65mm)	15mm
Working distance	3.54" (93mm)	4.53" (115mm)	4.53" (115mm)	6.85" (174mm)	57.5mm
Scanning error *	12μm	15μm	18μm	17μm	1.8μm
Max. Acquisition rate	75,000 points/sec			3×25,000 points/sec	25,000 points/sec.
Mass	0.95 lbs (430g)	0.88 lbs (400g)	0.88 lbs (400g)	1.06 lbs (480g)	500g
Laser Class	EN/IEC	Class2 [ EN/IEC 60825-1(2007) ]			
	JIS	Class2 [ JIS C 6802 : 2011 ]			
Line Laser	Laser type	Red semiconductor			Semiconductor
	Wavelength	660nm			670nm
Point Laser	Output	4mW			1 mW
	Wavelength	635nm			—
Point Laser	Output	1mW			—
	—	—			—

\*1: Made-to-order models

\*2: According to Mitutoyo's acceptance procedure. (1 σ /sphere measurement, probe alone)

Accuracy inspection environment	Temperature: 20°C±1°C / Humidity: 50%±10%
* Target workpiece	Specified master ball for inspection (Diameter 30mm)
Inspection method	According to Mitutoyo's acceptance procedure. (1 σ /sphere measurement, probe alone)

## MEASURING RANGE

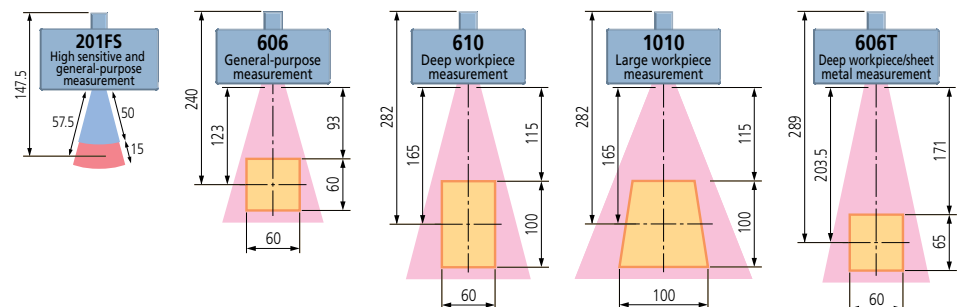

# MSURF

## Software for SurfaceMeasure Probe for CNC CMMs



### Laser Scanning: MSURF-S

A scanning path can be created by defining a scanning start point, a scanning length and a scanning width.

- Specify the 3 points using the joystick while watching the camera view.
- When a point group or master data exists on the screen, 3 points can be defined by selecting the data using the mouse. Automation of measuring paths from start to finish reduces measuring time.
- Operating of a joystick and buttons enables configuration and execution of a scanning path,

and registration to or deletion from a macro. The ability to measure without using a PC has significantly improved operational efficiency, particularly for large-sized CMMs.

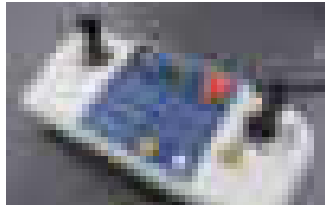

Scanning paths can be registered as a measurement macro.

- The measurement conditions of a measurement macro can be partly or wholly changed by the override function.
- The sub-macro function is effective for measuring multiple identical workpieces.
- A trial calculation of measurement macro execution time is based on the measurement conditions and the specifications of the CMM.



MSURF-S can be started from MCOSMOS.

- A work coordinate system created with MCOSMOS can be used with MSURF-S. Therefore, fully automatic measurement combined with contact measurement/non-contact measurement can be performed.

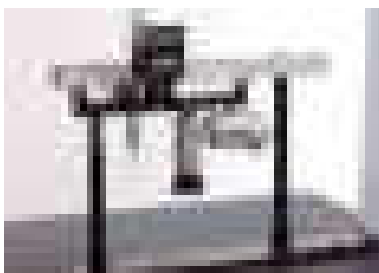
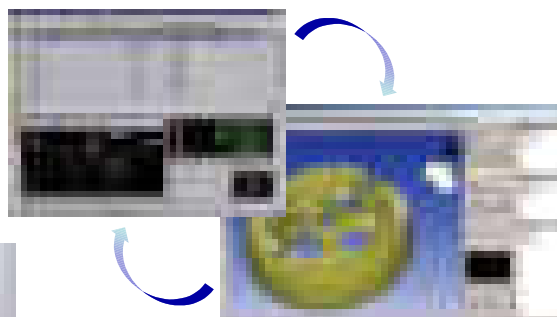

Note: If not using ACR3, probe replacement is performed manually.

MSURF software enables users to perform operations from measurement to evaluation on the same platform when the non-contact line laser probe, SurfaceMeasure, is used. Three types of software are provided according to the task:

**MSURF-S:** Calculates point cloud data measured by CNC CMM with SurfaceMeasure. Generates scanning paths by defining the scanning start position, length and width.

**MSURF-I:** Conducts analysis or comparison verification of measured point cloud data in reference to nominal data (supporting CAD data import).

**MSURF-G:** Primarily creates part programs (measurement procedure programs) using CAD data.

## Inspection: MSURF-I

### CAD data import

- SAT and STEP format are supported as standard.
- As an option, CATIA V4, CATIA V5, Creo, Unigraphics/NX, IGES, VDAFS, Parasolid, and Solidworks are available.

### Comparison by features

- MSURF-I can detect various features from point cloud or mesh data and compare with nominal data. It also can calculate distances between features that have point data such as circle elements.
- Detectable features include basic plane, point, straight line, circle, slot, cylinder, cone, sphere, etc., and also weld bolt, weld nut, cylindrical pin, T-shaped stud and more.

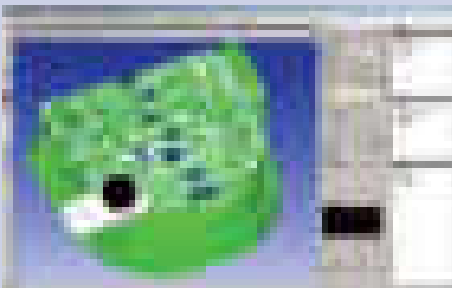
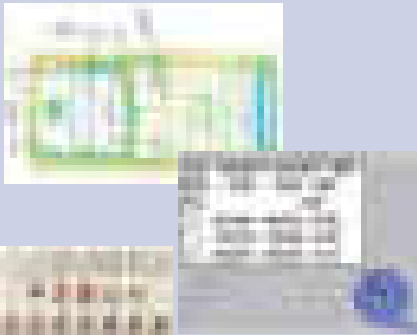

### Comparison of cross-sectional shape

- Cut of a point cloud, mesh data or master data allows for comparison of cross-sectional shapes and calculation of angle, distance, radius of curvature and more.
- The turbine blade analysis function enables calculation of LE thickness, TE thickness, maximum thickness, cord length, etc.



Section evaluation (dimensional calculation)



Turbine blade analysis (optional function)

### Comparison of plane shape

- The plane shape error will be displayed on a color map by comparing a point cloud or mesh data with CAD data.
- Thickness can be displayed on a color map, therefore, it is not necessary to cut a real workpiece.
- Capability of defining the shape of digital calipers enables evaluation of various types of uneven gaps.
- The evaluation of surface curvature can be used for evaluating an angle R within a specified dimensional tolerance.

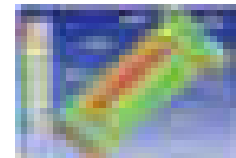

Error color map



Thickness color map



Evaluation of step/clearance



Surface curvature evaluation

### Creation of operating procedure macro by automation function

- The automation function allows users to record the operating procedure including execution of a measurement macro.
- A series of operations from measurement to evaluation and report can be automated.

### Off-line teaching: MSURF-G

MSURF-G allows users to create measurement macros using model data. Therefore, users can start measurement immediately when a real workpiece is available. MSURF-G can improve the operating rate of your measuring instrument. Combining it with MSURF-I can reduce the man-hours from measurement to product evaluation.

- CMM time for creating measurement macros can be reduced.
- Measurement macros are created regardless of operator's skill level.
- The workflow from measurement to evaluation can be optimized.

### MSURF-PLANNER

MSURF-PLANNER software automatically creates measurement macros (surface form, feature form) for the line laser probe from 3D CAD data. Optimized data (travel path, number of probe head revolutions, etc.) of a measurement path contributes to improvements in productivity.

\*MSURF-PLANNER is optional software for MSURF-S and MSURF-G.

# Non-Contact CMM Probe Options

## QVP Quick Vision Probe

### Provides image measuring capability for coordinate measuring machines.

The QVP probe performs form measurement by image processing micro geometry that cannot be measured by a contact-type probe or flexible bodies that are easily deformed by slight measuring forces. Although the method of microscopic measurement with the centering microscope mounted on the coordinate measuring machine has been used since CMMs came into use in the industry, they have an inherent disadvantage in that the operation of identifying positions is dependent on the operator, possibly resulting in measurement errors. Even with a CNC CMM, manual measurement may still need to be performed, such as with an installed centering microscope. The QVP probe is a vision probe for CMMs and was developed based on Mitutoyo's state-of-the-art technology in order to enable full automation of image measurement with a CNC CMM. This technology was originally developed for Mitutoyo vision measuring machines.



Objective ML1X **375-036**  
 Objective ML5X **375-034**  
 Objective ML10X **375-035**



### Automatic detection of workpiece edge

The QVP-captured image will have various automatic edge detections performed by the dedicated software, Visionpak, and then various calculation processes (calculation of dimensions and geometrical deviations) will be performed with the general purpose measurement program, Geopak.

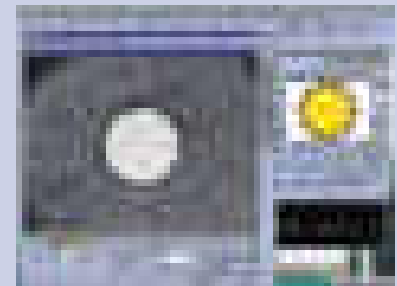

### VISIONPAK

#### Dedicated data processing software

VISIONPAK operates using the Microsoft Windows operating system and is a general purpose measurement program for coordinate measuring machines. It displays the image window when it detects a workpiece edge. After detecting an edge, it undertakes various calculations with regular general purpose measurement programs.

#### Variety of image processing functions

With the powerful image processing functions (tools), it can detect various forms of edges at high speed. It can measure in the height direction by means of its auto-focus function, and save the captured image as the image data (bitmap format).

#### Outlier removal function

In ordinary micro-form measurement it is often difficult to remove burrs and dusts from the objective workpiece, resulting in an inevitable measurement error. In contrast, VISIONPAK can recognize, for example, the obstruction as an outlier and bypass it during measurement.

### Standard provision of white LED illumination

Since the QVP is equipped with the standard co-axial light running through the lens system, as well as white-light LED ring illumination, which is bright and has a long service life, no auxiliary illumination is required. The light volume can be set to between 0 and 100% in 1% increments.



### Mounting on the automatic probe changer

The QVP also can be mounted on an automatic probe changer (ACR3), allowing full-automatic measurement including both the contact and non-contact types in combination with the contact-type probes. QVP requires PH10M, PH10MQ or PH6M probe head.

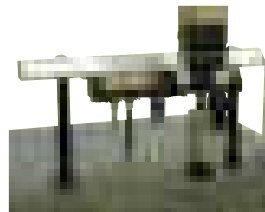

## QVP Specifications

<b>QVP Main Unit</b>	CCD Size	1/3 inch (B/W)			
	Optical tube magnification	0.375x			
	Illuminating function	Co-axial	White light LED source (built-in): Power dissipation 5W or less		
		Ring	White light LED source: Power dissipation 10W or less		
	Mass	Automatic-joint type: 315g, shank type: 390g			
	Optical magnification	0.375x	1.125x	1.875x	3.75x
	Observation range (mm)	9.6x12.8	3.2x4.3	1.9x2.6	1x1.3
	Working distance (mm)	61	72.3	61	51
<b>Objective</b>	Magnification	ML1x	ML3x	ML5x	ML10x
		Optional	Standard	Optional	Optional
	Numerical Aperture N.A.	0.03	0.09	0.13	0.21
	Depth of focus (μm)	306	34	16.3	6.2
	Mass	80g	55g	60g	95g
<b>QVP I/F BOX</b>	Supply voltage	AC100 to 240V			
	Frequency	50/60Hz			
	Power capacity	45W			
	Mass	3800g			

### Standard-type detector

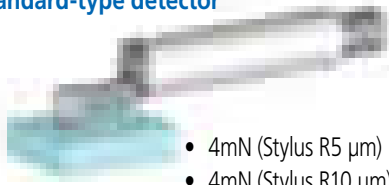

- 4mN (Stylus R5  $\mu\text{m}$ )
- 4mN (Stylus R10  $\mu\text{m}$ )

### Small hole detector

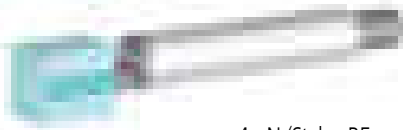

- 4mN (Stylus R5  $\mu\text{m}$ )

### Extra-small hole detector



- 4mN (Stylus R5  $\mu\text{m}$ )

### Deep groove detector

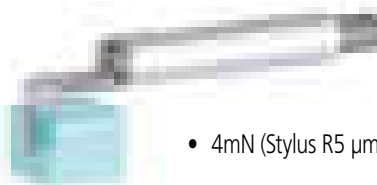

- 4mN (Stylus R5  $\mu\text{m}$ )

### Gear-tooth surface detector

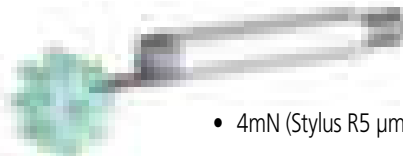

- 4mN (Stylus R5  $\mu\text{m}$ )

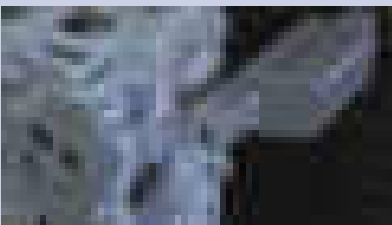
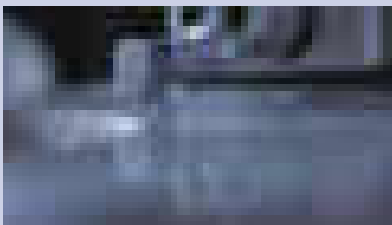

Note: For new purchase of Crysta-AS700 and larger, retrofit of existing Crysta-AS CMM by request.

# CMM Surface Roughness Measuring

## CMM Surftest Probe

**CNC CMMs can be used to measure surface roughness, eliminating workpiece changeover to a second measurement device.**

Mitutoyo has developed a range of surface roughness analysis products from handheld portable units to CNC-type Surftest with broader functions and higher accuracy. By utilizing the technologies developed over the years on surface roughness measuring machines, our coordinate measuring machines can execute surface roughness analysis by implementing a Surftest Probe and the dedicated software. The Surftest probe requires PH10M or PH10MQ probe head.



### FEATURES

- Can be attached to our CNC CMM. (Retro-fitting is possible depending on the model.)
- The auto joint-probe system allows probe changing automatically between scanning (SP25M) and the CMM Surftest surface analysis probe. The measurement and evaluation of size, shape and roughness, is completely automated with auto joint-probe changing.\*
- PH10M(Q) allows surface roughness measurement for features requiring rotation.
- The CMM Surftest Probe is derived from the successful Mitutoyo SJ-210/310 Series of portable surface finish units.

\* Requires ACR3 change rack (OPTION)

### Skid Measurement Specifications

Item		Specifications
<b>Probe (Detector specifications)</b>	Measurement range	AUTO, 25, 100, 360 $\mu\text{m}$
	Driving range	17.5 mm
	Measurement speed	0.25, 0.5, 0.75 mm/s
	Stylus tip radius	2, 5, 10* $\mu\text{m}$ *Standard-type detector only
	Measuring force	4mN (Std) , 0.75mN (Opt.)
<b>Evaluation software</b>	Analysis software	SURFPAK-SP
	Control software	MCOSMOS
	Miscellaneous	Multi-wire autojoint probe head required (PH6M, PH10M, PH10MQ)

### Skidded Measurement

In skidded measurements, surface features are measured with reference to a skid following close behind the stylus. This cannot measure waviness and stepped features exactly, but the range of movement within which measurement can be made is greater because the skid tracks the workpiece surface contour.

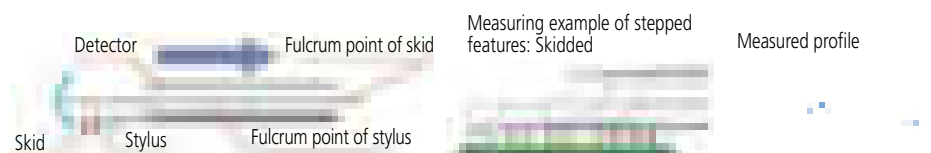

# CMM Probing Accessories

## Mitutoyo Styli Kits

### M2



STARTER - K651376

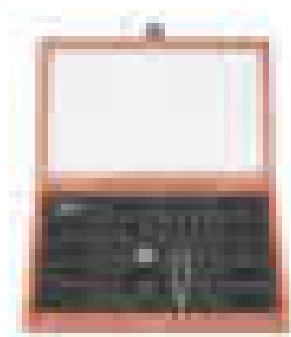

BASIC 1 - K651377



BASIC 2 - K651354

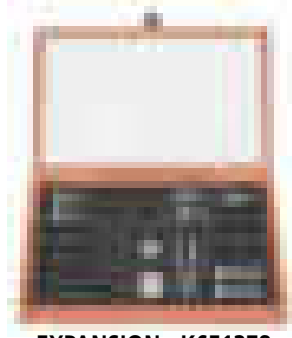

EXPANSION - K651378

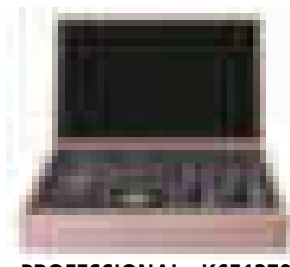

PROFESSIONAL - K651379

### M3

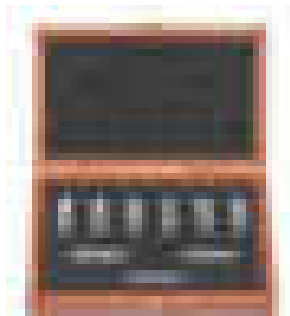

STARTER - K651380

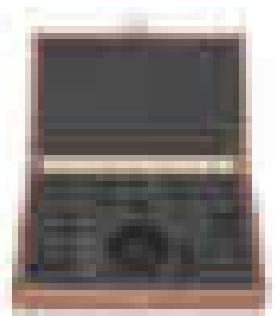

BASIC 1 - K651381

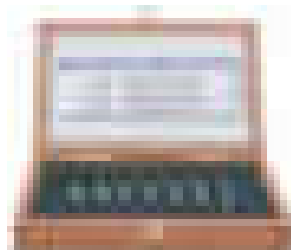

Carbon Fiber 1 - K651318

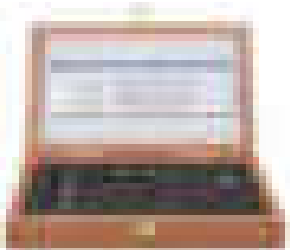

Carbon Fiber 2 - K651319



Carbon Fiber 3 - K651320

## Materials used for spherical probes

### Ruby

As the hardest of all probe element materials, ruby is the perfect all-round material. Spherical probes made of ruby have been used for most standard applications. The low specific density of ruby enables the mass of the stylus tip to be kept as small as possible. This effectively allows the elimination of false triggers caused by mass inertia when the CMM moves.



### Zirconium oxide

Because of the specific surface properties of balls made of zirconium oxide - a ceramic compound - it is ideally suited for aggressive scanning of abrasive surfaces, such as workpieces made of cast iron. Zirconium oxide has virtually the same hardness and wear-resistant properties as ruby.



### Silicon nitride

Silicon nitride is extremely hard and wear-resistant with the lowest surface roughness of all ball materials. Specific advantage: Silicon nitride is resistant to absorbing aluminum from workpiece surfaces.



Locating Pins 1 - K551123



Locating Pins 2 - K551124



Clamping Elements 1 - K551125



Supporting Elements 1 - K551126



Supporting Elements 2 - K551127



Straight Pins - K551128



Receiver Brackets 1 - K551129



Receiver Brackets 2 - K551130



Magnet 1 - K551131



Joints 1 - K551132



# CMM Accessories

## Mitutoyo ECO-FIX Kit Fixture Systems

The Mitutoyo Eco-Fix Clamping System for modular CMM and vision product workholding setups work well for different part sizes/types and environments. The design combines operational modularity advances with lower-cost solutions. This can be found both in the reduction or elimination of hard fixturing costs and setup time. This system is comprised of well-marked, color-coded components designed to simplify part measurement requirements. Magnetic or threaded fastening points deliver fast, plug-and-play connectivity. First-time fixturing jobs can be established and reconfigured in a matter of minutes for quick turnaround for future part measurement. Or, as needed, fixtures can be built and stored to meet all common part measurement requirements. Base plates are hard-coated and other components are machined for durability.

The entry-level Mitutoyo Eco-Fix Kit S version is comprised of a 250mm x 250mm base plate footprint and 59 total components in the system. The Eco-Fix Kit L is a larger version and built for more complex part fixturing applications (measuring 500mm x 400mm in base plate footprint and a total of 98 total components in the system).

Eco-Fix Kit - S K551048



Eco-Fix Kit L - K551049



Eco-Fix MAG S - K551089



Eco-Fix MAG L - K551090

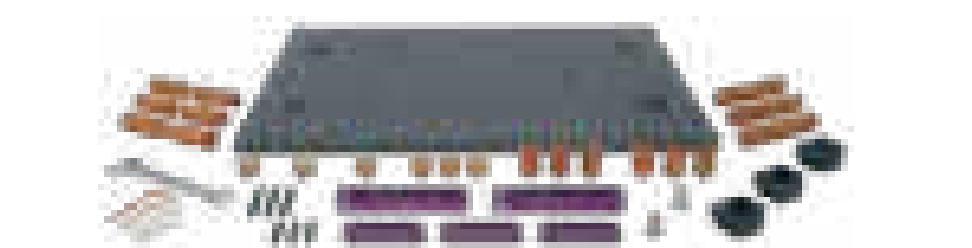

# MITUTOYO CUSTOM SOLUTIONS

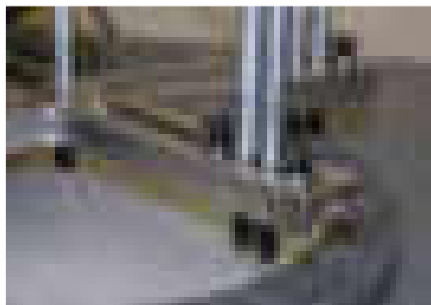
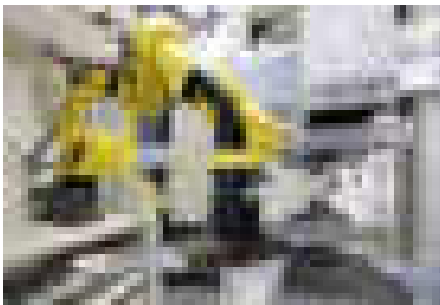

Mitutoyo Custom Solutions helps businesses in a wide range of industries achieve higher quality products, parts and machines with custom precision measurement tools and equipment.

Mitutoyo's highly skilled engineers specialize in designing and building custom measurement systems, applications and software to bring value-added solutions to resolve nearly every measurement need for customers with unique applications.

## Custom Solutions & Services Include:

- Inline/near line part inspection and gaging
- Factory automation
- Data management
- Fixture design/build
- 3D CAD concepts/renderings
- Turnkey capital projects
- Product implementation
- Custom styli/accessories
- "Green button" technology

If you have any questions or would like more information regarding Mitutoyo Custom Solutions, contact: [solutions@mitutoyo.com](mailto:solutions@mitutoyo.com).





### Vision Measuring Systems

#### INDEX

##### Vision Measuring Systems

Quick Scope Series 359 — Manual Vision Measuring System	M-2
Quick Image Series 361 — Non-contact 2D Vision Measuring System	M-3
QV Active Compact CNC Vision Measuring Systems	M-4
QV Apex Series 363 — CNC Vision Measuring System	M-5
QV Stream Plus Series 363 — CNC Vision Measuring System	M-6
QV Hyper Series 363 — High-Accuracy CNC Vision Measuring System	M-7
QV Hybrid Type 1, Type 4 Series 365 — CNC Vision Measuring System with a Non-contact Displacement Sensor	M-8
QV- WLI Series 363 — CNC Video Measuring System with White Light Interferometry	M-9
ULTRA QV Series 363 — Ultra-High Accuracy CNC Vision Measuring System	M-10
UMAP Vision System TYPE2 Series 364 — Micro-Form Measuring System	M-11
QV ACCEL Series 363 — Large-Format CNC Vision Measuring System	M-12
Quick Vision with Touch-Trigger Probe	M-13
Accessories for Quick Vision	M-14
OPTI-FIX Kits — Modular Clamping System for Vision Measuring Systems	M-15-17
Quick Guide to Precision Measuring Instruments	M-18,19



QV Active 202

# Quick Scope

## SERIES 359 — Manual Vision Measuring System

### FEATURES

- Surface, contour and fiber-optic ring light illumination options enable users to configure the QS lighting to meet a variety of measurement needs.
- Powerful, Windows®-based QSPAK software offers a spectrum of measuring and analysis capabilities.
- Functions include auto-focus, measurement playback, one-click edge detection, graphic display, 48 different macros and a pattern matching function for several common part features.
- Excellent surface observation model for a variety of workpieces.
- 0.1µm resolution and 150mm Z-axis range.
- Power zoom enables quick magnification changes.
- Fine illumination capability enables lighting changes to match workpiece requirements.

- The quick release system on the stage enables instant switching between coarse and fine movements.
- Quick Navigation function enables the user to repeat measurements quickly.



### ■ Illumination

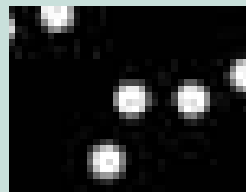

Contour (stage) illumination

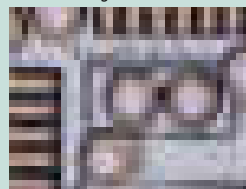

Surface (coaxial) illumination

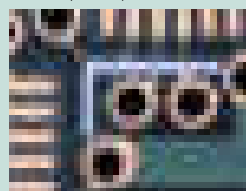

Fiber-optic ring illumination

During automatic measurement the part program provides automatic control over the illumination system, thus providing the necessary balance between user-friendliness and high efficiency.

### SPECIFICATIONS

Model No.	QS-L2010ZB	QS-L3017ZB	QS-L4020ZB
Range (X-axis / Y-axis / Z-axis)	8" x 4" x 6" / 200 x 100 x 150mm	12" x 6.7" x 6" / 300 x 170 x 150mm	15.7" x 8" x 6" / 400 x 200 x 150mm
Resolution	0.1µm		
Scale type	Linear encoder		
Measuring accuracy (at 20°C and 3.0x magnification)	XY: (2.5+20L/1000)µm Z: (5+40L/1000)µm		
Image detecting unit	1/2" 3 MP Color CMOS camera		
Illumination (Halogen)	Co-axial light, fiber-optic ring light, stage light		
Stage glass size	9.84 x 5.91" (250 x 150 mm)	14.57 x 9.45" (370 x 240 mm)	17.32 x 9.45" (440 x 240 mm)
Max. workpiece height	6" / 150mm		
Max. stage loading	22 lbs / 10 kg	44 lbs / 20 kg	33 lbs / 15 kg
Dimensions (W x D x H)	25" x 30" x 28" / 624 x 769 x 722 mm	27" x 33" x 36" / 682 x 837 x 916 mm	30" x 33" x 37" / 757 x 837 x 930 mm
Mass (main unit)	158.7 lbs / 72 kg	308.6 lbs / 140 kg	321.9 lbs / 146 kg

### ■ System diagram

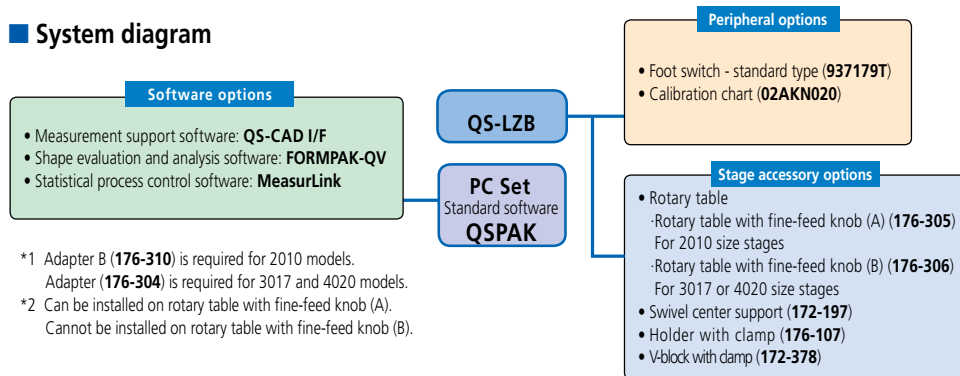

- \*1 Adapter B (**176-310**) is required for 2010 models.  
Adapter (**176-304**) is required for 3017 and 4020 models.
- \*2 Can be installed on rotary table with fine-feed knob (A).  
Cannot be installed on rotary table with fine-feed knob (B).

### ■ Control Box

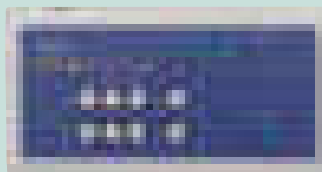

For QS-LZB

### ■ Optical system magnification ratios available for QS-LZB

Total magnification Field of View (mm)	29X 8.8x6.6	38X 6.8x5.1	49X 5.2x3.9	58X 4.4x3.3	87X 2.9x2.2	116X 2.2x1.6	145X 1.7x1.3	202X 1.2x0.9
<b>QS-LZB</b>	0.75X	0.98X	1.28X	1.5X	2.25X	3X	3.75X	5.25X
Working distance (mm)	55							

\* Total magnification shown in the above table is a reference value displayed in the default window state when using 22-inch LCD.

# Quick Image

## SERIES 361 — Non-contact 2-D Vision Measuring System

### Double-telecentric optics enable efficient measurement with a wide field of view

Batch measurement with a wide field of view 1.259" x 0.945" (32 x 24mm) realized using a 0.2X magnification model can substantially improve measurement efficiency. With a 0.5X magnification model, dimensions of very small workpieces and stepped workpieces easily can be measured.



Actual image acquired with a 0.2X magnification model

Quick Image is a new concept in 2-D vision measuring instruments. It provides unique features for improving measurement efficiency.

### FEATURES

- Long focal depth and wide field of view
- Telecentric optical system
- 3 mega-pixel color CCD camera
- Large quadrant LED ring light
- Single-click measurement execution
- Displays measurement results on video window
- Orientation of part is automatically detected



QI-A2010D



QI-C2010D

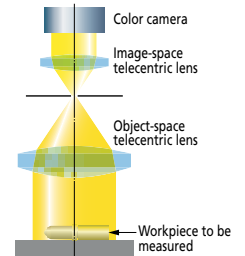

### SPECIFICATIONS

		Manual stage model					Motorized stage model		
0.2X	Model	QI-A1010D	QI-A2010D	QI-A2017D	QI-A3017D	QI-A4020D	QI-C2010D	QI-C2017D	QI-C3017D
0.5X	Model	QI-B1010D	QI-B2010D	QI-B2017D	QI-B3017D	QI-B4020D			
Measuring range (XxY)		3.94" x 3.94" 100x100mm	7.87" x 3.94" 200x100mm	7.87" x 6.69" 200x170mm	11.8" x 6.69" 300x170mm	15.7" x 7.87" 400x200mm	7.87" x 3.94" 200x100mm	7.87" x 6.69" 200x170mm	11.8" x 6.69" 300x170mm
Effective stage glass size		6.69" x 6.69" 170x170mm	9.53" x 5.51" 242x140mm	10.2" x 9.06" 260x230mm	14.2" x 9.06" 360x230mm	17.3" x 9.13" 440x232mm	9.53" x 5.51" 242x140mm	10.2" x 9.06" 260x230mm	14.2" x 9.06" 360x230mm
Maximum stage loading *1		Approx. 22 lbs.(10kg)		Approx. 44 lbs.(20kg)		Approx. 33 lbs. (15kg)	Approx. 22 lbs. (10kg)	Approx. 44 lbs.(20kg)	
Main unit mass		Approx. 143 lbs. 65kg	Approx. 152 lbs. 69kg	Approx. 330 lbs. 150kg	Approx. 348 lbs. 158kg	Approx. 361 lbs. 164kg	Approx. 158 lbs. 72kg	Approx. 337 lbs. 153kg	Approx. 354 lbs. 161kg

\*1 Does not include extremely offset or concentrated loads

		QI-A / QI-C		QI-B	
View field		1.26" x 0.94" (32x24mm)		0.50" x 0.378" (12.8x9.6mm)	
Measurement mode		High resolution mode / Normal mode *4			
Travel range (Z axis)		3.94"(100mm)			
Accuracy	Measurement accuracy within the screen *1	High resolution mode	±2μm		±1.5μm
		Normal mode	±4μm		±3μm
	Repeatability within the screen (±2σ) *2	High resolution mode	±1μm		±0.7μm
		Normal mode	±2μm		±1μm
Measurement accuracy (E1xy) *1		±(3.5+0.02)μm L: arbitrary measuring length (mm)			
Monitor magnification *3		7.6X		18.9X	
Optical system	Magnification (Telecentric Optical System)		0.2X		0.5X
	Depth of focus	High resolution mode	±0.6mm		±0.6mm
		Normal mode	±11mm		±1.8mm
Working distance		3.54"(90mm)			
Camera		3 million pixels, 1/2", full color			
Illumination		Transmitted light: Green LED telecentric illumination Co-axial light: White LED Ring light: 4-quadrant white LED			
Power supply		100-240VAC 50/60Hz			
Accuracy guaranteed temperature range		19-21°C			

\*1 Inspected to Mitutoyo standards by focus point position.

\*2 The measuring accuracy is guaranteed to be accurate within the depth of focus.

\*3 For 1X digital zoom (when using the 22-inch-wide monitor)

\*4 Patent registered (Japan)

**Mitutoyo**

# QV Active

## Compact CNC Vision Measuring Systems

### FEATURES

- High-quality zoom optics with interchangeable lenses
- High-resolution and high-speed color camera
- Compact design saves significant space—available in two sizes
- Powerful QVPAK 3D vision software
- Contact and noncontact measurement
- Touch-probe retrofittable
- Programmable LED stage, coaxial and 4-quadrant ring light



1X, 1.5X and 2X interchangeable lens



QV Active 202

Optical magnification	0.5X	0.65X	0.75X	0.85X	0.98X	1X	1.28X	1.3X	1.5X	1.7X	2X	2.25X	2.5X	3X	3.5X	3.75X	4X	5X	5.25X	7X	
View field Horizontal (H) (mm)	13.60	10.46	9.07	8.00	6.94	6.80	5.31	5.23	4.53	4.00	3.40	3.02	2.72	2.27	1.94	1.81	1.70	1.36	1.30	0.97	
View field Vertical (V) (mm)	10.80	8.31	7.20	6.35	5.51	5.40	4.22	4.15	3.60	3.18	2.70	2.40	2.16	1.80	1.54	1.44	1.35	1.08	1.03	0.77	
Objective 1X Working distance																					
Objective 1.5X Working distance																					
Objective 2X Working distance																					

### SPECIFICATIONS

Name	Quick Vision Active	
Model No.	QV Active 202 / QV Active 202 TP	QV Active 404 / QV Active 404 TP
Range (X,Y,Z-axis) with vision head	9.84" x 7.87" x 5.91" 250 x 200 x 150 mm	15.75" x 15.75" x 7.87" 400 x 400 x 200 mm
Resolution	0.1 μm	
Accuracy (μm)*	$E_{1(X,Y)} = (2+3L/1000)$ $E_{1(Z)} = (3+5L/1000)$ $E_{2(X,Y)} = (2.5+4L/1000)$	
Max. stage loading	22 lbs. (10 kg)	44 lbs. (20 kg)
Mass	265 lbs. (120 kg)	606 lbs. (275 kg)
Illumination	(White LED) Contour / Coaxial / 4-quadrant ring light	
Magnification change system	Zoom optical system with 8 positions (Standard 1.5X magnification lens)	
Sensor type	High-resolution CMOS color camera	
Optional objective lenses	1X and 2X magnification	
Factory option	Series 364 (TP) Touch-Probe option (Page M-13)	

\* L is arbitrary length in mm

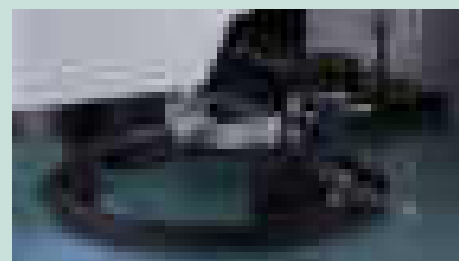

### Touch-Probe System

The QV touch-probe system is available on all the models. All touch-probe systems include probes, modules, calibration articles and installed software. (See page M-13)

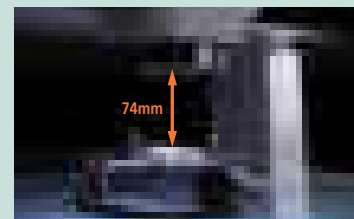

Long working distance 74mm  
\*when using Z-objective 1X

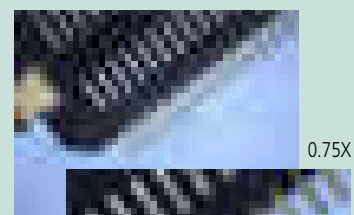

0.75X

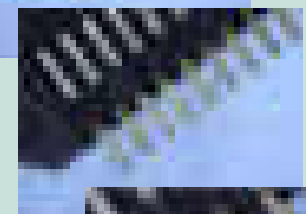

1.28X

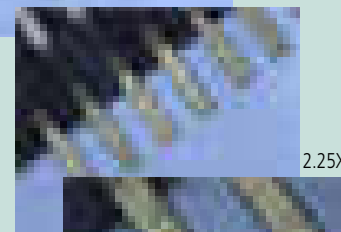

2.25X

8 steps high speed zoom



5.25X

## Image Multi-AutoFocus

The optimal focus can be selected for each surface texture and measured feature, realizing high reproducibility and reliable edge detection.

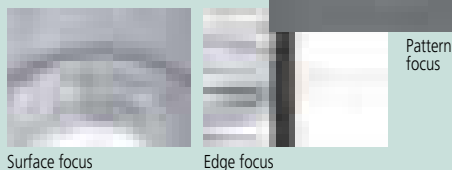

## Programmable Ring Light (PRL)

Fine control of obliquity and direction provides illumination optimal for measurement. Obliquity can be arbitrarily set in the range from 30° to 80°. This type of illumination is effective for enhancing the edge of inclined surfaces or very small steps. Illumination can be controlled independently in every direction, front and back, right and left. Measurement with edge enhancement is possible by forming a shadow with lighting from only one direction.

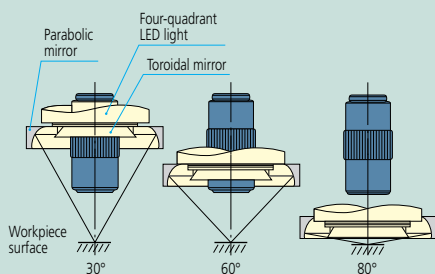

## Tracking Auto Focus (TAF)

The TAF feature focuses continuously, adjusting to changes in the height of the object being measured. Automatic tracking of surface waves and warpage (in the Z axis height direction) improves measurement throughput. The feature also eliminates the hassle of focusing during manual measurement.

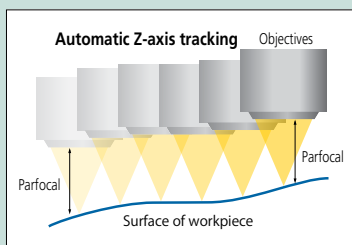

### Tracking Auto Focus (TAF)

AF principle	Objective coaxial autofocusing (knife-edge method)				
Suitable objectives	QV-HR1x	QV-SL1x	QV-HR2.5x	QV-SL2.5x	QV-5x
Tracking range*2	6.3mm (±3.15mm)	6.3mm (±3.15mm)	1mm (±0.5 mm)	1mm (±0.5 mm)	0.25mm (±0.125mm)
Spot diameter*3	5.2µm	8.0µm	2.1µm	3.1µm	1.5µm
Laser source	Semiconductor laser (peak wavelength: 690nm)				
Laser power	0.9mW				
Laser safety	Class 2 (JIS C6802:2011, EN/IEC 60825-1:2007)				

\*2 Varies according to workpiece surface texture and reflectance.

\*3 These are design values.

**Optional Accessories: Refer to page M-14.**

# QV Apex

## SERIES 363 — CNC Vision Measuring System



QV Apex 302 PRO

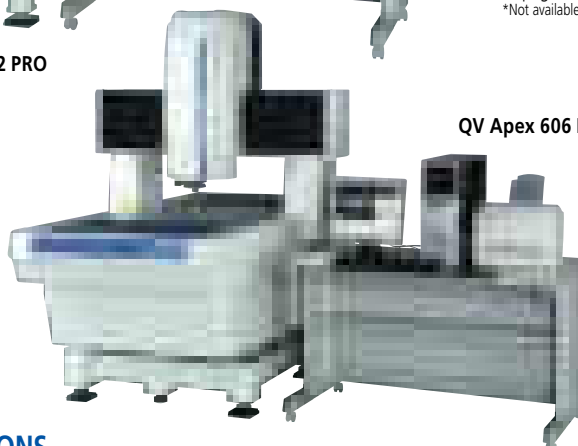

QV Apex 606 PRO

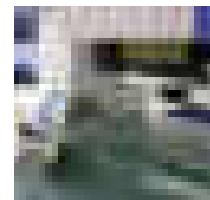

### Optional Index Table\*

Automatic multi-plane measurement is possible with the optional index table. Refer to page M-14 for more details.  
\*Not available with QV ACCELL models

## SPECIFICATIONS

Name	Quick Vision Apex			
	QV Apex 302 PRO	QV Apex 404 PRO	QV Apex 606 PRO	
	QV Apex 302 (ISO10360-7)	QV Apex 404 (ISO10360-7)	QV Apex 606 (ISO10360-7)	
Model No.	QV Apex 302 (w/TAF)	QV Apex 404 (w/TAF)	QV Apex 606 (w/TAF)	
Measuring Range	X-axis	11.81" / 300mm	15.75" / 400mm	23.62" / 600mm
	Y-Axis	7.87" / 200mm	15.75" / 400mm	25.59" / 650mm
	Z-Axis	7.87" / 200mm	9.84" / 250mm	9.84" / 250mm
Resolution / Scale Unit	0.1µm / Reflective-type Linear Encoder			
Resolution Z Scale Using Tracking Autofocus (TAF)	0.3 µm			
Laser Auto Focus repeatability $\sigma \leq$	0.8 µm			
CCD camera	B & W			
Illumination Unit (LED)	Surface	White LED		
	Contour	White LED		
	Programmable Ring Light	White LED		
Max. Drive Speed	X/Y Axis	300 mm/s	400 mm/s	
	Z-Axis	300 mm/s	300 mm/s	
Measuring Accuracy*	$E_{IX}, E_{IY}$	(1.5+3L/1000)µm		
	$E_{IZ}$	(1.5+4L/1000)µm		
	$E_{2XY}$	(2+4L/1000)µm		
	$E_{U,MPE}$ (ISO10360-7:2011)	3+5.5L/1000, 3+6L/1000**		
	$P_{F2D,MPE}$ (ISO10360-7:2011)	2.3µm		
Magnification Change System	Programmable Power Turret (1x, 2x, 6x)			
Stage Glass Size	15.71" x 10.67" (399 x 271mm)	19.41" x 21.69" (493 x 551mm)	27.44" x 29.84" (697 x 758mm)	
Maximum Stage Loading	44 lbs. (20kg)	88 lbs. (40kg)	110 lbs. (50kg)	
Dimensions of Main Unit	37.44" x 33.82" x 41.06" (951 x 859 x 1043mm)	55.39" x 40.43" x 54.37" (1407 x 1027 x 1381mm)	78.15" x 51.54" x 61.81" (1985 x 1309 x 1570mm)	
Mass of Main Unit (Including Machine Stand)	794 lbs. (360kg)	1276 lbs. (579kg)	3197 lbs. (1450kg)	

\*The measuring accuracy defined under the following conditions:

Programmable Power Turret: 2x Position; Objective Lens: 2.5x (HR or SL); L=Dimension between two arbitrary points (mm)

\*\*Accuracy 3.5+5.5L/1000 for 20 ± 2°C, Accuracy 3+6L/1000 from 18 to 23°C

# QV Stream Plus

## SERIES 363 — CNC Vision Measuring System



QV Stream Plus 606 PRO

### STREAM MODE

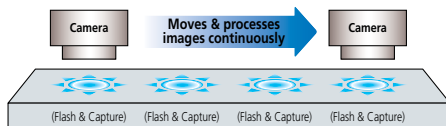

### High-density mounting of ultra-high intensity LED elements

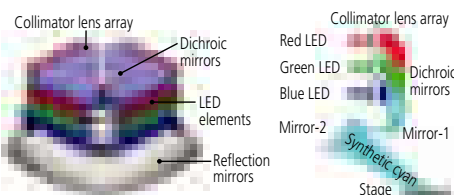

## SPECIFICATIONS

Name		Quick Vision Stream Plus		
Model No.		QV Stream Plus 302 PRO	QV Stream Plus 404 PRO	QV Stream Plus 606 PRO
		QV Stream Plus 302 (w/TAF)	QV Stream Plus 404 (w/TAF)	QV Stream Plus 606 (w/TAF)
Measuring Range	X-axis	11.81" / 300mm	15.75" / 400mm	23.62" / 600mm
	Y-axis	7.87" / 200mm	15.75" / 400mm	25.59" / 650mm
	Z-axis	7.87" / 200mm	9.84" / 250mm	9.84" / 250mm
Resolution / Scale Unit		0.1 μm / Reflective-type Linear Encoder		
Resolution Z Scale Using Tracking Autofocus (TAF)		0.3 μm		
Laser Auto Focus repeatability $\sigma \leq$		0.8 μm		
CCD camera		B & W, Progressive Scanning CCD		
Illumination Unit (C: Continuous; S: Stroboscopic; PRL: Programmable Ring Light)	Surface (C)	Red, Green, Blue & White (LED)		
	Surface (S)	Blue (LED)		
	Contour (C)	Blue (LED)		
	Contour (S)	Blue (LED)		
	PRL (C)	Red, Green, Blue & White (LED)		
	PRL (S)	Blue (LED)		
Max. Drive Speed		X/Y/Z Axis 300 mm/s		
Measuring Accuracy*	$E_{1X}, E_{1Y}$	(1.5+3L/1000) μm		
	$E_{1Z}$	(1.5+4L/1000) μm		
	$E_{2XY}$	(2+4L/1000) μm		
Magnification Change System		Programmable Power Turret (1x, 2x, 6x)		
Stage Glass Size		15.71" x 10.67" (399 x 271mm)	19.41" x 21.69" (493 x 551mm)	27.44" x 29.84" (697 x 758mm)
Maximum Stage Loading		44 lbs. (20kg)	88 lbs. (40kg)	110 lbs. (50kg)
Dimensions of Main Unit		37.44" x 33.82" x 41.06" (951 x 859 x 1043mm)	55.39" x 40.43" x 54.37" (1407 x 1027 x 1381mm)	78.15" x 51.54" x 61.81" (1985 x 1309 x 1570mm)
Mass of Main Unit (Including Machine Stand)		794lbs. (360kg)	1276 lbs. (579kg)	3197 lbs. (1450kg)

\*The measuring accuracy defined under the following conditions:  
Programmable Power Turret: 2x Position; Objective Lens: 2.5x (HR or SL); L=Dimension between two arbitrary points (mm)

## FEATURES



### Non-stop Vision Measurement Extreme Improvement in Throughput\*

Conventional vision measuring systems endlessly repeat the cycle of stage displacement, stage stop, measurement, stage start and stage displacement. This mode of operation is a fundamental limitation on improving measurement throughput.

In contrast, the Quick Vision Stream system uses an innovative image capture technique that avoids the need to repeatedly stop the stage, thereby allowing for continuous measurement while still maintaining accuracy.

### Measurement Throughput Comparison between QV STREAM and the Conventional System

STREAM PLUS series: more than 5 times faster

\* Comparison of measurement throughput using a Mitutoyo sample workpiece with that of conventional Mitutoyo systems.

### Newly Developed Stroboscopic Illumination System

The development of a high-intensity LED flash illuminator makes non-stop vision measurement possible. At the precise moment the stage reaches a measurement point, the illuminator creates an extremely short, high-intensity flash that effectively freezes all motion. The illuminator turns on and off so quickly that no image blur occurs, and the image is captured in full and accurate detail.

This innovative design takes full advantage of high-density, high-intensity LED arrays aided by collimating lenses and dichroic mirrors to produce ultra bright, directional and efficient illumination.

### Tracking Auto Focus (TAF)

The TAF feature continuously focuses, adjusting to changes in the height of the object being measured. Automatic tracking of surface waves and warpage (in the Z axis height direction) improves measurement throughput. The feature also cuts out the hassle of focusing during manual measurement, reducing the work burden for measuring system operators.

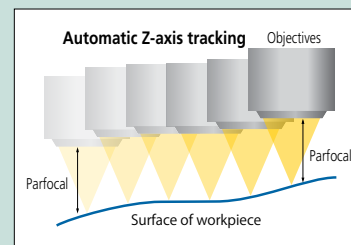

### Tracking Auto Focus (TAF)

AF principle	Objective coaxial autofocus (knife-edge method)				
Suitable objectives	QV-HR1x	QV-SL1x	QV-HR2.5x	QV-SL2.5x	QV-5x
Tracking range*2	6.3mm (±3.15mm)	6.3mm (±3.15mm)	1mm (±0.5 mm)	1mm (±0.5 mm)	0.25mm (±0.125mm)
Spot diameter*3	5.2 μm	8.0 μm	2.1 μm	3.1 μm	1.5 μm
Laser source	Semiconductor laser (peak wavelength: 690nm)				
Laser power	0.9mW				
Laser safety	Class 2 (JIS C6802:2011, EN/IEC 60825-1:2007)				

\*2 Varies according to workpiece surface texture and reflectance.

\*3 These are design values.

## Programmable Power Turret (PPT)

The three tube lens selection provides three magnification levels with the same objective lens. Replacement objective lenses allow a wide range of magnifications to support a variety of measurements.



1X tube lens x 2.5X objective  
View field: 2.5 x 1.88 mm



2X tube lens x 2.5X objective  
View field: 1.25 x 0.94 mm



6X tube lens x 2.5X objective  
View field: 0.41 x 0.31 mm

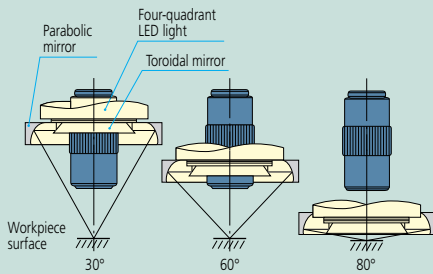

## Programmable Ring Light (PRL)

Fine control of obliquity and direction provides illumination optimal for measurement. Obliquity can be arbitrarily set in the range from 30° to 80°. This type of illumination is effective for enhancing the edge of inclined surfaces or very small steps. Illumination can be controlled independently in every direction, front and back, right and left. Measurement with edge enhancement is possible by forming a shadow by lighting from only one direction.

# QV Hyper

## SERIES 363 — High-accuracy CNC Vision Measuring System

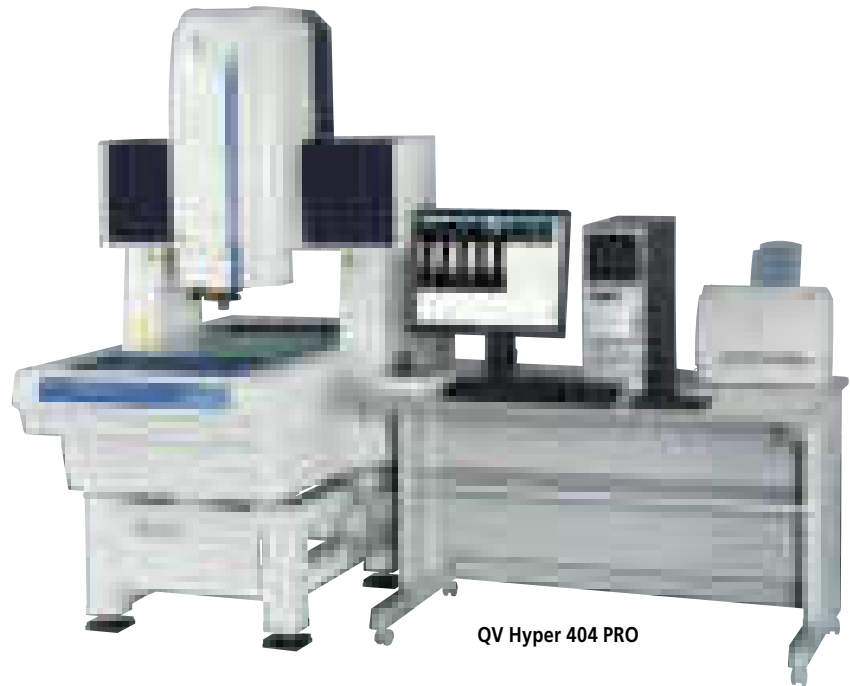

QV Hyper 404 PRO

## SPECIFICATIONS

Name		Quick Vision Hyper		
		QV Hyper 302 PRO	QV Hyper 404 PRO	QV Hyper 606 PRO
Model No.		QV Hyper 302 (ISO10360-7)	QV Hyper 404 (ISO10360-7)	QV Hyper 606 (ISO10360-7)
		QV Hyper 302 (w/TAF)	QV Hyper 404 (w/TAF)	QV Hyper 606 (w/TAF)
Measuring Range	X-axis	11.81" / 300mm	15.75" / 400mm	23.62" / 600mm
	Y-Axis	7.87" / 200mm	15.75" / 400mm	25.59" / 650mm
	Z-Axis	7.87" / 200mm	9.84" / 250mm	9.84" / 250mm
Resolution / Scale Unit		0.02μm / Reflective-type Linear Encoder		
Resolution Z Scale using Tracking Autofocus (TAF)		0.26 μm		
Laser Auto Focus repeatability $\sigma \leq$		0.8 μm		
CCD Camera		B & W		
Illumination Unit (LED)	Surface	White LED		
	Contour	White LED		
	Programmable Ring Light	White LED		
Max. Drive Speed	XYZ-Axis	200mm/s		
Measuring Accuracy*	$E_{1X}, E_{1Y}$	(0.8+2L/1000)μm		
	$E_{1Z}$	(1.5+2L/1000)μm		
	$E_{2XY}$	(1.4+3L/1000)μm		
	$E_{U,MPE}$ (ISO10360-7:2011)	2.5+4L/1000, 2.5+4.5L/1000**		
	$P_{F2D,MPE}$ (ISO10360-7:2011)	1.7μm		
Magnification Change System		Programmable Power Turret (1x, 2x, 6x)		
Stage Glass Size		15.71" x 10.67" (399 x 271mm)	19.41" x 21.69" (493 x 551mm)	27.44" x 29.84" (697 x 758mm)
Maximum Stage Loading		44 lbs. (20kg)	88 lbs. (40kg)	110 lbs. (50kg)
Dimensions of Main Unit		37.44" x 33.82" x 41.06" (951 x 859 x 1043mm)	55.39" x 40.43" x 54.37" (1407 x 1027 x 1381mm)	78.15" x 51.54" x 61.81" (1985 x 1309 x 1570mm)
Mass of Main Unit (Including Machine Stand)		794 lbs. (360kg)	1276 lbs. (579kg)	3197 lbs. (1450kg)

\*The measuring accuracy defined under the following conditions:

Programmable Power Turret: 2x Position; Objective Lens: 2.5x (HR or SL); L=Dimension between two arbitrary points (mm)

\*\*Accuracy 2.5+4L/1000 for 20 ± 2°C, Accuracy 2.5+4.5L/1000 from 18 to 23°C

# QV Hybrid Type 1, Type 4

## SERIES 365 — CNC Vision Measuring System with Non-contact Displacement Sensor

### FEATURES

The Quick Vision Hybrid is an advanced machine that allows vision measurement with both a CCD camera and high-speed scanning by applying a vision measurement unit in parallel with a non-contact displacement sensor.

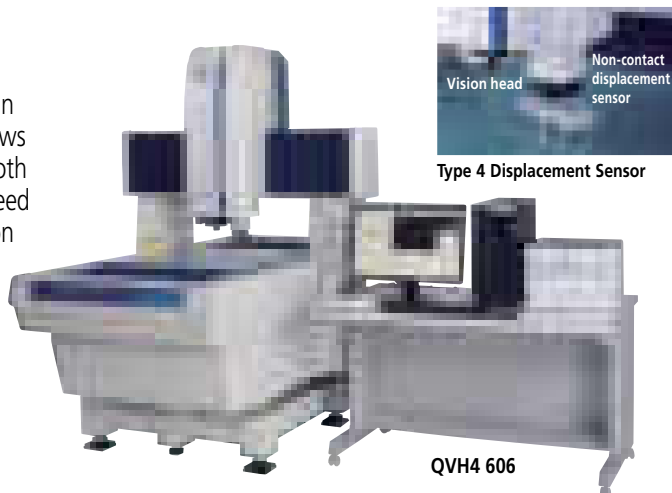

Type 4 Displacement Sensor

QVH 606

### FEATURES: Hybrid Type 1

- The focusing point method minimizes the difference in the measuring face reflectance and realizes high measurement reproducibility.
- The double pinhole method (less directivity) is employed as the measurement principle.



Laser head  
Vision head

CLASS 1 LASER PRODUCT

### Safety precautions regarding laser autofocus system (factory-installed option)

This product uses a low-power visible laser (690nm) for measurement. The laser is a CLASS 1 EN/IEC60825-1 (2007) device. A warning and explanation label, as shown above, is attached to the product as appropriate.

### SPECIFICATIONS

Name		Quick Vision Hybrid 302		Quick Vision Hybrid 404		Quick Vision Hybrid 606			
Model No.		QVH Apex 302 (ISO10360-7)	QV Hyper 302 (ISO10360-7)	QVH Apex 404 (ISO10360-7)	QV Hyper 404 (ISO10360-7)	QVH Apex 606 (ISO10360-7)	QV Hyper 606 (ISO10360-7)		
		QVH STREAM 302		QVH STREAM 404		QVH STREAM 606			
Measuring Range (XxYxZ)	Vision	11.81" x 7.87" x 7.87" (300x200x200mm)		15.75" x 15.75" x 9.84" (400x400x250mm)		23.62" x 25.59" x 9.84" (600x650x250mm)			
	Non-contact Displacement Sensor	TYPE1	7.09" x 7.87" x 7.87" (180x200x200mm)		11.02" x 15.75" x 9.84" (280x400x250mm)		18.90" x 25.59" x 9.84" (480x650x250mm)		
		TYPE4*1	6.92" x 7.87" x 7.87" (176x200x200mm)		10.87" x 15.75" x 9.84" (276x400x250mm)		18.74" x 25.59" x 9.84" (476x650x250mm)		
Measuring Accuracy	(Vision) <sup>2*3</sup>	E1X, E1Y	(1.5+3L/1000) $\mu$ m	(0.8+2L/1000) $\mu$ m	(1.5+3L/1000) $\mu$ m	(0.8+2L/1000) $\mu$ m	(1.5+3L/1000) $\mu$ m	(0.8+2L/1000) $\mu$ m	
		E1Z	(1.5+4L/1000) $\mu$ m	(1.5+2L/1000) $\mu$ m	(1.5+4L/1000) $\mu$ m	(1.5+2L/1000) $\mu$ m	(1.5+4L/1000) $\mu$ m	(1.5+2L/1000) $\mu$ m	
		E2XY	(2.0+4L/1000) $\mu$ m	(1.4+3L/1000) $\mu$ m	(2.0+4L/1000) $\mu$ m	(1.4+3L/1000) $\mu$ m	(2.0+4L/1000) $\mu$ m	(1.4+3L/1000) $\mu$ m	
	(Displacement Sensor) <sup>2*3</sup>	E1Z	(1.5+4L/1000) $\mu$ m	(1.5+2L/1000) $\mu$ m	(1.5+4L/1000) $\mu$ m	(1.5+2L/1000) $\mu$ m	(1.5+4L/1000) $\mu$ m	(1.5+2L/1000) $\mu$ m	
		(ISO10360-7:2011)	E <sub>L,MPE</sub>	3+5.5L/1000 <sup>4</sup> 3+6.0L/1000 <sup>5</sup>	2.5+4L/1000 <sup>4</sup> 2.5+4.5L/1000 <sup>5</sup>	3+5.5L/1000 <sup>4</sup> 3+6.0L/1000 <sup>5</sup>	2.5+4L/1000 <sup>4</sup> 2.5+4.5L/1000 <sup>5</sup>	3+5.5L/1000 <sup>4</sup> 3+6.0L/1000 <sup>5</sup>	2.5+4L/1000 <sup>4</sup> 2.5+4.5L/1000 <sup>5</sup>
			P <sub>F2D,MPE</sub>	2.3 $\mu$ m	1.7 $\mu$ m	2.3 $\mu$ m	1.7 $\mu$ m	2.3 $\mu$ m	1.7 $\mu$ m
Scale Resolution		0.1 $\mu$ m	0.02 $\mu$ m	0.1 $\mu$ m	0.02 $\mu$ m	0.1 $\mu$ m	0.02 $\mu$ m		
Max. Drive Speed	XYZ Axis	300 mm/s	200 mm/s	300 mm/s	200 mm/s	300 mm/s	200 mm/s		
Stage Glass Size		15.71" x 10.67" (399 x 271mm)		19.41" x 10.67" (493 x 551mm)		27.44" x 29.84" (697 x 758mm)			
Maximum Stage Loading		44 lbs. (20kg)		88 lbs. (40kg)		110 lbs. (50kg)			
Dimensions of Main Unit		37.44" x 33.82" x 41.06" (951 x 859 x 1043mm)		55.39" x 40.43" x 54.37" (1407 x 1027 x 1381mm)		78.15" x 51.54" x 61.81" (1985 x 1309 x 1570mm)			
Mass of Main Unit (Including Machine Stand)		794 lbs. (360kg)		1276 lbs. (579kg)		3197 lbs. (1450kg)			

Name		Quick Vision ACCEL			
Model No.		QVH ACCEL808	QVH ACCEL 1010	QVH ACCEL 1212	QVH ACCEL 1517
Measuring Range (XxYxZ)	Vision	31.50x31.50x5.91" (800x800x150mm)	39.37x39.37x5.91" (1000x1000x150mm)	49.21x49.21x3.94" (1250x1250x100mm)	59.06x68.90x3.94" (1500x1750x100mm)
	Non-contact Displacement Sensor	TYPE1	26.77x31.50x5.91" (680x800x150mm)	34.65x39.37x5.91" (880x1000x150mm)	44.49x49.21x3.94" (1130x1250x100mm)
Measuring Accuracy	(Vision) <sup>2*3</sup>	E1X, E1Y	(1.5+3L/1000) $\mu$ m		(2.2+3L/1000) $\mu$ m
		E1Z	(1.5+4L/1000) $\mu$ m		(2.5+5L/1000) $\mu$ m
		E2XY	(2.5+4L/1000) $\mu$ m		(3.5+4L/1000) $\mu$ m
	(Displacement Sensor) <sup>2*3</sup>	E1Z	(2.5+4L/1000) $\mu$ m		(3.5+5L/1000) $\mu$ m
Scale Resolution		0.1 $\mu$ m			
Max. Drive Speed	XY Axis	400 mm/s		300 mm/s	
	Z Axis	150 mm/s		150 mm/s	
Stage Glass Size		34.76" x 37.72" (883x958mm)	46.69" x 46.69" (1186x1186mm)	56.69" x 56.69" (1440x1440mm)	67.48" x 77.48" (1714x1968mm)
Maximum Stage Loading		22 lbs. (10kg)		66 lbs. (30kg)	
Dimensions of Main Unit		58.07" x 73.23" x 62.13" (1475 x 1860 x 1578mm)	75.28" x 84.29" x 63.11" (1912 x 2141 x 1603mm)	85.28" x 93.31" x 61.18" (2166 x 2370 x 1554mm)	96.06" x 114.09" x 61.18" (2440 x 2898 x 1554mm)
Mass of Main Unit		4519lbs. (2050kg)	6504 lbs. (2950kg)	7937 lbs. (3600kg)	9921 lbs. (4500kg)

\*1 TYPE 4 is not supported by QVH STREAM

\*2 L = arbitrary measuring length (mm)

\*3 Inspected by Mitutoyo standard

\*4 Accuracy for 20 ± 2°C

\*5 Accuracy from 18 to 23°C

### FEATURES: Hybrid Type 4

- Enables detection of high inclination angles for both mirror and diffused surfaces.
- The automatic lighting adjustment function allows for high-accuracy measurements.
- Thickness measurement of thin and transparent objects such as film.

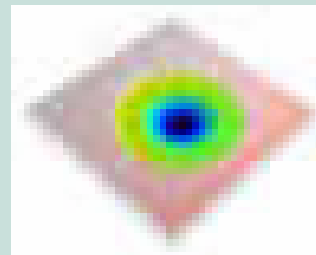

3-dimensional topographical result, data of plastic package by MCubeMAP

Common Specifications	QV Apex	QV Hyper	QV Accel	QV Stream
CCD camera		Black & White		Black & White; Progressive Scanning
Magnification Change System		Programmable Power Turret (1x, 2x, 6x)		
Guide Method		Linear Motion Hard Bearing		
Illumination (Catalog Page Number Reference)	M-5	M-7	M-12	M-6

\* Specification of QVH1 ACCEL



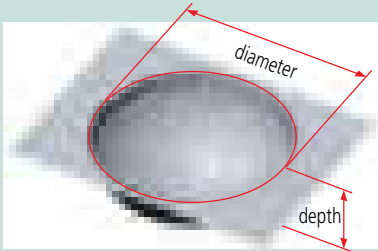

Application view of nano hole

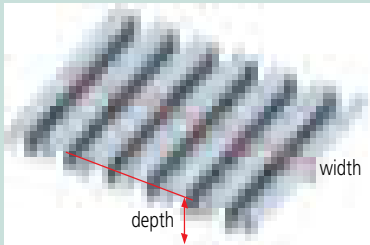

Application view of surface trace



FormTracePak AP

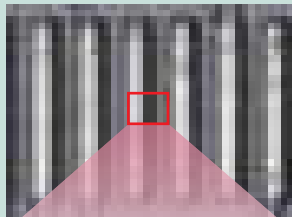

3-dimensional topographical result, data of micro-circuit

# QV WLI

## SERIES 363 — CNC Video Measuring System with White Light Interferometry

- QV WLI can measure coordinates and dimensions and assess micro-3D forms without contact.
- High-accuracy, dual-head vision measuring system equipped with a white light interferometer.
- The white light interferometer uses a high aspect ratio to accurately measure shapes.
- The standard vision measuring function can continuously perform coordinate, dimension and 3D shape measuring.
- Large work stage accurately handles over-sized work pieces such as a PCB.

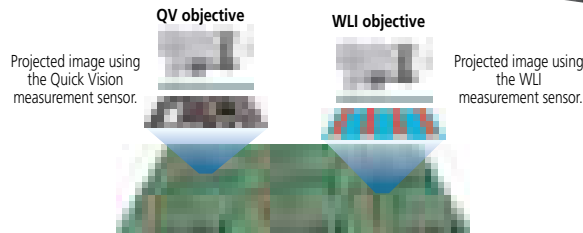

### SPECIFICATIONS

Name	QV Hyper WLI 302	QV Hyper WLI 404	QV Hyper WLI 606
<b>Model No.</b>	<b>QV Hyper WLI 302 (ISO10360-7)</b>	<b>QV Hyper WLI 404 (ISO10360-7)</b>	<b>QV Hyper WLI 606 (ISO10360-7)</b>
Measuring Range (XxYxZ)	Vision Measuring Area	11.81" x 7.87" x 7.48" (300x200x190mm)	15.75" x 15.75" x 9.45" (400x400x240mm)
	WLI Measuring Area*1	8.46" x 7.87" x 7.48" (215x200x190mm)	12.40" x 15.75" x 9.44" (315x400x240mm)
<b>WLI Optical Head Unit</b>			
Field of View (HxV)	5X lens: approx. 0.64x0.48mm / 10X lens: approx. 0.32x0.24mm / 25X lens: approx. 0.13x0.10mm		
Illumination	Co-axial Light	Halogen	
Repeatability	2σ ≤ .08μm		
Z-axis Scanning Range*2	170μm		
<b>Vision Optical Head Unit</b>			
Magnification Change System	Programmable Power Turret (1X-2X-6X)		
Image Detection Method	B&W CCD camera		
Illumination	Co-axial Light	White LED	
	Transmitted Light	White LED	
	Programmable Ring Light	White LED	
Measuring Accuracy	E1X, E1Y	(0.8+2L/1000)μm	
	E1Z	(1.5+2L/1000)μm	
	E2XY	(1.4+3L/1000)μm	
	E <sub>U,MPE</sub> (ISO10360-7:2011)	2.5+4L/1000	
	P <sub>F2D,MPE</sub> (ISO10360-7:2011)	1.7μm	
<b>Main Unit</b>			
Resolution	0.01μm		
Max. Stage Loading	33 lbs. (15kg)	55 lbs. (25kg)	77 lbs. (35kg)
Guidance System	Linear Motion Hard Bearing		
Dimensions (WxDxH)	33.82" x 37.40" x 63.23" (859x950x1606mm)	40.43" x 55.39" x 70.11" (1027x1407x1781mm)	51.54" x 78.15" x 70.55" (1309x1985x1792mm)
Mass (Vibration Isolator Stand Included)	Approx. 1080 lbs. (490kg)	Approx. 2557 lbs. (1160kg)	Approx. 2275 lbs. (1031kg)

\*1: WLI head is moveable. Multiple fields of view can be stitched together.

\*2: In standard mode. Applicable to max. 200μm by modifying scan pitch.

# ULTRA QV

## SERIES 363 — Ultra-high Accuracy CNC Vision Measuring System

### FEATURES

- Minimizes straightness errors through the use of a precision air-bearing linear guide system.
- Utilizes a 0.01µm resolution glass scale manufactured at an ultra-precision facility located 11 meters underground.
- In order to minimize error caused by temperature fluctuations, the linear encoder scale is made of special crystallized glass with an expansion coefficient that is almost zero.
- Optimizes the mechanical structure of the main unit in Finite Element Method analysis.
- Stabilizes the geometrical accuracy (i.e. straightness of each axis and perpendicularity) to lessen thermal effects.



### SPECIFICATIONS

Model No.	ULTRA QV 404 PRO	ULTRA QV 404 PRO w/ TAF
	ULTRA QV 404 PRO (ISO10360-7:2011)	ULTRA QV 404 PRO w/ TAF (ISO10360-7:2011)
Range	X x Y x Z 16" x 16" x 8" (400x400x200mm)	
Magnification Change System	Programmable Power Turret (Selectable from Magnifications of 1X, 2X and 6X)	
Resolution / Scale Unit	0.01µm / Linear Encoder <sup>4</sup>	
Resolution of Z-Scale Using TAF	-	0.25µm
High-sensitivity CCD Camera	B&W	
Illumination (PRL: Programmable Ring Light)	Surface	Halogen
	Contour	Halogen
	PRL	Halogen
Accuracy <sup>*1</sup> (20°C±0.2°C)	E1XY	(0.25+L/1000)µm
	E1Z (50mm Stroke) <sup>*2</sup>	(1.0+2L/1000)µm
	E1Z (Full Stroke)	(1.5+2L/1000)µm
	E2XY Plane	(0.5+2L/1000)µm
	E <sub>UMPE</sub> (ISO10360-7:2011)	1.3+3L/1000, 1.3+3.5L/1000 <sup>*5</sup>
	P <sub>FZD,MPE</sub> (ISO10360-7:2011)	1.0µm
Accuracy Assurance Environments <sup>*3</sup>	Temperature Range	20±0.2°C
	Temperature Variation	0.5°C/1H
	Temperature Gradient	1°C/m
Repeatability within the Visual Field	3σ=0.2µm	
Repeatability of Auto-focus	σ=0.4µm	
Stage Glass Size	19.4" x 21.7" (493x551mm)	
Max. Stage Loading	88lb (40kg)	
Dimensions (W x D x H)	46" x 68" x 75.2" (1172x1735x1910mm)	
Mass	4464 lb (2025kg)	
Used Air Pressure	0.4MPa <sup>*6</sup>	
Supplied Air Flow Rate	150L/min <sup>*7</sup>	

\*1: Accuracy when measured at the center of the video screen and in the middle of measuring stroke on a plane using the 5X objective and 1X tube lens  
 \*2: Specified only for factory shipping inspection.  
 \*3: Accuracy assurance environments in the case where no temperature compensation is performed.

Those in the case where temperature compensation is performed are as follows.  
 - Accuracy-assured temperature range: 20±2°C  
 - Temperature variation: 0.5°C/H  
 - Temperature gradient: 1°C/m  
 \*4: Thermal expansion coefficient: (0±0.02)X10-6/K

\*5: Accuracy 1.3+3L/1000 for 20 ± 2°C, Accuracy 1.3+3.50L/1000 from 18 to 23°C  
 \*6: An air source is required to maintain the original air pressure between 0.5 and 0.9MPa.  
 \*7: Indicates the flow rate under normal conditions.

### Self-Suction Air Pad

If a normal air pad is used for the Y axis, it is necessary to increase the mass of the work stage to obtain appropriate rigidity. ULTRA QV (Quick Vision) employs a special air pad called a self-suction type that floats the air pad using compressed air and also generates an absorption power with a vacuum zone provided under negative pressure at the center of the pad. This achieves greater Y-axis rigidity and stage weight reduction concurrently, thus enabling stable stage drive.

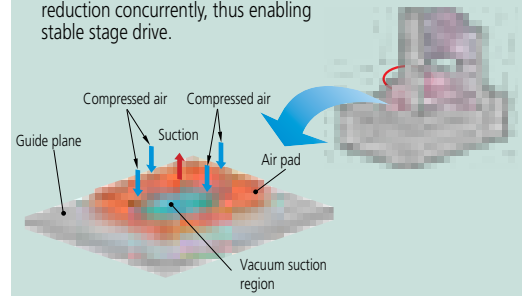

### Ball Screw Floating Mechanism

ULTRA QV employs high-reliability ball screws in the floating mechanism. This floating mechanism will minimize the error due to axial fluctuation that adversely affects kinetic performance, such as straightness, and improves the driving speed.

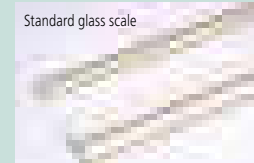
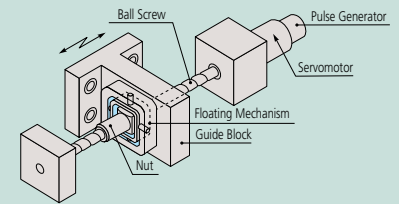

Ultra-high accuracy crystallized glass scale with virtually zero thermal expansion

The ULTRA Quick Vision is equipped with a crystallized glass scale having a resolution of 0.01µm and linear expansion coefficient of ±0.02x10<sup>-6</sup>/K. Virtually zero thermal expansion means the ULTRA Quick Vision can minimize accuracy fluctuation resulting from thermal changes.

### Tracking Auto Focus (TAF)

The TAF feature focuses continuously, adjusting to changes in the height of the object being measured. Automatic tracking of surface waves and warpage (in the Z axis) improves measurement throughput. The feature also cuts out the hassle of focusing during manual measurement and reduces the burden for the operator.

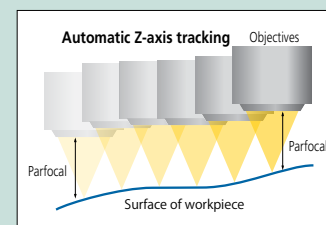

# UMAP Vision System TYPE2

## SERIES 364 — Micro-form Measuring System

### FEATURES

#### • Ultrasonic micro probe, UMAP

The ultrasonic micro probe (UMAP) has the ability to sense the amplitude variability in a micro area, and the optional contact points (15 to 300 $\mu$ m diameter) provide high-accuracy measurements to meet a variety of specifications.

#### • High-accuracy contact and non-contact measurement capabilities in one system

This unit includes the UMAP and the non-contact type vision head. Until now, it was difficult to measure minute areas, but it is now possible to do both contact and non-contact measurement on a single platform.



HYPER UMAP Vision System 302 TYPE2

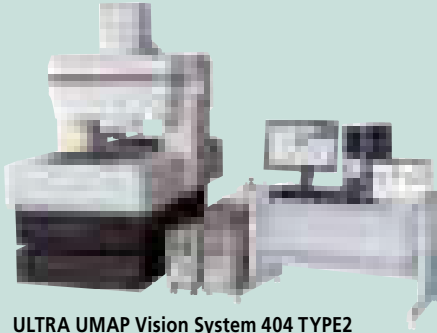

ULTRA UMAP Vision System 404 TYPE2

### Application examples



Contour measurement of a  $\phi 0.125$  hole

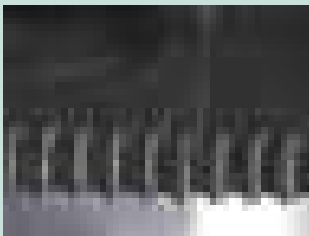

Measuring form of micro gear teeth

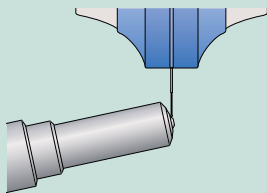

Measurement of a fuel injection nozzle hole's shape

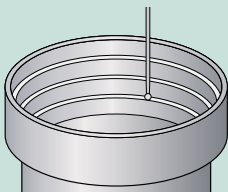

Measurement of a lens barrel's shape

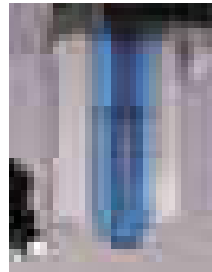

Micro probe, UMAP

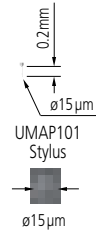

UMAP101 Stylus

$\phi 15\mu\text{m}$

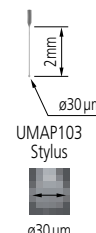

UMAP103 Stylus

$\phi 30\mu\text{m}$

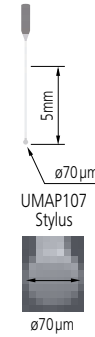

UMAP107 Stylus

$\phi 70\mu\text{m}$

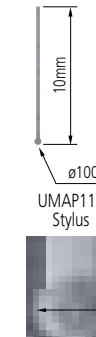

UMAP110 Stylus

$\phi 100\mu\text{m}$

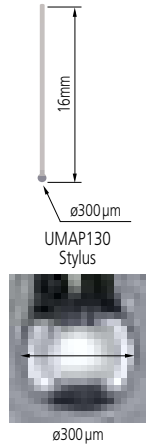

UMAP130 Stylus

$\phi 300\mu\text{m}$

### Detection of Surface Principle

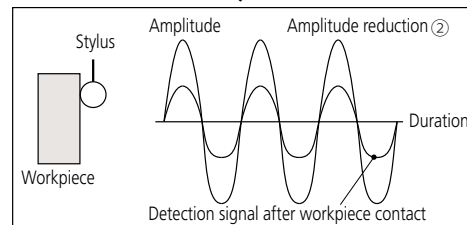
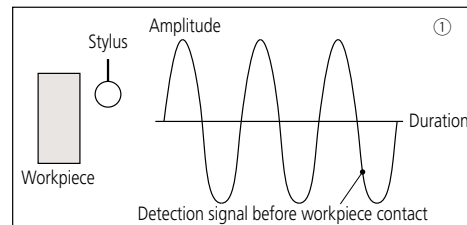

- ① In this drawing, the stylus is vibrating with a micro amplitude. When it does not come into contact with the workpiece, the vibration state is maintained.
- ② As the stylus comes into contact with the workpiece, the vibration amplitude decreases as the contact increases. When the decreasing amplitude falls below a certain level, a touch-trigger signal is generated.

### SPECIFICATIONS

		TYPE2	
		Hyper UMAP302	ULTRA UMAP404
Measuring range (common to vision and UMAP)	X-axis x Y-axis	7.28 x 7.87" (185x200mm)	11.22 x 15.75" (285x400mm)
	Z-axis	6.89" (175mm): UMAP101/103 7.07" (180mm): UMAP107/110 7.28" (185mm): UMAP130	
Measuring accuracy (Vision)	$E_{1X}, E_{1Y}$	(0.8+2L/1000) $\mu\text{m}$	(0.25+L/1000) $\mu\text{m}$
	$E_{1Z}$	(1.5+2L/1000) $\mu\text{m}$	
Repeatability	UMAP 101/103/107	$\sigma = 0.1\mu\text{m}$	$\sigma = 0.08\mu\text{m}$
	UMAP 110/130	$\sigma = 0.15\mu\text{m}$	$\sigma = 0.12\mu\text{m}$

# QV ACCEL

## SERIES 363 — Large-format CNC Vision Measuring System

### FEATURES

#### Moving-bridge type structure

Designed with primary focus on measurement efficiency, the machine drives the X and Y axes at 400mm/s (QV ACCEL808, ACCEL1010).

The moving-bridge type structure eliminates the need for a moving stage. This facilitates a more simplified design of the workpiece fixture, resulting in a significant reduction in the man-hours required for fixture fabrication and inspection.



### SPECIFICATIONS

Model No.		QV ACCEL 808 PRO	QV ACCEL 1010 PRO	QV ACCEL 1212 PRO	QV ACCEL 1517 PRO
Range	X-axis	32" / 800mm	40" / 1000mm	50" / 1250mm	60" / 1500mm
	Y-axis	32" / 800mm	40" / 1000mm	50" / 1250mm	70" / 1750mm
	Z-axis	6" / 150mm	6" / 150mm	4" / 100mm	4" / 100mm
Resolution		0.1µm			
Resolution of Z Scale using TAF		0.3µm			
High-sensitivity CCD camera		B&W			
Accuracy*	E1xy	(1.5+3L/1000)µm		(2.2+3L/1000)µm	
	E1z	(1.5+4L/1000)µm		(2.5+5L/1000)µm	
	E2xy	(2.5+4L/1000)µm		(3.5+4L/1000)µm	
Max. Drive Speed	X/Y-axis	400mm/s		300mm/s	
	Z-axis	150mm/s		150mm/s	
Illumination (PRL: Programmable Ring Light)	Surface	LED, white			
	Contour	LED, white			
	PRL	LED, white (4 divisions)			
Magnification Change System		Programmable Power Turret (1X, 2x, 6x)			
Stage Glass Size		34.8" x 37.7" 883 x 958mm	46.7" x 46.7" 1186 x 1186mm	56.7" x 56.7" 1440 x 1440mm	67.5" x 77.5" 1714 x 1968mm
Dimensions (W x D x H)		58 x 67.5 x 62" 1475x1716x1578mm	75.3 x 82 x 63" 1912x2086x1603mm	85.3 x 92 x 61" 2166x2340 x1554mm	96 x 113 x 61" 2440 x 2868 x 1554mm
Max Stage Loading		22 lbs / 10kg	66.1 lbs / 30kg	66.1 lbs / 30kg	66.1 lbs / 30kg
Mass		5666 lbs / 2570kg	6504 lbs / 2950kg	7937 lbs / 3600kg	9921 lbs / 4500kg

\* The measuring accuracy is defined at the following conditions, Programmable power turret: 1X, Objective lens: 2.5X (HR or SL), L = Dimension between two arbitrary points (mm)

#### Image Multi-AutoFocus

The optimal focus can be selected for each surface texture and measured feature, providing high reproducibility and reliable edge detection.



Surface focus

Edge focus

#### Programmable Ring Light (PRL)

Fine control of obliquity and direction provides illumination optimal for measurement. Obliquity can be arbitrarily set in the range from 30° to 80°. This type of illumination is effective for enhancing the edge of inclined surfaces or very small steps. Illumination can be controlled independently in every direction, back and forth, right and left. Measurement with edge enhancement is possible by forming a shadow with lighting from only one direction.

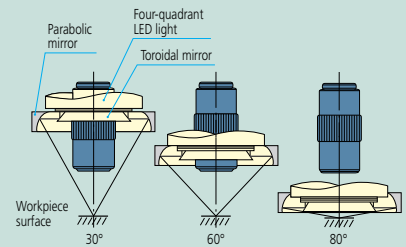

#### Tracking Auto Focus (TAF)

The TAF feature focuses continuously, adjusting to changes in the height of the object being measured. Automatic tracking of surface waves and warpage (in the Z axis) improves measurement throughput. The feature also removes the hassle of focusing during manual measurement.

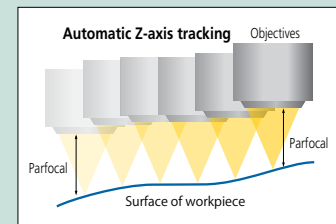

#### Tracking Auto Focus (TAF)

AF principle	Objective Coaxial Autofocusing (Knife-edge method)				
Suitable Objectives	QV-HR1x	QV-SL1x	QV-HR2.5x	QV-SL2.5x	QV-5x
Tracking Range*2	6.3mm (±3.15mm)	6.3mm (±3.15mm)	1mm (±0.5 mm)	1mm (±0.5 mm)	0.25mm (±0.125mm)
Spot Diameter*3	5.2µm	8.0µm	2.1µm	3.1µm	1.5µm
Laser Source	Semiconductor laser (peak wavelength: 690nm)				
Laser Power	0.9mW				
Laser Safety	Class 2 (JIS C6802:2011, EN/IEC 60825-1:2007)				

\*2 Varies according to workpiece surface texture and reflectance.

\*3 Design values.

# Quick Vision with Touch-Trigger Probe

## QV3DCAD-Online

QV3DCAD-Online uses 3D CAD models to easily create QVPAK part programs. QV measurements can be performed by specifying an element in the CAD data. This improves program creation efficiency more than using a joystick to perform teaching.

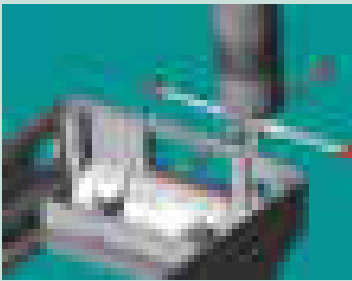

The interference check function can be used to prevent problems caused by the probe or objective lens colliding with the workpiece.

## Non-contact and contact measurement with one machine

QV touch probe allows both vision measurement and touch-probe measurement.

## 3D workpiece measurement

Measures three-dimensional workpieces such as molded products, resin-molded products, machined products and more.

## Module change rack available

Easily change between vision and touch-probe measurement with a module change rack.

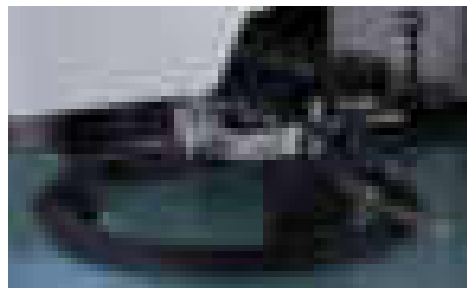
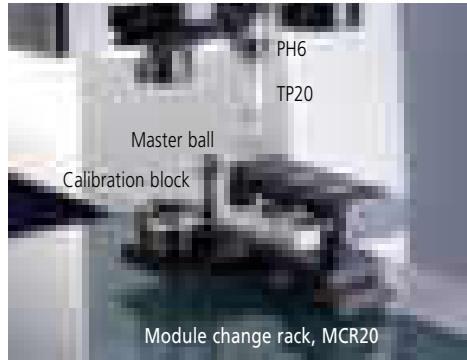

QV Active with optional Opti-fix clamping system

## Supported CAD Formats

- SAT
- IGES\*
- STEP\*
- Parasolid\*
- SolidWorks\*
- Unigraphics\*
- CATIA\*

\* optional

## Specifications with Touch-Probe Option

		QV TP Active 202	QV TP Active 404	QV TP Apex302 Hyper QV TP302	QV TP Apex404 Hyper QV TP404	QV TP Apex606 Hyper QV TP606
Measuring Range* <sup>1</sup> (X×Y×Z)	Vision	250×200×150mm	400×400×200mm	300×200×200mm	400×400×250mm	600×650×250mm
	Touch Probe	131×200×150mm <sup>†</sup>	284×400×200mm	234×200×200mm	334×400×250mm	534×650×250mm
Measuring accuracy* <sup>2</sup> (Touch Probe)	E <sub>1x</sub> , E <sub>1y</sub> , E <sub>1z</sub>	(2.4+3L/1000)μm	(2.4 + 3L/1000)μm	QV TP Apex:(1.8+3L/1000)μm Hyper QV TP:(1.7+3L/1000)μm		

		QV TP ACCEL 808	QV TP ACCEL 1010	QV TP ACCEL 1212	QV TP ACCEL 1517
Measuring Range* <sup>1</sup> (X×Y×Z)	Vision	800×800×150mm	1000×1000×150mm	1250×1250×100mm	1500×1750×100mm
	Touch Probe	734×800×150mm	934×1000×150mm	1184×1250×100mm	1434×1750×100mm
Measuring Accuracy* <sup>2</sup> (Touch probe)	E <sub>1x</sub> , E <sub>1y</sub> , E <sub>1z</sub>	(1.8+3L/1000)μm	(3+4L/1000)μm	(6+7L/1000)μm	

\*1: When a module change rack, a master ball and a calibration ring are mounted, the measurement ranges are smaller than those in the table. Other specifications are the same as those of QV ELF, QV Apex, Hyper QV, and QV ACCEL. Please contact our sales office for more details.

\*2: Inspected by Mitutoyo standard. L = length between two arbitrary points (mm)

<sup>†</sup> : With calibration ring removed.

# Accessories for Quick Vision

## Tracking Auto Focus (TAF)

The TAF feature focuses continuously, adjusting to changes in the height of the object being measured. Automatic tracking of surface waves and warpage (in the Z axis) improves measurement throughput. The feature eliminates the hassle of focusing during manual measurement.

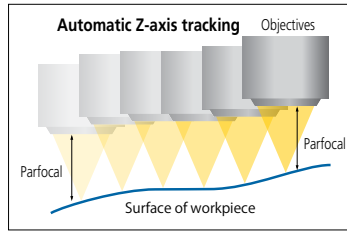

### Tracking Auto Focus (TAF)

AF principle	Objective Coaxial Autofocusing (Knife-edge Method)				
Suitable Objectives	QV-HR1x	QV-SL1x	QV-HR2.5x	QV-SL2.5x	QV-5x
Tracking Range*2	6.3mm (±3.15mm)	6.3mm (±3.15mm)	1mm (±0.5 mm)	1mm (±0.5 mm)	0.25mm (±0.125mm)
Spot Diameter*3	5.2µm	8.0µm	2.1µm	3.1µm	1.5µm
Laser Source	Semiconductor laser (peak wavelength: 690nm)				
Laser Power	0.9mW				
Laser Safety	Class 2 (JIS C6802:2011, EN/IEC 60825-1:2007)				

\*2 Varies according to workpiece surface texture and reflectance.  
\*3 Design values.

## PFF (Points from Focus)

Mitutoyo-developed optical data collection method that stitches images together with high-resolution Z axis data.

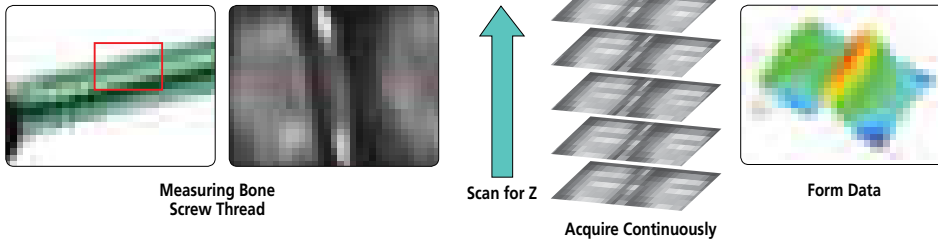

## Calibration Glass Chart

### No. 02AKN020 †

A calibration chart is used to compensate for the pixel size of the CCD chip, autofocus accuracy and the optical axis offset at each magnification of the variable magnification unit (PPT).



## Compensation Chart

### No. 02AKU400\*

A compensation chart is used to decrease optical distortion and errors caused by difference of the pattern and texture on the workpiece surface.



## QV-Index Head\*

Automatic multi-plane measurement is possible with the optional index table.

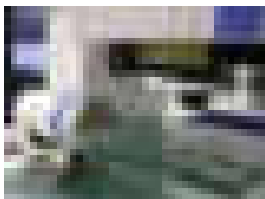

Max. workpiece diameter	5.51" / 140mm
Max. workpiece mass	4.41 lbs / 2kg
Min. rotation angle	0.1°
Positioning accuracy	±0.5°
Max. rotation speed	10rpm

## Capable of Supporting ISO10360-7 Guaranteed Accuracy

Some models in the Quick Vision Series support the ISO10360-7 guaranteed accuracy specifications.

Contact Mitutoyo for details on applicable models.

### Guaranteed accuracies

- Length measurement error  $E_{L^*/MPE}$
- Probing error  $P_{F2D^*/MPE}$

Length measurement error E

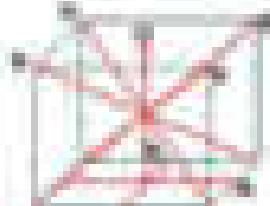

## Objectives



Objective mag.	Turret lens mag.	Monitor mag.	Field of View
0.5X	1X	16X	12.54 x 9.40
	2X	32X	6.27 x 4.70
	6X	96X	2.09 x 1.56
1X	1X	32X	6.27 x 4.70
	2X	64X	3.13 x 2.35
	6X	192X	1.04 x 0.78
2.5X	1X	80X	2.50 x 1.88
	2X	160X	1.25 x 0.94
	6X	480X	0.41 x 0.31
5X	1X	160X	1.25 x 0.94
	2X	320X	0.62 x 0.47
	6X	960X	0.20 x 0.15
10X	1X	320X	0.62 x 0.47
	2X	640X	0.31 x 0.23
	6X	1920X	0.10 x 0.07
25X	1X	800X	0.25 x 0.18
	2X	1600X	0.12 x 0.09
	6X	4800X	0.04 x 0.03

## Objective †

Objective	Order No.	Working Distance
QV-SL0.5X	02AKT199	30.5mm
QV-HR1X	02AKT250	40.6mm
QV-SL1X	02ALA150	52.5mm
QV-HR2.5X	02AKT300	40.6mm
QV-SL2.5X	02ALA170	60mm
QV-5XHR	02AWD010	20mm
QV-10XHR	02AKT650	20mm
QV-25X	02ALG020	13mm

The monitor magnification and field of view values are for the PRO machine.  
QV-10X, QV-25X: Depending on a workpiece of illumination may be insufficient at a turret lens magnification of 2X and 6X.  
QV-25X: The PRL illumination is restricted in its usable position.

## Multi-Function Control Box

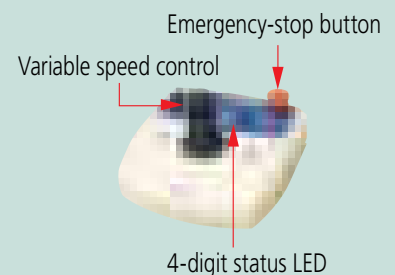

# OPTI-FIX Kits

## Modular Clamping System for Vision Measuring Systems

The modular opti-fix clamping system has been developed specifically for optical coordinate measuring systems.

Opti-fix guarantees safe part fixturing during measurement. This functional configuration also makes multiple part measurements considerably easier.

In order to reduce errant reflections of lighting systems and ambient light effects to a minimum, all important construction elements are anodized in flat-black or matte finish.



For mounting workpieces on the glass stage, different fixturing methods are available.

In the case of measuring methods using reflected, as well as transmitted light, for measurement of cubic, rotationally symmetrical and flat workpieces, the use of Opti-fix is a practical solution.

Furthermore, the spring clips and centering pins are integrated into the system to allow for tactile measuring. Opti-fix offers a large number of configurations for part fixturing, from clamping tweezers for miniature parts to a precision vice for large parts.

Fastening brackets, vacuum plates or magnetic holders for mounting the clamping system on the measuring machine, can be ordered separately.

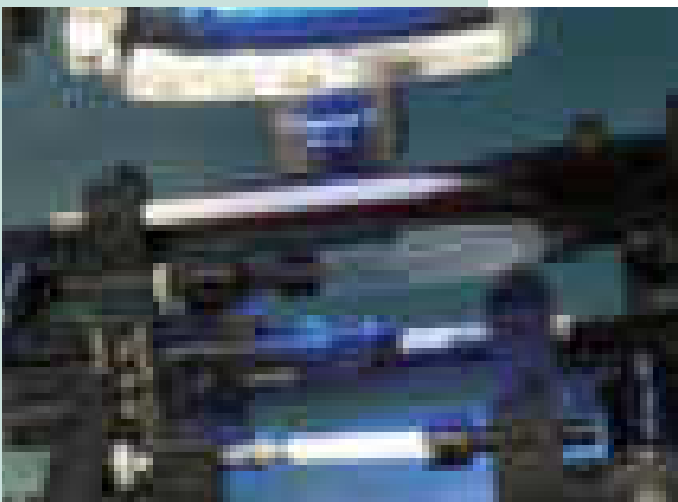
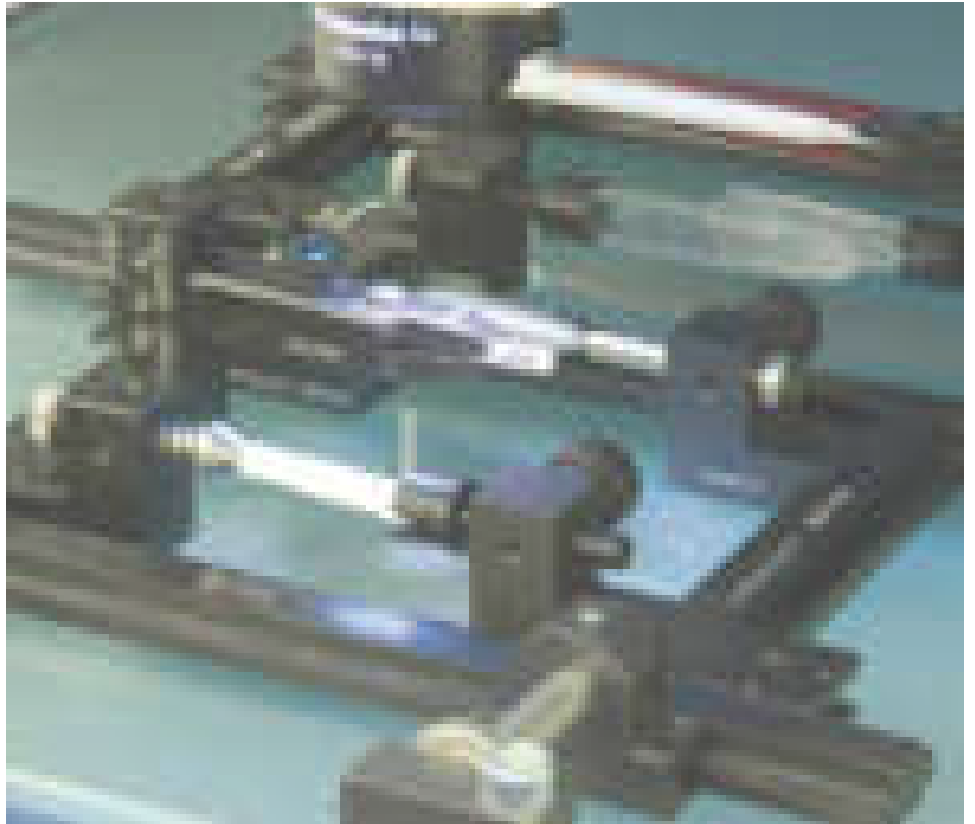

# OPTI-FIX Kits

## Opti-Set Start



K551056

For construction of a simple rail system with a length of 250 mm and for fixturing parts with simple part geometry. 16 parts.

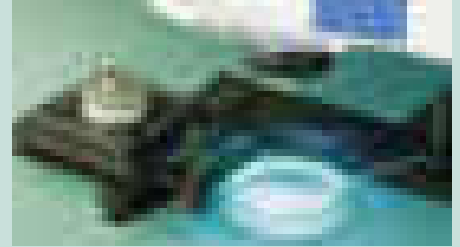

## Opti-Set Basic



K551057

For construction of a basic frame with the dimensions of 200 mm x 100 mm and for fixturing parts with simple part geometry. 26 parts.

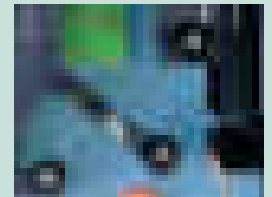
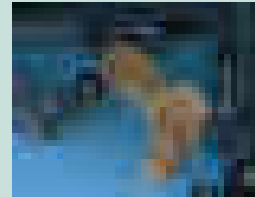

## Opti-Set Rotation



K551058

For construction of a basic frame with the dimensions of 250 mm x 200 mm and for fixturing parts that are rotationally symmetric with and without center holes. 23 parts.

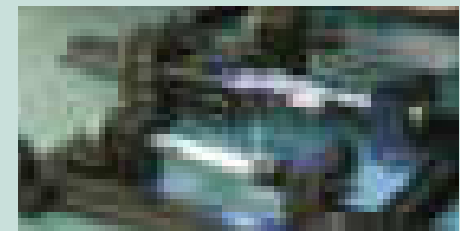



# OPTI-FIX Kits

## Opti-Set Advanced

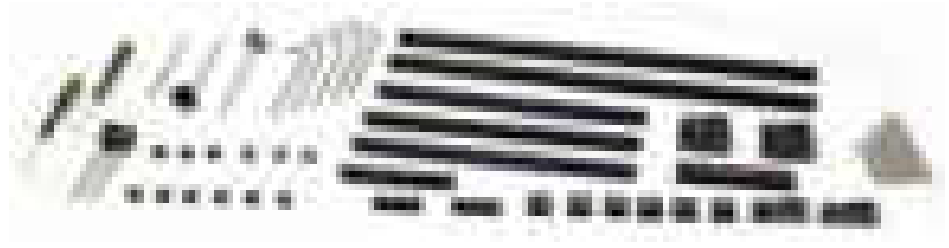
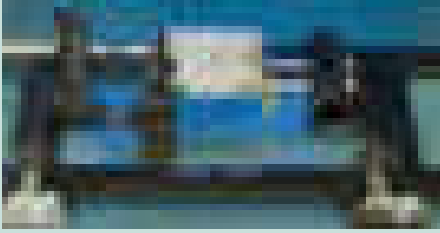

**K551059**

For construction of a basic frame with the dimensions of 400 mm x 250 mm and for fixturing parts with slightly more complex part geometry. 51 parts.

## Opti-Set Professional

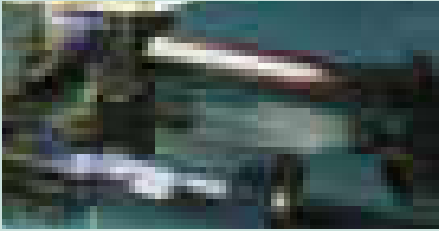

**K551060**

For construction of a basic frame with the dimensions of 400 mm x 250 mm and for fixturing parts with complex part geometry. The fixturing of parts with a rotational part geometry is also available. 115 parts.

## Opti-Set Round

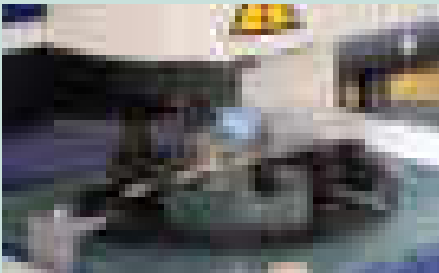

**K550298**

With locating and clamping elements, included adaptor plates for adaptation to the basic frame of the rail system. 18 parts.

# Quick Guide to Precision Measuring Instruments



## Vision Measuring Machines

### ■ Vision Measurement

Vision measuring machines provide the following processing capabilities.

#### ■ Edge detection

Detecting/measuring edges in the XY plane

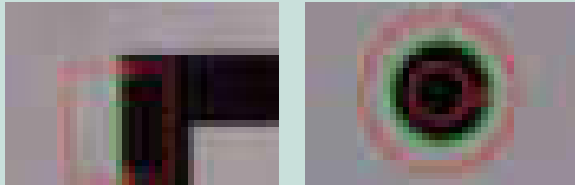

#### ■ Auto focusing

Focusing and Z measurement

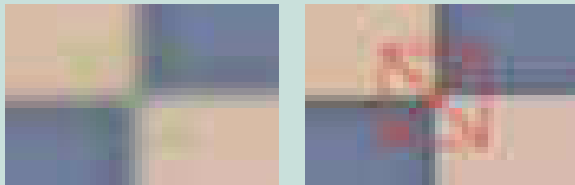

#### ■ Pattern recognition

Alignment, positioning, and checking the presence of a feature

### ■ Image Storage

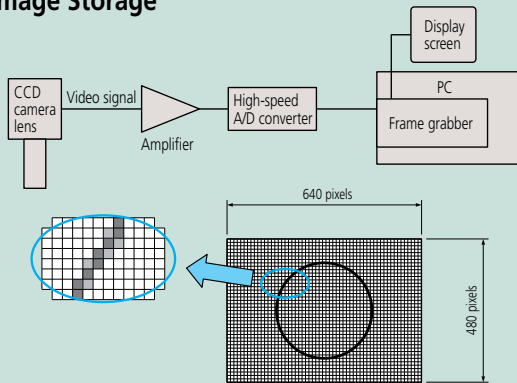

An image is comprised of a regular array of pixels, similar to the process that produces a printed image picture on fine plotting paper with each square solid-filled.

### ■ Gray Scale

A PC stores an image after internally converting it to numeric values. A numeric value is assigned to each pixel of an image. Image quality varies depending on how many levels of gray scale are defined by the numeric values. The PC provides two types of gray scale: two-level and multi-level. The pixels in an image are usually displayed as the 256-level gray scale.

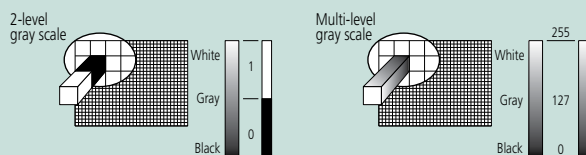

Pixels in an image brighter than a given level are displayed as white and all other pixels are displayed as black.

Each pixel is displayed as one of 256 levels between black and white. This allows high-fidelity images to be displayed.

### ■ Difference in Image Quality

Difference between 2-level and 256-level gray-scale images

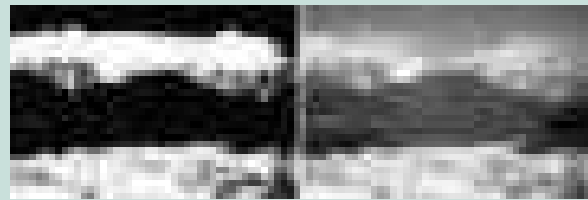

Sample image displayed in 2-level gray scale      Sample image displayed in 256-level gray scale

### ■ Variation in Image Depending on Threshold Level



These three pictures are the same image displayed as 2-level gray scale at different slice levels (threshold levels). In a 2-level gray-scale image, different images are provided as shown above due to a difference in slice level. Therefore, the 2-level gray scale is not used for high-precision vision measurement since numeric values will change depending on the threshold level that is set.

### ■ Dimensional Measurement

An image consists of pixels. If the number of pixels in a section to be measured is counted and multiplied by the size of a pixel, then the section can be converted to a numeric value in length. For example, assume that the total number of pixels in the lateral size of a square workpiece is 300 pixels as shown in the figure below. If a pixel size is 10µm under a specific imaging magnification, the total length of the workpiece is given by 10µm x 300 pixels = 3000µm = 3mm.

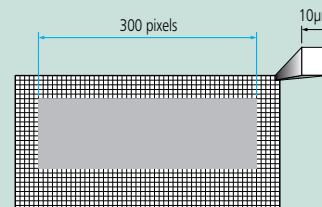

### ■ Edge Detection

How to detect a workpiece edge in an image is described using the following monochrome picture as an example. Edge detection is performed within a given domain. A symbol that visually defines this domain is referred to as a tool. Multiple tools are provided to suit various workpiece geometries or measurement data.

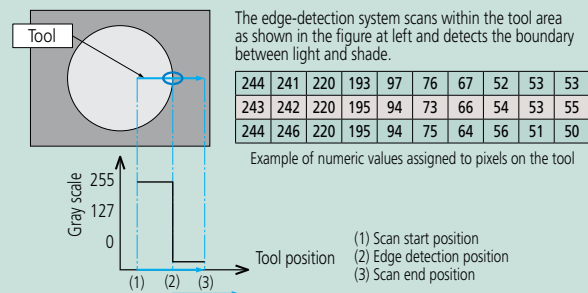

## High-resolution Measurement

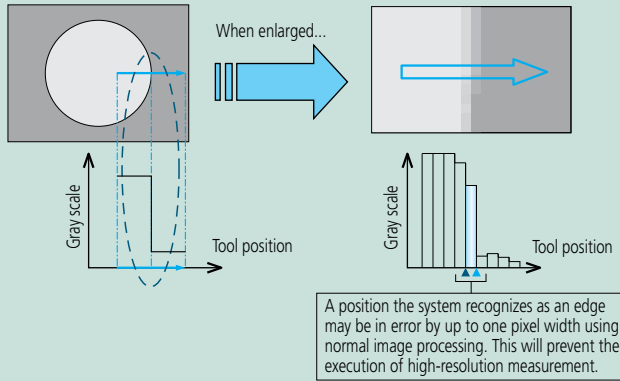

To increase the accuracy in edge detection, sub-pixel image processing is used.

An edge is detected by determining an interpolation curve from adjacent pixel data as shown below. As a result, it allows measurement with a resolution higher than 1 pixel.

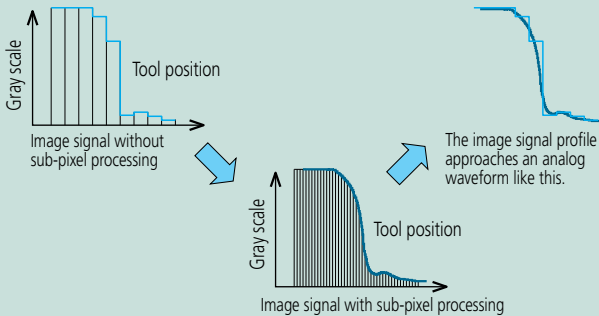

## Measurement along Multiple Portions of an Image

Large features that cannot be contained on one screen have to be measured by precisely controlling the position of the CCD sensor and stage so as to locate each reference point within individual images. By this means, the system can measure even a large circle, as shown below, by detecting the edge while moving the stage across various parts of the periphery.

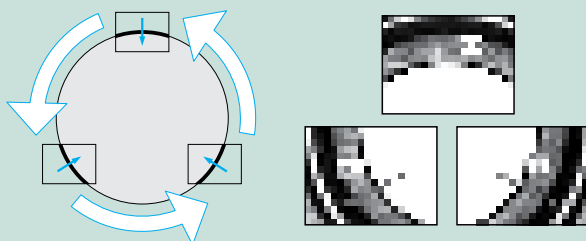

## Composite Coordinates of a Point

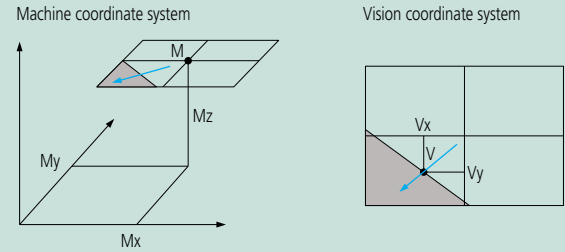

Measuring machine stage position  
 $M = (M_x, M_y, M_z)$

Detected edge position (from the center of vision)  
 $V = (V_x, V_y)$

Actual coordinates are given by  $X = (M_x + V_x)$ ,  $Y = (M_y + V_y)$ , and  $Z = M_z$ , respectively.

Since measurement is performed while individual measured positions are stored, the system can measure dimensions that cannot be included in one screen.

## Principle of Auto Focusing

The system can perform XY-plane measurement, but cannot perform height measurement using only the CCD camera image. The system is commonly provided with the Auto Focus (AF) mechanism for height measurement. The following explains the AF mechanism that uses a common image, although some systems may use an AF laser.

The AF system analyzes an image while moving the CCD in the Z axis. In the analysis of image contrast, an image in sharp focus will show a peak contrast and one out of focus will show a low contrast. Therefore, the height at which the image contrast peaks is the just-in-focus height.

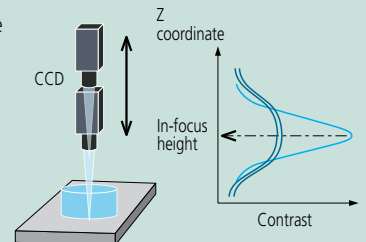

## Variation in Contrast Depending on the Focus Condition

Edge contrast is low due to out-of-focus edges.

Edge contrast is high due to sharp, in-focus edges.

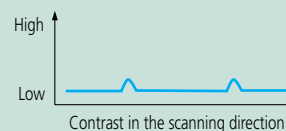
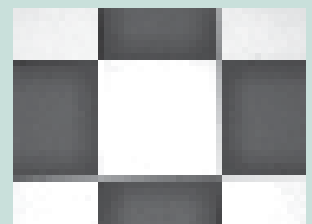
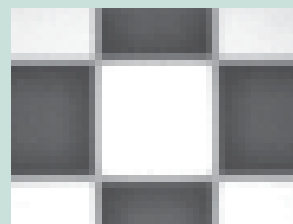

# Notices and Disclaimers

## Warranties

Mitutoyo America Corporation ("Mitutoyo") warrants all of its products sold and shipped in the United States and Canada for one year from the date of installation at the original purchaser facility. The description as shown below is not a warranty by itself and is for general information only. For warranty terms and conditions as they pertain to a specific product, contact the Mitutoyo service center.

Mitutoyo warrants the products and software it manufactures and sells directly or through an authorized distributor, if the product or software is in the possession of the original purchaser. Except for software, Mitutoyo will, at its option, repair or replace any part or parts, which upon examination, are found to be defective in workmanship or material, provided the product is returned to Mitutoyo and the purchaser can prove that the product has been used and maintained and, where applicable, installed in accordance with Mitutoyo instructions and has not been subject to abuse. For software, Mitutoyo will replace defective media or make a warranted program operate or replace the program with a functionally equivalent program as warranted, provided there is satisfactory documentation that the software has been installed, used and maintained in accordance with Mitutoyo instructions in the User Manual and provided further that the customer can satisfactorily show that a defect exists.

Mitutoyo does not accept liability or responsibility for repairs, additions, or modifications made to the product, including those made by others, without Mitutoyo's written consent.

The warranties Mitutoyo provides do not adversely affect Mitutoyo's right to modify or change the design of products, without notice, including any of its specifications or materials.

## Export Compliance

All products in this catalog are subject to the Foreign Exchange and Foreign Trade Control laws of Japan, US Export Administration Regulations (EAR) or the Canadian Export and Import Permits Act. Re-export or relocation of any of these products may require prior approval by an appropriate governing authority. If a purchased product is exported or re-exported, even if it is not considered a regulated item by a governing authority, Mitutoyo would like to be made aware, as the customer service available for that product may be affected. If you have any questions, please consult your local Mitutoyo sales office.

## Safety Caution

Carefully read the specifications and functions in this catalog before selecting products. Safety may be compromised if you use products for purposes other than those stated here. Feel free to contact your nearest Mitutoyo sales center if you wish to use a product for other purposes or in a special environment.

## Appearance and Specifications

Appearance and specifications are subject to change without prior notice for product improvement.

The product names in this catalog are registered trademarks or trademarks of Mitutoyo or their respective companies.

## Conformance to Specification

The simple acceptance decision rule, as defined in ASME B89.7.3.1-2001, ISO/IEC Guide 98-4:2012, and ISO/TR 14253-6:2012, applies when determining measuring equipment conformance to specified accuracy values in this catalog. In applying the simple acceptance decision rule, the measurement capability index, as defined in ISO/IEC Guide 98-4:2012 and ISO/TR 14253-6:2012, shall be equal to or greater than one and is recommended to be equal to or greater than four whenever practicable. Mitutoyo America Corporation recommends the use of ISO/IEC 17025 accredited calibration laboratories and that measurement uncertainty be evaluated in accordance with ISO/IEC Guide 98-3:2008 and ISO 14253-5:2015.

# APPLICATIONS INDEX



## STANDARDS

	Page
Bore Gage Auxiliary Block Kit	E-27
Bore Gage Zero Checker	C-29
CERA Caliper Checker	D-49
CERA Straight Master	E-30
Check Master	E-29
Depth Micro Checker	D-51
Digital Height Master	E-26
Gage Blocks	E-2-19
Height Master	E-25
High Precision Squares	E-33
Inside Micro Checker	C-19
Micrometer Standards	B-51
Micrometer Stands	B-48
Optical Flats	B-50
Optical Parallels	B-50
Setting Rings	C-29,30
Square Master	E-31
Standard Scales	E-32
Universal Height Master	E-28
Working Standard Scales	E-32
Rockwell Hardness Tester Calibration Set	K-11
Hardmatic Test Block Set	K-15
Step Master	E-23
Thickness / Feeler Gages	E-36



## MEASUREMENT OF INSIDE DIMENSIONS

	Page
<b>■ ONE-DIMENSIONAL</b>	
ABSOLUTE Digimatic and Vernier Calipers (Offset)	D-15
ABSOLUTE Digimatic Bore Gage	C-27
ABSOLUTE Digimatic Calipers	D3-7,15,17,20-30
Bore Gages	C-10-28
Borematic	C-8-10
Dial Caliper Gages	F-56,57
Dial Calipers	D-8,9
Digimatic Holtest	C-2,3,10
Groove Micrometers	B-46
Holtest	C-2-7,10
Inside Micro Checker	C-19
Inside Micrometers	C-11-18
Small Hole Gage Set	B-47
Telescoping Gage Set	B-47
Tubular Inside Micrometers	C-11,12,14-17
Vernier Calipers	D-10-16,22-27,29
<b>■ TWO-DIMENSIONAL</b>	
Measuring Microscopes	I-16-22
Profile Projectors	I-2-11
QM-Data200	I-25,26
Quick Image Non-contact 2D Vision Measuring System	M-3
Toolmakers' Microscopes	I-16
Vision Unit	I-27
<b>■ THREE-DIMENSIONAL</b>	
Coordinate Measuring Machines (CMM)	L-3-15
Quick Scope Manual Vision Measuring System	M-2
Quick Vision Series	M-4-10,12,13
UMAP Micro-form Measuring System	M-11



## MEASUREMENT OF OUTSIDE DIMENSIONS

	Page
<b>■ ONE-DIMENSIONAL</b>	
Calipers	D-2-32
Dial Thickness Gages	F-50-52
Digimatic Thickness Gages	F-50-52
Dial Caliper Gages	F-56,57
Dial Snap Gages	F-59
Outside Micrometers	B-9,11-19
Digital Outside Micrometers	B-42
Digimatic Micrometers	B-2-8,18,20-24,27-29,31,32,34-36,38,45
Quickmike	B-8
Litematic	G-27
Steel Rules	E-34,35
Working Standard Scales	E-32
Working Standard Scales	E-32
<b>■ TWO-DIMENSIONAL</b>	
Measuring Microscopes	I-16-22
Profile Projectors	I-2-11
QM-Data200	I-25,26
Quick Image Non-contact 2D Vision Measuring System	M-3
Toolmakers' Microscopes	I-16
Vision Unit	I-27
<b>■ THREE-DIMENSIONAL</b>	
Coordinate Measuring Machines (CMM)	L-3-15
Quick Scope Manual Vision Measuring System	M-2
Quick Vision Series	M-4-10,12,13
UMAP Micro-form Measuring System	M-11



## ANGLE MEASUREMENT

	Page
<b>■ ONE-DIMENSIONAL</b>	
Bevel Protractor	E-38
Digital Universal Protractor	E-41
Universal Bevel Protractor	E-38
<b>■ TWO-DIMENSIONAL</b>	
Measuring Microscopes	I-16-22
Profile Projectors	I-2-11
QM-Data200	I-25,26
Quick Image Non-contact 2D Vision Measuring System	M-3
Toolmakers' Microscopes	I-16
Vision Unit	I-27
<b>■ THREE-DIMENSIONAL</b>	
Coordinate Measuring Machines (CMM)	L-3-15
Quick Scope Manual Vision Measuring System	M-2
Quick Vision Series	M-4-10,12,13
UMAP Micro-form Measuring System	M-11

# APPLICATIONS INDEX



## DEPTH MEASUREMENT

Page

### ■ ONE-DIMENSIONAL

ABSOLUTE Digimatic Calipers	D3-7,15,17,20-30
ABSOLUTE Digimatic Depth Gages	D-52, 53, 55,57,58
Depth Base Attachment (Vernier Caliper)	D-33
Depth Micrometers	D-50,51
Dial Calipers	D-8,9
Dial Depth Gage	D-56-58
Digimatic Depth Micrometers	D-50
Extension Bases (Optional accessory for Depth Gage)	D-56
Vernier Calipers	D-10-16,22-27,29
Vernier Depth Gages	D-54,55

### ■ TWO-DIMENSIONAL

Linear Height	D-36,37
Measuring Microscopes	I-16-22
Vision Unit	I-27

### ■ THREE-DIMENSIONAL

Coordinate Measuring Machines (CMM)	L-3-15
Quick Vision Series	M-4-10,12,13
UMAP Micro-form Measuring System	M-11



## HEIGHT MEASUREMENT

Page

### ■ ONE-DIMENSIONAL

Black Granite Surface Plates	E-45
Dial Height Gages	D-42
Digimatic Height Gages	D-40,41,43,44
Height Master	E-25
QM-Height	D-38,39
Universal Height Master	E-28
Vernier Height Gages	D-45,46

### ■ TWO-DIMENSIONAL

Linear Height	D-36,37
Measuring Microscopes	I-16-22
Vision Unit	I-27

### ■ THREE-DIMENSIONAL

Coordinate Measuring Machines (CMM)	L-3-15
Quick Scope Manual Vision Measuring System	M-2
Quick Vision Series	M-4-10,12,13
UMAP Micro-form Measuring System	M-11



## MEASUREMENT OF COMPLEX 3D PARTS

Page

### ■ THREE-DIMENSIONAL

Coordinate Measuring Machines (CMM)	L-3-15
Quick Scope Manual Vision Measuring System	M-2
Quick Vision Series	M-4-10,12,13
UMAP Micro-form Measuring System	M-11



## COMPARISON MEASUREMENT

Page

### ■ ONE-DIMENSIONAL

Bore Gages	C-10-28
Borematic	C-8-10
Calibration Tester	F-49
Comparator Stands	F-64
Dial Gage Stands	F-61
Dial Indicators	F-15-32
Dial Snap Gages	F-59
Dial Snap Meters	B-44
Dial Test Indicators	F-39-46
Digimatic Height Gages	D-40,41,43,44
Digimatic Holtest	C-2,3,10
Digimatic Indicators	F-2-13
Digimatic Micrometers	B-2-8,18,20-24,27-29,31,32,34-36,38,45
Gage Block Comparator	E-24
Gage Blocks	E-2-19
Height Master	E-25
Indicating Micrometers	B-43
Laser Scan Micrometers	G-36-43
Linear Gages	G-4-17
Litematic	G-27
Mu-Checker (In-process measurement)	G-30-33
QM-Height	D-38,39
Telescoping Gage Set	B-47
QM-Height	D-38 - D-39
Telescoping Gage Set	B-47

### ■ TWO-DIMENSIONAL

Linear Height	D-36,37
Measuring Microscopes	I-16-22
Profile Projectors	I-2-11
QM-Data200	I-25,26
Quick Image Non-contact 2D Vision Measuring System	M-3
Toolmakers' Microscopes	I-16
Vision Unit	I-27

### ■ THREE-DIMENSIONAL

Coordinate Measuring Machines (CMM)	L-3-15
Quick Vision Series	M-4-10,12,13
UMAP Micro-form Measuring System	M-11



## STEP MEASUREMENT

Page

### ■ ONE-DIMENSIONAL

ABSOLUTE Digimatic Calipers	D3-7,15,17,20-30
Dial Calipers	D-8,9
Dial Height Gages	D-42
Dial Indicators	F-15-32
Dial Test Indicators	F-39-46
Digimatic Height Gages	D-40,41,43,44
Digimatic Indicators	F-2-13
Linear Gages	G-4-17
Mu-Checker (In-process measurement)	G-30-33
QM-Height	D-38,39
Uni-Mike	B-29
Vernier Calipers	D-10-16,22-27,29
Vernier Height Gages	D-45,46

### ■ TWO-DIMENSIONAL

Linear Height	D-36,37
---------------	---------

### ■ THREE-DIMENSIONAL

Coordinate Measuring Machines (CMM)	L-3-15
Quick Scope Manual Vision Measuring System	M-2
Quick Vision Series	M-4-10,12,13
UMAP Micro-form Measuring System	M-11



## MEASUREMENT OF ELASTIC PARTS

Page

### ■ ONE-DIMENSIONAL

ABSOLUTE Low Force Caliper	D-28
Litematic	G-27
Litematic Head	G-27

### ■ TWO-DIMENSIONAL

Measuring Microscopes	I-16-22
Profile Projectors	I-2-11
Quick Image Non-contact 2D Vision Measuring System	M-3
Toolmakers' Microscopes	I-16

### ■ THREE-DIMENSIONAL

Coordinate Measuring Machines (CMM)	L-3-15
Quick Scope Manual Vision Measuring System	M-2
Quick Vision Series	M-4-10,12,13
UMAP Micro-form Measuring System	M-11



## MEASUREMENT OF SHEET METALS

Page

Laser Scan Micrometers	G-36-43
Sheet Metal Micrometers	B-30



## NON-CONTACT MEASUREMENT

Page

### ■ ONE-DIMENSIONAL

Laser Scan Micrometers	G-36-43
------------------------	---------

### ■ TWO-DIMENSIONAL

Measuring Microscopes	I-16-22
Profile Projectors	I-2-11
Toolmakers' Microscopes	I-16

### ■ THREE-DIMENSIONAL

Quick Scope Manual Vision Measuring System	M-2
Quick Vision Series	M-4-10,12,13
UMAP Micro-form Measuring System	M-11



## MULTI-POINT MEASUREMENT

Page

Dial Indicators	F-15-32
Digimatic Indicators	F-2-13
Linear Gage Counter (EC, EG, EB, EV)	G-20-25
Linear Gages	G-4-17
Mu-Checker	G-30-33



## MEASURING INSTRUMENTS TO BE USED AS SENSORS

Page

ABSOLUTE Digimatic Scale Units	H-2-5
Dial Indicators	F-15-32
Dial Test Indicators	F-39-46
Digimatic Indicators	F-2-13
Laser Scan Micrometers	G-36-43
Linear Gages	G-4-17
Linear Scale	H-10-29
MICSYS 2D Non-contact Encoder	H-18
Mu-Checker (In-process measurement)	G-30-33



## MEASUREMENT OF FORM (SURFACE ROUGHNESS, ROUNDNESS), SQUARENESS, AND PARALLELISM

Page

Bench Centers	E-43
Black Granite Surface Plates	E-45
Contracer	J-28-31
Coordinate Measuring Machines (CMM)	L-3-15
Dial Test Indicators	F-39-46
Formtracer	J-14-21
High Precision Squares	E-33
Mu-Checker (use together with Height Gages, etc.)	G-30-33
Optical Flats	B-50
Optical Parallels	B-50
Precision Levels	E-36
Roundtest	J-39-48
Square Master	E-31
Surftest	J-2-13

# APPLICATIONS INDEX



## MEASUREMENT OF CENTER-TO-CENTER DISTANCES

Page

### ■ ONE-DIMENSIONAL

ABSOLUTE Digimatic and Vernier Calipers (Offset)	D-15
Black Granite Surface Plates	E-45
QM-Height	D-38,39

### ■ TWO-DIMENSIONAL

Linear Height	D-36,37
Measuring Microscopes	I-16-22
Profile Projectors	I-2-11
QM-Data200	I-25,26
Quick Image Non-contact 2D Vision Measuring System	M-3
Toolmakers' Microscopes	I-16
Vision Unit	I-27

### ■ THREE-DIMENSIONAL

Coordinate Measuring Machines (CMM)	L-3-15
Quick Scope Manual Vision Measuring System	M-2
Quick Vision Series	M-4-10,12,13
UMAP Micro-form Measuring System	M-11



## SCREW THREAD MEASUREMENT

Page

### ■ ONE-DIMENSIONAL

3-Wire Units	B-39
Digimatic Micrometers	B-2-8,18,20-24,27-29,31,32,34-36,38,45
Digital Outside Micrometers	B-42
Outside Micrometers	B-9,11-19
Point Micrometers	B-21
Screw Thread Micrometers	B-37,38
Thread Pitch Gages	E-39
V-Anvil Micrometers	B-23,24,29

### ■ TWO-DIMENSIONAL

Contracer	J-28-31
Measuring Microscopes	I-16-22
Profile Projectors	I-2-11
QM-Data200	I-25,26
Quick Image Non-contact 2D Vision Measuring System	M-3
Toolmakers' Microscopes	I-16
Vision Unit	I-27

### ■ THREE-DIMENSIONAL

Coordinate Measuring Machines (CMM)	L-3-15
Quick Scope Manual Vision Measuring System	M-2
Quick Vision Series	M-4-10,12,13
UMAP Micro-form Measuring System	M-11



## MEASUREMENT OF GEARS

Page

### ■ ONE-DIMENSIONAL

Disk Micrometers	B-32-35
Gear Tooth Micrometers	B-36

### ■ TWO-DIMENSIONAL

Measuring Microscopes	I-15 - I-20
Profile Projectors	I-2 - I-11
QM-Data200	I-23 - I-24
Quick Image Non-contact 2D Vision Measuring System	M-3
Toolmakers' Microscopes	I-14
Vision Unit	I-25

### ■ THREE-DIMENSIONAL

Coordinate Measuring Machines (CMM)	L-3 - L-15
Quick Scope Manual Vision Measuring System	M-11
Quick Vision Series	M-2
UMAP Micro-form Measuring System	M-4 - M-12



## HARDNESS MEASUREMENT

Page

Durometers	K-14
Hardness Testing Machines	K-2-14



## MEASUREMENT ASSOCIATED WITH SEMICONDUCTOR/LCD FABRICATION

Page

### ■ ONE-DIMENSIONAL

ABSOLUTE Digimatic Calipers	D3-7,15,17,20-30
Dial Calipers	D-8,9
Dial Indicators	F-15-32
Dial Test Indicators	F-39-46
Digimatic Indicators	F-2-13
Digimatic Micrometers	B-2-8,18,20-24,27-29,31,32,34-36,38,45
Linear Gages	G-4-17
Litematic	G-27
Mu-Checker	G-30-33
Outside Micrometers	B-9,11-19
Outside Micrometers	B-9,11-19
Vernier Calipers	D-10-16,22-27,29

### ■ TWO-DIMENSIONAL

FS-70 Semiconductor Inspection Microscope Unit	I-26
Measuring Microscopes	I-16-22
Objectives and Eyepieces	I-28-32
Profile Projectors	I-2-11
QM-Data200	I-25,26
Quick Image Non-contact 2D Vision Measuring System	M-3
Toolmakers' Microscopes	I-16
Vision Unit	I-27
VMU Video Microscope Unit	I-29
Wide VMU	J-27

### ■ THREE-DIMENSIONAL

Quick Scope Manual Vision Measuring System	M-2
Quick Vision Series	M-4-10,12,13
UMAP Micro-form Measuring System	M-11





## DIGITAL READOUT AND POSITION FEEDBACK OF MACHINE TOOLS

Page

ABSOLUTE Digimatic Scale Units	H-2-5
Linear Gages	G-4-17
Linear Scale	H-10-29



## STATISTICAL PROCESS CONTROL

Page

Digimatic Mini-Processor DP-1VA	A-19
Input Tool	A-11
MeasurLink	A-2-10
Multiplexer MIG8USB, MIG4USB	A-17
USB Input Tool Direct: USB-ITN	A-12,13
U-Wave System	A14-16



## MEASUREMENT IN ROLL FORMING

Page

### ■ ONE-DIMENSIONAL

ABSOLUTE Digimatic Calipers	D3-7,15,17,20-30
Black Granite Surface Plates	E-45
Bore Gages	C-10-28
Dial Calipers	D-8,9
Dial Height Gages	D-42
Dial Indicators	F-15-32
Dial Test Indicators	F-39-46
Digimatic Height Gages	D-40,41,43,44
Digimatic Indicators	F-2-13
Digimatic Micrometers	B-2-8,18,20-24,27-29,31,32,34-36,38,45
Digital Outside Micrometers	B-42
Laser Scan Micrometers	G-36-43
Linear Gages	G-4-17
Mu-Checker	G-30-33
Outside Micrometers	B-9,11-19
QM-Height	D-38,39
Vernier Calipers	D-10-16,22-27,29
Vernier Height Gages	D-45,46

### ■ TWO-DIMENSIONAL

Linear Height	D-36,37
---------------	---------

### ■ THREE-DIMENSIONAL

Coordinate Measuring Machines (CMM)	L-3-15
Quick Vision Series	M-4-10,12,13
Roundtest	J-39-48
Surftest	J-2-13
UMAP Micro-form Measuring System	M-11

# NUMERICAL INDEX

Series No.	Description	Page
<b>0-99</b>		
0	Dial Indicators	F-15
0	Dial Indicators	F-16
1	Dial Indicators	F-17-19
1	Back Plunger Dial Indicators	F-31,32
2	Dial Indicators	F-20-27
2	Back Plunger Dial Indicators	F-31,32
3	Dial Indicators	F-28,29
4	Dial Indicators	F-30
7	Micro Jack	B-72
7	ABSOLUTE Digimatic/Dial Depth Gage	D-57,58
7	Thickness Gages	F-50-52
7	Dial/Test Indicator & Magnetic Stand Sets	F-60
7	Magnetic Stands	F-60
7	Dial Gage Stands	F-61

<b>100-199</b>		
101	Outside Micrometers	B-9
102	Ratchet-Thimble Micrometer	B-10
102	Outside Micrometers	B-11
103	Outside Micrometers	B-12-14
104	Outside Micrometers	B-15,16
105	Outside Micrometers	B-17
107	Outside Micrometers	B-19
110	Micrometer Heads	B-69
111	Spline Micrometers	B-20
112	Point Micrometers	B-21
112	Crimp Height Micrometers	B-22
113	Limit Micrometers	B-25
114	V-Anvil Micrometers	B-23,24
115	Spherical Face Micrometers	B-27
115	Tube Micrometers	B-28
116	Pana Micrometers	B-26
117	Uni-Mike	B-29
118	Sheet Metal Micrometers	B-30
119	Sheet Metal Micrometers	B-30
122	Blade Micrometers	B-31
123	Disk Micrometers	B-32-35
124	Gear-Tooth Micrometers	B-36
125	Screw Thread Micrometers	B-37
126	Screw Thread Micrometers	B-38
128	Depth Micrometer	D-51
129	Depth Micrometer	D-50
133	Tubular Inside Micrometers	C-11-12
137	Tubular Inside Micrometers	C-15
139	Tubular Inside Micrometers	C-16
140	Tubular Inside Micrometers	C-17
141	Inside Micrometers	C-13
142	Point Micrometers	B-21
142	Crimp Height Micrometers	B-22
143	Caliper-Type Micrometers	B-45
145	Inside Micrometers	C-18
146	Groove Micrometers	B-46
147	Can Seam Micrometers	B-40

Series No.	Description	Page
147	Hub Micrometers	B-41
147	Wire Micrometers	B-41
148	Micrometer Heads	B-58-63
149	Micrometer Heads	B-64
150	Micrometer Heads	B-65
151	Micrometer Heads	B-66
152	Micrometer Heads	B-68,70
153	Micrometer Heads	B-67,153
154	Small-Hole Gage Set	B-47
155	Telescoping Gage Set	B-47
156	Micrometer Stands	B-48
157	Optical Parallels	B-50
158	Optical Flats	B-50
160	Vernier Caliper	D-14
160	ABSOLUTE Digimatic & Vernier Caliper	D-15
164	Digimatic Micrometer Heads	B-56
167	Micrometer Standards	B-51
167	Standards for Screw Thread Micrometers	B-52
167	Standards for V-Anvil Micrometers	B-52
169	Disk Micrometers	B-32-35
169	Paper Thickness Micrometers	B-33
170	i-Checker	F-48
170	UDT-2 Dial Gage Testers	F-49
172	PH-A14	I-8,9
172	PH-3515F	I-10,11
172	Accessories for Profile Projectors	I-12
174	KA-200 Counter	H-7
174	KLD200 Counter	H-7
176	TM-505B/1005B Toolmakers' Microscopes	I-16
176	MF Measuring Microscopes	I-17,18
176	MF Motorized Type	I-19
176	MF-U High-power Multi-function	I-20,21
176	MF-U Motorized Type Universal	I-22
177	Setting Rings	C-29,30
178	Surftest SJ-210	J-2
178	Surftest SJ-310	J-3
178	Surftest SJ-210/310 Optional Accessories	J-4,5
178	Surftest SJ-410	J-6,7
178	Surftest SJ-500/P, SV-2100	J-8,9
178	Surftest SV-3200	J-10,11
178	Surftest Extreme SV-3000CNC	J-12
178	Surftest Extreme SV-M3000CNC	J-13
181	V-Block Sets	F-58
181	Magnetic V-Block	F-58
182	Standard Scales	E-32
182	Working Standard Scales	E-32
182	Steel Rules	E-34,35
182	Semi-Flexible Rules	E-35
183	Pocket Magnifiers	I-39
183	Pocket Comparators	I-39
183	Zoom Loupe	I-39
183	Clear Loupe	I-39
184	Thickness/Feeler Gages	E-36

Series No.	Description	Page
186	Radius Gages	E-39
186	Radius Gages-Sets	E-40
187	Digital Universal Protractor	E-37
187	Universal Bevel Protractor	E-38
187	Bevel Protractor	E-38
188	Pitch Gages	E-39
191	CRYSTA-Apex S 500/700/900/1200 Series 191 — Standard CNC	L-4, 5
191	CRYSTA-Apex EX 500T/700T/900T Series PH20-Equipped 5-Axis CNC CMM	L-6
191	CRYSTA-Apex EX 1200R Series — REVO-Equipped 5-Axis CNC CMM	L-7
191	CRYSTA-Apex S 1600/2000 Series 191 — Standard CNC CMM	L-8
192	Digimatic Height Gage	D-40,41
192	Dial Height Gage	D-42
193	Digital Outside Micrometers	B-42
196	CrystaPlus M Series 196 — Manual Floating CMM	L-3
197	Micrometer Heads	B-71

## 200-299

201	Dial Snap Gages	F-59
209	Digimatic Caliper Gages	F-54,55
209	Dial Caliper Gages	F-56,57
211	Roundtest RA-120 / 120P	J-39,40
211	Roundtest RA-1600 / RA-1600M	J-41,42
211	Roundtest RA-2200AS / DS / AH / DH	J-43,44
211	Roundtest RA-H5200AS / AH	J-45,46
211	Roundtest Extreme RA-2200CNC / RA-H5200CNC	J-47,48
215	Granite Comparator Stands	F-63
215	Comparator Stands	F-64
218	Contracer CV-2100	J-28,29
218	Contracer CV-3200 / CV-4500	J-30,31
223	Disk Micrometers	B-32-35
227	ABSOLUTE Digimatic Micrometers	B-7
227	Disk Micrometers	B-32-35
250	Micrometer Heads	B-72
264	Input Tools	A-11
264	DP-1VA	A-19
264	QM-Data200 2-D Processing Unit	I-25,26
293	Coolant-Proof Micrometer	B-2,3
293	Digimatic Micrometer	B-4
293	Digimatic Micrometer- MDC - Lite	B-4
293	MDH Micrometer	B-5
293	QuantuMike	B-6
293	Quickmike	B-8
295	Spherical Face Micrometers	B-27
295	Tube Micrometers	B-28

## 300-399

302	PJ-A3000-Vertical	I-2,3
303	PJ-H30-High Accuracy	I-4,5
304	PV-5110	I-6,7
311	CERA Straight Master SM-C	E-30
311	Square Master	E-31
311	High-Precision Square	E-33
314	V-Anvil Micrometers	B-23,24

Series No.	Description	Page
317	Uni-Mike	B-29
318	Litematic G-27	G-27
323	Disk Micrometers	B-32-35
324	Gear-Tooth Micrometers	B-36
326	Screw Thread Micrometers	B-38
329	Depth Micrometer	D-50
331	Spline Micrometers	B-20
337	Digimatic Tubular Inside Micrometers	C-14
339	Digimatic Tubular Inside Micrometers	C-14
340	Outside Micrometers	B-15,16
342	Point Micrometers	B-21
342	Crimp Height Micrometers	B-22
343	Caliper-Type Micrometers	B-45
345	Inside Micrometers	C-18
350	Digimatic Micrometer Heads	B-57
355	STRATO-Apex 500/700/900 Series 355 — High-Accuracy CNC CMM	L-9
355	STRATO-Apex 1600 Series 355 — High-Accuracy CNC CMM	L-10
355	FALCIO-Apex 2000/3000 Series 355 — High-Accuracy Large CNC CMM	L-11
356	LEGEX 500/700/900 Series 356 — Ultra-High Accuracy CNC CMM	L-12
359	Vision Unit System Retrofit	I-27
359	Quick Scope Series 359 — Manual Vision Measuring System	M-2
360	MACH-V 9106 Series 360 — Inline CNC CMM	L-13
360	MACH-3A 653 Series 360 — Inline CNC CMM	L-13
360	MACH KO-GA-ME Series 360 — Inline CNC CMM	L-14
361	Quick Image Series 361 — Non-contact 2D Vision Measuring System	M-3
363	QV Apex Series 363 — CNC Vision Measuring System	M-5
363	QV Stream Plus Series 363 — CNC Vision Measuring System	M-6
363	QV Hyper Series 363 — High-Accuracy CNC Vision Measuring System	M-7
363	QV-WLI Series 363 — CNC Video Measuring System with White Light Interferometry	M-9
363	ULTRA QV Series 363 — Ultra-High Accuracy CNC Vision Measuring System	M-10
363	QV ACCEL Series 363 — Large-Format CNC Vision Measuring System	M-12
364	UMAP Vision System TYPE2 Series 364 — Micro Form Measuring System	M-11
365	QV Hybrid Type 1, Type 4 Series 365 — CNC Vision Measuring System	M-8
368	Holtest	C-4,5
368	Holtest (Type II)	C-6,7
368	Holtest/Digimatic Holtest/Borematic	C-10
369	Disk Micrometers	B-32-35
377	MSM-400 Stereo Microscopes	I-35-38
378	FS-70 For Semiconductor Inspection	I-28
378	VMU Video Microscope Unit	I-29
378	Eyepieces	I-30
378	Objectives	I-30-34
389	Sheet Metal Micrometers	B-30
395	Spherical Face Micrometers	B-27
395	Tube Micrometers	B-28

# NUMERICAL INDEX

Series No.	Description	Page
<b>400-499</b>		
406	Outside Micrometers	B-18
422	Blade Micrometers	B-31
468	Digimatic Holtest	C-2,3
468	Holtest/Digimatic Holtest/Borematic	C-10
<b>500-599</b>		
500	Super Caliper-Solar Powered	D-2
500	ABSOLUTE Solar Caliper	D-3
500	ABSOLUTE Coolant-Proof Caliper	D-4,5
500	ABSOLUTE Digimatic Caliper	D-6,7
505	Dial Caliper	D-8,9
510	Indicating Micrometers	B-43
511	Bore Gages	C-20-26,28
511	ABSOLUTE Digimatic Bore Gage	C-27
513	Dial Test Indicators	F-39-43
513	Pocket Dial Test Indicators	F-44,45
513	Dial Test Indicators	F-46
514	Vernier Height Gage	D-45,46
515	Inside Micro Checker	C-19
515	Bore Gage Zero Checker	C-29
515	CERA Caliper Checker	D-49
515	Depth Micro Checker	D-51
515	Height Master	E-25
515	Digital Height Master	E-26
515	Riser Blocks	E-27
515	Auxiliary Block Kit	E-27
515	Universal Height Master	E-28
515	High-Accuracy Check Master HMC-H	E-29
516	Gage Blocks	E-2-4
516	Metric Rectangular Gage Block Set	E-5,6
516	Inch Rectangular Gage Block Set	E-7
516	Micrometer Inspection Gage Block Sets	E-8
516	Bore Gage Calibration Kit	E-8
516	Rectangular Gage Block Accessories	E-13-15
516	Metric Square Gage Block Set	E-16
516	Inch Square Gage Block Set	E-17
516	Square Gage Block Accessories	E-20,21
516	Maintenance Kit for Gage Block	E-22
516	Step Master	E-23
517	Granite Surface Plate Accessories	E-43
517	Black Granite Surface Plate	E-44,45
517	Steel Stands	E-45
517	Precision Granite Stands	F-65
518	QM-Height	D-38,39
519	Transfer Stands	F-62
519	Mu-checker Probes	G-30,31
519	Mu-checker	G-32,33
521	Calibration Testers	F-49
523	Snap Meters	B-43
523	Dial Snap Meters	B-44
525	Formtracer SV-C3200 / SV-C4500	J-14,15
525	Formtracer Extreme SV-C4500CNC	J-16,17
525	Formtracer CS-3200	J-18,19

Series No.	Description	Page
525	Formtracer Extreme CS-5000CNC / CS-H5000CNC	J-20,21
526	Bore Gages	C-28
527	Vernier Depth Gage	D-54,55
527	Dial-Depth Gage	D-56
529	Linear Scales AT216-T / AT217-TL	H-25
530	Vernier Caliper	D-10,11
531	Vernier Caliper	D-12
532	Vernier Caliper	D-13
534	Long-Jaw Vernier Caliper	D-16
536	Offset Caliper	D-22
536	Offset Centerline Caliper	D-23
536	Point Caliper	D-24
536	Blade-Type Caliper	D-25
536	Neck Caliper	D-26
536	Tube Thickness Caliper	D-27
536	Scribing Caliper	D-29
536	ABSOLUTE Inside Caliper	D-30,31
539	Linear Scales ABS AT1100	H-12
539	Linear Scales ABS AT300	H-13
539	Linear Scales ABS AT715	H-14
539	Linear Scales ABS AT500	H-15
539	Linear Scales AT103	H-19
539	Linear Scales AT113	H-20
539	Linear Scales AT112-F	H-21
539	Linear Scales AT116	H-22
539	Linear Scales AT402E	H-23
539	Linear Scales AT203	H-24
539	AT211-A (Multipoint mounting), AT211-B (Double-end mounting)	H-26
539	Pulse Signal Interface Unit PSU-200	H-32
539	Signal Conversion Adapter PSU-400E	H-33
542	EC Counter	A-18
542	EC Counter	F-14
542	Linear Gage LGK	G-4
542	Linear Gage LGF	G-5
542	Linear Gage LGF-Z	G-6
542	Linear Gage LGB-Slim	G-7
542	Linear Gage LGB2-Slim	G-8,9
542	Linear Gage LG-Long Range	G-10,11
542	Linear Gage LGF-High Resolution	G-15
542	Linear Gage LGB2-High Resolution	G-16
542	Linear Gage LGH-High Resolution	G-17
542	Laser Hologage LGH-High Resolution	G-18
542	EH Counter-Multi Function	G-19
542	EC Counter-Single-function	G-20
542	EG Counter-Single-function	G-21
542	EB Counter-Single-function	G-22
542	EV Counter-Multi-function	G-23
542	EV Counter System Configuration	G-24
543	ABSOLUTE Solar Digimatic Indicator ID-S	F-2,3
543	ABSOLUTE Digimatic Indicator ID-C	F-5,6
543	ABSOLUTE Digimatic Indicator ID-C Calculation Type	F-7
543	ABSOLUTE Digimatic Indicator ID-C With Max./Min. Value Holding Function	F-8

Series No.	Description	Page
543	ABSOLUTE Digimatic Indicator ID-C Specially Designed for Bore Gage Application	F-9
543	ABSOLUTE Digimatic Indicator ID-C With Green/Red LED and Go/No-go Signal Output Function	F-10
543	ABSOLUTE Digimatic Indicator ID-H	F-11
543	ABSOLUTE Digimatic Indicator ID-F	F-12
543	ABSOLUTE Digimatic Indicator ID-N / B	F-13
544	Laser Scan Micrometer Selection Guide	G-34,35
544	Laser Scan Micrometer LSM-6902H	G-36
544	Laser Scan Micrometer LSM-500S	G-37
544	Laser Scan Micrometer LSM-501S	G-38
544	Laser Scan Micrometer LSM-503S	G-39
544	Laser Scan Micrometer LSM-506S	G-40
544	Laser Scan Micrometer LSM-512S	G-41
544	Laser Scan Micrometer LSM-516S	G-42
544	Laser Scan Micrometer LSM-9506	G-43
544	LSM-6200 Display Unit	G-44
544	LSM-5200 Display Unit	G-45
544	Laser Scan Micrometer Optional Accessories	G-46-49
546	Dial Tension Gages	F-58
547	ABSOLUTE Digimatic/Dial Depth Gage	D-57,58
547	Thickness Gages	F-50-52
549	MICSYS	H-18
550	ABSOLUTE Digimatic & Vernier Caliper	D-15
551	ABSOLUTE Digimatic Caliper	D-17
552	Digimatic Carbon-Fiber Caliper	D-18,19
552	ABSOLUTE Coolant-Proof Carbon-Fiber Caliper	D-20
565	Gage Block Comparator GBGD-250	E-24
565	Gage Block Comparator GBGD-100A	E-24
568	Borematic	C-8,9
568	Holtest/Digimatic Holtest/Borematic	C-10
570	ABSOLUTE Digimatic Height Gage	D-43,44
571	Tire Tread Depth Gage	D-53
571	ABSOLUTE Point-Type Digimatic Depth Gage	D-53
571	ABSOLUTE Digimatic Depth Gage	D-55
572	SD ABSOLUTE Digimatic Scale Units	H-2,3
572	ABSOLUTE Digimatic Scale Units	H-4,5
573	ABSOLUTE Back-Jaw Centerline Caliper	D-21
573	Offset Caliper	D-22
573	Offset Centerline Caliper	D-23
573	Point Caliper	D-24
573	Blade-Type Caliper	D-25
573	Neck Caliper	D-26
573	Tube Thickness Caliper	D-27
573	ABSOLUTE Low-Force Caliper	D-28
573	ABSOLUTE Snap Caliper	D-28
573	Scribing Caliper	D-29
573	ABSOLUTE Inside Caliper	D-30,31
575	ABSOLUTE Digimatic Indicator ID-U	F-4
575	Linear Gage LGD	G-12,13
575	Linear Gage LGS	G-14
579	Linear Scales ABS ST700	H-16
579	Linear Scales ABS ST1300	H-17
579	Linear Scales ST422	H-27

Series No.	Description	Page
579	Linear Scales ST46-EZA	H-28
579	Linear Scales ST36	H-29
579	Fiber Scale ST-F11	H-30,31

## 700-799

700	Quick-Mini	F-53
-----	------------	------

## 800-899

810	HM-210 / 220 Type A	K-3
810	HM-200 Series with AVPAK Software	K-4
810	MZT-500	K-5
810	HV-110 / 120	K-6,7
810	HR-530/530L	K-9
810	HR-523/523L	K-10
810	Hardmatic HH-411	K-13
811	Hardmatic HH-300	K-14

## 900-999

950	Spring Dividers and Calipers	E-33
950	Thickness/Feeler Gages	E-36
950	Pitch Gages	E-39
950	Digital Protractor	E-41
960	Precision Levels	E-36
967	Bench Center	E-43
982	Multiplexers – MIG-8USB, MIG-4USB	A-17
982	Digital Hand Tachometers	E-42
811	Hardmatic HH-300	K-14
950	Digital Protractor	E-42
950	Spring Dividers and Calipers	E-33
950	Pitch Gages	E-40
950	Thickness Gages	E-37
960	Precision Levels	E-37
963	HR-320MS / 430MR / 430MS	K-10
967	Bench Center	E-44
982	Digital Hand Tachometers	E-43
982	Multiplexers – MIG-8USB, MIG-4USB	A-16
7000	Dial Indicator Crystal Setter	F-38
7000	Dial Indicator Repair Tool Kit	F-38

# ALPHABETICAL INDEX

Description	Series No.	Page
<b>A</b>		
ABSOLUTE Back-Jaw Centerline Caliper	573	D-21
ABSOLUTE Coolant-Proof Caliper	500	D-4,5
ABSOLUTE Coolant-Proof Carbon-Fiber Caliper	552	D-20
ABSOLUTE Digimatic & Vernier Caliper	550	D-15
ABSOLUTE Digimatic & Vernier Caliper	160	D-15
ABSOLUTE Digimatic Bore Gage	511	C-27
ABSOLUTE Digimatic Caliper	500	D-6,7
ABSOLUTE Digimatic Caliper	551	D-17
ABSOLUTE Digimatic Depth Gage	571	D-55
ABSOLUTE Digimatic Height Gage	570	D-43,44
ABSOLUTE Digimatic Indicator ID-C	543	F-5,6
ABSOLUTE Digimatic Indicator ID-C Calculation Type	543	F-7
ABSOLUTE Digimatic Indicator ID-C Specially Designed for Bore Gage Application	543	F-9
ABSOLUTE Digimatic Indicator ID-C With Green/Red LED Go/No-go Signal Output Function	543	F-10
ABSOLUTE Digimatic Indicator ID-C With Max./Min. Value Holding Function	543	F-8
ABSOLUTE Digimatic Indicator ID-F	543	F-12
ABSOLUTE Digimatic Indicator ID-H	543	F-11
ABSOLUTE Digimatic Indicator ID-N / B	543	F-13
ABSOLUTE Digimatic Indicator ID-U	575	F-4
ABSOLUTE Digimatic Micrometers	227	B-7
ABSOLUTE Digimatic/Dial Depth Gage	547	D-57,58
ABSOLUTE Digimatic/Dial Depth Gage	7	D-57,58
ABSOLUTE Inside Caliper	573	D-30,31
ABSOLUTE Inside Caliper	536	D-30,31
ABSOLUTE Low-Force Caliper	573	D-28
ABSOLUTE Point-Type Digimatic Depth Gage	571	D-53
ABSOLUTE Snap Caliper	573	D-28
ABSOLUTE Solar Caliper	500	D-3
ABSOLUTE Solar Digimatic Indicator ID-S	543	F-2,3
ABSOLUTE Digimatic Scale Units	572	H-4,5
Accessories for Measuring Microscope		I-23,24
Accessories for Profile Projectors	172	I-12
Accessories for Quick Vision		M-14
AT211-A (Multipoint mounting), AT211-B (Double-end mounting)	539	H-26
Auxiliary Block Kit	515	E-27
<b>B</b>		
Back Plunger Dial Indicators	1, 2	F-31,32
Backs		F-33
Bench Center	967	E-43
Bevel Protractor	187	E-38
Black Granite Surface Plate	517	E-44,45
Blade Micrometers	422	B-31
Blade Micrometers	122	B-31
Blade-Type Caliper	573	D-25
Blade-Type Caliper	536	D-25

Description	Series No.	Page
Bore Gage Calibration Kit	516	E-8
Bore Gage Zero Checker	515	C-29
Bore Gages	511	C-20-27
Bore Gages	526	C-28
Borematic	568	C-8,9
<b>C</b>		
Calibration Testers	521	F-49
Caliper-Type Micrometers	343	B-45
Caliper-Type Micrometers	143	B-45
Can Seam Micrometers	147	B-40
CARBapex / CARBstrato Series – Car Body Measuring System CNC CMM		L-15
Carbide-Tipped Scriber		D-47
Center-Line Gage		D-33
CERA Caliper Checker	515	D-49
CERA Straight Master SM-C	311	E-30
Ceraston		E-22
Clear Loupe	183	I-39
CMM Probe & Change Rack Options – Motorized Probe Heads	Probes	L-21
CMM Probe & Change Rack Options – TouchTrigger Probe System	Probes	L-20
CMM Surface Roughness Measuring – CMM SurfTest Probe	Probes	L-27
Color Ratchet & Color Speeder		B-49
Color Spindle Caps		F-37
Comparator Stands	215	F-64
Contact Points		F-34,35
Contact Points and Clamp Holders		F-47
Contracer CV-2100	218	J-28,29
Contracer CV-3200 / CV-4500	218	J-30,31
Coolant-Proof Micrometer	293	B-2,3
Crimp Height Micrometers	342	B-22
Crimp Height Micrometers	142	B-22
Crimp Height Micrometers	112	B-22
CRYSTA-Apex EX 1200R Series — REVO-Equipped 5-Axis CNC CMM	191	L-7
CRYSTA-Apex EX 500T/700T/900T Series PH20-Equipped 5-Axis CNC CMM	191	L-6
CRYSTA-Apex S 1600/2000 Series 191 — Standard CNC CMM	191	L-8
CRYSTA-Apex S 500/700/900/1200 Series 191 — Standard CNC	191	L-4, 5
CrystaPlus M Series 196 — Manual Floating CMM	196	L-3
<b>D</b>		
Depth Base Attachment		D-33
Depth Micro Checker	515	D-51
Depth Micrometer	329	D-50
Depth Micrometer	129	D-50
Depth Micrometer	128	D-51
D-EV Display Unit		G-25
Dial Caliper	505	D-8,9

Description	Series No.	Page
Dial Caliper Gages	209	F-56,57
Dial Crystal Setter		F-38
Dial Gage Stands	7	F-61
Dial Height Gage	192	D-42
Dial Indicator Repair Tool Kit		F-38
Dial Indicators	0	F-16
Dial Indicators	1	F-17-19
Dial Indicators	2	F-20-27
Dial Indicators	3	F-28,29
Dial Indicators	4	F-30
Dial Snap Gages	201	F-59
Dial Snap Meters	523	B-44
Dial Tension Gages	546	F-58
Dial Test Indicators	513	F-39-43
Dial Test Indicators	513	F-46
Dial/Test Indicator & Magnetic Stand Sets	7	F-60
Dial-Depth Gage	527	D-56
Digimatic Caliper Gages	209	F-54,55
Digimatic Carbon-Fiber Caliper	552	D-18,19
Digimatic Height Gage	192	D-40,41
Digimatic Holtest	468	C-2,3
Digimatic Micrometer	293	B-4
Digimatic Micrometer Heads	164	B-56
Digimatic Micrometer Heads	350	B-57
Digimatic Micrometer- MDC- Lite	293	B-4
Digimatic Tubular Inside Micrometers	337	C-14
Digimatic Tubular Inside Micrometers	339	C-14
Digital Hand Tachometers	982	E-42
Digital Height Master	515	E-26
Digital Outside Micrometers	193	B-42
Digital Protractor	950	E-41
Digital Readout/ DRO packages 2-Axis/3-Axis Travels		H-9
Digital Universal Protractor	187	E-37
Disk Micrometers	323,223,123	B-32-35
Disk Micrometers	369,227,169	B-32-35
DP-1VA	264	A-19
<b>E</b>		
EB Counter-Single-function	542	G-22
EC Counter	542	F-14
EC Counter-Single-function	542	G-20
EC Counter	542	A-18
Eco-Fix Kit Form-S & L		J-52
EG Counter-Single-function	542	G-21
EH Counter-Multi Function	542	G-19
EV Counter System Configuration	542	G-24
EV Counter-Multi-function	542	G-23
Extension Bases		D-56
Eyepieces	378	I-30

Description	Series No.	Page
<b>F</b>		
FALCIO-Apex 2000/3000 Series 355 — High-Accuracy Large CNC CMM	355	L-11
Fiber Scale ST-F11	579	H-30,31
Fixtures for Micrometer Heads and Linear Gages		B-74,75
Formtracer CS-3200	525	J-18,19
Formtracer Extreme CS-5000CNC / CS-H5000CNC	525	J-20,21
Formtracer Extreme SV-C4500CNC	525	J-16,17
Formtracer SV-C3200 / SV-C4500	525	J-14,15
FS-70 For Semiconductor Inspection	378	I-28
<b>G</b>		
Gage Block Comparator GBCD-100A	565	E-24
Gage Block Comparator GBCD-250	565	E-24
Gage Blocks	516	E-2-4
Gage Heads / Display Units Selection Guide		G-2,3
Gage Selector 3		A-18
Gear-Tooth Micrometers	324	B-36
Gear-Tooth Micrometers	124	B-36
Granite Comparator Stands	215	F-63
Granite Surface Plate Accessories	517	E-43
Groove Micrometers	146	B-46
<b>H</b>		
Hardmatic HH-300	811	K-14
Hardmatic HH-300 Test Block Set		K-15
Hardmatic HH-411	810	K-13
Height Master	515	E-25
High-Accuracy Check Master HMC-H	515	E-29
High-Precision Square	311	E-33
HM-200 Series with AVPAK Software	810	K-4
HM-210 / 220 Type A	810	K-3
Holtest	368	C-4,5
Holtest (Type II)	368	C-6,7
Holtest/Digimatic Holtest/Borematic	368,468,568	C-10
HR-523/523L	810	K-10
HR-530/530L	810	K-9
Hub Micrometers	147	B-41
HV-110 / 120	810	K-6,7
<b>I</b>		
i-Checker	170	F-48
Inch Rectangular Gage Block Set	516	E-7
Inch Square Gage Block Set	516	E-17
Indicating Micrometers	510	B-43
Individual Inch Rectangular Gage Block		E-11
Individual Inch Square Gage Block		E-19
Individual Metric Rectangular Gage Block		E-9,10
Individual Metric Square Gage Block		E-18

# ALPHABETICAL INDEX

Description	Series No.	Page
Input Tools	264	A-11
Inside Micro Checker	515	C-19
Inside Micrometers	141	C-13
Inside Micrometers	345, 145	C-18
Interface for LSM6200, LSM 6900		G-48
<b>K</b>		
KA-200 Counter	174	H-7
KLD200 Counter	174	H-7
<b>L</b>		
Laser Hologage LGH-High Resolution	542	G-18
Laser Scan Micrometer LSM-500S	544	G-37
Laser Scan Micrometer LSM-501S	544	G-38
Laser Scan Micrometer LSM-503S	544	G-39
Laser Scan Micrometer LSM-506S	544	G-40
Laser Scan Micrometer LSM-512S	544	G-41
Laser Scan Micrometer LSM-516S	544	G-42
Laser Scan Micrometer LSM-6902H	544	G-36
Laser Scan Micrometer LSM-9506	544	G-43
Laser Scan Micrometer Optional Accessories	544	G-46-49
Laser Scan Micrometer Selection Guide	544	G-34,35
LEGEX 500/700/900 Series 356 — Ultra-High Accuracy CNC CMM	356	L-12
Limit Micrometers	113	B-25
Limit Stickers		F-37
Linear Gage LGB2-High Resolution	542	G-16
Linear Gage LGB2-Slim	542	G-8,9
Linear Gage LGB-Slim	542	G-7
Linear Gage LGD	575	G-12,13
Linear Gage LGF	542	G-5
Linear Gage LGF-High Resolution	542	G-15
Linear Gage LGF-Z	542	G-6
Linear Gage LGH-High Resolution	542	G-17
Linear Gage LGK	542	G-4
Linear Gage LG-Long Range	542	G-10,11
Linear Gage LGS	575	G-14
Linear Height LH-600E		D-36,37
Linear Scales ST36	579	H-29
Linear Scale Counter		H-8
Linear Scales ABS AT1100	539	H-12
Linear Scales ABS AT300	539	H-13
Linear Scales ABS AT500	539	H-15
Linear Scales ABS AT715	539	H-14
Linear Scales ABS ST1300	579	H-17
Linear Scales ABS ST700	579	H-16
Linear Scales AT103	539	H-19
Linear Scales AT112-F	539	H-21
Linear Scales AT113	539	H-20
Linear Scales AT116	539	H-22
Linear Scales AT203	539	H-24

Description	Series No.	Page
Linear Scales AT216-T / AT217-TL	529	H-25
Linear Scales AT402E	539	H-23
Linear Scales ST422	579	H-27
Linear Scales ST46-EZA	579	H-28
Linear Scales System Diagram		H-10,11
Lineup of Hardness Testing Machines		K-2
Litematic G-27	318	G-27
Long-Jaw Vernier Caliper	534	D-16
LSM-5200 Display Unit	544	G-45
LSM-6200 Display Unit	544	G-44
<b>M</b>		
MACH KO-GA-ME Series 360 – Inline CNC CMM	360	L-14
MACH-3A 653 Series 360 – Inline CNC CMM	360	L-13
MACH-V 9106 Series 360 – Inline CNC CMM	360	L-13
Made-to-Order Block & Reference		E-23
Magnetic Stands	7	F-60
Magnetic V-Block	181	F-58
Maintenance Kit for Gage Block	516	E-22
MCOSMOS Software for Manual / CNC Coordinate Measuring Machines		L-16,17
MDH Micrometer	293	B-5
MeasurLink		A-2-10
Metric Rectangular Gage Block Set	516	E-5,6
Metric Square Gage Block Set	516	E-16
MF Measuring Microscopes	176	I-17,18
MF Motorized Type	176	I-19
MF-U High-power Multi-function	176	I-20,21
MF-U Motorized Type Universal	176	I-22
MiCAT Planner — Automatic Measurement Program Generation Software		L-18,19
Micro Jack	7	B-72
Micrometer Head Selection Guide		B-55
Micrometer Heads	148	B-58-63
Micrometer Heads	149	B-64
Micrometer Heads	150	B-65
Micrometer Heads	151	B-66
Micrometer Heads	153	B-67
Micrometer Heads	152	B-68,70
Micrometer Heads	110	B-69
Micrometer Heads	197	B-71
Micrometer Heads	250	B-72
Micrometer Heads for Profile Projectors and Toolmakers' Microscopes		I-12
Micrometer Inspection Gage Block Sets	516	E-8
Micrometer Oil		B-49
Micrometer Standards	167	B-51
Micrometer Stands	156	B-48
MICSYS	549	H-18
Mitutoyo CMM Accuracy Statements		L-2
Mitutoyo ECO-FIX Kit Fixture Systems		L-29
Mitutoyo Styli Kits		L-28



Description	Series No.	Page
MSM-400 Stereo Microscopes	377	I-35-38
MSURF Software for Manual / CNC Coordinate Measuring Machines		L-24,25
Mu-checker	519	G-32,33
Mu-checker Probes	519	G-30,31
Multiplexers – MIG-8USB, MIG-4USB	982	A-17
MyCAL-Lite		D-32
MZT-500	810	K-5

## N

Neck Caliper	536,573	D-26
Neck Caliper	536	D-26
Non-Contact CMM Probe Options – QVP Quick Vision Probe		L-26
Non-Contact CMM Probe Options – SurfaceMeasure 606/610/1010/606T/201FS		L-22,23

## O

Objectives	378	I-30-34
Offset Caliper	536,573	D-22
Offset Centerline Caliper	536,573	D-23
Optical Flats	158	B-50
Optical Parallels	157	B-50
OPTI-FIX Kits — Modular Clamping System for Vision Measuring Systems		M-15-17
Optional Accessories for Automatic Measurement		J-24
Optional Accessories for Automatic Measurement		J-35
Optional Accessories for Contracer / Formtracer		J-36
Optional Accessories for Height Gages		D-47
Optional Accessories For Rockwell/Rockwell Superficial Hardness Testing Machine		K-11,12
Optional Accessories for Roundtest		J-51
Optional Accessories for Surftest / Formtracer		J-25
Optional Accessories Micro-Vickers/Vickers Hardness Testing Machine		K-8
Optional Arms and Styli for Contour Measurement		J-32-34
Optional Styli for Roundtest		J-49,50
Optional Styli for Surface Roughness Measurement		J-22,23
Outside Micrometers	101	B-9
Outside Micrometers	102	B-11
Outside Micrometers	103	B-12-14
Outside Micrometers	340,104	B-15,16
Outside Micrometers	105	B-17
Outside Micrometers	406	B-18
Outside Micrometers	107	B-19
Overlay Chart Set		I-14

## P

Pana Micrometers	116	B-26
Paper Thickness Micrometers	169	B-33
PH-3515F	172	I-10,11
PH-A14	172	I-8,9
Pitch Gages	188,950	E-39
PJ-A3000-Vertical	302	I-2,3
PJ-H30-High Accuracy	303	I-4,5

Description	Series No.	Page
Pocket Comparators	183	I-39
Pocket Dial Test Indicators	513	F-44,45
Pocket Magnifiers	183	I-39
Point Caliper	573,536	D-24
Point Micrometers	112,142,342	B-21
Precision Granite Stands	517	F-65
Precision Lead Screw		B-73
Precision Levels	960	E-36
Pulse Signal Interface Unit PSU-200	539	H-32,33
PV-5110	304	I-6,7

## Q

QM-Data 200 2-D Processing Unit	264	I-25,26
QM-Height	518	D-38,39
QuantuMike	293	B-6
Quick Guide to Precision Measuring Instruments		B-76
Quick Guide to Precision Measuring Instruments - Calipers		D-34,35
Quick Guide to Precision Measuring Instruments - Hardness Testing Machines		K-16,17
Quick Guide to Precision Measuring Instruments - Height Gages		D-48
Quick Guide to Precision Measuring Instruments - Profile Projectors		I-15
Quick Guide to Precision Measuring Instruments - Linear Scales		H-34,35
Quick Guide to Precision Measuring Instruments - Contracer		J-37,38
Quick Guide to Precision Measuring Instruments - Laser Scan Micrometers		G-51
Quick Guide to Precision Measuring Instruments - Linear Gages		G-28,29
Quick Guide to Precision Measuring Instruments - Microscopes		I-40,41
Quick Guide to Precision Measuring Instruments - Roundtest		J-53,54
Quick Guide to Precision Measuring Instruments - Surftest		J-26,27
Quick Image Series 361 — Non-contact 2D Vision Measuring System	361	M-3
Quick Scope Series 359 — Manual Vision Measuring System	359	M-2
Quick Guide to Precision Measuring Instruments		M-18,19
Quick Vision with Touch-Trigger Probe		M-13
Quickmike	293	B-8
Quick-Mini	700	F-53
Quill Kit with Absolute Encoder		H-6
QV ACCEL Series 363 — Large-Format CNC	363	M-12
QV Hybrid Type 1, Type 4 Series 365 — CNC Vision Measuring System with a Noncontact Displacement Sensor	365	M-8
QV Hyper Series 363 — High-Accuracy CNC Vision Measuring System	363	M-7
QV Stream Plus Series 363 — CNC Vision Measuring System	363	M-6
QV Active Compact CNC Vision Measuring Systems		M-4
QV Apex Series 363 — CNC Vision Measuring System	363	M-5
QV-WLI Series 363 — CNC Video Measuring System with White Light Interferometry	363	M-9

# ALPHABETICAL INDEX

Description	Series No.	Page
<b>R</b>		
Radius Gages	186	E-39
Radius Gages-Sets	186	E-40
Ratchet-Thimble Micrometer	102	B-10
Rectangular Gage Block Accessories	516	E-13-15
Rectangular Gage Block with CTE		E-12
Riser Blocks	515	E-27
Roundtest Extreme RA-2200CNC / RA-H5200CNC	211	J-47,48
Roundtest RA-120 / 120P	211	J-39,40
Roundtest RA-1600 / RA-1600M	211	J-41,42
Roundtest RA-2200AS / DS / AH / DH	211	J-43,44
Roundtest RA-H5200AS / AH	211	J-45,46
<b>S</b>		
Screw Thread Micrometers	125	B-37
Screw Thread Micrometers	126,326	B-38
Scribing Caliper	573	D-29
Scribing Caliper	536	D-29
SD ABSOLUTE Digimatic Scale Units	572	H-2,3
Semi-Flexible Rules	182	E-35
Sensopak Software		G-26
Setting Rings	177	C-29,30
Sheet Metal Micrometers	118,119,389	B-30
Signal Conversion Adapter PSU-400E	539	H-33
Small-Hole Gage Set	154	B-47
Snap Meters	523	B-43
SPC Connecting Cables		A-20
Spherical Face Micrometers	115,295,395	B-27
Spindle Attachment Tip		B-49
Spindle Lifting Lever and Cable		F-36
Spline Micrometers	111,331	B-20
Spring Dividers and Calipers	950	E-33
Square Gage Block Accessories	516	E-20,21
Square Master	311	E-31
Standard Scales	182	E-32
Standards for Screw Thread Micrometers	167	B-52
Standards for V-Anvil Micrometers	167	B-52
Steel Rules	182	E-34,35
Steel Stands	517	E-45
Step Master	516	E-23
STRATO-Apex 1600 Series 355 — High-Accuracy CNC CMM	355	L-10
STRATO-Apex 500/700/900 Series 355 — High-Accuracy CNC CMM	355	L-9
Super Caliper-Solar Powered	500	D-2
Surftest Extreme SV-3000CNC	178	J-12
Surftest Extreme SV-M3000CNC	178	J-13
Surftest SJ-210	178	J-2
Surftest SJ-210/310 Optional Accessories	178	J-4,5
Surftest SJ-310	178	J-3
Surftest SJ-410	178	J-6,7

Description	Series No.	Page
Surftest SJ-500/P, SV-2100	178	J-8,9
Surftest SV-3200	178	J-10,11
<b>T</b>		
Telescoping Gage Set	155	B-47
Thickness Gages	547, 7	F-50-52
Thickness/Feeler Gages	950,184	E-36
Tire Tread Depth Gage	571	D-53
TM-505B/1005B Toolmakers' Microscopes	176	I-16
Tool Kits		B-53,54
Transfer Stands	519	F-62
Tube Micrometers	115,295,395	B-28
Tube Thickness Caliper	573,536	D-27
Tubular Inside Micrometers	133	C-11,12
Tubular Inside Micrometers	137	C-15
Tubular Inside Micrometers	139	C-16
Tubular Inside Micrometers	140	C-17
<b>U</b>		
UDT-2 Dial Gage Testers	170	F-49
ULTRA QV Series 363 — Ultra-High Accuracy CNC Vision Measuring System	363	M-10
UMAP Vision System TYPE2 Series 364 — Micro Form Measuring System	364	M-11
Uni-Mike	317,117	B-29
Universal Bevel Protractor	187	E-38
Universal Height Master	515	E-28
USB Input Tool Direct: USB-ITN		A-12,13
U-WAVE Fit		A-16
U-WAVE		A-14,15
<b>V</b>		
V-Anvil Micrometers	114,314	B-23,24
V-Block Sets	181	F-58
Vernier Caliper	530	D-10,11
Vernier Caliper	531	D-12
Vernier Caliper	532	D-13
Vernier Caliper	160	D-14
Vernier Depth Gage	527	D-54,55
Vernier Height Gage	514	D-45,46
Vision Unit System Retrofit	359	I-27
VMU Video Microscope Unit	378	I-29
<b>W</b>		
Wire Micrometers	147	B-41
Working Standard Scales	182	E-32
Workpiece Fixtures for Profile Projectors and Measuring Microscopes		I-13
<b>Z</b>		
Zero CERA Blocks		E-12
Zoom Loupe	183	I-39
3-Wire Thread Measuring System		B-39



### In the Spirit of Mitutoyo

To become a complete man, one must acquire Wisdom, Benevolence and Valor. With Wisdom only, one tends to be cold. Benevolence alone makes one weaker. With valor only, one may reach beyond his capabilities. When the three qualities are combined, however, one will become a complete man. Similarly, success in enterprise lies in the knowledge of Heaven, Earth and Man. Business will succeed only when these factors, "heavensent" chances, natural opportunities, and harmony of man are present. Without even one factor, success is remote. In Buddhism, Butsu (Buddha), Po (Doctrine) and So (Priest) are three principle treasures for its promotion of the teaching. In Christianity, God, Bible and Minister.

The word MITUTOYO signifies three abundances. "Mitsu" means three, while "Toyo" stands for a state of abundance. The name MITUTOYO was selected, with a sincere wish to see more complete men, to create a prosperous enterprise and to introduce righteous religion to all, along with the lasting wish for a peaceful world and fulfillment of meaningful life.



## Mitutoyo America Corporation

965 Corporate Blvd.  
Aurora, Illinois 60502  
Phone: (630) 820-9666  
Fax: (630) 978-3501  
Email: [info@mitutoyo.com](mailto:info@mitutoyo.com)  
[www.mitutoyo.com](http://www.mitutoyo.com)

For customer support call toll free:  
1-888-MITUTOYO (1-888-648-8869)

© 2018 Mitutoyo America Corporation

Distributed by:

