

Mitutoyo

Mitutoyo Quality

Profile Projector PJ/PV/PH Series

Optical Measuring



Bulletin No. 2300

Projector PJ/PV/PH Series

Each Mitutoyo profile projector measuring machine efficiently performs measurements, inspections and observations by projecting an image of a test workpiece on the stage onto a viewing screen under accurate magnification. The inherently non-contact measurement method of profile projectors makes this type of instrument highly suitable for measuring small parts that are unmeasurable with general-purpose contact instruments or plastic parts that are easily deformed. A profile projector can also be used to observe the surface profiles of workpieces or inspect minute assemblies with surface illumination. Additionally, a wide selection of accessories allows advanced measurement and inspection of various types of workpieces. These machines can be installed and used in a wide range of environments from inspection rooms to manufacturing and processing sites.

Provides reliable measurements in manufacturing site environments.



PJ-PLUS Series



PJ-H30 Series



PV-5110 Series

PJ Series

Screen diameter
300mm / 11.81"

- Available in 2 types: PJ-PLUS (white LED light source) and PJ-H30 (high accuracy)
- Broad lineup of stages for handling minute parts to large workpieces
- Controls centered at the front for better operability



PV Series

Screen diameter
508mm / 20"

- Equipped with a large forward-tilted screen
- Perfect for comparative measurements with enlarged drawings and tracing of projected images
- Recommended for precision and minute parts such as watch and electronic components

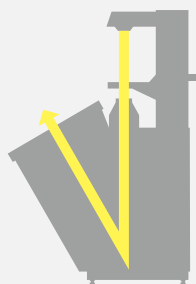

PH Series

Screen diameter
353mm / 14"

- Standard model in the edged tool industry. Perfect for observation and measurement of cutting tools (end mills, cutters, and tipped saws)
- Equipped with a high-rigidity stage boasting maximum load of 45kg / 100lbs
- Horizontal beam design makes loading/unloading the stage very easy

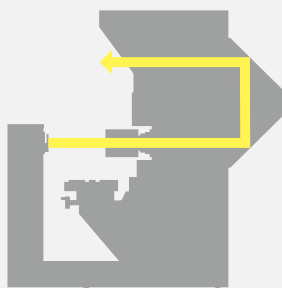

PH-3515F

PJ-PLUS
.....P4 - 7

PJ-H30
.....P8 - 11

PV-5110
.....P12 - 13

PH-3515F
.....P14 - 15

Stage
.....P16 - 17

Accessories
.....P18 - 22

Basic optical terminology
.....P23

PJ-PLUS



This profile projector can be operated intuitively, even by inexperienced users, and has excellent durability and energy saving performance thanks to the adoption of an LED illumination source and fan-less cooling system. This provides stable dimension and angle measurements in harsher environments that conventional models can't handle, such as manufacturing and processing lines.

PJ-PLUS



PJ-P2010A
302-802-10

Features (high durability and energy savings)

Thanks to the LED light source, lamp burnout is greatly reduced.

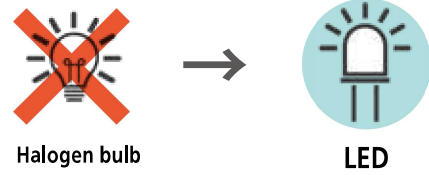

Compared with a halogen bulb

- Long service life
- Low power consumption (main unit):
Approx. 85% lower (400 W → 60 W)

Thanks to the fan-less system, oil mist or dust won't enter the main unit.



Improved durability

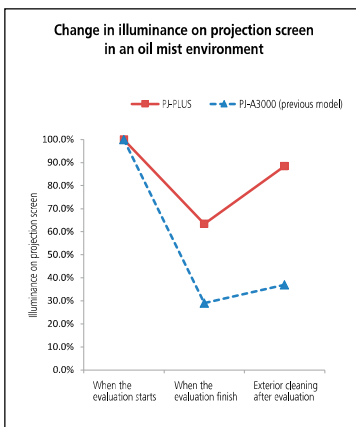

Adoption of the LED illumination source has eliminated the need for a cooling fan into the main unit of the measuring instrument and has drastically decreased the entry of oil mist, dust, etc. via the cooling fan into the instrument body. This also drastically reduces adhesion of oil and dust to the internal mirror, lens, and light source. The graph on the left shows changes in illuminance on the projection screen in case of long-term installation together with a conventional model (the projector with a fan) in a misty processing site. As compared with the conventional model, the LED light source type improves the rate of decline in illuminance by about 50%. It maintains high optical performance by preventing the entry of mist into the main unit even in the harsh environment of a processing line. The unit has excellent durability and requires less frequent maintenance, resulting in lower maintenance costs.

Note 1: Exterior cleaning of the projection lens surface, stage glass top, etc. is easy.

Note 2: The graph data shows measurement examples, and measured values may vary according to the installation environment and so on.

Observation light source

Stepless illumination adjustment



The conventional 2-step illumination adjustment has been changed to stepless control so the level of illumination can be precisely set to suit the surface texture and color of the workpiece.



LED (White)

No color change in projected image with changes in illumination intensity.

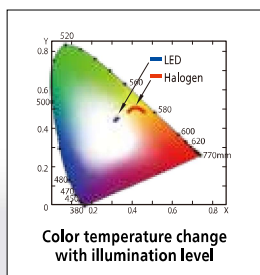

Color temperature varies significantly with the level of halogen illumination but not so much with LED illumination, so the appearance of the image varies a lot less as the LED level is adjusted. Also, the projected image under LED illumination is sharper and easier on the operator's eyes, which contributes to a reduction in fatigue and therefore more efficient inspection and measurement.

LED Circular Illuminator for PJ-PLUS Optional



Example of attaching the LED circular illuminator on PJ-PLUS



LED illumination can increase contrast and provide sharper images of the workpiece. Projected image can be observed at high color reproducibility, Low power consumption: 17.4 W, and long operating life: 30,000 hours.

■ Specifications

Order No.	172-502
Compatible model	PJ-PLUS (Projection lens 10X and 20X)*
Illumination source	White LED
Power consumption	12 V / 17.4 W
LED life (reference)	30,000 H

*The optional accessory (12AAX044) is necessary to attach this product to the PJ-PLUS 20X projection lens.

PJ-PLUS

Features (Operability)

High visibility digital display



Since the digital counter (XY axes and angle) built into all models as standard uses a high-intensity LED and a large character display, it secures high visibility unaffected by the environment. In addition to zero-setting and direction change, the data output of each counter value adopts the highly versatile RS-232C.

Resolution: 0.0001 in / 0.001 mm

Main unit side panel (output connectors)



Technical Data

Projected image		Inverted
Protractor screen	Effective diameter	ø315mm / 12.4"
	Screen rotation	±360° (The counter displays up to ±370°)
	Angle reading	Digital counter (ABS/INC mode switching), Zero Set
	Resolution	1' or 0.01° (switchable)
Projection lens	Cross-hairs	90° solid lines
	Magnification	10X (Standard accessory), 20X, 50X, 100X External half-reflecting mirror for surface illumination (only for 10X, 20X)
	Lens mount	Bayonet mount
Magnification accuracy*	Contour illumination	±0.1 % or less of nominal magnification
	Surface illumination	±0.15 % or less of nominal magnification
Maximum workpiece height	Refer to the projection lenses L ₁ right	
Contour illumination	White LED light source, Telecentric, Variable brightness adjustment	
Surface illumination	White LED light source, With an adjustable condenser lens, Variable brightness adjustment	
Resolution for X/Y counter	0.0001 in / 0.001 mm	
Power supply	100 V to 240 V AC, 50/60 Hz	
Mass	114kg / 251lbs (PJ-P1010A), 118 kg / 260lbs (PJ-P2010A)	
Power consumption	60 W	

* Our magnification accuracy standard only checks contour illumination (that it is ±0.1 % or less). (If the magnification accuracy under contour illumination is a permissible value, that under surface illumination is also guaranteed to be within ±0.15 % of our standard.)

Note: For the stage specification, refer to page 16.

Dimensions

(Unit: mm/inch)

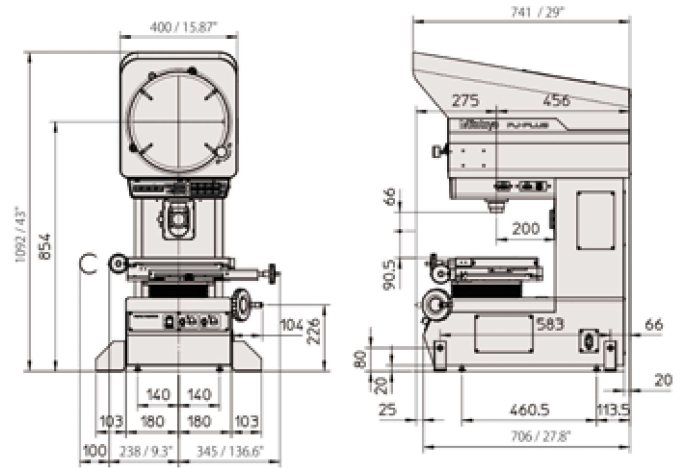

PJ-P2010A

Projection lenses (10X is a standard accessory)

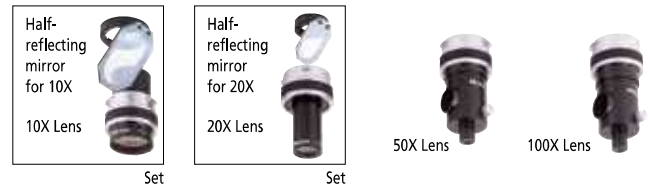

(Unit: mm)

	Contour illumination				Surface illumination			
	10X	20X	50X	100X	10X	20X	50X	100X
Magnification	10X	20X	50X	100X	10X	20X	50X	100X
View field	31.5	15.7	6.3	3.1	31.5	15.7	6.3	3.1
Working distance	L ₂	66	32.5	12.6	5	20	2	12.6
	L ₁	91						
PJ-P1010A	D	182	87	27	10	182	61	27
	L ₁	90.5						
PJ-P2010A	D	181	87	27	10	181	61	27

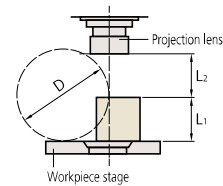

L₁: Max. height where focusing is available
L₂: Max. step where focusing is available (working distance)
D: Max. diameter when a cylinder generatrix is projected on the center line of the screen

Oblique reflection mirror

This is used for observing low-reflectivity workpieces, such as plastic parts, and the surfaces of parts with high surface roughness.

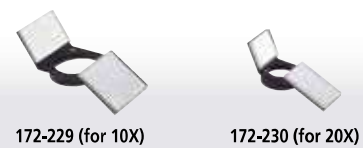

Order No.	172-229	172-230
Applicable models	PJ-PLUS	
Mass	0.3 kg / .66lbs	0.07 kg / 0.15 lbs

System Diagram

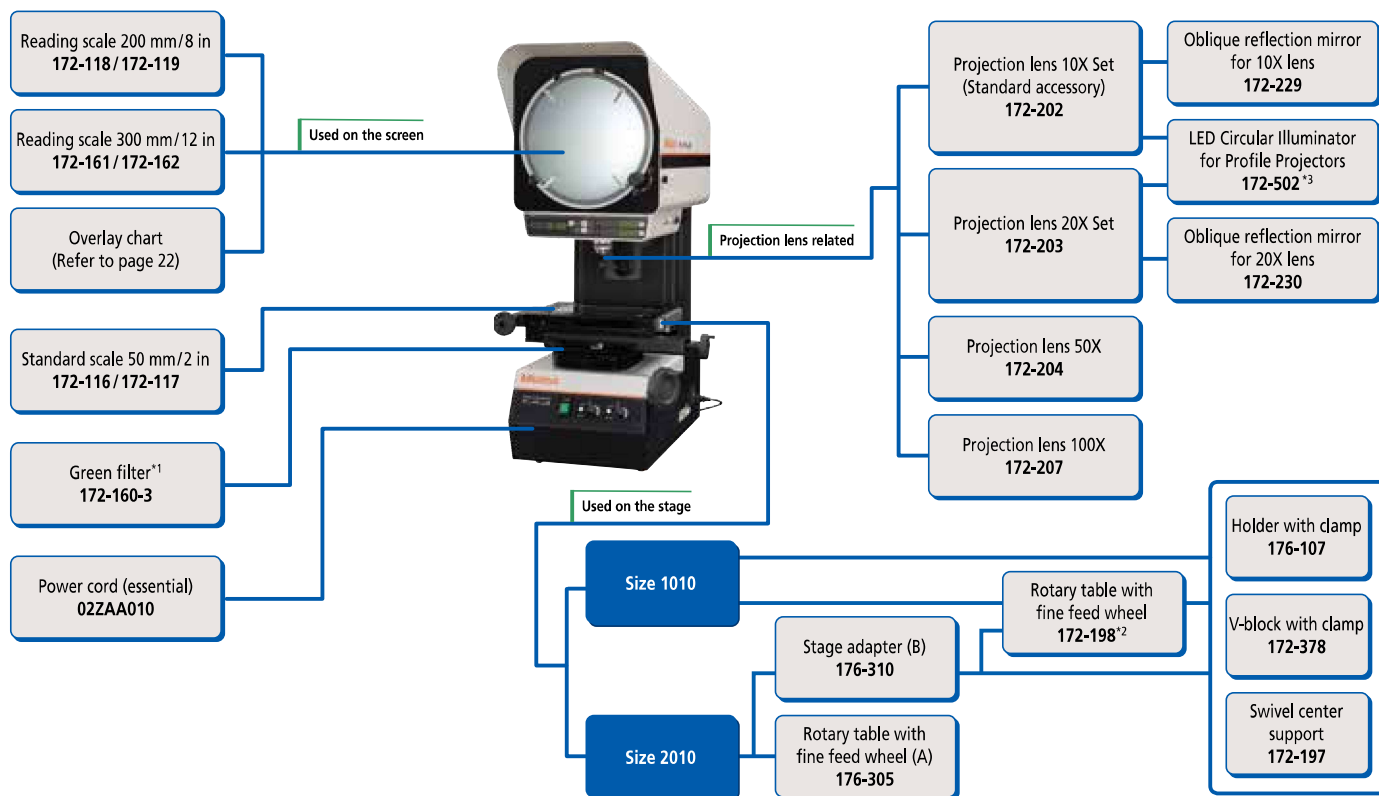

*1 This is inserted beside the stage adapter during use.

*2 172-197 (swivel center support) cannot mount on 172-198 (rotary table with fine feed wheel).

*3 The optional accessory (12AAX044) is necessary when this product is attached to the PJ-Plus 20x lens.

Note: If an optional unit is installed on the stage, the L₁ (Max. workpiece height) length is reduced by the optional unit height.
Stand for PJ-Plus is 64PMI167

Data Processing System Diagram

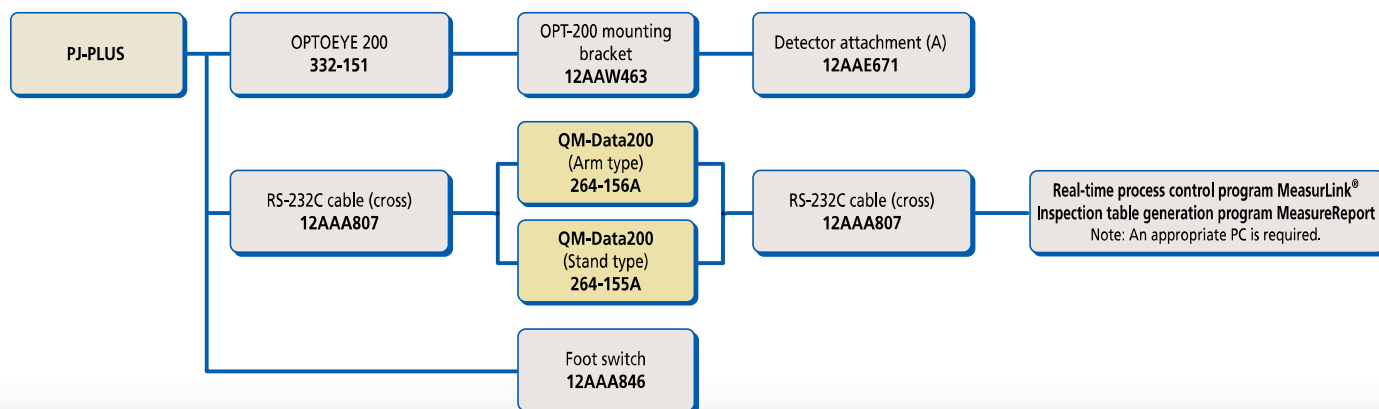

For details, refer to the QM-Data200 and Vision Unit brochure.

PJ-PLUS

PJ-H30

High-end model of PJ series that realizes the ultimate in bright, sharp projected images. High-rigidity main unit equipped with a linear scale for realizing high-accuracy measurements. Lineup of 8 models, derived from combinations of 4 stage types (100mm x 100mm / 4" x 4" to 300mm x 170mm / 12" x 6.8") and manual focusing / motor-driven focusing models. Adopts a quick-release handle that allows you to switch feed between fine and coarse remotely. Realizes smooth measurements, together with a turret structure, for easy lens changing.

PJ-H30



PJ-H30A2010B
303-713-1A

Features (Measuring accuracy)

Pursuit of measurement accuracy

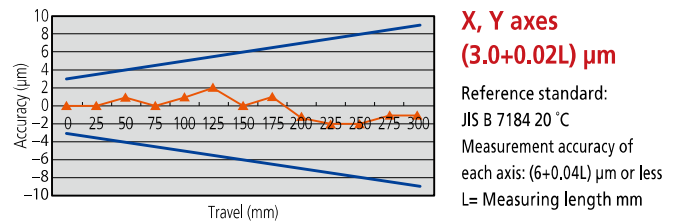

Red graph shows measured X-axis accuracy for a randomly selected projector.

The profile projector must maintain a high level of performance, not only in terms of optical performance, but also comprehensive measurement accuracy. The PJ-H30 Series, which performs not only contour observation and comparative inspection but also two-dimensional measurement with high accuracy, has achieved the above measurement accuracy in all stage sizes.*

Having achieved both long-stroke measurement and high accuracy, it is helpful in every measurement setting.

* Compliant with JIS B 7184, measurement method for each of the XY axes

Features (Bright, clear observation)

Also equipped with oblique reflected illumination with good color reproducibility as standard



The reflected illumination comprises vertical illumination which goes through the projection lens, and oblique illumination, with changeable angle of illumination emitter as standard. It is effective in three-dimensional observation with enhanced color reproducibility.

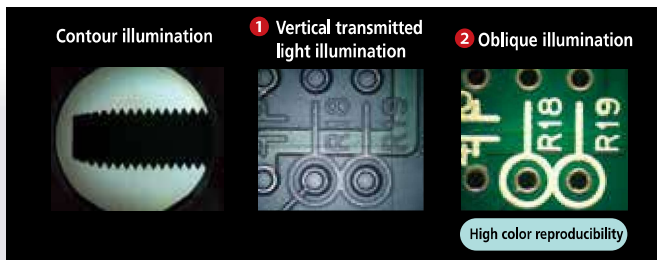

Features (Maintainability)

Easy-to-replace lamp housing design

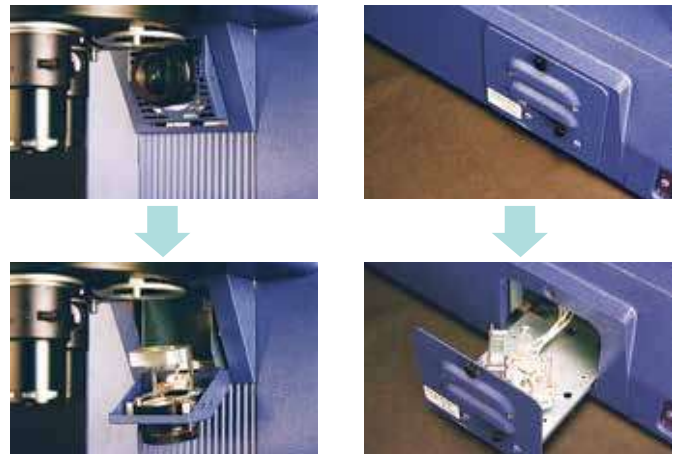

Having a halogen lamp burn out during use causes issues and down time. Immediately after a lamp burns out, it is too hot to be replaced. The PJ-H30 Series has a slide change mechanism, which allows you to change lamps from outside of the machine. Even if the lamp burns out suddenly, you can continue inspection and measurement without issues (for transmitted illumination only). The housing can be pulled out just by loosening the screw, making it very easy to replace the lamp. Furthermore, it is safe to pull out the housing because no electricity is flowing.

Features (Operability)

All models equipped with turrets as standard



The turret of the PJ-H30 Series uses low-friction bearings for smooth and rapid rotary motion and to bring different projection lenses into the light path to change magnification. The turret body uses bayonet mounts to aid quick attachment and detachment of lenses.

Focusing with high operability



Manual focusing handle of PJ-H30A



PJ-H30D (motor-driven focusing) front panel

To place a test workpiece on the stage and focus swiftly, an easy-to-grip handle and handle position are very important. Therefore, the PJ-H30 Series has an oblique manual focusing handle that lets you operate in a natural position, whether standing or sitting, without awkwardness. Moreover, a high-operability jog shuttle with motor-driven focusing is also available, and its smooth movement contributes to less fatigue in observation and measurement.

Note: PJ-H30D (with motor-driven focusing) does not come with a manual focusing handle.

Stepless illumination adjustment



Stepless illumination adjustment has been adopted to provide moderate illuminance according to the surface texture and color of the workpiece. Illumination strength ranges from weak to strong, and this method is also effective in extending the halogen lamp life, which is enhanced by using a soft start feature to limit input surge current.

Projection Lens 10X with C mount Optional



Example of attaching the Projection Lens 10X with C mount on PJ-H30



The projection lens is equipped with a C mount, therefore a compatible digital camera can be attached. A workpiece can be observed on the large-size projection screen, and simultaneously the color image can be saved on the camera and observed on the monitor.

■ Specifications

Order No.	172-500
Camera Projected Image	Inverted
Compatible Sensor Size	Four Thirds 4/3 type
Camera Mount	C mount
Mountable Mass	0.9 kg or less

The magnification accuracy of the camera is not guaranteed
 Vignetting occurs on the four corners of a camera image under contour illumination
 Turret can only rotate 120 degrees while mounted
 Camera may interfere with turret rotation
 Surface illumination will not work with this projection lens, ring light is suggested

LED Circular Illuminator for PJ-H30 Optional



LED illumination can increase the contrast of the projected image and provide sharp on-screen images. The projected image will have higher color reproducibility when compared to halogen illumination. Low power consumption: 17.4 W and longer operating life: 30,000 hours.

■ Specifications

Order No.	172-501
Compatible model	PJ-H30 (10X Projection Lens with C mount, Projection lens 10X and 20X)
Illumination source	White LED
Power consumption	12 V / 17.4 W
LED life (reference)	30,000 H

Features (Operability)

High visibility digital display



Since the digital counter (XY axes and angle) built into all models as standard uses a high-intensity LED and a large-character display, it secures high visibility unaffected by the environment. In addition to zero-setting and direction change, the data output of each counter value adopts the highly versatile RS-232C.

Resolution: 0.0001 in / 0.001 mm*

* 0.5 μm or 0.1 μm readings can also be equipped. Please ask our Techno Service.

Technical Data

Projected image	Erect	
Protractor screen	Effective diameter	306mm / 12.04"
	Screen rotation	±360° (The counter displays up to ±370°)
	Angle reading	Digital counter (ABS/INC mode switching), Zero Set
	Resolution	1° or 0.01° (switchable)
Projection lens	Cross-hairs	Solid lines
	Magnification	10X (Standard accessory), 5X, 20X, 50X, 100X Parfocal lens Half-reflecting mirror for surface illumination
	Lens mount	Bayonet mount (registered utility model), 3-mount turret
Magnification accuracy*1	Contour illumination	±0.1 % or less of nominal magnification
	Surface illumination	±0.15 % or less of nominal magnification
Maximum workpiece height	105mm / 4.1"±2	
Contour illumination	24 V, 150 W 50 h Halogen bulb (515530) Zoom Telecentric, Heat-absorbing filter Cooling fan, Non-stepped brightness adjustment Soft lighting function (reduced inrush current) Lamp mount switching system	
	24 V, 150 W, 50h Halogen bulb (515530) Vertical/oblique illumination with an adjustable condenser lens Heat-absorbing filter, Cooling fan, Non-stepped brightness adjustment, Soft lighting function (reduced inrush current)	
Surface illumination	24 V, 150 W, 50h Halogen bulb (515530) Vertical/oblique illumination with an adjustable condenser lens Heat-absorbing filter, Cooling fan, Non-stepped brightness adjustment, Soft lighting function (reduced inrush current)	
Focusing	Projection screen head driving PJ-H30A (manual), PJ-H30D (power drive)	
Resolution for X/Y counter	0.0001 in / 0.001 mm* * You can specify 0.5 μm or 0.1 μm resolution. (Available on request.)	
Power supply	ON/OFF switch, 100 to 240 V AC (unnecessary switching voltage), GND terminal, 50/60 Hz, Power cord (2 m)	
Mass	167 kg / 387.2 lbs to 212 kg / 466.4 lbs	
Power consumption	Approx. 420 W	

*1 Our magnification accuracy standard only checks contour illumination (that it is ±0.1 % or less). (If the magnification accuracy under contour illumination is a permissible value, that under surface illumination will also be guaranteed to be within ±0.15 % of our standard.)

*2 For the stage specification, refer to page 16.

Dimensions

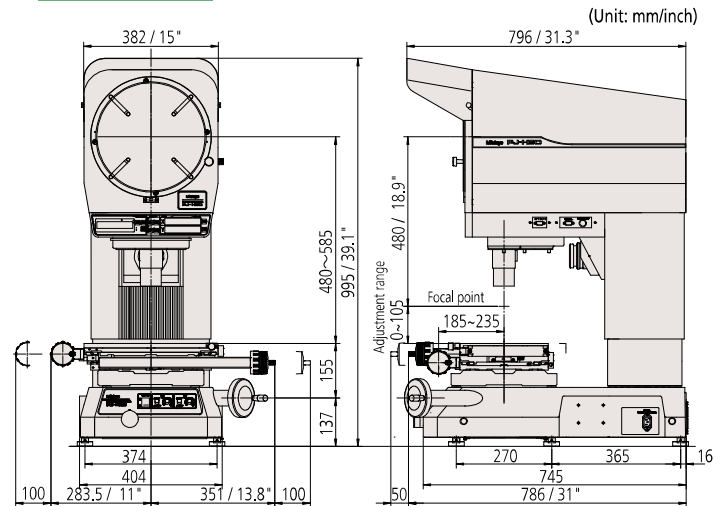

PJ-H30A2010B

Main unit side panel



Projection lenses (10X is a standard accessory)



Order No.	View field (mm)	L1 (mm)	L2 (mm)	D (mm)
5X Lens 172-271	61.2	105	66	148
10X Lens (Standard accessory) 172-472	30.6	105	70.5	197
20X Lens 172-473	15.3	105	56.5	137
50X Lens 172-474	6.12	105	50	114
100X Lens 172-475	3.06	105	50	114

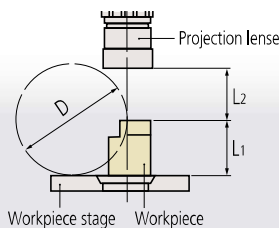

Note: When rotary table is not mounted.

L1: Max. height where focusing is available
L2: Max. step where focusing is available (working distance)
D: Max. diameter when a cylinder generatrix is projected on the center line of the screen

System Diagram

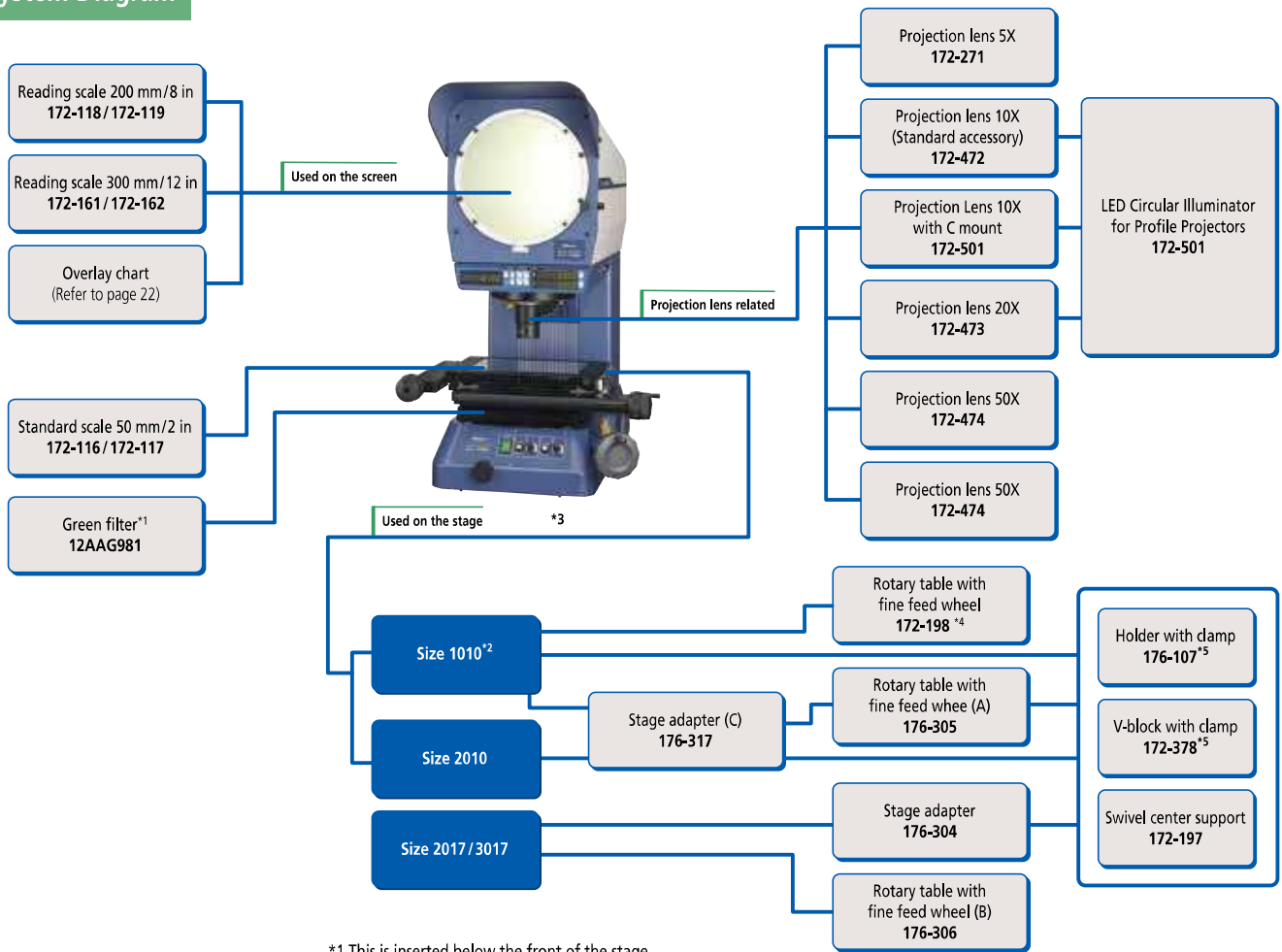

- *1 This is inserted below the front of the stage.
 - *2 For the 1010 size, it is also possible to directly attach the "holder with clamp (176-107)," "V-block with clamp (172-378)," and "swivel center support (172-197)," bypassing the "stage adapter C (176-317)."
 - *3 Machine Stand is part number 172-269
 - *4 172-198 requires 176-317 to connect to -2010 stage and it requires adapter 176-304 to connect to -2017/-3017 stage.
 - *5 176-107 and 172-378 can mount on 172-198
- Note: If an optional unit is installed on the stage, the H (Max. workpiece height) length is reduced by the optional unit height.

Data Processing System Diagram

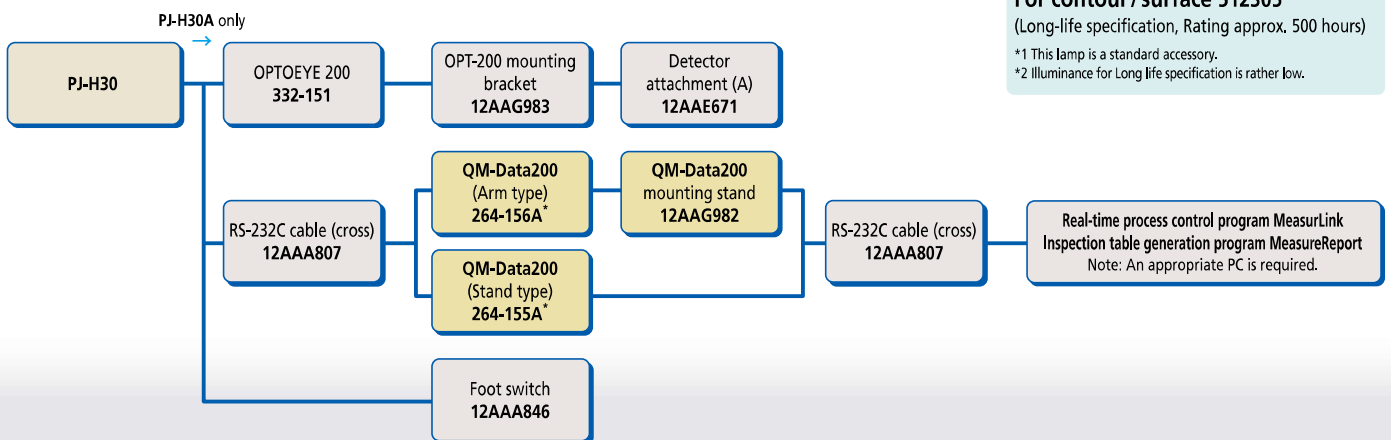

◆ Lamp replacement ◆
For contour/surface 515530*1
For contour/surface 512305*2
 (Long-life specification, Rating approx. 500 hours)
 *1 This lamp is a standard accessory.
 *2 Illuminance for Long life specification is rather low.

For details, refer to the QM-Data200 and Vision Unit brochure.

* To denote your AC power cable add the following suffixes to the order No.: A for UL/CSA, D for CEE, DC for CCC, E for BS, K for KC, C and No suffix are required for PSE.

PJ-H30

PV-5110

Equipped with a 500mm / 19.6" forward-tilted screen, the PV-5110 is perfect for comparative measurements with enlarged drawings and tracing of projected images. This model increases inspection efficiency of mass-production precision parts.



PV-5110
304-919A

Dimensions

(Unit: mm/inch)

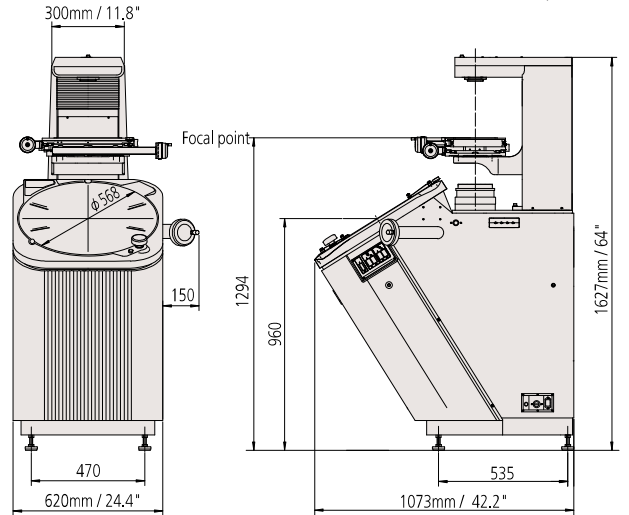

Note: To mount the counter (KA-212) and counter stand, approximately 300mm / 11.8" space is required on the right-hand side of the main unit.

PV-5110

Technical Data

Projected image	Inverted	
Protractor screen	Effective diameter	508mm / 20"
	Screen material	Fine-ground glass
	Screen rotation	±360° (The counter displays up to ±370°)
	Angle reading	Digital counter (ABS/INC mode switching), Zero Set
	Resolution	1' or 0.01" (switchable)
	Cross-hairs	90° solid lines
Projection lens	0 Line (Index)	Built-in, With a LED back light
	Magnification	5X, 10X (Standard accessory), 20X, 50X, 100X
Magnification accuracy*	Contour illumination	±0.1 % or less of nominal magnification
	Surface illumination	±0.15 % or less of nominal magnification
Maximum workpiece height	Refer to projection lens table	
Contour illumination	24 V, 150 W, 500 h Halogen bulb (512305)	
	Mount switching system	
	Telecentric, Heat-absorbing filter	
	Cooling fan, 2-step (High/Low) brightness switch	
Surface illumination	Can be used in conjunction with color filter	
	24 V, 150 W, 500 h Halogen bulb (512305)	
	Heat-absorbing filter, Adjustable condenser lens	
	Oblique illumination (for 5X, 10X and 20X)	
Focusing	Cooling fan, 2-step (High/Low) brightness switch	
	Stage part drive	
Power supply	Manual	
	100 V, 110 V, 120 V, 220 V, 230 V, 240 V AC external switching	
Mass	Approx. 210 kg / 462lbs (including X-Y stage)	
Power consumption	Approx. 560 W	

* Our magnification accuracy standard only checks contour illumination (that it is ±0.1 % or less). (If the magnification accuracy under contour illumination is a permissible value, that under surface illumination will also be guaranteed to be within ±0.15 % of our standard.)

Note: For the stage specification, refer to page 17.

Projection lenses (10X is a standard accessory)



Order No.	View field (mm)	L ₁ (mm)	L ₂ (mm)	D (mm)
5X Lens Set 172-401	101.6	125	60 (27)	120
10X Lens Set (Standard accessory) 172-402	50.8	181	60	120
20X Lens Set 172-403	25.4	206	60	120
50X Lens Set 172-404	10.16	87	32.4	64.8
100X Lens Set 172-405	5.08	87	22.5	45

Note 1: () : When using surface illumination
Note 2: Each lens set contains the condenser lenses for illumination.
Note 3: D is for the case of contour illumination.

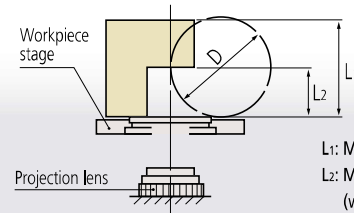
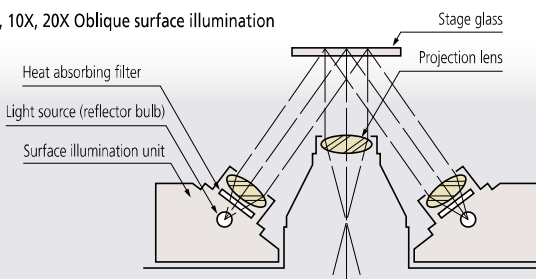

L₁: Max. height where focusing is available
L₂: Max. step where focusing is available (working distance)
D: Max. diameter when a cylinder generatrix is projected on the center line of the screen

System Diagram

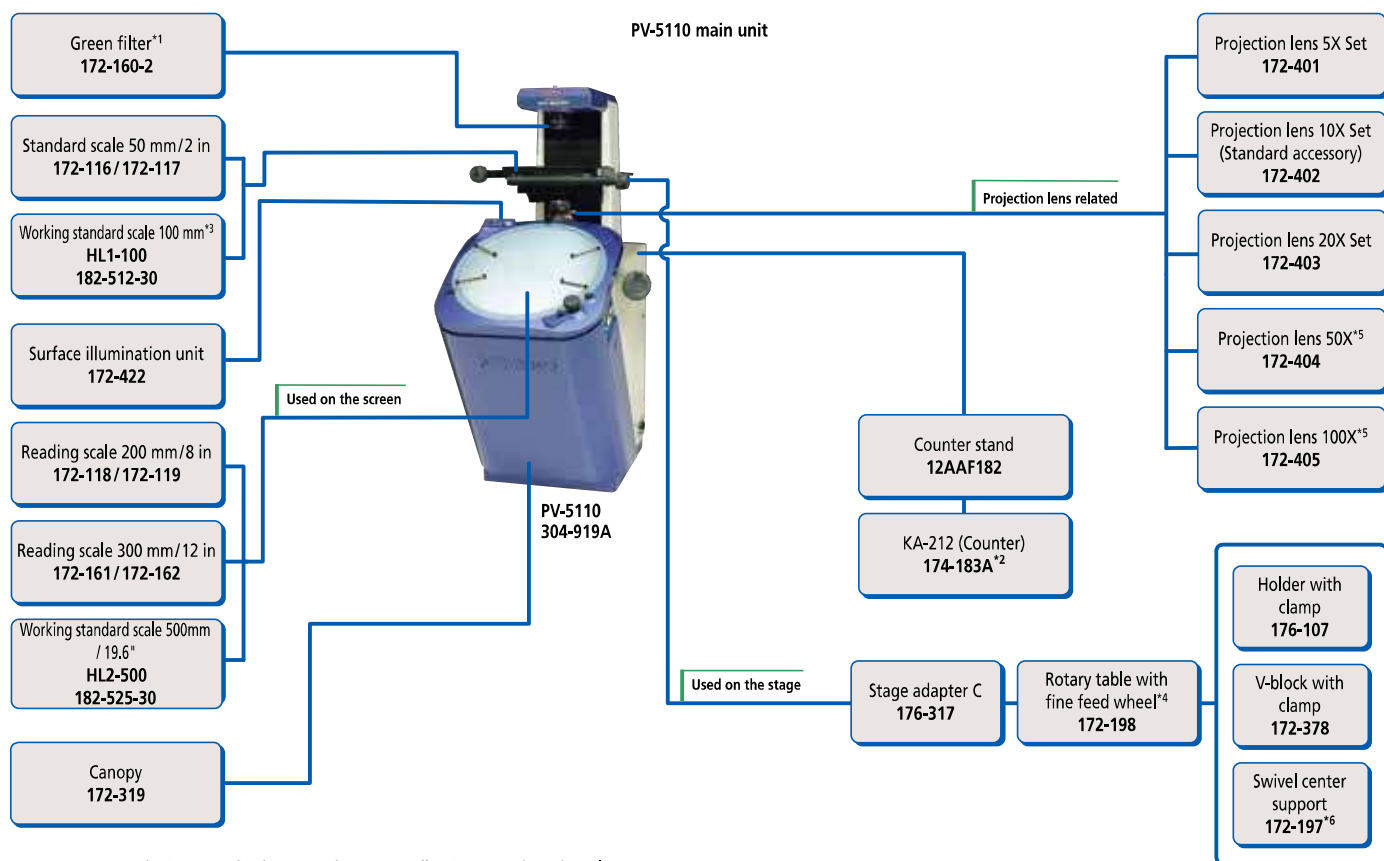

*1 This is inserted in between the contour illuminator and condenser lens.

*2 To denote your AC power cable add the following suffixes to the order No.: A for UL/CSA, D for CEE, DC for CCC, E for BS, K for KC, C and No suffix are required for PSE.

*3 Used on the stage. It is projected onto the screen to check the magnification accuracy with a reading scale.

*4 Since the rotary stage section is small, if it is used for a large stage, some restrictions may be imposed on the measuring range.

*5 When using a 50X or a 100X projection lens, you need to remove the stage glass in order to prevent a collision between the stage glass for the X/Y stage and the projection lens. 172-197 cannot mount to 172-198. 172-197 can connect directly to 176-317.

*6 172-197 cannot mount to 172-198. 172-197 can connect directly to 176-317.

*7 rotary stage 176-305 can mount to stage adapter C 176-317. 176-107, 172-378, and 172-197 can all mount to 176-305 or they can mount directly to 176-317.

Note: If an optional unit is installed on the stage, the H (Max. workpiece height) length is reduced by the optional unit height.

Data Processing System Diagram

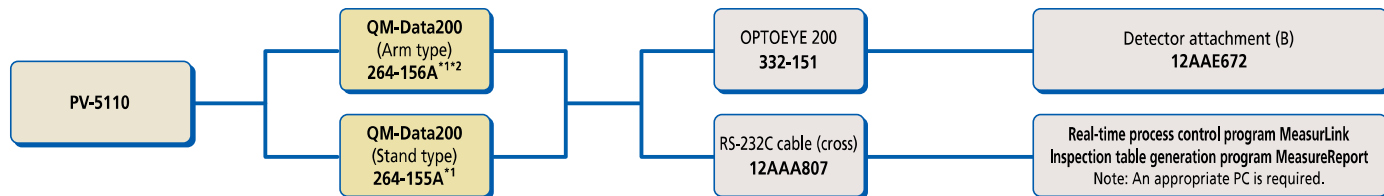

◆Lamp replacement◆
For contour / surface 512305

For details, refer to the QM-Data200 and Vision Unit brochure.

*1 To denote your AC power cable add the following suffixes to the order No.: A for UL/CSA, D for CEE, 00 for CCC, E for BS, K for KC, C and No suffix are required for PSE.

*2 The arm type cannot be used concurrently with a counter stand.

PV-5110

PH-3515F

The PH-3515 is the standard in the edged tool industry. This model is perfect for contour observation and measurement of edged tools (such as end mills, cutters, and tipped saws), screws, springs, and the like. It is equipped with a high-rigidity stage with a long stroke of 254 x 152 mm / 10" x 6" and a load-carrying capacity of 45 kg / 100 lbs, supporting even long, heavy workpieces.



Technical Data

Projected image	Erect*1 (PH-3515F), Inverted (PH-A14)	
Protractor screen	Effective diameter	ø353 (13.9 in) mm (PH-3515F), ø356 (14 in) mm (PH-A14)
	Screen material	Fine-ground glass
	Screen rotation	±360° (The counter displays up to ±370°)
	Angle reading	(PH-3515F) Digital counter (ABS/INC mode switching), Zero Set (PH-A14) vernier scale
	Resolution	1" or 0.01" (switchable) (PH-3515F)
	Cross-hairs	90° solid lines
Projection lens	Magnification	10X (Standard accessory) 5X (PH-3515 only), 20X, 50X, 100X
	Lens mount	Screw mount
Magnification accuracy*2	Contour illumination	±0.1 % or less of nominal magnification
	Surface illumination	±0.15 % or less of nominal magnification
Maximum workpiece height	Refer to the projection lenses L1 right.	
Contour illumination	Contour illumination	24 V, 150 W, 500 h Halogen bulb (515530) Telecentric, Heat-absorbing filter Cooling fan, 2-step (High/Low) brightness switch: PH-3515F, (Lit together with main power activation: PH-A14) Can be used in conjunction with color filter
	Surface illumination	24 V, 200 W, 500 h Parabolic halogen bulb (12BAA637): PH-3515F, (24V 150W, common to the contour illumination: PH-A14) Adjustable condenser lens, Heat-absorbing filter Cooling fan
Focusing	Stage part drive Manual	
Power supply	Power supply	100 V, 110 V, 120 V, 220 V, 240 V AC external switching (PH-3515F) 100 V, 120 V, 130 V, 220 V, 230 V, 240 V AC external switching (PH-A14) 50/60 Hz Power cord (2 m)
	Mass	150 kg / 330 lbs (PH-3515F), 140 kg / 308 lbs (PH-A14)
Power consumption	Approx. 410 W (PH-3515F), 200 W (PH-A14)	

*1 The projected image of the workpiece is erect but reversed, which means that the vertical orientation and displacement direction of the image is the same as on the workpiece side, but the horizontal orientation and displacement direction are reversed.
*2 Our magnification accuracy standard only checks contour illumination (that it is ±0.1 % or less). (If the magnification accuracy under contour illumination is a permissible value, that under surface illumination will also be guaranteed to be within ±0.15 % of our standard.)
Note 1: X and Y counters are not built into the projector main unit. If a counter display is required, it is recommended that a QM-Data200 or KA-212 is purchased separately.
Note 2: The indicated value of a measurement may be slightly smaller than the actual value due to optical distortion caused by the illumination conditions.
Note 3: For the stage specification, refer to page 17.

Dimensions

PH-3515F

(Unit: mm/inch)

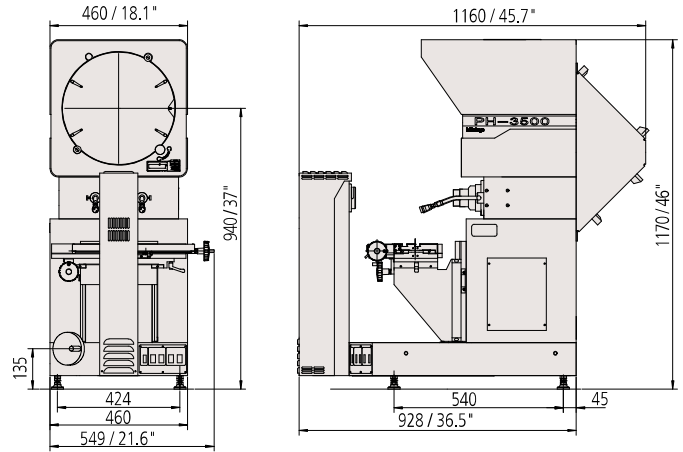

Note 1: To mount the optional counter (KA-212) and counter stand, approximately 300 mm / 11.8" space is required on the right-hand side of the main unit.
Note 2: Refer to page 17 for the dimensions of PH-A14.

Projection lenses (10X is a standard accessory)

PH-3515F

Order No.	View field (mm)	L1 (mm)	L2*2 (mm)	D (mm)	H (mm)
5X Lens Set 172-145	70.6	175	160 (64)	152.4	152.4
10X Lens Set (Standard accessory)*1 172-184	35.3	235	93 (41)	152.4	152.4
20X Lens Set 172-173	17.65	235	40 (40)	116	152.4
50X Lens Set 172-165	7.06	80	14.6 (14.6)	30.4	152.4
100X Lens Set 172-166	3.5	109	9.5 (9.5)	19	152.4

*1 The 10x lens set includes half-reflecting mirror (172-295) for the 10x lens.
*2 Dimension L2 values in parentheses are those under surface illumination.

PH-A14

Order No.	View field (mm)	L1 (mm)	L2*2 (mm)	D (mm)	H (mm)
10X Lens Set (Standard accessory) 172-011	35.6	235	93	130	102
20X Lens Set 172-012	17.8	235	40	116	102
50X Lens Set 172-013	7.12	109	14.6	31.3	102
100X Lens Set 172-014	3.56	109	9.5	19.2	102

* Dimension L2 values in parentheses are those under surface illumination.

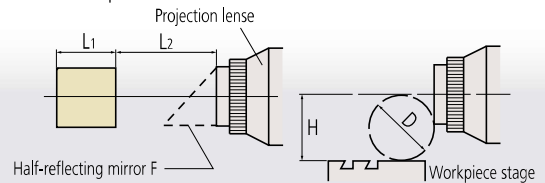

L1: Max. height where focusing is available
 L2: Max. step where focusing is available (working distance)
 D: Max. diameter when a cylinder generatrix is projected on the center line of the screen
 H: Max. size from optical axis and workpiece stage surface

System Diagram

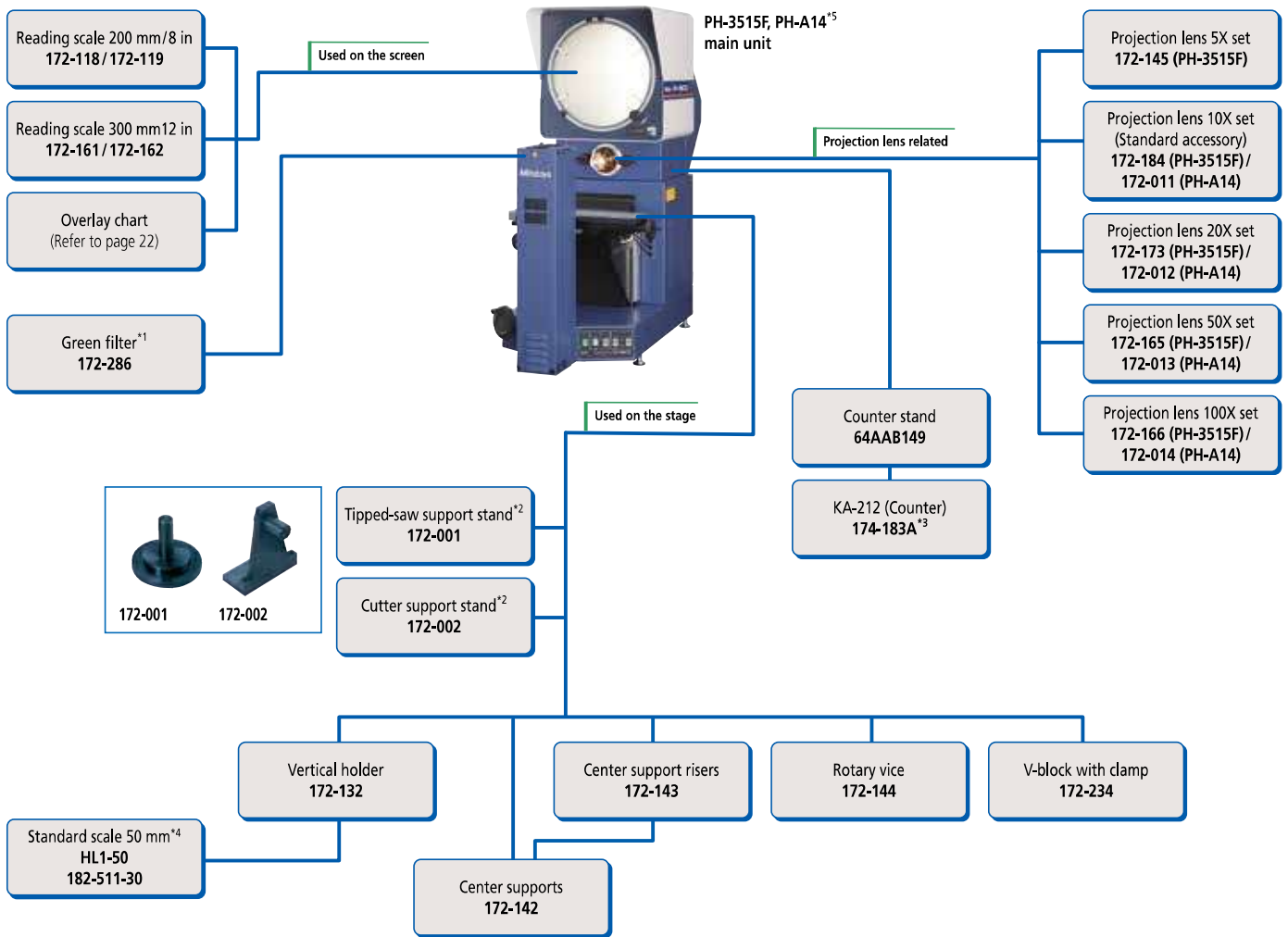

*1 This is inserted in the contour light source section during use.

*2 The tipped-saw and cutter support stands support a center hole diameter of 25.4 mm.

*3 To denote your AC power cable add the following suffixes to the order No.: A for UL/CSA, D for CEE, DC for CCC, E for BS, K for KC, C and No suffix are required for PSE.

*4 Reference scale for checking the magnification accuracy. It is fixed on the stage with a vertical holder and projected on the screen to check the magnification with HL.

*5 Machine stand for PH-3515 is 64AAB176. Machine stand for PH-A14 is 64AAA129B.

Data Processing System Diagram

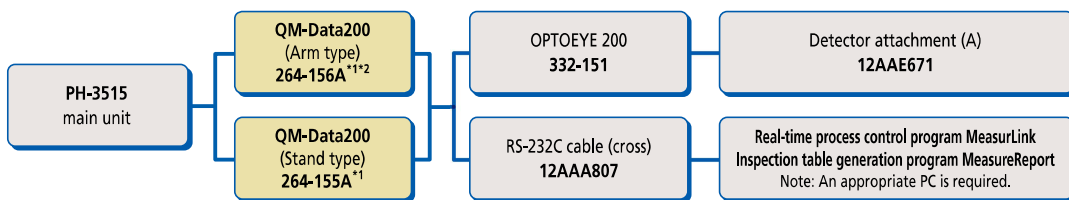

◆ Lamp replacement ◆

For contour / surface 515530^{*1}

For contour / surface 512305^{*2}

(Long-life specification, Rating approx. 500 hours)

For oblique reflection / reflection 12BAA637^{*1}

*1 This lamp is a standard accessory.

*2 Illuminance for Long Life specification is rather low.



For details, refer to the QM-Data200 and Vision Unit brochure.





*1 To denote your AC power cable add the following suffixes to the order No.: A for UL/CSA, D for CEE, DC for CCC, E for BS, K for KC, C and No suffix are required for PSE.

*2 The arm type cannot be used concurrently with a counter stand.

PH-3515F

Stage

PJ-PLUS			
		100 x 100 mm / 4" x 4"	200 x 100 mm / 8" x 4"
PJ-PLUS main unit	Model	PJ-P1010A	PJ-P2010A
	Order No.	302-801-10	302-802-10
Unit system for the counter unit		mm/in	
Measuring unit		Digital scale	
Quick-release mechanism		X and Y axes	
Top surface size		250 x 250 mm / 9.8" x 9.8"	350 x 280 mm / 13.8" x 11"
Effective size of stage glass		142 x 142 mm / 5.6" x 5.6"	240 x 140 mm / 9.4" x 5.5"
Stage glass thickness		5mm / .19"	8 mm / .31"
Stage glass		12BAE041	12BAD760
Swivel adjustment range		—	—
Maximum loading		10 kg / 22 lbs	8 kg / 17.6 lbs

PJ-H30					
		100 x 100 mm / 4" x 4"	200 x 100 mm / 8" x 4"	200 x 170mm / 8" x 6.7"	300 x 170 mm / 12" x 6.7"
Protractor screen	Model	PJ-H30A1010B	PJ-H30A2010B	PJ-H30A2017B	PJ-H30A3017B
	Order No.	303-712-1A*	303-713-1A*	303-714-1A*	303-715-1A*
Protractor screen/ OPTOEYE built-in/ motor-driven focusing	Model	PJ-H30D1010B	PJ-H30D2010	PJ-H30D2017B	PJ-H30D3017B
	Order No.	303-732-1A*	303-733-1A*	303-734-1A*	303-735-1A*
Measuring unit		High-accuracy digital scale			
Quick-release mechanism		X and Y axes standard			
Top surface size		300 x 240 mm / 12" x 9.4"	350 x 280 mm / 13.8" x 11"	410 x 342 mm / 16" x 13.4"	510 x 342 mm / 20" x 13.4"
Effective size of stage glass		180 x 150 mm / 7.1" x 6"	250 x 150 mm / 9.8" x 6"	270 x 240 mm / 10.6" x 9.4"	370 x 240 mm / 14.6" x 9.4"
Stage glass thickness		6 mm / .24"	6 mm / .24"	8 mm / .31"	8 mm / .31"
Stage glass		380412	382762	12BAD363	12BAD330
Swivel adjustment range		±3° (right)		±5° (left)	
Maximum loading		10 kg / 22 lbs		20 kg / 44 lbs	
Measuring accuracy		(3+0.02L) μm L: Measured length (mm) Note: The measurement method conforms to JIS B 7184 .			

* To denote your AC power cable add the following suffixes to the order No.: A for UL/CSA, -1D for CEE, -1 DC for CCC, -1E for BS, -1K for KC, C and No suffix are required for PSE.

Stage

Stage

Quick-release mechanism allows rapid traverse

PV-5110	
XY range	200 x 100 mm / 8" x 4" (164 x 68mm / 6.5" x 2.7") ^{*1}
PV-5110 main unit Order No.	304-919A ^{*2}
Measuring unit	Digital scale
Quick-release mechanism	X and Y axes
Top surface size	380 x 250 mm / 15" x 9.8"
Effective size of stage glass	266 x 170 mm / 10.5" x 6.7"
Stage glass thickness	6 mm / .24"
Stage glass	382762
Swivel adjustment range	±3°
Maximum loading	5 kg / 11 lbs

*1 () The range where no shading is observed using a 5X projection lens.
 *2 To denote your AC power cable add the following suffixes to the order No.: A for UL/CSA, -1D for CEE, -1 DC for CCC, -1E for BS, -1K for KC, C and No suffix are required for PSE.

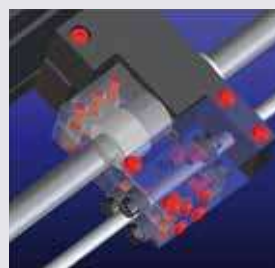

Twist roller system

Quick-release handle

A quick-release mechanism inside the X/Y handle allows you to switch stage feed between extremely coarse and fine traverse movement. Since the stage is completely free floating, it is very convenient when the distance to the next measuring position is large or when you need to return to the reference position swiftly. Since this mechanism has adopted the twist roller system, there is almost no shock in switching, and the feed is smooth.

Note: Except for PJ-PLUS Series and PH Series.

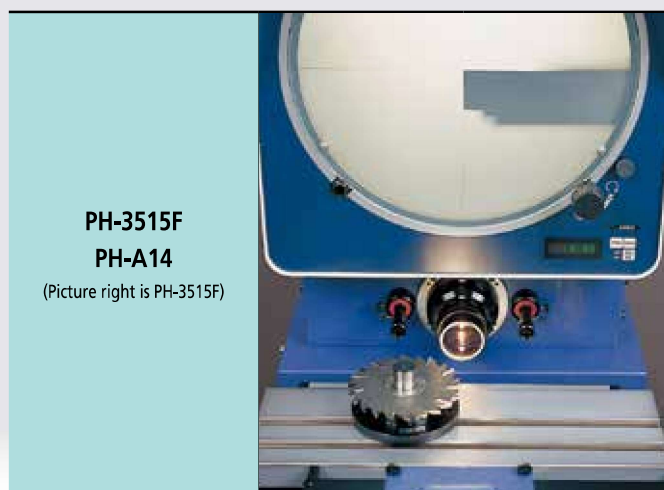

PH-3515F
PH-A14

(Picture right is PH-3515F)

Model No.	PH-3515F	PH-A14
XY range	254 x 152 mm / 10" x 6"	200 x 100 mm / 8" x 4"
PH-3515F main unit Order No.	172-868A ^{*1}	172-810-10A ^{*2}
Measuring unit	Digital scale	
Quick-release mechanism	Only X-axis	
Top surface size	450 x 146 mm / 17.7" x 5.7"	407 x 152.4 mm / 16" x 6"
Dovetail groove	Two (Pitch = 43 mm)	
Minimum swivel angle reading	30'	—
Maximum measuring diameter (horizontally fixed) ^{*3}	340mm / 13.4"	300 mm / 11.8"
Swivel adjustment range	±10°	—
Maximum loading	45 kg / 100 lbs	

Photo: Cutter (Outside diameter of 175 mm max.) is mounted on the tipped-saw support fixture (172-001).

*1 To denote your AC power cable add the following suffixes to the order No.: A for UL/CSA, D for CEE, DC for CCC, E for BS, K for KC, C and No suffix are required for PSE.

*2 To denote your AC power cable add the following suffixes to the order No.:

-10A for UL/CSA, -20D for CEE, -20DC for CCC, -20E for BS, -20K for KC.

*3 When using the projection lens 10X (Standard accessory).

Dimensions of PH-A14

(Unit: mm/inch)

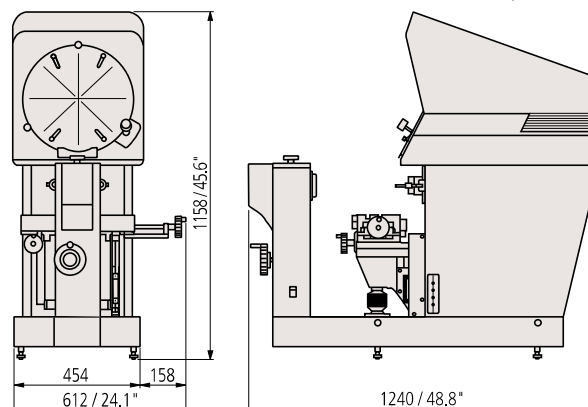









Accessories (Optional)

■ 2-D Data Processing Unit QM-Data200











The QM-Data200 is a geometric readout / analysis unit for optical instruments such as profile projectors. This unit features powerful 2-D coordinate measurement capabilities with easy-to-use key operation. Measurement results can be visualized on the LCD display and printed out if required.

Basic element measurement

 Point Coordinates (Multi-point processing for a maximum of 100 points) Note: In multi-point processing, the mean value is used as the measured value.	 Line Angle and perpendicularity with the X axis. (Multi-point processing for a maximum of 100 points)	 Circle Center coordinates, diameter, roundness (Multi-point processing for a maximum of 100 points)	 Point-point distance Distance, Coordinates difference, radial difference
 Ellipse Center coordinates, major-axis diameter, minor-axis diameter, angle with the X axis, departure from the X axis (Multi-point processing for a maximum of 100 points)	 Rectangular hole Center coordinates, length, width	 Slotted hole Center coordinates, length, width, radius of slotted hole	 Intersection point and intersecting angle Intersection coordinates, intersecting angle, supplementary angle

Pattern measurement

 Pitch Point-point distance, difference between coordinates, angle, cumulative distance, cumulative angle	 Line-point distance Perpendicular (shortest) distance	 Line-circle distance Center-center distance, longest distance, shortest distance	 Circle-circle distance Center-center distance, longest distance, shortest distance, difference between coordinates, radial difference
 Line-circle intersection Coordinates of intersection	 Intersection of circles Coordinates of intersection	 Midpoint between points Coordinates of midpoint	 Midpoint between line and point Coordinates of midpoint

■ Specifications

Code	QM-Data200	
	Stand-mount type	Arm-mount type
Order No.	264-155A*1	264-156A*1
Display languages (selectable)	Japanese/English/German/French/Italian/Spanish/Portuguese/Czech/Chinese/Korean/Turkish/Swedish/Polish/Dutch/Hungarian	
Measured value unit	Length: mm Angle: degree/degree minute second (selectable)	
Resolution	0.1 μm	
Program functions	Part program creation, execution, editing	
Statistical processing	Number of data, maximum value, minimum value, mean value, standard deviation, range, histogram, statistics on a measuring function basis (by command)	
Display system	COLOR TFT LCD (with LED backlight)	
Edge Sensor Position Compensation	Supported (Projector)	
Input/Output	XYZ : Maximum of three Linear Scales RS-232C 1 : For connecting to external PC RS-232C 2 : For connecting to counter of measuring instrument OPTOEYE : For inputting edge signal from OPTOEYE (OPTOEYE 200) FS : For connecting to optional foot switch PRINTER : For connecting to optional printer USB-MEMORY : For connecting to USB memory	
Measurement result file output	RS-232C output (CSV format, MUX-10 format)	
Power	100 to 240 V AC	
Maximum power consumption	17 W (does not include optional accessories)	
External dimensions (WxDxH)	Approximately 260 x 242 x 310 mm / 10.2" x 9.5" x 12.2" (including the stand)	Approximately 318 x 153 x 275 mm / 12.5" x 6.0" x 10.8" (when the arm is in the horizontal posture)
Mass	Approximately 2.9 kg / 6.4 lbs	Approximately 2.8 kg / 6.2 lbs
Applicable models	PJ-PLUS Series PJ-H30 Series PV-5110 PH-3515F PH-A14	PJ-PLUS Series PJ-H30 Series PV-5110*2 PH-3515F*2 PH-A14*2
Standard accessories	AC adapter, power cable, Easy operation guide	

■ Operation screen (Counter)

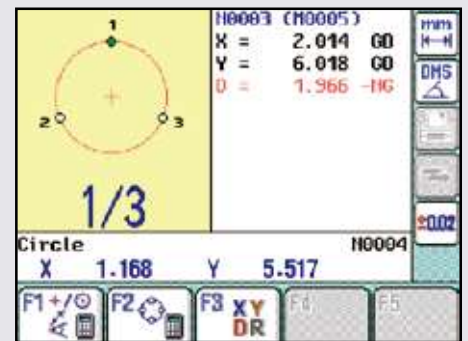

Measurement result

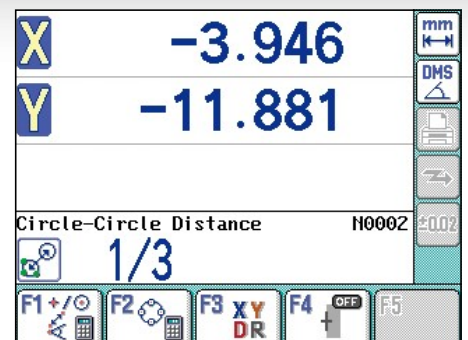

Magnified counter screen

*1 To denote your AC power cable add the following suffixes to the order No.: A for UL/CSA, D for CEE, 00 for CCC (power cord for CCC and User's Manual set of Simplified Chinese are provided for separately), E for BS, K for KC, C and No suffix are required for PSE.

*2 The arm-mount type cannot be used concurrently with a counter stand.
Note: For details, refer to the QM-Data200 and Vision Unit brochure.

Accessory

Rotary tables

Used for rotating the workpiece on the stage without needing to handle it.

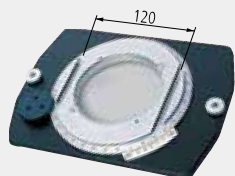

172-198



176-305



176-306

Order No.	172-198	176-305	176-306
Product Name	Rotary table with fine feed wheel	Rotary table with fine feed wheel A	Rotary table with fine feed wheel B
Rotary stage size	146 mm / 5.7"	240 mm / 9.4"	270 mm / 10.6"
Fine adjustment	✓	✓	✓
Effective glass diameter	96 mm / 3.8"	182 mm / 7.2"	238 mm / 9.4"
Minimum angle reading	2°	—	—
External dimensions (WxDxH)	240 x 172 x 19.7 mm / 9.4" x 6.8" x .78"	280 x 280 x 23.7 mm / 11" x 11" x .93"	342 x 342 x 23.2 mm / 13.4" x 13.4" x .91"
Mass	2.4 kg / 5.3 lbs	5.5kg / 12.1lbs	6.5kg / 14.3kg
Applicable models	PJ-PLUS Series	✓ ^{*1}	—
	PJ-H30 Series	✓ ^{*1}	✓
	PV-5110	✓ ^{*2}	—

*1 Since the rotary stage section is small, if it is used for a large stage, some restrictions may be imposed on the measuring range.

*2 When using a 50X or a 100X projection lens, you need to remove the stage glass in order to prevent a collision between the stage glass for X/Y stage and the projection lens.

*3 It is possible to set for only the 2010 size.

Holder with clamp

Used for clamping down a thin workpiece, such as a board or a pressed product.

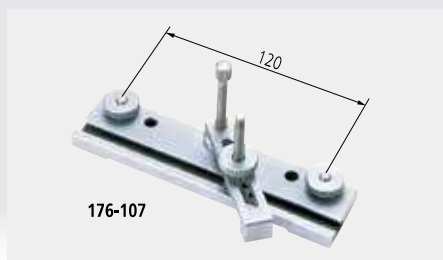

176-107

Order No.	176-107
Applicable models	PJ-PLUS Series PJ-H30 Series PV-5110
Maximum width to be clamped	0 to 35mm / 1.4"
Mass	0.4 kg / .88 lbs

V-block with clamp

Used for clamping a cylinder.



172-234

172-378

Order No.	172-234	172-378
Applicable models	PH-3515F / PH-A14	PJ-PLUS Series PJ-H30 Series PV-5110
Maximum workpiece diameter to be clamped	50 mm / 2"	25 mm / 1"
Central height from a mounting surface	38 to 48 mm / 1.5" to 1.89"	38 to 48 mm / 1.5" to 1.89"
Mass	1.24 kg / 2.7"	0.8 kg / 1.8 lbs

Swivel center support

Used for holding a center-drilled workpiece. Since an inclination of ±10 degrees can be set, it is suitable for helping measure the depth and flank angle of threads.



172-197

Order No.	172-197
Applicable models	PJ-PLUS Series PJ-H30 Series PV-5110
Maximum workpiece size to be clamped*	80 mm / 3.1" (65 x 140mm / 2.6" x 5.5")
Inclination	±10°
Mass	2.5 kg / 5.5 lbs

* The maximum measurable dimension varies according to the projection magnification. Dimension in parentheses is that for an inclination of 10°.

Adapter

This enables a workpiece clamping option, such as the holder with clamp or the swivel center support, to be attached to the X/Y stage of the projector.

Order No.	176-304	176-310	176-317
Product Name	Stage adapter	Stage adapter (B)	Stage adapter (C)
External dimensions (WxDxH)	50 x 340 x 15 mm / 2" x 13.4" x .6"	50 x 280 x 15 mm / 2" x 11" x .6"	73 x 278 x 17 mm / 2.9" x 11" x .67"
Mass	1.5 kg / 3.3 lbs	1.2 kg / 2.64 lbs	1.8 kg x 3.96 lbs
Applicable models	PJ-PLUS	✓	—
	PJ-H30	✓	✓
	PV-5110	—	✓

Accessories (Optional)

Rotary vise

Used for clamping a workpiece. It rotates the horizontal plane.



172-144

Order No.	172-144
Applicable models	PH-3515F PH-A14
Rotation range	360°
Size between mounting surface and top surface	76 mm / 3"
Minimum angle reading	5°
Mass	2.8 kg / 6.2 lbs

Center supports

Used for holding a center-drilled workpiece.



172-142

Order No.	172-142
Applicable models	PH-3515F PH-A14
Maximum workpiece diameter to be clamped	120 mm / 4.7" / (240 mm / 9.4")*
Mass	3.3 kg / 7.3 lbs

* When center support risers (172-143) are used.

Center support risers

These are used to raise the center supports to a more convenient working height, or to enable a larger diameter workpiece to be inspected.



172-143

Order No.	172-143
Applicable models	PH-3515F PH-A14
Height	60 mm / 2.4"
Mass	2.2 kg / 4.8 lbs

Vertical holder

Used for holding small thin parts.



172-132

Order No.	172-132
Applicable models	PH-3515F PH-A14
Glass size	—
Mass	1.3 kg / 2.9 lbs

Standard scale

Glass scale used for checking magnification accuracy

172-116



Order No.	172-116	172-330	172-117
Range	50 mm	80 mm	2 in
Graduation	0.1 mm		0.01 in
Accuracy (20 °C)	(3+5L/1000) μm L=Measured length (mm)		(120+5L)×10 ⁻⁶ in L=Measured length (in)

Working standard scale (Made to order)

- Although the reference scale is used for checking the indication accuracy of the X/Y table, it also substitutes for a standard scale or a reading scale. A substitute for the standard scale is HL1, and that for the reading scale is HL2.
- Refer to page 15 for details of 14005 brochure.



Order No.	182-511-30*	182-512-30*	182-522-30*	182-523-30*	182-525-30*
Code	HL1-50	HL1-100	HL2-200	HL2-300	HL2-500
Range (mm)	50	100	200	300	500
Length (mm)	75	125	230	330	530
Graduation line thickness (μm)	20				
Material	Soda-lime glass				
Accuracy (20 °C) (μm)	1.5+2L/1000 L=Measured length (mm)				

* If the specified code No. ends with "-30," we will attach a calibration certificate.
Note: The unit of the working standard scales is mm only.

Reading scale

Glass scale specially designed for inspecting the magnified image of a standard scale on the projection screen

172-118

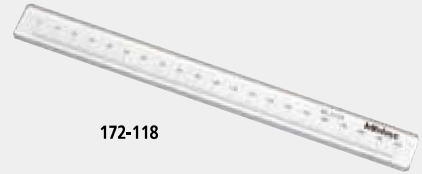

Order No.	172-118	172-161	172-329	172-119	172-162
Range	200 mm	300 mm	600 mm	8 in	12 in
Graduation	0.5 mm			0.02 in	
Accuracy (20 °C)	(15+15L/1000) μm L=Measured length (mm)			(600+15L)×10 ⁻⁶ in L=Measured length (in)	

Dimensions

Unit: mm

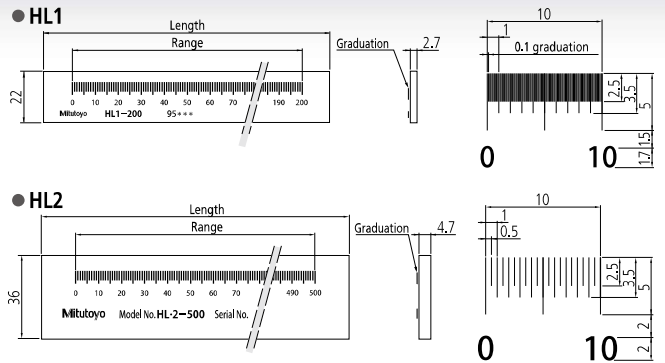

Accessory

Green filter

These filters are for adjusting image contrast, and are inserted in the transmitted illumination section during use.



Order No.	172-160-3	12AAG981	172-160-2	172-286
Applicable models	PJ-PLUS	PJ-H30	PV-5110	PH-3515F PH-A14
External dimensions (WxD) mm	50 x 110 (2" x 4.3")	195 x 260 (7.7" x 10.2")	50 x 167 (2" x 6.6")	58 x 120 (2.3" x 4.7")
Mass	0.3 kg / .66lbs	0.44 kg / .97 lbs	0.3 kg / .66lbs	

OPTOEYE 200 (Projected image position detecting device)



PJ-PLUS with OPTOEYE 200



OPTOEYE 200 and detector mounting plate A

- An edge detecting device for improving the measuring efficiency and reliability of a profile projector by removing the need to position the cross hairs on an edge manually. This has the effect of eliminating the operator variability factor from data entry and shortening the measurement time.
- The detector uses an optical fiber that can be easily fixed on the screen with chart clips.
- The device is provided with an error detection function that works if the screen light intensity changes.
- This device can be retrofitted onto the QM-Data200 and does not need an AC adapter since power is supplied from the QM-Data200 through the connecting cable.
- When using the Optoeye system, there are two ways to connect: connection to the projector main unit via an RS-232C cable, or direct connection of the projector main unit's X- and Y-axis linear scales to QM-Data200.
- This system can be used in combination with the QM-Data200 but is only available for the PJ-H30A. (PJ-H30D does not need this system because it has a built-in Optoeye sensor.)

Order No.	332-151
Model	OPT-200
Illumination	Contour/surface ^{*1}
Detecting directivity	Non-directional
Minimum detectable circle	ø2 mm
Minimum detectable line width	1 mm
Maximum response speed	1000 mm/s
Illumination range (Bright)	30 to 1500 ℓX
Bright-Dark field difference	20 ℓX or higher
Repeatability (contour illumination)	$\sigma = 1 \mu\text{m}^2$

*1, *2 Mitutoyo's test conditions.

Configuration of standard accessories	
Electronic unit	
Detector: Optical fiber: 1950 mm	
Connecting cable: For connecting electrical component main unit and QM-Data200	
Fixture for QM-Data200 (12BAG139): For fixing the electrical component main unit to QM-Data200	

Note: Detector mounting plate is an optional accessory.

Built-in OPTOEYE (only PJ-H30D)



PJ-H30D	Detecting sensor: Built into center of screen, non-directional illumination ^{*3} , Minimum detectable circle: ø2 mm (projected image size), Minimum line width: 1mm (projected image size), Repeatability: $\sigma = 1 \mu\text{m}^4$
---------	--

*3 This may be undetectable depending on the illumination conditions.

*4 Mitutoyo test conditions.

Accessories (Optional)

Accessory

■ Overlay charts

To quickly check an image projected on the screen, an appropriate chart is used. 13 types of overlay charts are available according to the application.

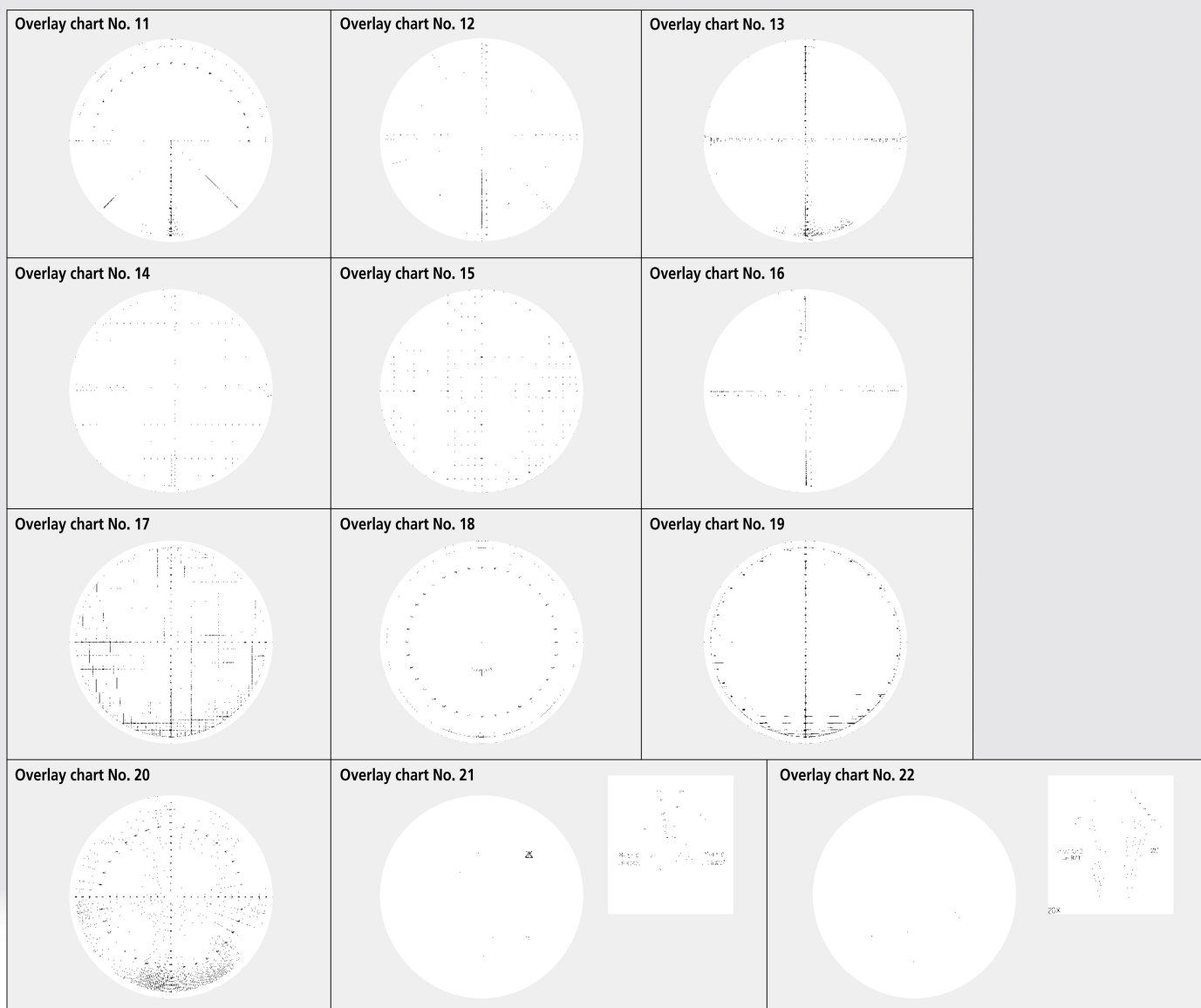

Product name	Order No.	Specification
Overlay charts Set of 12	12AAM027	Set of 12 charts (Overlay charts No.11 – No.22)
Overlay chart No.11	12AAM587	Upper side: radial lines (at intervals of 1°) Lower side: concentric circles (at intervals of 1 mm in radius)
Overlay chart No.12	12AAM588	Concentric circles (at intervals of 5 mm in radius) with cross hairs (1 mm graduation)
Overlay chart No.13	12AAM589	Concentric circles (at intervals of 1 mm in radius) with cross hairs
Overlay chart No.14	12AAM590	Horizontal: Parallel lines at intervals of 50 mm (50-times enlargement of 1 mm) Vertical: Parallel lines at intervals of 20 mm (20-times enlargement of 1 mm)
Overlay chart No.15	12AAM591	10 mm-interval grids
Overlay chart No.16	12AAM592	Cross hairs (0.5 mm graduation)

Product name	Order No.	Specification
Overlay chart No.17	12AAM593	1 mm-interval grids
Overlay chart No.18	12AAM594	1°-interval radial lines
Overlay chart No.19	12AAM595	Horizontal: 1 mm-interval parallel lines
Overlay chart No.20	12AAM596	Concentric circles (at intervals of 1 mm in radius) and radial lines (at intervals of 1°)
Overlay chart No.21	12AAM597	Metric screw for 20X lens: P = 0.2 to 2 mm Unified screw: 28 to 12 threads/in Whitworth screw: 20 to 10 threads/in
Overlay chart No.22	12AAM598	Metric screw for 100X lens: P = 0.08 to 0.25 mm Involute tooth profile for 20X lens (reference rack tooth profile) 20°m: 0.2 to 1 14.5°m: 0.2 to 1
Overlay chart (Staggered cross-hairs)	12AAM599	Solid lines + Staggered cross-hairs

Quick guide to Profile Projectors

Basic knowledge

■ Erect Image and Inverted Image

An image of an object projected onto a screen is erect if it is orientated the same way as the object on the stage. If the image is reversed top to bottom, left to right and by movement with respect to the object on the stage (as shown in the figure below) it is referred to as an inverted image (also known as a reversed image).

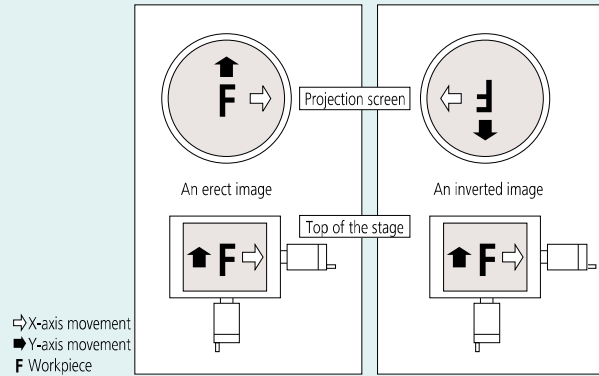

■ Magnification Accuracy

The magnification accuracy of a projector when using a certain lens is established by projecting an image of a reference object and comparing the size of the image of this object, as measured on the screen, with the expected size (calculated from the lens magnification, as marked) to produce a percentage magnification accuracy figure, as illustrated below. (Note that magnification accuracy is not the same as measuring accuracy.)

$$\Delta M (\%) = \frac{L - IM}{IM} \times 100$$

$\Delta M (\%)$: Magnification accuracy expressed as a percentage of the nominal lens magnification
 L : Length of the projected image of the reference object measured on the screen
 I : Length of the reference object
 M : Magnification of the projection lens

Nominal magnification: Magnification displayed on the projection lens.

■ Type of Illumination

- **Contour illumination:** An illumination method to observe a workpiece by transmitted light and is used mainly for measuring the magnified contour image of a workpiece.
- **Coaxial surface illumination:** An illumination method whereby a workpiece is illuminated by light transmitted coaxially to the lens for the observation/ measurement of the surface. (A half-reflecting mirror or a projection lens with a built-in half-reflecting mirror is needed).
- **Oblique surface illumination:** A method of illumination by obliquely illuminating the workpiece surface. This method provides an image of enhanced contrast, allowing it to be observed three-dimensionally and clearly. However, note an error is apt to occur in dimensional measurement with this method of illumination.
(An oblique mirror is needed. Models in the PJ-H30 Series are supplied with an oblique mirror.)

■ Telecentric Optical System

This is an optical system where the principal ray is aligned parallel to the optical axis by placing a lens stop on the focal point on the image side. Its functional feature is that the image will not vary in size though the image blurs as the object is shifted along the optical axis.

For measuring projectors and measuring microscopes, an identical effect is obtained by placing a lamp filament at the focal point of a condenser lens instead of a lens stop so the object is illuminated with parallel beams. (See the figure below.)

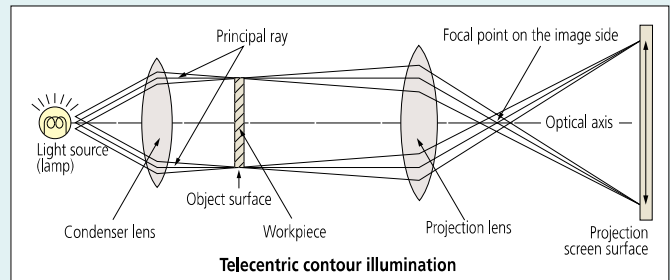

■ Working distance

Refers to the distance from the face of the projection lens to the surface of a workpiece in focus. It is represented by L in the diagram below.

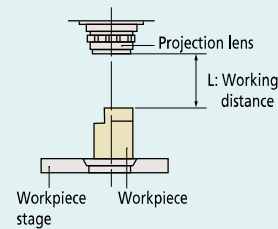

■ Parallax error

This means an error resulting from variations in the line of sight when reading a scale.

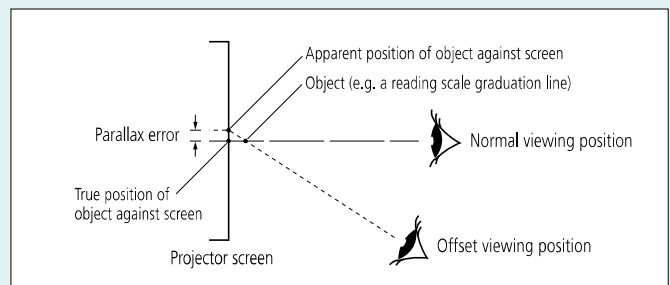

■ Field of view diameter

The maximum diameter of workpiece that can be projected using a particular lens.

$$\text{Field of view diameter (mm)} = \frac{\text{Screen diameter of profile projector}}{\text{Magnification of projection lens used}}$$

Example: If a 5X magnification lens is used for a projector with a screen of $\phi 500\text{mm} / 19.6''$:
 Field of view diameter is given by $\frac{500\text{mm} / 19.6''}{5} = 100\text{mm}$

The $\phi 100\text{mm}$ range is projected over the entire projection screen.



**Whatever your challenges are,
Mitutoyo supports you from start to finish.**

Mitutoyo is not only a manufacturer of top quality measuring products but one that also offers qualified support for the lifetime of the equipment, backed by comprehensive services that ensure your staff can make the very best use of the investment.

Apart from the basics of calibration and repair, Mitutoyo offers product and metrology training, as well as IT support for the sophisticated software used in modern measuring technology. We can also design, build, test and deliver measuring solutions and even, if deemed cost-effective, take your critical measurement challenges in-house on a sub-contract basis.



**Find additional product literature
and our product catalog**

www.mitutoyo.com

Note: All information regarding our products, and in particular the illustrations, drawings, dimensional and performance data contained in this printed matter as well as other technical data are to be regarded as approximate average values. We therefore reserve the right to make changes to the corresponding designs. The stated standards, similar technical regulations, descriptions and illustrations of the products were valid at the time of printing. In addition, the latest applicable version of our General Trading Conditions will apply. Only quotations submitted by ourselves may be regarded as definitive. Specifications are subject to change without notice.

Mitutoyo products are subject to US Export Administration Regulations (EAR). Re-export or relocation of our products may require prior approval by an appropriate governing authority.

Trademarks and Registrations

Designations used by companies to distinguish their products are often claimed as trademarks. In all instances where Mitutoyo America Corporation is aware of a claim, the product names appear in initial capital or all capital letters. The appropriate companies should be contacted for more complete trademark and registration information.

Mitutoyo

Mitutoyo America Corporation

www.mitutoyo.com

One Number to Serve You Better

1-888-MITUTOYO (1-888-648-8869)

M³ Solution Centers:

Aurora, Illinois (Headquarters)

Boston, Massachusetts

Charlotte, North Carolina

Cincinnati, Ohio

Detroit, Michigan

Los Angeles, California

Birmingham, Alabama

Seattle, Washington

Houston, Texas