

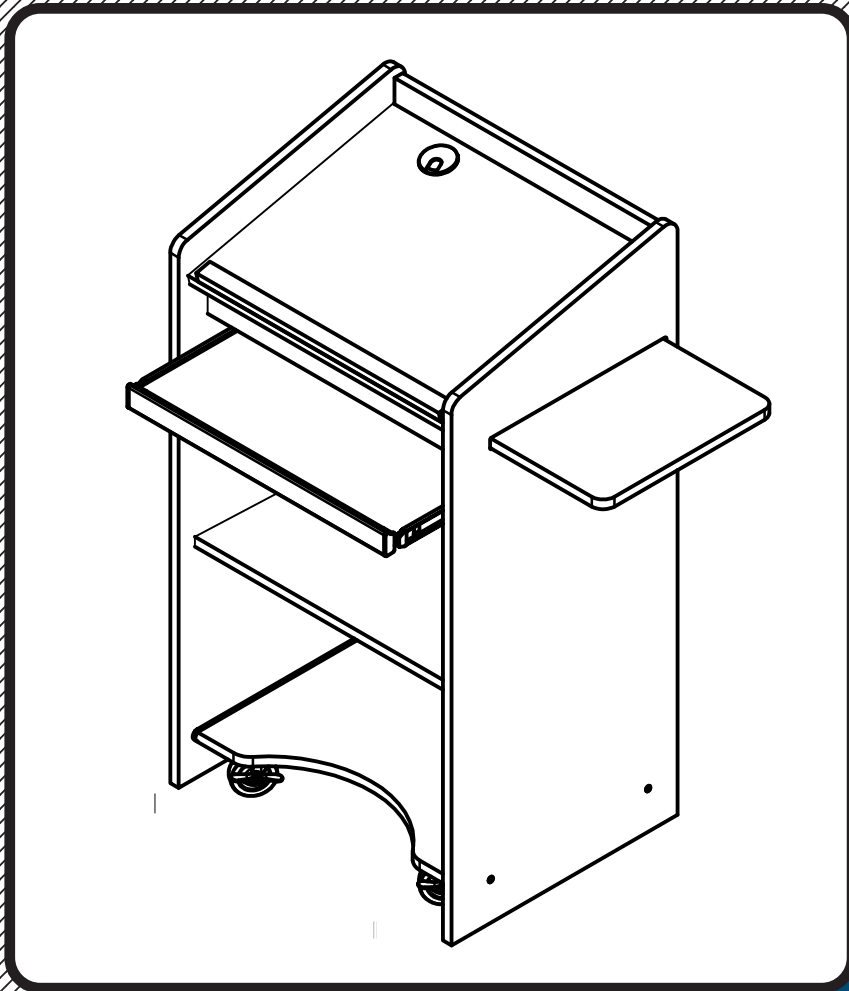

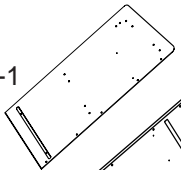

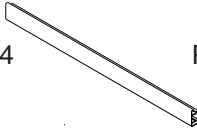

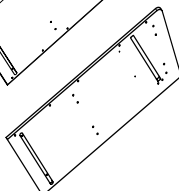



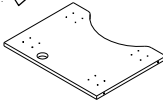

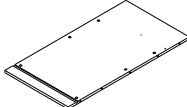
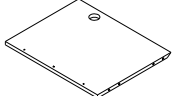

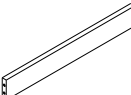

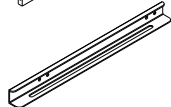
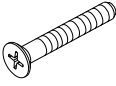
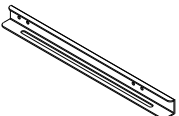
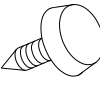
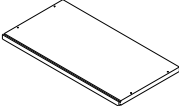
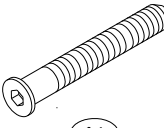
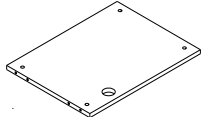
27508, 27510

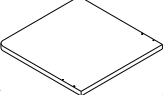
Floor Lectern

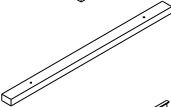
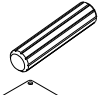
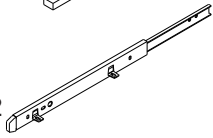
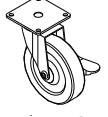
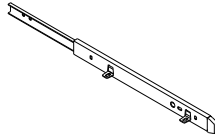

Assembly Instructions

Part	Drawing	Description	Qty	Part	Drawing	Description	Qty
P-1		Left Side Panel	1 EA	P14		Plastic Extrusion	1 EA
P-2		Right Side Panel	1 EA	P15		Left Plastic endcap	1 EA
P-3		Bottom Shelf	1 EA	P16		Right Plastic endcap	1 EA
P-4		Back Panel	1 EA	Hardware List			
P-5		Slanted Top Panel	1 EA	A		Pan Hd Screw #10x11/16	24 EA
P-6		Shelf Support	1 EA	A1		CS Wood Screw #6x5/8	4 EA
P-7L		Left Metal Bracket	1 EA	A2		Phil Screw M6 X32mm	2 EA
P-7R		Right Metal Bracket	1 EA	A3		ThumbScrew #6x 7/16	2 EA
P-8		Laptop Shelf	1 EA	B		Wood Screw M7X50mm	4 EA
P-9		Middle Shelf	1 EA	C		Cam Lock	14 EA
P-10		Side Shelf	1 EA	D		Cam Post	14 EA
P-11		Book Stop	1 EA	E		Wood Dowel	16 EA
P-12		Left Keyboard Slide	1 EA	F		3" Locking Plate Caster	2 EA
P-13		Right Keyboard Slide	1 EA	G		3" Plate Caster	2 EA
				H		Grommet Sleeve	3 EA
				J		Grommet Cap	3 EA
				K		Allen Wrench	1 EA
				Tools required: Phillips Head Screwdriver			

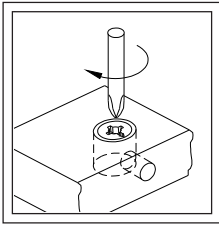

Note:
Camlocks can be turned with Allen Wrench, or Large Phillips Screwdriver

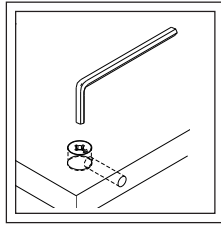

Assembly Diagram

To Assemble:

1. Identify and Separate all the Parts and Hardware.

2. Place the Right Side Panel (P-2) with the Predrilled holes facing up and install 7 each Cam Posts (D) in the 7 threaded insert nuts (Pre-installed) as shown in illustration # 1.

3. Install 8 each Wood Dowels (E) into the holes as shown in illustration # 1.

4. Attach Right Keyboard Slide (P-13) to the Right Side Panel (P-2) using 2 each Screws (A) as shown in illustration # 1.

5. Place the Left Side Panel (P-1) with the Predrilled holes facing up and install 7 each Cam Posts (D) in the 7 threaded insert nuts (Pre-installed) as shown in illustration # 2.

6. Install 8 each Wood Dowels (E) into the holes as shown in illustration # 2.

7. Attach Left Keyboard Slide (P-12) to the Right Side Panel (P-2) using 2 each Screws (A) as shown in illustration # 2.

Illustration # 1

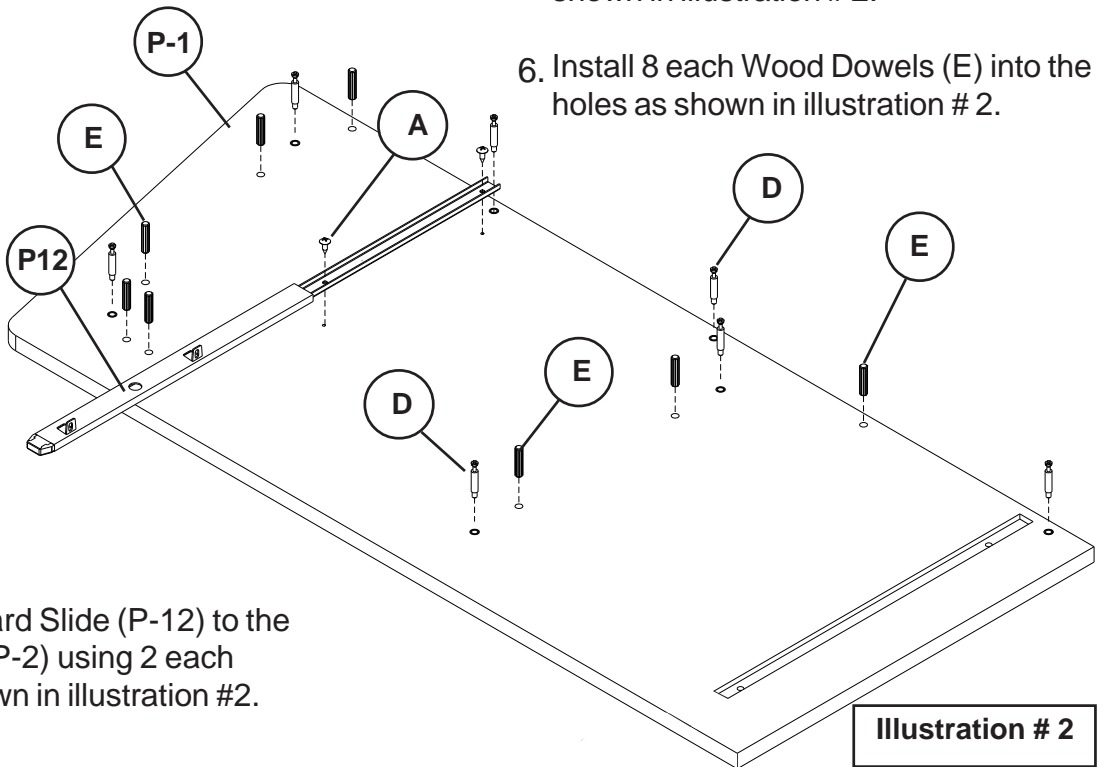
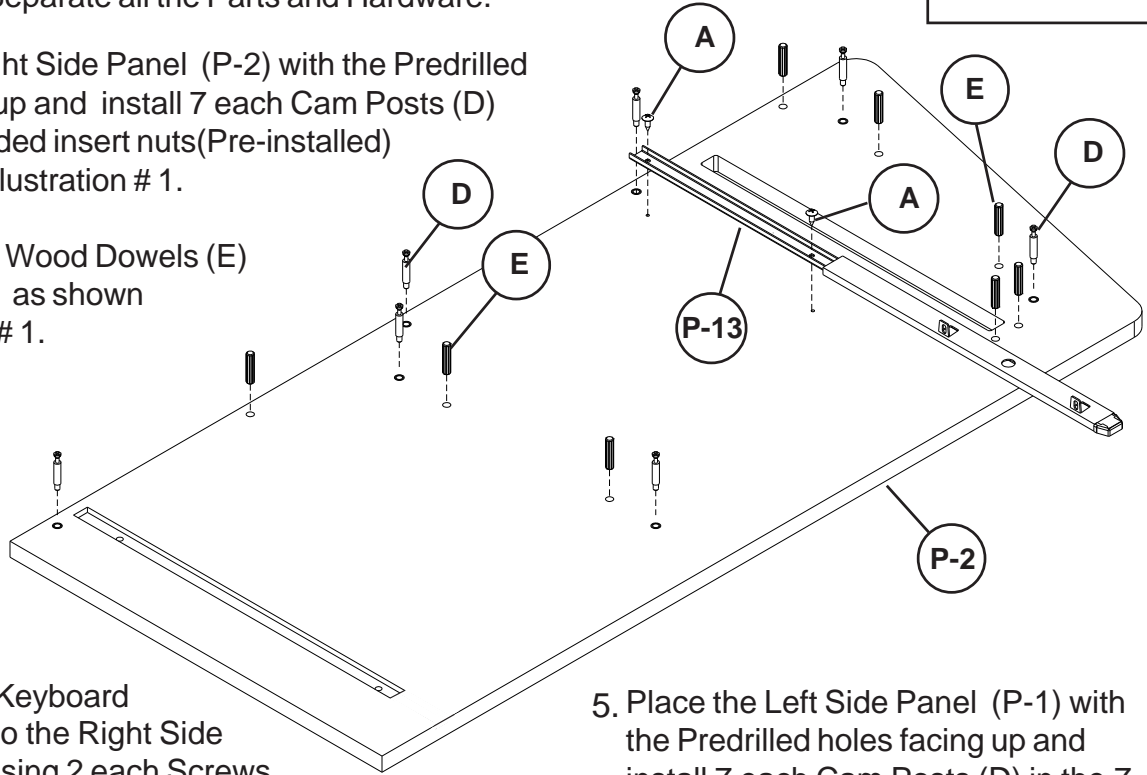

Illustration # 2

8. Place the Back Panel (P-4) with the Pre-drilled holes facing up and install 6 each Cam Locks (C) in the 6 large holes as shown in illustration # 3.

9. Attach Right Metal Bracket (P-7R) to Back Panel (P-4) using 2 Screws (A1) as shown in illustration # 3.

Illustration # 3

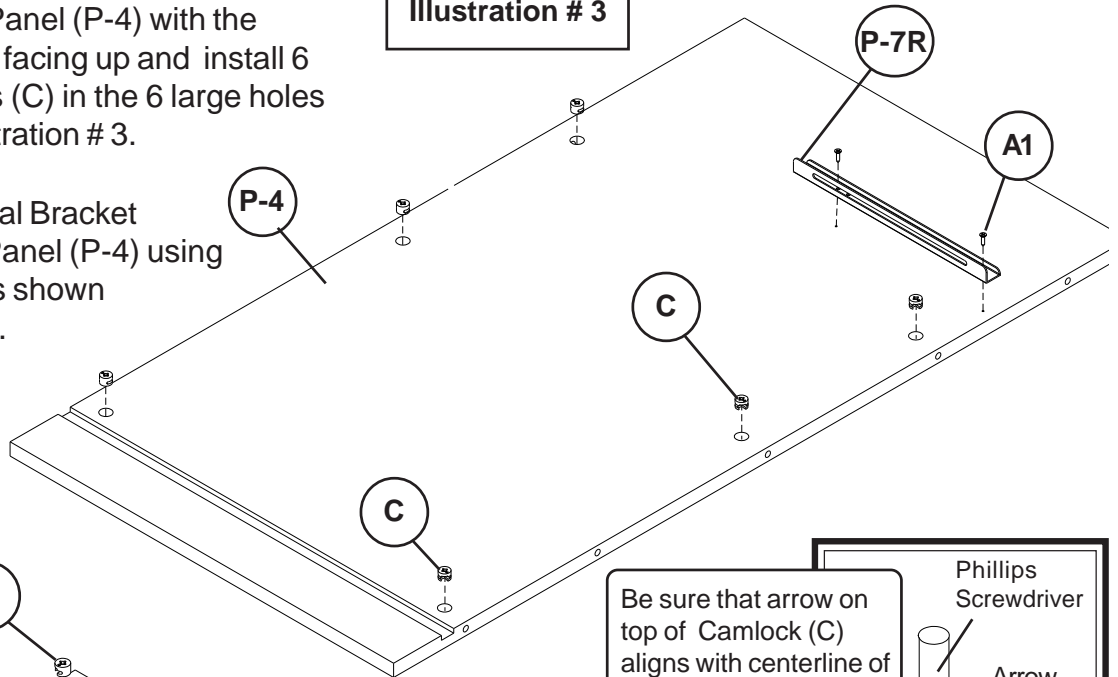
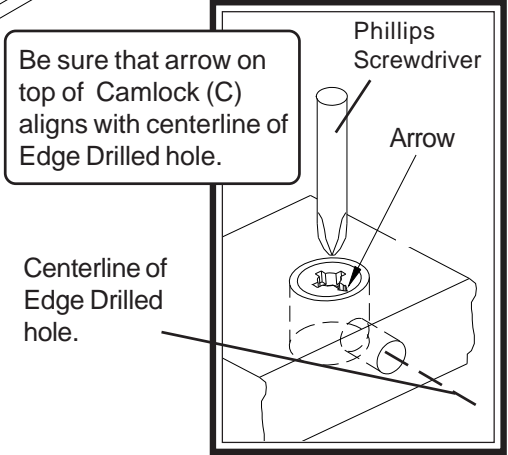
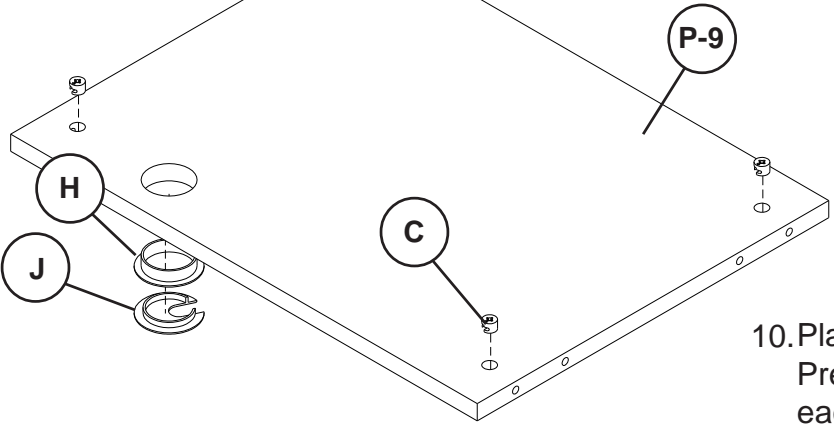

Illustration # 4



10. Place the Middle Shelf (P-9) with the Pre-drilled holes facing up and install 4 each Cam Locks (C) in the 4 large holes as shown in illustration # 4.

11. Insert 1 Grommet Sleeve (H) in Round opening in Middle Shelf (P-9) as shown in illustration #4.

12. Snap Grommet Cap (J) into Grommet Sleeve (H) as shown in illustration #4.

13. Locate Bottom Shelf (P-3) and Insert 1 Grommet Sleeve (H) in round opening as shown in illustration #5.

14. Snap Grommet Cap (J) into Grommet Sleeve (H) .

Illustration # 5

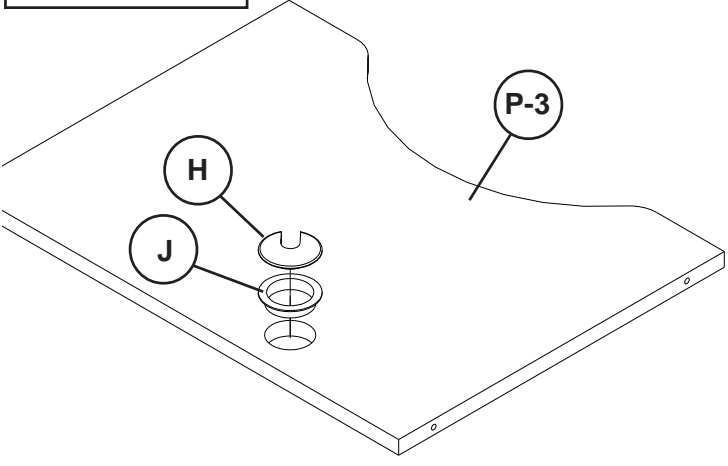

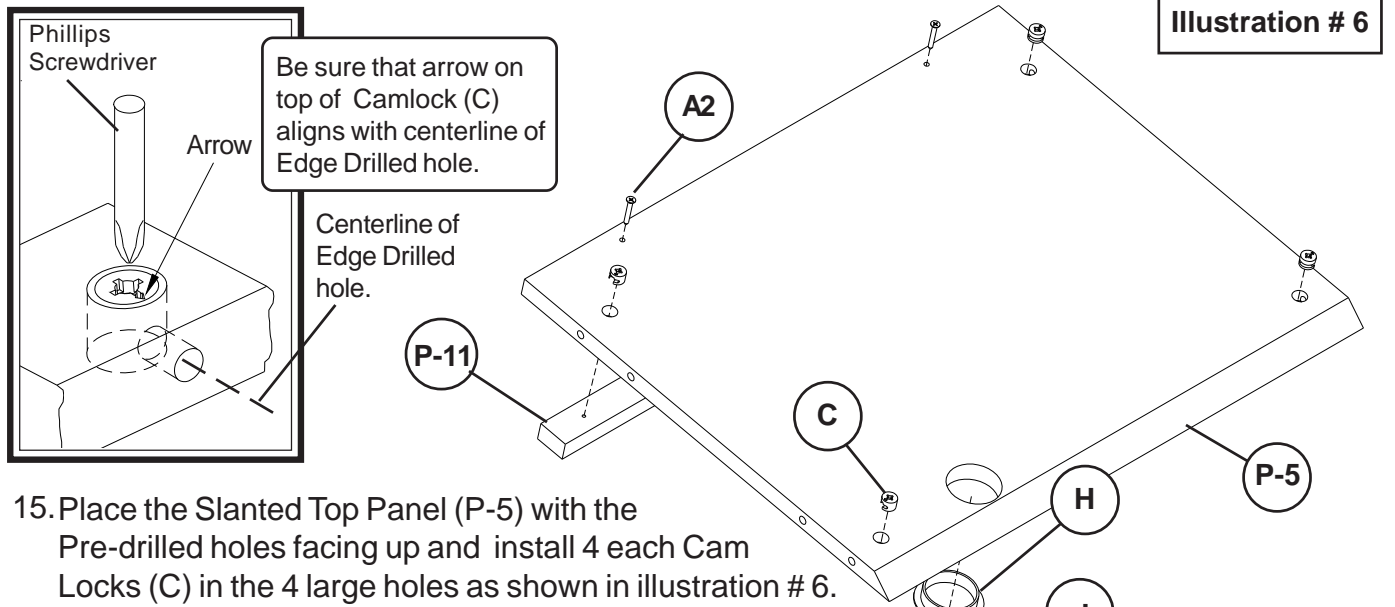

15. Place the Slanted Top Panel (P-5) with the Pre-drilled holes facing up and install 4 each Cam Locks (C) in the 4 large holes as shown in illustration # 6.

16. Attach Book Stop (P-11) to Slanted Top Panel (P-5) using 2 Screws (A2) as shown in illustration # 6.

17. Insert Grommet Sleeve (H) in round opening in Slanted Top Platform (P-5) as shown in illustration # 6.

18. Snap Grommet Cap (J) into Grommet Sleeve (H) as shown in illustration # 6.

19. Place the Shelf Support (P-6) with the Pre-drilled holes facing up and attach Left Metal Bracket (P-7L) using 2 Screws (A1) as shown in illustration # 7.

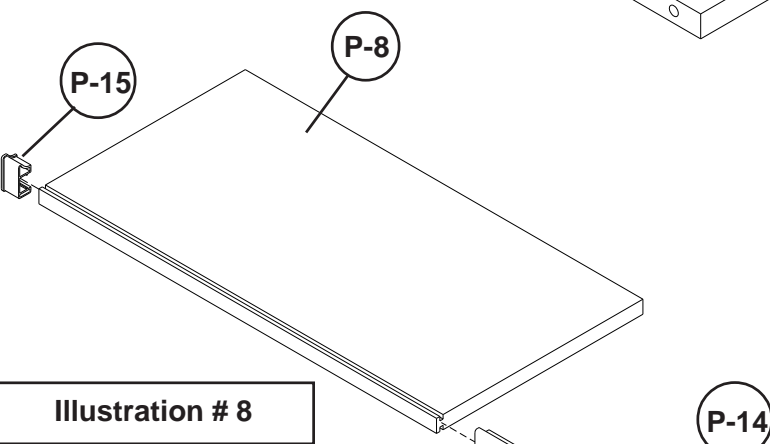
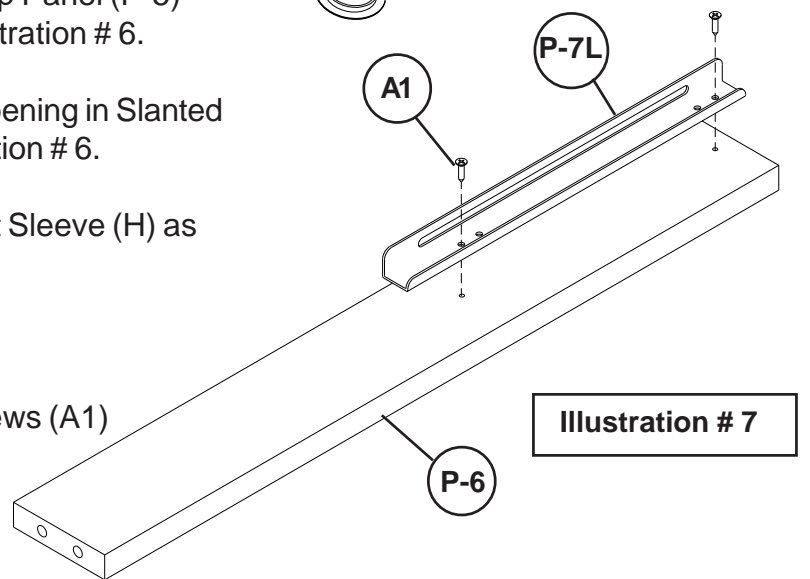

20. Slide 1 Plastic extrusion (P-14) over the front of Laptop Shelf (P-8) as shown in illustration # 8. Attach 1 Left Plastic Endcap (P15) and 1 Right Plastic Endcap (P-16).

Illustration # 9

To Secure Cam Locks, Insert Large Phillips Head Screwdriver and turn Cam Lock 1/4 turn (90 degrees) clockwise.

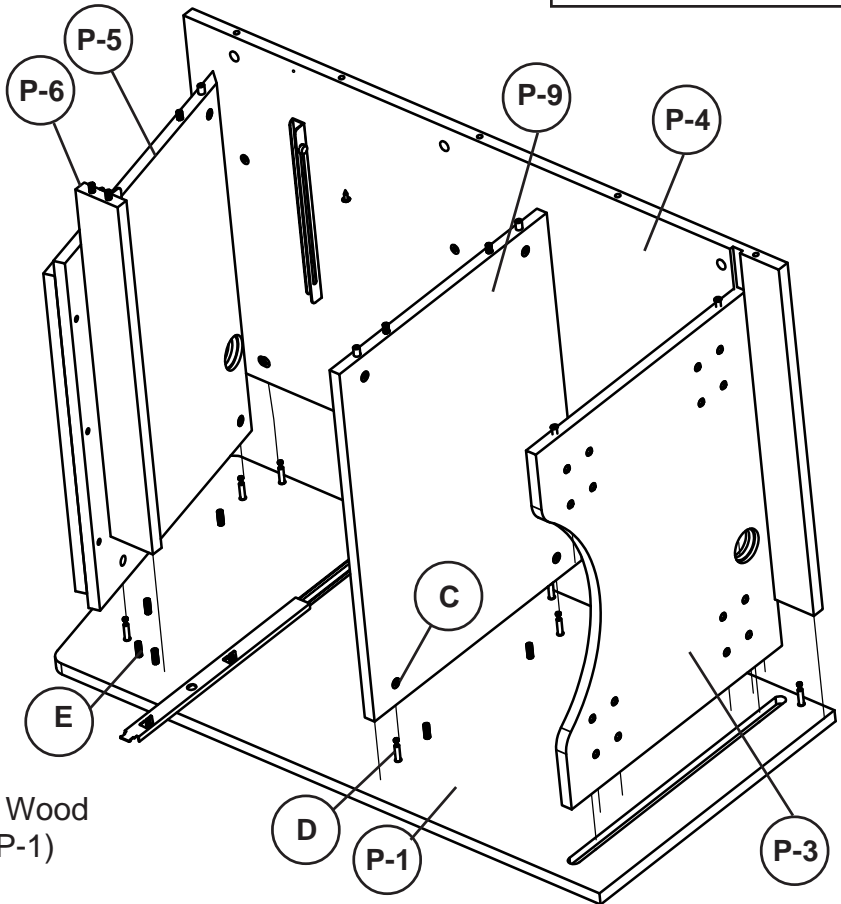
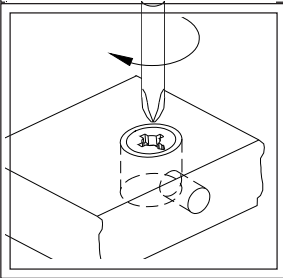

21. Slide Slanted Top Panel (P-5), Middle Shelf (P-9), Bottom Shelf (P-3) and Back Panel (P-4) over the Wood Dowels (E) and the Camposts (D) in the Left Side Panel (P-1) as shown in illustration #9. Secure by turning the Cam Locks (C) 1/4 turn until they lock.

22. Slide Shelf Support (P-6) over the Wood Dowels (E) in the Left side Panel (P-1) as shown in illustration # 9.

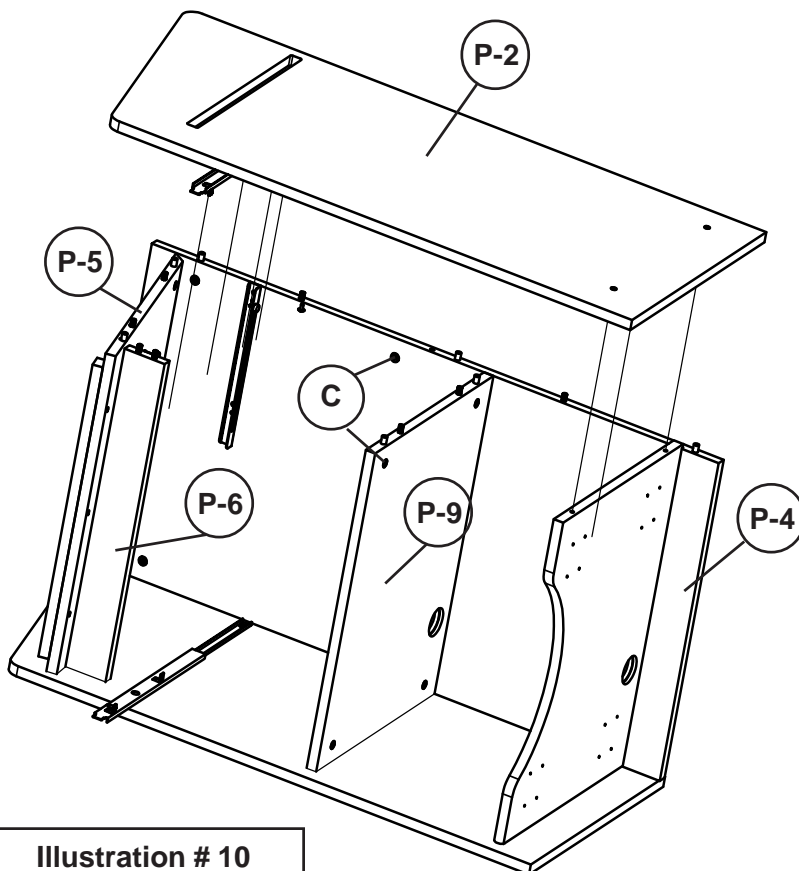

23. Slide Wood Dowels (E), and Camposts (D) in Right Side Panel (P-2) into the holes in the Slanted Top Shelf (P-5), Middle Shelf (P-9), Bottom Shelf (P-

24. Secure by turning the Cam Locks (C) 1/4 turn until they lock.

Illustration # 10

Illustration # 11

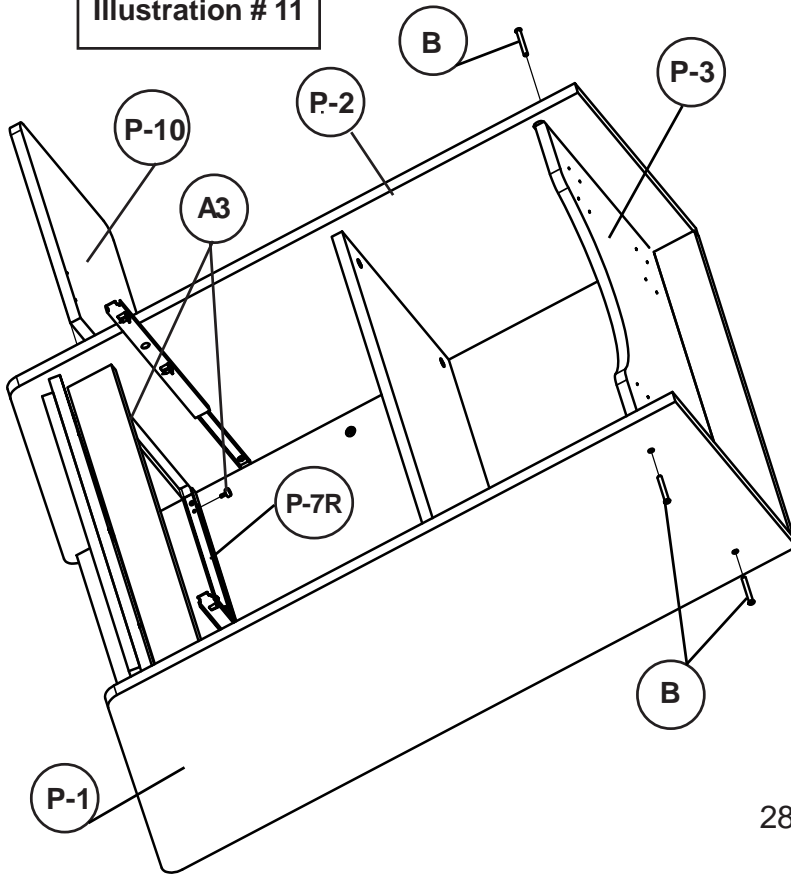

25. Slide Side Shelf (P-10) through the slot in Right Side Panel (P-2) and into the Metal Brackets (P-7L & P-7R) as shown in illustration #11.

26. Insert 2 thumbscrews (A3) through the slot in Metal Brackets (P-7) and into Side Shelf (P-10).
Finger Tighten Only.

27. Secure Bottom Shelf (P-3) to the Left Side Panel (P-1) and the Right Side Panel (P-2) using 4 Wood Screws (B) as shown in illustration # 11.

28. Attach 2 Locking Plate Casters (F) and 2 Plate Casters (G) to the Bottom shelf (P-3) using 16 screws (A) as shown in illustration # 12. Tighten (A) Screws using Phillips Head Screwdriver.

29. Attach Laptop Shelf (P-8) to Left Keyboard Slide (P-12) and Right Keyboard Slide (P-13) using 4 Wood Screws (A) as shown in illustration # 12.

30. Tighten Screws (A) using Phillips Screwdriver.

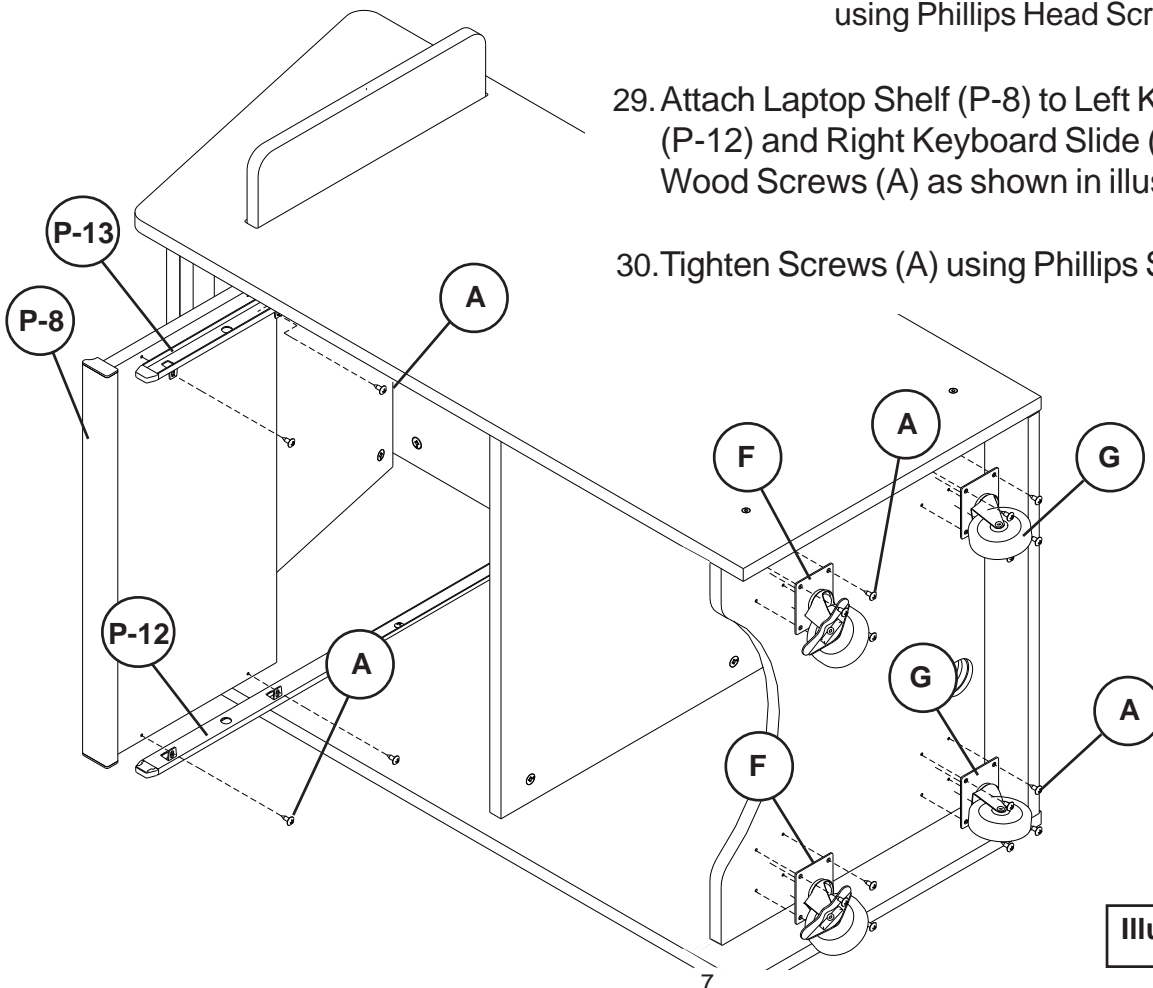

Illustration # 12

27508, 27510

Floor Lectern

