

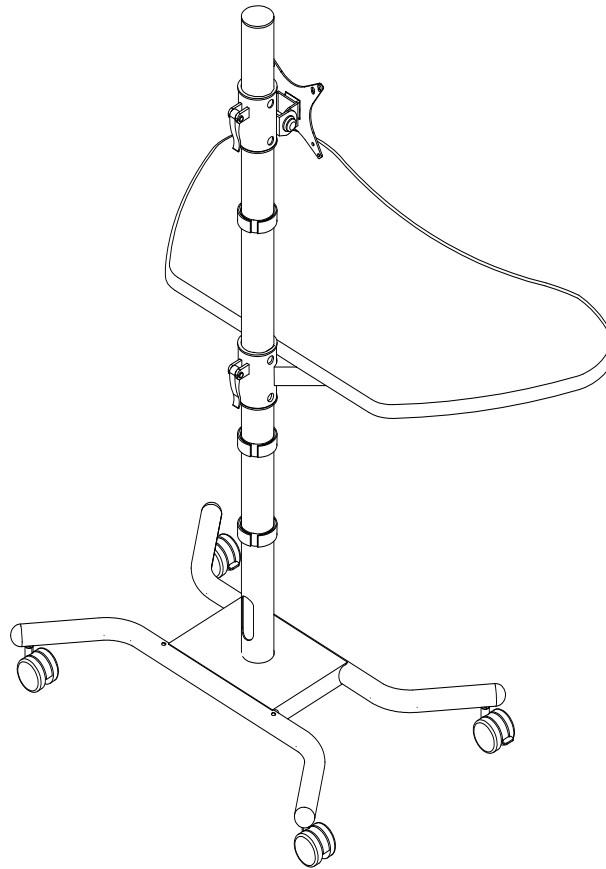

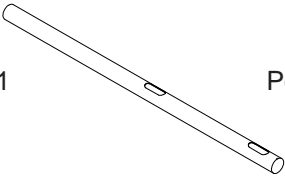









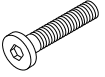

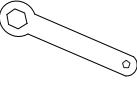





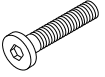

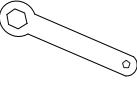



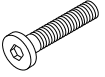

# #90329 WOW Flexi-Desk

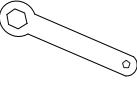

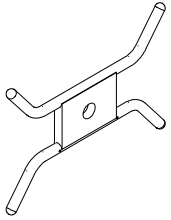
## Assembly Instructions

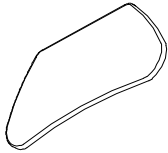
# #90329 WOW Flexi-Stand

Part	Drawing	Description	Qty	Part	Drawing	Description	Qty																																
P1		Pole	1 EA	<div style="border: 2px solid black; padding: 10px;"> <h3 style="text-align: center;">Hardware List</h3> <table border="0"> <tr> <td>A</td> <td></td> <td>2" Locking Caster</td> <td>2 EA</td> </tr> <tr> <td>B</td> <td></td> <td>2" Caster</td> <td>2 EA</td> </tr> <tr> <td>C</td> <td></td> <td>Castor Wrench</td> <td>1 EA</td> </tr> <tr> <td>D</td> <td></td> <td>M6x25mm</td> <td>4 EA</td> </tr> <tr> <td>E</td> <td></td> <td>M6x40mm</td> <td>4 EA</td> </tr> <tr> <td>F</td> <td></td> <td>Allen Wrench</td> <td>1 EA</td> </tr> <tr> <td>G</td> <td></td> <td>Wrench</td> <td>2 EA</td> </tr> <tr> <td>H</td> <td></td> <td>Cable Tie</td> <td>3 EA</td> </tr> </table> </div>				A		2" Locking Caster	2 EA	B		2" Caster	2 EA	C		Castor Wrench	1 EA	D		M6x25mm	4 EA	E		M6x40mm	4 EA	F		Allen Wrench	1 EA	G		Wrench	2 EA	H		Cable Tie	3 EA
A		2" Locking Caster	2 EA																																				
B		2" Caster	2 EA																																				
C		Castor Wrench	1 EA																																				
D		M6x25mm	4 EA																																				
E		M6x40mm	4 EA																																				
F		Allen Wrench	1 EA																																				
G		Wrench	2 EA																																				
H		Cable Tie	3 EA																																				
P2		Base	1 EA																																				
P3		Top Frame	1 EA																																				
P4		Top Panel	1 EA																																				
P5		Monitor Mount	1 EA																																				

# #90329

## Assembly Diagram

READ THROUGH INSTRUCTIONS FROM BEGINNING TO END **BEFORE** STARTING TO ASSEMBLE UNIT.

Illustration # 1

- 1.) Identify and Separate all the Parts and Hardware.
- 2.) Screw in two Locking Casters (A) into the bottom of the Base (P2) at the front. Screw in two Casters (B) into the bottom of Base (P-1) at the rear. The rear of the Base (P-2) has two holes on the top as shown in Illustration # 1. Tighten with Caster Wrench (C).

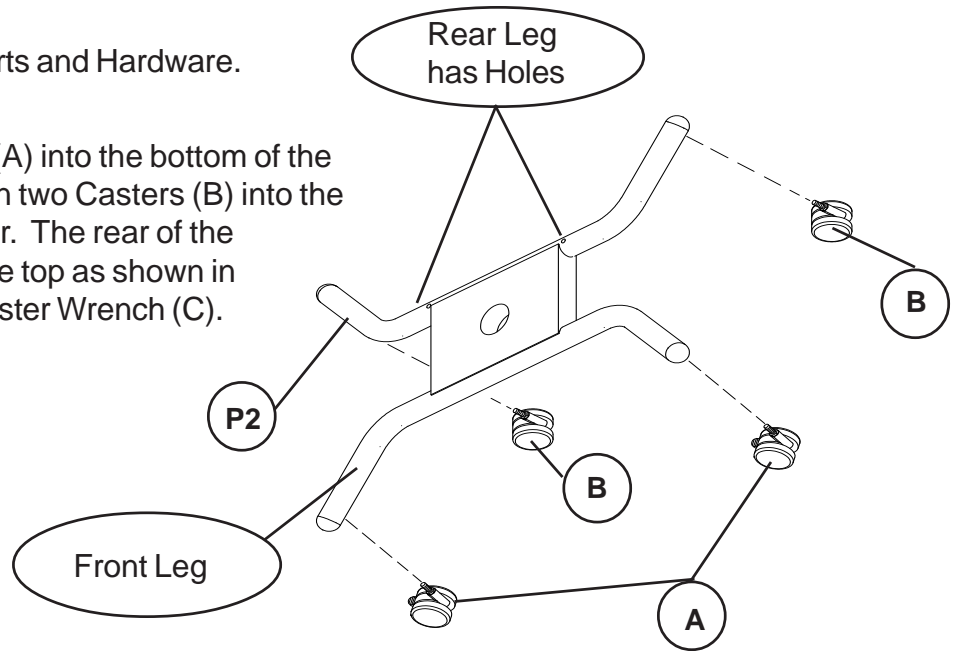

- 3.) Insert the Pole (P1) into the Base (P2). Make sure you place the end of the Pole that has the threaded insert into the Base as shown in illustration #2. Attach the Pole (P-1) to the Base (P-2) using four Screws (D). Tighten Screws with Allen Wrench (F).

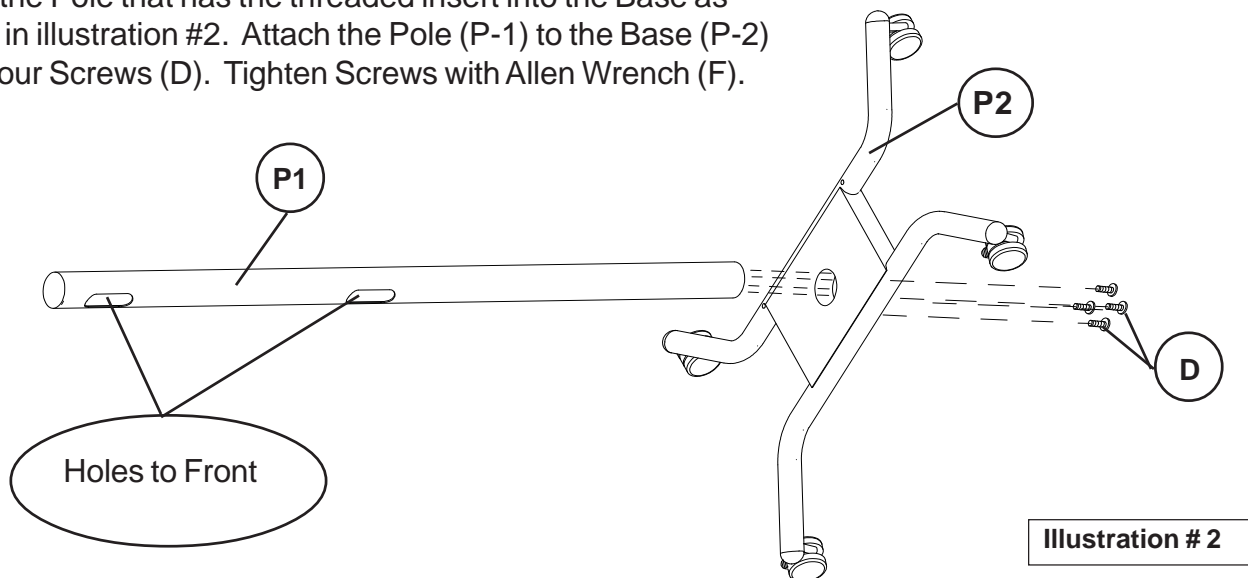
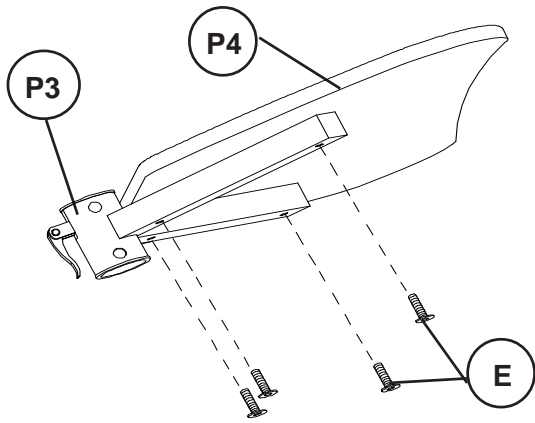

Illustration # 2



4.) Attach the Top Panel (P-4) to the Top Frame (P-3) using four Screws (E) as shown in illustration #3.

Illustration # 3

5.) Open up the Clamp Lever on the Top Panel Assembly. Place it on the Pole (P-1) and slide it down to the height level you like. Lock the Clamp Lever down to hold the Top Panel assembly in place on the Pole. See illustration #4.

6.) Open the Clamp Lever on the Monitor Mount (P-5) and slide it down the Pole (P-1) to the height you like. Lock the Clamp Lever down to hold the Monitor Mount in place.

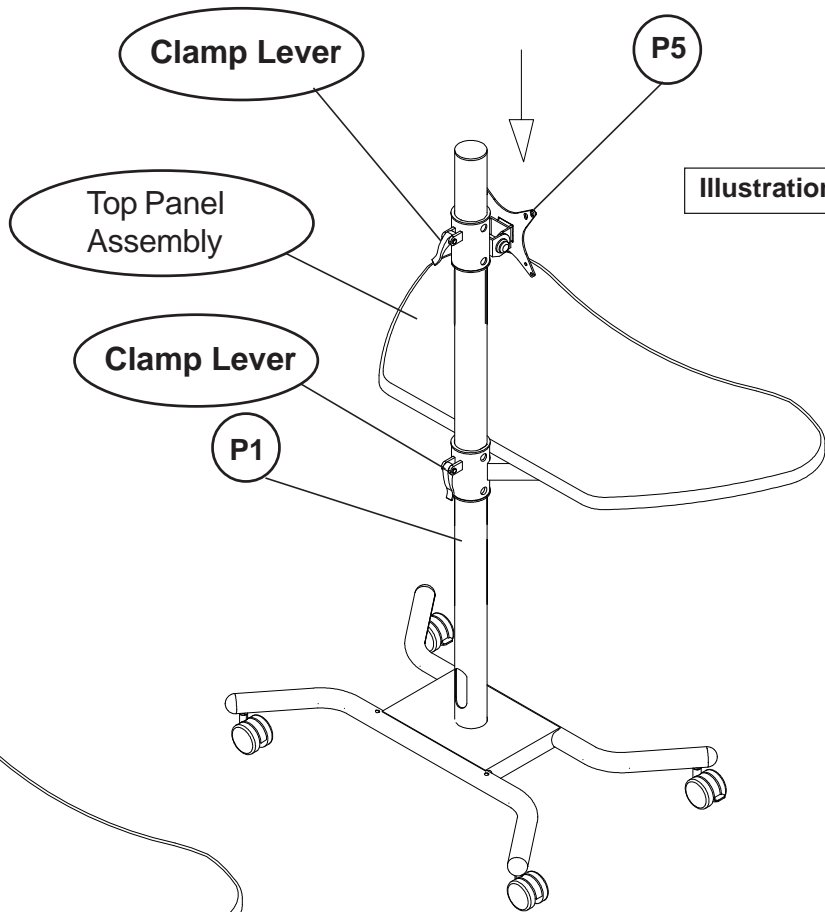

Illustration # 4

Note: Pop the plastic caps off the Monitor Mount(P-5) and use two Wrench (G) to adjust tilt tension if needed.

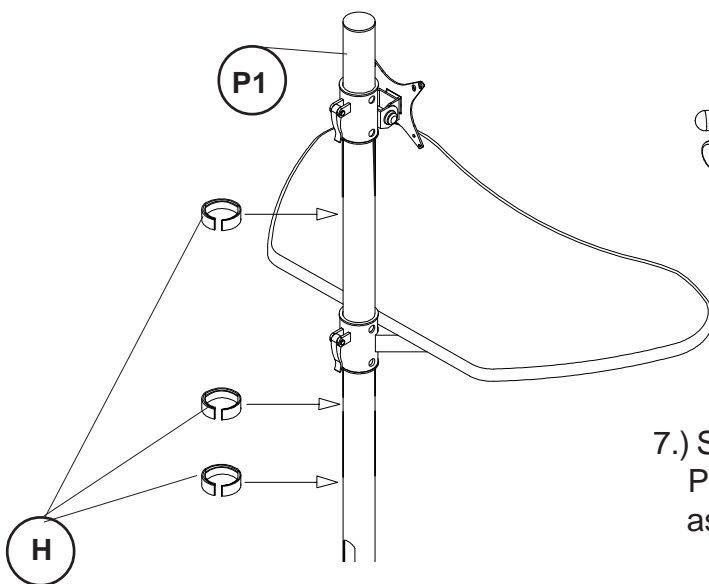
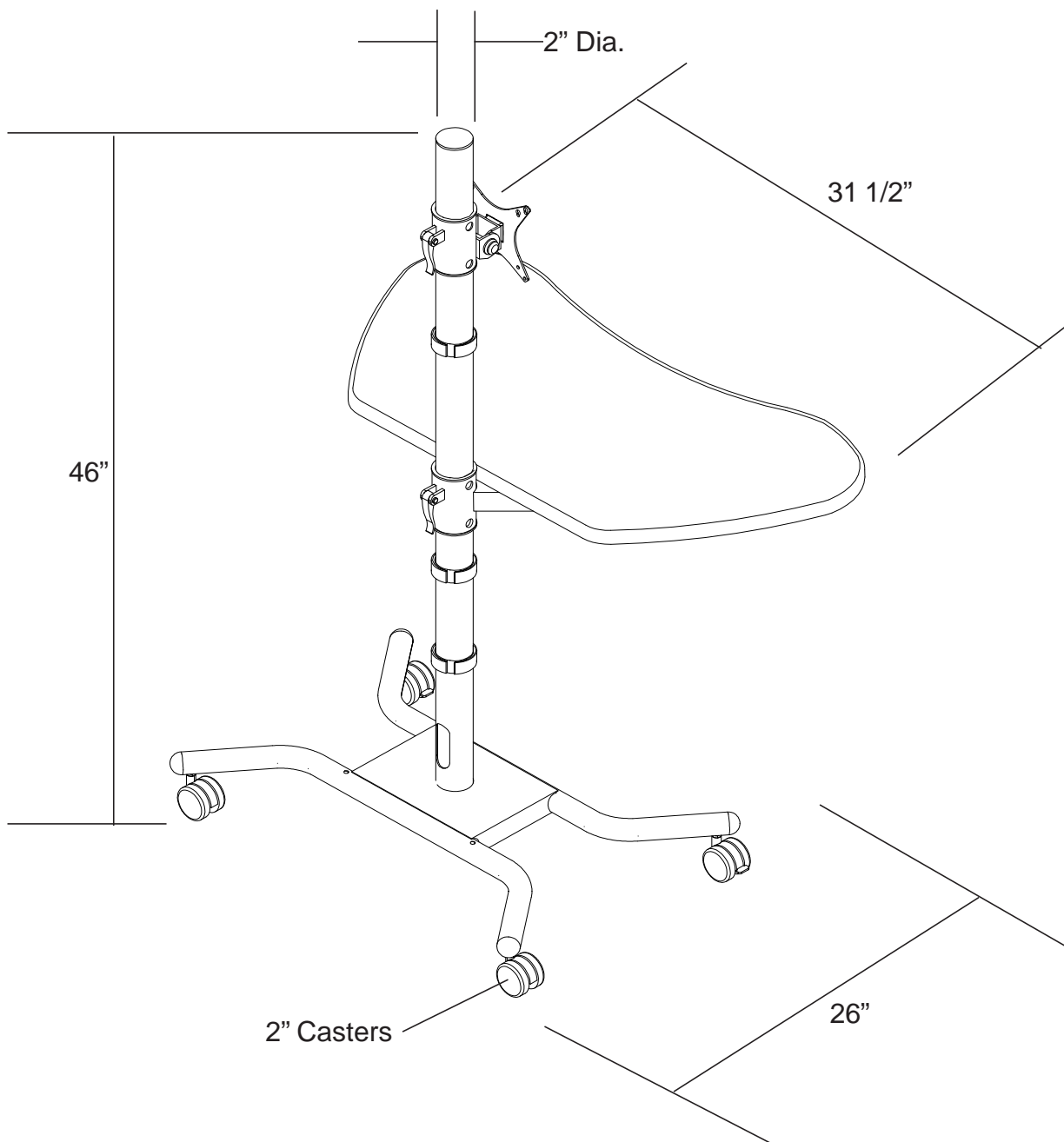

Illustration # 5

7.) Snap-on three Cable Ties (H) onto the Pole (P1) to help with wire management as shown in illustration #5.

# #90329 WOW Flexi-Desk





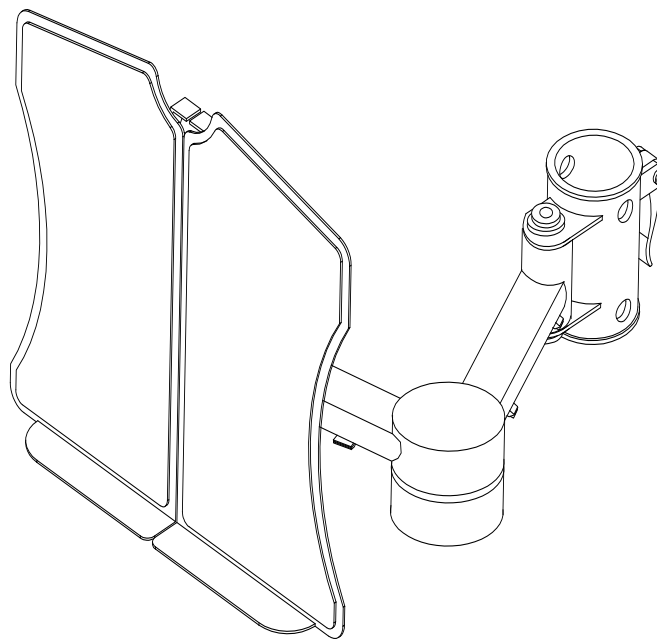

# #66641 WOW Flexi-Desk Optional Laptop Mount-2 Link

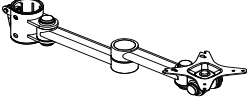

## Assembly Instructions

# #66641 WOW Flexi-Stand

## Optional Laptop Mount with 2 Link

Part	Drawing	Description	Qty	Part	Drawing	Description	Qty
P1		2 Link Arm	1 EA	<p style="text-align: center;">Hardware List</p> <p>A  Locknut 4 EA</p> <p>B  Wrench 2 EA</p>			
P2		Laptop Holder	1 EA				

- 1.) Identify and Separate all the Parts and Hardware.
- 2.) Attach the 2 Link Arm (P-1) to the back of the Laptop Holder (P-2) as shown in illustration #1. Secure the two together using four Locknuts (A). Tighten the Locknuts (A) using the small end of Wrench (B).
- 3.) To adjust the tension of the joints on the 2 Link Arm (P-1), pop the two Plastic Caps and use the two Wreches (B) to tighten or loosen the Tension Nuts at each joint.

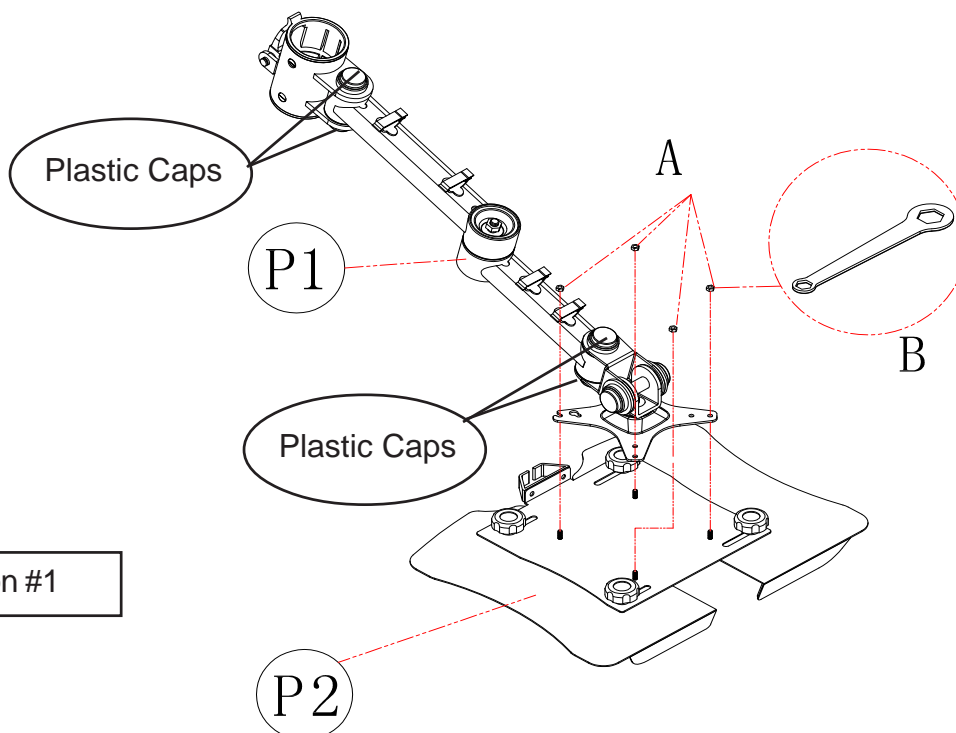

illustration #1