

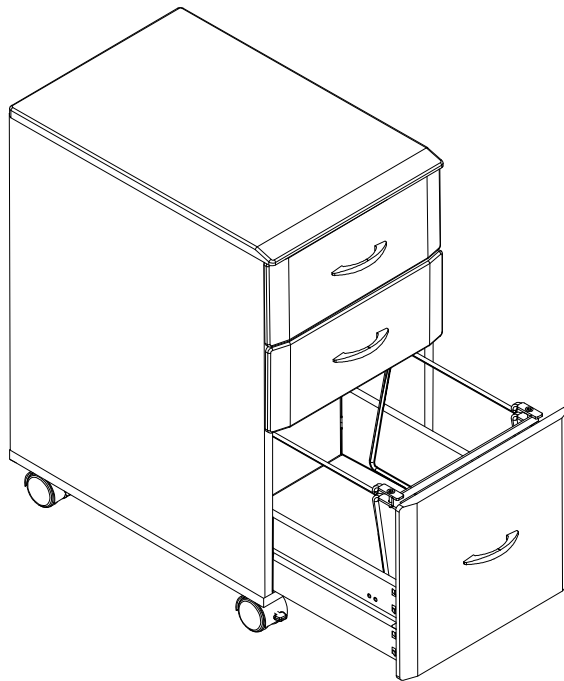

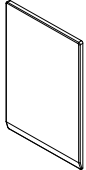

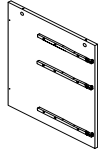





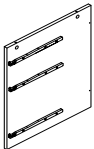

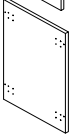

iFlex Cabinet



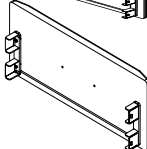









Assembly Instructions

iFlex Cabinet

Part	Drawing	Description	Qty	Part	Drawing	Description	Qty
P1		Top Panel	1 EA	Hardware List			
P2		Right Side Panel	1 EA	A		Cam	8 EA
P3		Left Side Panel	1 EA	B		Campost	8 EA
P4		Back Panel	1 EA	C		Caster Screw	16 EA
P5		Bottom Panel	1 EA	D		Locking Caster	2 EA
P6		Small Drawer Front	2 EA	E		Non-locking Caster	2 EA
P7		Large Drawer Front	1 EA	F		Drawer Screw	24 EA
P8		Drawer Bottom	3 EA				
P9		Small Drawer Side	4 EA				
P10		Small Drawer Back	2 EA				

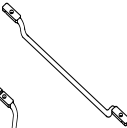
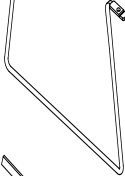
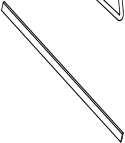
iFlex Cabinet

Part	Drawing	Description	Qty	Part	Drawing	Description	Qty
P11		Small Drawer Corner	8 EA	Hardware List			
P12		Large Drawer Side	2 EA	G		Drawer Handle	3 EA
P13		Large Drawer Back	1 EA	H		Drawer Handle Screw	6 EA
P14		Large Drawer Corner	4 EA	J		Long Wood Screw	4 EA
				K		Drawer Stop	6 EA
				L		Hanger Top Bar	2 EA
				M		Hanger Foot	2 EA
				N		Hanger Rail	2 EA
				O		Hanger Screw	4 EA
				P		Allen Wrench	1 EA

iFlex Cabinet

Assembly Instructions

READ THROUGH INSTRUCTIONS FROM BEGINNING TO END BEFORE STARTING TO ASSEMBLE UNIT.

- 1.) Identify and Separate all the Parts and Hardware.
- 2.) Place Top Panel (P-1) upside down on work table and screw in four Camposts (B) into the predrilled holes as shown in Illustration # 1. Place this assembly to the side.

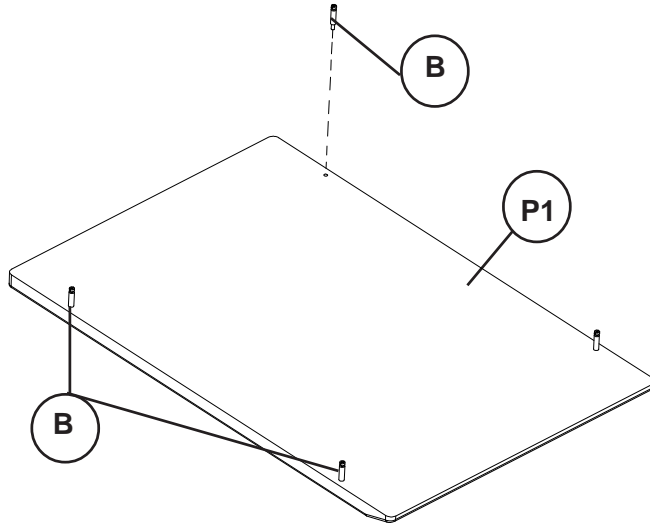

Illustration # 1

- 3.) Insert two Cams (A) into the large predrilled holes in the Right Side Panel (P2). Make sure the arrow on each cam is pointed up. Screw in two Camposts (B) into the predrilled holes in the Right Side Panel (P2) as shown in Illustration # 2.

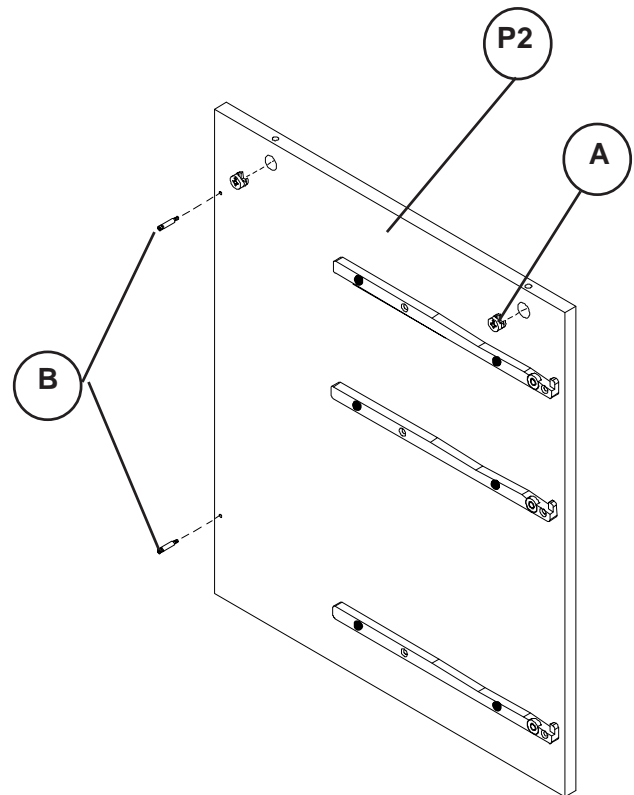
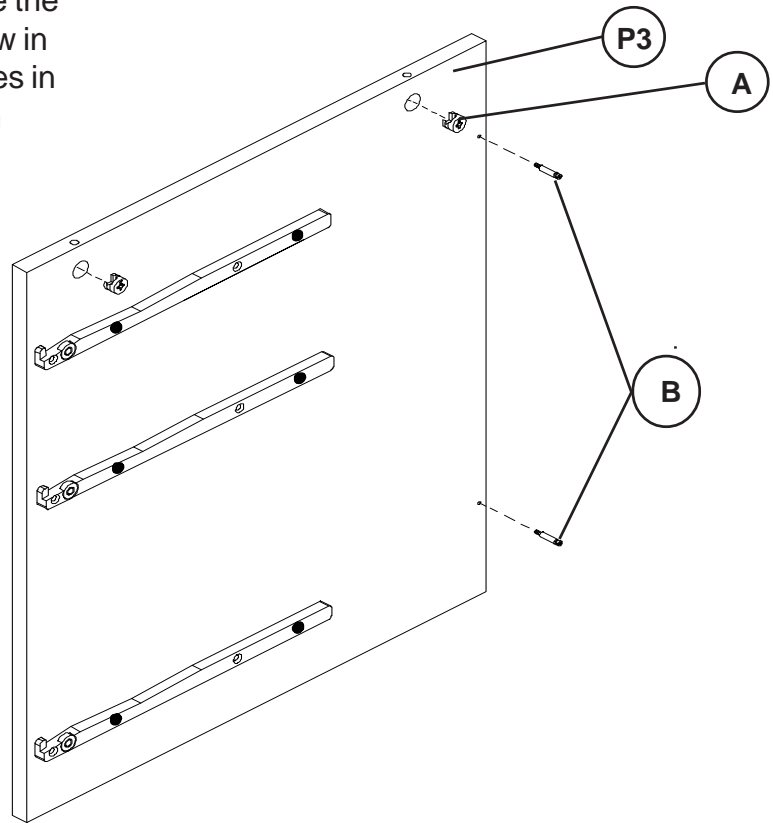

Illustration # 2

- 4.) Insert two Cams (A) into the large predrilled holes in Left Side Panel (P3). Make sure the arrow on each cam is pointed up. Screw in two Camposts (B) into the predrilled holes in the Left Side Panel (P3) as shown in Illustration #3.

Illustration # 3



- 5.) Insert four Cams (A) into the large predrilled holes in the Back Panel (P4). Make sure the arrow on each Cam (A) is point to the hole in the nearest edge as shown in Illustration # 4.

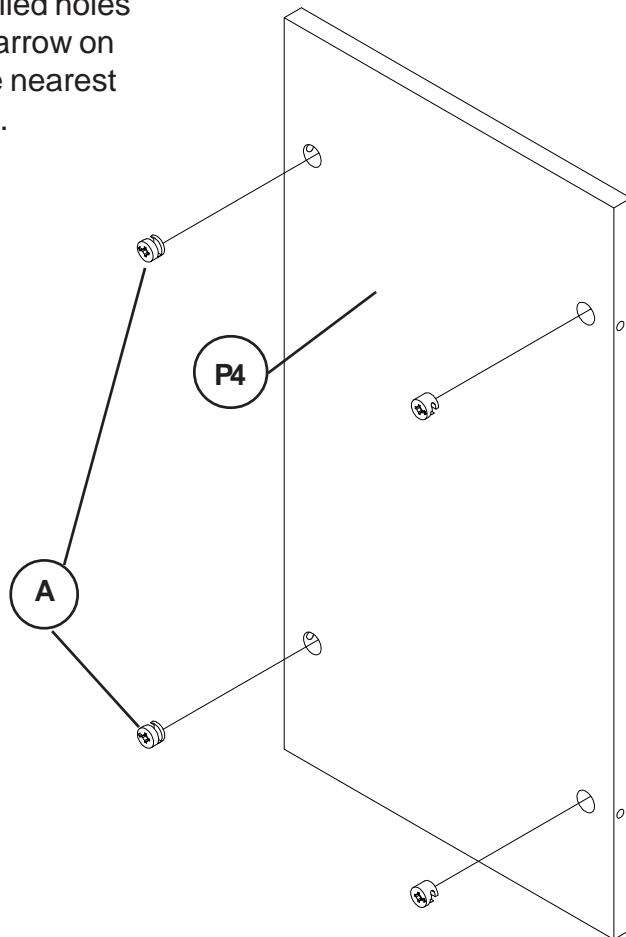

Illustration # 4

- 6.) Insert the Camposts (B) on the Right Side Panel (P2) assembly into the predrilled holes in the edge of the Back Panel (P4) assembly. Turn the Cams (A) clockwise 90 degrees to lock the two panels together. Repeat this step with the Left Side Panel (P3) assembly locking it to the Back Panel (P4) as shown in Illustratiion # 5.

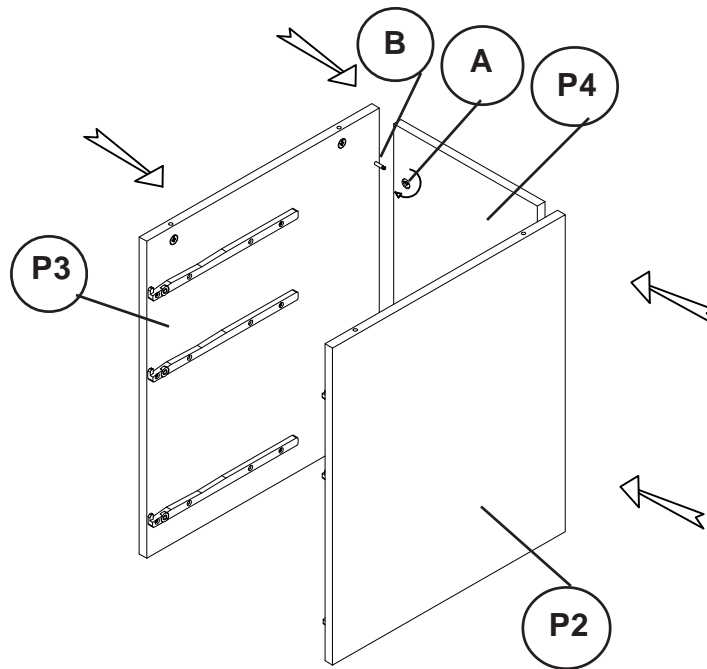

Illustration # 5

- 7.) Place the assembly from Step # 6 upside down on the assembly from Step # 2. Insert the Camposts (B) of the Top Panel (P1) into the predrilled holes in the top edges of the Left Side Panel (P3), Right Side Panel (P2) and the Back Panel (P4). Turn the Cams (A) clockwise 90 degrees to lock the Top Panel to the Sides and Back as shown in Illustration # 6.

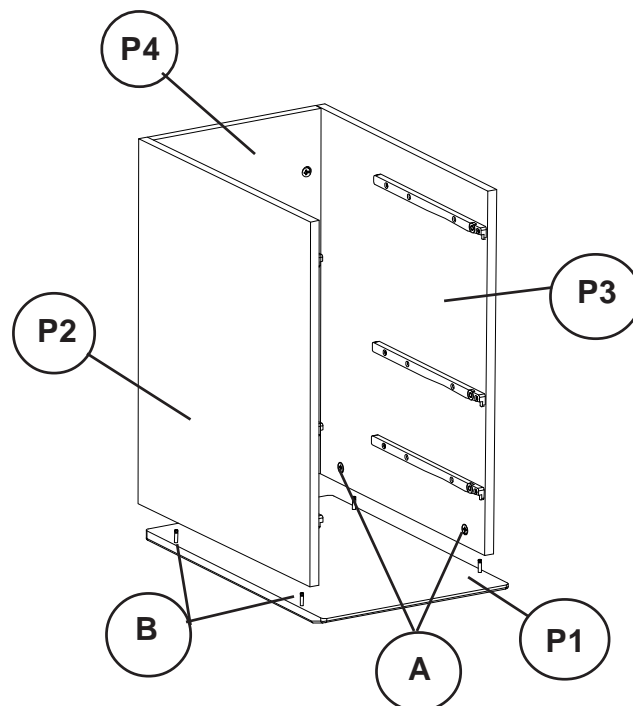

Illustration # 6

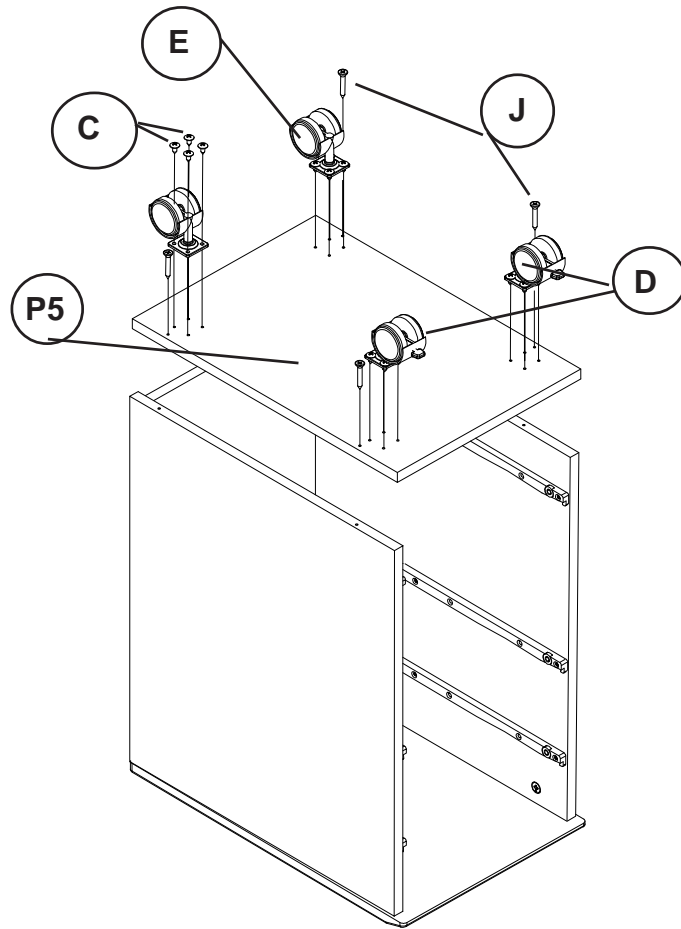

Illustration # 7

8.) Attach the Bottom Panel (P5) to the assembly from Step # 7 using four Long Wood Screws (J). Make sure the predrilled holes for the Casters in the Bottom Panel (P5) are showing on the bottom. Attach two Locking Casters (D) to the front of the Bottom Panel (P5) using eight Castor Screws (C). Attach two Non-Locking Casters (E) to the back holes in the Bottom Panel (P5) using eight Castor Screws (C) as shown in Illustration # 7.

SMALL DRAWER ASSEMBLY STEPS:

- 9.) Slide on two Small Drawer Sides (P9) onto the Small Drawer Front's brackets (P6). Make sure the Drawer Bottom groove is to the inside and at the bottom of the drawer as shown in the drawing. The locking tabs on the Small Drawer Front's brackets (P6) will snap into the small cut-outs in the sides of the Small Drawer Sides (P9). Snap-in four Small Drawer Corners (P11) into the Small Drawer Back (P10). Make sure the Small Drawer Back has the Drawer Bottom groove down and on the inside. The Small Drawer Corner's locking tabs should face out and snap into the small cut-outs in the Small Drawer Back (P10). Slide the Drawer Bottom (P8) with the gray side up into the drawer bottom groove in the Small Drawer Sides (P9) and down into the drawer bottom groove in the Small Drawer Front's back. Snap-in the Small Drawer Back assembly into the Small Drawer Sides. Attach the Drawer Handle (G) to the Small Drawer Front (P6) using two Drawer Handle Screws (H). Push-in two Drawer Stops (K) into the rear predrilled holes in the Small Drawer Sides (P9) as shown in Illustration # 8.

Illustration # 8

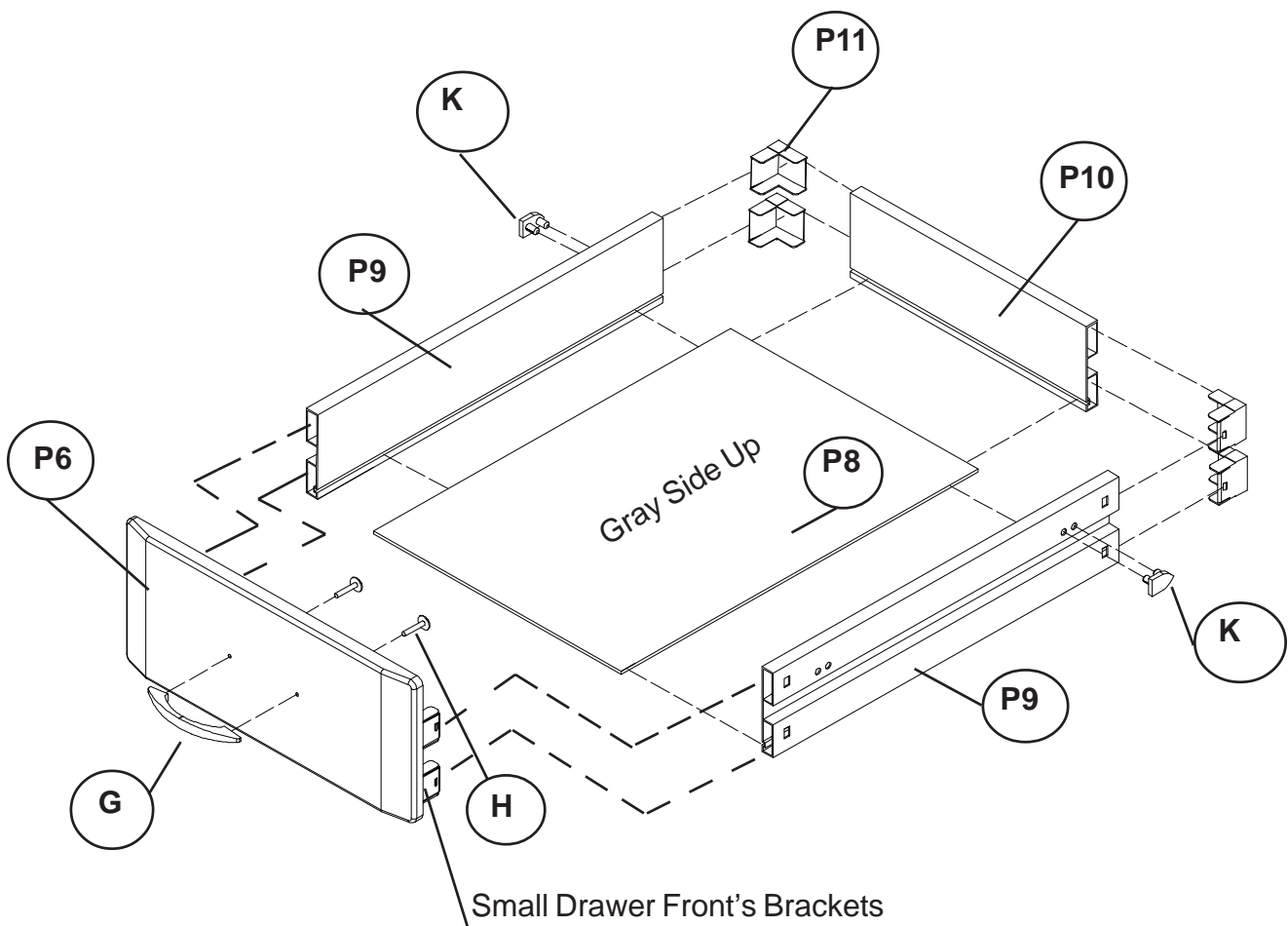

- 10.) Repeat Step # 9 to assemble the second Small Drawer.

LARGE DRAWER ASSEMBLY STEPS:

- 11.) Slide on two Large Drawer Sides (P12) onto the Large Drawer Front's brackets (P7). Make sure the Drawer Bottom groove is to the inside and at the bottom of the drawer as shown in the drawing. The locking tabs on the Large Drawer Front's brackets (P7) will snap into the small cut-outs in the sides of the Large Drawer Sides (P12). Snap-in four Large Drawer Corners (P14) into the Large Drawer Back (P13). Make sure the Large Drawer Back has the Drawer Bottom groove down and on the inside. The Large Drawer Corner's locking tabs should face out and snap into the the small cut-outs in the Large Drawer Back (P13). Slide the Drawer Bottom (P8) with the gray side up into the drawer bottom grooves in the Large Drawer Sides (P12) and down into the drawer bottom groove in the Large Drawer Front's back. Snap-in the Large Drawer Back assembly into the Large Drawer Sides. Attach the Drawer Handle (G) to the Large Drawer Front (P7) using two Drawer Handle Screws (H). Push-in two Drawer Stops (K) into the rear predrilled holes in the Large Drawer Sides (P12) as shown in Illustration # 9.

Illustration # 9

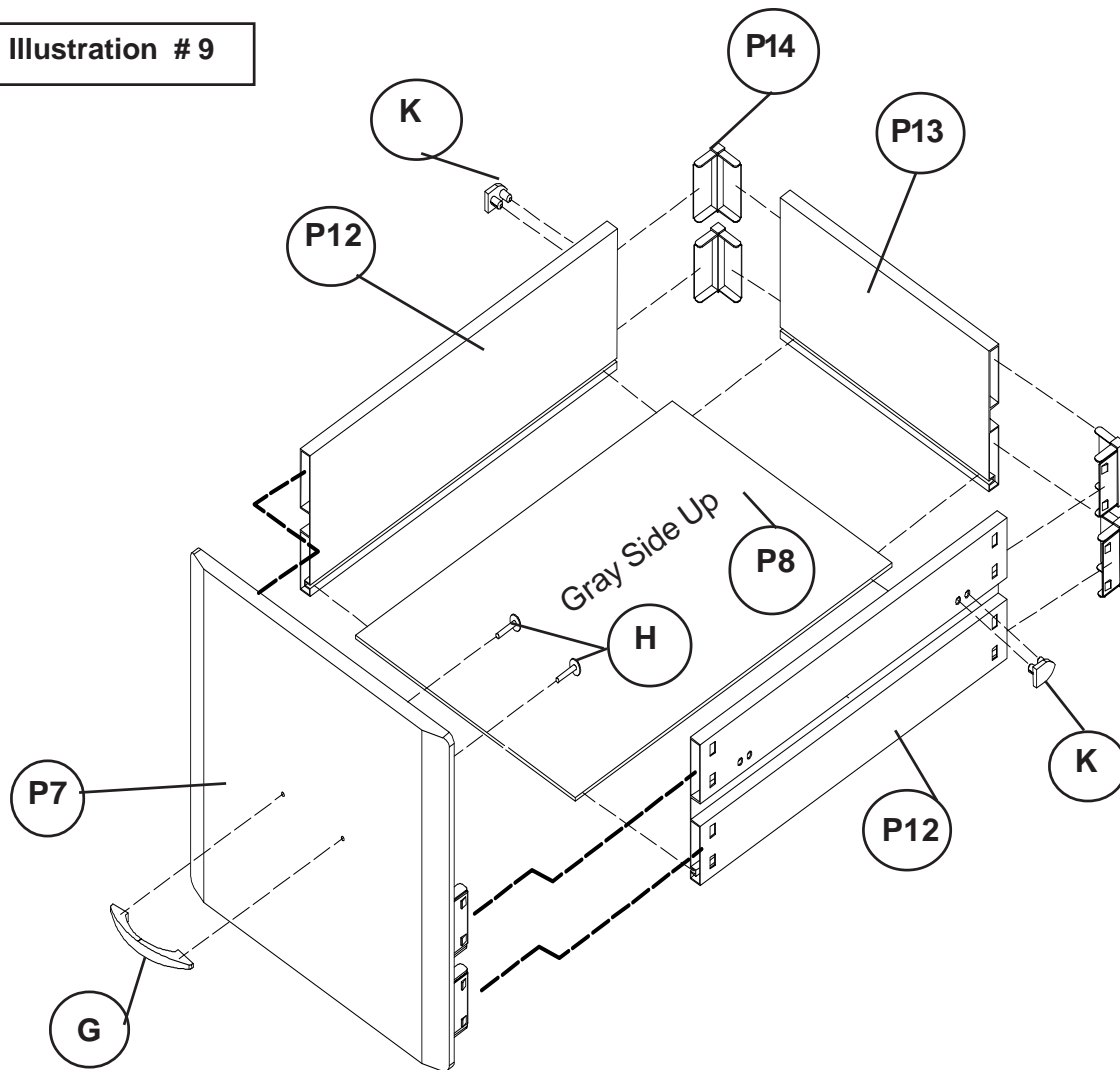

12.) Install the two Small Drawer assemblies in the top two openings. Make sure the cabinet's slide fits into the channel in the side of each drawer. Place the Large drawer in the bottom opening as shown in Illustration # 10.

Illustration # 10

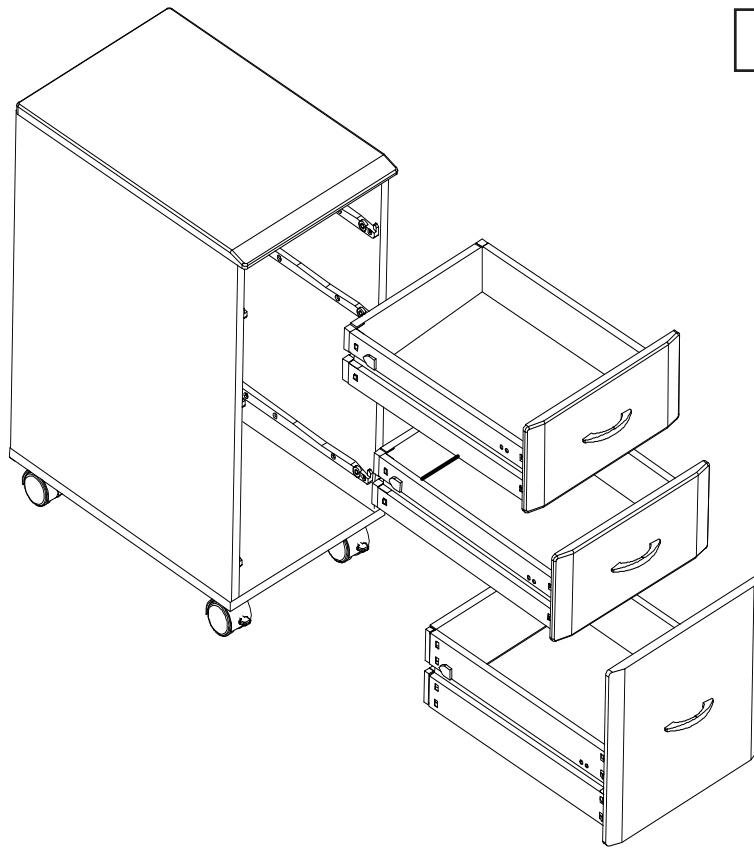

13.) **LARGE DRAWER FILE HANGER:**

Attach the Hanger Top Bar (L) to the Hanger Foot (M) using two Hanger Screws (O). Finger tighten only at this point. Insert and flush the Hanger Rail (N) between the Hanger Top Bar (N) and the Hanger Foot (M) making sure the Hanger Rail fits into the notches. Tighten the assembly using the Allen Wrench (P). Repeat this step for all four corners as shown in Illustration #12.

Place the assembled File Hanger in the Large Drawer.

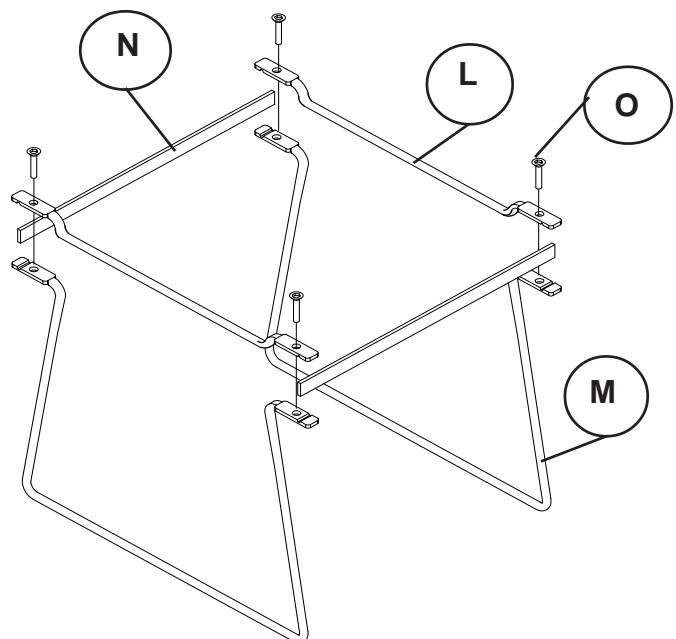

iFlex Cabinet

