

NAVAC Inc.

1099 Wall Street West, Suite 179
Lyndhurst, NJ 07071

Tel/Fax: +1 877 MY-NAVAC
877 696 2822

Info@NavacGlobal.com
www.NavacGlobal.com



Empowering you to work smarter

BREAKFREE™
CORDLESS SERIES



Commercial & Industrial



Delivering unsurpassed customer value at every opportunity defines the mission of NAVAC. We empower HVAC technicians to get jobs done with more accuracy, ease and efficiency by offering highly differentiated products with leading technology and superior quality. NAVAC products include the industry's first Brushless DC-Driven Vacuum Pump, North America's first Cordless Vacuum Pump - the 2019 Dealer Design Award (DDA) Gold Winner, the world's first 4-Cylinder Digital DC Recovery Unit - the 2020 DDA Gold Winner, Smart Refrigerant Charging Machine and our unique Power Tube Expander and Power Flaring Tools. Those award-winning, innovative tools serve contractors well in delivering unprecedented performances while saving their time and effort. **NAVAC Empowering You to Work Smarter.**

NP2DLM
BreakFree™ Cordless Vacuum Pump



Cordless · Compact · Convenient

High Performance Lithium Battery

- High capacity
- Up to 1 hour running time

Brushless DC Technology

- Light weight at 8.4 lbs
- Highly efficient

Compact Design

- Easy to carry
- Easy to store

Twin Cylinder

- Ultimate vacuum down to 23 microns

Other Features

- Backflow prevention check valve
- Isolation valve

Model	NP2DLM	
Li-ion Battery		NB1, 18V, 5Ah
Flow Rate	CFM	2
Ultimate Vacuum	micron	23
Pump Design	Dual-Stage, DC Motor	
Motor Power	HP	1/6
Inlet Port	in	1/4", 3/8" flare
Oil Capacity	oz	5.1
Dimension	in	9.2 x 3.5 x 7.5
Weight	lbs	8.4 (with battery)
Accessory	Carry bag, NB1 Battery, NC2 Battery Charger	

NP4DLM
BreakFree™ Cordless Vacuum Pump



World's Highest Capacity Cordless DC Pump

Highest Capacity Cordless Pump

- 4CFM
- Residential and light commercial applications

High Performance Lithium Battery

- High capacity
- Up to 1 hour running time

Brushless DC Technology

- Light weight at 15.4 lbs
- Highly efficient

Compact Design

- Easy to carry
- Easy to store

Twin Cylinder

- High ultimate vacuum down to 15 microns

Other Features

- Backflow prevention check valve
- Isolation valve & Lifting hook

Model	NP4DLM	
Li-ion Battery		NBP2, 18V, 9Ah
Flow Rate	CFM	4
Ultimate Vacuum	micron	15
Pump Design	Dual-Stage, DC Motor	
Motor Power	HP	1/2
Inlet Port	in	1/4", 3/8", 1/2" flare
Oil Capacity	oz	8.8
Dimension	in	12.4 x 4.4 x 9.4
Weight	lbs	15.4 (with battery)
Accessory	Carry bag, NBP2 Battery, NC2 Battery Charger	

**NB1
NBP2
NAPS1
NC2**
Battery Power Accessories

NB1
Battery for NP2DLM



NBP2
Battery for NP2DLM & NP4DLM



NAPS1
Power Supply Adapter



NC2
Battery Charger for NB1 & NBP2



Model	Description	Compatibility	Specification
NB1	Battery Pack	NP2DLM	Li-ion 18V 5.0Ah 90Wh
NBP2	Battery Pack	NP2DLM, NP4DLM	Li-ion 18V 9.0Ah 162Wh
NC2	Charger	NB1, NBP2	Input: 100V-240V~50/60Hz 180W Output: 18V 6A
NAPS1	Power Supply Adapter	NP2DLM, NP4DLM	Input: 100V-240V~50/60Hz, 4.5A, 450VA Output: 21V 20A

NP4DP
Vacuum Pump



Performance • Reliability

Dual-Stage Integrated Cylinder Design

- High ultimate vacuum
- High reliability

Forced Oil Circulation

- Improved efficiency and durability

Internal Check Valve

- Prevent oil backflow

Lifting Hook

- Safe & convenient for roof top use

Model	NP4DP	
Power Supply	V / Hz	115V / 60Hz
Flow Rate	CFM	4
Run Load Amps	A	4.3
Ultimate Vacuum	micron	15
Pump Design	Dual-Stage, AC Motor	
Motor Power	HP	3/4
Inlet Port	in	1/4", 3/8", 1/2" Flare
Oil Capacity	oz	17
Dimension	in	14 x 5 x 11.3
Weight	lbs	24.3

NP7DP
Vacuum Pump

PRO
SERIES

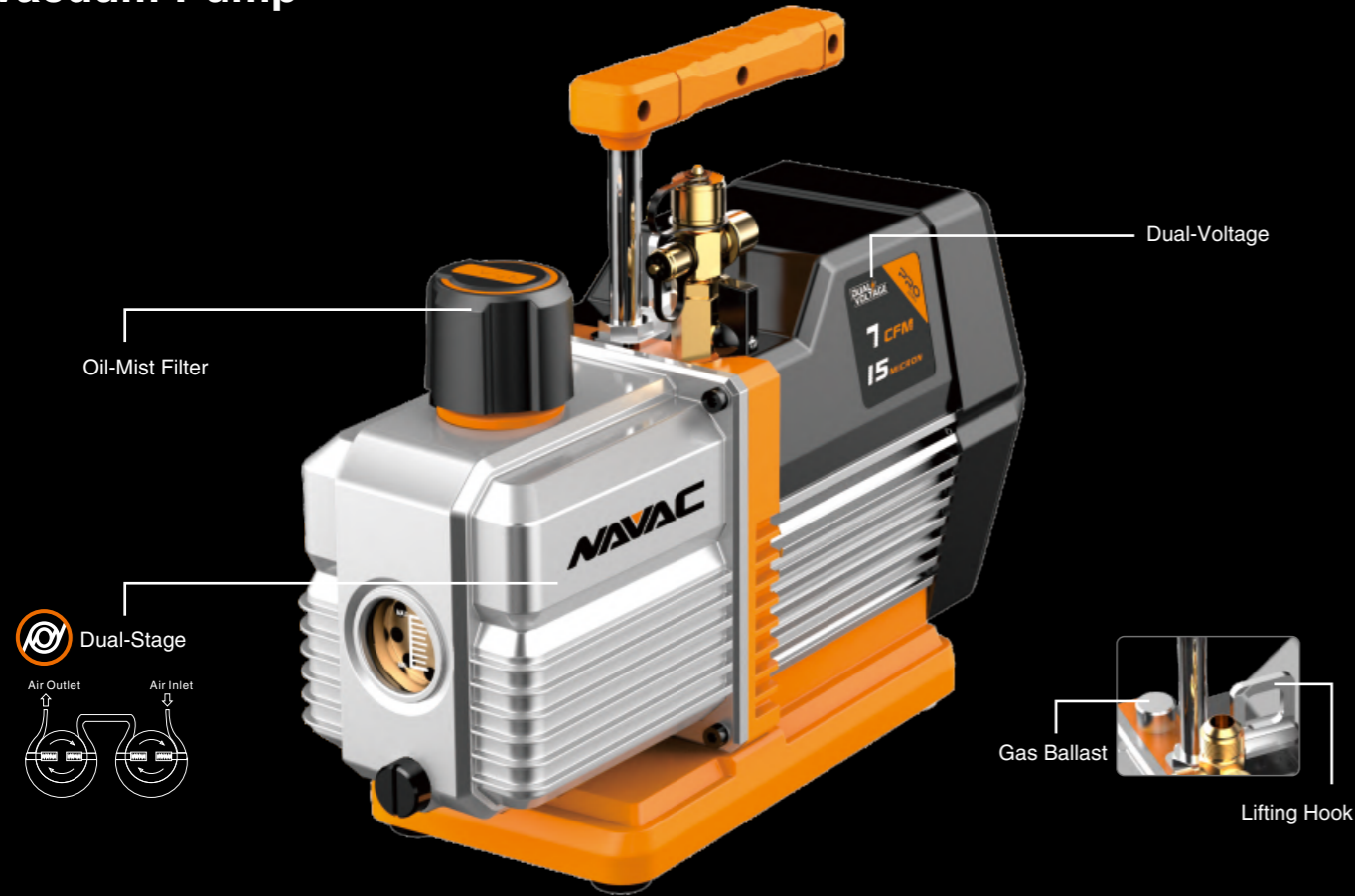

Performance • Reliability

Dual-Voltage

- Expanded application

Dual-Stage Integrated Cylinder Design

- High ultimate vacuum
- High reliability

Lifting Hook

- Safe & convenient for roof top use

Internal Check Valve

- Prevent oil backflow

Forced Oil Circulation

- Improved efficiency and durability

Model	NP7DP	
Power Supply	V/Hz	115V / 60Hz 230V / 60Hz
Flow Rate	CFM	7
Run Load Amps	A	4A (115V), 1.8A (230V)
Ultimate Vacuum	micron	15
Pump Design		Dual-Stage, AC Motor
Motor Power	HP	3/4
Inlet Port	in	1/4", 3/8", 1/2" Flare
Oil Capacity	oz	15
Dimension	in	14 x 5 x 11.3
Weight	lbs	26

NP7DP2
Vacuum Pump

PRO
SERIES



NEW

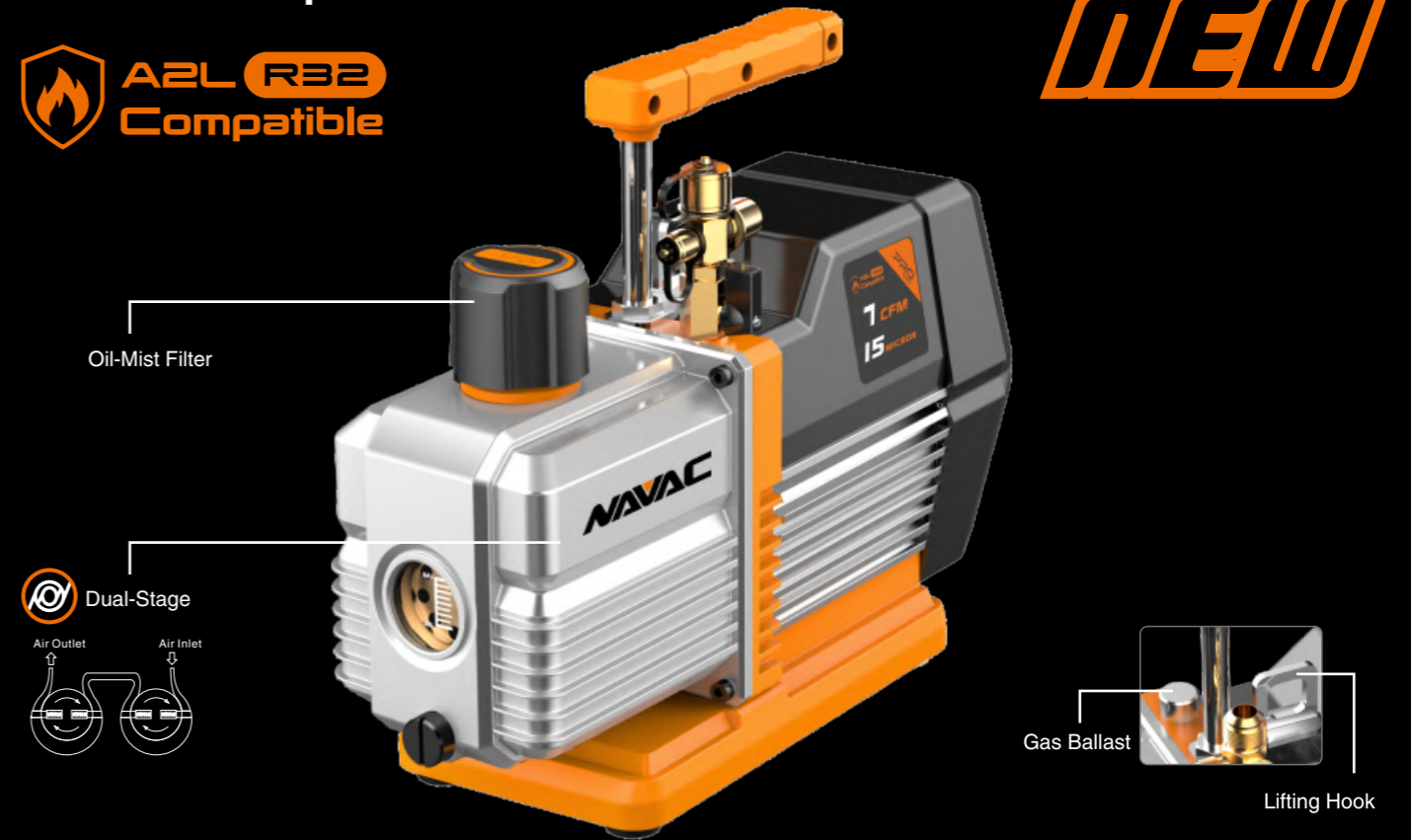

Performance • Reliability

A2L (R32) Compatible

- Expanded application

Dual-Stage Integrated Cylinder Design

- High ultimate vacuum
- High reliability

Lifting Hook

- Safe & convenient for roof top use

Internal Check Valve

- Prevent oil backflow

Forced Oil Circulation

- Improved efficiency and durability

Model	NP7DP2	
Power Supply	V/Hz	115V / 60Hz
Flow Rate	CFM	7
Run Load Amps	A	4A
Ultimate Vacuum	micron	15
Pump Design		Dual-Stage, AC Motor
Motor Power	HP	3/4
Inlet Port	in	1/4", 3/8", 1/2" Flare
Oil Capacity	oz	15
Dimension	in	14 x 5 x 11.3
Weight	lbs	26

The Industry's First Brushless DC Vacuum Pump



The era of smart refrigerant evacuation begins here with the combination of inverter, vacuum measurement and smart control in one unit, NAVAC NRP6Di and NRP8Di. Light-weight, inverter-driven, dual-stage vacuum pump delivers high-speed evacuation along with high ultimate vacuum. A built-in Micron Vacuum Gauge with LCD Digital Display precisely measures vacuum level and provides a real-time view of the system's internal vacuum condition. Smart control assures the system's vacuum by automatically extending evacuation time. Built-in solenoid valve prevents oil back flow and seals the system to preserve the vacuum during power outage or accidental disconnect.

Leading Technology, Superior Quality, Best Experience.

Empowering You to Work Smarter



NRP6Di NRP8Di

Smart Vacuum Pump



Brushless DC with Smart Control

Brushless DC Technology

- Light
- More efficient

Smart Control

- Extended evacuation for better vacuum
- Automatic control
- Task reminder

Built-In Micron Vacuum Gauge

- Precise vacuum measurement
- Digital display

Dual-Stage

- High ultimate vacuum

Solenoid Valve

- Prevent oil backflow
- Preserve vacuum

Model		NRP6Di	NRP8Di
Power Supply	V/Hz	115V / 60Hz	115V / 60Hz
Flow Rate	CFM	6	8
Ultimate Vacuum	micron	15	15
Pump Design		Dual-Stage, DC Motor	Dual-Stage, DC Motor
Motor Power	HP	3/4	3/4
Inlet Port	in	1/4", 3/8", 1/2" Flare	1/4", 3/8", 1/2" Flare
Oil Capacity	oz	17.6	17.6
Dimension	in	14 × 5.3 × 11.9	14 × 5.3 × 11.9
Weight	lbs	25.35	25.35

NP12DM Vacuum Pump

5 micron **12** CFM



High Performance Oil Mist Filter

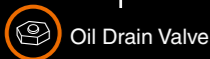
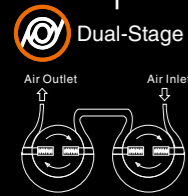

Adjustable Gas Ballast

Lifting Hook

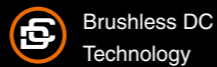
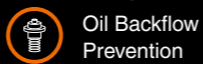

Fast • Robust • Powerful

Industrial Grade Design

- High quality, super high vacuum
- High evacuation performance

Oil Backflow Prevention

- No system oil contamination during power failure

Brushless DC Technology

- Light
- More efficient

Oil Drain Valve

- Ball valve design, easier to drain

Integrated Dual-Stage Pump

- High vacuum level down to 5 microns

Large Oil Sight Glass

- Better view of oil level

Model		NP12DM
Power Supply	V/Hz	115V / 60Hz
Flow Rate	CFM	12
Ultimate Vacuum	micron	5
Pump Design		Dual-Stage, DC Motor
Motor Power	HP	1/2
Inlet Port	in	1/4", 3/8", 1/2" Flare
Oil Capacity	oz	28
Dimension	in	16.3 x 6 x 12.1
Weight	lbs	32

NP12DA1 Ammonia Vacuum Pump

5 micron **12** CFM



Indoor Application

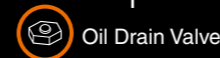
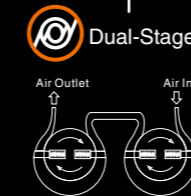

Adjustable Gas Ballast

Lifting Hook

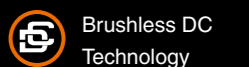
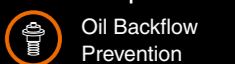

Robust and Corrosion-Resistant

Corrosion Resistant for Ammonia (R-717)

- Special corrosion resistant pump parts
- Stainless steel inlet port

Ignition-Proof Design

- Electronic starter for ignition prevention

Brushless DC Technology

- Light
- More efficient

Oil Drain Valve

- Ball valve design, easier to drain

Industrial Grade Design

- Super high vacuum level down to 5 microns
- Heavy duty for industrial applications

Large Oil Sight Glass

- Better view of oil level

Model		NP12DA1
Power Supply	V/Hz	115V / 60Hz
Flow Rate	CFM	12
Ultimate Vacuum	micron	5
Pump Design		Dual-Stage, DC Motor
Motor Power	HP	1/2
Inlet and Exhaust Flange		KF25
Oil Capacity	oz	28
Dimension	in	16.3 x 6 x 12.1
Weight	lbs	32

**VO1Q
VO1G
Vacuum Pump Oil**



Premium Oil

Widely Applicable

- Suitable for most vacuum pumps available in the market

High Quality

- Clean and free of contaminants

Model	VO1Q	VO1G
Capacity	1 Liquid Quart	1 Liquid Gallon

**NRD16T
Industrial Vacuum Pump**



**Suitable for Heavy Commercial Applications
Industry-Leading Ultimate Vacuum down to 3 Microns
Fast Evacuation with Power and Reliability**

Adjustable Gas Ballast Valve

Oil Backflow Prevention

Integrated Cylinder Structure

Forced Oil Circulation

Model		NRD16T
Flow Rate	CFM	12
Ultimate Vacuum	micron	3
Ultimate Vacuum Gas Ballast	micron	6
Water Vapor Capacity	lbs/h	0.7
Motor Power	hp	1
Oil Capacity	Quart	1.6
Inlet and Exhaust Flange		Inlet KF16 Exhaust KF25
Noise Level	dB	58
Net Weight	lbs	98 (with cart)
Dimensions	in	20.5 x 7.4 x 10.7
Accessory		Cart, NPO68 Pump Oil, NOT30B Oil Mist Filter, KF16 to 1/2" Adapter, KF16 & KF25 Clamps

**NRD24M
NRD30M
Industrial Vacuum Pump**



Powerful • Reliable • Corrosion-Resistant

Heavy-Duty, Industrial-Grade Design

Corrosion-Resistant

- Suitable for use on ammonia systems

Adjustable Gas Ballast Valve

Oil Backflow Prevention

Forced Oil Circulation

Integrated Cylinder Structure

Model		NRD24M	NRD30M
Flow Rate	CFM	18	23
Ultimate Vacuum	micron	3	3
Ultimate Vacuum Gas Ballast	micron	6	6
Water Vapor Capacity	lbs/h	1.1	1.1
Motor Power	hp	1.5	1.5
Oil Capacity	Quart	2.1	2.1
Inlet and Exhaust Flange		Inlet KF25 Exhaust KF25	Inlet KF25 Exhaust KF25
Noise Level	dB	58	58
Net Weight	lbs	77	77
Dimensions	in	20.5 x 7.4 x 10.7	20.5 x 7.4 x 10.7
Accessory		NPO68 Pump Oil, KF25 Clamps	

**CART1
NOT30B
NPO68
Industrial Pump Accessories**

**CART1
Cart for NRD16T/24M/30M**



**NOT30B
Oil Mist Filter for NRD16T/24M/30M**



**NPO68
Industrial Grade Vacuum Pump Oil
1 Liquid Quart**





Empowering you to work smarter

The Industry's First Smart Refrigerant Charging Machine

NRC62D Smart Charging

Automatic operation for easy, reliable evacuation and refrigerant charging



MASTER SERIES

3 in 1

- 1 High Performance Vacuum Pump
- 2 Digital Manifold Gauge
- 3 Wireless Refrigerant Scale

The industry's first smart charging machine, with never before seen features and advanced technology, NAVAC brings smart charging products to the HVAC industry. Conventional refrigerant charging operations use vacuum pump, manifold gauges, electronic charging scale, refrigerant tubing and other connection devices. It is dependent on the technician's experience level and judgement to evacuate and charge refrigeration systems. The conventional method is inconvenient, labor intensive, and it is difficult to ensure accuracy of the refrigerant charge.

The high-power dual-stage vacuum pump, with ultra-high vacuum capability, rapidly evacuates the system to the preset vacuum level. The smart control precisely measures the system's vacuum and digitally displays the vacuum level. After reaching the preset vacuum level, it automatically conducts the dry operation and leak detection. When the unit confirms the system is under proper conditions, the smart control automatically starts the charging function with precise control of the predetermined refrigerant charge, and turns off the system once charging is complete. The NAVAC smart charging machine enables you to automatically, accurately, and efficiently complete HVAC system charging.

Leading Technology, Superior Quality, Best Experience.

Empowering You to Work Smarter

Traditional Refrigerant Charging:

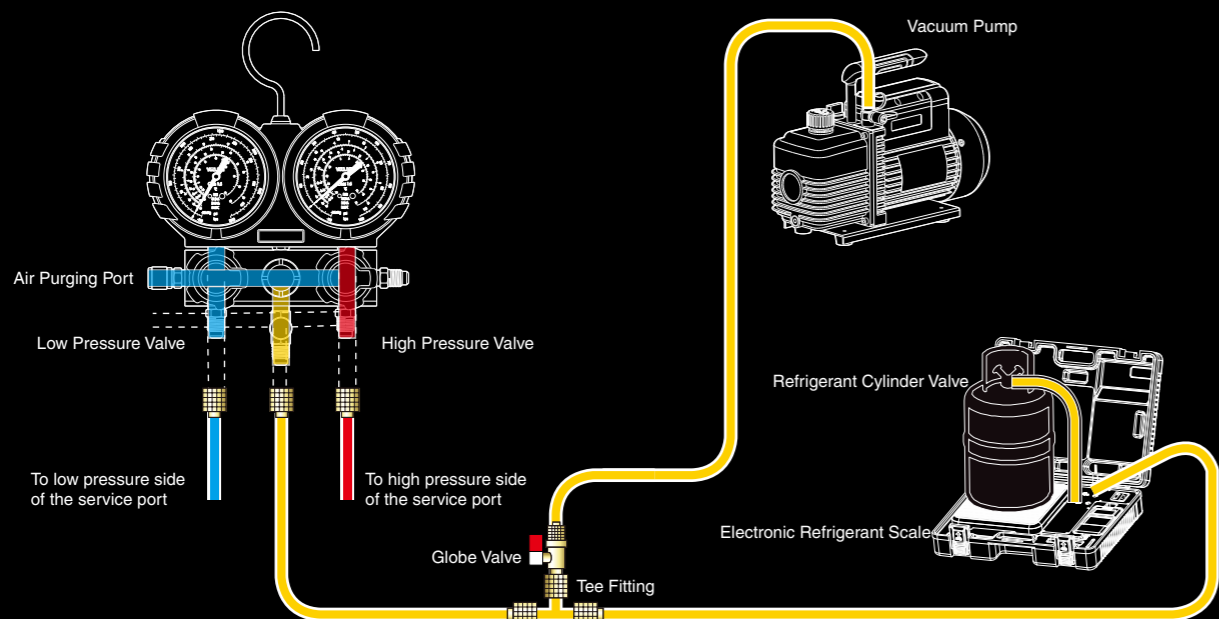

Smart Refrigerant Charging:

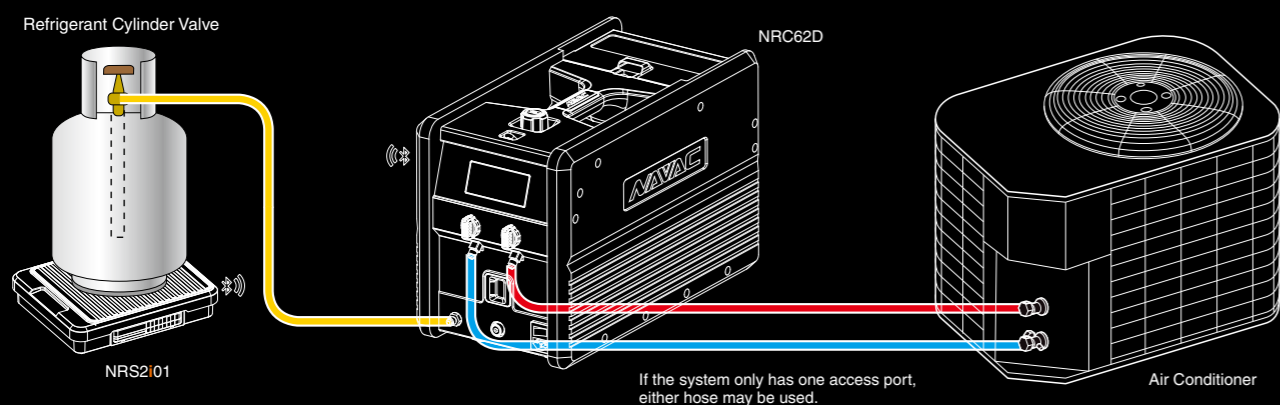

The innovative design and advanced technology of the Smart Refrigerant Charging Machine delivers automatic, accurate and efficient refrigerant charging experience for HVAC service technicians.

Leading Technology, Superior Quality, Best Experience.

Empowering You to Work Smarter

**NRC62D
Smart Refrigerant Charging Machine**



3 in 1



Smart Charging

3-in-1 Smart Charging Machine with Vacuum Pump, Digital Manifold and Refrigerant Scale

- 6 CFM DC dual-stage vacuum pump
- Built-in advanced digital manifold gauge
- Wireless refrigerant scale
- Built-in micron vacuum gauge with leak detection
- Wireless temperature probes
- 3-color refrigerant hoses

Smart Control

- Automatic operation
- Built-in leak detection
- Real time status display and warning

Model	NRC62D	
Power Supply	V/Hz	115V / 60Hz
Evacuation Rate	CFM	6
Charge Rate	lbs/min	4
Motor Power	HP	1/3
Dimension	in	19.7 x 10 x 14.5
Weight	lbs	39.6
Accessory Included	NRS2101 (Scale), NRHH53 (Hoses), NMT1 (High Temp Probe), NMT2 (Low Temp Probe)	

**NRRD
Recovery Unit**



Light • Fast

One Key Operation

- Easy to use

Purge Function

- Prevent mixing of various refrigerants

Twin Cylinder

- Fast recovery

High Pressure Protection

- Added safety

Oil-Free Compressor

- Suitable for all commonly used refrigerants

Model		NRRD			
Refrigerant Type		Category III: R-12, R-134a, R-401C, R-500 Category IV: R-22, R-401A, R-401B, R-402B, R-407C, R-407D, R-408A, R-409A, R-411A, R-411B, R-412A, R-502, R-509 Category V: R-402A, R-404A, R-407A, R-407B, R-410A, R-507			
Power Supply	V/Hz	115V/60Hz			
Motor	HP	1			
Max Current Draw	A	10			
Compressor		Oil-less, Air-cooled, Piston style			
Automatic Safety Shut-Off		558 psi / 38.5 bar			
Recovery Rate	lbs/min		R-410A	R-22	R-134a
		Direct Vapor	0.44	0.49	0.31
		Direct Liquid	6.06	6.17	4.7
		Push/Pull Liquid	12.61	11.60	10.8
Dimension	in	18 x 10 x 14			
Weight	lbs	30			

**NRDD
Digital DC Recovery Unit**



Fastest Twin-Cylinder Recovery Unit

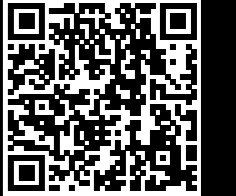

Scan to see recovery unit comparison sheet



Fastest in Its Class

Fastest in Direct Vapor for R410A, R22

- UL verified recovery rate, best performance in its class

Twin Cylinder with 2-Row Oversized Condenser

- Fast recovery

Brushless DC Motor

- Light and more efficient

Oil-Free Compressor

- Suitable for all commonly used refrigerants

Large Backlit Display

- Easy-to-read large LCD display
- Backlit for clarity

Purge Function

- Prevent mixing of various refrigerants

Model		NRDD			
Refrigerant Type		Category III: R-12, R-134a, R-401C, R-500 Category IV: R-22, R-401A, R-401B, R-402B, R-407C, R-407D, R-408A, R-409A, R-411A, R-411B, R-412A, R-502, R-509 Category V: R-402A, R-404A, R-407A, R-407B, R-410A, R-507			
Power Supply	V/Hz	115V/60Hz			
Motor	HP	1			
Max Current Draw	A	12			
Compressor		Oil-less, Air-cooled, Piston style			
Automatic Safety Shut-Off		558 psi / 38.5 bar			
UL Verified Recovery Rate	lbs/min (kg/min)		R-410A	R-22	R-134a
		Direct Vapor	0.75 (0.34) 🏆	0.64 (0.29) 🏆	0.57 (0.26)
		Direct Liquid	14.44 (6.55)	11.11 (5.04)	7.85 (3.56)
		Push/Pull Liquid	18.41 (8.35)	17.04 (7.73)	12.81 (5.81)
Dimension	in	14.5 x 9.9 x 11.7			
Weight	lbs	24.3			

3-YEAR WARRANTY *

* NAVAC offers a 2-year over the counter warranty, but you can extend to 3 years with registration on navacglobal.com/product-registration within 30 days of purchase

NRDDF
Recovery Unit for
Flammable Refrigerants

NEW

A2L, A2 & A3
Compatible



Fast • Compact • Ignition-Proof

Sparkless, Ignition-Proof Design

- Designed and tested to UL 121201, CSA C22.2 No. 213-17 and IEC 60079-7 Standards
- Suitable for A2L, A2 and A3 refrigerants

Oil-Free Compressor

- Suitable for all commonly used refrigerants

Fast and Efficient Recovery

- Brushless DC motor
- Twin cylinder with 2-row oversized condenser

Purge Function

- Prevent mixing of various refrigerants

Large Backlit Display

- Easy-to-read large LCD display
- Backlit for clarity

IP54 Waterproof Design

- Tested to be waterproof and dustproof

Model		NRDDF			
Refrigerant Type		Category III: R-12, R-134a, R-401C, R-500, R-1234YF, R-600a Category IV: R-22, R-401A, R-401B, R-402B, R-407C, R-407D, R-408A, R-409A, R-411A, R-411B, R-412A, R-502, R-509, R-290 Category V: R-32, R-402A, R-404A, R-407A, R-407B, R-410A, R-507			
Power Supply	V/Hz	115V/60Hz			
Motor	HP	1			
Max Current Draw	A	12			
Compressor		Oil-less, Air-cooled, Piston style			
Automatic Safety Shut-Off		558 psi/38.5 bar			
UL Verified Recovery Rate	lbs/min (kg/min)		R-410A	R-22	R-134a
		Direct Vapor	0.75 (0.34)	0.64 (0.29)	0.57 (0.26)
		Direct Liquid	14.44 (6.55)	11.11 (5.04)	7.85 (3.56)
		Push/Pull Liquid	18.41 (8.35)	17.04 (7.73)	12.81 (5.81)
Dimension	in	14.5 x 9.9 x 11.7			
Weight	lbs	24.3			

* For recovering only HVAC/R refrigerants from sealed HVAC/R systems. Warranty Voided if used for any other purposes.

NRDC4M
4-Cylinder Recovery Unit

4-Cylinder

A2L R32
Compatible

DD 2020
DEALER DESIGN
AWARDS
theNEWS | GOLD

Industry Fastest



Scan to see recovery unit comparison sheet



World's First DC Inverter 4-Cylinder Recovery Unit
Fastest • Most Powerful

4-Cylinder for Powerful Recovery

- Up to 40% faster than 2-cylinder unit
- Oversized inlet port for faster recovery

Large Digital Display

- Easy-to-read large LCD display
- Backlit for clarity

Super-Efficient Condenser

- Over-sized micro-channel coil
- 3 cooling fans

Dual Oil-Free Compressors

- Suitable for all commonly used refrigerants

Brushless DC Motor

- More efficient

Acceleration Knob Design

- To achieve faster vapor recovery

Model		NRDC4M			
Refrigerant Type		Category III: R-12, R-134a, R-401C, R-500 Category IV: R-22, R-401A, R-401B, R-402B, R-407C, R-407D, R-408A, R-409A, R-502, R-509 Category V: R-402A, R-404A, R-407A, R-407B, R-410A, R-507			
Power Supply	V/Hz	115V/60Hz			
Motor	HP	1.5			
Max Current Draw	A	12			
Compressor		Oil-less, Air-cooled, Piston style			
Automatic Safety Shut-Off		558 psi/38.5 bar			
UL Verified Recovery Rate	lbs/min (kg/min)		R-410A	R-22	R-134a
		Direct Vapor	1.06 (0.48)	0.99 (0.45)	0.84 (0.38)
		Direct Liquid	16.82 (7.63)	12.76 (5.79)	9.19 (4.17)
		Push/Pull Liquid	18.23 (8.27)	16.76 (7.60)	15.08 (6.84)
Inlet/Outlet Port	in	Inlet 3/8", Outlet 1/4"			
Dimension	in	17 x 10.7 x 12.2			
Weight	lbs	41.9			

NVR1 Valve Core Removal Tool

2 sizes in 1 tool



Fast Recovery and Evacuation

For Use With Both 1/4" and 5/16" Flare Fittings

Designed for High-Pressure Refrigerants Including R410a

Vacuum Rated to 20 Microns

Metal Handle for Durability

Model	NVR1
Accessory	VR01005 O Ring (3pk)

NMV1 Micron Vacuum Gauge

It uses the Pirani high-precision vacuum sensor to precisely measure vacuum levels. Digital display affords a comprehensive view of vacuum conditions. When reaching the preset vacuum level, it will buzz as a reminder. When the vacuum level increases from the preset vacuum level, it will buzz rapidly and flash the backlight to warn of leaks.

Leading Technology, Superior Quality, Best Experience.

Empowering You to Work Smarter



Precise Measurement

Pirani Vacuum Sensor

- Professional grade
- More precise

Large Backlit Display

- Easy-to-read large digital display
- Backlit for clarity
- Auto power off

Buzzing Alert

- Vacuum level reminder
- Vacuum leakage warning

Ergonomic Design

- Easy to carry

Model	NMV1
Maximum overload pressure	14 psi
Range	0-10000 Pa, 0-100 mBar, 0-75 mmHg, 0-75000 microns
Resolution	0.01 (10 Pa), 0.0001 (10 mBar), 0.0001 (10 mmHg), 1 (30000 microns)
Accuracy	15-750 micron: ±5% of reading (at 68°F)
Operating temperature	32-122°F (0-50°C)
Unit	Pa, mBar, mmHg, microns
Sensor	Pirani sensor
Buzzer alarm	90 dB, shut down after 10 seconds
Weight	4.5 oz
Accessory	Storage Bag

NML1 Refrigerant Leak Detector

Featuring a semiconductor sensor and a high-performance rechargeable lithium battery, it is precise, durable and easy to carry.

Leading Technology, Superior Quality, Best Experience.

Empowering You to Work Smarter



Accurate Detection

Semiconductor Sensor

- Precise measurement
- Extended service life

Lithium Battery

- Rechargeable

Ergonomic Design

- Easy to carry

Sniffing Fan

- 2 CFM ball bearing fan for very small leaks

Model	NML1
Refrigerants	CFC, HCFC, HFC refrigerants
Minimum of leakage	≤ 0.1 oz / year (R-134a)
Response time	≤ 3 s (depending on the size and location of leak)
Battery life	≥ 8 hours
System pressure	≥ 50 psi
Sensor life	≥ 1 year under normal usage (1500 h)
Length of probe	15.7 in
Weight	0.77 lbs
Calibration	Auto
Fan	2 CFM
Accessory	Carry Case

NMC1 Digital Clamp Meter

NAVAC NMC1 Digital Clamp Meter has a high-precision smart chip for a quick and accurate measurement of electrical current. Its adjustable 1-1/8" jaw makes it easy to get around large conductors. Easy to read with a large backlit LCD. The compact design is ideal for tight spaces.

Leading Technology, Superior Quality, Best Experience.

Empowering You to Work Smarter



Simple • Solid

High Precision Chip

- Precise measurement

Backlit LCD

- Easy to read large display

1-1/8" Jaw

- Suitable for large conductors

Compact Design

- Ideal for tight spaces

Model	NMC1
Max Measurement Voltage	600V
Max Measurement AC Current	400 A
Max Measurement Capacitance	4000 μF
Temperature Measurement Range	-40°F~1832°F (-40°C~1000°C)
Weight	9.6 oz
Accessory	Test Leads, Type K Temperature Probe, Storage Bag

NMT300 Infrared Thermometer

NAVAC NMT300 determines surface temperature by measuring the infrared energy of target surface. Its low power consumption design allows for a long-lasting operation. High-precision infrared sensor is quick and accurate in getting surface temperature.

Leading Technology, Superior Quality, Best Experience.
Empowering You to Work Smarter

NEW



Easy to Use

Precision Infrared Sensor

- Rapid response, accurate measurement

Large-Aperture Silicon Mirror

- Long-distance reach
- Wide measuring range

One-Key Operation

- Convenient, easy to use

Backlit LCD

- Easy to read display

Model	NMT300
Emissivity	0.10~1.00 adjustable
Temperature Range	-25.6°F~752°F (-32°C~400°C)
Max Measuring Accuracy	±2%
Response Time	500 mS
Debug Mode	Single-process debugging

NRS2i01 NRS3i01 Wireless Refrigerant Scale



The NAVAC **NRS2i01**, **NRS3i01** bluetooth wireless electronic refrigerant scale is designed and reinforced with advanced technology, providing more precise and portable refrigerant charging technology.

Through the bluetooth connection between handheld device and electronic charging scale, you can perform other tasks while charging.

While real-time refrigerant charge is transmitted to the handheld device, it will buzz when the charge is within 2 oz of the setting, to alert the operator to stop the charging once the setting is reached.

The magnesium alloy weighing pan and ergonomic, one-piece, portable design makes it lighter and easier to carry.

Leading Technology, Superior Quality, Best Experience.

Empowering You to Work Smarter

NRS2i01
Wireless Refrigerant Scale



Precise Charging

Wireless Bluetooth Control

- More convenient
- Auto power off

Large Backlit Display

- Large screen digital display, better readability

Precision Sensor

- Precise measurements
- Accuracy 0.05%

Integrated Handle Design

- Convenient hide-away storage for hand-held device

Magnesium Alloy Weighing Platform

- 3.3 lbs only, easy to carry

Model	NRS2i01	
Range	lbs	220
Resolution	oz	0.2
Accuracy	%	0.05%
Power	4 × AA (scale), 4 × AAA (controller)	
Dimension	in	8.25 × 10.2
Weight	lbs	3.3
Accessory	Storage Bag	

NRS3i01
Wireless Refrigerant Scale, Large Weighing Pan

NEW



Precise Charging

Wireless Bluetooth Control

- More convenient
- Auto power off

Large Backlit Display

- Large screen digital display, better readability

Precision Sensor

- Precise measurements
- Accuracy 0.05%

Integrated Handle Design

- Convenient hide-away storage for hand-held device

Large Aluminum Weighing Platform

- Suitable for larger size refrigerant cylinders
- Durable and highly reliable

Model	NRS3i01	
Range	lbs	265
Resolution	oz	0.35
Accuracy	%	0.05%
Power	4 × AA (scale), 4 × AAA (controller)	
Dimension	in	10.6 × 12.6
Weight	lbs	10.3
Accessory	Carry Case	

N2D4H
Manifold Gauge with Digital Display



Precision • Impact-Resistant

Accurate

- Class 0.4 accuracy
- Over 100% improvement vs. analog gauges

Folding Hook

- Hidden hook design, easy to transport

Aluminum Body with 1/4 Turn Ball Valve Handle

- Reliable, efficient and durable
- Better work experience

Digital Display

- Easy to read
- Auto power off

Impact-Resistant

- Impact-resistant design
- Durable rubber cover

22 Programmed Refrigerant Types

Model	N2D4H	
Refrigerant Type		R-22, R-32, R-134A, R-290, R-404A, R-407A, R-407C, R-410A, R-426A, R-427A, R-434A, R-442A, R-448A, R-449A, R-450A, R-452A, R-453A, R-507A, R-513A, R-600A, R-744, R-1234YF
Pressure Range	psi	-30 inHg to 720 psi
Hose	in	Red 1/4" - 1/4" Yellow 1/4" - 1/4" Blue 1/4" - 1/4"
Standard Length	ft	3x5'
Accessory		Carry Case

N2A4
Manifold Gauge



Precision • Impact-Resistant

Accurate

- Precision pressure gauge with Class 1.0 accuracy

Impact-Resistant

- Impact-resistant design
- Durable rubber cover

Aluminum Body with 1/4 Turn Ball Valve Handle

- Reliable, efficient and durable
- Better work experience

Folding Hook

- Hidden hook design, easy to transport

4-Refrigerants for Wider Applications

- Ø3-1/8 large dial for easy reading
- Commonly used refrigerants on outer rings for better reading

Model	N2A4	
Refrigerant Type		R-22, R-404A, R-134a, R-410A
Gauge Diameter	in	Φ 3-1/8
Pressure Range	psi	-30 inHg to 800 psi -30 inHg to 500 psi
Hose		No
Accessory		Carry Case

N2A4A
Manifold Gauge



Precision • Impact-Resistant

- Accurate**
 - Precision pressure gauge with Class 1.0 accuracy
- Impact-Resistant**
 - Impact-resistant design
 - Durable rubber cover
- Aluminum Body with 1/4 Turn Ball Valve Handle**
 - Reliable, efficient and durable
 - Better work experience
- Folding Hook**
 - Hidden hook design, easy to transport
- R32 Compatible for Wider Applications**
 - Φ3-1/8 large dial, color-coded for easy reading
 - R32 refrigerant on outer rings for better reading
- Phosphorescent**
 - Glow in the dark

Model	N2A4A	
Refrigerant Type	R-32, R-410A, R-22, R-134a	
Gauge Diameter	in	Φ 3-1/8
Pressure Range	psi	-30 inHg to 800 psi -30 inHg to 500 psi
Hose	No	
Accessory	Carry Case	

N4A4H
4-Valve Manifold Gauge



Precision • Impact-Resistant

- Accurate**
 - Precision pressure gauge with Class 1.0 accuracy
- Impact-Resistant**
 - Impact-resistant design
 - Durable rubber cover
- Aluminum Body with 1/4 Turn Ball Valve Handle**
 - Reliable, efficient and durable
 - Better work experience
- Folding Hook**
 - Hidden hook design, easy to transport
- 4-Refrigerants for Wider Applications**
 - Φ3-1/8 large dial for easy reading
 - Commonly used refrigerants on outer rings
- 4 Valve**
 - Easy to use

Model	N4A4H	
Refrigerant Type	R-22, R-404A, R-134a, R-410A	
Gauge Diameter	in	Φ 3-1/8
Pressure Range	psi	-30 inHg to 800 psi -30 inHg to 500 psi
Hose	in	Black 3/8" - 3/8" Red 1/4" - 1/4" Yellow 1/4" - 1/4" Blue 1/4" - 1/4"
Hose Length	ft	4x5'
Accessory	Carry Case	

NH5SC
Refrigerant Hose

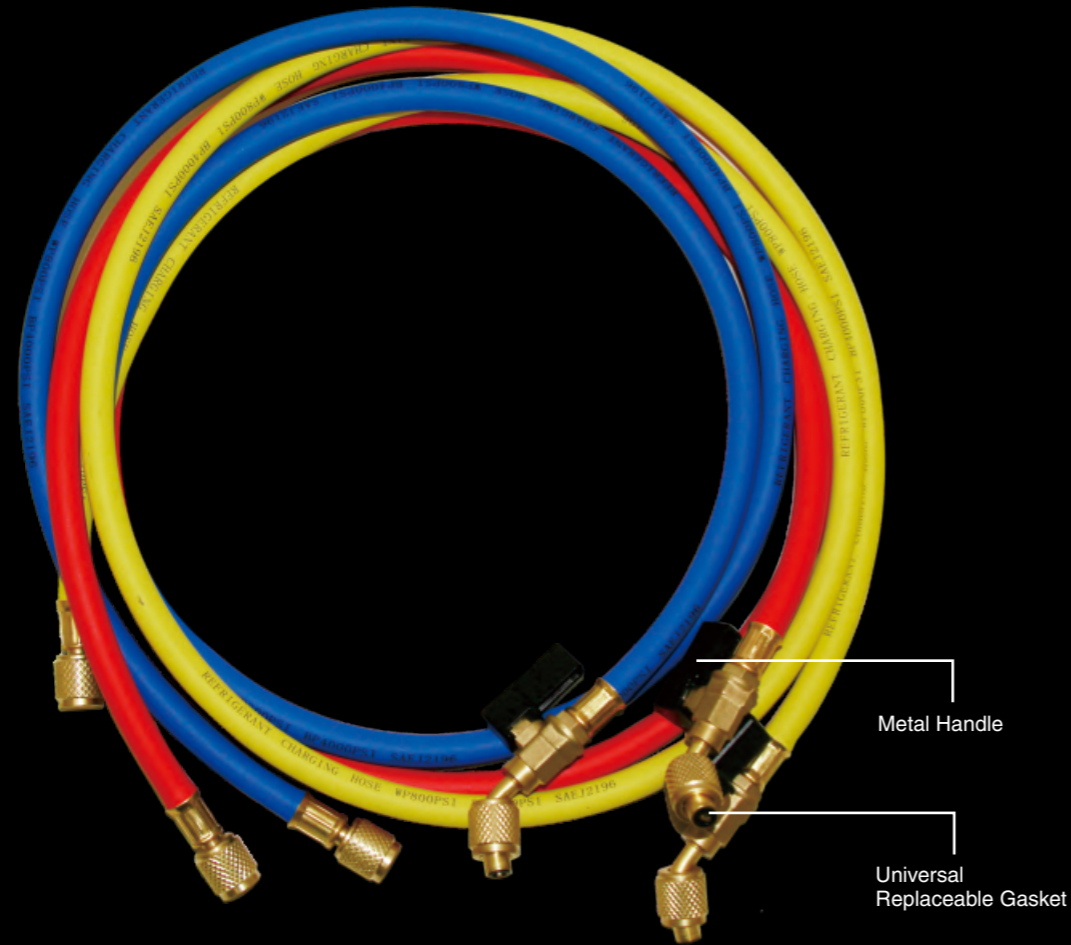

1/4" Charging Hoses with Ball Valve, 5 Ft Long

High Strength

- Ball valve to prevent refrigerant loss
- Suitable for R-410A, R-134a, R-22 and other refrigerants
- 1/4" SAE fittings with 45° bend on one end
- Leak-proof eight-sided crimp
- 800 psi working pressure, 4000 psi burst pressure

Improved Design

- Metal valve handle
- Universal, replaceable gasket

Model	NH5SC		
Type	Red	Yellow	Blue
Pressure Scale	psi	0-800 psi	
Length	ft	5	
Connector	in	1/4" - 1/4"	

NHB1
NHB2
Big Boy High-Flow Evacuation Hoses



Evacuation Hose

Fast & Efficient

- 1/2" large diameter for fast evacuation
- 4-layer construction for low permeation
- 3200 psi burst pressure, 640 psi working pressure
- Vacuum rated to 20 microns

Model	NHB1		NHB2	
Length	feet	6'	feet	6'
Diameter	in	1/2"	in	1/2"
Fitting		3/8" to 1/4"		1/2" to 1/4"

**NEVK1
NEVK2
NEVK3
Rapid Evacuation Kit**



2 sizes in 1 tool



Rapid Evacuation

Big Boy High-Flow Evacuation Hoses, 6' Long

- 1/2" large diameter for fast evacuation
- 4-layer construction for low permeation
- 3200 psi burst pressure, 640 psi working pressure
- Vacuum rated to 20 microns

NVR1 Valve Core Removal Tool

- For use with both 1/4" and 5/16" flare fitting
- Vacuum rated to 20 microns
- Designed for high-pressure refrigerants including R410a
- Metal handle for durability

NMV1 Micron Vacuum Gauge

- Pirani vacuum sensor
- Large backlit display
- Buzzing alert
- Ergonomic design

Model	NEVK1	NEVK2	NEVK3
Description	Rapid Evacuation Kit, Pro Series	Rapid Evacuation Kit, Pro Series	Rapid Evacuation Kit, Pro Plus
Items	Quantity		
NHB1 Evacuation Hose, 3/8" to 1/4" Fitting	1	-	1
NHB2 Evacuation Hose, 1/2" to 1/4" Fitting	-	1	1
NVR1 Valve Core Removal Tool	1	1	2
NMV1 Micron Vacuum Gauge	-	-	1

**NKS1
Mini-Split Tool Kit**



NAVAC Advanced Tool Kit for Mini-Split Installation

NEF6LM Cordless Flaring Tool

- Quick accurate flaring
- Ultra light at 2.9 lbs

NTW1 Digital Torque Wrench

- Digital readout
- Adjustable jaw

Manifold Gauge with Digital Display

- Large LCD screen for clarity
- Doubling accuracy vs. analog gauge

Model	Item	Specification	Quantity
NEF6LM	Cordless Power Flaring Tool	Lithium battery: 7.4V 2Ah 14.8Wh Tube OD: 1/4", 3/8", 1/2", 5/8", 3/4"	1
NTW1	Digital Torque Wrench	3.1 - 62.7 ft-lb (4.2 - 85 N-m)	1
NRM1D	Manifold Gauge with Digital Display	Refrigerant type: R-22, R-134a, R-1234yf, R-290, R-404A, R-407C, R-410A, R-32, R-507	1
NHK1	30-Piece Hex Wrench Set	SAE: 7/250"-3/8" Metric: 0.7-10 mm	1
NTC6	Tube Cutter	Tube OD 1/8" ~ 3/4"	1
NTC12	Tube Cutter	Tube OD 1/8" ~ 1-1/4"	1
NTR14	Internal/External Reamer	Tube OD 1/8" ~ 1-1/2"	1
NTD28	Tube Deburrer	2 spare blades included	1
NFG1	Flare Gauge	Tube OD: 1/4", 5/16", 3/8", 1/2", 5/8", 3/4"	1

NTW1 Digital Torque Wrench



Digital Readout · Adjustable Jaw

- Accurate within 2%
- Dual direction (CW & CCW)
- Torque setting memory & Peak hold
- Auto turn-off after 5 minutes inactivity
- Selectable measuring units (ft-lb, in-lb, N-m, kg-cm)
- Indicator lights and sound for target torques

Model	NTW1
Torque Measuring Range	3.1 - 62.7 ft-lb (4.2 - 85 N-m)
Jaw Size	0.2 - 1.2 inch (5 - 30 mm)
Weight	3 lbs
Accessory	Storage Case

NTF66 NTF66C Flaring Tool

NAVAC Flaring Tools, with axial spacing and patented rivet connection, deliver consistent, accurate flaring each and every time. Nitride treatment makes them more robust and durable.

Leading Technology, Superior Quality, Best Experience.

Empowering You to Work Smarter



Accurate Flaring

Axial Spacing

- Ensuring accurate and consistent flaring

Internal Clutch

- Preventing over-torquing

Nitride Treatment

- Longer service life
- Robust and durable

Eccentric Cone

- 45° flare for R410A system

Patented Annular Rivet Connection

Heavy-Duty Handle & Shaft



Model	NTF66	NTF66C
Tube OD	1/4", 5/16", 3/8", 1/2", 5/8", 3/4"	1/4", 5/16", 3/8", 1/2", 5/8", 3/4"
Accessory	Carry Case	Carry Case, NTC12 (Cutter)

NTF67D
Hand and Drill-Powered Flaring Tool



Accurate Flaring

Hand or Drill-Powered

- Efficient and labor-saving with drill attached

Axial Spacing

- Axial spacing for accurate and consistent flaring
- Eccentric cone with 45° flare

Nitride Treatment

- Longer service life
- Robust and durable

Patented Annular Rivet Connection

Internal Clutch

- Preventing over-torquing

Eccentric Cone

- 45° flare for R410A system

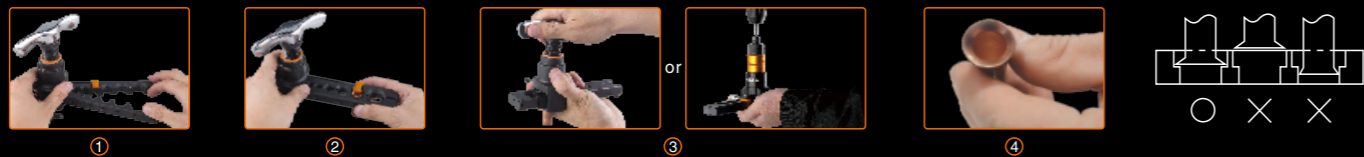

Model	NTF67D
Tube OD	3/16", 1/4", 5/16", 3/8", 1/2", 5/8", 3/4"
Accessory	Carry Case, NFG1 Flare Gauge

NEF6LM
BreakFree™ Power Flaring Tool

Weighing less than three pounds, the new Model NEF6LM Power Flaring Tool produces precise, automatic flares in a fraction of the time compared to traditional flaring methods. NAVAC's new cordless flaring solution makes flaring faster and far simpler without sacrificing accuracy or consistency. Offering easy flare connectivity, it can create flares in five sizes, ranging from 1/4" to 3/4". Designed to perform reliably in harsh environments, the NEF6LM Cordless Power Flaring Tool is your ideal flaring solution for mini-split ACs and VRF systems.

Leading Technology. Superior Quality. Best Experience.
Empowering You to Work Smarter



NEF6LM
BreakFree™ Power Flaring Tool



NFG1
Flare Gauge

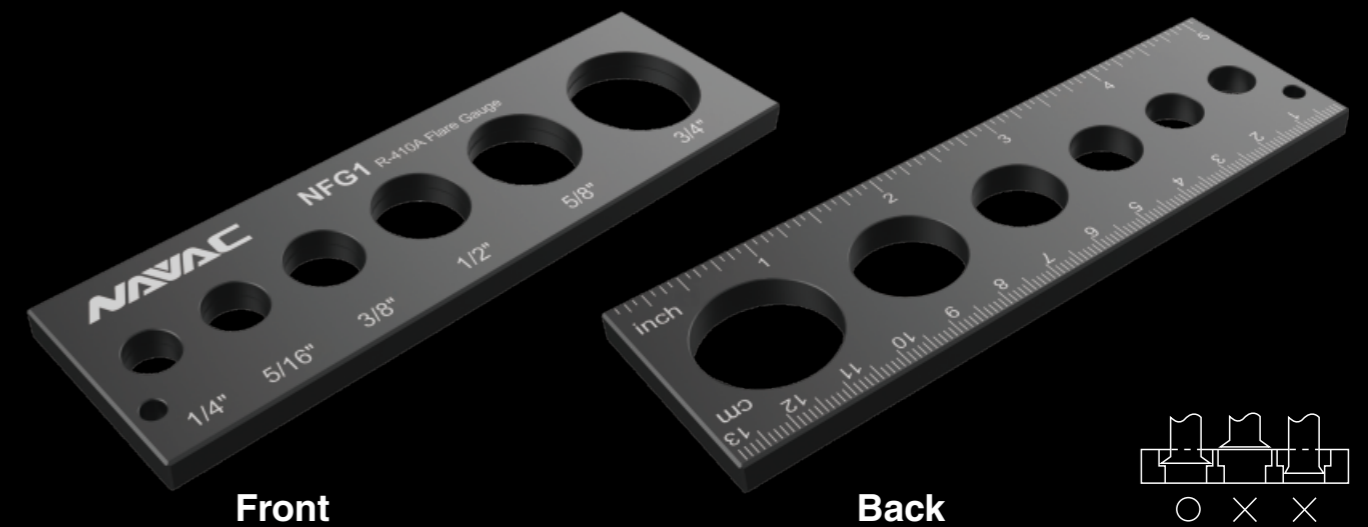

Quick Accurate Flaring · Ultra Light

- Complete a flare in 15 seconds
- Over 100 flares per charge
- Quick charge in 30 minutes
- Ultra light at 2.9 lbs
- Quick connect with ready-to-use clamps
- 45° flaring for R410A
- Limit baffle assures precise flare depth
- Easy one-button operation
- Battery power indicator
- LED flash light
- Flare gauge included



Model	NEF6LM
Battery Type	7.4V 2Ah 14.8Wh
Tubing Type	Copper
Tube OD	1/4", 3/8", 1/2", 5/8", 3/4"
Weight	2.9 lbs (with battery)
Accessory	Carry Case, NFG1 Flare Gauge

Ensuring Perfect Flares

Tube OD: 1/4", 5/16", 3/8", 1/2", 5/8", 3/4"

For Precise Measurement of Tube Flares

NTE7 Tube Expander

NAVAC NTE7 Tube Expander, with its simple structure and foldable design, is convenient to carry and easy to use. Leading Technology, Superior Quality, Best Experience.

Empowering You to Work Smarter

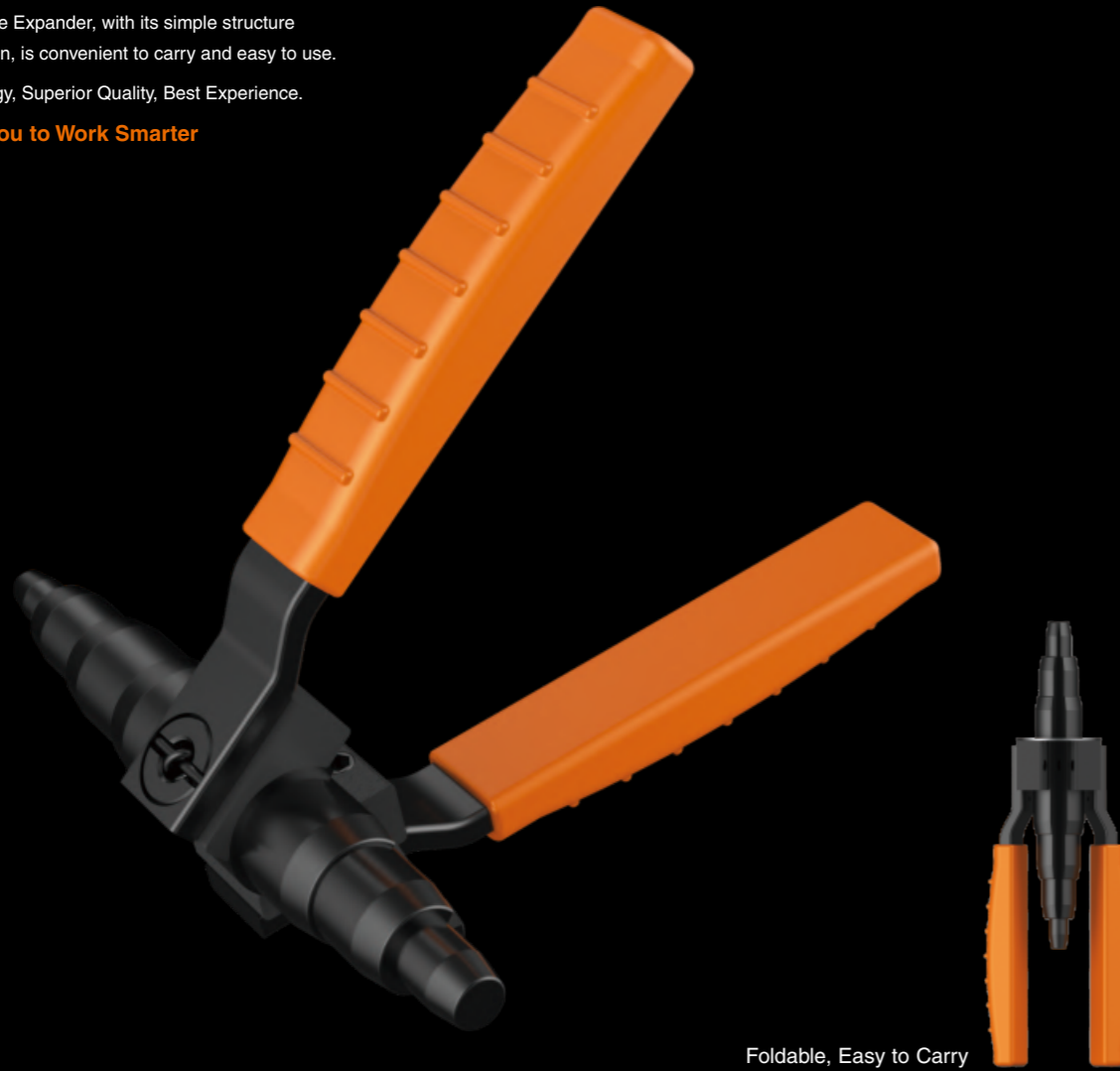

Foldable, Easy to Carry

Easy to Expand

Easy to Carry

- Foldable design for portability

Easy to Use

- Simple structure for expanding copper tubing



Model	NTE7
Tube OD	3/8", 1/2", 5/8", 3/4", 7/8"

NTE11H Hydraulic Tube Expander



Powerful and Durable

Hydraulic Expander

- Vacuum sealed hydraulic system, no oil change needed
- Easy to expand
- Suitable for large diameter copper

Compact

- Convenient for narrow spaces
- Easy to use

Easy One-Hand Operation

- Reduced labor and improved efficiency



Model	NTE11H
Tube OD	3/8", 1/2", 5/8", 3/4", 7/8", 1", 1-1/8"
Accessory	NTC12 (Cutter), NTD28 (Deburring Tool), Carry Case

NTEHHK

Expander Kit for NTE11H



Model	NTEHHK
Tube OD	1-1/4", 1-3/8", 1-1/2", 1-5/8"

NTE11L

BreakFree™ Power Tube Expander

Get the job done quickly with the NTE11L BreakFree Power Tube Expander. Expand a tube in 12 seconds by pressing one button. The long-lasting rechargeable lithium battery allows up to 200 expansions on a single charge. Battery and charger are compatible with NAVAC NEF6LM BreakFree™ Power Flaring Tool. Expander heads from the NTE11H Hydraulic Expander can be shared with NTE11L with a NAQA1 adapter.

Leading Technology, Superior Quality, Best Experience.
Empowering You to Work Smarter



NTE11L
BreakFree™ Power Tube Expander



Effortless, Quick & Accurate Expanding

- One-button operation
- Automatic pressure relief
- Quick connect heads
- Large capacity lithium battery
- Complete an expansion in 12 seconds
- Up to 200 expansions per charge
- Quick charge in 30 minutes
- Innovative head design minimizing 3/8" tube splitting
- Battery power indicator
- LED flash light

NTE11L (full kit)

Quick Connect Expander Heads	Yes
NAQA1 Quick Connect Adapter	No
NBF2 Lithium Battery	Yes
NCF2 Battery Charger	Yes
Carry Case	Yes

Model	NTE11L
Battery Type	7.4V 2Ah 14.8Wh
Tubing Type	Soft or Annealed Copper
Tube OD	3/8", 1/2", 5/8", 3/4", 7/8", 1", 1-1/8"
Weight	3.4 lbs (with battery)

N11LNB (no battery, no charger)

► For NEF6LM owners

Quick Connect Expander Heads	Yes
NAQA1 Quick Connect Adapter	No
NBF2 Lithium Battery	No
NCF2 Battery Charger	No
Carry Case	Yes

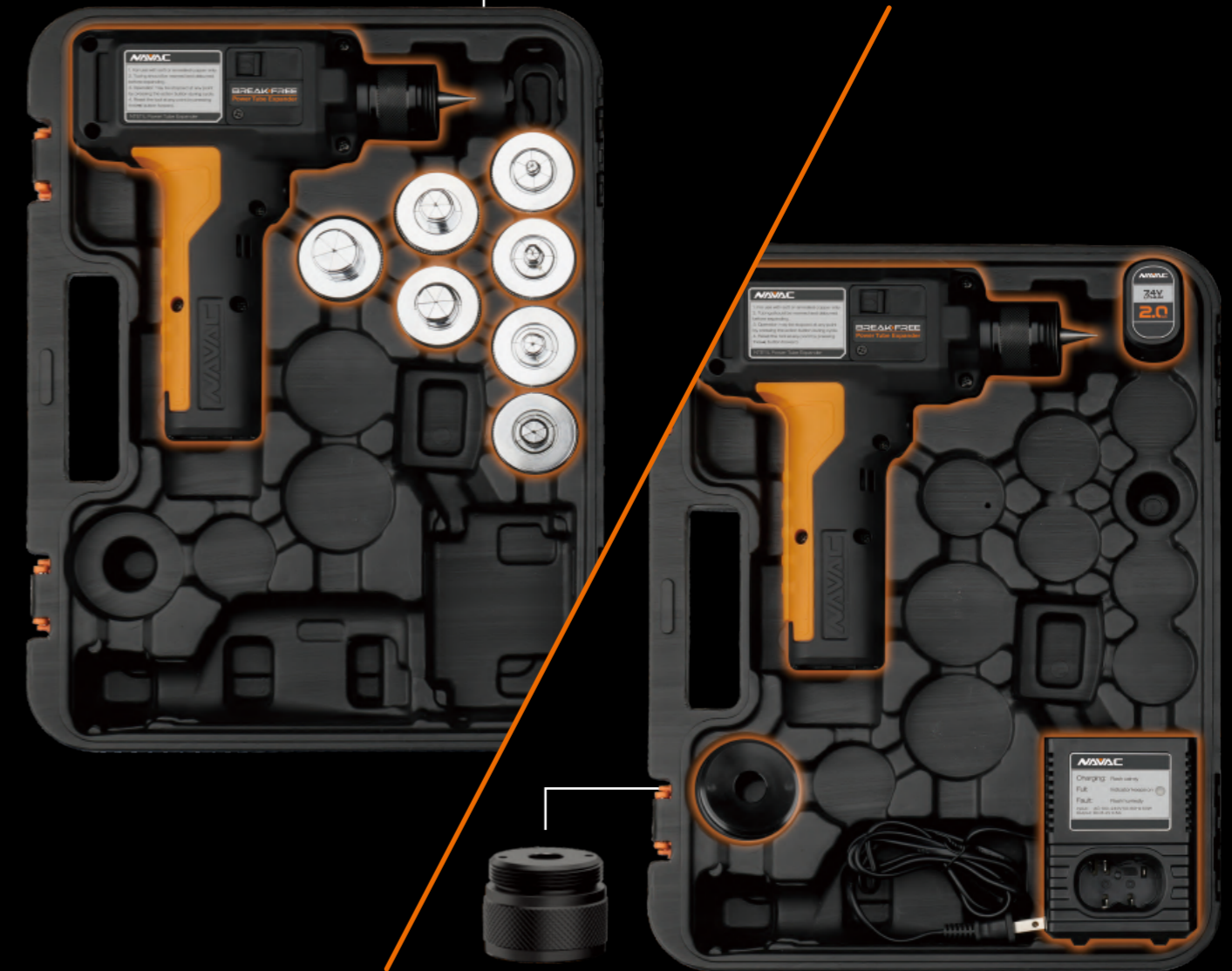

NAQA1
Quick Connect Adapter

Expander heads from NTE11H Hydraulic Expander can be shared with NTE11L with a NAQA1 adapter.

N11LNH (no heads)

► For NTE11L, NTEHHK owners

Quick Connect Expander Heads	No
NAQA1 Quick Connect Adapter	Yes
NBF2 Lithium Battery	Yes
NCF2 Battery Charger	Yes
Carry Case	Yes

**NTC6
NTC12
NTC15
Tube Cutter**

With sharp cutting blade, ball bearings and aluminum alloy body, it makes tube cutting easy and efficient.

Leading Technology, Superior Quality, Best Experience.

Empowering You to Work Smarter



Easy to Cut

High-Quality Cutting Blade

- Sharp and durable
- One extra blade supplied

Ball Bearing

- Easy cutting and better quality
- Short cut for flare ends, saving copper

Aluminum Alloy

- Light weight, easy to carry and use

Model	NTC6	NTC12	NTC15
Tube OD	1/8" - 3/4"	1/8" - 1-1/4"	1/4" - 1-5/8"

**NTR14
Internal & External Reamer**

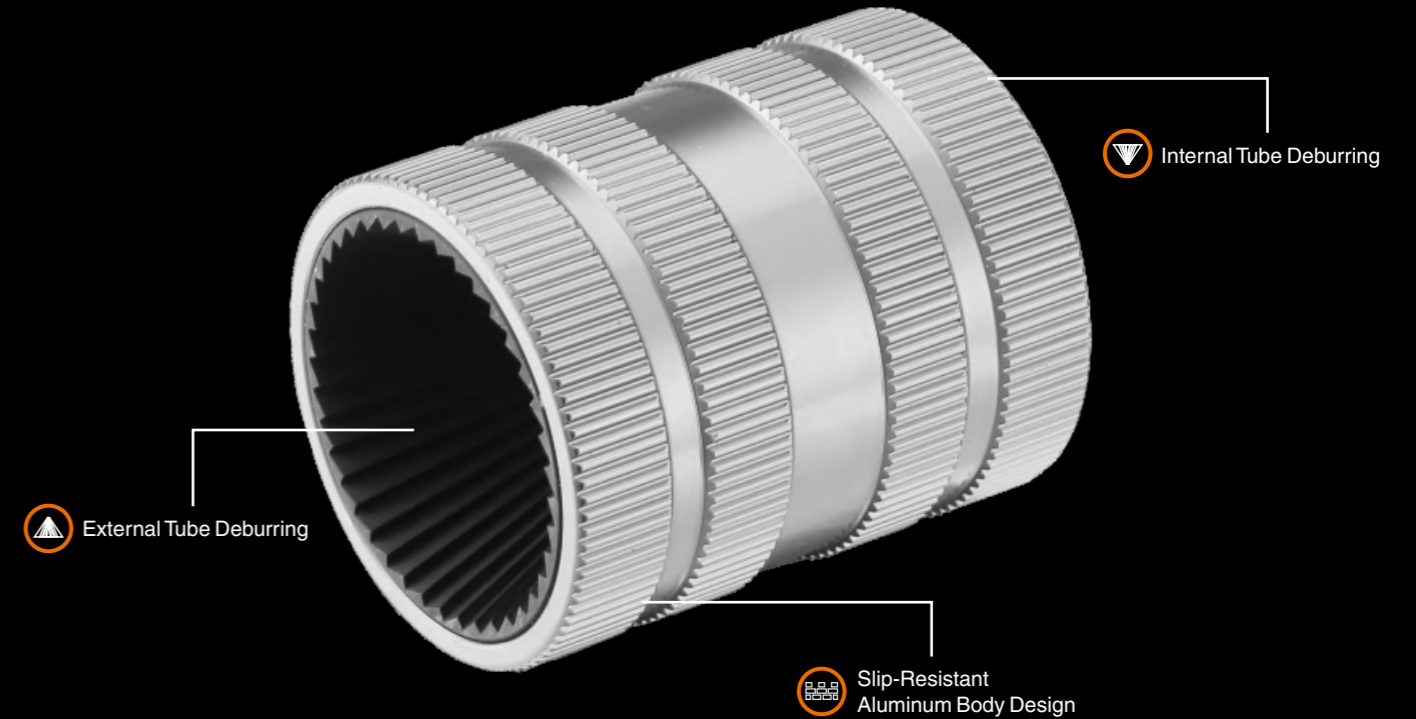

Fast, Easy and Clean

Multi-Blade Alloy Steel Internal Surface

- Easy to clean internal and external tubing surfaces

Slip-Resistant Aluminum Body Design

- Light weight
- Durability

Model	NTR14
Tube OD	1/8" - 1-1/2"

NTD28
Tube Deburring Tool



Easy to Carry and Use

Replaceable Blades
• 2 spare blades included

Easy to Carry

NTK1
Tubing Tool Kit

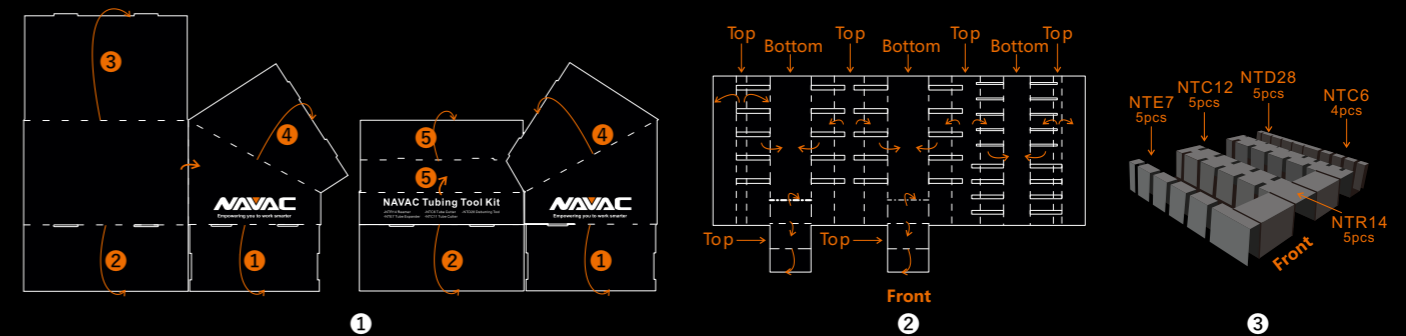

Your Favorite NAVAC Tubing Tools

Counter Displayable

Convenient Showcase

Easy to Refill

Item	Description	Quantity
NTE7	Tube Expander, 7/8" Max OD	5
NTR14	Internal/External Reamer, 1-1/2" Max OD	5
NTC12	Tube Cutter, 1/8"-1-1/4" Max OD	5
NTC6	Tube Cutter, 3/4" Max OD	4
NTD28	Tube Deburrer	5
MM014	2 sets of counter display cartons	1

A2L (R32) Compatible Tools

Special Tools Needed, Processes Unchanged

Refrigerant Safety Groups	Lower Toxicity OEL > 400ppm	Higher Toxicity OEL < 400ppm
Higher Flammability	A3 All Hydrocarbons	B3
Lower Flammability HCFs, non-fluorocarbons	A2 R-152a	B2
Lower Flammability (Mildly Flammable) Low Burning Velocity HCFs, HFC/HFO Blends, HFOs	A2L R-32, R-452B, R-454B, R-455A, R-516A, R-1234yf, R-134ze(E)	B2L
No Flame Propagation HFCs, HFC/HFO Blends, HFOs, HCFOs, HFO/chloro-olefin blends, non-fluorocarbons	A1 R-134a, R410A, R-448A, R-449A, R-460B, R-513A, R-515A, R-1336mzz(Z)	B1

With the impending phasedown of HFCs, including the widely used R-410A, air conditioning equipment containing lower-GWP refrigerants will be coming to market over the next few years. Unlike previous refrigerant transitions, which moved from one nonflammable (A1) refrigerant to another, this transition will likely be to A2L refrigerants, which are mildly flammable. ^①

NAVAC, the world's largest supplier of HVAC vacuum pumps in addition to a wide array of tools, gauges, charging machines, recovery units and other industry-specific items, is one of the first manufacturers who offer a full-line of A2L compatible tools, including vacuum pumps, recovery units and manifold gauges.

Resource:

^①Turpin, J. R. (2021, October 9). A1 versus A2L refrigerants: Similar but different. ACHR News RSS. Retrieved November 19, 2021.

A2L (R32) Compatible Tools

Special Tools Needed, Processes Unchanged



No.	Model	Description	No.	Model	Description
1	NP2DLM	BreakFree Cordless Vacuum Pump, 2CFM	6	NRDD & NRDDF	Digital DC Recovery Unit
2	NP4DLM	BreakFree Cordless Vacuum Pump, 4CFM	7	NRDC4M	4-Cylinder Recovery Unit
3	NP7DP2	Vacuum Pump, 7CFM	8	N2A4A	Manifold Gauge
4	NRP6Di & NRP8Di	Smart Vacuum Pump, Master Series	9	N2D4H	Manifold Gauge with Digital Display, 5 Hoses
5	NP12DM	Vacuum Pump, Industrial Grade, Master Series	10	NKS1	Advanced Mini-Split Tool Kit

NAVAC'S No-Hassle Warranty

Warranty Information

NAVAC Inc. GUARANTEES all NAVAC products to be free of defective material and craftsmanship which could affect the life of the product when used for purpose for which it is designed. This warranty does not cover items which have been abused, misused, or improperly maintained, (including failure to use the correct type of vacuum pump oil). The sole obligation under this warranty shall be to repair, replace (OTC Exchange), or provide credit for any defective product or parts thereof, at the discretion of NAVAC Inc. within the period mentioned below. In some instances, NAVAC Inc. may require the defective product be returned for warranty analysis.

Note: Warranty only applies if product is purchased from a NAVAC Authorized Dealer.

Different warranty periods cover different product groups, so please read carefully.

Warranty period is stated in chart below:

Category	Model	Warranty Period (Years)
Charging Station	NRC62i / NRC62D	2
BreakFree™ Cordless Vacuum Pump	NP2DLM / NP4DLM	2
Digital Vacuum Pump	NRP6Di / NRP8Di	2
Industrial-Grade Vacuum Pump	NP12DM	2
Digital Recovery Unit	NRDD	2**
4 Cylinder Recovery Unit	NRDC4M	2
BreakFree™ Power Flaring Tool	NEF6Li / NEF6LM	2
BreakFree™ Power Tube Expander	NTE11L / N11LNB / N11LNH	2
Hydraulic Tube Expander	NTE11H / NTEHHK	2
Vacuum Pump	NP4DP / NP7DP / NP7DP2	1
Mechanical Pump	NRP6DV / NRP8DV	1
Ammonia Vacuum Pump	NP12DA1	1
Industrial Vacuum Pump	NRD16T / NRD24M / NRD30M	1
Mechanical Recovery Unit	NRRD	1
Recovery Unit for Flammable Refrigerants	NRDDF	1
Manifold Gauge	NRM1D / NRM2D / N2D4H / N4A3H / N4A4H / NRM1B / NRM2B / N2A4 / N2A4A	1
Hose	NRHH53 / NRHH53C / NH5SC / NHB1 / NHB2 / NHB3	1
Core Tool	NVR1	1
Rapid Evacuation Kit	NEVK1 / NEVK2 / NEVK3	1
Scale	NRS2i01 / NRS3i01	1
Micron Gauge	NMV1	1
Refrigerant Leak Detector	NML1	1
Digital Clamp Meter	NMC1	1
Infrared Thermometer	NMT300	1
Mechanical Flaring Tool	NTF66 / NTF66C / NTF67D	1
Flaring Gauge	NFG1	1
Mechanical Expander	NTE7	1
Torque Wrench	NTW1	1
Tube Cutter	NTC6 / 11 / 12 / 13 / 15	1
Reamer / Deburrer	NTR14 / NTD28	1
Electronic Accessory	NB1 / NBF2 / NBP2 / NAPS1 / NC1 / NC2 / NCF2	2

****3 YEARS IF PRODUCT IS REGISTERED** at <https://navacglobal.com/product-registration/> (Effective 4/1/2020)

Vacuum Pump / Charging Machine / Recovery Unit / Tubing Tools:

Use these devices to pump and recover only HVAC/R refrigerants from sealed HVAC/R systems. Warranty is voided if used for any other purpose, including manufacturing purposes.

NAVAC Pumps and Recovery Units are not warranted for use on the following systems:

- Lithium
- Ammonia (Except NP12DA1)
- Bromide
- Butane (Except NRDDF)
- CO₂ type extraction
- Leak Stop products

Warranty is VOID if:

- Oil has NOT been changed.
- Corrosive substances have been introduced in the pump.
- Pump has been altered, modified, or any components missing or removed.

Gauges:

The following exceptions **will not** be covered under this warranty.

- Over-pressurized or broken gauges.
- Gauges that have been altered, misused, or improperly maintained.

Tools:

Hand tools are covered except for "Tool Kits". **Only the failed component** will be issued a credit or replacement. For the NKS1, each tool will be warrantied for its individual warranty period in the chart above, based on Date of Purchase of NKS1.

How to Return Product

Prior to returning any product to NAVAC, you are required to obtain a Returns Merchandise Authorization, (RMA), number.

Fill out the online RMA form at <https://navacglobal.com/return-merchandise-authorization/> or Download an RMA Form <https://navacglobal.com/wp-content/uploads/2019/05/2019-RMA-Form.pdf> and email to Techsupport@navacglobal.com, or Fax to 877-696-2822 Please fill out completely. Any missing information could delay processing.

Company Information:

NAVAC Inc. is a leading provider of advanced HVAC Tools. We offer highly differentiated vacuum pumps, recovery units, refrigerant charging machines, manifold gauges and other tools for HVAC service technicians to make their job easier, more efficient and enjoyable.

Office Address: 1099 Wall Street West, Suite 179
Lyndhurst, NJ 07071
Telephone: +1 877 MY-NAVAC
Fax: +1 877 696 2822
Web URL: www.NavacGlobal.com

Primary/Order Contact: Phone: +1 877 MY-NAVAC, Fax: +1 877 696 2822
Email: Order@NavacGlobal.com

Facebook:
[@NAVACHvactools](https://www.facebook.com/NAVACHvactools)



Instagram:
[navac_inc_hvac_tools](https://www.instagram.com/navac_inc_hvac_tools)



LinkedIn:
[NAVAC Inc. - HVAC Tools Division](https://www.linkedin.com/company/NAVAC-Inc.-HVAC-Tools-Division)



YouTube:
[NAVAC Inc. HVAC Tools Division](https://www.youtube.com/NAVAC-Inc.-HVAC-Tools-Division)

