

Your Ideal Vacuum Pump



NAVAC Inc.

1099 Wall Street West, Suite 242
Lyndhurst, NJ 07071

T +1 201.939.6699

F +1 201.939.3899

Info@NavacGlobal.com

www.NavacGlobal.com

High Reliability

Speed • Innovation • Quality

Your Ideal Vacuum Pump

Speed • Innovation • Quality



High Reliability

Speed • Innovation • Quality

NRS

Single Stage Oil Sealed Rotary Vane Vacuum Pump

Perfect Design and Performance



Wind Energy



Solar



Oil and Gas



Electric Power Engineering



Automotive & Transport

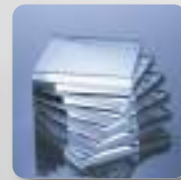

Glass



Space and Aeronautics



Plastic and Rubber



Analytics & Laboratory



Battery



Vulcanization



Medical & Hospitals



Filter Press



Machine Building

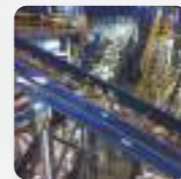

Waste Management

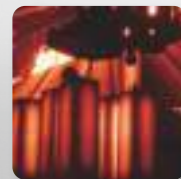

Metallurgical Industry



Semiconductor



LED

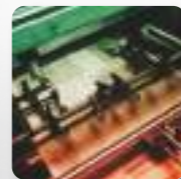

Printing

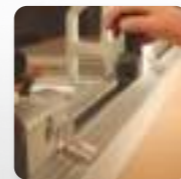

Wood Industry



Lifting



Vacuum Packaging

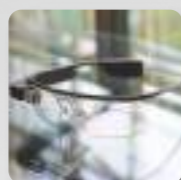

Film Plating



Surface Technology



Vacuum Forming

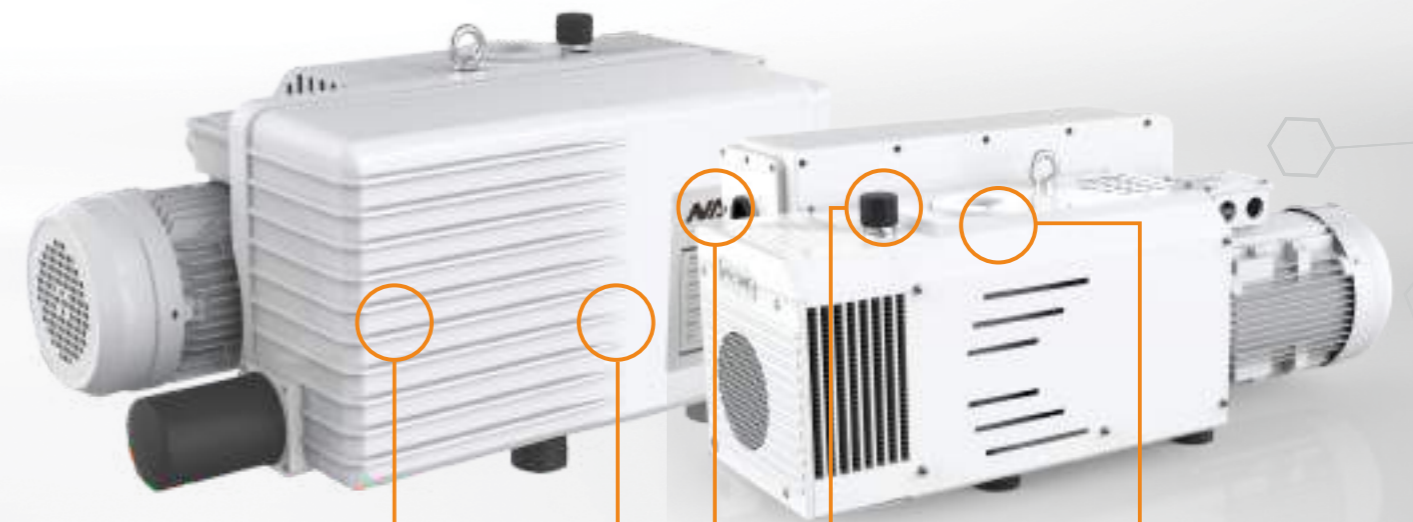

Seals made from FPM improving the anti-corrosion performance and preventing oil leakage issues.



High efficiency oil mist filters prevent oil vapor exhausting into the equipment space and smoking while also prolonging the service life.



Gas ballast helps to evacuate more vapor



Integrated anti-suckback valve

High Reliability

Speed • Innovation • Quality

Features

- ✓ High efficiency oil mist filters prevent oil vapor exhausting into the equipment space and smoking while also prolonging the service life.
- ✓ Sealing parts are made from fluororubber (FPM) improving the anti-corrosion performance and preventing oil leakage issues.
- ✓ Japanese Mori Seiki Horizontal CNC machining guarantees high reliability and precision.
- ✓ Unique industrial design yields elegant appearance.
- ✓ Integrated pump and motor design.

Flow Rate Characteristic

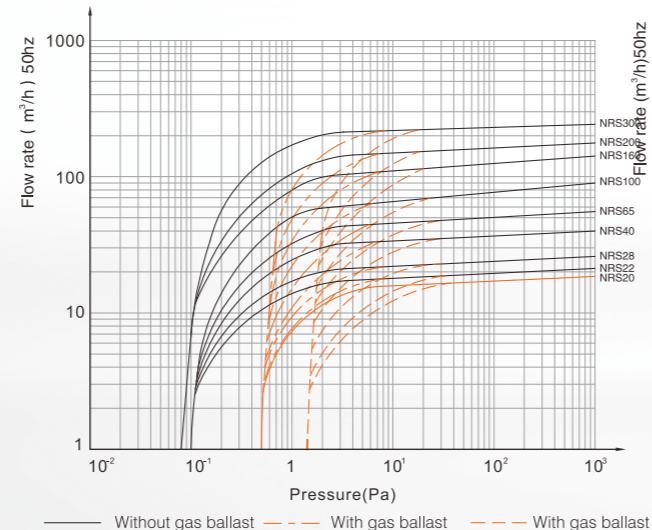

NRS100

NRS

Single Stage Oil Sealed Rotary Vane Vacuum Pump

Specification		NRS20	NRS22	NRS28	NRS40	NRS65
Displacement speed	m ³ /h (50Hz)	20	22	28	40	65
	cfm (60Hz)	14	16	20	28	46
Ultimate pressure (total)	pa	100	30	30	30	30
	torr	7.5×10 ⁻¹	2.25×10 ⁻¹	2.25×10 ⁻¹	2.25×10 ⁻¹	2.25×10 ⁻¹
	In.Hg	30	9	9	9	9
Ultimate pressure - GB I	mbar	0.5	0.5	0.5	0.5	0.5
	torr	3.75×10 ⁻¹	3.75×10 ⁻¹	3.75×10 ⁻¹	3.75×10 ⁻¹	3.75×10 ⁻¹
Ultimate pressure - GB II	mbar	1.5	1.5	1.5	1.5	1.5
	torr	1.125	1.125	1.125	1.125	1.125
Water vapor tolerance - GB I	mbar	15	15	15	15	15
Water vapor capacity - GB I	kg/h	0.2	0.2	0.3	0.4	0.5
	torr	11	11	11	11	11
Water vapor tolerance - GB II	mbar	30	30	30	30	30
	torr	22	22	22	22	22
Water vapor capacity - GB II	kg/h	0.4	0.4	0.5	0.8	1.0
	torr	15	15	15	15	15
Power rating	kw	0.75	1.1	1.1	1.1	1.5
	hp	1	1.5	1.5	1.5	2
Motor speed	rpm (50Hz)	1440	1440	1440	1440	1440
	rpm (60Hz)	1720	1720	1720	1720	1720
Oil capacity	litres	0.5	1	1	2	2
Oil type (NPO)		46H	68H	68H	68H	68H
Inlet and exhaust flange		G3/4"	G3/4"	G3/4"	G1-1/4"	G1-1/4"
Noise level	dB	65	58	58	59	61
Ambient Temperature	°C	10-40	10-40	10-40	10-40	10-40
Net weight	kg	20	30	30	40	43
	lbs	44	66	66	88	95
Dimensions	mm	317×249×219	496×268×248	496×268×248	555×304×268	555×311×268
	in	12.5×9.8×8.6	12.5×10.6×9.8	12.5×10.6×9.8	21.9×12×10.6	21.9×12.2×10.6

Specification		NRS100	NRS160	NRS200	NRS300
Displacement speed	m ³ /h (50Hz)	100	160	200	300
	cfm (60Hz)	70	113	140	212
Ultimate pressure (total)	pa	30	8	8	8
	torr	2.25×10 ⁻¹	6×10 ⁻²	6×10 ⁻²	6×10 ⁻²
	In.Hg	9	3	3	3
Ultimate pressure - GB I	mbar	0.5	0.5	0.5	0.5
	torr	3.75×10 ⁻¹	3.75×10 ⁻¹	3.75×10 ⁻¹	3.75×10 ⁻¹
Ultimate pressure - GB II	mbar	1.5	1.5	1.5	1.5
	torr	1.125	1.125	1.125	1.125
Water vapor tolerance - GB I	mbar	15	30	30	30
Water vapor capacity - GB I	kg/h	0.8	2.4	2.8	3.8
	torr	11	22	22	22
Water vapor tolerance - GB II	mbar	30	50	50	50
	torr	22	37	37	37
Water vapor capacity - GB II	kg/h	1.6	4.0	4.8	6.4
	torr	15	15	15	15
Power rating	kw	2.2	4	4	5.5
	hp	3	5.4	5.4	7.4
Motor speed	rpm (50Hz)	1440	1440	1440	1440
	rpm (60Hz)	1720	1720	1720	1720
Oil capacity	litres	5	7	7	9
Oil type (NPO)		68H	68H	68H	68H
Inlet and exhaust flange		G1-1/4"	G2"	G2"	G2"
Noise level	dB	62	70	70	71
Ambient Temperature	°C	10-40	10-40	10-40	10-40
Net weight	kg	70	143	143	197
	lbs	155	316	316	435
Dimensions	mm	703×406×286	930×533×436	930×533×436	1035×540×434
	in	27.7×16×11.3	36.6×21×17.2	36.6×21×17.2	40.7×21.3×17.1

High Reliability

Speed • Innovation • Quality

NRD

Dual Stage Oil Sealed Rotary Vane Vacuum Pump

Perfect Design and Performance



Refrigeration Industry

Refrigerant charging, A/C, helium leak detection, helium recovery systems, etc...



Medical Industry

Plasma sterilizers, vacuum freeze drying, vacuum mixing. NRD M Series available to handle large amounts of H₂O₂ gas and water vapor.



Analytical Instruments

Mass spectrometry, SEM, Helium Leak Detection, Analytical Equipment in Chemistry.



Power Industry

Transformer drying, Solar Cell Production, etc...



Electronics, Semi-Conductor Industry

Sf₆ gas recovery, vacuum oven, glovebox, sapphire and polycrystalline furnace, vacuum annealing/heat treatment, plasma cleaning, thin film vacuum coatings, backing high vacuum or roots systems.



Two-shift adjustable gas ballast valve
allows for the different requirements of condensable gas to be exhausted.

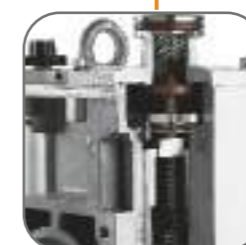

Dual automatic anti-suckback design
Protects vacuum system from oil contamination in the event of an unexpected shut down



Forced oil circulation system
ensures stable running of the pump

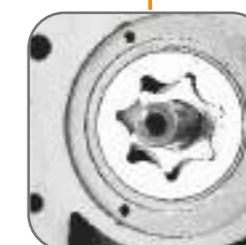

Integrated cylinder structure and pin connection
convenient and accurate for maintenance and inspection

High Reliability

Speed • Innovation • Quality

Features

- ✔ **Gas Ballast**
 Adjustable gas ballast allows for the different requirements of condensable gas to be exhausted.
- ✔ **Oil**
 High quality mineral oil provided standard with the pump. All models can also be prepped for PFPE.
- ✔ **Anti Suck Back Design**
 Protects vacuum system from oil contamination in the event of an unexpected shut down.

Flow Rate Characteristic

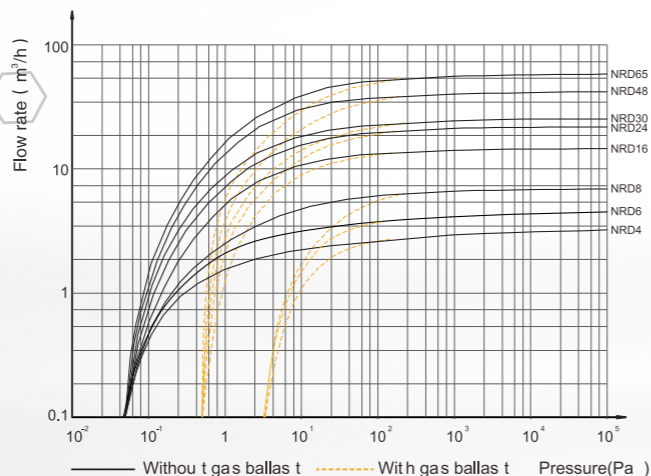

NRD8

NRD

Dual Stage Oil Sealed Rotary Vane Vacuum Pump

Specification		NRD4	NRD6	NRD8	NRD16
Displacement speed	m ³ /h (50Hz)	4	6	8	16
	cfm (60Hz)	2.8	4.2	5.6	11.3
Ultimate pressure (total)	pa	5×10 ⁻¹	5×10 ⁻¹	5×10 ⁻¹	4×10 ⁻¹
	torr	3.75×10 ⁻³	3.75×10 ⁻³	3.75×10 ⁻³	3.0×10 ⁻³
	mbar	5×10 ⁻³	5×10 ⁻³	5×10 ⁻³	4×10 ⁻³
Ultimate pressure GB (total)	pa	3	3	3	8×10 ⁻¹
	torr	2.25×10 ⁻²	2.25×10 ⁻²	2.25×10 ⁻²	6.0×10 ⁻³
Water vapor tolerance	mbar	30	30	30	25
	torr	22	22	22	18
Water vapor capacity	kg/h	0.1	0.1	0.2	0.3
Power rating	kw	0.4	0.4	0.4	0.75
	hp	0.5	0.5	0.5	1
Motor speed	rpm (50Hz)	1440	1440	1440	1440
	rpm (60Hz)	1720	1720	1720	1720
Oil capacity	litres	1	1	1	1.5
Oil type (NPO)		46H	46H	46H	68H
Inlet and exhaust flange		KF16	KF16	KF16	KF25
Noise level	dB	56	56	56	58
Ambient Temperature	°C	5-40	5-40	5-40	5-40
Net weight	kg	19	20	20	33
	lbs	42	44	44	73
Dimensions	mm	460×144×207	460×144×207	460×144×207	520×188×272
	inch	18.1×5.6×8.1	18.1×5.6×8.1	18.1×5.6×8.1	20.5×7.4×10.7

Specification		NRD24	NRD30	NRD48	NRD65
Displacement speed	m ³ /h (50Hz)	24	30	48	65
	cfm (60Hz)	17	21.2	34	46
Ultimate pressure (total)	pa	4×10 ⁻¹	4×10 ⁻¹	4×10 ⁻¹	4×10 ⁻¹
	torr	3.0×10 ⁻³	3.0×10 ⁻³	3.0×10 ⁻³	3.0×10 ⁻³
	mbar	4×10 ⁻³	4×10 ⁻³	4×10 ⁻³	4×10 ⁻³
Ultimate pressure GB (total)	pa	8×10 ⁻¹	8×10 ⁻¹	8×10 ⁻¹	8×10 ⁻¹
	torr	6.0×10 ⁻³	6.0×10 ⁻³	6.0×10 ⁻³	6.0×10 ⁻³
Water vapor tolerance	mbar	25	25	20	20
	torr	18	18	15	15
Water vapor capacity	kg/h	0.5	0.6	0.7	0.9
Power rating	kw	1.1	1.1	1.5	2.2
	hp	1.5	1.5	2	3
Motor speed	rpm (50Hz)	1440	1440	1440	1440
	rpm (60Hz)	1720	1720	1720	1720
Oil capacity	litres	2	2	4	4
Oil type (NPO)		68H	68H	100H	100H
Inlet and exhaust flange		KF25	KF25	KF40	KF40
Noise level	dB	58	58	62	62
	°C	5-40	5-40	5-40	5-40
Net weight	kg	35	37	62	65
	lbs	77	82	137	143
Dimensions	mm	560×188×272	560×188×272	720×234×358	720×234×358
	inch	20.5×7.4×10.7	20.5×7.4×10.7	28.3×9.2×14.1	28.3×9.2×14.1

High Reliability

Speed • Innovation • Quality

Features

- ✔ **Gas Ballast**
 Adjustable gas ballast allows for the different requirements of condensable gas to be exhausted.
- ✔ **Oil**
 High quality mineral oil provided standard with the pump. All models can also be prepped for PFPE.
- ✔ **Anti Suck Back Design**
 Protects vacuum system from oil contamination in the event of an unexpected shut down.

Flow Rate Characteristic

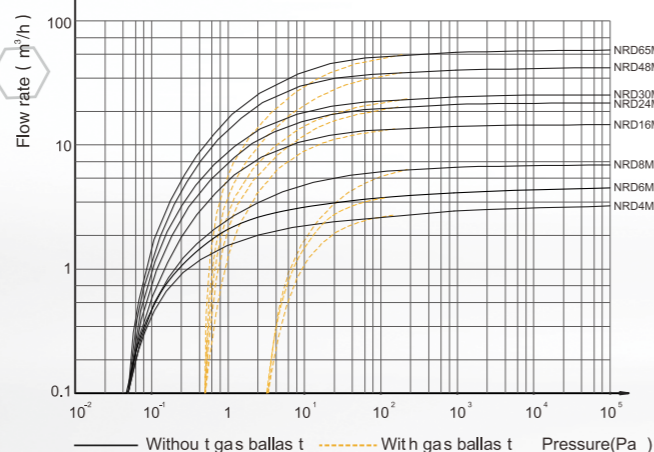

NRD8M

✔ Mild Corrosion Resistant

NRD M Series pumps are designed to perform in mildly corrosive applications such as H₂O₂.

NRD M

Dual Stage Oil Sealed Rotary Vane Vacuum Pump

Specification		NRD8M	NRD16M	NRD30M
Displacement speed	m ³ /h (50Hz)	8	16	30
	cfm (60Hz)	5.6	11.3	21.2
Ultimate pressure (total)	pa	5×10 ⁻¹	4×10 ⁻¹	4×10 ⁻¹
	torr	3.75×10 ⁻³	3.0×10 ⁻³	3.0×10 ⁻³
	mbar	5×10 ⁻³	4×10 ⁻³	4×10 ⁻³
Ultimate pressure GB (total)	pa	3	8×10 ⁻¹	8×10 ⁻¹
	torr	2.25×10 ⁻²	6.0×10 ⁻³	6.0×10 ⁻³
Water vapor tolerance	mbar	30	25	25
	torr	22	18	18
Water vapor capacity	kg/h	0.2	0.3	0.6
Power rating	kw	0.4	0.75	1.1
	hp	0.5	1	1.5
Motor speed	rpm (50Hz)	1440	1440	1440
	rpm (60Hz)	1720	1720	1720
Oil capacity	litres	1	1.5	2
Oil type (NPO)		46H	68H	68H
Inlet and exhaust flange		KF16	KF25	KF25
Noise level	dB	56	58	58
Ambient Temperature	°C	5-40	5-40	5-40
Net weight	kg	20	33	37
	lbs	44	73	82
Dimensions	mm	460×144×207	520×188×272	560×188×272
	inch	18.1×5.6×8.1	20.5×7.4×10.7	20.5×7.4×10.7



High Reliability

Speed • Innovation • Quality

Dimension

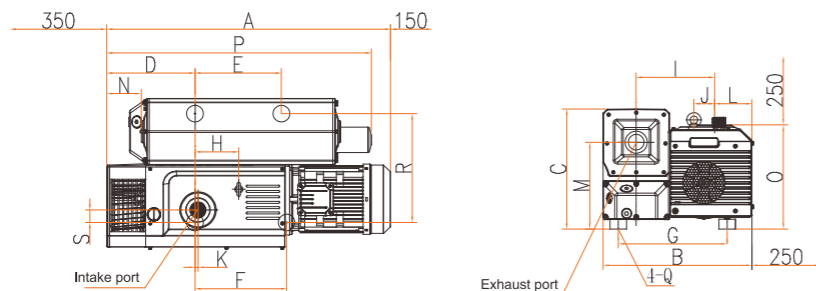

Dimensions (inch)

Model	A	B	C	D	E	F	G	H	I	J	K	L	M	N	O	P	Q	R	S	Intake port	Exhaust port
NRS20	12.5	9.8	8.6	2.8	5.5	4.3	5.2	/	127.5	/	14	5	6.2	0.7	7.2	11.9	M8	5.0	0.2	G1/2" G3/4"	/
NRS22	19.5	10.5	9.8	4.4	8.7	11.8	7.5	4.2	146	25	20	5.7	7.2	1.1	8	15.4	M6	7.6	1.4	G3/4"	G3/4"
NRS28	19.5	10.5	9.8	4.4	8.7	11.8	7.5	4.2	146	25	20	5.7	7.2	1.1	8	15.4	M6	7.6	1.4	G3/4"	G3/4"
NRS40	21.8	12	10.6	5.9	8.5	7.9	9.3	2.3	179	51	5	7	8	1.3	9.9	18.3	M8	9.3	1.3	G1"1/4"	G1"1/4"
NRS65	21.8	12.2	10.6	5.9	8.5	7.9	10	2.3	189	51	5	7.4	8	1.3	9.9	18.3	M8	9.5	1.3	G1"1/4"	G1"1/4"
NRS100	27.7	16	11.3	6.5	8.9	8.9	12.6	5.2	226	42	27	8.9	8.7	2.4	11	22.8	M10	10.2	1.6	G1"1/4"	G1"1/4"
NRS160	36.6	21	17	10.4	9.9	12	15.5	4.4	298	66	32	11.7	12	5.3	15	36.6	M10	15.5	1.8	G2"	G2"
NRS200	36.6	21	17	10.4	9.9	12	15.5	4.4	298	66	32	11.7	12	5.3	15	36.6	M10	15.5	1.8	G2"	G2"
NRS300	40.7	21.3	17	12.8	12.3	13	15.5	6.3	284	75	11	11.2	12.4	5.2	14.8	38	M10	15.5	1.8	G2"	G2"

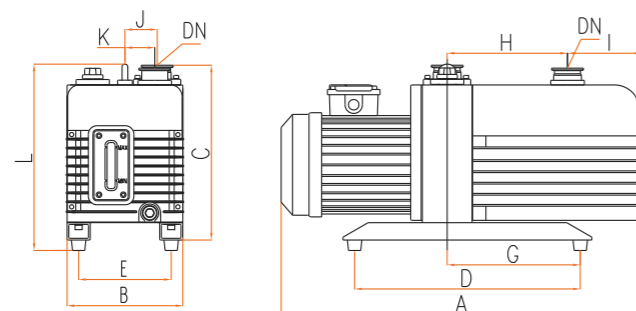

Dimensions (inch)

Model	A	B	C	D	D	E	G	H	I	J	K	L	DN
NRD4	18.1	5.7	8.1	8.1	8.3	4.3	5	6.1	1.8	1.8	1.3	/	KF16
NRD6	18.1	5.7	8.1	8.1	8.3	4.3	5	6.1	1.8	1.8	1.3	/	KF16
NRD8	18.1	5.7	8.1	8.1	8.3	4.3	5	6.1	1.8	1.8	1.3	/	KF16
NRD16	20.5	7.4	10.7	10.7	12.6	5.8	6.3	6.5	2.7	2.3	1.5	11.6	KF25
NRD24	22	7.4	10.7	10.7	12.6	5.8	6.3	7.3	3.2	2.3	1.9	11.6	KF25
NRD30	22	7.4	10.7	10.7	12.6	5.8	6.3	7.3	3.2	2.3	1.9	11.6	KF25
NRD48	28.7	9.2	14.1	14.1	15.6	7.5	7.9	8.8	6.2	2.7	2.2	15.4	KF40
NRD65	28.7	9.2	14.1	14.1	15.6	7.5	7.9	8.8	6.2	2.7	2.2	15.4	KF40

Available Motor Specifications

	NRD4	NRD6	NRD8	NRD16	NRD24	NRD30	NRD48	NRD65
115-230V / 50-60Hz, 1ph	yes	yes	yes					
115V / 60Hz, 1ph				yes	yes	yes		
230-460V / 50-60Hz, 3ph	yes	yes	yes	yes	yes	yes	yes	yes

Spare Parts

Your Ideal Vacuum Pump



Oil Mist Filter 	Connectors and fittings 	KF Model Air Inlet 	O-Ring
Clamp 	Centering Ring 	Filter 	Flange
Adapter 	Pump Oil 		

High Reliability

Speed • Innovation • Quality

Ordering info

Your Ideal Vacuum Pump

NRS

Model	Product Description	Order No. VPO mineral oil
NRS4	115V, 60Hz, 1ph	N20041001
NRS8	115V, 60Hz, 1ph	N20081001
NRS10	115V, 60Hz, 1ph	N20101001
NRS16	115V, 60Hz, 1 ph	N20161001
NRS20	115V, 60Hz, 1 ph	N20201001
	200-220/380-415V, 50Hz, 200-230/460V, 60Hz, 3 ph	N20201002
NRS22	200-220/380-415V, 50Hz, 200-230/460V, 60Hz, 3 ph	N20221001
NRS28	200-220/380-415V, 50Hz, 200-230/460V, 60Hz, 3 ph	N20281001
NRS40	200-220/380-415V, 50Hz, 200-230/460V, 60Hz, 3 ph	N20401001
NRS65	200-220/380-415V, 50Hz, 200-230/460V, 60Hz, 3 ph	N20651001
NRS100	200-220/380-415V, 50Hz, 200-230/460V, 60Hz, 3 ph	N201001001
NRS160	200-220/380-415V, 50Hz, 200-230/460V, 60Hz, 3 ph	N201601001
NRS200	200-220/380-415V, 50Hz, 200-230/460V, 60Hz, 3 ph	N202001001
NRS300	200-220/380-415V, 50Hz, 3 ph	N203001001

Oil and others

Model	Product Description	Order No.
Oil	NPO46H02 (0.5 liter bottle, for NRS20)	NPO46H02
	NPO68H (1 liter bottle for NRS22/28/40/65/100/160/200/300)	NPO68H
Service kit	for NRS20	NSK20
	for NRS22	NSK22
	for NRS28	NSK28
	for NRS40	NSK40
	for NRS65	NSK65
	for NRS100	NSK100
	for NRS160	NSK160
	for NRS200	NSK200
for NRS300	NSK300	

NRD

Model	Product Description	Order No. VPO mineral oil	Order No. PFPE oil not included
NRD4	115/230V, 50/60Hz, 1 ph, set to 115V	N10041001	N10042001
	200-220/380-415V, 50Hz, 200-230/460V, 60Hz, 3 ph	N10041002	N10042002
NRD6	115/230V, 50/60Hz, 1 ph, set to 115V	N10061001	N10062001
	200-220/380-415V, 50Hz, 200-230/460V, 60Hz, 3 ph	N10061002	N10062002
NRD8	115/230V, 50/60Hz, 1 ph, set to 115V	N10081001	N10082001
	200-220/380-415V, 50Hz, 200-230/460V, 60Hz, 3 ph	N10081002	N10082002
NRD16	115V, 60Hz, 1 ph	N10161001	N10162001
	230V, 50Hz, 1 ph	N10161002	N10162002
	200-220/380-415V, 50Hz, 200-230/460V, 60Hz, 3 ph	N10161003	N10162003
NRD24	115V, 60Hz, 1 ph	N10241001	N10242001
	230V, 50Hz, 1 ph	N10241002	N10242002
	200-220/380-415V, 50Hz, 200-230/460V, 60Hz, 3 ph	N10241003	N10242003
NRD30	115V, 60Hz, 1 ph	N10301001	N10302001
	230V, 50Hz, 1 ph	N10301002	N10302002
	200-220/380-415V, 50Hz, 200-230/460V, 60Hz, 3 ph	N10301003	N10302003
NRD48	200-220/380-415V, 50Hz, 200-230/460V, 60Hz, 3 ph	N10481001	N10482001
NRD65	200-220/380-415V, 50Hz, 200-230/460V, 60Hz, 3 ph	N10651001	N10652001

High Reliability

Speed • Innovation • Quality

Ordering info

Your Ideal Vacuum Pump

NRD M

Model	Product Description	Order No. VPO mineral oil	Order No. PFPE oil not included
NRD8	115/230V, 50/60Hz, 1 ph, set to 115V	N10081001M	N10082001M
	200-220/380-415V, 50Hz, 200-230/460V, 60Hz, 3 ph	N10081002M	N10082002M
NRD16	115V, 60Hz, 1 ph	N10161001M	N10162001M
	230V, 50Hz, 1 ph	N10161002M	N10162002M
	200-220/380-415V, 50Hz, 200-230/460V, 60Hz, 3 ph	N10161003M	N10162003M
NRD24	115V, 60Hz, 1 ph	N10241001M	N10242001M
	230V, 50Hz, 1 ph	N10241002M	N10242002M
	200-220/380-415V, 50Hz, 200-230/460V, 60Hz, 3 ph	N10241003M	N10242003M
NRD30	115V, 60Hz, 1 ph	N10301001M	N10302001M
	230V, 50Hz, 1 ph	N10301002M	N10302002M
	200-220/380-415V, 50Hz, 200-230/460V, 60Hz, 3 ph	N10301003M	N10302003M
NRD48	200-220/380-415V, 50Hz, 200-230/460V, 60Hz, 3 ph	N10481001M	N10482001M
NRD65	200-220/380-415V, 50Hz, 200-230/460V, 60Hz, 3 ph	N10651001M	N10652001M

Oil and others

Model	Product Description	Order No.
Oil	NPO46H (1 liter bottle, for NRD4/6/8)	NPO46H
	NPO68H (1 liter bottle, for NRD16/24/30 and NRS22/28/40/65/100/160/200/300)	NPO68H
	NPO100H (one 4-liter bottle, for NRD48/65)	NPO100H
Oil mist filter	NOT8A (KF16, for NRD4/6/8)	NOT8A
	NOT8B (KF25, for NRD4/6/8)	NOT8B
	NOT30B (KF25, for NRD16/24/30)	NOT30B
	NOT65C (KF40, for NRD48/65)	NOT65C
Service kit	for NRD4	NSK4
	for NRD6	NSK6
	for NRD8	NSK8
	for NRD16	NSK16
	for NRD24	NSK24
	for NRD30	NSK30
	for NRD48	NSK48
Service kit	for NRD65	NSK65
	for NRD8M	NSK8M
	for NRD16M	NSK16M
	for NRD24M	NSK24M
	for NRD30M	NSK30M
	for NRD48M	NSK48M
	for NRD65M	NSK65M