

User's Manual

All-in-one Collaboration Solution

NEC 55" InfinityBoard 2.1 (QL)

MONITOR MODEL: V554Q IGB

Please find your model name on the label on rear side of the monitor.

Index

Addendum to User's Manuals of MultiSync V554Q.....	Page 03
Registration Information.....	Page 04
Important Information.....	Page 06
Safety Precautions, Maintenance & Recommended Use.....	Page 07
Shipping Content.....	Page 08
Unpacking.....	Page 09
General Installation.....	Page 10
InfinityBoard Assembly Instruction.....	Page 11
Setup the OPS Slot-in PC.....	Page 16
Troubleshooting.....	Page 20
Specifications – 55" InfinityBoard 2.1 (QL).....	Page 21
Manufacturer's Recycling and Energy Information.....	Page 26

Addendum to User's Manuals of MultiSync V554Q

This user's manual is an addendum to the standard user's manual of the base model monitors V554Q. All specifications listed here supersede those in the standard version of the manual included with this monitor.

NOTE: Following feature sets are not supported by the InfinityBoard models:

- **Table Top Stand Option:** Other than the standard monitor, the NEC InfinityBoard does not allow for table top installations, as the table top brackets has been removed
- **Room Light Sensing Sensor:** Other than the standard monitor, the NEC InfinityBoard does not allow the monitor to make automatic adjustments to the backlight setting.
- **Intelligent Wireless Data Sensor:** Other than the standard monitor, the NEC InfinityBoard does not include a sensor for wireless communication to the monitor for information and settings.
- **NEC Logo Plate Position:** Other than on the standard monitor, changing the position of the NEC logo is not possible on the NEC InfinityBoard.

Registration Information

Cable Information

 **CAUTION:** Use the provided specified cables with this product so as not to interfere with radio and television reception. For USB please use a shielded signal cable with ferrite core. For HDMI, DisplayPort and D-Sub 9-pin, please use a shielded signal cable. For Audio, please use a signal cable with ferrite core. Use of other cables and adapters may cause interference with radio and television reception.

FCC Information

 **WARNING:** The Federal Communications Commission does not allow any modifications or changes to the unit EXCEPT those specified by NEC Display Solutions of America, Inc. in this manual. Failure to comply with this government regulation could void your right to operate this equipment.

This equipment has been tested and found to comply with the limits for a Class B digital device, pursuant to part 15 of the FCC Rules. These limits are designed to provide reasonable protection against harmful interference in a residential installation. This equipment generates, uses and can radiate radio frequency energy, and, if not installed and used in accordance with the instructions, may cause harmful interference to radio communications. However, there is no guarantee that interference will not occur in a particular installation. If this equipment does cause harmful interference to radio or television reception, which can be determined by turning the equipment off and on, the user is encouraged to try to correct the interference by one or more of the following measures:

- Reorient or relocate the receiving antenna.
- Increase the separation between the equipment and receiver.
- Connect the equipment into an outlet on a circuit different from that to which the receiver is connected.
- Consult the dealer or an experienced radio/TV technician for help.

If necessary, the user should contact the dealer or an experienced radio/television technician for additional suggestions. The user may find the following booklet, prepared by the Federal Communications Commission, helpful: "How to Identify and Resolve Radio-TV Interference Problems." This booklet is available from the U.S. Government Printing Office, Washington, D.C., 20402, Stock No. 004-000-00345-4.

DECLARATION OF CONFORMITY

This device complies with Part 15 of FCC Rules. Operation is subject to the following two conditions. (1) This device may not cause harmful interference, and (2) this device must accept any interference received, including interference that may cause undesired operation.

U.S. Responsible Party:	NEC Display Solutions of America, Inc.
Address:	3250 Lacey Rd, Ste 500 Downers Grove, IL 60515
Tel. No.:	(630) 467-3000
Type of Product:	Display Monitor
Equipment Classification:	Class B Peripheral
Model:	V554Q IGB



Registration Information

DECLARATION OF CONFORMITY

Windows is a registered trademark of Microsoft Corporation.

NEC is a registered trademark of NEC Corporation.

MultiSync is a trademark or registered trademark of NEC Display Solutions, Ltd. in Japan and other countries.

DisplayPort and DisplayPort Compliance Logo are trademarks owned by Video Electronics Standards Association in the United States and other countries.



All other brands and product names are trademarks or registered trademarks of their respective owners.

The terms HDMI and HDMI High-Definition Multimedia Interface, and the HDMI Logo are trademarks or registered trademarks of HDMI Licensing Administrator, Inc. in the United States and other countries.



Trademark PLink is a trademark applied for trademark rights in Japan, the United States of America and other countries and areas.

microSD and microSD SDHC logos are trademarks of SD-3C, LLC.



CRESTRON and CRESTRON ROOMVIEW are trademarks or registered trademarks of Crestron Electronics, Inc. in the United States and other countries.



Raspberry Pi is a trademark of the Raspberry Pi Foundation.



Adobe and the Adobe logo are either registered trademarks or trademarks of Adobe Systems Incorporated in the United States and/or other countries.

GPL/LGPL Software Licenses

The product includes software licensed under GNU General Public License (GPL), GNU Lesser General Public License (LGPL), and others. For more information on each software, see “readme.pdf” inside the “about GPL&LGPL” folder on the supplied CD-ROM.

Important Information

	WARNING	
<p>TO PREVENT FIRE OR SHOCK HAZARDS, DO NOT EXPOSE THIS UNIT TO RAIN OR MOISTURE. ALSO, DO NOT USE THIS UNIT'S POLARIZED PLUG WITH AN EXTENSION CORD RECEPTACLE OR OTHER OUTLETS UNLESS THE PRONGS CAN BE FULLY INSERTED.</p> <p>REFRAIN FROM OPENING THE CABINET AS THERE ARE HIGH VOLTAGE COMPONENTS INSIDE. REFER SERVICING TO QUALIFIED SERVICE PERSONNEL.</p>		

	CAUTION	
<p>TO REDUCE THE RISK OF ELECTRIC SHOCK, MAKE SURE POWER CORD IS UNPLUGGED FROM WALL SOCKET. TO FULLY DISENGAGE THE POWER TO THE UNIT, PLEASE DISCONNECT THE POWER CORD FROM THE AC OUTLET. DO NOT REMOVE COVER (OR BACK). NO USER SERVICEABLE PARTS INSIDE. REFER SERVICING TO QUALIFIED SERVICE PERSONNEL.</p>		

 This symbol warns user that uninsulated voltage within the unit may have sufficient magnitude to cause electric shock. Therefore, it is dangerous to make any kind of contact with any part inside this unit.

 This symbol alerts the user that important literature concerning the operation and maintenance of this unit has been included. Therefore, it should be read carefully in order to avoid any problems.

 **CAUTION:** Please use the power cord provided with this display in accordance with the table below. If a power cord is not supplied with this equipment, please contact NEC. For all other cases, please use the power cord with the plug style that matches the power socket where the monitor is located. The compatible power cord corresponds to the AC voltage of the power outlet and has been approved by, and complies with, the safety standards in the country of purchase.

This equipment is designed to be used with a power cord that has a protective earth pin connected to earth. If the power cord is not connected to the earth, it may cause electric shock. Please make sure the power cord is earthed properly.

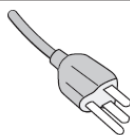
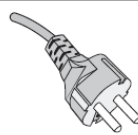
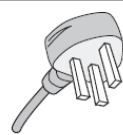
Plug Type	North America		European Continental	U.K.
Plug Shape				
Region	U.S.A./ Canada	Taiwan	EU	U.K.
Voltage	120*	110	230	230

* When operating this monitor with its AC 125-240V power supply, use a power supply cord that matches the power supply voltage of the AC power outlet being used.

NOTE: This product can only be serviced in the country where it was purchased.

Use the power cord which has BSMI mark at both ends when you use this monitor in Taiwan.

- The intended primary use of this product is as an Information Technical Equipment in an office or domestic environment.
- The product is intended to be connected to a computer and is not intended for the display of television broadcast signals.



Safety Precautions, Maintenance & Recommended Use

Safety Precautions and Maintenance

Refer to the instruction explained on page English-3 of the standard user's manual of the monitor.

Cleaning the Glass Surface

- The glass surface should be cleaned regularly with a soft, lint free cloth.
- It is recommended to use an anti-static plastic and glass cleaner suited for PMMA/acrylic glass/Plexiglas,

or water with a small amount of washing-up liquid.

Cleaning the Cabinet

- Unplug the power supply.
- Gently wipe the cabinet with a soft cloth.
- To clean the cabinet, dampen the cloth with a neutral detergent and water, wipe the cabinet and follow with a dry cloth.

NOTE: DO NOT clean with benzene thinner, alkaline detergent, alcoholic system detergent, wax, polish cleaner, soap powder or insecticide. Rubber or vinyl should not be in contact with the cabinet for an extended period of time. These types of fluids and materials can cause paint to deteriorate, crack or peel.

Shipping Content

55" InfinityBoard 2.1

1. FlatFrog InGlass™ Touch Display – V554Q IGB
2. OPS Slot-in PC
 - a. OPS-Kbl-i7v-d8/128/W10Pro/W/TPM/Infinity (55" InfinityBoard 2.1)
 - b. OPS-Kbl-i7v-d16/256/W10Pro/W/TPM/Inf/QL (55" InfinityBoard 2.1 QL)
3. Collaboration Soundbar incl. Huddly IQ Camera - SP-PSCM-55IB-IQ
4. Soundbar Bracket – SP-Bracket 55IB 2.0
5. 2x Passive Magnetic Pen
6. Remote Control
7. CD-ROM (User Guides/Manuals)
8. Addendum to User's Manuals
9. Power Cable
10. DisplayPort Cable
11. 2x USB Cable 300cm
12. USB Cable 10cm
13. Cable Clamps

Unpacking

Unpacking the Display

Unpack the display (V554Q IGB) from the carton box by removing the white clips on the bottom of the box.

NOTE: Due to the weight of the product, for installation and handling 4 people are required. DO NOT start unless you have enough people available. Working with less people may result in injuries and damaged product.

Lift the carton box upwards. Make sure to have one additional person to secure the display from tipping over.

NOTE: Remember to save your original box and packing material to transport or ship the monitor.

For further instructions, please refer to the printed instruction on the carton box.

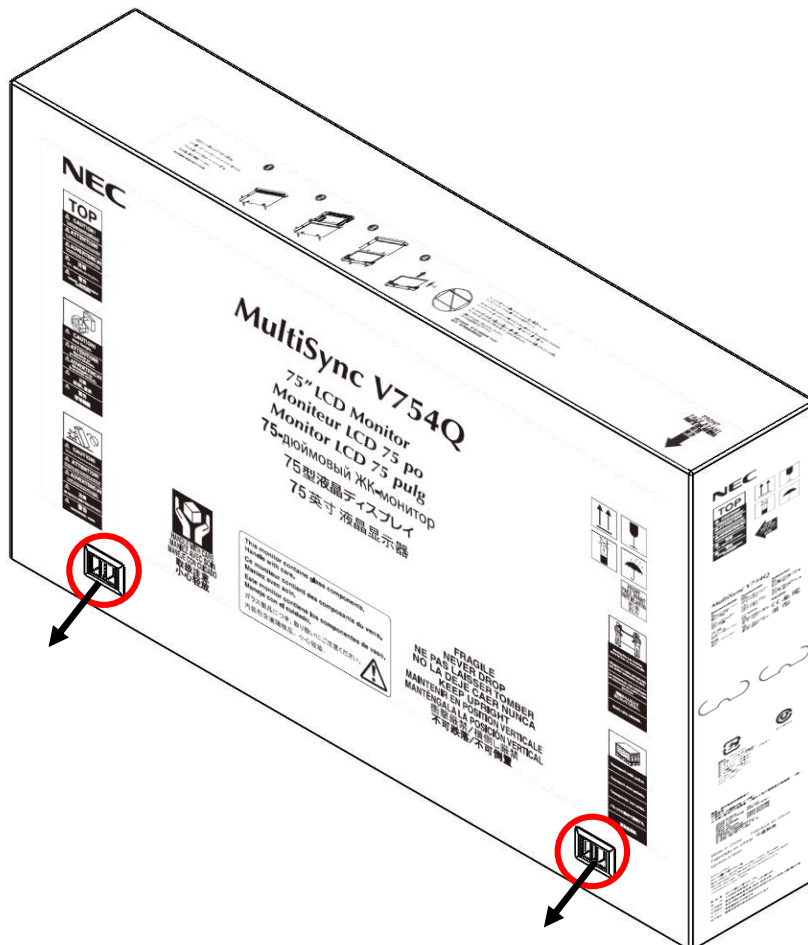

General Installation

This device cannot be used or installed without a mounting accessory for support. For proper installation it is strongly recommended to use a trained, NEC authorized service person. Failure to follow NEC standard mounting procedures could result in damage to the equipment or injury to the user or installer. Product warranty does not cover damage caused by improper installation. Failure to follow these recommendations could result in voiding the warranty

Mounting

For customer:



CAUTION

DO NOT mount the monitor yourself. For proper installation it is strongly recommended to use a trained, qualified technician. Please contact your supplier, as they may be able to provide a list of qualified installation professionals. Mounting on a wall or ceiling and hiring a technician is the customer's responsibility.

Maintenance

- Periodically check for loose screws, gaps, distortions, or other problems that may occur with the mounting equipment. If a problem is detected, please refer to qualified personnel for service.
- Regularly check the mounting location for signs of damage or weakness that may occur over time.

DO NOT block ventilated openings with mounting accessories or other accessories.

For NEC Qualified Personnel:

Stability Hazard.

The device may fall, causing serious personal injury or death. To prevent injury, this device must be securely attached to the floor/wall in accordance with the installation instructions. Carefully inspect the location where the unit is to be mounted. Not all walls or ceilings are capable of supporting the weight of the unit. Weight of this monitor is mentioned in Specification (see 55" InfinityBoard on page 21). Product warranty does not cover damage caused by improper installation, remodeling, or natural disasters. Failure to comply with these recommendations could result in voiding the warranty.

To ensure safe installation, use two or more brackets to mount the unit. Mount the unit to at least two points on the installation location.

NOTE: To achieve optimum performance of touch technology, monitor must be correctly leveled. Only straight upright and titled back position of the monitor is acceptable. Monitor tilted to front will result in convex position of the glass and might negatively influence the touch performance.

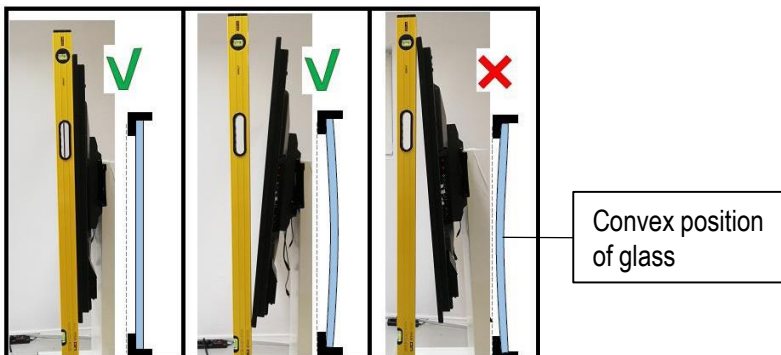

For further instructions, please refer to standard user's manual of the base model monitors V554Q.

InfinityBoard Assembly Instruction

Mounting of Collaboration Soundbar

NOTE: The Soundbar have to be mounted on top of the screen.

1. MOUNTING ON THE SCREEN

PART	QUANTITY	DESCRIPTION
A	1	Display
B	1	Soundbar
C	1	Soundbar Bracket
D	6	M4x 12 Screw
E	6	M4 Washer
F	1	OPS Slot-in PC

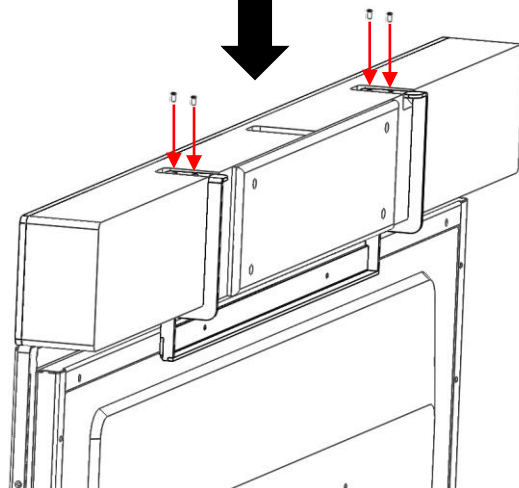
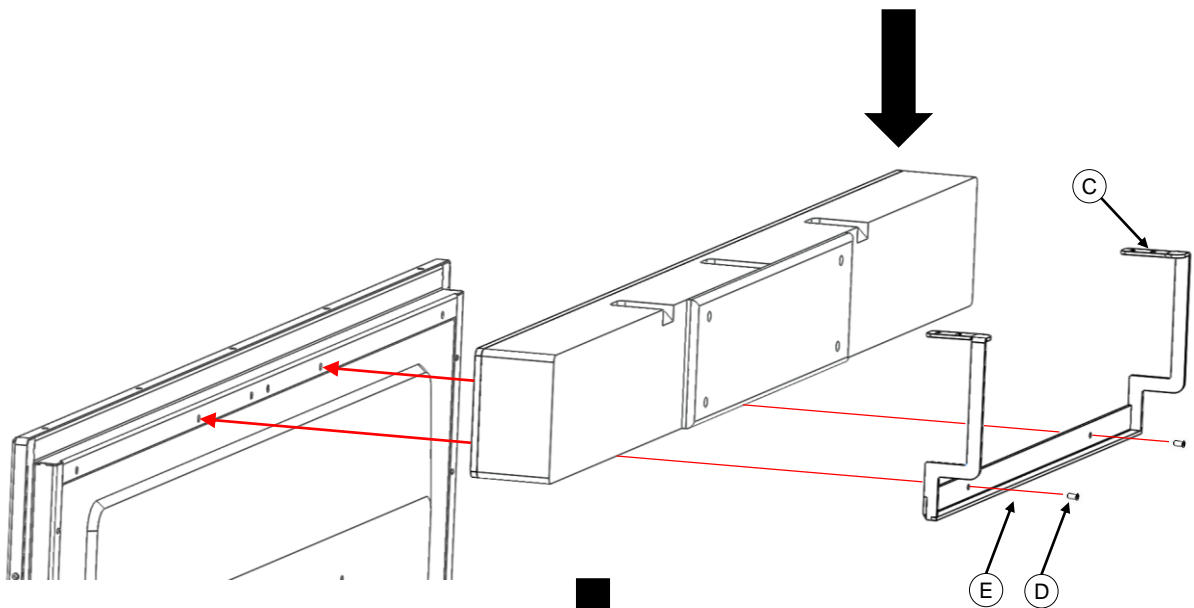
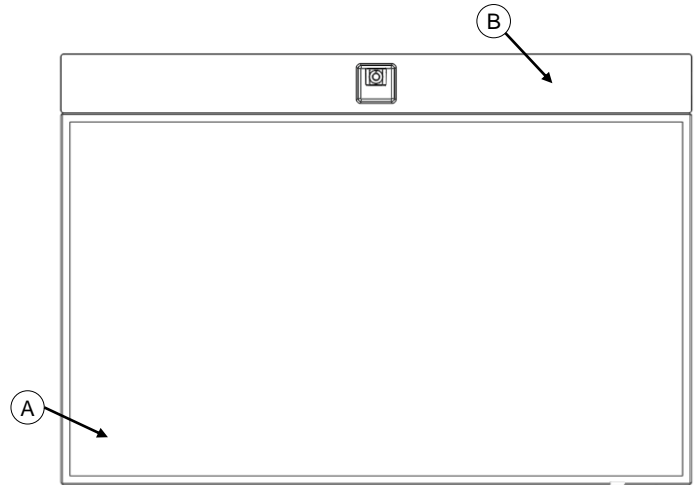

InfinityBoard Assembly Instruction

Installing the OPS Slot-in PC

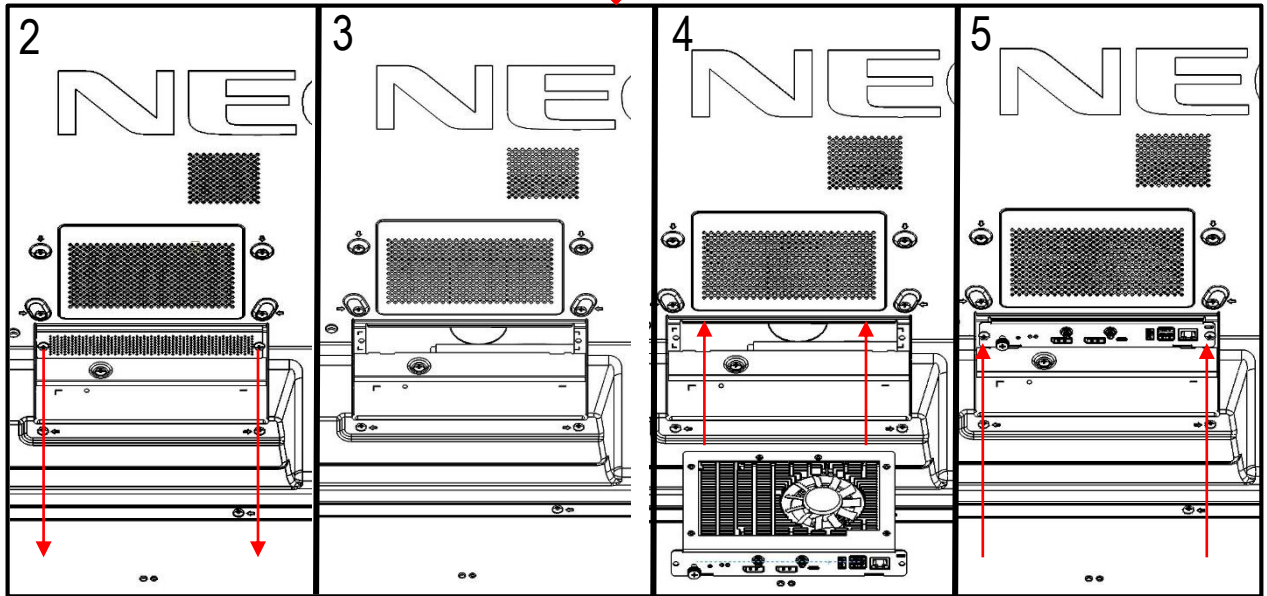
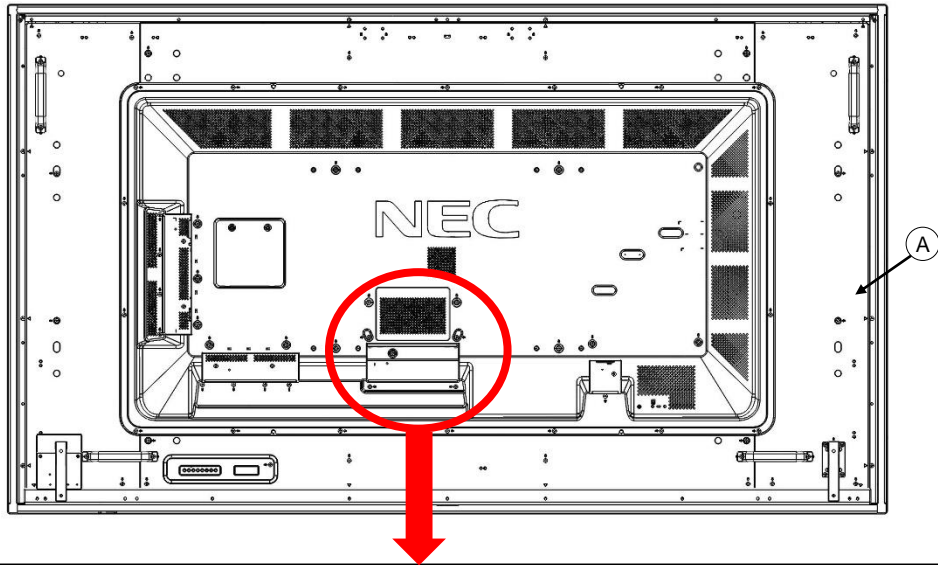

NOTE: Make sure to write down the Windows 10 license code which can be found on the rear-side of the OPS slot-in PC.

Follow the instruction described in picture 2 to 5:

1. Turn off the main power switch on the monitor.
2. Remove the attached slot cover by unscrewing the installed screws (picture 2), sliding to right (picture 3) and moving up (picture 4).
3. Insert the OPS PC into the monitor and fix it with the removed screws (picture 5).

NOTE: Do not apply excessive force to manipulate the OPS PC before fixing it with screws. Make sure that the OPS PC is inserted into the slot in the correct orientation.

⚠ CAUTION: Ensure the OPS PC is attached by the removed screws. Otherwise, the OPS PC may fall out and expose you to danger.
(Recommended Fasten Force: 139 - 189N•cm).

InfinityBoard Assembly Instruction

Connecting Cables

NOTE: Do not connect or disconnect cables when turning on the monitor's main power or other external equipment's power as this may result in a loss of image.

NOTE: Do not use an attenuating (built-in resistor) audio cable. Use an audio cable without a built-in resistor. Using an audio cable with a built-in resistor will lower the sound level.

Before making connections:

- Turn off the device's power before connecting it to the monitor.
- Refer to the device's user manual for available connection types and instructions for the device.
- We recommend turning off the monitor's main power before connecting or disconnecting a USB storage device or a microSD memory card to avoid data corruption.

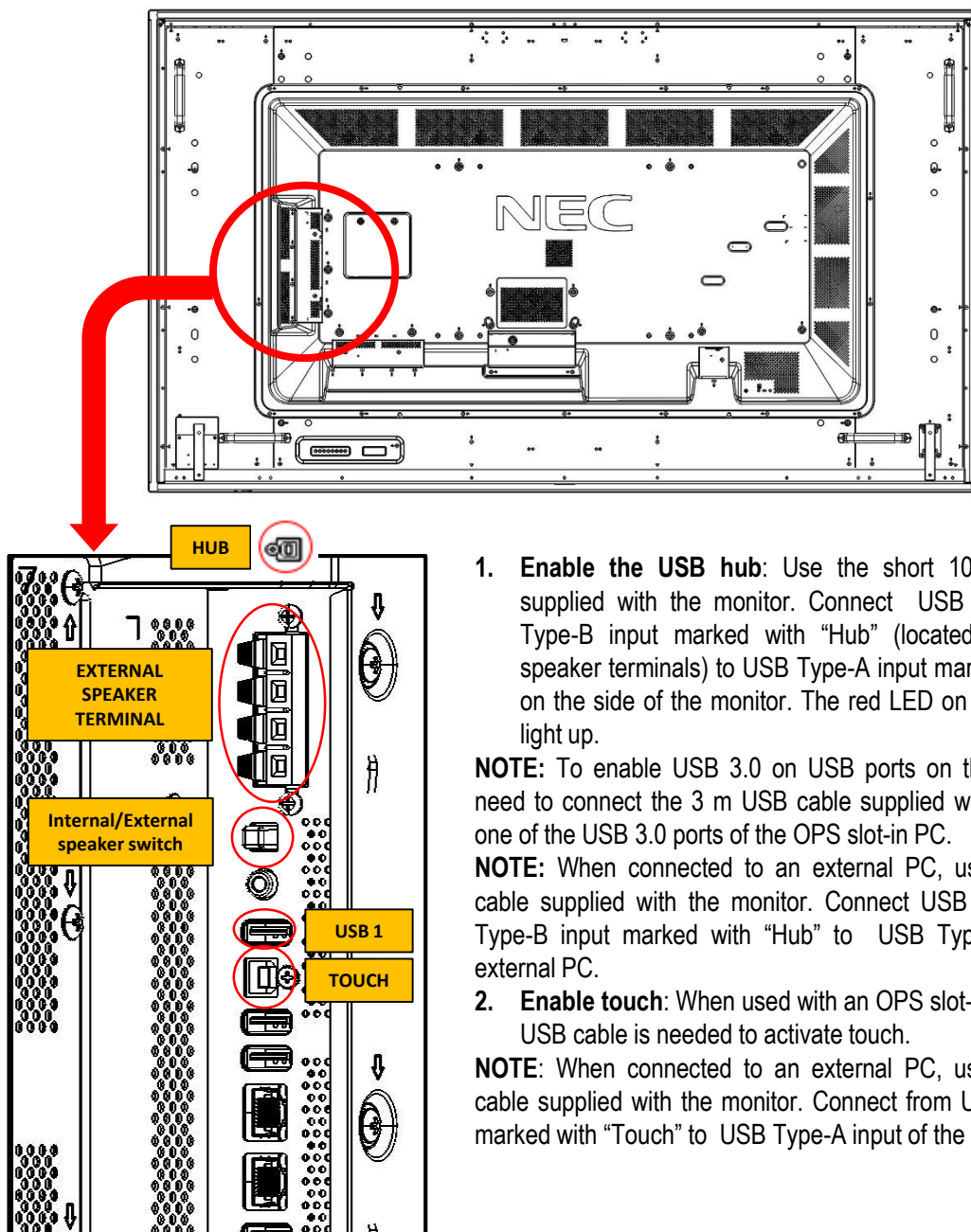

1. **Enable the USB hub:** Use the short 10 cm USB cable supplied with the monitor. Connect USB cable from USB Type-B input marked with "Hub" (located above external speaker terminals) to USB Type-A input marked with "USB 1" on the side of the monitor. The red LED on the USB hub will light up.

NOTE: To enable USB 3.0 on USB ports on the USB hub you need to connect the 3 m USB cable supplied with the monitor to one of the USB 3.0 ports of the OPS slot-in PC.

NOTE: When connected to an external PC, use the 3 m USB cable supplied with the monitor. Connect USB cable from USB Type-B input marked with "Hub" to USB Type-A input of the external PC.

2. **Enable touch:** When used with an OPS slot-in PC no external USB cable is needed to activate touch.

NOTE: When connected to an external PC, use the 3 m USB cable supplied with the monitor. Connect from USB Type-B input marked with "Touch" to USB Type-A input of the external PC.

InfinityBoard Assembly Instruction

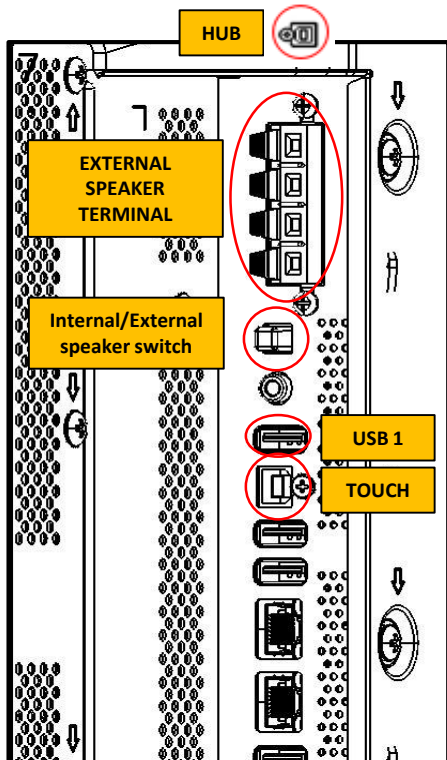

3. **Connect the soundbar speakers:** Connect the audio cables to the speaker terminals on the side of the InfinityBoard. Red terminal is plus (+) and black terminal is minus (-).
4. **Activate the external speakers:** Push the button "Internal/External speaker switch" below the speaker terminals on the monitor to enable the external speakers.
5. **Connect the soundbar microphone:** Connect the USB cable of the soundbar to the of the USB 2.0 Type-A port on the OPS slot-in PC.



Picture of USB hub and soundbar speaker cabling

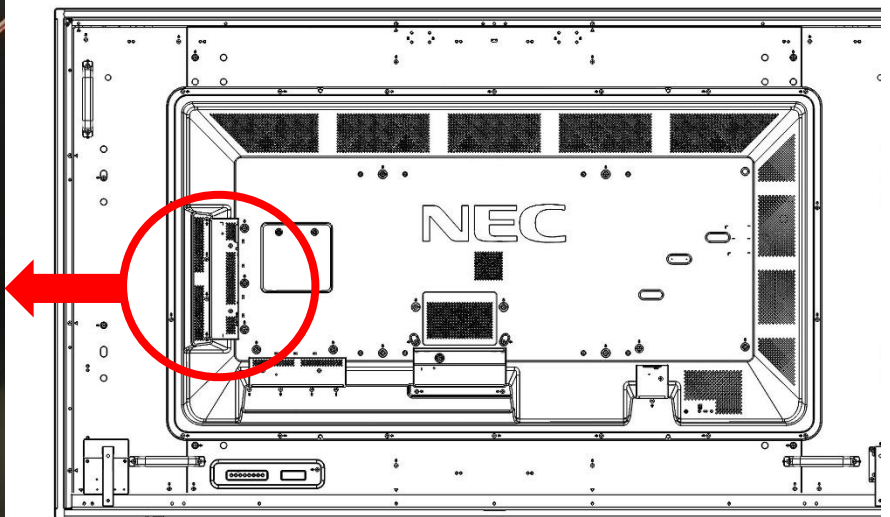

InfinityBoard Assembly Instruction

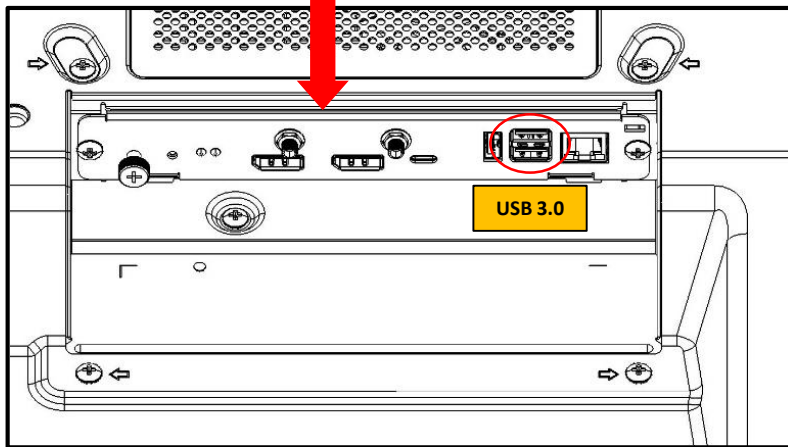
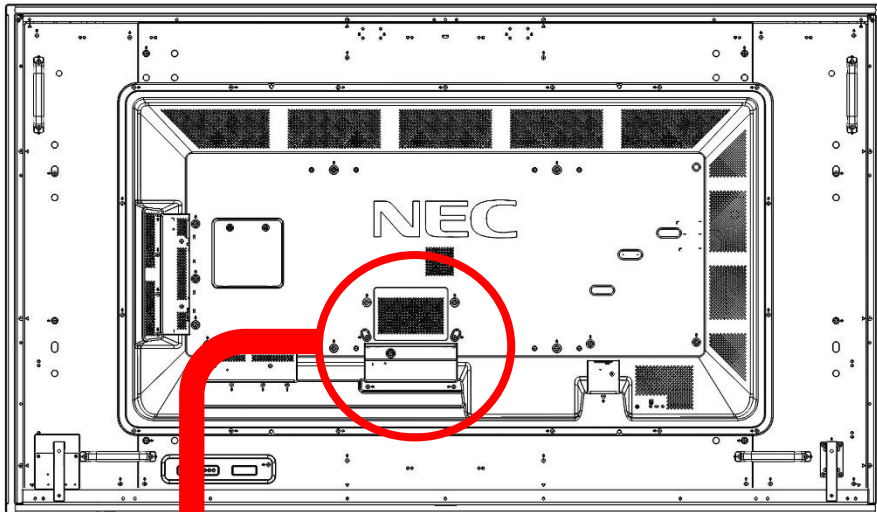

- 6. Connect the Huddly camera:** Connect the 2 m USB cable supplied with the Huddly camera from USB-C of the camera to one of the USB 3.0 ports of the OPS slot-in PC.

NOTE: For use with external PC, NEC can provide Huddly certified USB extension cables to connect the Huddly camera to the external PC.

Setup the OPS Slot-in PC

Installation of Windows 10 Professional

1. Follow the Windows installation process.
2. To activate Windows, please use the Windows 10 license code which can be found on the rear side of the OPS slot-in PC.
3. Once you are ready, you will see the following start screen.

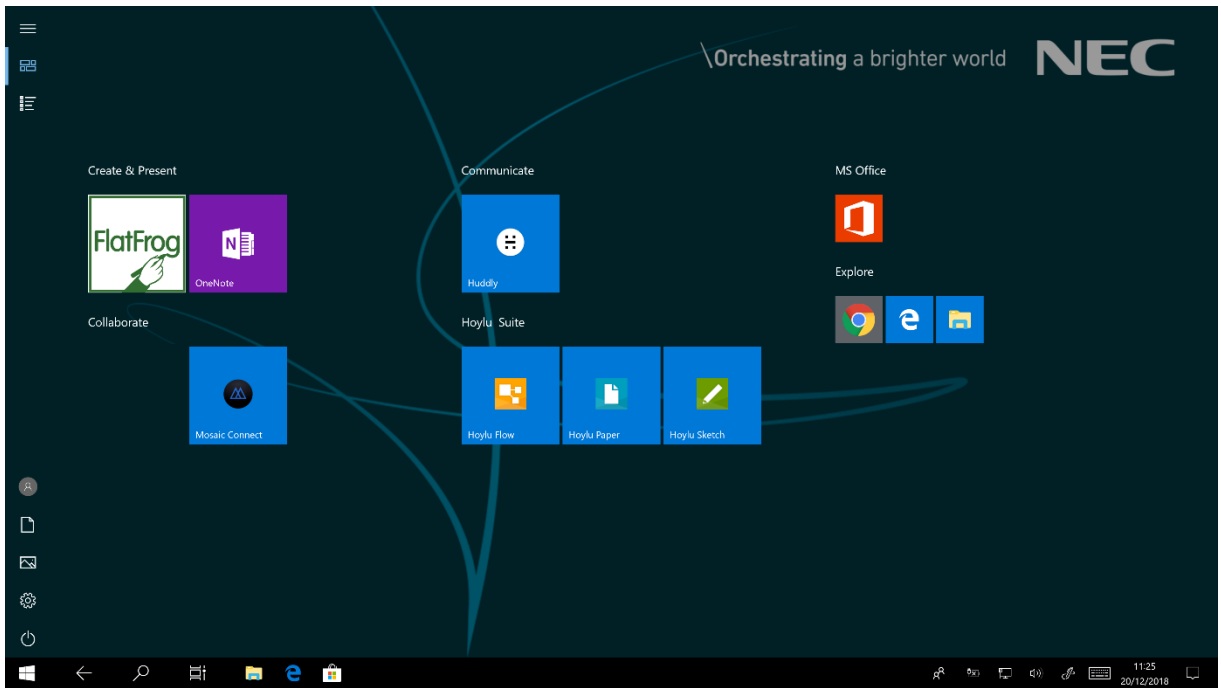

4. Pre-installed applications:
 - FlatFrog Board (single user license)
 - >> For further information please visit: www.flatfrog.com/nec
 - MS OneNote
 - Mosaic Connect
 - Huddly App for camera control
 - Hoylu Suite (single user license)
 - >> For further information please visit: <https://hoylu.com/> or contact hello@hoylu.com

Installation of Quicklaunch Ultimate Edition (InfinityBoard 2.1 QL models only)

1. Double click on the Quicklaunch icon on the OPS desktop
2. This will start the download process of Quicklaunch Ultimate Edition
3. The following video will explain the installation process of Quicklaunch on an NEC InfinityBoard OPS slot-in PC: <https://youtu.be/LBAqRxx9Mws>

Setup the OPS Slot-in PC

Installation of Quicklaunch Ultimate Edition (InfinityBoard 2.1 QL models only)

1. Double click on the Quicklaunch icon on the OPS desktop
2. This will start the download process of Quicklaunch Ultimate Edition
3. The following video will explain the installation process of Quicklaunch on an NEC InfinityBoard OPS slot-in PC: <https://youtu.be/LBAqRrk9Mws>
4. Once you input the license key to the software it will enable the NEC template of Quicklaunch

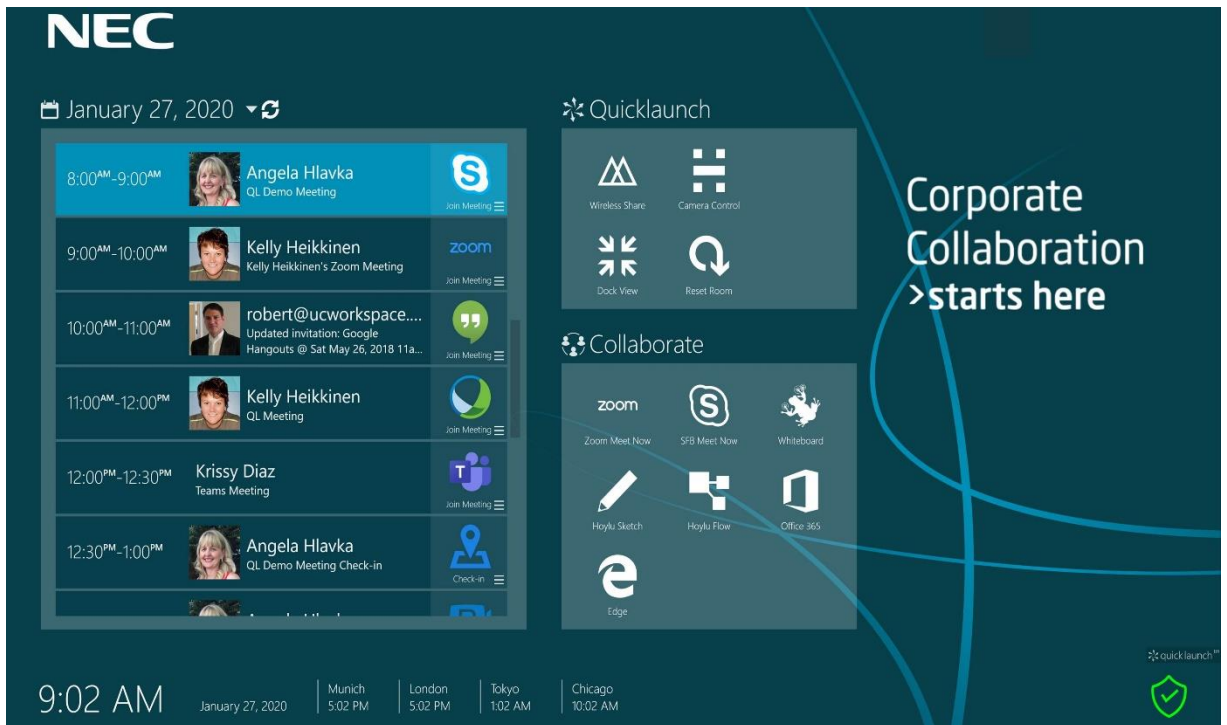

5. Pre-installed applications:
 - FlatFrog Board (single user license)
 - >> For further information please visit: www.flatfrog.com/nec
 - MS OneNote
 - Mosaic Connect
 - Huddly App for camera control
 - Hoylu Suite (single user license)
 - >> For further information please visit: <https://hoylu.com/> or contact hello@hoylu.com

Setup the OPS Slot-in PC

Select the Speakers

1. Open the “Sound” settings in Windows by clicking on the speaker icon in the Windows task bar.

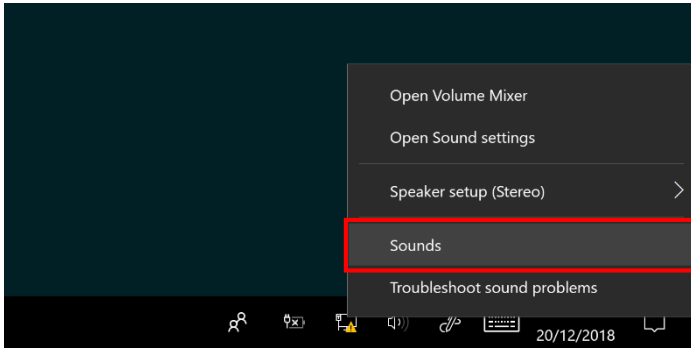

2. Open the “Playback” tab in the “Sound” settings and select the V554Q monitor as “Default Device”. This will enable the side-mounted passive speakers.

NOTE: We recommend to disable all other speaker options.

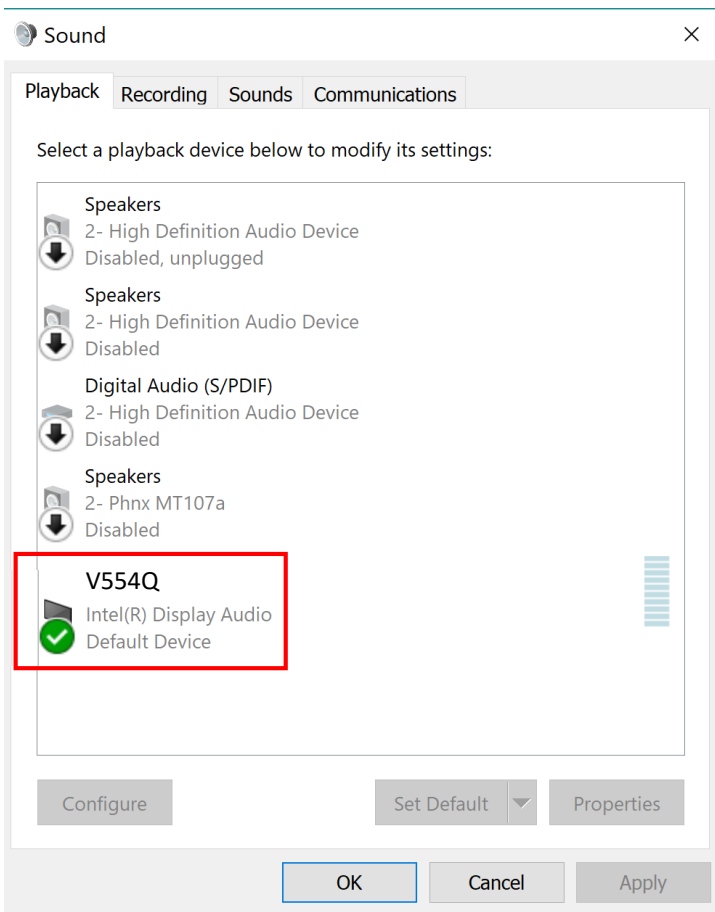

Setup the OPS Slot-in PC

Select a Microphone

1. Open the “Sound” settings in Windows by clicking on the speaker icon in the Windows task bar.
2. Open the “Recording” tab in the “Sound” settings and select “Microphone 2- Phnx MT107a” as “Default Device”. This will enable the side-mounted passive speakers.

NOTE: We recommend to disable all other speaker options.

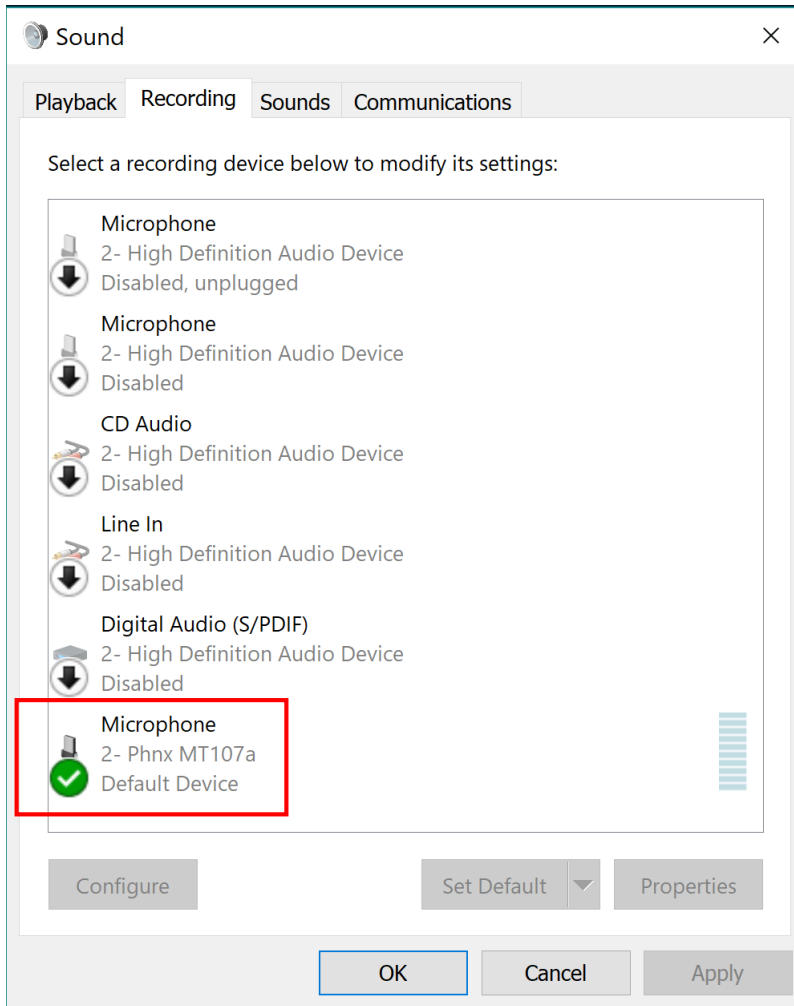

Troubleshooting

1. Slow writing performance

Make sure the OPS PC is running UHD resolution with 60Hz

OSD MENU SETTING:

- ADVANCED OPTION1 » OPTION SETTINGS
- SLOT2 CH SETTING » CH1
- SLOT2 CH SELECT » DPORT

2. Bad sound quality from side-mounted speakers

Make sure the following setting is enabled in the OSD

OSD MENU SETTING:

- ADVANCED OPTION1 » OPTION SETTINGS
- LONG CABLE COMP » AUDIO » DIGITAL

3. OPS slot-in PC doesn't shut down when monitor is set to stand-by mode

Make sure the following setting is enabled in the OSD

OSD MENU SETTING:

- ADVANCED OPTION1 » OPTION SETTINGS
- AUTO OFF » change to ON

4. Monitor doesn't go to stand-by mode after OPS slot-in PC was shutting down

Make sure the following setting is enabled in the OSD

OSD MENU SETTING:

- DISPLAY PROTECTION » POWER SAVE
- AUTO STANDBY » ENABLE and set a time period

5. The touch panel does not respond

- Make sure that PIP (picture in picture), PBP (picture by picture), TILE MATRIX, ROTATE and ZOOM are not selected.
- Check the input signal setting.
- The touch panel function does not support the media player function. Please use the remote control to set the media player while the touch panel function is working.
- Make sure that TOUCH POWER setting in USB in CONTROL is "ON".
- Check the PC SOURCE setting in USB in CONTROL.

Using slot 2 type PC:

Make sure that PC SOURCE is AUTO or OPTION, and the input signal is set to OPTION.

Make sure the slot 2 type PC is connected properly.

Using external computer:

Make sure that PC SOURCE is AUTO or EXTERNAL PC, and the input signal is set to which supplied by the connected computer.

Make sure the USB cable is connected properly.

Troubleshooting

- The touch panel function may not work depending on the specification of an external computer and connecting method.
- If the TOUCH POWER setting in USB in CONTROL is set to “ON”, change it to “OFF” and back to “ON” again after a moment.
- When using touch function at the display edge, there may be a slight gap between touch position on the screen and where you touched. It is the specification and not a failure of product.

6. The USB hub only supports USB 2.0

To enable USB 3.0 on the USB hub you need to connect the 3 m USB cable supplied with the monitor to one of the USB 3.0 ports of the OPS slot-in PC.

Specifications – 55” InfinityBoard 2.1 (QL)

55” InfinityBoard 2.1

Product Information

Product Name	NEC 55" InfinityBoard® 2.1
Product Group	LCD 55" All-in-One Collaboration Solution
Order Code	40001353

55” InfinityBoard 2.1 QL

Product Information

Product Name	NEC 55" InfinityBoard® 2.1 QL
Product Group	LCD 55" All-in-One Collaboration Solution
Order Code	40001442

Display

Panel Technology	IPS with Edge LED backlights
Active Screen Area (W x H) [mm]	1,209.6 x 680.4
Screen Size [inch/cm]	55 / 138.78
Aspect Ratio	16:9
Pixel Pitch [mm]	0.315
Brightness [cd/m²]	500
Contrast Ratio (typ.)	1100:1
Viewing Angle [°]	178 / 178 (at contrast ratio > 10:1)
Colour Depth [bn]	1.073 (10bit)
Response Time (typ.) [ms]	8 (grey-to-grey)
Panel Refresh Rate [Hz]	60
Haze Level [%]	Pro (28)
Supported Orientation	Face Up; Landscape; Portrait

Synchronisation Rate

Horizontal Frequency [kHz]	26 - 135
Vertical Frequency [Hz]	23 - 86

Resolution

Native Resolution	3840 x 2160			
Supported Resolutions	4096 x 2160; 1920 x 2160; 1920 x 1200; 1920 x 1080;	1650 x 1050; 1600 x 1200; 1440 x 900; 1400 x 1050;	1366 x 768; 1360 x 768; 1280 x 1024; 1280 x 720;	1024 x 768

Connectivity

Input Video Digital	1 x OPS Slot; 2 x DisplayPort (with HDCP); 3 x HDMI (with HDCP)
Input Audio Analogue	1 x 3.5 mm jack
Input Audio Digital	2 x DisplayPort; 3 x HDMI
Input Control	LAN 100Mbit; remote control wire (3,5mm jack); RS232
Input Data	1 x microSD (MediaPlayer); 1 x USB 2.0 (Downstream); 1 x USB 2.0 (MediaPlayer); 1 x USB Type-B (Upstream); 2 x USB 2.0 (Compute Module, 1 x 5V/2A powered)
Output Video Digital	1 x DisplayPort (loop through: DisplayPort, OPS slot-in PC)
Output Audio Analogue	1 x 3.5 mm jack
Output Control	1 x LAN 100Mbit

Specifications – 55” InfinityBoard 2.1 (QL)

Open Modular Intelligence

OPS Slot	Slot Technology: Open pluggable specification (NEC / Intel OPS standard)
OPS Max. Current / Power Consumption [A / W]	4.7 / 75
Compute Module Slot	Slot Technology: Compute Module Slot (NEC proprietary standard)

Sensors

Human Sensor	Optional, external, 4-5m range, triggered actions programmable
Temperature Sensor	Integrated, 1 sensors, triggered actions programmable

Electrical

Power Consumption Eco/max. [W]	132 Eco (shipment setting), 182
Power Savings Mode [W]	< 0.5; < 2 (Networked Standby)
Power Management	VESA DPMS

Environmental Conditions

Operating Temperature [°C]	+0 to +40
Operating Humidity [%]	20 to 80
Storage Humidity [%]	10 to 90
Storage Temperature [°C]	-20 to 60

Mechanical

Dimensions (W x H x D) [mm]	1,284.5 x 877.3 x 90.6
Weight [kg]	46.82
Bezel Width [mm]	18.4 (bottom); 18.4 (left, right and top)
VESA Mounting [mm]	300 x 300 (FDMI); 4 holes; M6
Ingress Protection	IP5x (front); IP2x (back)
Packaging Dimensions (W x H x D) [mm]	Box (TBD): (TBD) x (TBD) x (TBD); Box 1: 1,430 x 250 x 920
Packaging Weight [kg]	Box 1: 48.3; Box 2: 9.8

Glass

Thickness [mm]	3
Type	Premium toughened glass, anti-glare coating
Light Transmission [%]	88 (+/- 1%)

Touch

Touch Technology	InGlass™ Touch
Number of Touches	Real multi-touch up to 20 touches
Response Time [ms]	≤ 15
Touch Method	Finger; Gloves; Stylus (≥ 2 mm)
Supported Operating System	Native Multi-Touch: Windows 7, Windows 8, Windows 10, Linux, Android; Default Mouse: Windows XP, Windows Vista, Mac OS X
Data Interface	USB-HID
Accuracy [mm]	< 1

Specifications – 55” InfinityBoard 2.1 (QL)

MediaPlayer

Supported Image Formats	JPG (baseline, progressive, RGB, CMYK); max. resolution 5000 x 5000; PNG (interlace, alpha channel); max. resolution 4000 x 4000
Supported Video Formats	MP4 / MOV / FLV (video H.264, audio MP3, AAC); max. resolution 1080p at 30 Hz, 1080i at 60 Hz; MPG (video mpeg1/2, audio mpeg audio layer2/3, AAC-LC); MP @ ML, MP @ HL; WMV (video H.264, wmv advanced L3, wmv simple / main, audio mp3 wmv std); max. resolution 1080p at 30 Hz, 1080i at 60 Hz
Supported Audio Formats	MP3 (MP3); max. bit-rate 320 kBit/s; WAV (LPCM); max. 48 kHz sampling
Supported File Storage / File System	MicroSDHC / FAT16, FAT32; USB 2.0 / FAT16, FAT32

Video Conference Camera

Camera Model	Huddly IQ
Viewing Angle [°]	150 diagonal / 120 horizontal / 90 vertical
Resolution	Output HD 1080p 30fps
Aspect Ratio	16:9
Optical Capabilities	Digital Pan / Tilt / Zoom with 3x lossless digital zoom
Driver	Plug&Play, driverless install
Connectivity	SuperSpeed USB
Software Specification	3DNR sensor-model-based visual noise reduction; Flicker elimination; Genius Framing; High-quality video scaling and dewarping; Huddly InSights analytics API; Optical aberration correction; Robust automatic white balance; Spatio-temporal noise filtering

Conference Speakers

Input (max.) [W]	40; 8
Frequency Response Rate [Hz-kHz]	70 to 15
Sound Pressure Level [dB]	82.1 (2.83 V)

Microphone/Echo-Cancelling

Frequency [kHz]	32, sampling frequency
Bandwidth [Hz - kHz]	100 to 16
Echo Cancelling	2 levels of echo cancelling, aggressiveness and 3 levels of echo cancelling speed
Controllable Tail Length [mms]	up to 220
Noise Suppression	Residual noise suppressed to environment noise level to prevent pumping noise
Pre-set Colour Filters	8 pre-set colour filters for both the output and the speaker signal
Delay [msec]	10
Mic Level [mV]	280 peak-to-peak
Line Level [V]	2/4 peak-to-peak
Boost [dB]	6

OPS Slot-In PC

55” InfinityBoard 2.1

CPU	Intel® i7 4 x 3 GHz base frequency (up to 3.7 GHz turbo mode)
Graphics	630 integrated Gen9-LP graphics controller
SSD	up to 2 M.2 SSD (SATA), 128 GB
RAM	8 GB (DDR4), dual channel mode
Operating System	Microsoft Windows 10 Professional
Interfaces Frontside	1 x Micro Sim Card; 1 x USB 2.0; 1 x USB 3.1 Gen1 Type C; 2 x Antenna for WiFi; 2 x DisplayPort 1.2 ++; 2 x USB 3.0; RJ45 10 / 100 / 1000 Mbps

Specifications – 55” InfinityBoard 2.1 (QL)

Interfaces Frontside	1 x Micro Sim Card; 1 x USB 2.0; 1 x USB 3.1 Gen1 Type C; 2 x Antenna for WiFi; 2 x DisplayPort 1.2 ++; 2 x USB 3.0; RJ45 10 / 100 / 1000 Mbps
Interfaces Backside	Internal HDMI 1.4 or DisplayPort 1.2; Internal OPS interface to OPS slot-in PC (JAE 80-pin connector)
Wi-Fi	Intel Dual Band Wireless-AC 8260 802.11ac, dual band; Wi-Fi and bluetooth 4.2 adapter
Security	TPM (Trusted Platform Module)
EDID/DDC Support	Internal OPS Interface DisplayPort up to 4096 x 2160 at 60 Hz

OPS Slot-In PC

55” InfinityBoard 2.1 QL

CPU	Intel® i7 4 x 3 GHz base frequency (up to 3.7 GHz turbo mode)
Graphics	630 integrated Gen9-LP graphics controller
SSD	up to 2 M.2 SSD (SATA), 256 GB
RAM	16 GB (DDR4), dual channel mode
Operating System	Microsoft Windows 10 Professional
Interfaces Frontside	1 x Micro Sim Card; 1 x USB 2.0; 1 x USB 3.1 Gen1 Type C; 2 x Antenna for WiFi; 2 x DisplayPort 1.2 ++; 2 x USB 3.0; RJ45 10 / 100 / 1000 Mbps
Interfaces Backside	Internal HDMI 1.4 or DisplayPort 1.2; Internal OPS interface to OPS slot-in PC (JAE 80-pin connector)
Wi-Fi	Intel Dual Band Wireless-AC 8260 802.11ac, dual band; Wi-Fi and bluetooth 4.2 adapter
Security	TPM (Trusted Platform Module)
EDID/DDC Support	Internal OPS Interface DisplayPort up to 4096 x 2160 at 60 Hz

Available Options

Accessories	Trolley (PD03 Tipster, PDMHM-L); Wall mount (PDW S 32-55 L, BalanceBox400-2)
Compute Module Slot	NEC Compute Module; Raspberry Pi Compute Module 1 and 3
OPS Slot	HDBaseT receiver; Intel® Atom, Celeron and Core CPUs; OPS-2C Quad 3G SDI

Green Features

Energy Efficiency	ECOMode; Energy efficiency class: B; Human Sensor; LED backlight
-------------------	--

Additional Features

Special Characteristics	12-bit Look Up table; AMX NetLinX Support; Auto ID assignment; Auto tiling function; Automated Email Alert; CEC Support; Cisco Webex Kit compatible; Crestron Connected Support; Crestron RoomView Support; DICOM Simulation; Emergency Notification; HDMI with UHD at 60 Hz; HDR Gamma Support (PQ, HLG); Intelligent Wireless Data (based on NFC); KeyGuide; NaViSet Administrator 2; OSD rotation for portrait mode; PjLink Support; Powered USB-Port; Scheduler; Screen saver functions; SNMP Support; TileMatrix (10 x 10); USB Media Player
Safety and Ergonomics	CE; EAC; EMC Class B; FCC; RCM; REACH; RoHS; UL/C-UL
Pixel Failure Class	ISO 9241-307, Class 1
Audio	Integrated Speakers (10 W + 10 W)
Shipping Content	1x 10 cm USB Cable; 2 x Stylus; 2x 300 cm USB Cable; Cable Clamps; Collaboration Soundbar; Display; DisplayPort Cable; HDMI Cable; OPS Slot-in PC; Power Cable; Remote Control; User Manual
Operating Hours	24/7

NOTE: Technical specifications are subject to change without notice.

Manufacturer's Recycling and Energy Information

NEC DISPLAY SOLUTIONS is strongly committed to environmental protection and sees recycling as one of the company's top priorities in trying to minimize the burden placed on the environment. We are engaged in developing environmentally-friendly products, and always strive to help define and comply with the latest independent standards from agencies such as ISO (International Organisation for Standardization) and TCO (Swedish Trades Union).

Disposing of your old NEC product

The aim of recycling is to gain an environmental benefit by means of re-use, upgrading, reconditioning or reclamation of material. Dedicated recycling sites ensure that environmentally harmful components are properly handled and securely disposed. To ensure the best recycling of our products, **NEC DISPLAY SOLUTIONS offers a variety of recycling procedures** and gives advice on how to handle the product in an environmentally sensitive way, once it has reached the end of its life.

All required information concerning the disposal of the product and country-specific information on recycling facilities can be found on our following websites:

<https://www.nec-display-solutions.com/p/greenvision/en/greenvision.xhtml> (in Europe),

<https://www.nec-display.com> (in Japan) or

<https://www.necdisplay.com> (in USA).

Energy Saving

This monitor features an advanced energy saving capability. When a Display Power Management signal is sent to the monitor, the Energy Saving mode is activated. The monitor enters a single Energy Saving mode.

For additional information visit:

<https://www.necdisplay.com/> (in USA)

<https://www.nec-display-solutions.com/> (in Europe)

<https://www.nec-display.com/global/index.html> (Global)

For ErP requirement/For ErP (Network standby) requirement:

Except for the conditions below:

The monitor is using an Option Board.

INPUT DETECT is set to a setting except for NONE.

USB POWER is set to ON. DisplayPort in the TERMINAL SETTINGS is set to MST.

Power consumption (Glowing amber): 2.0 W or less (with 1 port connection)/3.0 W or less (with all ports connection). Time for power management function: 10 sec. (Default setting)

Power consumption (Blinking amber): 0.5 W or less.

Time for power management function: 3 min. (Default setting) (Except for a condition that the monitor has plural signal inputs.)

Manufacturer's Recycling and Energy Information

WEEE Mark (European Directive 2012/19/EU and amendments)

Disposing of your used product: In the European Union



EU-wide legislation as implemented in each Member State requires that used electrical and electronic products carrying the mark (left) must be disposed of separately from normal household waste. This includes monitors and electrical accessories, such as signal cables or power cords. When you dispose of such products, please follow the guidance of your local authority or ask the shop where you purchased the product, or if applicable, follow applicable legislation or agreement you may have. The mark on electrical and electronic products may only apply to the current European Union Member States.

Outside the European Union

If you wish to dispose of used electrical and electronic products outside the European Union, please contact your local authority and ask for the correct method of disposal.



For EU: The crossed-out wheeled bin implies that used batteries should not be put to the general household waste! There is a separate collection system for used batteries, to allow proper treatment and recycling in accordance with legislation.

According to EU directive 2006/66/EC and amendments, the battery can't be disposed improperly. The battery shall be separated to collect by local service.