

User's Manual

Large Format Display

MultiSync UN552

MultiSync UN552V

MODEL: UN552, UN552V

The model name and serial number can be found in the rating label on the rear side of monitor.

Table of Contents

Registration Information	1	Safety Precautions and Maintenance	3
Important Information	2	Recommended Use	3
Safety Precautions, Maintenance & Recommended Use	3	Cleaning the LCD Panel	4
		Cleaning the Cabinet	4

Features

Chapter 1 Installation

Setup Overview	7	Attaching Mounting Accessories	13
Mounting	9	Using a Wall Mount Adapter	13
Mounting location	11	Installing and Removing the Optional Table Top Stand	14
Orientation	11	Installing an Option Board	15
Ventilation Requirements	12	Installing an Optional Sensor Unit	16

Chapter 2 Parts Name and Functions

Control Panel	18	Wireless Remote Control (Optional)	21
Terminal Panel	19		

Chapter 3 Connections

Wiring Diagram	24	Internal Video Sources	27
Connections	24	Media Player	28
External Video Connections	25	Option Boards for the Monitor	29
Connecting to a Personal Computer	25	Connecting a USB Device	30
Connecting to a Media Device with HDMI	26		

Chapter 4 Basic Operation

Power ON and OFF Modes	32	OSD (On-Screen-Display) Controls.....	37
Operating Range for the Optional Remote Control...	33	Using the Media Player.....	39
Using Power Management	33	File Display Screen.....	40
Showing the Information OSD	34	Playing Files	41
Switching Between Picture Modes	34	Configuring the Slideshow Settings.....	42
Setting the Aspect Ratio	35	Enabling Auto Play	43
Using Point Zoom	36	Displayable/Playable Files	44

Chapter 5 Advanced Operation

Creating a Power Schedule	46	Setting Security and Locking the Monitor Controls...	58
Advanced Color Adjustment	47	Password Security	58
Using the SpectraView Engine	47	Locking the Button Controls	59
Using Stand-alone calibration.....	50	Media Player Settings.....	62
Using Other Picture Modes	53	Network & Other Settings	63
Multi-Picture Mode.....	54	Copying Files to the microSD memory card	64
PIP (Picture-In-Picture) matrix.....	56	Using Emergency Contents.....	68

Chapter 6 Multi-Monitor Setup

Connecting Multiple Monitors	70	Setting the Remote Control ID Function.....	73
Video Out Connection	72		

Chapter 7 External Control

Connecting Interfaces.....	76	Network Setting by Using an HTTP Browser.....	82
Commands	76	OSD Menu Settings in the Monitor Web controls	83
Supporting HDMI CEC Command.....	78	Network Settings	84
Controlling the Monitor via RS-232C	79	Intelligent Wireless Data	88
Controlling the Monitor via LAN.....	80	Proof of Play	89
Multiple Monitors Connection	81		

Chapter 8 Troubleshooting

Screen Image and Video Signal Issues.....	91	Image Persistence	94
Hardware Issues.....	92		

Chapter 9 Specifications

UN552	96	UN552V	97
-------------	----	--------------	----

Appendix A External Resources

Appendix B OSD Controls List

INPUT	101	MULTI-DISPLAY	112
PICTURE	101	DISPLAY PROTECTION	116
AUDIO	106	CONTROL	117
SCHEDULE	106	OPTION	122
MULTI-INPUT	108	SYSTEM	122
OSD	111	COMPUTE MODULE	123

Appendix C Manufacturer's Recycling and Energy Information

Disposing of your old NEC product	125	Energy Saving	125
---	-----	---------------------	-----

Registration Information

Cable Information

CAUTION: Use the provided specified cables with this product so as not to interfere with radio and television reception.
For DVI, USB and mini D-Sub 15-pin, please use a shielded signal cable with ferrite core.
For HDMI, DisplayPort and D-Sub 9-pin, please use a shielded signal cable.
Use of other cables and adapters may cause interference with radio and television reception.

FCC Information

⚠ WARNING: The Federal Communications Commission does not allow any modifications or changes to the unit EXCEPT those specified by NEC Display Solutions of America, Inc. in this manual. Failure to comply with this government regulation could void your right to operate this equipment.

This equipment has been tested and found to comply with the limits for a class A digital device, pursuant to Part 15 of the FCC Rules. These limits are designed to provide reasonable protection against harmful interference when the equipment is operated in a commercial environment. This equipment generates, uses, and can radiate radio frequency energy and, if not installed and used in accordance with the instruction manual, may cause harmful interference to radio communications. Operation of this equipment in a residential area is likely to cause harmful interference in which case the user will be required to correct the interference at his own expense.

If necessary, the user should contact the dealer or an experienced radio/television technician for additional suggestions.
The user may find the following booklet, prepared by the Federal Communications Commission, helpful: "How to Identify and Resolve Radio-TV Interference Problems." This booklet is available from the U.S. Government Printing Office, Washington, D.C., 20402, Stock No. 004-000-00345-4.

SUPPLIER'S DECLARATION OF CONFORMITY

This device complies with Part 15 of FCC Rules. Operation is subject to the following two conditions. (1) This device may not cause harmful interference, and (2) this device must accept any interference received, including interference that may cause undesired operation.

U.S. Responsible Party: NEC Display Solutions of America, Inc.
Address: 3250 Lacey Rd, Ste 500
Downers Grove, IL 60515
Tel. No.: (630) 467-3000
Type of Product: Display Monitor
Equipment Classification: Class A Peripheral
Model: UN552
UN552V



Windows is a registered trademark of Microsoft Corporation.

NEC is a registered trademark of NEC Corporation.

DisplayPort and DisplayPort Compliance Logo are trademarks owned by Video Electronics Standards Association in the United States and other countries.

MultiSync is a trademark or registered trademark of NEC Display Solutions, Ltd. in Japan and other countries.

All other brands and product names are trademarks or registered trademarks of their respective owners.

The terms HDMI and HDMI High-Definition Multimedia Interface, and the HDMI Logo are trademarks or registered trademarks of HDMI Licensing Administrator, Inc. in the United States and other countries.

Trademark PLink is a trademark applied for trademark rights in Japan, the United States of America and other countries and areas.

microSD and microSD SDHC logos are trademarks of SD-3C, LLC.

CRESTRON and CRESTRON ROOMVIEW are trademarks or registered trademarks of Crestron Electronics, Inc. in the United States and other countries.

Adobe and the Adobe logo are either registered trademarks or trademarks of Adobe Systems Incorporated in the United States and/or other countries.

Raspberry Pi is a trademark of the Raspberry Pi Foundation.

GPL/LGPL Software Licenses

The product includes software licensed under GNU General Public License (GPL), GNU Lesser General Public License (LGPL), and others. For more information on each software, see "readme.pdf" inside the "about GPL&LGPL" folder on the NEC website.



- NOTE:**
- (1) The contents of this user's manual may not be reprinted in part or whole without permission.
 - (2) The contents of this user's manual are subject to change without notice.
 - (3) Great care has been taken in the preparation of this user's manual; however, should you notice any questionable points, errors or omissions, please contact us.
 - (4) Notwithstanding article (3), NEC will not be responsible for any claims on loss of profit or other matters deemed to result from using this device.



Important Information

	WARNING	
<p>TO PREVENT FIRE OR SHOCK HAZARDS, DO NOT EXPOSE THIS UNIT TO RAIN OR MOISTURE. ALSO, DO NOT USE THIS UNIT'S POLARIZED PLUG WITH AN EXTENSION CORD RECEPTACLE OR OTHER OUTLETS UNLESS THE PRONGS CAN BE FULLY INSERTED.</p> <p>REFRAIN FROM OPENING THE CABINET AS THERE ARE HIGH VOLTAGE COMPONENTS INSIDE. REFER SERVICING TO QUALIFIED SERVICE PERSONNEL.</p>		

	CAUTION	
<p>TO REDUCE THE RISK OF ELECTRIC SHOCK, MAKE SURE POWER CORD IS UNPLUGGED FROM WALL SOCKET. TO FULLY DISENGAGE THE POWER TO THE UNIT, PLEASE DISCONNECT THE POWER CORD FROM THE AC OUTLET. DO NOT REMOVE COVER (OR BACK). NO USER SERVICEABLE PARTS INSIDE. REFER SERVICING TO QUALIFIED SERVICE PERSONNEL.</p>		

-  This symbol warns user that uninsulated voltage within the unit may have sufficient magnitude to cause electric shock. Therefore, it is dangerous to make any kind of contact with any part inside this unit.
-  This symbol alerts the user that important literature concerning the operation and maintenance of this unit has been included. Therefore, it should be read carefully in order to avoid any problems.

CAUTION: Please use the power cord provided with this monitor in accordance with the table below. If a power cord is not supplied with this equipment, please contact NEC. For all other cases, please use the power cord with the plug style that matches the power socket where the monitor is located. The compatible power cord corresponds to the AC voltage of the power outlet and has been approved by, and complies with, the safety standards in the country of purchase.

This equipment is designed to be used with a power cord that has a protective earth pin connected to earth. If the power cord is not connected to the earth, it may cause electric shock. Please make sure the power cord is earthed properly.

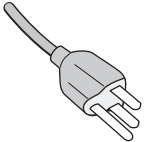
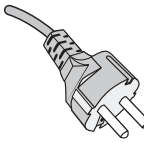
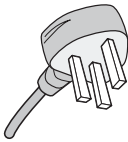
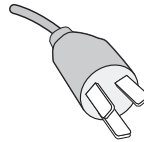
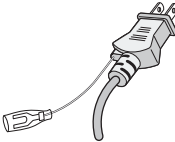
Plug Type	North America		European Continental	U.K.	Chinese	Japanese
Plug Shape						
Region	U.S.A./ Canada	Taiwan	EU	U.K.	China	Japan
Voltage	120*	110	230	230	220	100

* When operating the MultiSync monitor with its AC 125-240 V power supply, use a power supply cord that matches the power supply voltage of the AC power outlet being used.

NOTE: This product can only be serviced in the country where it was purchased.
Use the power cord which has BSMI mark at both ends when you use this monitor in Taiwan.

- The intended primary use of this product is as an Information Technical Equipment in an office or domestic environment.
- The product is intended to be connected to a computer and is not intended for the display of television broadcast signals.

WARNING

This equipment is compliant with Class A of CISPR 32. In a residential environment this equipment may cause radio interference.



Safety Precautions, Maintenance & Recommended Use

Safety Precautions and Maintenance

FOR OPTIMUM PERFORMANCE, PLEASE NOTE THE FOLLOWING WHEN SETTING UP AND USING THE MULTI-FUNCTION MONITOR:

- DO NOT OPEN THE MONITOR. There are no user serviceable parts inside and opening or removing covers may expose you to dangerous shock hazards or other risks. Refer all servicing to qualified service personnel.
- Do not bend, crimp or otherwise damage the power cord.
- Do not place any heavy objects on the power cord. Damage to the cord may cause shock or fire.
- Fasten the power cord to the monitor by attaching the screw and clamp to prevent loose connection. (Recommended Fasten Force: 139 - 189 N•cm).
- Please make sure that enough power is supplied to the monitor. Please refer to the "Power Supply" in the specifications.
- The power supply cord you use must have been approved by and comply with the safety standards of your country. (e.g. Type H05VV-F 3G 1 mm² should be used in Europe).
- In the UK use a BS-approved power cord with a molded plug having a black (5 A) fuse installed for use with this monitor.
- The power cord connector is the primary means of detaching the system from the power supply. The monitor should be installed close to a power outlet that is easily accessible.
- Do not spill any liquids into the cabinet or use your monitor near water.
- Do not insert objects of any kind into the cabinet slots, as they may touch dangerous voltage points, which can be harmful or fatal, or may cause electric shock, fire or equipment failure.
- Do not place this product on a sloping or unstable cart, stand or table, as the monitor may fall, causing serious damage to the monitor.
- Do not mount this product face up, face down, or upside down for an extended period of time as it may cause permanent damage to the screen.
- Do not use the monitor outdoors.
- If glass is broken, handle with care.
- This monitor is equipped with temperature control fans. For reliable performance and long life use of this product, it is required that the vents on the monitor are not covered.
- If the monitor or glass is broken, do not come in contact with the liquid crystal and handle with care.
- Allow adequate ventilation around the monitor, so that heat can properly dissipate.
- Do not block ventilated openings or place the monitor near a radiator or other heat source.
- Do not put anything on top of the monitor.
- Handle with care when transporting. Save packaging for transporting.
- When running the cooling fan continuously, we recommend wiping clean the ventilation holes a minimum of once a month.
- To ensure the monitor's reliability, please clean the ventilation holes at the rear side of the cabinet at least once a year to remove dirt and dust.
- When using a LAN cable, do not connect to a peripheral device with wiring that might have excessive voltage.
- Do not use the monitor in high temperature, humid, dusty, or oily areas.
- Do not use the monitor under rapid changes in temperature and humidity, and avoid cold air directly from an air-conditioning vent. These conditions may shorten the life of the monitor or cause condensation. If water condensation has occurred, unplug the monitor and do not use the monitor until the condensation has evaporated.

Connecting to a TV*¹

- Cable distribution system should be grounded (earthed) in accordance with ANSI/NFPA 70, the National Electrical Code (NEC), in particular Section 820.93, Grounding of Outer Conductive Shield of a Coaxial Cable.
- The screen of the coaxial cable is intended to be connected to earth in the building installation.

Under the following conditions immediately disconnect your monitor from the wall outlet and refer servicing to qualified service personnel:

- If the power supply cord or plug is damaged.
- If liquid has spilled or objects have fallen into the monitor.
- If the monitor has been exposed to rain or water.
- If the monitor has been dropped or the cabinet has been damaged.
- If you notice any structural damage such as cracks or unnatural wobbling.
- If the monitor does not operate normally by following operating instructions.

*¹: The product you purchased may not have this feature.

Recommended Use

Ergonomics

To realize the maximum ergonomic benefits, we recommend the following:

- For optimum performance of the monitor, allow 20 minutes for warming up. Avoid reproduction of still patterns on the monitor for long periods of time to avoid image persistence (after image effects).
- Rest your eyes periodically by focusing on an object at least 5 feet away. Blink often.
- Position the monitor at a 90° angle to windows and other light sources to minimize glare and reflections.

- Adjust the monitor's brightness, contrast and sharpness controls to enhance readability.
- Get regular eye checkups.
- Use the preset Size and Position controls with standard input signals.
- Use the preset color settings.
- Use non-interlaced signals.
- Do not view the primary color blue on a dark background. It is difficult to see and may cause eye fatigue due to insufficient contrast.
- Suitable for entertainment purposes at controlled luminous environments to avoid disturbing reflections from the screen.

Cleaning the LCD Panel

- When the LCD panel is dusty, please gently wipe with a soft cloth.
- Clean the LCD panel surface with a lint-free, non-abrasive cloth. Avoid using any cleaning solution or glass cleaner!
- Please do not rub the LCD panel with a hard or abrasive material.
- Please do not apply pressure to the LCD panel surface.
- Please do not use OA cleaner as it will cause deterioration or discoloration on the LCD panel surface.

Cleaning the Cabinet

- Unplug the power supply.
- Gently wipe the cabinet with a soft cloth.
- To clean the cabinet, dampen the cloth with a neutral detergent and water, wipe the cabinet and follow with a dry cloth.

NOTE: DO NOT clean with benzene thinner, alkaline detergent, alcoholic system detergent, glass cleaner, wax, polish cleaner, soap powder, or insecticide. Rubber or vinyl should not be in contact with the cabinet for an extended period of time. These types of fluids and materials can cause the paint to deteriorate, crack or peel.

Features

- **Optimized for Video wall**
 - **Ultra Narrow Bezel**
Provides the optimum solution in a tiling environment.
 - **Tile Matrix and Tile Compensation (TILE COMP), Tile Cut**
Shows one image over multiple screens with accuracy while compensating for bezel width.
 - **Frame Comp and V Scan Reverse**
Compensates for content lag in larger video walls with horizontal moving objects.
 - **HDMI / DisplayPort daisy chain**
Improved daisy chain capabilities allowing for 4K daisy chain for video wall purposes.
 - **USB power supply**
Allows the monitor to supply power to an external device via USB CM1 terminal (5 V/2 A (Max)).
- **Seamless and accurate color reproduction**
 - **SpectraView Engine**
The sophisticated NEC exclusive color processing engine integrated into the display. It combines internal luminance, white point, ambient lighting, temperature and time monitoring, together with individual characterization and calibration of each display during production, to provide an unparalleled level of color control, uniformity, accuracy and stability. The SpectraView engine provides the utmost in versatility; from faster and more advanced color calibration, to the ability to accurately emulate color spaces such as Adobe®RGB and sRGB, to performing printer output emulations using ICC Profiles and internal 3D Look-Up Tables.
 - **Picture modes include HDR (see page 53)**
Up to 5 programmable Picture Mode profiles for quick access to Industry standard color spaces or user customized settings. HDR video is also supported.
 - **NEC Display Wall Calibrator (NDWC) and MultiProfiler supported**
Multiple color modes can be easily configured and selected using the MultiProfiler software, which can be downloaded from our website.
 - **Uniformity (see page 105)**
Provides a more consistent luminance and color across the screen by compensating for variations in luminance and color that are inherent to LCD panels.
 - **Stand-alone calibration (see page 50)**
This function updates the monitor's internal color processor reference data with measurements taken using your color sensor to enhance color presentation.
Please calibrate your monitor in these cases:
 - All monitors are set to the same picture mode but each monitor's display color look individual.
 - Color degradation due to long-term use.By using a calibration sensor, OSD picture preset value will match to the value sensor measures.
- **Multiple signal input**
 - **Option Board Slot**
You can use an Option Board. Please contact your supplier for detailed information.
 - **Media player (see page 28)**
The internal Media Player will play audio and video files that are stored on a microSD memory card or USB memory connected to the side terminal panel on the monitor.
 - **DisplayPort and HDMI interfaces (see page 26)**
Designed to be future-ready scalable solutions for high performance digital display connectivity. Both interfaces enable the highest resolution, fastest refresh rates and deepest color depths.
 - **Picture-By-Picture/Picture-In-Picture (see page 54)**
Increases productivity by displaying two different input sources simultaneously, either side by side (Picture-By-Picture) or a small sub screen on a large main screen (Picture-In-Picture). This function can also be used to display one input source in two different picture modes for a side by side comparison of different settings.

Chapter 1 Installation

This Chapter Includes:

- ⇒ “Setup Overview” on page 7
- ⇒ “Mounting” on page 9
- ⇒ “Attaching Mounting Accessories” on page 13
- ⇒ “Installing an Option Board” on page 15
- ⇒ “Installing an Optional Sensor Unit” on page 16

CAUTION:

For box contents, please refer to the printed contents sheet provided in the box.

This device cannot be used or installed without the Tabletop Stand or other mounting accessory for support. For proper installation it is strongly recommended to use a trained, NEC authorized service person. Failure to follow NEC standard mounting procedures could result in damage to the equipment or injury to the user or installer. Product warranty does not cover damage caused by improper installation. Failure to follow these recommendations could result in voiding the warranty.

Setup Overview

1. Determine the installation location

- ⚠ CAUTION:**
- Installing your monitor must be done by a qualified technician. Contact your supplier for more information.
 - MOVING OR INSTALLING THE MONITOR MUST BE DONE BY TWO OR MORE PEOPLE. Failure to follow this caution may result in injury if the monitor falls.
 - This monitor has internal temperature sensors and cooling fans, including a fan for the Option Board. If the monitor becomes too hot, the cooling fans will turn on automatically.

The Option Board's fan is active although the temperature is lower than normal operating temperature for cooling the Option Board. If the monitor overheats while the cooling fan is running, a "Caution" warning appears. If the "Caution" warning appears, stop using the unit, turn off the power and allow it to cool. Using the cooling fans will reduce the likelihood of early unit failure and may help reduce image degradation and "Image Persistence".

If the monitor is used in an enclosed area or if the LCD panel is covered with a protective screen, please check the inside temperature of the monitor by using the HEAT STATUS control in the OSD (see [page 116](#)). If the temperature is higher than the normal operating temperature, please turn the cooling fan to [ON] within the [FAN CONTROL] menu within the OSD (see [page 116](#)).

NOTE: To avoid scratching the LCD panel, always place a soft cloth, such as a blanket that is larger than the monitor's screen area, on the table before laying the monitor face down.

2. Install the remote control (Optional) batteries

The remote control is powered by two 1.5 V AAA batteries.

To install or replace batteries:

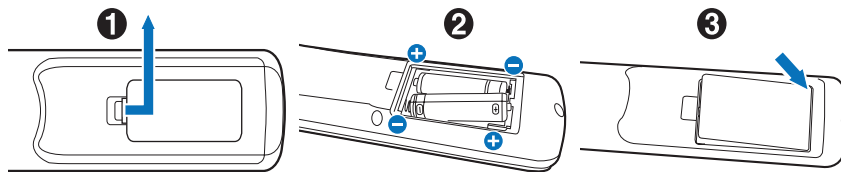

1. Press and slide to open the cover.
2. Align the batteries according to the (+) and (-) indications inside the case.
3. Replace the cover.

NEC recommends the following battery use:

- ⚠ CAUTION:** Incorrect usage of batteries can result in leaks or bursting.
- Place "AAA" size batteries matching the (+) and (-) signs on each battery to the (+) and (-) signs of the battery compartment.
 - Do not mix battery brands.
 - Do not combine new and old batteries. This can shorten battery life or cause liquid leakage of batteries.
 - Remove dead batteries immediately to prevent battery acid from leaking into the battery compartment.
 - Do not touch exposed battery acid, it may injure your skin.

NOTE: If you do not intend to use the Remote Control for a long period of time, remove the batteries.

3. Connect external equipment (See [page 23](#))

- To protect the external equipment, turn off the main power before making connections.
- Refer to the user's manual of your equipment for further information.

NOTE: Do not connect/disconnect cables when turning on the monitor or other external equipment as this may result in loss of image.

4. Connect the supplied power cord

- The monitor should be installed close to an easily accessible power outlet.

- ⚠ CAUTION:**
- Fasten the power cord to the monitor by attaching the screw and clamp. (Recommended Fasten Force: 139 - 189 N•cm).
 - Please make sure that enough power is supplied to the monitor. Please refer to the “Power Supply” in the specification (See “UN552” on page 96 and “UN552V” on page 97).

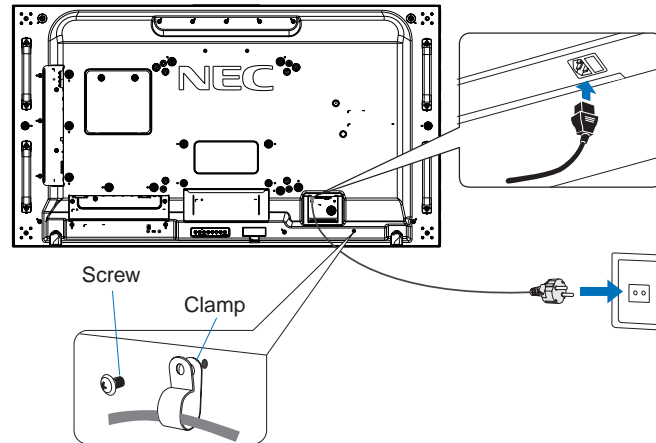

- ⚠ WARNING:**
- Please refer to the “Important Information” section of this user’s manual for proper selection of an AC power cord.
 - Fully insert the prongs into the power outlet socket. A loose connection may cause image instability and may pose a fire hazard.

5. Cable information

- ⚠ CAUTION:** Use the provided specified cables with this product so as not to interfere with radio and television reception. For DVI, USB and mini D-Sub 15-pin, please use a shielded signal cable with ferrite core. For HDMI, DisplayPort and D-Sub 9-pin, please use a shielded signal cable. Use of other cables and adapters may cause interference with radio and television reception.

6. Turn on the power for the external equipment and the monitor

When connected to a computer, switch on the monitor power first.

7. Operate the attached external equipment

Select the input source for the attached equipment to show the image signal on screen.

8. Adjust the sound

Make volume adjustments when required.

9. Adjust the picture settings (See page 101)

If necessary, make adjustments to the backlight, colors, contrast, and image position in the OSD PICTURE menu.

10. Recommended Adjustments

To reduce the risk of the “Image Persistence”, please adjust the following items based on the application being used:

- [SCREEN SAVER] and [SIDE BORDER COLOR] in the [OSD PROTECT] menu (see page 116).
It is recommended that the [FAN CONTROL] setting also be checked [ON].
- [DATE & TIME] and [SCHEDULE SETTINGS] in the [OSD SCHEDULE] menu (see page 106).

Mounting

⚠ CAUTION:

For customer:

DO NOT mount the monitor yourself. For proper installation it is strongly recommended to use a trained, qualified technician. Please contact your supplier as they may be able to provide a list of qualified installation professionals. Mounting on a wall or ceiling and hiring a technician is the customer's responsibility.

Maintenance

- Periodically check for loose screws, gaps, distortions, or other problems that may occur with the mounting equipment. If a problem is detected, please refer to qualified personnel for service.
- Regularly check the mounting location for signs of damage or weakness that may occur over time.

DO NOT block ventilated openings with mounting accessories or other accessories.

For NEC Qualified Personnel:

Stability Hazard

The device may fall, causing serious personal injury or death. To prevent injury, this device must be securely attached to the floor/wall in accordance with the installation instructions.

Carefully inspect the location where the unit is to be mounted. Not all walls or ceilings are capable of supporting the weight of the unit. The weight of this monitor is provided in the specifications (see "UN552" on page 96 and "UN552V" on page 97). Product warranty does not cover damage caused by improper installation, re-modeling, or natural disasters. Failure to comply with these recommendations could result in voiding the warranty.

To ensure safe installation, use two or more brackets to mount the unit. Mount the unit to at least two points on the installation location.

Please note the following when mounting on wall or ceiling:

⚠ CAUTION:

- When using mounting accessories other than those that are NEC approved, they must comply with the VESA-compatible (FDMLv1) mounting method.
- NEC recommends mounting interfaces that comply with UL1678 standard in North America.
- NEC strongly recommends using size M6 screws (10-12 mm + thickness of bracket and washer in length). If using screws longer than 10-12 mm, check the depth of the hole. (Recommended Fasten Force: 470 - 635 N•cm). Bracket hole should be under ϕ 8.5 mm.
- Prior to mounting, inspect the installation location to ensure that it is strong enough to support the weight of the unit so that the unit will be safe from harm.
- For detailed information, refer to the instructions included with the mounting equipment.
- Make sure that there is no gap between the monitor and the bracket.

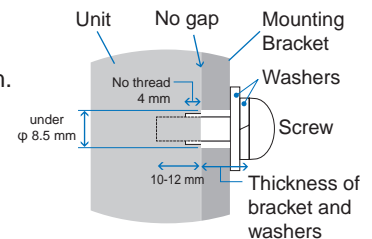

NOTE: When used in a video wall configuration for a long time, slight expansion of the monitors may happen due to temperature changes. It is recommended that over one millimeter gap is kept between adjacent monitor edges.

When used in a video wall configuration, you can use spacers to keep a gap between monitors. Attach spacers in the positions indicated below.

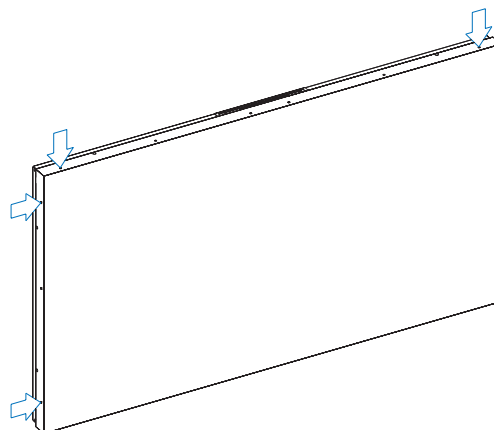

- Use a screwdriver for fixing spacers.
- The tightening torque is 0.63 N•m or less.

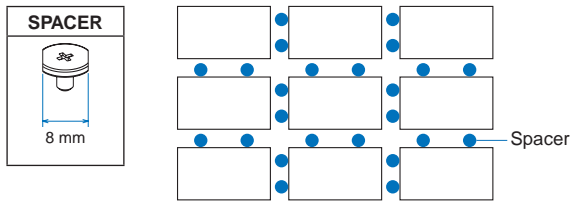

e.g. Spacer installation in multi-monitor configuration.

Installing a safety wire

- CAUTION:**
- Do not attempt to hang the monitor using an installation safety wire. The monitor must be properly installed.
 - When installing, do not apply pressure to the LCD panel or excessive force to any part of the monitor by pushing or leaning on it. This may cause the monitor to become distorted or damaged.
 - Please install the monitor in a spot on the wall or ceiling strong enough to support the monitor.
 - To prevent the monitor from falling off from the wall or ceiling, NEC strongly recommends using a safety wire.
 - Prepare the monitor using mounting accessories, such as hook, eyebolt, or mounting parts, and then secure the monitor with a safety wire. The safety wire must not be tight.
 - Please make sure the mounting accessories are strong enough to support the monitor before mounting it.

Installing a wire to a monitor with installed speakers (Landscape position only)

Please use speaker mounting parts to install a wire to the monitor.

Optional speaker is installed on the rear of the monitor:

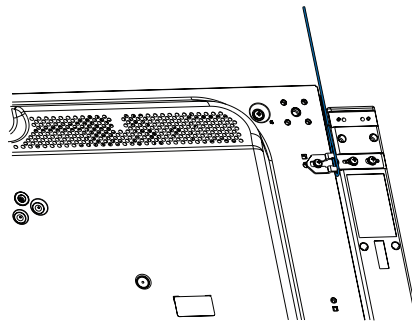

Handles for safety wire

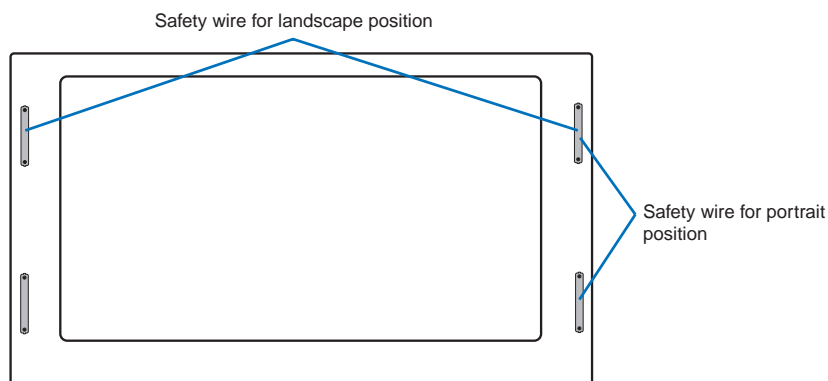

Mounting location

⚠ CAUTION:

- The ceiling or wall must be strong enough to support the monitor and mounting accessories.
- DO NOT install in locations where a door or gate can hit the unit.
- DO NOT install in areas where the unit will be subjected to strong vibrations and dust.
- DO NOT install the monitor next to a location where the main power supply is fed into the building.
- DO NOT install the monitor in a location where people can easily grab and hang onto the unit or the mounting equipment.
- When mounting in a recessed area, such as in a wall alcove, leave at least 4 inches (100 mm) of space between the monitor and the wall for proper ventilation.

NOTE: Allow for adequate ventilation or provide air conditioning around the monitor, so that heat can properly dissipate away from the monitor and from the mounting equipment.

Orientation

- When using the monitor in the portrait position, it should be rotated clockwise so that the left side is moved to the top, right side is moved to the bottom. This will allow for proper ventilation and will extend the lifetime of the monitor. Improper ventilation may shorten the lifetime of the monitor.

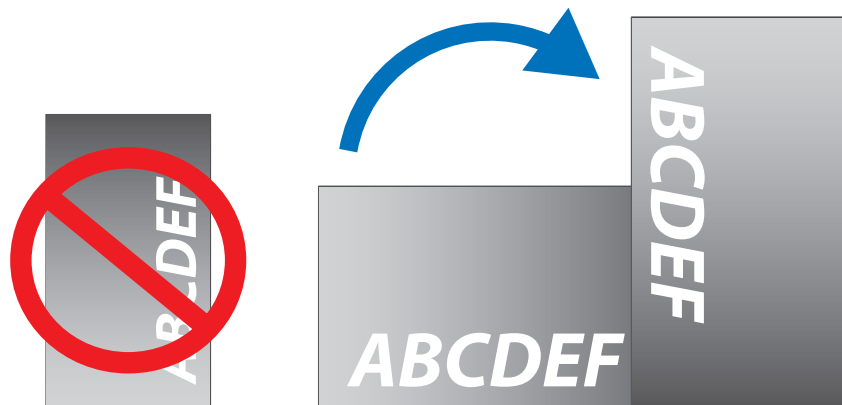

⚠ CAUTION:

- Do not mount this monitor with any tilt.
- Do not mount this product face up, face down, or upside down for an extended period of time as it may cause permanent damage to the screen.

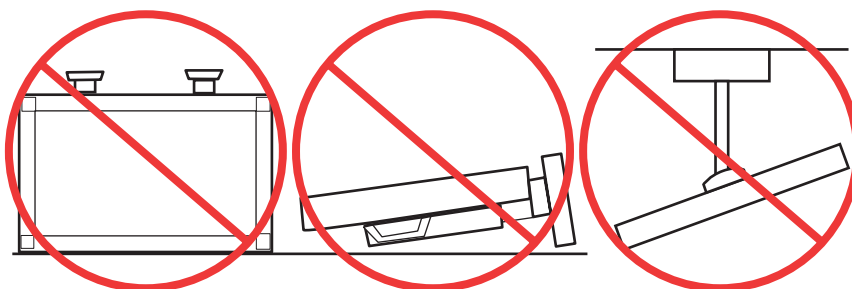

Ventilation Requirements

When mounting in an enclosed space or recessed area, leave adequate room between the monitor and the enclosure to allow heat to disperse, as shown below.

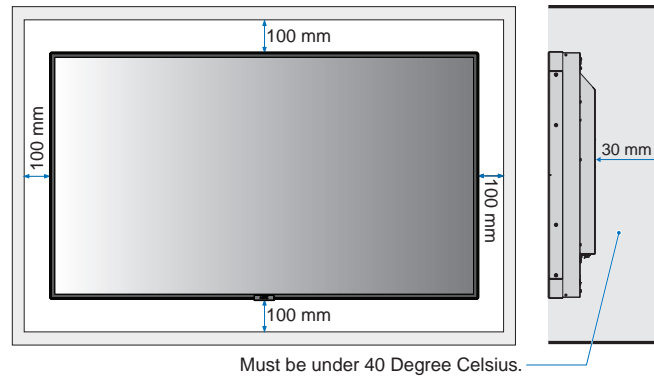

NOTE: Allow adequate ventilation or provide air conditioning around the monitor, so that heat can properly dissipate away from the unit and the mounting equipment; especially when you use monitors in a multiple screen configuration.

Mounting on ceilings

⚠ CAUTION:

- Ensure that the ceiling is strong enough to support the weight of the unit and the mounting equipment over time, against earthquakes, unexpected vibrations, and other external forces.
- Be sure the unit is mounted to a solid structure within the ceiling, such as a support beam. Secure the monitor using bolts, spring lock washers, washer and nut.
- DO NOT mount to areas that have no supporting internal structure. DO NOT use wood screws or anchor screws for mounting. DO NOT mount the unit to ceiling or to hanging fixtures.

Attaching Mounting Accessories

The monitor is designed for use with the VESA mounting system. Be careful to avoid tipping the monitor when attaching accessories.

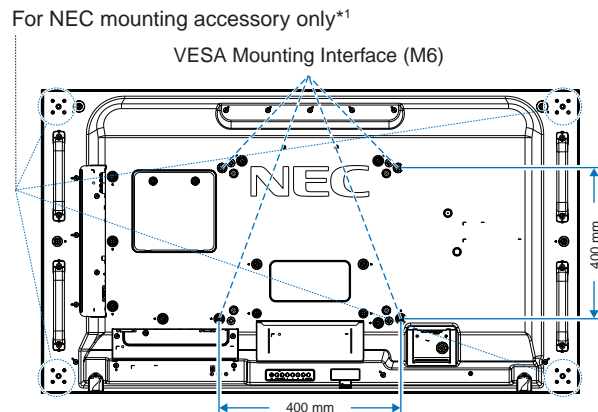

Mounting accessories can be attached with the monitor in the face down position. To avoid scratching the LCD panel, always place a soft cloth, such as a blanket that is larger than the monitor's screen area, on the table before laying the monitor face down. Make sure there is nothing on the table that can damage the monitor.

When using mounting accessories other than NEC compliant and approved, they must comply with the VESA Flat Display Mounting Interface Standard (FDMI).

NOTE: Prior to installation, place the monitor face down on a flat even surface that is larger than the monitor screen. Use a sturdy table that can easily support the weight of the monitor.

*¹: WM-55UN-L or WM-55UN-P.

Using a Wall Mount Adapter

If the mounting accessory interferes with ventilation holes, use the included wall mount adapters (Dia. 14 mm) and screws. If the adapter screws are too long, include a washer to reduce the depth. Washer not included.

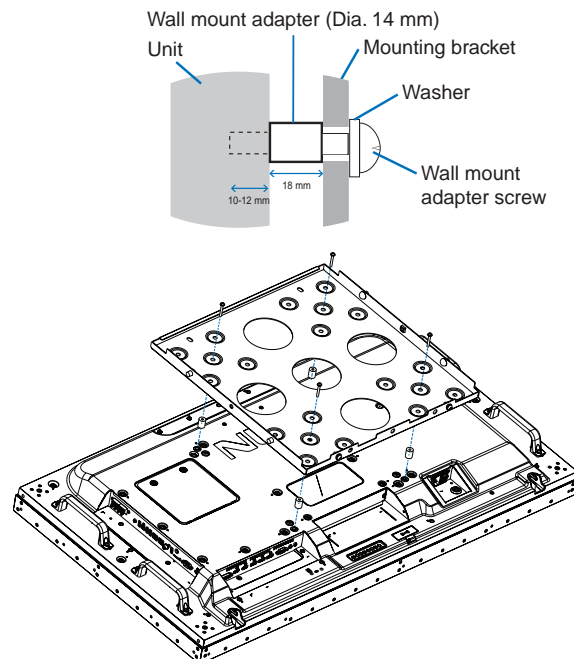

NOTE: Pictured mounting accessories may not be available in some countries.

Installing and Removing the Optional Table Top Stand

- ⚠ CAUTION:**
- Installing and removing the stand must be done by two or more people.
 - When installing the monitor stand, handle the unit with care to avoid pinching your fingers.

For installation, follow the instructions included with the stand or mounting equipment. Use only those devices recommended by the manufacturer.

- NOTE:**
- ONLY use thumbscrews which are included in the monitor.
 - Install the stand so the long end of the feet face forward. Use the ST-5220.

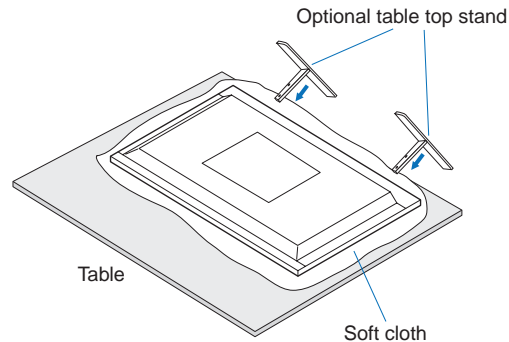

Prevent Tipping

⚠ CAUTION:

When using the monitor with the optional table top stand, fasten the monitor to a wall using a cord or chain that can support the weight of the monitor in order to prevent the monitor from falling. Fasten the cord or chain to the monitor using the provided clamps and screws.

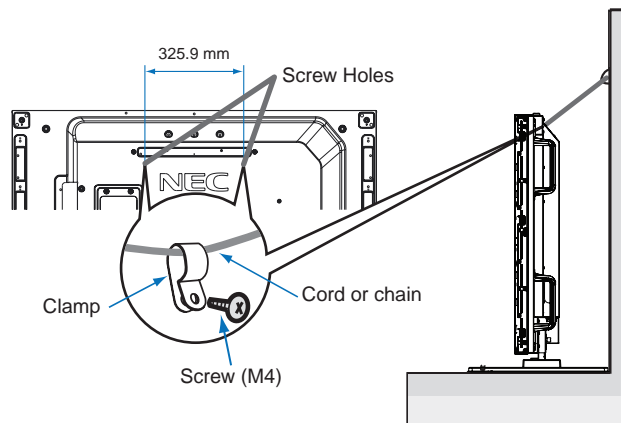

Before attaching the monitor to the wall, make sure that the wall can support the weight of the monitor.

- ⚠ CAUTION:** Be sure to remove the cord or chain from the wall before moving the monitor.

Installing an Option Board

1. Turn off the main power switch.
2. Place the monitor face down on a flat even surface that is larger than the monitor screen. Use a sturdy table that can easily support the weight of the monitor.

NOTE: To avoid scratching the LCD panel, always place a soft cloth, such as a blanket that is larger than the monitor's screen area, on the table before laying the monitor face down. Make sure there is nothing on the table that can damage the monitor.

3. Remove the attached slot cover by unscrewing the installed screws (**Figure 1**), sliding it to the right (**Figure 2**) and moving it up (**Figure 3**).

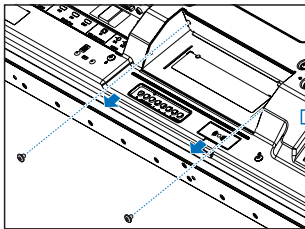
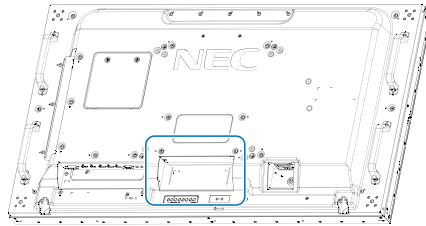

Figure 1

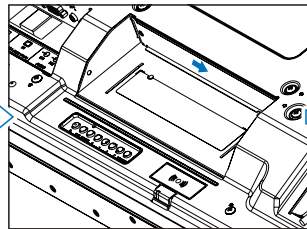

Figure 2

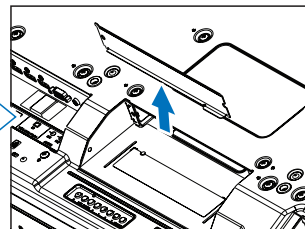

Figure 3

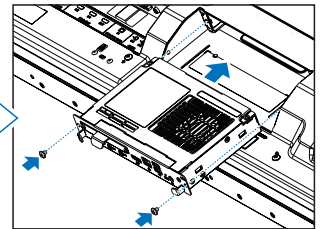

Figure 4

4. Insert the Option Board into the monitor and fix it in place with the removed screws (**Figure 4**).
(Recommended Fasten Force: 139 - 189 N•cm).

NOTE: Unless your monitor is purchased as part of a special bundle package, no Option Boards will be in the box or installed in the monitor. These are optional accessories available for separate purchase. Please contact your supplier for a list of Option Boards available for your monitor.

Make sure the board is inserted into the slot in the correct orientation.

Do not apply excessive force to manipulate the Option Board before fixing it with screws.

WARNING: Ensure the Option Board is securely fastened using the original screws to prevent the Option Board from falling out the monitor. A falling Option Board may expose you to danger.

Installing an Optional Sensor Unit

For installing the sensor to the monitor, please use the screw or the double-sided tape as shown below:

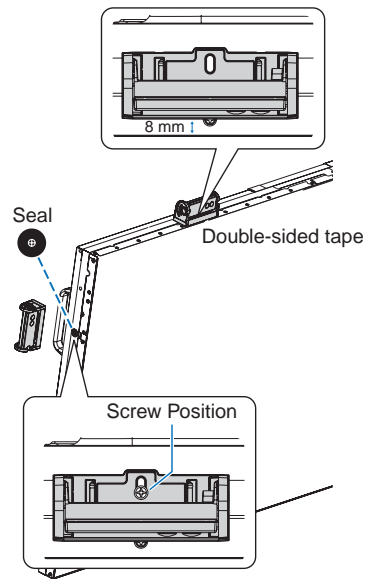

Fixed by screw: Remove the seal covering screw holes on the bezel. Secure the unit with the attached screw.
Set the sensor unit close to the back side.

Fixed by double-sided tape: You can set the sensor unit on any side of the monitor.
Set the sensor unit 8 mm away from the front edge.

Chapter 2 Parts Name and Functions

This Chapter Includes:

- ⇒ “Control Panel” on page 18
- ⇒ “Terminal Panel” on page 19
- ⇒ “Wireless Remote Control (Optional)” on page 21

Control Panel

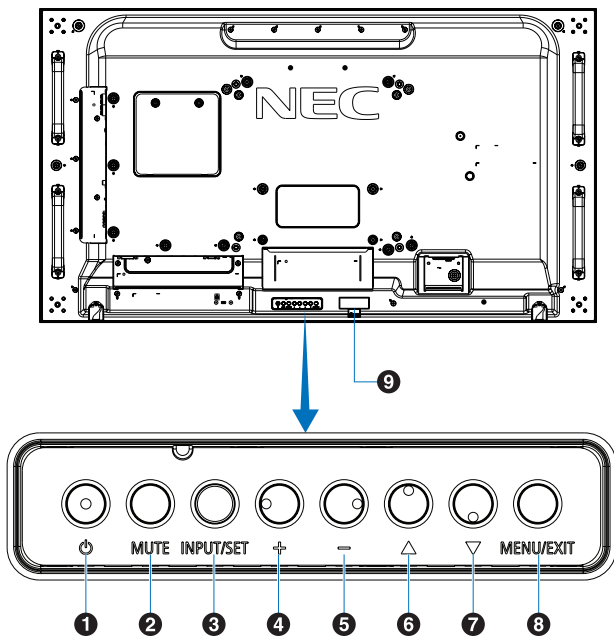

1 ⏻ Button (power button)

Switches between power on and standby. See [page 32](#).

2 MUTE Button

Switches the audio mute on/off.

3 INPUT/SET Button

INPUT: Cycles through the available inputs when the OSD menu is turned off. See [page 25](#) and [page 27](#).

[DVI], [HDMI1], [HDMI2], [DisplayPort1], [DisplayPort2], [VGA (YPbPr/RGB)], [VIDEO], [MP], [OPTION]*¹, [COMPUTE MODULE]*². These are available inputs only, shown as their factory preset name.

NOTE: MP is an abbreviation of Media Player.

SET: Acts as a set button when making a selection when the OSD menu is open.

*¹: This function depends on which Option Board installed in the monitor.

*²: This input is available when the optional Raspberry Pi Compute Module Interface Board and Raspberry Pi Compute Module are installed. See [page 98](#).

4 + Button (plus button)

Increases the audio output level when the OSD menu is turned off.

Acts to move the highlighted area to the right when navigating through the OSD menu options.

Acts as plus button to increase the adjustment of an OSD menu option after it has been selected with the [INPUT/SET] button.

5 - Button (minus button)

Decreases the audio output level when the OSD menu is turned off.

Acts to move the highlighted area to the left when navigating through the OSD menu options.

Acts as minus button to decrease the adjustment of an OSD menu option after it has been selected with the [INPUT/SET] button.

6 Δ Button (up button)

Activates the OSD menu when the OSD menu is turned off.

Acts as up button to move the highlighted area up to select adjustment items within the OSD menu.

7 ∇ Button (down button)

Activates the OSD menu when the OSD menu is turned off.

Acts as down button to move the highlighted area down to select adjustment items within the OSD menu.

8 MENU/EXIT Button

Activates the OSD menu when the OSD menu is turned off.

Acts as a back button within the OSD to move to the previous OSD menu.

Acts as an exit button to close the OSD when on the main menu.

9 Remote Control Sensor and Power Indicator

Receives the signal from the remote control (when using the wireless remote control). See [page 33](#).

Glow blue when the monitor is in active mode*¹.

Green and Amber blink alternately when the [SCHEDULE SETTINGS] function is enabled*².

When a component failure is detected within the monitor, the indicator will blink red or blink a combination of red and blue.

Please refer to the Power ON and OFF Modes table on [page 32](#).

*¹: If [OFF] is selected in the [POWER INDICATOR] the LED will not glow when the monitor is in active mode. See [page 120](#).

*²: If [OFF] is selected in the [SCHEDULE INDICATOR], the LED will not blink. See [page 120](#).

Terminal Panel

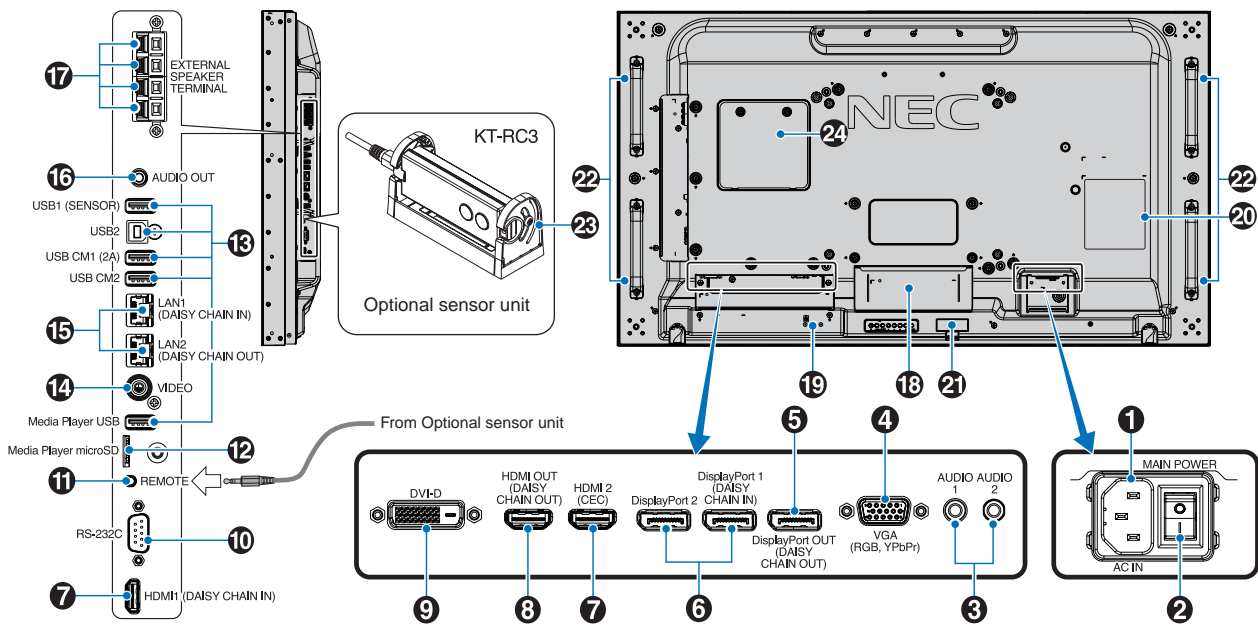

1 AC IN Connector

Connects with the supplied power cord.

2 Main Power Switch

On/Off switch to turn main power ON/OFF.

3 AUDIO IN (AUDIO1/AUDIO2)

Audio signal input from external equipment such as a computer or player.

4 VGA IN (Mini D-Sub 15-pin)

Analog RGB signals input from a personal computer or from other RGB equipment. This input can be used with an RGB or YPbPr source. Please select the signal type in [TERMINAL SETTINGS]. See [page 110](#).

NOTE: When you use this connector for YPbPr, please use a suitable signal cable. If you have any questions, please ask your supplier.

5 DisplayPort OUT (DisplayPort OUT (DAISY CHAIN OUT))

Output signal from DisplayPort 1 or OPTION.

6 DisplayPort IN (DisplayPort1 (DAISY CHAIN IN)/ DisplayPort2))

DisplayPort signals input.

7 HDMI IN (HDMI1 (DAISY CHAIN IN)/HDMI2 (CEC))

HDMI signals input.

8 HDMI OUT (HDMI OUT (DAISY CHAIN OUT))

Output signal from HDMI 1, DVI IN, or OPTION.

9 DVI IN (DVI-D)

Digital RGB signals input from a computer or HDTV device having a digital RGB output. See [page 110](#).

NOTE: This connector does not support analog input.

10 RS-232C IN (D-Sub 9-pin)

Connect RS-232C input from external equipment, such as a computer, in order to control RS-232C functions. See [page 79](#).

11 REMOTE

Use the optional sensor unit by connecting it to your monitor. See [page 16](#).

NOTE: Do not use this connector unless specified.

12 microSD Card Slot (Media Player microSD)

microSD memory card reader for use with the Media Player. See [page 39](#).

To install the microSD card slot cover, please refer to "Installing microSD card slot cover". See [page 28](#).

13 USB Ports

For the USB port information, please see “[Connecting a USB Device](#)” on page 30.

USB1 (SENSOR): Downstream port (USB Type-A).

USB2: Upstream port (USB Type-B).

USB CM1 (2A): Power supply port.

USB CM2*1: Service port. Please do not connect devices.

Media Player USB: USB storage device reader for use with the Media Player.

*1: USB functionality is available when the optional Raspberry Pi Compute Module Interface Board and Raspberry Pi Compute Module are installed. See [page 98](#).

14 VIDEO IN

Composite video signal input.

15 LAN Port IN/OUT (RJ-45) (LAN1 (DAISY CHAIN IN)/LAN2 (DAISY CHAIN OUT))

Connect to LAN in order to manage and control the monitor over the network. See [page 80](#).

NOTE: Please give priority for use to LAN1.

16 AUDIO

Audio signal output from AUDIO 1/2, DisplayPort and HDMI to an external device (stereo receiver, amplifier, etc.).

NOTE: This connector is not a Headphone terminal.

17 EXTERNAL SPEAKER TERMINAL

Audio signal output.

Red terminal is plus (+).

Black terminal is minus (-).

NOTE: This speaker terminal is for 15 W + 15 W (8 Ω) speaker.

18 Option Board Slot

Slot for installation of a Slot 2 type Option Board. See [page 15](#).

NOTE: Please contact your supplier for a list of compatible Option Boards.

19 Security Slot

Security and theft protection lock slot compatible with Kensington security cables/equipment.

NOTE: For products, visit Kensington's website.

20 Rating Label

21 Intelligent wireless data sensor

Sensor for wireless communication to the monitor for information and settings. See [page 88](#).

22 Option Speaker Mounting Holes

NOTE: Please contact your supplier for a list of compatible speaker.

23 Optional Sensor Unit (remote control, room light sensing and human sensing)

Receives the signal from the Remote control.

Detects the level of ambient light, allowing the monitor to make automatic adjustments to the backlight setting, resulting in a more comfortable viewing experience.

Do not cover this sensor.

Detects human presence in front of the monitor.

24 Raspberry Pi Compute Module Slot

Slot for installing a Raspberry Pi Compute Module Interface Board and Raspberry Pi Compute Module. See [page 98](#).

⚠ CAUTION: Installation must be performed by a qualified technician. Do not attempt to install a Compute Module Interface Board and Raspberry Pi Compute Module by yourself.

Wireless Remote Control (Optional)

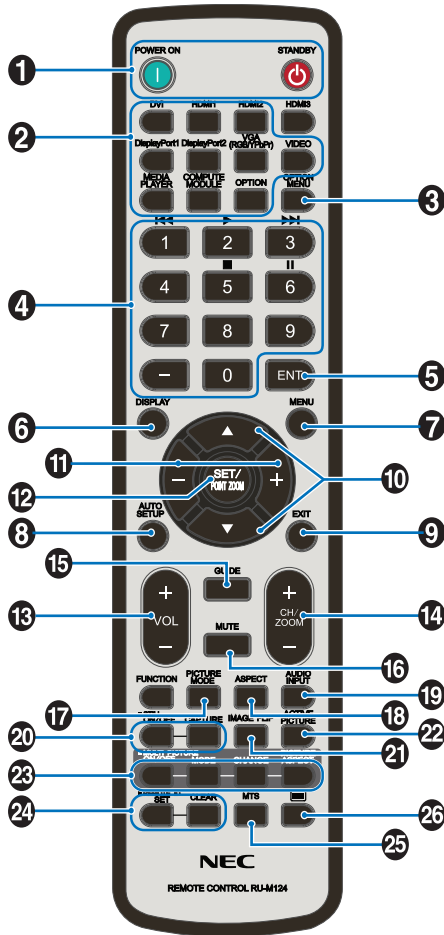

NOTE: The buttons with no explanation are not used with your monitor model.

1 POWER ON and STANDBY Buttons

POWER ON resumes full power from low power mode. STANDBY puts the monitor in low power mode. See [page 32](#).

2 INPUT Button

Cycles through the available inputs. See [page 25](#) and [page 27](#).

These are available inputs only, shown as their factory preset name.

NOTE: MP is an abbreviation of Media Player.

3 OPTION MENU Button

For use when an Option Board is installed. See [page 15](#).

The function depends on which Option Board installed in the monitor.

4 KEYPAD

Press the buttons to set and change passwords, change the channel and set the REMOTE ID. See [page 73](#).

Some buttons are used for CEC (Consumer Electronics Control) and the Media Player function ("Using the Remote Controls" on [page 41](#)).

5 ENT Button

Makes selections in the Media Player settings. See [page 63](#).

For use with an Option Board. The function depends on which Option Board installed in the monitor.

6 DISPLAY Button

Shows/Hides the information OSD. See [page 37](#).

Unlocks the remote control's buttons if they have been locked in the IR LOCK SETTINGS. Press and hold the DISPLAY button for more than 5 seconds to unlock the remote. See [page 60](#).

7 MENU Button

Opens and closes the OSD menu. See [page 37](#).

8 AUTO SET UP Button

Enters auto setup menu. See [page 103](#).

9 EXIT Button

Acts as a back button within the OSD to move to the previous OSD menu.

Acts as an EXIT button to close the OSD when on the main menu.

10 ▲/▼ Button (up/down button)

Acts as navigation buttons, within the OSD and Media Player menus, to move the highlighted area up or down.

Moves the Active picture up or down when using Multi Picture Mode. See [page 54](#).

11 -/+ Button (minus/plus button)

Acts as navigation buttons, within the OSD and Media Player menus, to move the highlighted area left or right.

Increases or decreases the adjustment level within the selected OSD menu setting.

Moves the Active picture left or right when using Multi Picture Mode. See [page 54](#).

12 SET/POINT ZOOM Button

SET: When the OSD is shown, this button acts as a set button when you make a selection.

POINT ZOOM: When the OSD is not shown, this button acts as a point zoom button. See [page 36](#).

13 VOLUME +/- Button

Increases or decreases the audio output level.

14 CH/ZOOM +/- Button*

Increases or decreases the point zoom level. Please refer to the Point Zoom instructions. See [page 36](#).

*: When using with an Option Board, the function depends on which Option board is installed in the monitor.

15 GUIDE Button

For use with an Option Board. The function depends on which Option Board is installed in the monitor.

16 MUTE Button

Silences the audio signal.

17 PICTURE MODE Button

Cycles through the picture modes [HIGHBRIGHT], [STANDARD], [sRGB], [CINEMA], [CUSTOM1], [CUSTOM2], [SVE-(1-5) SETTINGS]. See [page 34](#).

18 ASPECT Button

Cycles through the picture aspect ratios [FULL], [WIDE]*, [DYNAMIC]*, [1:1], [ZOOM] and [NORMAL]. See [page 35](#).

*: HDMI1, HDMI2, VGA (YPbPr) inputs only.

19 AUDIO INPUT Button

Selects the audio input source [IN1], [IN2], [HDMI1], [HDMI2], [DisplayPort1], [DisplayPort2], [OPTION]*¹, [MP] and [COMPUTE MODULE]*².

*¹: This function depends on which Option Board is installed in the monitor.

*²: This input is available when the optional Raspberry Pi Compute Module Interface Board and Raspberry Pi Compute Module are installed. See [page 98](#).

20 STILL Button

ON/OFF button: Activates/deactivates still picture mode.

CAPTURE button: Captures a still picture.

- NOTE:**
- This function deactivates when selecting [MULTI PICTURE MODE], [TEXT TICKER], [SCREEN SAVER], [POINT ZOOM], [IMAGE FLIP except for NONE], [SUPER in INPUT CHANGE], [TILE MATRIX].
 - [CLOSED CAPTION] is not available when STILL is active.
 - If the input signal is option, this button's action depends on which Option Board is installed in the monitor.

21 IMAGE FLIP Button

Toggle switches between [H FLIP], [V FLIP], [180° ROTATE] and [NONE]. See [page 105](#).

22 ACTIVE PICTURE Button

Selects the active picture when Multi Picture Mode is enabled. See [page 54](#).

23 MULTI PICTURE Buttons

ON/OFF button: Turns Multi Picture Mode on and off.

MODE button: Switches the mode between PIP (Picture-In-Picture) and PBP (Picture-By-Picture).

CHANGE button: Swaps the selected inputs between Picture 1 and Picture 2.

PICTURE ASPECT button: Selects the active picture frame aspect.

For more information see [page 54](#).

NOTE: If you press SET/INPUT ZOOM button while Multi Picture is ON, you can change the active picture's picture size.

24 REMOTE ID Button

Activates the REMOTE ID function. See [page 73](#).

25 MTS Button

For use with an Option Board. The function depends on which Option Board is installed in the monitor.

26 Button*

Activates closed captioning for VIDEO input only.

*: When using with an Option Board, the function depends on which Option Board is installed in the monitor. Refer to the Option Board's user's manual for further information.

Chapter 3 Connections

This Chapter Includes:

- ⇒ “Wiring Diagram” on page 24
- ⇒ “Connections” on page 24
- ⇒ “External Video Connections” on page 25
- ⇒ “Internal Video Sources” on page 27
- ⇒ “Connecting a USB Device” on page 30

Connecting External Equipment

- NOTE:**
- Do not connect or disconnect cables when turning on the monitor’s main power or other external equipment’s power as this may result in loss of image.
 - Do not use an attenuating (built-in resistor) audio cable. Using an audio cable with a built-in resistor will lower the sound level.

Before making connections:

- Turn off the device’s power before connecting it to the monitor.
- Refer to the device’s user manual for available connection types and instructions for the device.
- We recommend turning off the monitor’s main power before connecting or disconnecting a USB storage device or microSD memory card to avoid data corruption.

Wiring Diagram

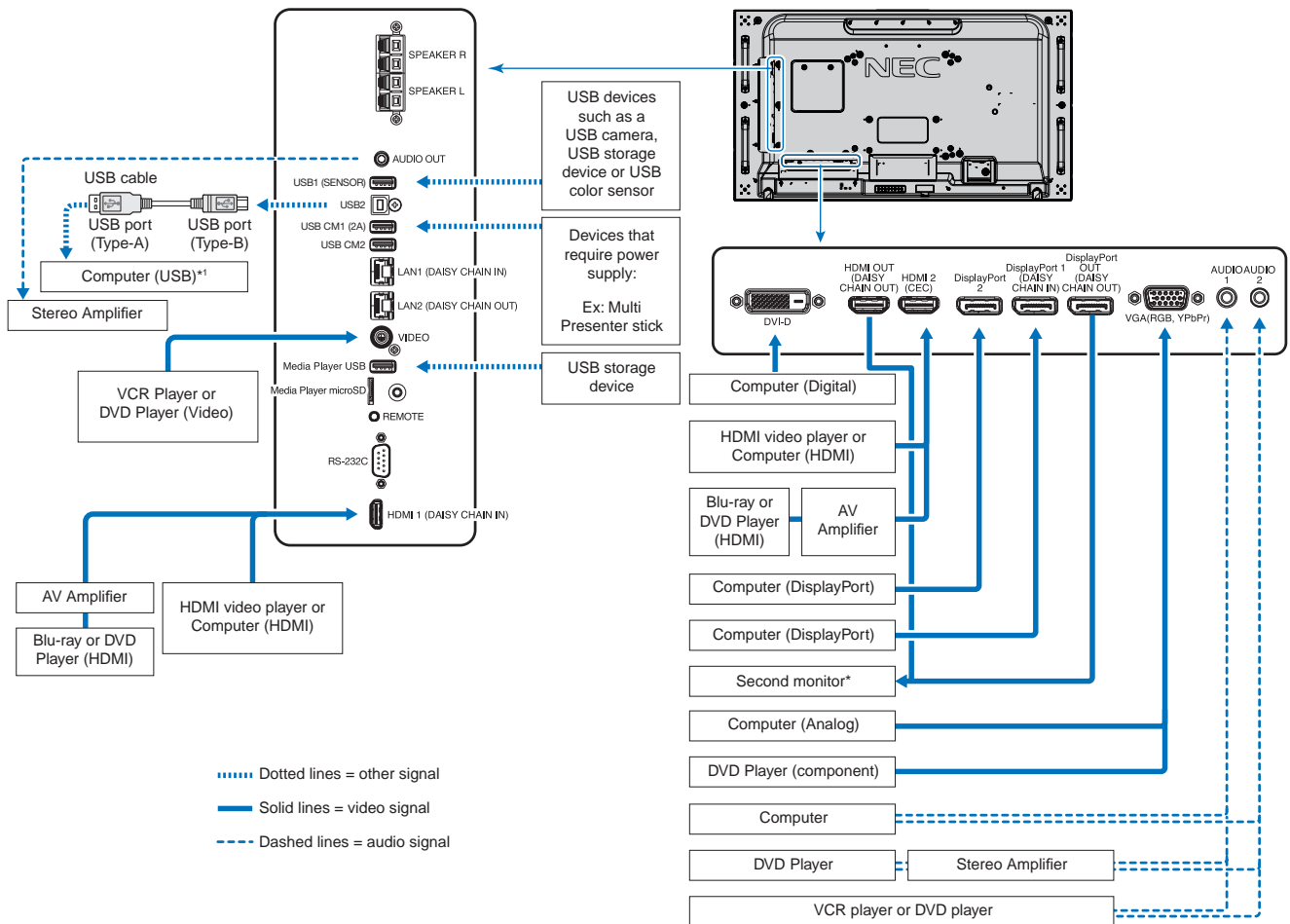

*: Multiple monitors that are daisy-chained have a limit to the number of connectable monitors. See [page 70](#).

*1: The device connected to USB2 can control the device connected to USB1 (SENSOR). See the ["Connecting a USB Device"](#) on [page 30](#).

Connections

Connecting terminal	Setting in TERMINAL SETTINGS	Input signal name	Connecting audio terminal	Input button in remote control
DVI (DVI-D)	DVI MODE: DVI-PC/DVI-HD	DVI	IN1/IN2	DVI
HDMI1 (DAISY CHAIN IN)	VIDEO LEVEL: RAW/EXPAND*2	HDMI1	HDMI1	HDMI1
HDMI2 (CEC)	VIDEO LEVEL: RAW/EXPAND*2	HDMI2	HDMI2	HDMI2
DisplayPort 1 (DAISY CHAIN IN)	VIDEO LEVEL: RAW/EXPAND*2	DisplayPort 1	DisplayPort 1	DisplayPort 1
DisplayPort 2	VIDEO LEVEL: RAW/EXPAND*2	DisplayPort 2	DisplayPort 2	DisplayPort 2
VGA (RGB, YPbPr)	VGA MODE: RGB/YPbPr	VGA: RGB/YPbPr	IN1/IN2	VGA (RGB/YPbPr)
VIDEO	—	VIDEO	IN1/IN2	VIDEO
Option Board Slot (SLOT2)	VIDEO LEVEL: RAW/EXPAND*2	OPTION	OPTION (ANALOG/DIGITAL)*2	OPTION
Media Player USB/microSD	—	MP	Media Player USB/microSD	MEDIA PLAYER
Raspberry Pi Compute Module slot	VIDEO LEVEL: RAW/EXPAND*2	COMPUTE MODULE	COMPUTE MODULE	COMPUTE MODULE

*2: Please set appropriate setting for input signal.

External Video Connections

Video Inputs

- Composite Video (RCA) – Analog video signal input with standard definition video quality, no audio signal.
- VGA – Analog video signal connection to a computer. Video only, no audio signal.
- DVI-D – Digital video signal connection to a computer. Video only, no audio signal.
- HDMI – High definition digital video and audio signal connection to a computer, streaming media player, Blu-ray player, game console, etc.
- DisplayPort (DP) – High definition digital video and audio signal connection to a computer.

Connecting to a Personal Computer

The type of video connections that can be used to connect to a computer depends on the computer's display adapter.

The following table shows the typical factory preset signal timing for each connection type. Some display cards may not be able to support the required resolution for proper image reproduction with the selected connection. The monitor will show the proper image by automatically adjusting the factory preset timing signal.

<Typical factory preset signal timing>

Resolution	Scanning frequency		VGA	DVI	HDMI		DisplayPort		Remarks
	Horizontal	Vertical			MODE1	MODE2	1.1a	1.2	
640 x 480	31.5 kHz	60 Hz	Yes	Yes	Yes	Yes	Yes	Yes	
800 x 600	37.9 kHz	60 Hz	Yes	Yes	Yes	Yes	Yes	Yes	
1024 x 768	48.4 kHz	60 Hz	Yes	Yes	Yes	Yes	Yes	Yes	
1280 x 720	45.0 kHz	60 Hz	Yes	Yes	Yes	Yes	Yes	Yes	
1280 x 768	47.8 kHz	60 Hz	Yes	Yes	Yes	Yes	Yes	Yes	
1280 x 800	49.7 kHz	60 Hz	Yes	Yes	Yes	Yes	Yes	Yes	
1280 x 960	60.0 kHz	60 Hz	Yes	Yes	No	No	No	No	
1280 x 1024	64 kHz	60 Hz	Yes	Yes	Yes	Yes	Yes	Yes	
1360 x 768	47.7 kHz	60 Hz	Yes	Yes	Yes	Yes	Yes	Yes	
1366 x 768	47.7 kHz	60 Hz	Yes	Yes	Yes	Yes	Yes	Yes	
1400 x 1050	65.3 kHz	60 Hz	Yes	Yes	Yes	Yes	Yes	Yes	
1440 x 900	55.9 kHz	60 Hz	Yes	Yes	Yes	Yes	Yes	Yes	
1600 x 1200	75.0 kHz	60 Hz	Yes	Yes	Yes	Yes	Yes	Yes	Compressed image
1680 x 1050	65.3 kHz	60 Hz	Yes	Yes	Yes	Yes	Yes	Yes	
1920 x 1080	67.5 kHz	60 Hz	Yes	Yes	Yes	Yes	Yes	Yes	Recommended resolution
1920 x 1200	74.6 kHz	60 Hz	Yes* ¹	Yes* ¹	Yes	Yes	Yes	Yes	Compressed image
1920 x 2160	133.3 kHz	60 Hz	No	No	Yes	Yes	Yes	Yes	Compressed image
3840 x 2160	65.7 kHz	30 Hz	No	No	No	No	Yes	Yes	Compressed image
3840 x 2160	67.5 kHz	30 Hz	No	No	Yes	Yes	No	No	Compressed image
3840 x 2160	133.3 kHz	60 Hz	No	No	No	Yes	No	Yes*	Compressed image
3840 x 2160	135.0 kHz	60 Hz	No	No	No	Yes	No	Yes*	Compressed image
4096 x 2160	54.0 kHz	24 Hz	No	No	Yes	Yes	No	No	Compressed image

*: Only HBR2 is set.

*1: Reduce blanking.

Connecting to a Computer with HDMI

- Please use an HDMI cable with the HDMI logo.
- It may take a moment for the signal to appear after turning on the computer.
- Some display cards or drivers may not display an image correctly.
- When you use a computer with HDMI, please set [OVERSCAN] to [AUTO] or [OFF] as display drivers may not be fully compatible and may not display an image correctly. See [page 104](#).
- To output HDMI audio, set [HDMI1] or [HDMI2] at AUDIO INPUT in the OSD or choose [HDMI1] or [HDMI2] by pressing the remote control AUDIO INPUT button.
- If the source signal is 3840 x 2160 (60 Hz) or HDCP 2.2 or HDR, please set [MODE2] at [HDMI] in [TERMINAL SETTINGS]. See [page 110](#).
- If the monitor's main power is turned on after a connected computer is turned on, sometimes an image is not displayed. In this case, please turn off the computer then turn it on again.

Connecting a Computer with DisplayPort

- Please use a DisplayPort cable with the DisplayPort compliance logo.
- To use the DisplayPort out connector, please refer to Video out. See [page 72](#).
- It may take a moment for the signal to appear after turning on the computer.
- When connecting a DisplayPort cable to a component with a signal conversion adapter, an image may not appear.
- Some DisplayPort cables feature a locking function. When removing this cable, hold down the top button to release the lock.
- To output DisplayPort audio, set [DisplayPort1] or [DisplayPort2] at [AUDIO INPUT] in the OSD or choose [DisplayPort1] or [DisplayPort2] by the remote control AUDIO INPUT button.
- To display individual images at each connected monitors with the DisplayPort OUT connector, please set [DisplayPort1.2] and [MST] at [DisplayPort] in the [TERMINAL SETTINGS]. See [page 110](#).
- If the monitor's main power is turned on after a connected computer is turned on, sometimes an image is not displayed. In this case, please turn off the computer then turn it on again.

Connecting to a Media Device with HDMI

Connect using a single HDMI cable for the highest picture and audio quality from Blu-ray players, streaming media players, or game consoles. 4K UHD content is displayed when the connected media player also supports 4K content.

Supports HDCP (High-bandwidth Digital Contents Protection) coding, a type of digital rights management that prevents high-definition content, in Blu-ray discs, DVDs and streaming media, from being copied or broadcast illegally.

- NOTE:**
- Supports 1920x1080 (60 Hz), 1080p, 1080i, 720p@50Hz/60Hz, 576p@50Hz, 480p@60Hz, 576i@50Hz, 480i@60Hz, 3840x2160 (30Hz/24Hz/25Hz [MODE1]), 3840x2160 (60Hz [MODE2]), 4096x2160 (24Hz).
 - Connect the HDMI cable when both the media player and the monitor are powered off.
 - Use an HDMI cable with the HDMI logo.
 - Some HDMI cables and devices may not display an image correctly due to different HDMI specifications.

HDMI-CEC (Consumer Electronics Control)

HDMI-CEC provides compatible media players, connected via HDMI, the ability to communicate and allow limited control between the device and the monitor. For example, turning on a Blu-ray player can immediately switch input to the Blu-ray player without using the remote control. Not all devices are fully compatible, and, in some cases, the media device manufacturer may only provide compatibility with its own monitors or TVs. See “Supporting HDMI CEC Command” on page 78.

When supported, the monitor’s optional Remote Control can be used to control the HDMI media device. The remote’s CEC enabled buttons are:

1 (⏮), 2 (▶), 3 (⏭), 5 (■), 6 (⏪), ENT, EXIT, ▲, ▼, +, -

NOTE: The instructions in this section guide you through configuring [CEC] in the monitor’s OSD menu. These settings can also be configured using the monitor’s web controls. The function names and location in the web controls are the same as the OSD menu.

Enabling CEC

1. Connect a CEC device to the HDMI2 port.
Press the HDMI2 button on the remote control .
2. Press the MENU button to open the OSD.
3. Navigate to [CONTROL] then to [CEC].
4. Select [ON] for [CEC] then [YES] for the [AUTO TURN OFF] and [AUDIO RECEIVER].
5. Select [YES] under [SEARCH DEVICE].

When the search is complete, the HDMI port with a CEC connected device is displayed with its name.

If no CEC device is found, make sure the device is plugged in, turned on, it supports CEC and CEC is enabled. Depending on the manufacturer, the CEC feature may have a different name. Refer the device’s product manual.

6. Press the EXIT button on the remote control.

Internal Video Sources

There are some video sources available that are internal and not connected to the video ports on the monitor’s Terminal Panel. These video sources are:

- Media Player
- OPS Option Board
- Raspberry Pi Compute Module

Media Player

The internal Media Player will play audio and video files that are stored on a microSD memory card or USB storage device. See [page 39](#) for instructions on using the Media Player.

Connect Compatible microSD Memory Card

Format a microSD memory card in the FAT32 format or FAT16 format. Refer to the computer's instruction manual or help file on how to format a microSD memory card.

NOTE: Up to 32GB microSDHC is supported.

The monitor is not guaranteed to work with all microSD memory cards sold commercially.

microSD with CPRM is not supported.

microSD UHS-1 or UHS-2 are not supported.

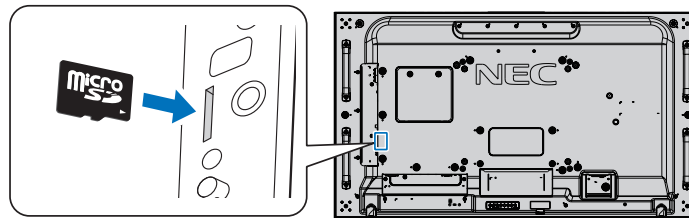

- When inserting a microSD memory card, please make sure of the microSD memory card is in the correct direction then insert it. Fully insert the microSD memory card and press in until the spring lock is engaged.
- When ejecting a microSD memory card from the microSD card slot, press the center of the microSD memory card to release the spring lock, then take it out.

Installing microSD card slot cover

To secure your microSD memory card, we recommend you to install the microSD card slot cover.

Please insert the edge of the microSD card cover into the hole. Secure it in place with the provided screw. (Recommended Fasten Force: 139 - 189 N•cm).

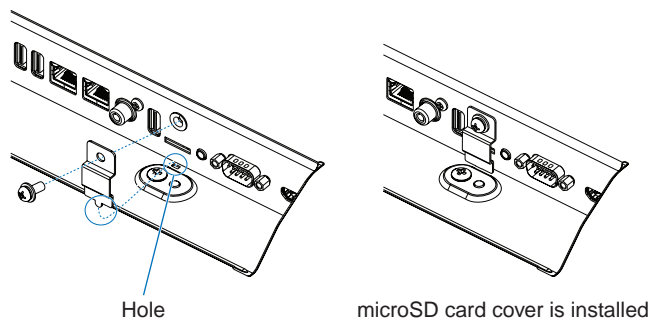

Connect Compatible USB storage device

Format a USB storage device in the FAT32 format or FAT16 format to use it with the Media Player. Refer to the computer's instruction user's manual or Help file on how to format a USB storage device.

Please use a USB storage device with this monitor in accordance with the drawing below.

If the physical size of the USB storage device is larger than the supported size listed below, please use a USB extension cable.

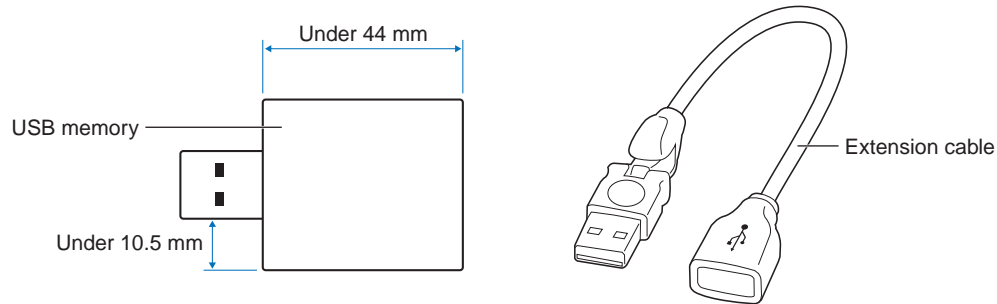

- NOTE:**
- If the monitor does not recognize a connected USB storage device, make sure the file structure is FAT32 or FAT16.
 - The monitor is not guaranteed to work with all USB storage devices sold commercially.
 - Insert the USB storage device into the Media Player USB port on the monitor's side terminal panel.
 - The Media Player does not use any other USB connection on the monitor (see [page 19](#)).

Option Boards for the Monitor

When an Option Board or a Raspberry Pi Compute Module Interface Board and Raspberry Pi Compute Module are installed in the monitor, it will show as available in the list in the [INPUT] of the OSD menu. Option Boards, the Raspberry Pi Compute Module Interface Board and Raspberry Pi Compute Module are available separately and must be physically installed in the monitor. This document contains instructions for how to use the monitor without any additional options. The locations where an Option Board and the Raspberry Pi Compute Module Interface Board, Raspberry Pi Compute Module are installed is indicated on the Terminal Panel diagram (see [page 19](#)). Full installation and usage instructions are provided with the individual device or available online.

- NOTE:**
- The optional DS1-IF10CE Compute Module Interface Board and Raspberry Pi Compute Module are available separately. Please contact an authorized NEC dealer for more information. Installation must be performed by a qualified technician. Do not attempt to install a Compute Module Interface Board and Raspberry Pi Compute Module by yourself. See [page 98](#).
 - Please contact your supplier for available Option Boards.

Connecting a USB Device

Some of the USB ports on the monitor's terminal panel have different uses depending on the type of connected USB device. Please follow these guidelines when using these ports with supported devices.

USB1 (SENSOR): USB downstream port (Type-A).

Connection used by external USB devices (such as cameras, flash memory, keyboards, etc.) and internal devices (an Option Board or Raspberry Pi Compute Module Interface Board and Raspberry Pi Compute Module when installed).

USB2: USB upstream port (Type-B).

Connection to a computer with a USB cable. A USB compatible computer connected to USB2 can control the devices connected to USB1 (SENSOR) port.

USB CM1* (2A): Power supply port.

Provides up to 2 A of power to a connected USB device, such as HDMI streaming media or presenter sticks. The actual amount of power consumption depends on the connected device. Make sure to use a USB cable that supports 2 A.

Enable [USB POWER] in the [USB] settings of the [CONTROL] menu in the OSD. See [page 121](#).

Please refer to the specifications pages for power supply information. See [page 95](#).

* Functions as a standard USB port when used with the Raspberry Pi Compute Module Interface Board and Raspberry Pi Compute Module. See [page 98](#).

USB CM2*: Service port.

Please do not connect devices.

* Functions as a standard USB port when used with the Raspberry Pi Compute Module Interface Board and Raspberry Pi Compute Module. See [page 98](#).

Media Player USB: USB downstream port (Type-A).

This port is for future software upgrades.

USB storage device reader for use with the internal Media Player. See [page 39](#).

⚠ CAUTION: Do not bind the USB cable. It may trap heat and start a fire.

- NOTE:**
- Please make sure the connector shape and orientation is correctly aligned when connecting the USB device or cable.
 - Depending on the computer BIOS, OS or device, the USB function may not work. Please check the user's manual of your computer or device.
 - Before turning off the main power switch of the monitor or shutting down Windows®, please turn off the USB function and remove the USB device from the monitor. Data may be lost or corrupted if the USB device is not disconnected properly.
 - It may take a few seconds for the monitor to recognize the USB input. Do not disconnect the USB cable or disconnect and reconnect the USB cable before the monitor recognizes the input.

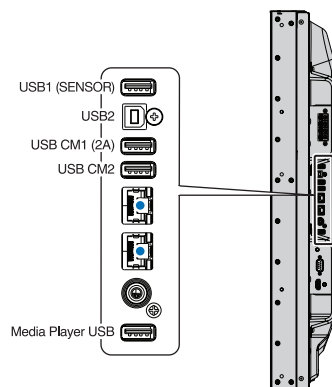

Chapter 4 Basic Operation

This Chapter Includes:

- ⇒ “Power ON and OFF Modes” on page 32
- ⇒ “Operating Range for the Optional Remote Control” on page 33
- ⇒ “Using Power Management” on page 33
- ⇒ “Showing the Information OSD” on page 34
- ⇒ “Switching Between Picture Modes” on page 34
- ⇒ “Setting the Aspect Ratio” on page 35
- ⇒ “Using Point Zoom” on page 36
- ⇒ “OSD (On-Screen-Display) Controls” on page 37
- ⇒ “Using the Media Player” on page 39

Power ON and OFF Modes

Press the  button on the Control Panel or POWER ON button on the Remote Control to turn on the monitor.

The monitor's power LED indicates the current status of the monitor. Please refer to the following table for information about the LED indicator.

LED indicator status and lighting pattern	Condition	Recovery
Glowing blue	Normal	<ol style="list-style-type: none"> 1. Turn on the monitor by the remote control or the monitor button. 2. Send an AV signal input to the monitor.
Blinking green* ¹	Under any of the conditions below, no input signal has been detected by the monitor during the period of time you set: <ul style="list-style-type: none"> • The monitor is using an Option Board. • [INPUT DETECT] is set to a setting except for [NONE]. • [USB POWER] is set to [ON]. • DisplayPort in the [TERMINAL SETTINGS] is set to [MST]. 	
Glowing amber	No AV signal input has been detected by the monitor during the period of time you set. (with network signal input)	
Blinking amber	No AV signal input has been detected by the monitor during the period of time you set. (no network signal input)	Turn on the monitor by the remote control or the monitor button.
Glowing red	Turn off the monitor by the remote control or the monitor button.	

*1: Time setting for [AUTO POWER SAVE] is available at [POWER SAVE] (See [page 116](#)).

- NOTE:**
- The blue LED indicator that the monitor is powered on and functioning normally can be turned off in the monitor's OSD menu options. See [page 120](#).
 - If the indicator is blinking red in a combination of long and short durations, a certain failure might have occurred, please contact your supplier.

The Main Power switch must be in the ON position in order to power up the monitor using the POWER ON button on the remote control or the  button on the Control Panel.

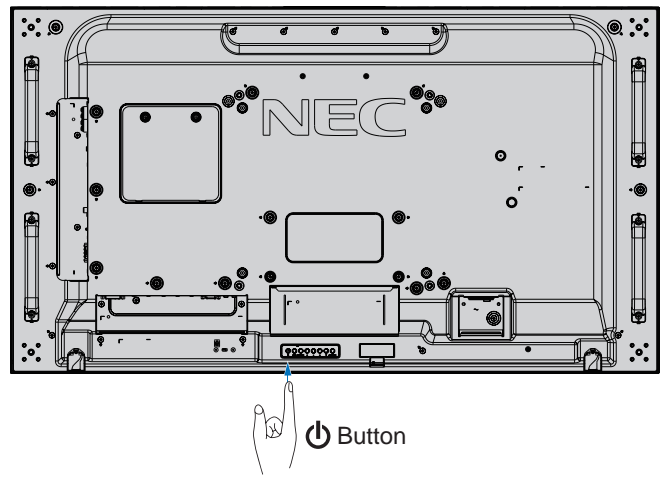
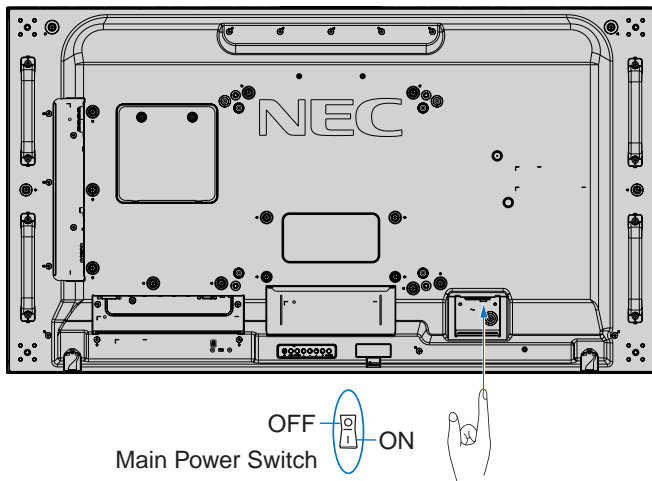

Operating Range for the Optional Remote Control

Point the top of the remote control toward the monitor's remote control sensor during button operation.

Use the remote control within a distance of about 7 m (23 ft.) from the remote control sensor, or at a horizontal and vertical angle of within 30° and within a distance of about 3.5 m (10 ft.).

NOTE: The remote control system may not function when direct sunlight or strong illumination strikes the remote control sensor, or when there is an object in the path.

Handling the remote control

- Do not expose to strong shock.
- Do not allow water or other liquid to splash on the remote control. If the remote control gets wet, wipe it dry immediately.
- Avoid exposure to heat and steam.
- Except to install the batteries, do not open the remote control.

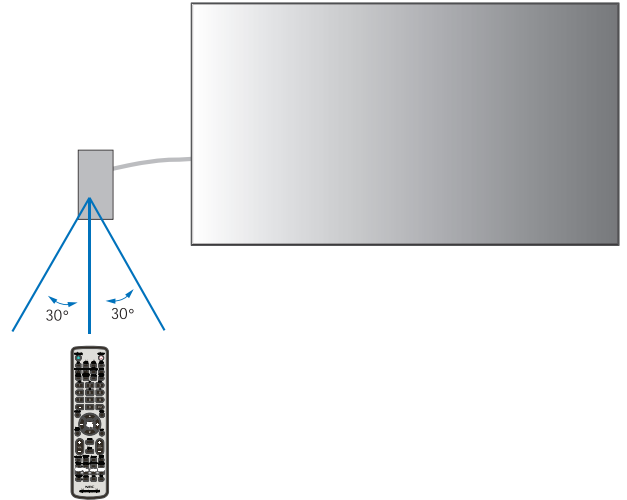

Using Power Management

This monitor follows the VESA approved DPM (Display Power Management) function. This function decreases the power consumption of the monitor when it is not in use.

When connected to a computer, power consumption by the monitor reduces automatically if the keyboard or mouse are not used during the time set in the computer's power management settings. Refer to your computer's user manual for more information.

When connected to an AV source, such as a Blu-ray, DVD, or streaming video player, power consumption by the monitor reduces automatically after a certain amount of time has passed since the monitor recognized "no signal input". This option is turned on or off in the [POWER SAVE] settings under the [PROTECT] menu of the OSD. See [page 116](#).

- NOTE:**
- Depending on the computer and display card used, this function may not operate.
 - After the video signal is lost, the monitor automatically goes into off at a preset time period. Please refer to the [AUTO POWER SAVE TIME SETTING] in [POWER SAVE] [page 116](#).
 - Schedules can be created for the monitor to power on or off at specific times. See [page 46](#).

Showing the Information OSD

The Information OSD provides information such as: Input Source, Picture Size, IP Address, Monitor ID, etc.

Press the DISPLAY button on the remote control to bring up the Information OSD.



Switching Between Picture Modes

Press the PICTURE MODE button on the wireless remote control to cycle through the SpectraView Engine picture modes from 1 to 5.

The picture modes are pre-configured with settings for general use. See [“Advanced Color Adjustment” on page 47](#) for instructions on changing the picture mode settings.

Setting the Aspect Ratio

Press the ASPECT button on the remote control to cycle through the options available for the current input signal.

For MP (Media Player), VIDEO

- FULL → ZOOM → NORMAL



For DVI, DisplayPort1, DisplayPort2, VGA (RGB), OPTION*1, COMPUTE MODULE*2

- FULL → 1:1 → ZOOM → NORMAL



*1: This function depends on which Option Board is installed in the monitor.

*2: This input is available when the optional Raspberry Pi Compute Module Interface Board and Raspberry Pi Compute Module are installed.

For VGA (YPbPr), HDMI1, HDMI2

- FULL → WIDE → DYNAMIC → 1:1 → ZOOM → NORMAL



Aspect ratio of image	Unchanged view*2	Recommended selection for picture aspect*2	Description
4:3		[NORMAL]	Reproduces the aspect ratio that is sent from the source.
		[DYNAMIC]	Expands a 4:3 picture to fill the entire screen with non-linearity. Some of the outside image area will be cut off due to expansion.
Squeeze		[FULL]	Fills the entire screen.
Letterbox		[WIDE]	Expands a 16:9 letter box signal to fill the entire screen.

*2: Gray areas indicate unused portions of the screen.

1:1: Shows the image in a 1 by 1 pixel format.

ZOOM

- The zoom function increases the image size, which expands the image beyond the active screen area. The parts of the image outside the active screen area are not shown.

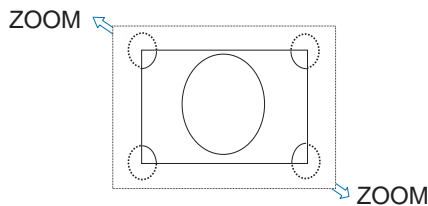

Using Point Zoom



The [POINT ZOOM] function increases the image size and expands it horizontally and vertically simultaneously. The image can be increased up to 10 times its size.

1. Press the SET/POINT ZOOM button on the remote control. A magnifier icon appears on-screen.
2. Move the magnifier to the area of the image you want to focus on by pressing the ▲ ▼ + – buttons.
3. Press the CH/ZOOM+ button to zoom in. Press CH/ZOOM- button to zoom out. When zooming in, the image expands passed the active screen area. The area at the magnifier location shifts closer to the center of the screen at each magnification level.
4. Press the SET/POINT ZOOM button to close the magnifier.
5. The image will remain zoomed in after closing the magnifier. Press the EXIT button to return to the normal image size.

- NOTE:**
- The image may look distorted when using this function.
 - [POINT ZOOM] is not available when the OSD settings are enabled for [IMAGE FLIP] (except for NONE), [MULTI PICTURE MODE], [SCREEN SAVER], [SUPER] in [INPUT CHANGE], [CLOSED CAPTION], [TILE MATRIX] and [TEXT TICKER].
 - When the [ASPECT] setting is [DYNAMIC] or [ZOOM], pressing the POINT ZOOM button automatically sets the [ASPECT] to [FULL] and then starts the [POINT ZOOM] function.
 - After exiting [POINT ZOOM], the [ASPECT] will return to the previous [ASPECT] setting. When the [ASPECT] is changed during the [POINT ZOOM] operation, [DYNAMIC] and [ZOOM] will be set to [FULL].
 - The magnifier icon will not move outside the active picture area.
 - The image returns to the normal size after changing the input signal or when the monitor is powered off.
 - [POINT ZOOM] deactivates if the [ASPECT] changes while using the [POINT ZOOM] function.
 - The [STILL] function is not available when [POINT ZOOM] is active.
 - [POINT ZOOM] is not available with a 3840 x 2160 (60 Hz) DisplayPort signal.
 - When [HDMI] of the [TERMINAL SETTINGS] is set to [MODE2], [POINT ZOOM] is not available.

OSD (On-Screen-Display) Controls

NOTE: Some functions may not be available depending on the model or optional equipment.

Input source: HDMI1

Main Menu Icons: INPUT, PICTURE, AUDIO, SCHEDULE, MULTISOURCE, OSD, MULTIJOB, PROTECT, CONTROL, OPTICAL, SYSTEM, C-MODULE*

Main Menu Item: PICTURE: PICTURE MODE

Sub Menu: EMULATION, 6 AXIS COLOR TRIM, PICTURE SETTINGS, SHARPNESS, UHD UPSCALING, ADJUST, COLOR SYSTEM, INPUT RESOLUTION, ASPECT, ADVANCED, ROTATION, SPECTRAVIEW ENGINE, RESET







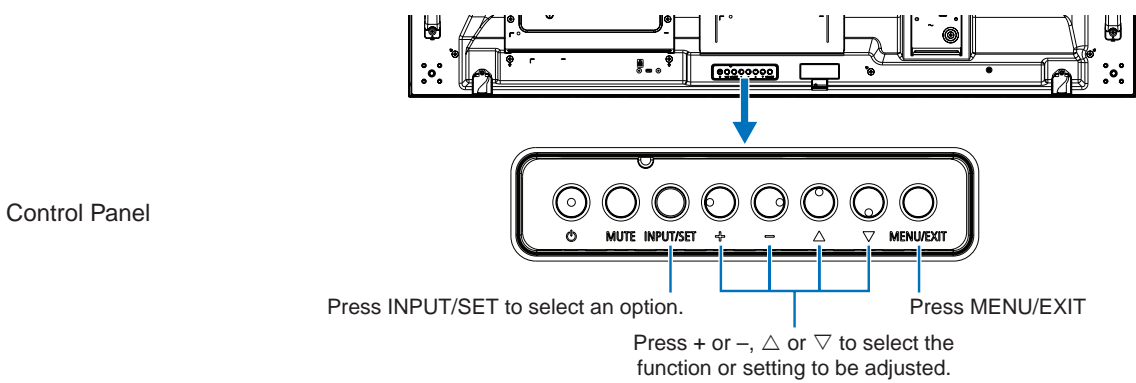
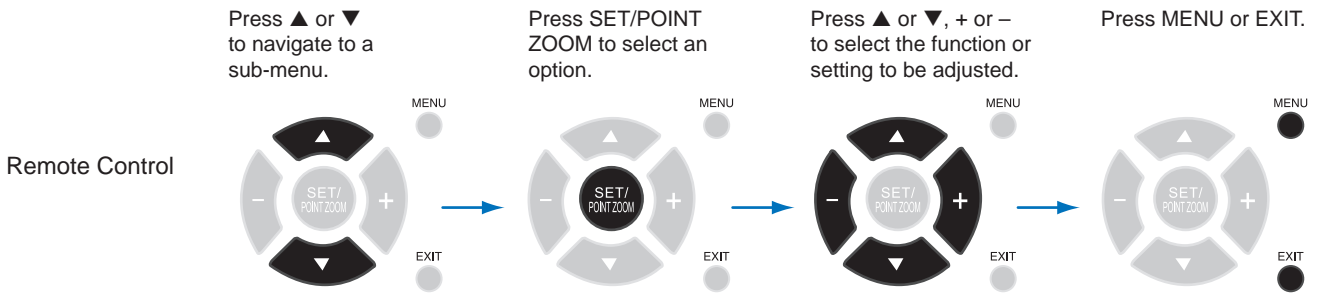





*: This menu is only available when the optional Raspberry Pi Compute Module Interface Board and Raspberry Pi Compute Module are installed.

Adjustment Settings

Key Guide: ▲/▼:Select + :SET/:Goto Adjustment EXIT :Return MENU:Close



Below is a brief summary of where controls are under each menu item. A table listing all options is located in “OSD Controls List” on page 100.

	<p>INPUT: Select the input signal source.</p>
	<p>PICTURE: Select one of the default picture modes, manually adjust the color settings, enable or disable SpectraView Engine, and adjust the aspect ratio, image flip, and rotation.</p>
	<p>AUDIO: Adjust volume, balance, equalizer, input source, and multi-picture mode output.</p>
	<p>SCHEDULE: Create auto power on/off schedules, set holidays and week day/weekend schedules, set the date and time, daylight savings time, and auto-off.</p>
	<p>MULTI-INPUT: Select Picture-In-Picture and Picture-By-Picture settings, signal input detection, and connection terminal settings.</p>
	<p>OSD: Select options related to the on-screen display menu, such as language, the amount of time the OSD stays on-screen, the location of the menu, transparency, rotation, etc.</p>
	<p>MULTI-DISPLAY: Set the monitor’s monitor ID, configure settings for multi-monitor setup.</p>
	<p>PROTECT: Select options related to protecting the monitor hardware, such as configuring the cooling fans, adjusting automatic power save and power on delay, enabling the screen saver and alert mail to be notified when an error occurs in the monitor.</p>
	<p>CONTROL: Set network information, security, power, etc.</p>
	<p>OPTION: Select settings related to an Option Board if installed.</p>
	<p>SYSTEM: View the monitor information (model, serial number, carbon footprint), firmware version, mac address, or perform a factory reset.</p>
	<p>COMPUTE MODULE: This menu is only available when the optional Raspberry Pi Compute Module Interface Board and Raspberry Pi Compute Module are installed. See page 98.</p>

Using the Media Player

The internal Media Player will play image and video files that are stored on a microSD memory card or USB storage device. The Media Player plays videos, still images and background music (BGM). See [page 30](#) for instructions on connecting USB storage device or microSD memory card.

Change to the Media Player by pressing the MEDIA PLAYER button on the optional remote control, or select the MP input in the OSD menu [INPUT].

Use the ▲▼+– and SET/POINT ZOOM buttons on the remote control to navigate the Media Player menus.

Media Player Home Screen

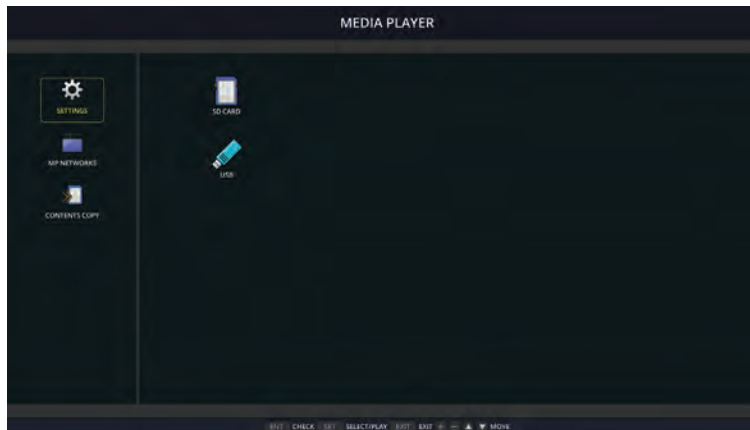

	SETTINGS	Displays the options for configuring the Slideshow, Auto Play, and open the Network Settings screen. See page 63 .
	MP NETWORKS	Displays the options for configuring the Network and Shared Folder settings.
	CONTENTS COPY	Displays the options for copying content to a microSD memory card connected to the monitor.
	SD CARD	Displays the file list for a connected microSD memory card. (This is a color icon when a microSD memory card is connected and the file system can be read. If this icon is gray, the Media Player does not detect, or it is not able to read, a microSD memory card.)
	USB	Displays the file list for a connected USB storage device. (This is a color icon when a USB storage device is connected and the file system can be read. If this icon is gray, the Media Player does not detect, or it is not able to read, a USB storage device.)

- NOTE:**
- If Media Player contents are played while [TILE MATRIX] is active, the image play timing may have a time delay between monitors.
 - If the monitor is used in portrait orientation when playing still image files (pictures), please set [OSD ROTATION] to [PORTRAIT]. Image orientation is changed according to what you set at [OSD ROTATION].
 - If the monitor is used in portrait orientation when playing videos, the videos are not automatically rotated when you set the [OSD ROTATION] to [PORTRAIT]. Please play video files that are rotated anticlockwise 90° for them to be viewed in the correct orientation.
 - A screen will appear when you press one of the monitor control panel buttons while in the Media Player. You can select to control either the OSD menu or the Media Player from the control panel buttons.

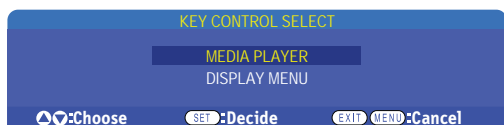









	DISPLAY MENU	This icon appears on the left side of the Media Player home screen after choosing to control the [MEDIA PLAYER] in the [KEY CONTROL SELECT] screen. Navigate to this icon and press INPUT/SET to stop controlling the Media Player from the monitor button controls.
--	--------------	--

File Display Screen



Icon display

	RETURN	Goes back one level higher.
	PAGE UP	Displays the previous set of files in the folder.
	PAGE DOWN	Displays the next set of files in the folder.
	SETTINGS	Shows the settings screen for configuring the Media Player.
	THUMBNAILS/ ICON	Switches between displaying thumbnails or icons for files.
	SORT	Changes the file display order to sort by name (filename), type (file extension), date (date of creation), or size (file capacity). The default sorting order is by "Name".
	EJECT	Unmount the USB storage device or the microSD memory card. Please select EJECT when the file list is displayed.
	ENT Button (remote control)	Select or deselect individual items, such as files to include in the [SLIDESHOW], or a folder to use for [AUTO PLAY] and [PRESET CONTENTS].

- NOTE:**
- A maximum of 300 items can be displayed in a folder, including folder icons.
 - The maximum folder hierarchy that can be shown is 16 levels.
 - Files in which the media type cannot be determined are indicated by a "?" icon.
 - Thumbnails may not be able to be displayed for some media types of media files.

Playing Files

Use the ▲▼ + – and SET/POINT ZOOM buttons on the remote control to navigate the Media Player menus.

1. Select either [SD CARD] or [USB] to view the file list.
2. De-select the files you do not want in the slideshow.







All files in the directory are selected by default. Navigate to a file and press the  button on the remote to deselect it.

3. Navigate to the first file you want to display then press the SET/POINT ZOOM button on the remote control.

This starts the manual slideshow and the selected file will be displayed on-screen. To change the image press the  button on the remote control to display the next file in the directory. The images are displayed in the file sort order.

NOTE: The slideshow can be configured to automatically switch images. See [page 42](#).

Using the Remote Controls

	Skips to the previous video file or image file in the current folder.
	Starts the video or slideshow from the selected file. Resumes the video or slideshow after pause. Resumes the video from rewind or fast forward.
	Skips to the next video file or image file in the current folder.
	Stops the video or slideshow.
	Pauses the video or slideshow.
	Reverses through a video file until the Play, Pause or Stop button is pressed.
	Forwards through a video file until the Play, Pause or Stop button is pressed.

Changing the Side Border Color

The color of the border that appears on the sides of an image, when it does not fill the entire screen, can be changed in the OSD menu settings.



1. Press the MENU button on the remote control to bring up on the OSD menu.
2. Navigate through the OSD menu to [DISPLAY PROTECTION] → [SIDE BORDER COLOR] then press SET/POINT ZOOM button.
3. Move the slider left or right using the + and - buttons on the remote control. The color can be adjusted between 0 (black) and 100 (white).
4. Press EXIT button to close the OSD menu.

Configuring the Slideshow Settings

Use the ▲▼ + – and SET/POINT ZOOM buttons on the remote control to navigate the Media Player menus.

1. Navigate to the SETTINGS icon and press SET/POINT ZOOM button.
2. Navigate to [PLAY MODE] and press SET/POINT ZOOM button.
3. Select [AUTO] and press SET/POINT ZOOM button.
4. Navigate to [INTERVAL] then use the [+] and [-] buttons on the remote to adjust the amount of time an image is displayed before switching.

This setting can be adjusted between 5 and 300 seconds.

5. Configure additional settings as needed.
 - To have the slideshow repeat after the last file in the folder is displayed, press the down arrow and press SET/POINT ZOOM button to select [REPEAT].
 - To have background music play while showing still images, press the down arrow and press SET/POINT ZOOM button to show the audio file screen. Navigate to the location where the audio file is saved, select the audio file you want to play and then press SET/POINT ZOOM button. This will immediately return to the [MEDIA PLAYER SETTINGS] screen.
Press the down arrow and press SET/POINT ZOOM button to select BGM. If BGM does not have a check mark next to it, the audio file you selected will not play.
 - To choose what should happen when the slideshow is not set to [REPEAT], press the down arrow to [PLAY END SCREEN] then press SET/POINT ZOOM button. Highlight the option you want and press SET/POINT ZOOM button.
 - **BLACK SCREEN** – when the last file is played, a black screen is shown until the  button on the remote is pressed.
 - **FILE LIST** – the Media Player returns to the file list screen.
 - **SAVE LAST SCREEN** – the slideshow pauses on the last screen, the image is displayed until the  button on the remote is pressed.
6. Navigate to [OK] and press SET/POINT ZOOM button to save the changes and return to the [MEDIA PLAYER] home screen.

- NOTE:**
- When the slideshow is running, the images are displayed in the files “sorted” order.
If there is a mix of both video files and still image files, the files will still play in the sorted order. The still images will be displayed, when it gets to a video file it will play the video, when the video is done the next still image file will be displayed.
 - If an audio file is playing as background music for still image files, the music will stop when a video file is playing, then start again when it returns to displaying still image files.

Enabling Auto Play

Use the ▲▼ + – and SET/POINT ZOOM buttons on the remote control to navigate the Media Player menus.

1. Navigate to the [SETTINGS] icon and press SET/POINT ZOOM button.
2. Navigate to [AUTO PLAY] and press SET/POINT ZOOM button.
3. Select [SLIDESHOW] and press SET/POINT ZOOM button.

The menu automatically returns to the MEDIA PLAYER SETTINGS screen when pressing SET/POINT ZOOM button on the remote control.

4. Navigate to [FOLDER] and press SET/POINT ZOOM button.
5. Select either [SD CARD] or [USB].

This depends on which device you have connected that contains the slideshow files.

6. Press ENT button the remote control to select the root directory of the microSD memory card or USB storage device.

If the files are in a sub-folder, press SET/POINT ZOOM button on SD CARD or USB, navigate to the folder that contains the slideshow pictures, and then press ENT button on the remote control.

The menu automatically returns to the [MEDIA PLAYER SETTINGS] screen when pressing ENT button on the remote control.

7. Navigate to [OK] and press SET/POINT ZOOM button to save the changes and return to the [MEDIA PLAYER] home screen.

Auto play automatically plays any pictures or videos in the selected folder. The images and videos will be displayed in the "sorted" order.

When [AUTO PLAY] is enabled, the monitor will start auto play as follows:

- When powering on the monitor with a USB storage device or microSD memory card already connected, and Media Player was the input source at the last power off.
- When connecting a USB storage device to the Media Player USB (see [page 30](#)) port, with the monitor already powered ON and the Media Player home screen displayed.
- When inserting a microSD memory card to the microSD card slot (see [page 28](#)), with the monitor already powered ON and the Media Player home screen displayed.

- NOTE:**
- Connecting a USB storage device or microSD memory card with the monitor already powered on is not recommended.
To prevent damage to the monitor and possible corruption of the connected device's data files, the monitor's main power switch should be off before making connections.
 - Only one USB storage device can be recognized with this monitor. External hub is not supported with this monitor.

Displayable/Playable Files

Still Images — Supported formats

File extension	Supported
.jpg, .jpeg, .jpe	Baseline, Progressive, RGB, CMYK
.png	Interlace, a channel

Motion Images — Supported formats

File extension	Video codec	Audio codec
.mpg, .mpeg	MPEG1, MPEG2	MPEG Audio Layer3 (Abbreviation: MP3) AAC-LC (Abbreviation: AAC), LPCM
.wmv	H.264, WMV	MP3, WMV Standard, WMA 9/10 Professional
.mp4	H.264	MP3, AAC
.mov	H.264	MP3, AAC
.flv, .f4v	H.264	MP3, AAC

BGM (Background Music) — Supported formats

File extension	Audio codec
.wav	LPCM
.mp3	MP3

Additional Information

Item	Conditions	
Resolution	JPEG	Up to 5000 x 5000
	PNG	Up to 4000 x 4000
	MPEG1	480@30fps
	MPEG2	MP@ML, MP@HL, 1080p@30fps / 1080i@60fps
	H.264	High profile Lv.4.2, 1080p@30fps / 1080i@60fps
	WMV	Advanced@L3, Simple&Main
Video bit date	-	Up to 15 Mbps
Audio sampling rate	-	Up to 48 kHz
Audio bit rate	MP2	Up to 384 Kbps
	MP3	Up to 320 Kbps
	AAC	Up to 1440 Kbps

- NOTE:**
- Some files may not play correctly even when they meet the conditions listed.
 - Depending on bit date of the file, the type of USB storage device or microSD memory card you use, it may not play correctly.
 - DRM (Digital Right Management) protected files cannot be played.
 - The maximum resolution for video files is 1920 (Horizontal) x 1080 (Vertical).

Chapter 5 **Advanced Operation**

This Chapter Includes:

- ⇒ “Creating a Power Schedule” on page 46
- ⇒ “Advanced Color Adjustment” on page 47
- ⇒ “Multi-Picture Mode” on page 54
- ⇒ “Setting Security and Locking the Monitor Controls” on page 58
- ⇒ “Media Player Settings” on page 62

Creating a Power Schedule

The schedule function allows the monitor to automatically change between power on and standby modes at different times.

To program the schedule:

1. Enter the [SCHEDULE] menu.
 - ① Highlight [SCHEDULE SETTINGS] using the ▲ and ▼ buttons.
 - ② Press the SET/POINT ZOOM or the + button to enter the Settings menu.
 - ③ Highlight the desired schedule number and press SET/POINT ZOOM button.
 - ④ The box next to the number will turn yellow.
The schedule can now be programmed.
 2. Use the ▼ button to highlight the [POWER]. Use the + and - buttons to set [ON].
To set a power off schedule, set [OFF].
 3. Use the ▼ button to highlight the [TIME]. Use the + and – buttons to set the time.
 4. Use the ▲ and ▼ buttons to highlight [INPUT]. Use the + and – buttons to choose the input source.
 5. Use the ▲ and ▼ buttons to highlight [PIC. MODE]. Use the + and – buttons to choose the picture mode.
 6. Use the ▼ button to select [DATE], [EVERY DAY], [EVERY WEEK], [WEEKDAY], [WEEKEND] or [HOLIDAY]. Press the SET/POINT ZOOM button on a menu which is suitable for the schedule.
If the schedule is to be run on a specific day, choose [DATE] and press the SET/POINT ZOOM button.
If the schedule is to be run every day, choose [EVERY DAY] and press the SET/POINT ZOOM button.
If a weekly schedule is desired, choose the days of the week using the ▲ and ▼ buttons and pressing SET/POINT ZOOM button to select. Then highlight the [EVERY WEEK] option and press SET/POINT ZOOM button. Please set [WEEKDAY], [WEEKEND], or [HOLIDAY] in the same manner.
NOTE: The [WEEKDAY], [WEEKEND], and [HOLIDAY] settings are available under the [SCHEDULE] setting (See [page 106](#)).
 7. After a schedule is programmed, the remaining schedules can then be set. Press MENU button to leave the OSD or press EXIT button to go back to the previous menu.
- NOTE:**
- If schedules are overlapping, the schedule with the highest number will have priority over the schedule with the lowest number. For example, schedule #7 will have priority over schedule #1.
 - If a selected input or picture mode is not available now, the disabled input or picture mode is shown in red.

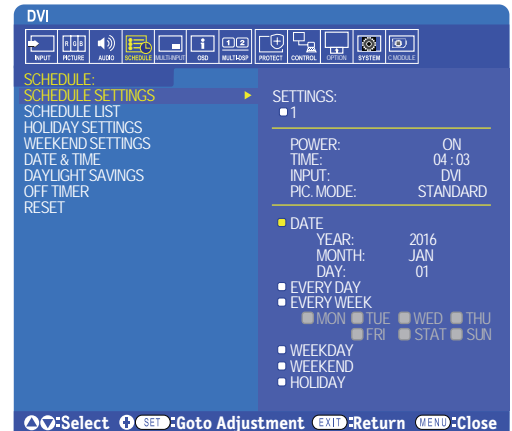

Advanced Color Adjustment

The SpectraView Engine (SVE) is a custom color processor engine integrated in the monitor. It combines individual characterization and calibration of the monitor during production together with temperature and time monitoring, to provide an unparalleled level of color control, accuracy and stability.

Adjustable color uniformity correction is available, utilizing detailed individual factory screen measurements together with the SVE to produce the best possible matching displays.

The SVE provides the utmost in versatility; from faster and more advanced color calibration, to the ability to accurately emulate colorspace such as Adobe®RGB and sRGB, to performing printer output emulations using ICC Profiles and internal 3D Look Up Tables.

The SVE can operate in one of two modes: On or Off

To enable or disable the SpectraView Engine using the remote control:

1. Press the MENU button.
2. Navigate to the [PICTURE] menu then to [SPECTRAVIEW ENGINE].
Use the ▲▼ + – buttons to navigate the OSD menu.
3. Highlight [ON] or [OFF] and press SET/POINT ZOOM to enable or disable the SpectraView Engine.
4. Press EXIT button to return to the main [PICTURE] menu.

Using the SpectraView Engine

When the SVE is on, the monitor's internal processor will handle many of the color management features and the user color controls allow a unique level of precision to be achieved. The white point is adjusted using a CIE x, y control and the grayscale response of the display is calculated and managed by the monitor itself.

The SVE includes Uniformity Correction, where different levels of compensation can be selected to enable a trade-off between the most uniform brightness and color vs. maximum brightness.

The SVE has five Picture Mode memories that can be individually configured and selected. Each individual Picture Mode can store fully customized color settings. This allows you to quickly switch between different settings by just changing between picture modes.

Using the SVE will also give access to other advanced functionality, such as the ability to emulate several modes of human color vision deficiency as well as the ability to select the monitor's output color gamut.

To change the settings in each SVE picture mode:

Presets have been configured with settings for general use as described in the "Preset Types" table next page. When choosing a preset for the SVE picture mode, all of the settings are immediately adjusted to match the preset. Each setting can be individually adjusted to customize as needed.

1. Press the MENU button.
2. Navigate to the [PICTURE] menu then to [PICTURE MODE].
Use the ▲▼ + – buttons to navigate the OSD menu.
3. Press the + button to navigate to the [PICTURE MODE] field.
4. Select a setting from 1 through 5 at [PICTURE MODE].

- 1 → 2 → 3 → 4 → 5
↑

5. Select a preset item at [PRESET].

Choose the [PRESET] that is most suitable for the type of content that is shown or application usage.

Each [PICTURE MODE] includes [LUMINANCE], [BLACK] (Black level), [GAMMA], [WHITE (K)](color temperature), [WHITE (x, y)](White point CIE x, y), [RED] (Red Primary CIE x, y), [GREEN] (Green Primary CIE x, y), and [BLUE] (Blue Primary CIE x, y), settings. You can change these settings in the “Picture Mode” menu.

If any settings need to be changed, press the ▼ button to navigate through the settings and make any adjustments needed using the + – buttons.

6. Press EXIT button to return to the main [PICTURE] menu.

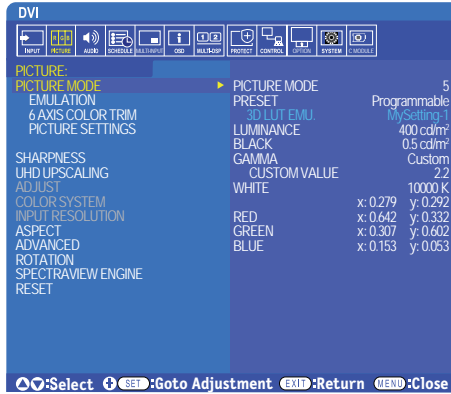

NOTE:

- Changing the settings in the [PICTURE MODE] menu does not change the default settings for the [PRESET].
- “*” mark is shown if the Picture Mode settings have been changed from the default preset settings.

Preset Types

PRESET	PURPOSE
sRGB	The standard color setting of the Internet, Windows® operating systems, and many smart-phone and other digital cameras. Recommended setting for general color management.
AdobeRGB	Wider color gamut setting used in high-end graphics applications such as professional digital still cameras and printing.
eciRGB_v2	Color setting recommended by Europe printing group, ECI (The European Color Initiative).
DCI-P3	Color setting for digital cinema.
Rec.709	Color setting for High-definition television.
Rec.2100 (HLG)	Color setting for HDR (High Dynamic Range) broadcasting.
Rec.2100 (PQ)	Color setting for HDR (High Dynamic Range) digital cinema on disc and internet streaming.
Low Blue	Reduces blue light emitted from the monitor. Paper-like color setting. (The Low Blue function substantially reduces blue light and helps to alleviate eye-strain.)
Signage	Color setting for use in digital signage applications with high ambient lighting conditions where a bright and high color temperature white point may be desirable.
TV Studio	Color setting for use with “on set shooting” where the monitor’s screen will be captured by the camera and should match the studio set’s incandescent lighting.
Full	Native LCD panel color gamut. Suitable for use with color managed applications.
DICOM sim.	Color setting for medical imaging that conforms to DICOM GSDF (Grayscale Standard Display Function).
Programmable	Programmable preset for MultiProfiler and other supported software. The preset name can be changed by software.

SpectraView Settings

SVE SETTINGS	PURPOSE
LUMINANCE	Adjusts the overall image and screen background luminance. When the setting is too high to display, the OSD characters are changed to green.
BLACK	Adjusts the black luminance. When the setting is too low to display, the OSD characters are changed to green.
GAMMA	Allows you to manually select the brightness level of grayscale.
	sRGB: Gamma setting for sRGB.
	L Star: Gamma setting for the CIELAB color space Lab.
	Rec.1886: Gamma setting for HDTV broadcasting.
	HDR-Hybrid Log: Gamma setting for HDR, typically for UHD broadcasting. System gamma can be adjusted. SYSTEM GAMMA: System gamma is adjustable in 0.5-2.0 range. When "Auto" is selected, the system gamma is automatically selected according to the "Luminance" setting.
	HDR-ST2084 (PQ): Gamma setting for HDR, typically for UHD disk media and streaming videos. Peak luminance value is adjustable. PEAK LUMI.: Sets the peak luminance value to display HDR-ST2084 (PQ) luminance range. A larger value will improve white saturation but the picture become darker. When "Auto" is selected, "Luminance" is used as the peak luminance setting.
	DICOM: DICOM GSDF (Grayscale Standard Display Function) is typically used for medical imaging.
	Programmable: A programmable gamma curve can be loaded using optional NEC software.
	Custom: Set a custom value for Peak luminance. CUSTOM VALUE: The gamma value is selected from a range from 0.5 to 4.0 in 0.1 steps. For general images 2.2 is used. Increasing the value will make the intermediate color darker, and lowering the value will make the intermediate color brighter.
	<p>SAMPLE OF PRESET GAMMA</p>
WHITE (K)	Adjusts the white by color temperature (K) or CIE x, y setting. A lower color temperature will result in a reddish screen and a higher color temperature in a bluish screen. A larger x value will result in a reddish screen, a larger y value changes the screen to greenish, and smaller x,y values will change the screen to bluish white.
WHITE (x, y)	
<p>WHITE RANGE</p>	

SVE SETTINGS	PURPOSE
RED (x,y) GREEN (x,y) BLUE (x,y)	Adjusts the color gamut. Set chromaticity with CIE x, y coordinates. It affects all colors except achromatic like white and gray. <div data-bbox="359 280 790 716" style="border: 1px solid black; padding: 5px; margin: 10px 0;"> <p style="text-align: center;">SAMPLE OF RGB GAMUT SETTING</p> </div>

- NOTE:**
- Settings for [EMULATION], [6 AXIS COLOR TRIM], and [PICTURE SETTING] are also stored to each [PICTURE MODE].
 - If the ICC Profile on your computer doesn't match the monitor's settings then color reproduction may be inaccurate.
 - For detailed color settings and to set the ICC profile on your computer automatically, MultiProfiler software is recommended. Connecting PC and the monitor with a USB cable is recommended. See [page 98](#).

Using Stand-alone calibration

This feature performs color calibration of the monitor without using an external computer or software. This is useful for color matching a small number of monitors quickly. It also updates the factory color measurement data used by the monitor's internal SpectraView Engine (SVE) color processor.

Updating the factory color data with measurements taken from a color sensor results in color related settings, shown on the OSD, closely matching measurements from the color sensor. In effect, the color sensor's measurements become the new reference for all of the SVE's internal color calculations. All color presets in the monitor automatically update to use the new reference.

Requirements for Stand Alone Calibration:

- NEC MDSVSENSOR3 color sensor. This sensor connects directly to the USB1 (SENSOR) port on the monitor. The monitor automatically takes screen measurements directly from the color sensor. See Appendix A for purchase and availability information.
- Or
- A near-range colorimeter with a measurement readout display in CIE Y/x, y format with Y in units of cd/m². Measurements are taken manually and each reading must be entered into the monitor via the OSD using the remote control. [VALIDATION] and [WHITE COPY] are not available.

NOTE: Other color sensor models and types are not supported.

- NOTE:**
- For best calibration results, it is recommended the monitor be allowed to warm up for at least 30 minutes before starting the calibration or measurement process.
 - It is not necessary to recalibrate the other Picture Modes in the monitor after performing the Self Calibration. Updating the monitor's internal reference automatically updates all color settings.
 - The original factory measurements can be restored at any time.
 - Access to each monitor's USB1 (SENSOR) port is necessary to use this feature with the NEC MDSVSENSOR3 color sensor. Be sure to provide adequate access when installing the monitors.
 - Differences between the factory color measurements and those taken with a color sensor are to be expected. Differences can be due to many factors, such as variations between color sensor measurement technologies and device calibration and drift, measurement position on the screen, and video signal differences.
 - For color matching and managing a large number of monitors, the NEC Display Wall Calibrator software is recommended. See Appendix A for details.
 - To open Stand Alone Calibration OSD menu, select Calibration (see [page 105](#)) on the OSD. Please make sure [SPECTRAVIEW ENGINE] is [ON] (see [page 105](#)).

To open the STAND-ALONE CALIBRATION window using the remote control:

1. Press the MENU button.
2. Navigate to the [PICTURE] menu then to [SPECTRAVIEW ENGINE].
Use the ▲▼ + – buttons to navigate the OSD menu.
3. Highlight [ON] and press SET/POINT ZOOM button to enable the SpectraView Engine.
4. Navigate to [CALIBRATION] then press SET/POINT ZOOM button. The STAND-ALONE CALIBRATION window appears.
5. Highlight a menu then press SET/POINT ZOOM button.
6. Press the EXIT button to close the OSD window.

Follow the instructions on the OSD message.

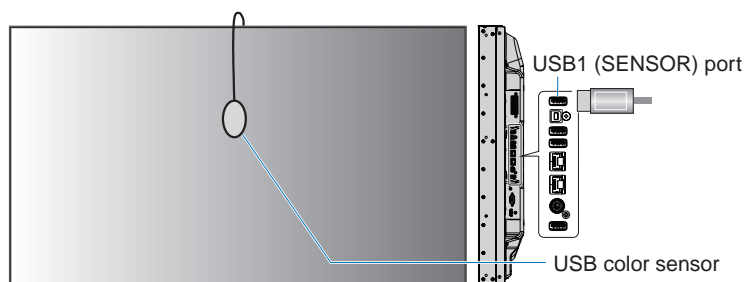
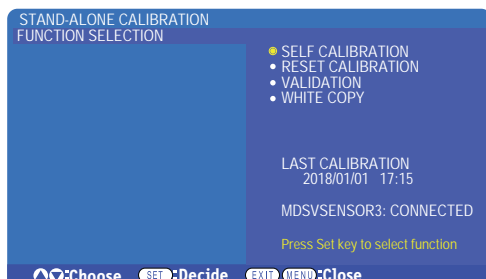

Self calibration

This function updates the monitor's internal SpectraView Engine color processor to use measurements taken using a supported color sensor device. These measurements will become the reference for all color settings in the monitor.

When an NEC MDSVSENSOR3 color sensor is connected to the monitor's USB1 (SENSOR) port, the monitor takes measurements and is calibrated automatically. Place the color sensor at the center of the screen and follow the messages displayed.

Otherwise, if using a near-range colorimeter device, measurements must be taken manually with the device and the CIE Y/x/y values individually entered via the OSD using the remote control. Y is in units of cd/m^2 .

Depending on the monitor usage and other factors, performing a Self Calibration at least once per year is recommended.

Reset calibration

This deletes the color measurement data created by the Self Calibration function and returns to the original factory internal reference color measurement data. All Picture Modes will automatically be updated. If you are using NEC display Wall Calibrator, uniformity adjustment data is also deleted.

Validation*

This can be used to determine if the Self Calibration operation should be performed.

It compares measurements taken of various color patches on the screen by the color sensor with the expected values calculated by the SVE, which uses the current internal reference color measurement data. The result of this comparison is indicated as an average color difference (dE) value. Larger values mean there is a larger difference between the measurements and the internal reference. If the dE value is higher than 3.0, Self Calibration is recommended to update the internal reference color data.

*: The Self Calibration function must have been previously performed before this function is available on the OSD menu.

- NOTE:**
- [Self calibration], [Validation] and [WHITE COPY] are not available if the source HDMI signal resolution is 3840 x 2160 (60 Hz).
 - The date and time stamped results of the "Self calibration" and "Validation" functions are stored in the monitor and can be read by software on your computer. Setting the [SCHEDULE] → [DATE & TIME] in OSD menu is required for this function.

White copy*

This function can be used to “copy” the luminance and white point from another monitor when used in a multi-monitor installation. This process is done by measuring the color of a monitor and setting those measured values into the monitor being adjusted. This can be useful in situations where it is necessary to match a monitor in color to neighboring monitors without having to recalibrate all monitors.

Before starting, it is necessary to input a full-white video signal to all of the monitors. Select the monitor that will be used as the Target – or source - of the copy operation (A).

This function will measure the luminance and white point of the target monitor (A), and set these values to the current Picture Mode of the destination monitor (B).

You can also fine-tune the measurement result while checking the screen color. If you want to return to the measured value, select re-measurement.

*: The Self Calibration function must have been previously performed before this function is available on the OSD menu.

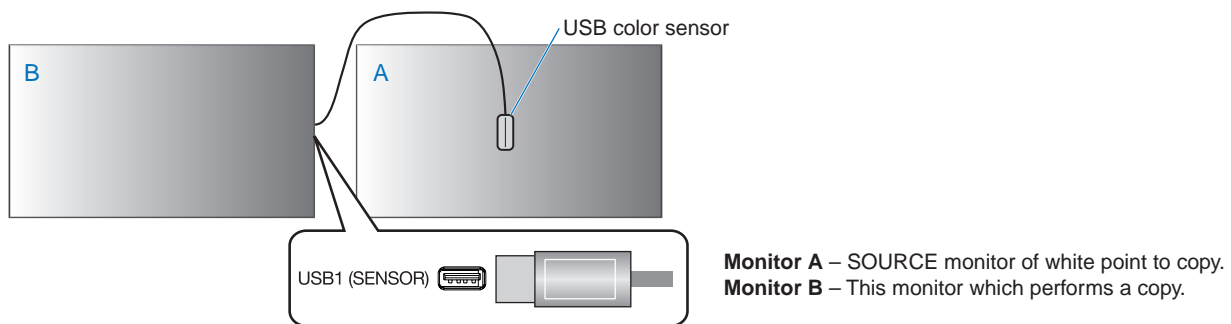

NOTE: When adjusting the color of multiple displays, we recommend that you perform [SELF CALIBRATION] from [WHITE COPY].

Using Other Picture Modes

When the SpectraView Engine is off, the white point can be adjusted using familiar red, green and blue level controls. To turn SpectraView Engine off, see [page 47](#) for instructions.

There are different picture modes available when the SpectraView Engine is off. These picture modes have also been configured with settings for general use as described in the “[Picture Mode Types](#)” table below.

To change picture modes:

Press the PICTURE MODE button on the wireless remote control to cycle through the modes, or select the mode in the [PICTURE] list in the OSD menu.

These picture modes are available based on the selected input:

- For [DVI], [DisplayPort1], [DisplayPort2], [OPTION*¹], [VGA (RGB)], [HDMI1], [HDMI2], [COMPUTE MODULE*²]

STANDARD → sRGB → CINEMA → CUSTOM1 → CUSTOM2 → HIGHBRIGHT



*¹: This function depends on which Option Board is installed in the monitor.

*²: This input is available when the optional Raspberry Pi Compute Module Interface Board and Raspberry Pi Compute Module are installed. See [page 98](#).

- For [VGA (YPbPr)], [VIDEO], [MP]

STANDARD → CINEMA → CUSTOM1 → CUSTOM2 → HIGHBRIGHT



Picture Mode Types

PICTURE MODE	PURPOSE
HIGH BRIGHT	Highest brightness setting.
STANDARD	Standard setting.
sRGB	The standard color space used for the Internet, Windows® operating systems and digital cameras. Recommended setting for general color management.
CINEMA	A setting that boosts dark tones; best suited for movies.
CUSTOM	Custom setting.

NOTE: Changing any of the settings of the [PICTURE] in the OSD menu will change the settings for the current input only.

Multi-Picture Mode

Multi-Picture mode lets you see video input from two different sources. The secondary input can be viewed in a inset window on the main video (Picture-In-Picture), or the two inputs can be viewed next to each other (Picture-By-Picture).

The instructions in this section guide you through configuring Multi-Picture Mode in the monitor's OSD menu. These settings can also be configured using the monitor's web controls. The function names and location in the web controls are the same as the OSD menu. See [page 83](#).

To enable multi-picture mode:

1. Press the MENU button on the remote control to bring up on the On Screen Display (OSD).
2. Navigate through the OSD menu to [MULTI-INPUT] → [MULTI PICTURE MODE], select [ON], and then choose either [PIP] or [PBP].

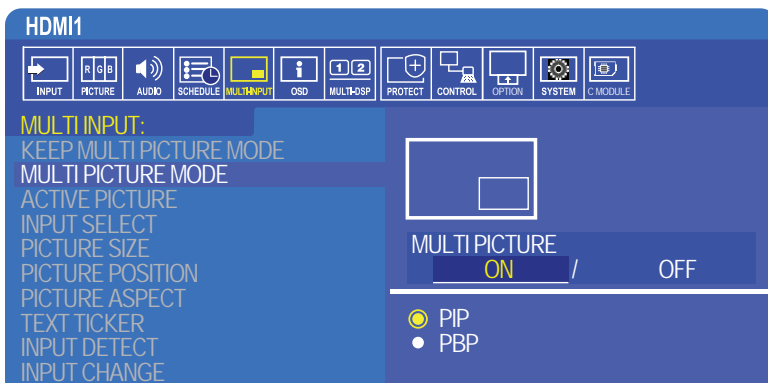

- **PIP (Picture-In-Picture)** — select this option to have a second input viewed in a subset window.
- **PBP (Picture-By-Picture)** — select this option to have the two inputs viewed next to each other.

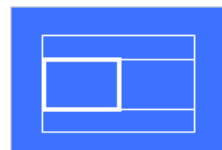

PIP (Picture-In-Picture) settings:

1. Navigate to [INPUT SELECT] on the OSD.
 - Select an input source for Picture1 (main input) and Picture2 (secondary input).
2. Navigate to [ACTIVE PICTURE] on the OSD.
 - Change the Active Picture to [PICTURE2].

The Picture Size, Position, and Aspect functions are for configuring the settings of the sub-picture window (Picture2). They will remain disabled as long as [PICTURE1] is the active picture.
 - Active Frame is the red frame shown around the currently selected Active Picture area when the OSD menu is open. This frame can be turned on or off on this menu. When multi-picture mode is enabled, the red frame makes it easy to see which picture is active when making changes in other areas of the Multi-Input OSD menu.
3. You can now adjust the settings for sub-picture window.
 - **Picture Size** — use the + or – remote control buttons to increase or reduce the size of the sub-picture.
 - **Picture Position** — use the + or – remote control buttons to move the sub-picture window.
 - **Picture Aspect** — adjust the aspect ratio for the sub-picture window.

PBP (Picture-By-Picture) settings:

1. Navigate to [INPUT SELECT] on the OSD.
 - Select an input source for [PICTURE1] and [PICTURE2].
2. Navigate to [ACTIVE PICTURE] on the OSD.
 - Select either [PICTURE1] or [PICTURE2].
The Picture Size, Position, and Aspect functions are configured separately for each input.
 - Active Frame is the red frame shown around the currently selected Active Picture area when the OSD menu is open. This frame can be turned on or off on this menu. When multi-picture mode is enabled, the red frame makes it easy to see which picture is active when making changes in other areas of the Multi-Input OSD menu.
3. You can now adjust the settings for each window.
 - **Picture Size** — use the + or – remote control buttons to increase or reduce the size of the active picture window.
 - **Picture Position** — use the + or – remote control buttons to move the active picture window.
 - **Picture Aspect** — adjust the aspect ratio for the active picture window.

Additional settings in the Multi-Input OSD menu:

Keep Multi-Picture Mode — select this option to have the monitor remain in Multi-Picture mode and Text Ticker mode after powering off.

Text Ticker — select either Horizontal or Vertical to enable this option. When enabled, a portion of the secondary input will be displayed either horizontally or vertically across the screen. This area can be used to display video from the second video input source, for example, as a text ticker application.

The position and amount (size) of where the secondary video is displayed can be adjusted. The top or left side of the secondary input video signal is used as the source of the video displayed.

- **Position** — use the + or – remote control buttons to move where the secondary input appears on the screen.
- **Size** — use the + or – remote control buttons to increase or reduce the size of the text ticker area.
The Text Ticker function displays the top portion of the second source. Adjusting the size of the Text Ticker area adjusts how much of the top or left portion of the second source is displayed.
- **Detect** — automatically turns the Text Ticker function on and off based on the presence of the secondary video signal.
- **Input Select** — the input signal for the primary [PICTURE1] and secondary [PICTURE2] sources.

Input Detect — select one of the functions to enable automatic detection of input signal.

- **First Detect** — when the monitor does not detect video signal on the current input, it will search for video signals on the other inputs and switch to the first active video signal it detects.
- **Last Detect** — when the monitor is currently displaying an active video signal and a new secondary source is detected, the monitor automatically switches to the new video source. If there is no current input signal, it will search for video signals on the other inputs and switch to the first active video signal it detects.
- **Custom Detect** — select this option and then choose an input source for each of the options. The monitor will only search for active signal on the selected video inputs. This is useful for “failsafe” applications when a backup video signal is used only if the primary video signal source disappears.

Input Change — this option changes the speed at which the monitor changes to a different video input.

When a cable is connected to the HDMI OUT port, speed of changing input may not be faster.

When a cable is connected to the HDMI OUT port, if [QUICK] or [SUPER] is set, this setting causes image distorted while switching signals.

- **Quick** — this option switches faster than Normal (default) but there may be image noise when switching signals. When you set QUICK then change input signal to DisplayPort, displaying image is distorted.
- **Super** — select this option and then choose the video signal for INPUT1 and INPUT2. The video signal between these two inputs.

Terminal Setting — the options in this section are for configuring settings specific to the type of signal input. Please see to “[TERMINAL SETTINGS](#)” on page 110 in the “[Appendix B OSD Controls List](#)” tables.

PIP (Picture-In-Picture) matrix

The combination of input connections that can be used for PIP and PBP configuration are limited. If you do not see the input you want to use for the sub picture, refer to the tables below to see if your inputs configuration is supported.

DisplayPort = 1.1a/HDMI = MODE1

		Sub picture												
		DisplayPort1	DisplayPort2	DVI	HDMI1	HDMI2	VGA (RGB)	VGA (YPbPr)	Video	OPTION		MP		
		Connector	DisplayPort1 (DAISY CHAIN IN)	DisplayPort2	DVI-D	HDMI1 (DAISY CHAIN IN)	HDMI2 (CEC)	VGA (RGB, YPbPr)		VIDEO	Option Board Slot (SLOT2 (DP))	Option Board Slot (SLOT2 (HDMI))	-	
Main picture	DisplayPort1	DisplayPort1 (DAISY CHAIN IN)	Yes	Yes	Yes	Yes	Yes	Yes	Yes	Yes	No	Yes	Yes	
	DisplayPort2	DisplayPort2	Yes	Yes	Yes	Yes	Yes	Yes	Yes	Yes	Yes	Yes	Yes	
	DVI	DVI-D	Yes	Yes	Yes	No	Yes	Yes	Yes	No	Yes	No	No	
	HDMI1	HDMI1 (DAISY CHAIN IN)	Yes	Yes	No	Yes	Yes	Yes	Yes	No	Yes	No	No	
	HDMI2	HDMI2 (CEC)	Yes	Yes	Yes	Yes	Yes	Yes	Yes	Yes	Yes	Yes	Yes	
	VGA (RGB)	VGA (RGB, YPbPr)	Yes	Yes	Yes	Yes	Yes	Yes	No	Yes	Yes	Yes	Yes	
	VGA (YPbPr)		Yes	Yes	Yes	Yes	Yes	No	Yes	Yes	Yes	Yes	Yes	
	VIDEO	VIDEO	Yes	Yes	No	No	Yes	Yes	Yes	Yes	Yes	No	No	
	OPTION	Option Board Slot (SLOT2 (DP))	No	Yes	Yes	Yes	Yes	Yes	Yes	Yes	Yes	Yes	Yes	Yes
		Option Board Slot (SLOT2 (HDMI))	Yes	Yes	No	No	Yes	Yes	Yes	No	Yes	Yes	No	No
MP	-	Yes	Yes	No	No	Yes	Yes	Yes	No	Yes	No	Yes		

DisplayPort = 1.1a/HDMI = MODE2

		Sub picture												
		DisplayPort1	DisplayPort2	DVI	HDMI1	HDMI2	VGA (RGB)	VGA (YPbPr)	Video	OPTION		MP		
		Connector	DisplayPort1 (DAISY CHAIN IN)	DisplayPort2	DVI-D	HDMI1 (DAISY CHAIN IN)	HDMI2 (CEC)	VGA (RGB, YPbPr)		VIDEO	Option Board Slot (SLOT2 (DP))	Option Board Slot (SLOT2 (HDMI))	-	
Main picture	DisplayPort1	DisplayPort1 (DAISY CHAIN IN)	Yes	Yes	Yes	No	No	Yes	Yes	Yes	No	No	Yes	
	DisplayPort2	DisplayPort2	Yes	Yes	Yes	No	No	Yes	Yes	Yes	Yes	No	Yes	
	DVI	DVI-D	Yes	Yes	Yes	No	No	Yes	Yes	No	Yes	No	No	
	HDMI1	HDMI1 (DAISY CHAIN IN)	No	No	No	No	No	No	No	No	No	No	No	
	HDMI2	HDMI2 (CEC)	No	No	No	No	No	No	No	No	No	No	No	
	VGA (RGB)	VGA (RGB, YPbPr)	Yes	Yes	Yes	No	No	Yes	No	Yes	Yes	No	Yes	
	VGA (YPbPr)		Yes	Yes	Yes	No	No	No	Yes	Yes	Yes	No	Yes	
	VIDEO	VIDEO	Yes	Yes	No	No	No	Yes	Yes	Yes	Yes	No	No	
	OPTION	Option Board Slot (SLOT2 (DP))	No	Yes	Yes	No	No	Yes	Yes	Yes	Yes	Yes	No	Yes
		Option Board Slot (SLOT2 (HDMI))	No	No	No	No	No	No	No	No	No	No	No	No
MP	-	Yes	Yes	No	No	No	Yes	Yes	No	Yes	No	Yes		

DisplayPort = 1.2/HDMI = MODE1

		Sub picture											
		DisplayPort1	DisplayPort2	DVI	HDMI1	HDMI2	VGA (RGB)	VGA (YPbPr)	Video	OPTION		MP	
Main picture	Connector	DisplayPort1 (DAISY CHAIN IN)	DisplayPort2	DVI-D	HDMI1 (DAISY CHAIN IN)	HDMI2 (CEC)	VGA (RGB, YPbPr)		VIDEO	Option Board Slot (SLOT2 (DP))	Option Board Slot (SLOT2 (HDMI))	-	
	DisplayPort1	DisplayPort1 (DAISY CHAIN IN)	No	No	No	No	No	No	No	No	No	No	No
	DisplayPort2	DisplayPort2	No	No	No	No	No	No	No	No	No	No	No
	DVI	DVI-D	No	No	Yes	No	Yes	Yes	Yes	No	No	No	No
	HDMI1	HDMI1 (DAISY CHAIN IN)	No	No	No	Yes	Yes	Yes	Yes	No	No	No	No
	HDMI2	HDMI2 (CEC)	No	No	Yes	Yes	Yes	Yes	Yes	Yes	No	Yes	Yes
	VGA (RGB)	VGA (RGB, YPbPr)	No	No	Yes	Yes	Yes	No	No	Yes	No	Yes	Yes
	VGA (YPbPr)		No	No	Yes	Yes	Yes	Yes	Yes	Yes	No	Yes	Yes
	VIDEO	VIDEO	No	No	No	No	Yes	Yes	Yes	Yes	No	No	No
	OPTION	Option Board Slot (SLOT2 (DP))	No	No	No	No	No	No	No	No	No	No	No
		Option Board Slot (SLOT2 (HDMI))	No	No	No	No	Yes	Yes	Yes	No	No	No	No
MP	-	No	No	No	No	Yes	Yes	Yes	No	No	No	Yes	

DisplayPort = 1.2/HDMI = MODE2

		Sub picture											
		DisplayPort1	DisplayPort2	DVI	HDMI1	HDMI2	VGA (RGB)	VGA (YPbPr)	Video	OPTION		MP	
Main picture	Connector	DisplayPort1 (DAISY CHAIN IN)	DisplayPort2	DVI-D	HDMI1 (DAISY CHAIN IN)	HDMI2 (CEC)	VGA (RGB, YPbPr)		VIDEO	Option Board Slot (SLOT2 (DP))	Option Board Slot (SLOT2 (HDMI))	-	
	DisplayPort1	DisplayPort1 (DAISY CHAIN IN)	No	No	No	No	No	No	No	No	No	No	No
	DisplayPort2	DisplayPort2	No	No	No	No	No	No	No	No	No	No	No
	DVI	DVI-D	No	No	Yes	No	No	Yes	Yes	No	No	No	No
	HDMI1	HDMI1 (DAISY CHAIN IN)	No	No	No	No	No	No	No	No	No	No	No
	HDMI2	HDMI2 (CEC)	No	No	No	No	No	No	No	No	No	No	No
	VGA (RGB)	VGA (RGB, YPbPr)	No	No	Yes	No	No	Yes	No	Yes	No	No	Yes
	VGA (YPbPr)		No	No	Yes	No	No	No	Yes	Yes	No	No	Yes
	VIDEO	VIDEO	No	No	No	No	No	Yes	Yes	Yes	No	No	No
	OPTION	Option Board Slot (SLOT2 (DP))	No	No	No	No	No	No	No	No	No	No	No
		Option Board Slot (SLOT2 (HDMI))	No	No	No	No	No	No	No	No	No	No	No
MP	-	No	No	No	No	No	Yes	Yes	No	No	No	Yes	

Setting Security and Locking the Monitor Controls

Under normal operation, the monitor can be controlled by any person using the remote control or the monitor control panel. You can prevent unauthorized use and changes to the monitor settings by enabling the options for Security and Lock Settings.

The security and locking functions covered in this section are:

- Setting the password
- Enabling password security
- Locking the remote control buttons
- Locking the monitor Control Panel buttons

NOTE: The instructions in this section describe locking access to the display controls. Other security settings available for this monitor are described in the related sections for those controls:

- “Shared SD Card Settings” on page 63 for the Media Player.
- “Network Settings” on page 84 for the monitor’s web controls.

Settings Location

The instructions in this section guide you through configuring security and locking functions in the monitor’s OSD menu. These settings can also be configured using the monitor’s web controls. The function names and location in the web controls are the same as the OSD menu. See [page 83](#).

The menu options for Security and Lock Settings are in the [CONTROL] menu in both the OSD menu and web controls.

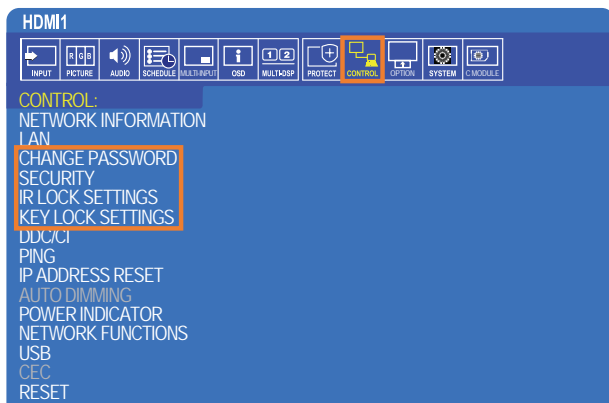

Password Security

When password security is enabled a 4-digit passcode is required when turning on the main power and/or accessing the OSD (see [page 59](#)). The monitor will function normally after the password is entered. If no buttons have been pressed for 30 seconds, the monitor will return to SECURE MODE automatically and the password will be required again.

NOTE: If you change the password make note of the password in a secure location. If the wrong code is entered three times access to the OSD menu will be locked; you will need to contact technical support to get a recovery password to access the monitor OSD menu.

Set a password for the monitor

This step is only required if you want to change the password.

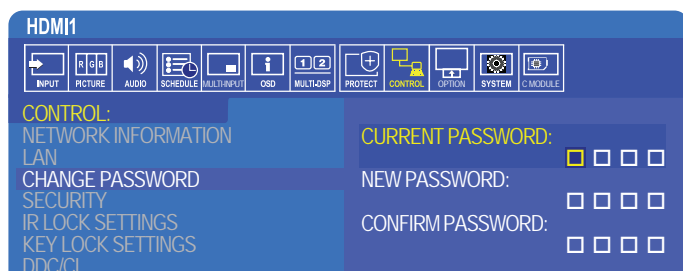

1. Using the remote control navigate to [CONTROL] then to [CHANGE PASSWORD].
2. Enter the password in the [CURRENT PASSWORD] field. (The default password is: 0 0 0 0).
3. Input a [NEW PASSWORD] and then input it again in the [CONFIRM PASSWORD] field.
4. The new password is immediately saved.

Enable password security

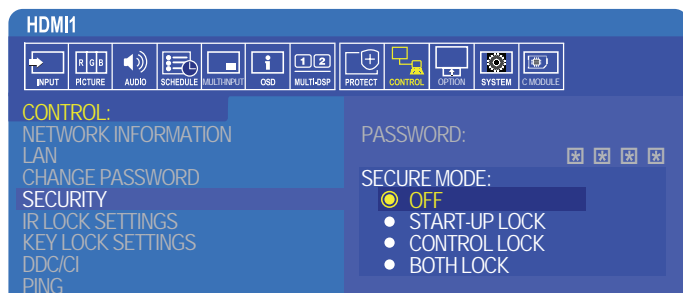

1. Using the remote control navigate to [CONTROL] then to [SECURITY].
2. Enter the password in the [PASSWORD] field to access the [SECURE MODE] settings.
3. Select the type of [SECURE MODE] you want to use:
 - **[OFF]** – no password is required
 - **[START-UP LOCK]** – the password is required when turning on the monitor from the main power switch.
When this option is selected the password is only required on power cycle using the main power switch or after power failure. This option does not prompt for a password when using the remote control POWER ON and STANDBY buttons or the  button on the monitor control panel.
 - **[CONTROL LOCK]** – the password is required to use any of the remote control buttons or buttons on the monitor.
 - **[BOTH LOCK]** – the password is required for both start-up and control.
4. The selections are automatically saved.

Locking the Button Controls

The lock settings prevent the monitor from responding to button presses on the IR remote control or monitor control panel. When locking the button controls, some buttons can be configured to remain unlocked for users to adjust the settings. Locking and unlocking the button controls do not require a password.

Locking the IR Remote Buttons

The [IR LOCK SETTINGS] prevent the monitor from being controlled using the remote control. Enabling the [IR LOCK SETTINGS] does not lock the buttons the monitor control panel.

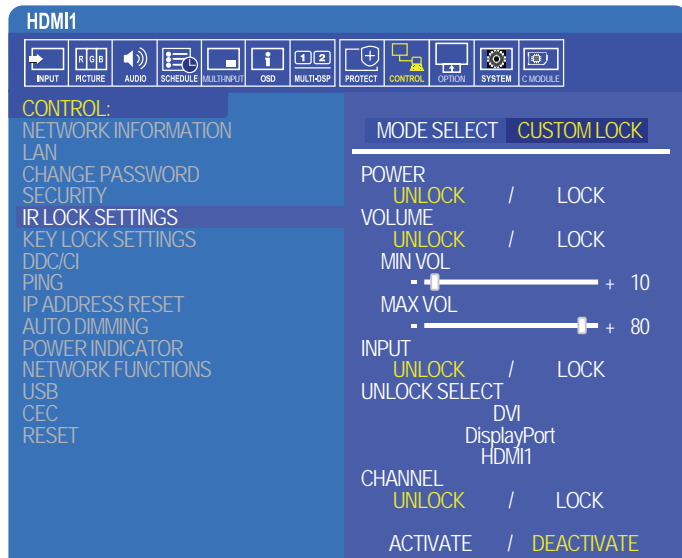

- Using the remote control navigate to [CONTROL] then to [IR LOCK SETTINGS].
- Under [MODE SELECT] choose the lock mode you want to enable.
 - [LOCK ALL]** – all buttons are locked.
 - [CUSTOM LOCK]** – all remote buttons are locked except for the following buttons that can be individually set as locked or unlocked.
 - [POWER]** – select [UNLOCK] to be able to use the  button when the IR Remote is locked. Select [LOCK] to lock the button.
 - [VOLUME]** – select [UNLOCK] to be able to control the volume with the VOL+, VOL- buttons when the IR Remote is locked. Select LOCK to prevent volume adjustment.

When activating the volume lock, the display volume will immediately change to the MIN VOL value.
 - [MIN VOL]** and **[MAX VOL]** – the volume buttons are unlocked, and the volume level can only be adjusted within the [MIN] and [MAX] range set.

The [VOLUME] must be set to [UNLOCK] for this setting to operate.
 - [INPUT]** – select [UNLOCK] and then select up to 3 input buttons to remain unlocked. Select [LOCK] to lock all input buttons.
 - [CHANNEL]** – select [UNLOCK] to be able to change channels with the CH/ZOOM+, CH/ZOOM- buttons when the IR remote is locked. Select [LOCK] to lock these buttons.

An optional tuner card must be installed for the channel buttons to function.
- Select [ACTIVATE] to activate all settings.

Unlocking the IR Remote Controls

- IR Remote Control – to return to normal operation press-and-hold the DISPLAY button for at least 6 seconds.

Locking the Control Panel Buttons

The [KEY LOCK SETTINGS] prevent the monitor from being controlled using the buttons on the monitor Control Panel. Enabling the [KEY LOCK SETTINGS] does not lock the buttons on the remote control.

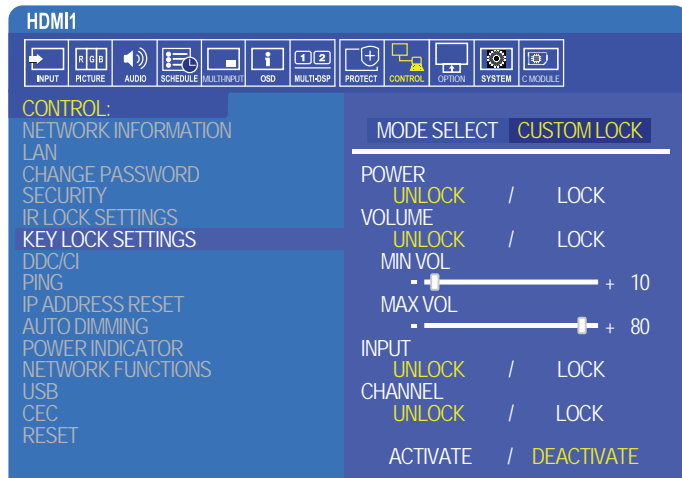

- Using the remote control navigate to [CONTROL] then to [KEY LOCK SETTINGS].
- Under [MODE SELECT] choose the lock mode you want to enable.
 - [LOCK ALL]** – all key buttons are locked.
 - [CUSTOM LOCK]** – all key buttons are locked except for the following buttons that can be individually set to be locked or unlocked.
 - [POWER]** – select [UNLOCK] to be able to use the  button when the keys are locked.
 - [VOLUME]** – select [UNLOCK] to be able to control the volume with the + and – buttons when the keys are locked. Select [LOCK] to prevent volume adjustment.

When activating the volume lock, the display volume will immediately change to the [MIN VOL] value.
 - [MIN VOL]** and **[MAX VOL]** – the [+] and [-] volume keys are unlocked and the volume can only be adjusted within the [MIN] and [MAX] set.

The [VOLUME] must be set to [UNLOCK] for this setting to operate.
 - [INPUT]** – select [UNLOCK] to be able to change the inputs using the INPUT/SET button.
 - [CHANNEL]** – select [UNLOCK] to be able to use the ▲/▼ buttons.
- Select [ACTIVATE] to activate all settings.

Unlocking the Monitor Button Panel Controls

Key Buttons – to return to normal operation press the ▲ and ▼ buttons on the display control panel simultaneously, for at least 4 seconds, to deactivate the key lock settings.

OSD Menu – to return to normal operation, use the remote control to navigate to [CONTROL] then to [KEY LOCK SETTINGS]. Under [MODE SELECT] choose [UNLOCK] and then select [ACTIVATE].

Media Player Settings

Change to the Media Player by pressing the MEDIA PLAYER button on the optional remote control, or select the MP input in the OSD INPUT menu.

Use the ▲▼+– and SET/POINT ZOOM buttons on the remote control to navigate the Media Player menus.

Select the ⚙ icon in the file list screen or home screen of the Media Player to display the configuration screen of the Media Player.

Media Player Home Screen

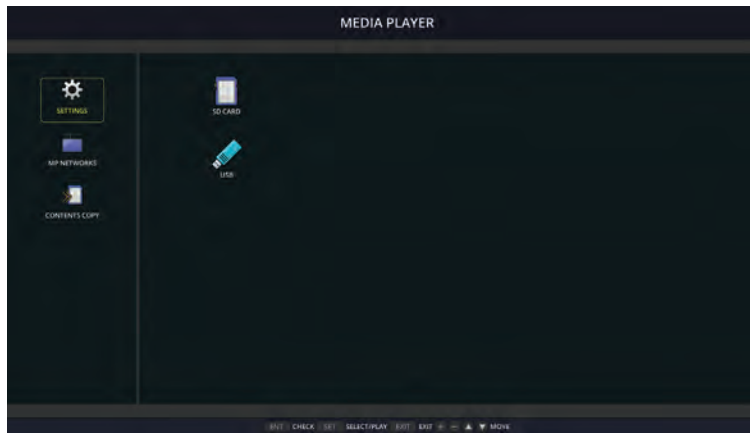

The following settings can be configured on the [SETTINGS] screen. Select [OK] then press SET/POINT ZOOM button to save any changes; otherwise settings you selected are not saved.

Slideshow

Menu	Function
SCREEN SIZE	Selects [ACTUAL SIZE] or [BEST FIT].
PLAY MODE	Selects [AUTO] or [MANUAL].
INTERVAL	Sets interval time.
REPEAT	Check the check box to repeat slideshow.
AUDIO FILE	Selects an audio file.
BGM	Check the check box to enable BGM.
PLAY END SCREEN	Selects a setting for when the slideshow finishes.
	Black screen: When the slideshow finishes, a black screen is displayed.
	File list: When the slideshow finishes, it goes back to the file list screen.
	Save last screen: When the slideshow finishes, the last slideshow image is kept on the screen.

Auto Play

Automatically plays any pictures or videos in the selected folder when the monitor is turned on with MP as the selected input. The images and videos will be displayed in the “sorted” order.

Menu	Function
AUTO PLAY	OFF: Automatic play mode is off.
	SLIDESHOW: Automatically plays a selected file.
FOLDER	The location on the USB storage device or microSD memory card where the files are located. Select [SD CARD] or [USB] then press ENT button to select the root directory of the SD CARD or USB device. If the files are in a sub-folder, highlight [SD CARD] or [USB] then press SET/POINT ZOOM button, navigate to the folder that contains the files, and then press ENT button on the remote control.

Preset Contents

When the monitor has no current signal input, the monitor automatically changes to the Media Player input and plays any picture or video files in the selected folder. For example, when a device such a Blu-ray player powers off, the monitor changes input from HDMI to MP and plays the files in the folder selected in this screen.

Menu	Function
ENABLE	Press [SET] to check the box to enable Preset Contents.
FOLDER	The location on the USB storage device or microSD memory card where the files are located. Select [SD CARD] or [USB] then press ENT button to select the root directory of the SD CARD or USB device. If the files are in a sub-folder, highlight [SD CARD] or [USB] then press SET/POINT ZOOM button, navigate to the folder that contains the files, and then press ENT button on the remote control.

Network & Other Settings

The settings below are for configuring the network settings and shared folder settings for the Media Player only.

To configure the settings, navigate to the [NETWORK & OTHER SETTINGS] option and press the SET/POINT ZOOM button on the remote control.

Network Settings for the Media Player

Menu	Function
IP SETTING	Network related settings to be configured for the Media Player.
IP ADDRESS	Note that the IP address for the Media Player is different than the IP address for the monitor. If you want to manually assign an IP address for the monitor, you will need to assign one to the Media Player as well. Otherwise, the IP address will be automatically assigned to the Media Player and possible conflicts on the network may occur.
SUBNET MASK	
DEFAULT GATEWAY	
DNS	
DNS PRIMARY	
DNS SECONDARY	

NETWORK INFORMATION shows the current network settings for the Media Player.

Shared Folder

The SHARED FOLDER options provide two different methods for copying files to the microSD memory card over a network. Please see [“Copying Files to the microSD memory card” on page 64](#) for instructions using the SHARED FOLDER function after enabling and configuring them in this screen.

Shared SD Card Settings

Enable this option to allow computers or mobile devices to access the microSD memory card in the monitor via the Media Player's IP address. Files can be copied to, or deleted from, the microSD memory card using a web browser. See [page 65](#).

Menu	Function
ENABLE	Check the checkbox to enable [SHARED SD CARD SETTINGS].
USER NAME	The User Name for accessing the monitor. It is the monitor model name and cannot be changed.
PASSWORD	Create a password for accessing the microSD memory card. A password is not required. If no password is set, any user/person can access and copy files to the microSD memory card.

Select OK then press SET/POINT ZOOM button on the remote control to save the settings. If OK is not pressed, the settings you configured are not saved.

Shared Folder Settings

This option allows you to access shared network folders, from within the Media Player, to copy files to the microSD memory card. Up to four folders can be added to the Shared Folder settings. See [page 65](#).

After opening the [SHARED FOLDER SETTINGS], select one of the folders then press SET/POINT ZOOM button to show the settings for configuring the network credentials.

Menu	Function
ENABLE	Check the checkbox to enable the selected folder.
SHARED FOLDER	Set the IP address or name of the network shared folder location that contains the files for copying to the microSD memory card.
USER NAME	Input the user name that has permission to access the shared network folder.
PASSWORD	Input the password for the user name that is being used to access the shared folder.

Select OK then press SET/POINT ZOOM button on the remote control to save the settings. If OK is not pressed, the settings you configured are not saved.

Shift to No Signal



Under normal operation on the other video input connections, when video signal is lost, such as when a Blu-ray player turns off, the monitor registers “No Signal” and enters power save mode.

When the Media Player is the current signal input, the Media Player is always on and sends video signal to the monitor. This prevents the monitor from entering power save mode, even when the Media Player is not actively playing files.

When SHIFT TO NO SIGNAL is enabled, the Media Player basically tells the monitor that there is no current video signal and to shift to no signal mode. This allows the monitor to register “No Signal” and enter power save mode, just as it would on the other video inputs when loss of video signal occurs.

The amount of time between when the Media Player is last used before it tells the monitor to shift to no signal can be adjusted.

The monitor shifts to no signal under the following conditions:

- After the Media Player stops playing content.
- While the monitor is displaying the Media Player home screen, USB  window or SD CARD  window, and no buttons have been pressed on the remote control or monitor control panel during the interval period you set.

Menu	Function
ENABLE	Check the checkbox to enable [SHIFT TO NO SIGNAL].
INTERVAL	Set the time between when the Media Player is last used to when the monitor goes into no signal mode.

Select OK then press SET/POINT ZOOM button on the remote control to save the settings. If OK is not pressed, the settings you configured are not saved.

Copying Files to the microSD memory card

There are two options for copying files to the microSD memory card when it is already inserted in the monitor. Files can be copied from a network folder or a USB storage device via the CONTENTS COPY option, or via the SD-CARD VIEWER in a web browser.

Copying files from a USB storage device is useful to easily change the content on the microSD memory card, without removing the microSD memory card and its cover from the monitor. Copying the files from a network folder or via a web browser are useful when the monitor is in a location that is not easily accessible.

Using CONTENTS COPY in the Media Player

When using the CONTENTS COPY option, the microSD memory card will be erased then the files will be copied from the selected folder.

Copying Files to the microSD memory card

1. Either connect a USB storage device to the Media Player USB port on the monitor, or configure the [SHARED FOLDER SETTINGS] in the Media Player's [NETWORK & OTHER SETTINGS] (see [page 63](#)).

2. From the Media Player's home screen select [CONTENTS COPY] then press SET/POINT ZOOM button.

The [CONTENTS COPY] screen shows any network folders that have been configured and the "USB" icon if a USB storage device is connected.

3. Select either USB or a network folder containing the files you want to copy to the microSD memory card then press SET/POINT ZOOM button.

4. On the confirmation screen, select OK then press SET/POINT ZOOM button.

The entire contents of the network folder or USB storage device will be copied to the microSD memory card. Make sure the microSD memory card's storage capacity is large enough to save the files you want to add.

- NOTE:**
- "Out of disk space" is displayed if the microSD memory card storage capacity is not enough to copy the selected folder.
 - When pressing **OK** to start CONTENTS COPY, previous data that was saved on the microSD memory card is immediately deleted. Canceling the CONTENTS COPY function will not restore the previous files.
 - Only devices connected to the monitor are shown.
 - When the monitor is copying a folder, the LED indicator blinks red.
 - While the monitor is copying files, do not eject the microSD memory card from the monitor and do not turn off the monitor's main power. Ejecting the microSD memory card or turning off the monitor while copying files may corrupt the data.
 - If you press the STANDBY button on the remote control or the  button on the monitor while the LED indicator is blinking red, the monitor goes to standby after completing the copy function.

NOTE: If the connection to a shared folder fails, an error message is shown and an "x" is displayed on the folder icon. Check for the following if this occurs:

- Is the name of the network folder correct?
- Is the network folder set for sharing?
- Have access rights been set in the network folder?
- Are there displayable files saved in the network folder?

Using SD-CARD VIEWER in a Web Browser

When using the SD-CARD VIEWER to copy files to the microSD memory card, individual files can be added to the microSD memory card without first erasing its content. Because files are added to the microSD memory card via its web controls in an internet browser, files can be copied from either a computer or a mobile device, such as a tablet, that is connected to the same network as the monitor.

Copying Files to the microSD memory card

1. Enable the [SHARED SD CARD] settings in the Media Player's [NETWORK & OTHER SETTINGS] (see [page 63](#)).

2. Open a web browser on a computer or mobile device connected to the same network as the monitor.

3. Input the IP address of the Media Player in the address field of the web browser, then press Enter to access the web controls.

The IP address for the Media Player is shown in the [NETWORK INFORMATION for MEDIA PLAYER] section of the [NETWORK & OTHER SETTINGS] screen.

4. If a password has been created for accessing the card, input the user name and password.

The user name is the monitor's model name. Note that both the user name and password are case sensitive.

- When the computer or mobile device successfully connects to the Media Player, the Media Player's web controls are displayed in the browser. Select the **SD-CARD VIEWER** link on the left side of the browser window.



- Press the **Choose File** button to open a file browser, then select a file.

The file will be added to the root directory of the microSD memory card. To upload a file to a different folder on the microSD memory card, do one of the following:

- Upload to an existing folder – If you want to add the file to an existing folder on the microSD memory card, select the folder name to open the folder first, then press the Choose File button.
 - Upload to a new folder – If you want to create a new folder before uploading the file, press the **CREATE** button. Input a folder name in the NAME field and then press **OK**. The new folder appears in the microSD memory card file list. Select the new folder to open the folder, then press the **Choose File** button.
- Navigate to the where the files you want to add to the card are located. Select the file you want to copy to the microSD memory card then press **Open**.
 - Press **OK** to confirm the file upload.
 - The file will now copy to the microSD memory card.

If you selected a file type that the Media Player cannot read, a message will show on the file upload screen that the file cannot be copied.

To delete files or folders from the microSD memory card, press the check boxes to select the items you want to delete then press the **DELETE** button.

- NOTE:**
- When the monitor is copying a folder, the LED indicator blinks red.
 - While the monitor is copying files, do not eject the microSD memory card from the monitor and do not turn off the monitor's main power. Ejecting the microSD memory card or turning off the monitor while copying files may corrupt the data.
 - If you press the STANDBY button on the remote control or the **⏻** button on the monitor while the LED indicator is blinking red, the monitor goes to standby after completing the copy function.
 - Only file formats for still images, motion video files, and BGM audio can be copied.

SD-CARD VIEWER Web Controls Buttons

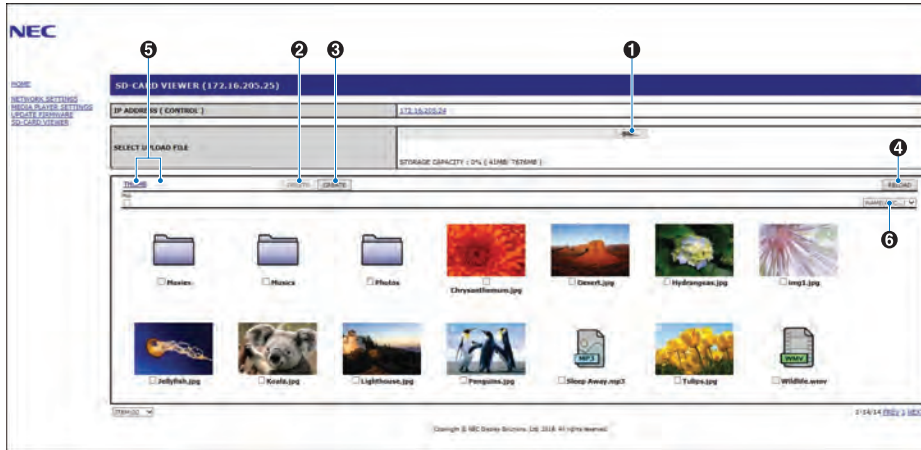

1. CHOOSE FILE

Choose File opens a file browser to select a file to copy to the microSD memory card. Pressing **Open** in the file browser shows the upload window displaying the selected file. Pressing **OK** starts the file upload.

NOTE: Please check the microSD memory card storage capacity before copying files. **STORAGE CAPACITY** shows the connected microSD memory card capacity.

2. DELETE

Press the check boxes to select files and folders. Pressing **DELETE** opens the **DELETE FOLDERS/FILES** window. Pressing **OK** deletes the selected files or folders.

3. CREATE

Create opens a window to name and add a new folder to the microSD memory card. Input folder name and select **OK**. A maximum of 255 alphanumeric characters is allowed.

4. RELOAD

Refreshes the microSD memory card data in the web browser.

5. THUMB/LIST

Switches between displaying the files using icons or thumbnails. Displays a description of the file or folder if you select thumb name or file name.

6. SORT

Selects the sorting the method. The folders saved in the microSD memory card are sorted based on the selected sort method.

Connecting to a different monitor's SD-CARD VIEWER

If there is more than one monitor on the network that has a Media Player, you can search from any monitor's main web controls to display all supported monitors on the network.

1. Input the monitor's IP address in the web browser's address field.

Press the DISPLAY button on the remote control to show the monitor's Information OSD on-screen, which displays the monitor's IP address.

The monitor and its Media Player have different IP addresses; both are automatically assigned by default when connected to a DHCP network.

2. Select the [SD-CARD VIEWER] link on the left side of the browser window.

This displays a [GO TO SD-CARD VIEWER] window.

3. Press the SEARCH button to display the [IP ADDRESS] of the currently connected monitor and all compatible monitors on the same network.
4. Select the IP address, under the [IP ADDRESS (MP)] column, to access the Media Player's web controls for the monitor you want to copy files to.

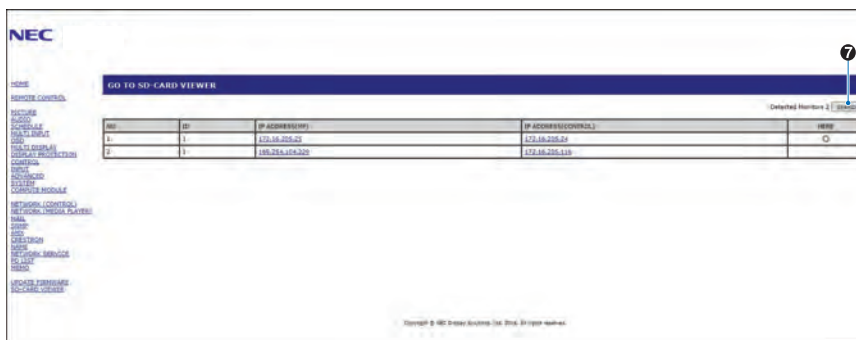

To open the other monitor's web page in a new tab, right-click on its IP address. To open the other monitor's web page in a new window, left-click on its IP address.

Using Emergency Contents

Media files for playback can be saved to a special folder. Create a folder called "EMERGENCY CONTENTS" in the root on the microSD memory card and copy the media files into the folder. The emergency playback can be triggered via an external command to the display via either LAN or RS-232C.

Instructions for the EMERGENCY CONTENTS can be found in the file called "External_Control.pdf". See [page 98](#).

Chapter 6 Multi-Monitor Setup

This Chapter Includes:

- ⇒ “Connecting Multiple Monitors” on page 70
- ⇒ “Video Out Connection” on page 72
- ⇒ “Setting the Remote Control ID Function” on page 73

Connecting Multiple Monitors

Monitors can be connected to each other, both communication and video connections, in multiple display installations. Chaining the video connections together creates a video wall where a single image can be tiled across all displays. When connecting multiple monitors to install a video wall, communication and video cable connections are necessary and their configuration must be carefully considered. Please refer to the [“Wiring Diagram” on page 24](#) for making communication and video connections.

The monitor settings for configuring a video wall in the OSD and Monitor Webpage settings are under [MULTI-DISPLAY].

- [AUTO TILE MATRIX SETUP] – automatically configures the multi-display settings when the communication and video ports are chained together. This automatically sets the [MONITOR ID] and position of the monitors in the video wall following the physical wiring between the monitors.

Input the number of monitors arranged horizontally and vertically on the master monitor. The following settings are set automatically when you run the auto setup: [MONITOR ID], [TILE MATRIX], [TILE MATRIX MEM], [Input Signal], [DisplayPort] in [TERMINAL SETTINGS] and setting for video out.

- NOTE:**
- [AUTO ID] will be automatically executed.
 - When you use this function, it is recommended that monitors be chained by DisplayPort cable.
 - This function is released if [MOTION] in [SCREEN SAVER] is activated.

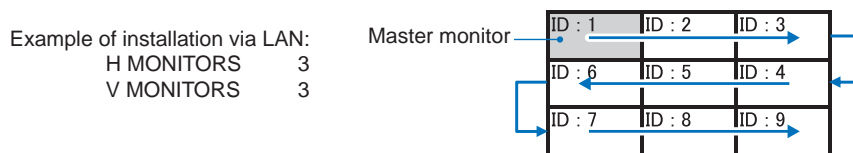

- [SETTING COPY] – copies some of the OSD menu categories to other monitors in the video wall, when chained together.
- [TILE MATRIX] – allows one image to be expanded and displayed over multiple screens (up to 100) through a distribution amplifier. Manually input the number of horizontal and vertical monitor in the video wall, position of the monitor in the wall, and turn on or off Tile Compensation. When tilting HDCP content, please refer to the [“Video Out Connection” on page 72](#).
 - [TILE COMP] - scales the displayed image to compensate for the width of the screen bezel in order to create a seamless image.
 - [TILE CUT] - select a part of image from the displaying image. The selected part is displayed as a full image on the screen.

Example of TILE CUT 2x1 (Landscape)

For the left monitor:

- Set H MONITORS [2] and V MONITORS [2].
One image will be divided by 4 then put number from 1 to 4.



- Select 1 to 4 at [POSITION].

e.g. Selecting 1



3. With [H ADJUSTMENT] and [V ADJUSTMENT], you can move the selected square to the exact spot where you display.

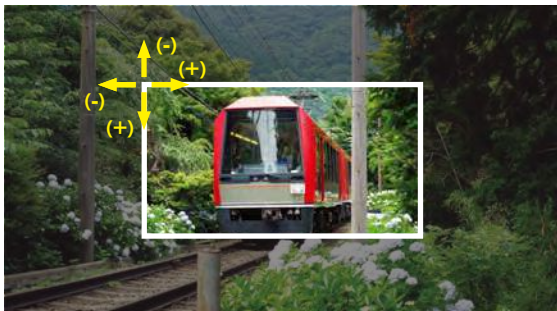

4. Select [YES] at [TILE MATRIX ENABLE].



For the right monitor:
Repeat the same steps.

e.g. Selecting 2 at [POSITION]

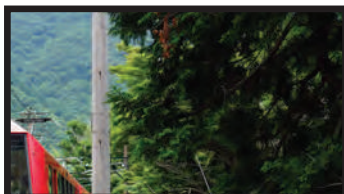

After individually setting, the 2x1 image (Landscape) will be shown as below.



- [FRAME COMP] - Allows auto setting of FRAME COMP by inputting the number of monitors arranged horizontally and vertically on.
It is recommended and should deliver the best results if fast moving content is displayed. Applying the [FRAME COMP] is needed for a specific installation.

[AUTO] - Sets total delay value, each delay value is set automatically by setting of [H MONITORS], [V MONITORS] and [POSITION] in TILE MATRIX.

[MANUAL] - Sets delay value to every monitors.

- [V SCAN REVERSE] - Reverse scanning image direction to create a smooth motion image.

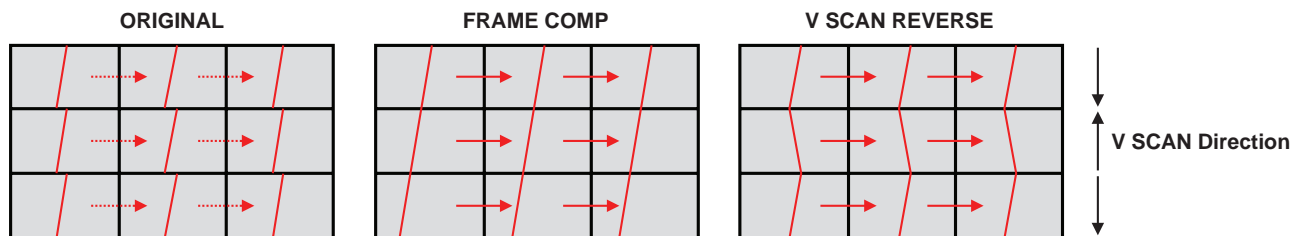

- [TILE MATRIX MEMORY] – allows settings for the tile matrix to be saved to all inputs in the monitor.
- [ID CONTROL] – sets the monitor ID and group IP for the current monitor. When the monitors LAN ports are chained together, the ID and IP can be automatically assigned to all displays.

- Video daisy chaining.
We strongly recommend using the same monitor model for all monitors in the connected daisy-chain.
MONITORS POSITION is different from ID. Please refer to the figure1.

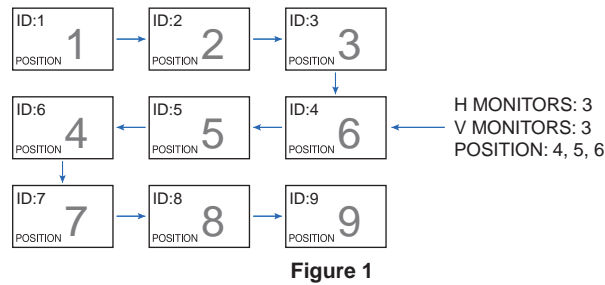

Video Out Connection

Main picture	DisplayPort1	DisplayPort2	DVI	HDMI1	HDMI2	VGA (RGB)	VGA (YPbPr)	Video	OPTION		MP
Connector	DisplayPort1 (DAISY CHAIN IN)	DisplayPort2	DVI-D	HDMI1 (DAISY CHAIN IN)	HDMI2 (CEC)	VGA (RGB, YPbPr)		VIDEO	Option Board Slot (SLOT2 (DP))	Option Board Slot (SLOT2 (HDMI))	-
DisplayPort	Yes	No	No	No	No	No	No	No	Yes	No	No
HDMI	No	No	Yes	Yes	No	No	No	No	No	Yes	Yes

NOTE: The output of Media Player signal (MP) is capable only between the same models.

For connecting multiple monitors with HDMI cable

- Using the same display model.
- Set the same ([MODE1] or [MODE2]) at [HDMI] in [TERMINAL SETTINGS] in all connected multiple monitors.

For DisplayPort Out

- Select either the DisplayPort1 or OPTION input for the monitor to output a signal from DisplayPort Out.
 - This monitor's signal output function supports contents protected by HDCP. HDCP content can be distributed across up to 3 connected monitors.
- When using an Option Board, please set [SLOT2 CH SETTING] to [CH1] then set [SLOT2 CH SELECT] to DisplayPort. See [page 122](#).

NOTE: Please use slot2 type option boards which outputs DisplayPort signal.

For HDMI Out

- Select either the HDMI1, DVI, MP, or OPTION input for the monitor to output a signal from HDMI OUT.
- This monitor's signal output function supports contents protected by HDCP.

HDCP content can be distributed across multiple connected monitors as described below:

- HDCP 1: Up to 8 monitors / HDCP 2.2: Up to 5 monitors.
- The time until image is displayed depends on the number of connected monitors.
- Without HDCP: Up to 9 monitors.

NOTE: • Depending on the device you use, number of monitor connection will change.

- When displaying an image in a multi-monitor setting, do not disconnect cables from the monitors. When you disconnect cables, please turn the main power off first.

- When using an option, please set [SLOT2 CH SETTING] to [CH1] then set [SLOT2 CH SELECT] to TMD5. See [page 122](#).

NOTE: Please use slot2 type option boards which outputs HDMI signal.

For HDCP Content

HDCP is a system for preventing illegal copying of video data sent over a digital signal. If you are unable to view material via the digital inputs, this does not necessarily mean that the monitor is not functioning properly. With the implementation of HDCP, there may be cases in which certain content is protected by HDCP and might not be displayed due to the decision/intention of the HDCP community (Digital Content Protection, LLC).

Due to these security restrictions in video content, HDCP video content can only be tiled across a limited number of monitors. HDCP video content is generally commercially produced Blu-rays and DVDs, television broadcast, and streaming media services.

Setting the Remote Control ID Function

The optional remote control can be used to control up to 100 individual MultiSync monitors using what is called the REMOTE CONTROL ID mode. The REMOTE CONTROL ID mode works in conjunction with the Monitor ID, allowing control of up to 100 individual MultiSync monitors. For example, if there are many monitors being used in the same area, a remote control in normal mode would send signals to every monitor at the same time (see **Figure 1**). Using the remote in REMOTE CONTROL ID mode will only operate one specific monitor within the group (see **Figure 2**).

To Set Remote Control ID

While holding down the REMOTE ID SET button on the remote control, use the KEYPAD to input the Monitor ID (1-100) of the monitor to be controlled via remote. The remote can then be used to operate the monitor having that specific Monitor ID number.

When 0 is selected or when the remote control is in normal mode, all monitors will be operated.

To Set/Reset Remote Control Mode

ID Mode - To enter ID Mode press the REMOTE ID SET button and hold down for 2 seconds.

Normal Mode - To return to Normal Mode press the REMOTE ID CLEAR button and hold down for 2 seconds.

- NOTE:**
- In order for this feature to work properly, the monitor must be assigned a Monitor ID number. The Monitor ID number can be assigned under the MULTI DISPLAY menu in the OSD. See [page 114](#).
 - Point the remote control towards the remote sensor of the desired monitor and press the REMOTE ID SET button. The MONITOR ID number is shown on the screen when your remote control is in ID mode.

Use the Remote to Control all Monitors in Range

1. On the remote control, press and hold down the REMOTE ID SET button while using the keypad to input the REMOTE CONTROL ID number "0".
2. All monitors within range of the remote control will now respond to keypad press.

NOTE: When the REMOTE ID is set to "0", pressing REMOTE ID SET will make all monitors, within range of the remote signal, display their Monitor ID on screen. This way you can easily see what the monitor ID is if you want to control a single monitor, as described below.

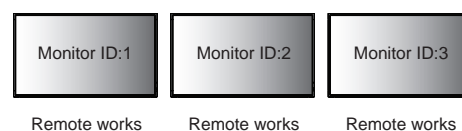

Figure 1
Remote in Normal mode or the REMOTE ID is set to 0

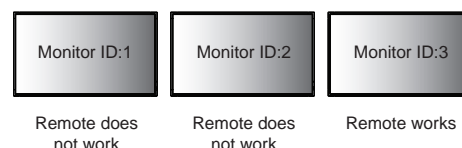

Figure 2
Remote set up to use REMOTE ID:3

You need an optional remote control for this function.

Use the remote control to operate a monitor that has a specific MONITOR ID number assigned to it.

1. Set the [MONITOR ID] number for the monitor (see [page 114](#)). The [MONITOR ID] number can range from 1-100.

This [MONITOR ID] number allows the remote control to operate this specific monitor without affecting other monitors.

2. On the remote control, press and hold down the REMOTE ID SET button while using the keypad to input the REMOTE CONTROL ID number (1-100). The REMOTE ID NUMBER should match the MONITOR ID number of the monitor to be controlled.

3. Point the remote control towards the remote sensor of the desired monitor and press the REMOTE ID SET button.

The MONITOR ID number is shown in red on the monitor.

If the REMOTE CONTROL ID is "0", then all monitors in range will show their respective MONITOR ID number in red.

If the MONITOR ID number is shown in white on the monitor, the MONITOR ID number and the REMOTE CONTROL ID are not the same.

This Chapter Includes:

- ⇒ “Connecting Interfaces” on page 76
- ⇒ “Controlling the Monitor via RS-232C” on page 79
- ⇒ “Controlling the Monitor via LAN” on page 80
- ⇒ “Intelligent Wireless Data” on page 88
- ⇒ “Proof of Play” on page 89

Connecting external device

There are two options to connect an external device to control the monitor.

NEC Display Wall Calibrator or NaViSet Administrator allows you to control the monitor settings and get the monitor status, including calibration information.

- RS-232C terminal.
Connecting an external device to the RS-232C terminal of the monitor with a RS-232C cable.
- LAN port.
Connecting a network to the LAN1 (DAISY CHAIN IN) port of the monitor with a LAN cable (RJ45 category 3 or higher).

Connecting Interfaces

RS-232C Interface

PROTOCOL	RS-232C
BAUD RATE	9600 [bps]
DATA LENGTH	8 [bits]
PARITY	NONE
STOP BIT	1 [bit]
FLOW CONTROL	NONE

LAN Interface

PROTOCOL	TCP
PORT NUMBER	7142
COMMUNICATION SPEED	AUTO setting (10/100Mbps)

Commands

Control command

The display supports two basic types of command formats:

- Binary communications: A sequence of encoded bytes that includes support for controlling almost all monitor functions.
- ASCII Control commands: This uses simple “English-like syntax” control commands using ASCII, for performing many common functions easily.

NOTE: The command formats for both types is explained in the external documents “External_Control.pdf”. See [page 98](#).

The table below gives some examples of the binary commands for several common functions. The data is listed as hexadecimal bytes. These examples assume the Monitor ID is 1.

Function (Monitor ID = 1)	Code Data
Power ON	01 30 41 30 41 30 43 02 43 32 30 33 44 36 30 30 30 31 03 73 0d
Power OFF	01 30 41 30 41 30 43 02 43 32 30 33 44 36 30 30 30 34 03 76 0d
Input Source Select DisplayPort1	01 30 41 30 45 30 41 02 30 30 36 30 30 30 30 46 03 04 0d or 01 30 41 30 45 30 41 02 31 31 30 36 30 30 30 46 03 04 0d
Input Source Select DisplayPort2	01 30 41 30 45 30 41 02 30 30 36 30 30 30 31 30 03 73 0d or 01 30 41 30 45 30 41 02 31 31 30 36 30 30 31 30 03 73 0d
Input Source Select DVI	01 30 41 30 45 30 41 02 30 30 36 30 30 30 30 33 03 71 0d or 01 30 41 30 45 30 41 02 31 31 30 36 30 30 30 33 03 71 0d
Input Source Select HDMI1	01 30 41 30 45 30 41 02 30 30 36 30 30 30 31 31 03 72 0d or 01 30 41 30 45 30 41 02 31 31 30 36 30 30 31 31 03 72 0d
Input Source Select HDMI2	01 30 41 30 45 30 41 02 30 30 36 30 30 30 31 32 03 71 0d or 01 30 41 30 45 30 41 02 31 31 30 36 30 30 31 32 03 71 0d
Input Source Select VGA (RGB)	01 30 41 30 45 30 41 02 30 30 36 30 30 30 30 31 03 73 0d
Input Source Select VGA (YPbPr)	01 30 41 30 45 30 41 02 30 30 36 30 30 30 30 43 03 01 0d
Input Source Select VIDEO	01 30 41 30 45 30 41 02 30 30 36 30 30 30 30 35 03 77 0d

Function (Monitor ID = 1)	Code Data
Input Source Select MP	01 30 41 30 45 30 41 02 30 30 36 30 30 30 38 37 03 7D 0d or 01 30 41 30 45 30 41 02 31 31 30 36 30 30 38 37 03 7D 0d
Input Source Select OPTION	01 30 41 30 45 30 41 02 30 30 36 30 30 30 30 44 03 06 0d or 01 30 41 30 45 30 41 02 31 31 30 36 30 30 30 44 03 06 0d
Sound Mute ON	01 30 41 30 45 30 41 02 30 30 38 44 30 30 30 31 03 09 0d
Sound Mute OFF	01 30 41 30 45 30 41 02 30 30 38 44 30 30 30 32 03 0a 0d

ASCII Control command

This monitor supports control command, which is listed in the “External_Control.pdf” (See [page 98](#)), but also supports common ASCII control command, which is used for controlling the NEC monitor or projector from a connected PC. For further information please visit our website.

Parameter

Input command

Input signal name	Response	Parameter
DVI	dvi	dvi or dvi1
HDMI1	hdmi1	hdmi1 or hdmi
HDMI2	hdmi2	hdmi2
DisplayPort1	DisplayPort1	DisplayPort1 or DisplayPort
DisplayPort2	DisplayPort2	DisplayPort2
VGA	vga	vga, vga1, computer, computer1, rgb or rgb1
VIDEO	video	video or video1
MP	mp	mp
OPTION	option	option

Status command

Response	Error status
error:temp	Temperature abnormal
error:fan	Cooling fan abnormal
error:light	Inverter or backlight abnormal
error:system	System error

Supporting HDMI CEC Command

Please connect a CEC supporting device to HDMI2 port.

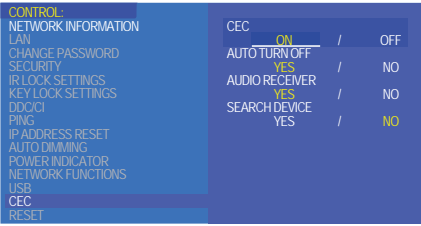
OSD menu	HDMI CEC command name	Explanation	Setting
CEC (Consumer Electronics Control)	One Touch Play	When a CEC supported HDMI device is turned on, the monitor connected to the device by an HDMI cable also automatically turns on. After the monitor powers on, [INPUT] automatically switches to the [HDMI2]. If the monitor is turned on when HDMI CEC devices are turned on, it changes the [INPUT] from the current one to [HDMI2].	 <p>To set the CEC options, please follow the steps below.</p> <p>Press the Menu button to open the OSD.</p> <p>Using the ▲▼ + - buttons, navigate to [CONTROL] to [CEC], then press SET/POINT ZOOM button to enter the CEC options.</p> <p>Use the + - buttons to highlight [ON], then press SET/POINT ZOOM button to enable CEC.</p>
	Remote Control Pass Through	The monitor's optional wireless remote control button operation can function with HDMI CEC supporting devices. For example, if turning on the monitor by wireless remote control and pressing the play button, a HDMI CEC supporting device can also be turned on and play.	
	Power Status	Connected HDMI CEC supporting devices obtain the monitor's power status, such as if the monitor is in standby mode or on.	
	System Information	This function obtains the information for a connected HDMI CEC supported device (CEC version, Physical Address). In addition, this function copes with the "Change Language function". If the language for the monitor is changed, the language for a connected HDMI CEC supported device is changed to the same language, which is selected for the monitor. For the "Change Language function", it is necessary that the connected HDMI CEC supported device be able to cope with multi-language.	
AUTO TURN OFF	System Standby	If the monitor is set to standby using the optional wireless remote control, HDMI CEC supported devices also go into standby at the same time. If the monitor goes into standby while an HDMI CEC supported device is recording, the device remains on. Please refer to the user's manual supplied with the HDMI CEC supported device for further information.	Use the ▲▼ buttons to select [AUTO TURN OFF]. Use the + - buttons to highlight [YES], then press the SET/POINT ZOOM button to select [YES].
AUDIO RECEIVER	System Audio Control	Please set an HDMI CEC audio amplifier between the monitor and an HDMI CEC supported device with an HDMI cable. The Volume button on the optional wireless remote control can control the volume of the connected HDMI CEC audio amplifier. While this function is active, the external speaker connected to the monitor is set to MUTE automatically.	Use the ▲▼ buttons to select [AUDIO RECEIVER] then press SET/POINT ZOOM. Use the + - buttons to highlight [YES], then press the SET/POINT ZOOM button to select [YES].
SEARCH DEVICE	Device OSD Name Transfer	Use the + - buttons to highlight YES, then press the SET/POINT ZOOM button to start the search.	Use the ▲▼ buttons to select [SEARCH DEVICE].
	Routing Control	By selecting a device name, the HDMI CEC supported device input switches to the input you selected. After selecting the device, wireless remote control operation functions for the selected device.	This function searches for CEC supported devices on the monitor's HDMI connections. If a CEC device is successfully detected, this function obtains the device's name. The device's name and the HDMI connection it is found on are displayed.
<p>This CEC function is supporting Feature Abort. Please refer to Connections (see page 23) for HDMI CEC devices connection.</p>			

Controlling the Monitor via RS-232C

This monitor can be controlled by connecting a personal computer with an RS-232C (reverse type) terminal.

For example, some of the functions that can be controlled by a personal computer are:

- Power ON or standby.
- Switching between input signals.
- Sound Mute ON or OFF.

Connection

Monitor + computer.

- Please turn off the monitor's main power before connecting a computer to the monitor.
- Please turn on the connected computer first then turn on the monitor's main power.

If you turn on the computer and monitor in reverse order, the com port may not work.

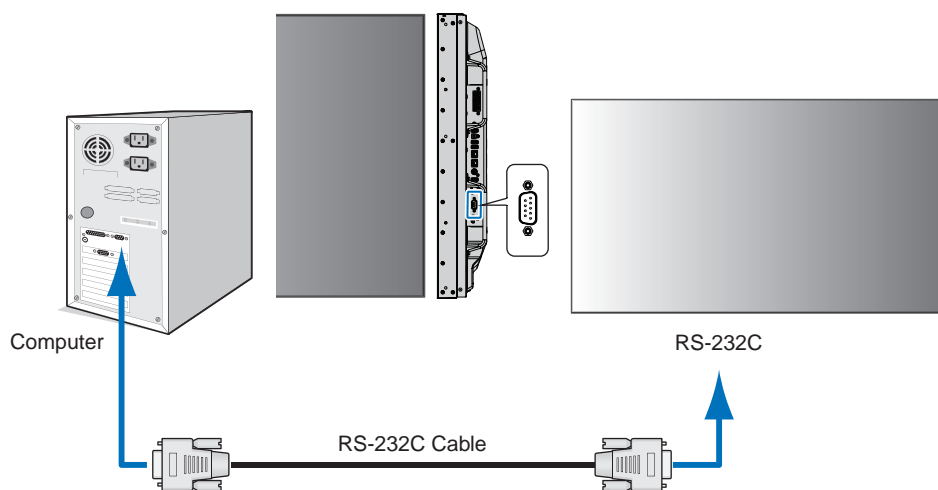

NOTE: • If your computer is equipped only with a 25-pin serial port connector, a 25-pin serial port adapter is required. Contact your supplier for details.

- For the pin assignment, please see “2) RS-232C input/output” on [page 80](#).

To control the monitor via commands sent from a computer connected with an RS-232C cable, please use the control command. Instructions for the control command can be found in the Control Command Diagram (see [page 76](#)) or the “External_Control.pdf”. See [page 98](#).

Interface

PROTOCOL	RS-232C
BAUD RATE	9600 [bps]
DATA LENGTH	8 [bits]
PARITY	NONE
STOP BIT	1 [bit]
FLOW CONTROL	NONE

This monitor uses RXD, TXD and GND lines for RS-232C control.

The reverse type cable (null modem cable) (not included) should be used for RS-232C control.

PIN ASSIGNMENT

RS-232C input/output

Pin No	Name
1	NC
2	RXD
3	TXD
4	NC
5	GND
6	NC
7	NC
8	NC
9	NC

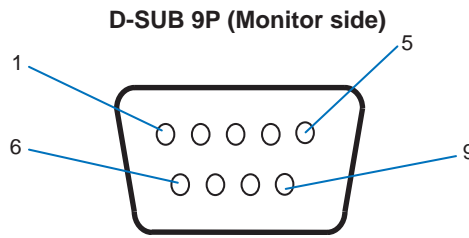

This monitor uses RXD, TXD and GND lines for RS-232C control.

Controlling the Monitor via LAN

Connecting to a Network

Using a LAN cable allows you to specify the Network Settings and the Alert Mail Settings by using an HTTP server function.

To use a LAN connection, you are required to assign an IP address. The monitor will obtain an IP address automatically when connected to a DHCP network.

Example of LAN connection:

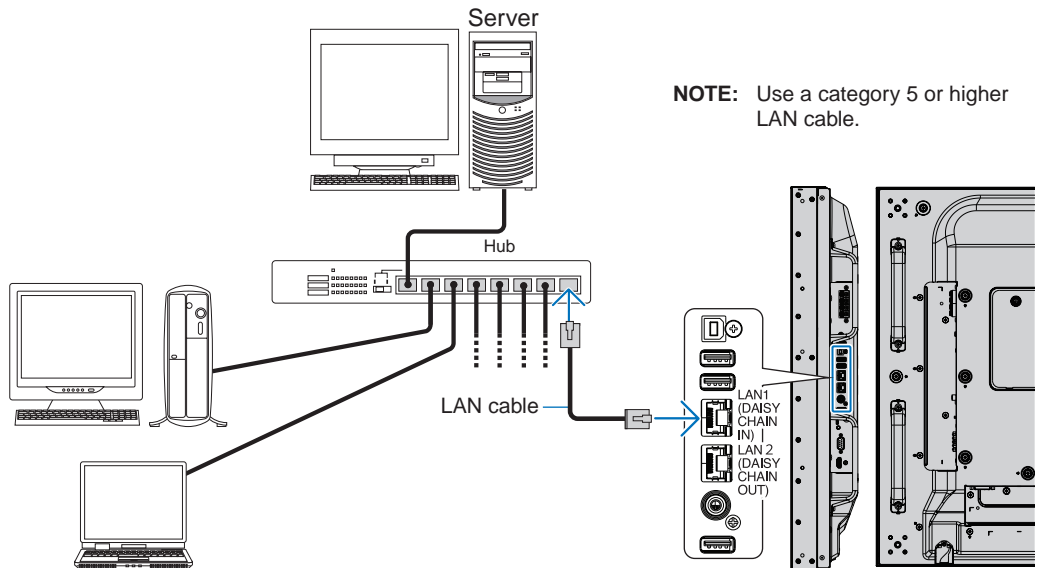

Multiple Monitors Connection

You can control multiple monitors by using RS-232C, REMOTE or LAN daisy-chain connection.

NOTE: • Up to 100 monitors can be daisy chained together. Please execute AUTO ID/IP to automatically assign unique IDs to each monitor (see [page 114](#)) before trying to control a monitor by manually specifying the ID number.

Master Monitor		Sub Monitors	
Connector		Connector	
IN	OUT	IN	OUT
RS-232C	LAN2 (DAISY CHAIN OUT)	LAN1 (DAISY CHAIN IN)	LAN2 (DAISY CHAIN OUT)
REMOTE			
LAN1 (DAISY CHAIN IN)			

Connection

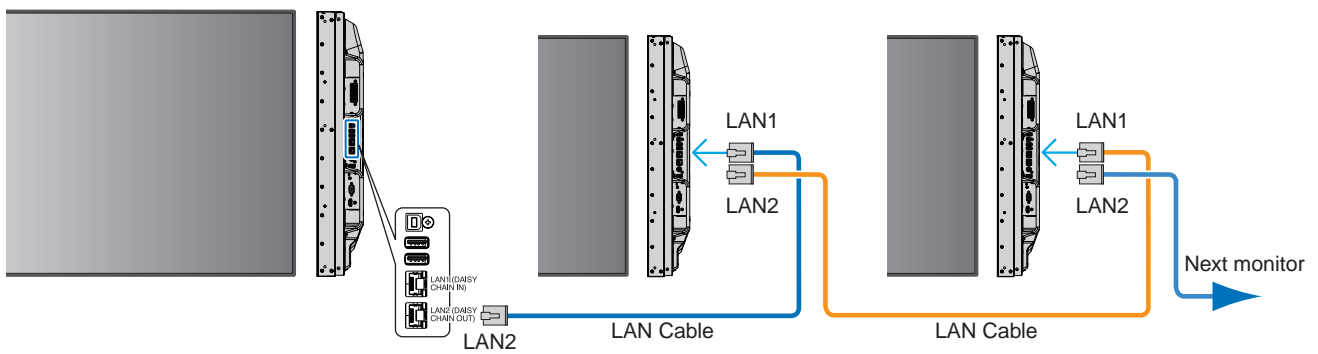

Network Setting by Using an HTTP Browser

Overview

Connecting the monitor to a network allows for remote control of the monitor from a computer connected to the same network.

The IP address and subnet mask of the monitor can be set on the Network Setting screen of the web browser by using an HTTP server. When connecting to a DHCP server, the IP address and subnet mask will be obtained automatically when the monitor is turned on. Please be sure to use “Microsoft Internet Explorer 10” or a higher version for the web browser.

This device uses “JavaScript” and “Cookies” and the browser should be set to accept these functions. Refer to the help files for the web browser to change the settings to use JavaScript and Cookies.

To access the HTTP server, launch a web browser on a computer connected to the same network as the monitor and enter the following URL in the web address field:

Network Setting

`http://<the Monitor's IP address>/index.html`

- NOTE:**
- The default IP address is assigned automatically to the monitor.
 - NaViSet Administrator software for managing monitors over the network is recommended. It can be download from the NEC Display website (See [page 98](#)).
 - If the [MONITOR NETWORK SETTINGS] screen does not appear in the web browser, press the Ctrl+F5 keys to refresh your web browser (or clear the cache).
 - If the monitor appears to be slow in response to commands or clicks on buttons in the browser, or the general speed of operation is unacceptable, this may be due to network traffic or the settings on your network. Should this happen, consult your network administrator.
 - The monitor may not respond if the buttons shown on the browser are repeatedly pressed in rapid intervals. Should this happen, wait a moment and repeat. If you still can't get a response, turn the monitor off and then back on.

Preparation Before Use

Connect the monitor to the network, using a commercially available LAN cable, before attempting to use browser operations.

Operation with a browser that uses a proxy server may not be possible depending on the type of proxy server and the setting method. Although the type of proxy server will be a factor, it is possible that items that have been set will not be shown, depending on the effectiveness of the cache, and the contents set from the browser may not be reflected in operation. It is recommended that a proxy server is not used unless the network environment requires it.

Handling of the Address for Operation via a Browser

A host name can be used in the following cases (corresponding to the IP address of the monitor):

The host name must be registered in the domain name system (DNS) by the network administrator. You can then access the network settings of the monitor via this registered host name by using a compatible browser.

If the host name has been configured in the “HOSTS” file of the computer being used, you can then access the network settings of the monitor via this host name by using a compatible browser.

Example 1: When the host name of the monitor has been set to “pd.nec.co.jp”, access is gained to the network setting by specifying `http://pd.nec.co.jp/index.html` for the address or the entry column of the URL.

Example 2: When the IP address of the monitor is “192.168.73.1”, access is gained to the mail alert settings by specifying `http://192.168.73.1/index.html` for the address or the entry column of the URL.

Operation

Access the following address to show HOME.

http://<the Monitor's IP address>/index.html

Click each link on the left column below HOME.

REMOTE CONTROL

Enable an operation to control the monitor equivalent to the keys on the remote control.

OSD Menu Settings in the Monitor Web controls

Select one of the links on the left side of the monitor web controls to configure the settings available in the monitor's OSD. Please see [page 100](#) for the full list of OSD menu controls.

[INPUT], [PICTURE], [AUDIO], [SCHEDULE], [MULTI INPUT], [OSD], [MULTI DISPLAY], [DISPLAY PROTECTION], [CONTROL], [OPTION], [SYSTEM], [COMPUTE MODULE]

The screenshot shows the NEC monitor web controls interface. On the left is a navigation menu with links: HOME, REMOTE CONTROL, INPUT, PICTURE, AUDIO, SCHEDULE, MULTI INPUT, OSD, MULTI DISPLAY, DISPLAY PROTECTION, CONTROL, OPTION, SYSTEM, COMPUTE MODULE, NETWORK (CONTROL), NETWORK (MEDIA PLAYER), MAIL, SNMP, AMX, CRESTRON, NAME, NETWORK SERVICE, PD LIST, MEMO, UPDATE FIRMWARE, and SD-CARD VIEWER. The main content area is titled 'OSD' and contains several settings sections:

- LANGUAGE:** Radio buttons for ENGLISH (selected), ITALIAN, RUSSIAN, GERMAN, SPANISH, CHINESE, FRENCH, SWEDISH, and JAPANESE. Includes 'APPLY' and 'CANCEL' buttons.
- OSD TIME:** A numeric input field set to '6' followed by 'x 5[SEC] (2 - 48)'. Includes 'APPLY' and 'CANCEL' buttons.
- OSD POSITION:** Two rows for X and Y coordinates. X is set to '128' (range 0-255) and Y is set to '225' (range 0-255). Includes 'APPLY' and 'CANCEL' buttons.
- INFORMATION OSD:** Radio buttons for ON (selected) and OFF. Below it, 'COMMUNICATION INFO.' has radio buttons for ON (selected) and OFF. Includes 'APPLY' and 'CANCEL' buttons.
- OSD TRANSPARENCY:** Radio buttons for ON and OFF (selected). Includes 'APPLY' and 'CANCEL' buttons.

NOTE: The buttons in the monitor web controls function as follows:

[APPLY]: Saves the settings.

[CANCEL]: Returns to the previous settings.

NOTE: CANCEL is disabled after clicking APPLY.

[RELOAD]: Reloads the settings.

[RESET]: Resets to the initial settings.

Network Settings

Click on "NETWORK" on the left column below HOME.

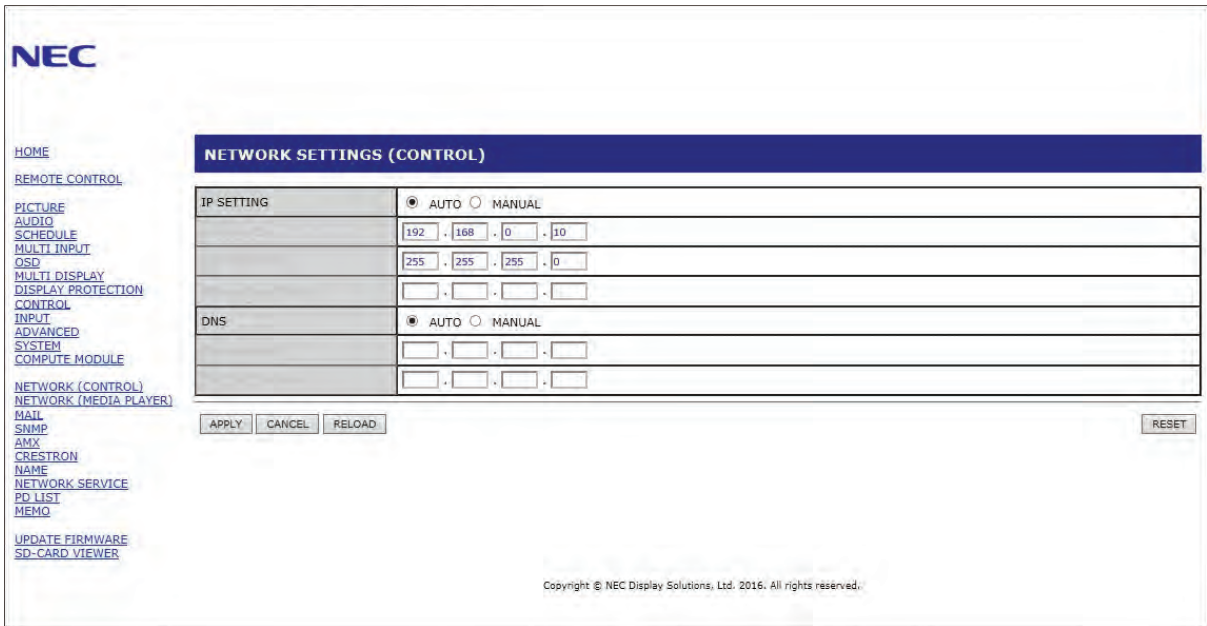

IP SETTING	Select an option for setting the IP ADDRESS. AUTO: Automatically assign an IP address. MANUAL: Manually set an IP address for the monitor connected to the network. NOTE: Consult your network administrator if you have any trouble.
IP ADDRESS	Set your IP address for the monitor connected to the network when [MANUAL] is selected for [IP SETTING].
SUBNET MASK	Set your subnet mask data for the monitor connected to the network when [MANUAL] is selected for [IP SETTING].
DEFAULT GATEWAY	Set your default gateway for the monitor connected to the network when [MANUAL] is selected for [IP SETTING]. NOTE: Set as [0.0.0.0] to delete the setting.
DNS	Set for IP ADDRESS setting of DNS server. AUTO: The DNS server connected to the monitor will automatically assign its IP address. MANUAL: Manually enter the IP address of the DNS server that is connected with the monitor.
PRIMARY DNS	Enter the primary DNS server settings of the network connected with the monitor. NOTE: Enter [0.0.0.0] to delete the setting.
SECONDARY DNS	Enter the secondary DNS server settings of the network connected with the monitor. NOTE: Enter [0.0.0.0] to delete the setting.

NOTE: The following settings will be set back to the factory settings when IP ADDRESS RESET is selected at CONTROL of the OSD:

[IP SETTING]: AUTO, [IP ADDRESS]: 192.168.0.10, [SUBNET MASK]: 255.255.255.0, [DNS]: AUTO [DEFAULT GATEWAY], [PRIMARY DNS] and [SECONDARY DNS] are blank.

Mail Setting

Click on "MAIL" on the left column below HOME.

When the Mail settings are configured and enabled, the monitor sends email notifications when an error occurs or if the input signal is lost. The monitor must be connected to a LAN for this feature to work.

Alert Mail	When an error occurs, the monitor will send an error message to the email address(es) listed in the Recipient's Address fields. Please see the "Alert error message list" table below. Note that it is not an error when no input signal is detected. The monitor will only send a no signal input notification email when Status Message is enabled. Selecting [ENABLE] turns on the Alert Mail feature. Selecting [DISABLE] turns off the Alert Mail feature.
Status Message	This is a setting whether to include no signal condition as a alerting condition or not. Selecting [ENABLE], Alert Mail send mails when the monitor is no signal or in alerting conditions. Selecting [DISABLE], Alert Mail send mails when the monitor is in alerting conditions. It doesn't send mail when the monitor is no signal.
Sender's Address	Type in the sender's address. Up to 60 alphanumeric and symbols characters can be used.
SMTP Server	Type in the SMTP server name to be connected with the monitor. Up to 60 alphanumeric characters can be used.
Recipient's Address 1 to 3	Type in your recipient's address. Up to 60 alphanumeric and symbols characters can be used.
Authentication Method	This selects the authentication method of the email transmission.
POP3 Server	This specifies the address of the POP3 server that is used in the authentication of the email.
User Name	This sets the user name for logging into the authentication server when authentication is required for the email transmission. Up to 60 alphanumeric characters can be used.
Password	This sets the password for logging into the authentication server when authentication is required for the email transmission. Up to 60 alphanumeric characters can be used.
Test Mail	Click on this button to send a test email to check if your settings are correct.

- NOTE:**
- If an alert email isn't received when performing a Test Mail, check that the network and server settings, and the recipient's email address are correct.
 - If you entered an incorrect address in a test, you may not receive an Alert email. Should this happen, check that the Recipient's Address is correct.

Alert error message list

Error number * ErrorCode	Alert mail Message	Explanation	Measure
70h ~ 7Fh	The monitor's power supply is not functioning normally.	Standby power abnormal	Please contact your supplier.
80h ~ Fh	The cooling fan has stopped.	Cooling fan abnormal	Please contact your supplier.
90h ~ 9Fh	The monitor's backlight unit is not functioning normally.	Backlight abnormal	Please contact your supplier.
A0h ~ AFh	The monitor is overheated.	Temperature abnormal	Please contact your supplier.
A2h		A Sensor reached the temperature limit which was specified in the OSD. *Condition: DISPLAY PROTECTION-FAN CONTROL-COOLING FAN = AUTO	Reconfirm the settings in the [FAN CONTROL] in the [DISPLAY PROTECTION]. Or please contact your supplier.
B0h ~ BFh	The monitor does not receive an input signal.	No signal	Please check "No picture" in "Troubleshooting".
D0h	The remaining capacity of the error log decreased.	The Proof of Play log memory size is 1 more hour.	Please get a log by using PD external command. See page 89 .
D1h	The battery for clocks is empty.	The battery is empty.	Please connect the monitor to the power then recharge the battery. Please set (DATE & TIME) in OSD.
E0h ~ EFh	A system error occurred in the monitor.	System error.	Please contact your supplier.

SNMP Settings

Click on “SNMP” on the left column below HOME.

The SNMP protocol is used to get status information and to control a monitor directly via the network.

Version:

SNMP v1 Authenticated plaintext by community name, does not return a confirmation message of the trap.

SNMP v2c Authenticated plaintext by community name, returns a confirmation message of the trap.

Community name:

The default setting of community name is “public”. It is read only. You can set community names for up to 3 settings.

Trap:

Sending error message to a specified address when an error occurs in the monitor.

Check Box	Explanation	Error code
Temperature	Temperature abnormal	0xA0, 0xA1, 0xA2
Fan	Cooling fan abnormal	0x80, 0x81
Power	Power abnormal	0x70, 0x71, 0x72, 0x78
Inverter/Backlight	Inverter or backlight abnormal	0x90, 0x91
No Signal	No signal	0xB0
PROOF OF PLAY	Lower the log storage	0xD0
System Error	System error	0xE0

AMX Settings

Click on “AMX” on the left column below HOME.

AMX BEACON	To turn on or off for the detection from AMX Device Discovery when connecting to a network supported by an AMX’s NetLinx control system. HINT: When using a device that supports AMX Device Discovery, all AMX NetLinx control systems will recognize the device and download the appropriate Device Discovery Module from an AMX server. Selecting [ENABLE] AMX Device Discovery will detect the device. Selecting [DISABLE] AMX Device Discovery will not detect the device.
------------	--

CRESTRON Settings

Click on “CRESTRON” on the left column below HOME.

CRESTRON ROOMVIEW compatibility

The monitor supports CRESTRON ROOMVIEW, allowing multiple devices connected in the network to be managed and controlled from a computer or a controller.

For further information, visit <http://www.crestron.com>

ROOMVIEW	ROOMVIEW for managing from the computer. ON: Enables ROOMVIEW. OFF: Disables ROOMVIEW.
CRESTRON CONTROL	CRESTRON CONTROL for managing from the controller. ON: Enables CRESTRON CONTROL. OFF: Disables CRESTRON CONTROL.
CONTROLLER IP ADDRESS	Sets the IP address of the CRESTRON SERVER.
IP ID	Sets your CRESTRON SERVER IP ID.

HINT: The CRESTRON settings are required only for use with CRESTRON ROOMVIEW.
For further information, visit <http://www.crestron.com>

Name Settings

Click on “NAME” on the left column below HOME.

MONITOR NAME	Allows you to customize the monitor's name, up to a maximum of 16 characters long. This name is displayed when searching for devices on the network when using an application such as NaViSet Administrator. Giving the monitor a unique name allows it to be easily identified when viewing a list of monitors on the network. The default name is the monitor's model name.
Host Name (CONTROL)	Type in the hostname of the monitor which is connected to the network. Up to 15 alphanumeric characters can be used.
HOST NAME (MP)	Type in the hostname of the network to be used in the Media Player connected to the monitor. Up to 15 alphanumeric characters can be used.
Domain Name	Type in the domain name of the network which is connected with the monitor. Up to 60 alphanumeric characters can be used.

Network Service Settings

Click on “NETWORK SERVICE” on the left column below HOME.

PJLink CLASS	Set a class for PJLink*. NOTE: PJLink is a network interface standard that JBMIA established. http://pjlink.jbmia.or.jp/index.html This monitor is available for class1 and class2 command.
NOTIFY FUNCTION ENABLE	Enable or disable a notification of the monitor network condition. This function is only for class2.
NOTIFY ADDRESS	Set an IP ADDRESS to which the monitor network status will be sent. This function is only for class2.
PJLink PASSWORD	Set a password for PJLink*. The password must be max. 32 characters long. Do not forget your password. If you forget your password, consult your supplier.
HTTP PASSWORD	Set a password for the HTTP server. The password must be max. 10 characters long.
HTTP PASSWORD ENABLE	An HTTP PASSWORD is required when logging into the HTTP server. Set the monitor name as the USER NAME when entering the password.

*What is PJLink?

PJLink is a standardization of protocol used for controlling devices of different manufacturers. This standard protocol was established by Japan Business Machine and Information System Industries Association (JBMIA) in 2005.

The device supports all commands of PJLink.

PD LIST Information

Click on “PD LIST” on the left column below HOME.

Shows a list of monitor IDs and IP addresses of multiple monitors which are daisy-chained.

NOTE: Only the master monitor can show the list.

MEMO Settings

Click on “MEMO” on the left column below HOME.

Use the MEMO settings to define text that can be viewed on-screen when a user selects MEMO in the OSD menu. For example, if you want to provide contact information for customer service at your company, that information can be entered here.

Note that the MEMO text cannot be set from the monitor’s OSD menu using the remote control. The MEMO text must be added in the fields in this section. The message is displayed on the monitor screen.

TITLE	The title must be max. 24 characters long.
MESSAGE	A message must be max. 240 characters long.
MEMO PASSWORD	The default is “0000”.
MEMO PASSWORD ENABLE	A MEMO PASSWORD is required when selecting MEMO PASSWORD ENABLE.

SD-CARD VIEWER setting

Click “SD-CARD VIEWER” on the left side of HOME.

Please refer to Using SHARED SD card SETTINGS. See [page 63](#).

Intelligent Wireless Data

This function can be used to get the monitor status via wireless communication, even when the main power off. Some of the OSD options can also be set using this method.

To use this function it must be turned on in the OSD settings [DISPLAY PROTECTION] → [INTELLI.WIRELESS DATA], and the wireless app must be installed on a compatible mobile device. This function is enabled by default. At this time, the mobile application is only available for Android devices. Please refer to the NEC website for more information.

- NOTE:**
- Sensor position: See [page 19](#) and [page 20](#).
 - Please contact your supplier for detailed information.
 - Complied with ISO 15693.

Function name
Setting Copy
Setting read and write function
Display information
Security Setting

Proof of Play

This function allows sending of messages for the current status of the monitor by self-diagnosis.

For the Proof of Play function including self-diagnosis, please see the “External_Control.pdf”. See [page 98](#).

Check item		Message
①	INPUT	DVI, DisplayPort1, DisplayPort2, HDMI1, HDMI2, OPTION*, MP, VGA (RGB/YpPr), VIDEO
②	Resolution	e.g. (H)1920, (V)1080, (H)1360, (V)768 or No signal or Invalid signal
③	AUDIO INPUT	IN1, IN2, DisplayPort1, DisplayPort2, HDMI1, HDMI2, OPTION*, MP
④	Audio signal	Audio in or No Audio in or N/A (IN1, IN2, OPTION (analog)*)
⑤	Picture Image	Normal Picture or No Picture
⑥	AUDIO OUT	Normal Audio or No Audio
⑦	TIME	(year)/(month)/(day)/(hour)/(minutes)/(second)
⑧	EXPANSION DATA	00h: Normal Proof of Play event 01h: Proof of Play event is “last power on time” 10h: MEDIA PLAYER is stop 11h: MEDIA PLAYER is start 12h: MEDIA PLAYER is pause 13h: MEDIA PLAYER error occur 20h: Contents Copy from USB 21h: Contents Copy form network folder 30h: Contents Copy Success 31h: Contents Copy Error (No media) 32h: Contents Copy Error (Connect error) 33h: Contents Copy Error (Out of disk space) 34h: Contents Copy Error (Read/Write error) 40h: Human detected (Human sensor Status) 41h: Human detect cleared (Human Sensor Status)

*: This function depends on which Option Board installed in the monitor.

Example:

- ① HDMI1
- ② 1920 x 1080
- ③ HDMI1
- ④ IN1
- ⑤ Normal Picture
- ⑥ Normal Audio
- ⑦ 2014/1/1/0h/0m/0s
- ⑧ 10h: MEDIA PLAYER is stop

Chapter 8 Troubleshooting

This Chapter Includes:

- ⇒ “Screen Image and Video Signal Issues” on page 91
- ⇒ “Hardware Issues” on page 92
- ⇒ “Image Persistence” on page 94

Screen Image and Video Signal Issues

No picture

- The signal cable should be completely connected to the display card/computer.
- The display card should be completely seated in its slot.
- Check the main Power Switch, it should be in the ON position.
- Make sure both the computer and monitor are powered on.
- Make sure that a supported resolution has been selected on the display card or system being used. If in doubt, please refer to the user's manual of the display controller or system to change the resolution.
- Check the monitor and your display card with respect to compatibility and recommended signal timings.
- Check the signal cable connector for bent or pushed-in pins.
- The monitor automatically goes into standby at the preset time period after the video signal is lost. Press the power on button on the remote control or press the  button on the monitor.
- Check the [DVI MODE] settings when a DVD player or computer equipment is connected to the DVI input.
- If you unplug the signal cable when starting the computer, images may not be displayed. Turn off the monitor and the computer and then connect the signal cable and turn on the computer and the monitor.
- Check the [OPTION POWER] setting when you use Option Board accessories.
- Check for HDCP (High-bandwidth Digital Content Protection) content. HDCP is a system for preventing illegal copying of video data sent over a digital signal. If you are unable to view material via the digital inputs, this does not necessarily mean that the monitor is not functioning properly. With the implementation of HDCP, there may be cases in which certain content is protected by HDCP and might not be displayed due to the decision/intention of the HDCP community (Digital Content Protection, LLC).

Snowy Picture, Black Screen in DVI input

- Check the DVI MODE setting when a DVD player or computer equipment is connected to the DVI input.

Image persistence

- Please be aware that LCD Technology may experience a phenomenon known as Image Persistence. Image Persistence occurs when a residual or "ghost" image of a previous image remains visible on the screen. Unlike CRT monitors, the image persistence of monitors is not permanent, but single still image being displayed for a long period of time should be avoided. To alleviate image persistence, put the monitor into standby via remote control or turn the monitor's main power off for as long as the previous image was displayed. For example, if an image was on the monitor for one hour and a residual image remains, the monitor should be in standby or main power off for one hour to erase the image.

NOTE: As with all personal display devices, NEC DISPLAY SOLUTIONS recommends displaying moving images, using a moving screen saver, or changing still images at regular intervals whenever the screen is idle, or turning it into standby or main power off of the monitor when not in use.

The image is blinking

- If you use a signal repeater or distributor or a long cable, this may cause image roughness or blink for a moment. In this case please connect the cable to the monitor directly without using a repeater or a distributor, or replace the cable with a higher quality cable. Using a twisted pair extender may cause image roughness depending on the environment where the monitor is in or the cable you are using. For further information please ask your supplier.
- Some HDMI cables may not show a correct image. If input resolution is 1920 x 2160, 3840 x 2160 or 4096 x 2160, please use an HDMI cable which is approved to support 4K resolution.

The image is unstable, unfocused or swimming is apparent

- The signal cable should be completely attached to the computer.
- Please adjust settings in the [ADJUST] of the [PICTURE MODE] by checking displayed image on the screen.
- When the display mode is changed, the OSD Image Adjust settings may need to be re-adjusted.
- Check the monitor and your display card with respect to compatibility and recommended signal timings.
- If text looks garbled, change the video mode to non-interlaced and use a 60 Hz refresh rate.
- The image may be distorted when turning the power on or changing the settings.

The image of component signal is greenish

- Check to see if the VGA (YPbPr) input connector is selected.

The image is not properly reproduced

- Use the OSD Image Adjust controls to increase or decrease the coarse adjustment.
- Make sure that a supported resolution has been selected on the display card or system being used.
- If in doubt, please refer to the user's manual of the display card or system to change the resolution.

Either light vertical or horizontal stripes may appear, depending on the specific image pattern. This is not a product fault or degradation.

Selected resolution is not displayed properly

- Check the Information OSD to verify the appropriate resolution has been selected.
- If the resolution you set is over or under a range, "OUT of RANGE" window will appear then warn you. Please set supported resolution at the connected computer.

Video contrast is either too high or too low

- Check that the correct option for the VIDEO LEVEL is selected for the input signal. This only applies to video signals on the DisplayPort, HDMI, and OPTION inputs.
 - **Blacks are crushed and whites are clipped** - change the VIDEO LEVEL to RAW. Crushing blacks and clipping whites can occur when the monitor's VIDEO LEVEL is set to EXPAND while the source video signal's color levels are RGB Full (RGB 0-255), causing lost details in the shadows and highlights and the image appears overly high in contrast.
 - **Blacks are dark grey and whites are dull** - change the VIDEO LEVEL to EXPAND. Dulling blacks and whites can occur when the VIDEO LEVEL is set to RAW while the source video signal's color levels are RGB Limited (RGB 16-235), which effectively appears to prevent the monitor from obtaining its full brightness range and the image appears to be lacking in contrast.

Hardware Issues

⏻ button does not respond

- Unplug the power cord of the monitor from the AC outlet to turn off and reset the monitor.
- Check the main Power Switch on the monitor.

No Sound

- Check to see if the audio cable is properly connected.
- Check to see if [MUTE] is activated. Use the remote control to enable or disable the Mute function.
- Check to see if [VOLUME] is set to a minimum.
- Check to see if the computer supports an audio signal through DisplayPort.

If unsure, contact your supplier.

- When [LINE OUT] is not functioning, check to see if [SURROUND] is [ON].
- If HDMI CEC audio device is not connected, please set [AUDIO RECEIVER] to [OFF].

The Remote Control is not functioning

- The batteries may be drained. Please change the batteries, then check if the remote control works.
- Check that the batteries are inserted correctly.
- Check that the Remote Control is pointing at the remote control sensor of the monitor.
- Check the status of [IR LOCK SETTINGS].
- The remote control system may not function when direct sunlight or strong illumination strikes the remote control sensor of the monitor, or when there is an object in the path.

The SCHEDULE/OFF TIMER function is not working properly

- The [SCHEDULE] function will be disabled when the [OFF TIMER] is set.
- If the [OFF TIMER] function is enabled and the power to the monitor is turned off when the power supply is interrupted unexpectedly, then the [OFF TIMER] will be reset.

Snowy Picture, Poor Sound in TV

- Check antenna/cable connection. Use new cable if necessary.

The USB Hub does not operate

- Check to make sure that the USB cable is properly connected. Refer to your USB device user's manual.
- Check that the USB upstream port on the monitor is connected to the USB downstream port on the computer. Please make sure the computer is [ON] or [USB POWER] is [ON].
- Disconnect one upstream USB cable when using 2 upstream connections.

Interference in TV

- Check components for shielding, move away from monitor if necessary.

USB or RS-232C or LAN control is not available

- Check RS-232C (reverse type) or the LAN cable. A category 5 or higher LAN cable is required for connection.
- Check USB cable connected to USB2 port. Check the [EXTERNAL CONTROL] is set to [ENABLE] then [PC SOURCE] is set to [EXTERNAL PC].

The monitor goes into standby automatically

- Please check [OFF TIMER] setting.
- Set the [CEC] function to [OFF]. The monitor may go into standby mode when a connected CEC supported device goes into standby.
- Please check [POWER] in the [SCHEDULE SETTINGS].

Media player function does not recognize the USB storage device

- Check that a USB storage device is connected to the Media Player USB port.
- Check the file format of the USB storage device if it is not recognized by the monitor.

MicroSD memory card does not work

- Check that the microSD memory card is properly connected.
- Check the microSD memory card format.

LED Indicator Patterns

LED on the monitor is not lit (no blue or red color can be seen) (see [page 32](#))

- Make sure the power cord is properly connected to the monitor and the wall, and make sure the monitor's main power switch is ON.
- Make certain the computer is not in a power-saving mode (touch the keyboard or move the mouse).
- Check that the [POWER INDICATOR] is set to [ON] in the [CONTROL] settings of the OSD menu.

LED colors, except for blue, are blinking or glowing

- A certain failure might have occurred, please contact your supplier.
- If the monitor is powered off by the internal temperature being higher than the normal operating temperature, the LED will blink green or amber or red for six times. Please leave the monitor for cool down for few minutes then turn it on again.
- The monitor could be in standby.

Press the power on button on the remote control or press the  button on the monitor.

Image Persistence

Please be aware that LCD Technology may experience a phenomenon known as Image Persistence. Image Persistence occurs when a residual or “ghost” image of a previous image remains visible on the screen. Unlike CRT monitors, LCD panel monitors’ image persistence is not permanent, but constant images being displayed for a long period of time should be avoided.

To alleviate image persistence, turn off the monitor’s main power or set it to standby for as long as the previous image was displayed. For example, if an image was on the monitor for one hour and a residual image remains, the monitor’s main power should be turned off or set it to standby for one hour to erase the image.

As with all personal display devices, NEC DISPLAY SOLUTIONS recommends displaying moving images and using a moving screen saver at regular intervals whenever the screen is idle, or turn off the monitor’s main power or set it to standby when not in use.

Please set [SCREEN SAVER], [DATE & TIME] and [SCHEDULE SETTINGS] functions to further reduce the risk of Image persistence.

For long life use as a Public Display

Image Sticking of LCD Panel

When an LCD panel is operated continuously for long hours, a trace of electric charge remains near the electrode inside the LCD and a residual or “ghost” image of the previous image may be observed. (Image Persistence)

Image Persistence is not permanent, but when a fixed image is displayed for long period, ionic impurities inside the LCD are accumulated along the displayed image and may be permanent. (Image Sticking)

Recommendations

To prevent Image Sticking, and for longer life usage of the monitor, the following is recommended.

- Fixed image should not be reproduced for long period. Change still images after short intervals.
- When not in use, please turn off the monitor via remote control, or use the Power Management function of the PC, or use the built-in Schedule Functions.
- Lower environmental temperatures prolong the lifespan of the monitor.

When a protective surface (glass, acrylic) is installed over the monitor’s screen surface, the monitor’s screen surface is located in an enclosure, utilize the temperature sensors inside the monitor.

To reduce the internal temperature, use the Cooling Fans, Screen Saver, the Power Management function of the PC and Low Brightness.

- Please use “Screen Saver Mode” of monitor.

This Chapter Includes:

- ⇒ “UN552” on page 96
- ⇒ “UN552V” on page 97

[Notice] About the MPEG-4 AVC, MPEG-4 Visual license included in this product

1. MPEG AVC

THIS PRODUCT IS LICENSED UNDER THE AVC PATENT PORTFOLIO LICENSE FOR THE PERSONAL USE OF A CONSUMER OR OTHER USES IN WHICH IT DOES NOT RECEIVE REMUNERATION TO (i) ENCODE VIDEO IN COMPLIANCE WITH THE AVC STANDARD (“AVC VIDEO”) AND/OR (ii) DECODE AVC VIDEO THAT WAS ENCODED BY A CONSUMER ENGAGED IN A PERSONAL ACTIVITY AND/OR WAS OBTAINED FROM A VIDEO PROVIDER LICENSED TO PROVIDE AVC VIDEO. NO LICENSE IS GRANTED OR SHALL BE IMPLIED FOR ANY OTHER USE. ADDITIONAL INFORMATION MAY BE OBTAINED FROM MPEG LA, L.L.C. SEE [HTTP://WWW.MPEGLA.COM](http://www.mpegla.com)

2. MPEG-4 Visual

THIS PRODUCT IS LICENSED UNDER THE MPEG-4 VISUAL PATENT PORTFOLIO LICENSE FOR THE PERSONAL AND NON-COMMERCIAL USE OF A CONSUMER FOR (i) ENCODING VIDEO IN COMPLIANCE WITH THE MPEG-4 VISUAL STANDARD (“MPEG-4 VIDEO”) AND/OR (ii) DECODING MPEG-4 VIDEO THAT WAS ENCODED BY A CONSUMER ENGAGED IN A PERSONAL AND NONCOMMERCIAL ACTIVITY AND/OR WAS OBTAINED FROM A VIDEO PROVIDER LICENSED BY MPEG LA TO PROVIDE MPEG-4 VIDEO. NO LICENSE IS GRANTED OR SHALL BE IMPLIED FOR ANY OTHER USE. ADDITIONAL INFORMATION INCLUDING THAT RELATING TO PROMOTIONAL, INTERNAL AND COMMERCIAL USES AND LICENSING MAY BE OBTAINED FROM MPEG LA, LLC. SEE [HTTP://WWW.MPEGLA.COM](http://www.mpegla.com).

Product Specifications

LCD Module		Pixel Pitch: Resolution: Color: Brightness: Contrast Ratio: Viewing Angle:	55"/138.8 cm diagonal 0.630 mm 1920 x 1080 Over 1073 million colors (depending on display card used) 700 cd/m ² (Max.) @25 °C 1200:1 89° (typ) @ CR>10
Frequency		Horizontal: Vertical:	15.625/15.734 kHz, 31.5 kHz - 91.1 kHz 50.0 - 85.0 Hz (Analog Input) 24.0 - 85.0 Hz (Digital Input)
Pixel Clock			Analog: 13.5 MHz, 25.0 MHz - 200.0 MHz Digital: 25.0 MHz - 165.0 MHz (DVI), 25.0 MHz - 600.0 MHz (HDMI/DisplayPort)
Viewable Size			1209.60 x 680.40 mm
Input Signal			
DVI	DVI-D 24pin	Digital RGB	DVI (HDCP 1.4) VGA60, SVGA60, XGA60, WXGA60, SXGA60, UXGA60*1, 1920X1080 (60 Hz), 1080p, 1080i
DisplayPort	DisplayPort Connector	Digital RGB	DisplayPort V1.2 (HDCP 1.3) VGA60, SVGA60, XGA60, WXGA60, SXGA60, UXGA60*1, WUXGA60*1, 1920x1080 (60 Hz), 1080p, 1080i, 720p@50 Hz/60 Hz, 576p@50 Hz, 480p@60 Hz, 3840x2160 (24 Hz/30 Hz/60 Hz (DisplayPort1.2))*1.*3
VGA (RGB)*4	Mini D-Sub 15-pin	Analog RGB	0.7 Vp-p/75 ohm VGA60, SVGA60, XGA60, WXGA60, SXGA60, UXGA60*1, WUXGA60*1, 1920X1080 (60 Hz)
		Sync	Separate: TTL level (Pos./Neg.) Composite sync on Green Video: 0.3 Vp-p Neg.
HDMI	HDMI Connector	Digital YUV Digital RGB	HDMI (HDCP 1.4/2.2) VGA60, SVGA60, XGA60, WXGA60, SXGA60, UXGA60*1, WUXGA60*1, 1920x1080 (60 Hz), 1080p, 1080i, 720p@50 Hz/60 Hz, 576p@50 Hz, 480p@60 Hz, 576i@50 Hz, 480i@60 Hz, 3840x2160 (30 Hz/24 Hz/25 Hz/60Hz (MODE2))*1.*3, 4096x2160 (24 Hz)*1.*3
VGA (YPbPr)*4	Mini D-Sub 15-pin	Component	Y: 1.0 Vp-p/75ohm, Cb/Cr (Pb/Pr): 0.7 Vp-p/75 ohm HDTV/DVD: 1080p, 1080i, 720p@50 Hz/60 Hz, 576p@50 Hz, 480p@60 Hz, 576i@50 Hz, 480i@60 Hz
Output Signal			
DisplayPort	DisplayPort Connector	Digital RGB	DisplayPort V1.2 (HDCP 1.3)
HDMI	HDMI Connector	Digital RGB	HDMI (HDCP 1.4/2.2)
AUDIO			
AUDIO Input	Stereo Mini Jack	Analog Audio	Stereo L/R 0.5 Vrms
	HDMI Connector	Digital Audio	PCM 32, 44.1, 48 kHz (16/20/24 bit)
	DisplayPort Connector	Digital Audio	PCM 32, 44.1, 48 kHz (16/20/24 bit)
AUDIO Output	Stereo Mini Jack	Analog Audio	Stereo L/R 0.5 Vrms
Speaker Output			External Speaker Jack 15 W + 15 W (8 ohm)
Control		RS-232C In: LAN: Remote IN:	D-Sub 9-pin RJ-45 10 BASE-T/100 BASE-TX x 2 Stereo Mini Jack 3.5 mm Ø
SD card Hub			Port: microSD card. Up to 32 GB microSDHC is supported.
USB Hub		USB1 (SENSOR): USB2: USB CM1 (2A): USB CM2: Media Player USB:	USB 2.0 Downstream port USB 2.0 Upstream port Power supply port, 5 V/2 A (max.) USB service port for maintenance Media Player/Firmware update port
Power Supply			4.2-1.7 A @ 100-240V AC, 50/60 Hz
Power Consumption		Normal operation:	Approx. 150 W
Operational Environment		Temperature*2: Humidity: Altitude:	0 - 40 °C / 32 - 104 °F, 0 - 35 °C / 32 - 95 °F (Slot 2 type PC with Face up position or with Face down position) 20 - 80 % (without condensation) 0 - 3000 m (Brightness may decrease with altitude)
Storage Environment		Temperature: Humidity:	-20 - 60 °C / -4 - 140 °F 10 - 90 % (without condensation) / 90 % - 3.5 % x (Temp - 40 °C) regarding over 40 °C
Dimension (without SIDE SEAL)*5			1213.4 (W) x 684.2 (H) x 103.8 (D) mm/47.77 (W) x 26.94 (H) x 4.09 (D) inches (without handle) 1213.4 (W) x 684.2 (H) x 107.2 (D) mm/47.77 (W) x 26.94 (H) x 4.22 (D) inches (with handle)
Weight			28.1 kg (61.9 lbs)
VESA compatible mounting interface			400 mm x 400 mm (M6, 4 Holes)
Power Management			VESA DPM
Power supply for Slot 2 type OPTION			16 V/3.6 A

NOTE: Technical specifications are subject to change without notice.

*1: Compressed image.

*2: When you use Option Board accessories, please contact your supplier for detailed information.

*3: Reproduced text may look blurred.

*4: Common terminal.

*5: Measurements are of the monitor only and do not include removable parts that protrude.

Product Specifications

LCD Module		Pixel Pitch: Resolution: Color: Brightness: Contrast Ratio: Viewing Angle:	55"/138.8 cm diagonal 0.630 mm 1920 x 1080 Over 1073 million colors (depending on display card used) 500 cd/m ² (Max.) @25 °C 1200:1 89° (typ) @ CR>10
Frequency		Horizontal: Vertical:	15.625/15.734 kHz, 31.5 kHz - 91.1 kHz 50.0 - 85.0 Hz (Analog Input) 24.0 - 85.0 Hz (Digital Input)
Pixel Clock		Analog: 13.5 MHz, 25.0 MHz - 200.0 MHz Digital: 25.0 MHz - 165.0 MHz (DVI), 25.0 MHz - 600.0 MHz (HDMI/DisplayPort)	
Viewable Size		1209.60 x 680.40 mm	
Input Signal			
DVI	DVI-D 24pin	Digital RGB	DVI (HDCP 1.4) VGA60, SVGA60, XGA60, WXGA60, SXGA60, UXGA60* ¹ , 1920X1080 (60 Hz), 1080p, 1080i
DisplayPort	DisplayPort Connector	Digital RGB	DisplayPort V1.2 (HDCP 1.3) VGA60, SVGA60, XGA60, WXGA60, SXGA60, UXGA60* ¹ , WUXGA60* ¹ , 1920x1080 (60 Hz), 1080p, 1080i, 720p@50 Hz/60 Hz, 576p@50 Hz, 480p@60 Hz, 3840x2160 (24 Hz/30 Hz/60 Hz (DisplayPort1.2))* ¹ ,* ³
VGA (RGB)* ⁴	Mini D-Sub 15-pin	Analog RGB	0.7 Vp-p/75 ohm VGA60, SVGA60, XGA60, WXGA60, SXGA60, UXGA60* ¹ , WUXGA60* ¹ , 1920X1080 (60 Hz)
		Sync	Separate: TTL level (Pos./Neg.) Composite sync on Green Video: 0.3 Vp-p Neg.
HDMI	HDMI Connector	Digital YUV Digital RGB	HDMI (HDCP 1.4/2.2) VGA60, SVGA60, XGA60, WXGA60, SXGA60, UXGA60* ¹ , WUXGA60* ¹ , 1920x1080 (60 Hz), 1080p, 1080i, 720p@50 Hz/60 Hz, 576p@50 Hz, 480p@60 Hz, 576i@50 Hz, 480i@60 Hz, 3840x2160 (30 Hz/24 Hz/25 Hz/60Hz (MODE2))* ¹ ,* ³ , 4096x2160 (24 Hz)* ¹ ,* ³
VGA (YPbPr)* ⁴	Mini D-Sub 15-pin	Component	Y: 1.0 Vp-p/75ohm, Cb/Cr (Pb/Pr): 0.7 Vp-p/75 ohm HDTV/DVD: 1080p, 1080i, 720p@50 Hz/60 Hz, 576p@50 Hz, 480p@60 Hz, 576i@50 Hz, 480i@60 Hz
Output Signal			
DisplayPort	DisplayPort Connector	Digital RGB	DisplayPort V1.2 (HDCP 1.3)
HDMI	HDMI Connector	Digital RGB	HDMI (HDCP 1.4/2.2)
AUDIO			
AUDIO Input	Stereo Mini Jack	Analog Audio	Stereo L/R 0.5 Vrms
	HDMI Connector	Digital Audio	PCM 32, 44.1, 48 kHz (16/20/24 bit)
	DisplayPort Connector	Digital Audio	PCM 32, 44.1, 48 kHz (16/20/24 bit)
AUDIO Output	Stereo Mini Jack	Analog Audio	Stereo L/R 0.5 Vrms
Speaker Output		External Speaker Jack 15 W + 15 W (8 ohm)	
Control		RS-232C In: LAN: Remote IN:	D-Sub 9-pin RJ-45 10 BASE-T/100 BASE-TX x 2 Stereo Mini Jack 3.5 mm Ø
SD card Hub		Port: microSD card. Up to 32 GB microSDHC is supported.	
USB Hub		USB1 (SENSOR): USB2: USB CM1 (2A): USB CM2: Media Player USB:	USB 2.0 Downstream port USB 2.0 Upstream port Power supply port, 5 V/2 A (max.) USB service port for maintenance Media Player/Firmware update port
Power Supply		3.6-1.4 A @ 100-240V AC, 50/60 Hz	
Power Consumption		Normal operation:	Approx. 110 W
Operational Environment		Temperature* ² : Humidity: Altitude:	0 - 40 °C / 32 - 104 °F, 0 - 35 °C / 32 - 95 °F (Slot 2 type PC with Face up position or with Face down position) 20 - 80 % (without condensation) 0 - 3000 m (Brightness may decrease with altitude)
Storage Environment		Temperature: Humidity:	-20 - 60 °C / -4 - 140 °F 10 - 90 % (without condensation) / 90 % - 3.5 % x (Temp - 40 °C) regarding over 40 °C
Dimension (without SIDE SEAL)* ⁵		1213.4 (W) x 684.2 (H) x 103.8 (D) mm/47.77 (W) x 26.94 (H) x 4.09 (D) inches (without handle) 1213.4 (W) x 684.2 (H) x 107.2 (D) mm/47.77 (W) x 26.94 (H) x 4.22 (D) inches (with handle)	
Weight		28.1 kg (61.9 lbs)	
VESA compatible mounting interface		400 mm x 400 mm (M6, 4 Holes)	
Power Management		VESA DPM	
Power supply for Slot 2 type OPTION		16 V/3.6 A	

NOTE: Technical specifications are subject to change without notice.

*¹: Compressed image.

*²: When you use Option Board accessories, please contact your supplier for detailed information.

*³: Reproduced text may look blurred.

*⁴: Common terminal.

*⁵: Measurements are of the monitor only and do not include removable parts that protrude.

Appendix A External Resources

Additional specification documents and accessories, and optional software applications referenced in this product manual are listed below.

NEC Display Solutions regional websites

Global: <https://www.nec-display.com/global/>

Asia-Pacific: <https://www.nec-display.com/ap/contact/>

North America: <https://www.necdisplay.com>

Europe, Russia, Middle East and Africa: <https://www.nec-display-solutions.com>

Japan: <https://www.nec-display.com/jp/>

Additional Documentation

“NEC LCD Monitor - External Control” PDF document

This document defines the communications protocol for externally controlling and querying the display via either RS-232C or LAN. The protocol uses encoded binary and requires calculation of checksums, and most functionality in the display can be controlled using these commands. A simpler protocol is also available for less demanding applications (see below).

This document is available for download from the NEC Display Solutions website in your region.

A Python programming language based SDK (Software Development Kit) is also available that encapsulates this communications protocol into a Python library for rapid development.

<https://github.com/NECDisplaySolutions/necpdsdk>

“Projector/ Monitor Common ASCII Control Command - Reference Manual” PDF document

This document defines the communications protocol for externally controlling the basic functions of the display via LAN using a simple English-like syntax. It is suitable for easy integration into existing control systems. Functionality such as controlling and querying the power state, video inputs, volume, and status is available. The protocol uses ASCII encoding and doesn't require calculation of checksums.

This document is available for download from the NEC Display Solutions website in your region.

“Raspberry Pi Compute Module - Setup Guide” PDF document



This document describes the features, installation, connectivity, and configuration of the Raspberry Pi Compute Module, which is an optional component available for this model. The required DS1-IF10CE Compute Module Interface Board and Raspberry Pi Compute Module are available separately. Please contact an authorized NEC dealer or visit the NEC Display Solutions website in your region for purchase information and availability.

This document can be downloaded from:

<https://www.nec-display.com/dl/en/manual/raspberrypi/>

Software

Software is available for download on the NEC Display Solutions global website.

https://www.nec-display.com/dl/en/dp_soft/lineup.html

NEC MultiProfiler Software



This free software provides complete control of the SpectraView Engine color settings in an easy-to-use application available for Microsoft Windows and macOS. The software can be used to emulate different color-spaces, perform printer output emulations using ICC Profiles and create 3D Look-Up Tables within the display. It requires a USB connection to the display.

The latest version of the MultiProfiler software is available on the NEC Display Solutions website.

NEC Display Wall Calibrator software



This software provides advanced video wall configuration and accurate color matching by calibrating the displays using an external color sensor. It is useful when setting up multi-display installations - such as a video wall - to achieve the best possible brightness and color matching between displays and configuring settings applicable to the video wall. The software, available for Microsoft Windows and macOS, is available for purchase and may require the use of a supported external color sensor. Please contact an authorized NEC dealer or see the NEC Display Solutions website in your region for purchase information and availability.

NaViSet Administrator software



This free software is an advanced and powerful network based control, monitoring and asset management system for NEC display monitors and projectors. The software is available for Microsoft Windows and macOS.

The latest version of the NaViSet Administrator software is available on the NEC Display Solutions website.

Intelligent Wireless Data App



This free software, available for Android OS devices equipped with an NFC sensor, provides access to read and write adjustment values and settings via the Intelligent Wireless Data sensor on the monitor, even when the monitor's main power is off.

Also available on: 

Hardware / Color Sensor

MDSVSENSOR3 USB Color Sensor

This customized X-Rite color sensor is required when using the stand-alone Color Calibration functions of this monitor, and can also be used with the NEC Display Wall Calibrator software listed above. Please contact an authorized NEC dealer or see the NEC Display Solutions website in your region for purchase information and availability.

Appendix B OSD Controls List

This Chapter Includes

- ⇒ "INPUT" on page 101
- ⇒ "PICTURE" on page 101
- ⇒ "AUDIO" on page 106
- ⇒ "SCHEDULE" on page 106
- ⇒ "MULTI-INPUT" on page 108
- ⇒ "OSD" on page 111
- ⇒ "MULTI-DISPLAY" on page 112
- ⇒ "DISPLAY PROTECTION" on page 116
- ⇒ "CONTROL" on page 117
- ⇒ "OPTION" on page 122
- ⇒ "SYSTEM" on page 122
- ⇒ "COMPUTE MODULE" on page 123

Default values can be provided on request.

INPUT

INPUT MENU	
DVI	Selects the input signals source.
HDMI1	
HDMI2	
DisplayPort1	
DisplayPort2	
VGA (RGB/YPbPr)	
VIDEO	
MP	
COMPUTE MODULE*1	
OPTION*2	

*1: This function is only available when Raspberry Pi Compute Module Interface Board and Raspberry Pi Compute Module are installed. See [page 98](#).

*2: This function depends on which option board you are using. This function is only available when option board is installed.

PICTURE

PICTURE MENU	
PICTURE MODE	<p>SpectraView Engine = OFF: Predefined picture modes [HIGHBRIGHT], [STANDARD], [sRGB], [CINEMA], [CUSTOM1], [CUSTOM2].</p> <p>SpectraView Engine = ON: Five customizable Picture Mode memories [1], [2], [3], [4] or [5]. See page 47.</p>
EMULATION*1	
3D LUT EMU.	<p>The 3D LUT (Look Up Table) is a three-dimensional table that maps colors into different color spaces. The SpectraView Engine inside this monitor allows complex color gamuts, such as those for color printers, to be emulated on the monitor directly. For example, this allows print previews or cinematic or color grading effects to be performed within the monitor itself.</p> <p>This feature is used with supporting software. 3D LUTs are uploaded to the monitor via application software.</p> <p>ON: Enables/Activates the 3D LUT function for the selected picture mode.</p> <p>OFF: Disables/Deactivates the 3D LUT function for the selected picture mode.</p> <p>Compare: In this mode, colors that lie outside the boundaries of the 3D LUT are shown in gray. It is useful for determining out of gamut colors.</p>
COLOR VISION EMU.	<p>Previews various typical human vision deficiencies and is useful for evaluating how people who have such deficiencies will perceive colors.</p> <p>This preview is available in types:</p> <ul style="list-style-type: none"> • P (Protanopia) • D (Deutanopia) • T (Tritanopia) <p>Grayscale can be used for evaluating contrast legibility.</p> <p>NOTE: Depending on the vision of the user, including those with color vision deficiency, there will be a variation in how the screen's color is seen and experienced. A simulation is used to illustrate the view of those with a color vision deficiency. It is not their actual view. The simulation is a reproduction of those with a strong color vision mode of type P, type D or type T. People with a slight color vision deficiency will experience little to no difference compared to those with normal color vision.</p>

*1: This function is available when [SPECTRAVIEW ENGINE] is set to [ON].

PICTURE MENU																					
6 AXIS COLOR TRIM ¹	With these controls, the standard color circle is divided into 6 separate ranges/areas: Reds, Yellows, Greens, Cyans, Blues, and Magentas. Each range can be individually adjusted in Hue, Saturation, and Offset (Brightness) for specific matching purposes. Neutral colors (grays) will not be impacted.																				
RED (HUE/SAT/OFFSET)	<p>HUE: Changes the actual color within its range on the color wheel without changing the saturation and offset. For example, the Red color range shifts reds towards Yellow or Magenta, the Yellow color range shifts yellows towards Red or Green, and so on.</p> <p>SAT. (Saturation): Changes the intensity of the color range without changing the hue and offset.</p> <p>OFFSET: Changes the brightness of the color range without changing the hue and saturation. e.g.: This is the color changes when Red color set to minimum value and maximum value at HUE/SAT./OFFSET.</p> <table border="1"> <thead> <tr> <th></th> <th>Minimum value</th> <th>0</th> <th>Maximum value</th> </tr> </thead> <tbody> <tr> <td>Default</td> <td></td> <td></td> <td></td> </tr> <tr> <td>HUE</td> <td></td> <td></td> <td></td> </tr> <tr> <td>SAT.</td> <td></td> <td></td> <td></td> </tr> <tr> <td>OFFSET</td> <td></td> <td></td> <td></td> </tr> </tbody> </table>		Minimum value	0	Maximum value	Default				HUE				SAT.				OFFSET			
		Minimum value	0	Maximum value																	
Default																					
HUE																					
SAT.																					
OFFSET																					
YELLOW (HUE/SAT/OFFSET)																					
GREEN (HUE/SAT/OFFSET)																					
CYAN (HUE/SAT/OFFSET)																					
BLUE (HUE/SAT/OFFSET)																					
MAGENTA (HUE/SAT/OFFSET)																					
PICTURE SETTING ¹																					
UNIFORMITY	<p>This function improves the color reproduction and evens out the non-uniformity in luminance of the monitor.</p> <p>NOTE: A higher number produces a better effect, but may also affect power consumption and lifetime of the monitor.</p>																				
BRIGHTNESS ²																					
BACKLIGHT	<p>Adjusts the overall image and background brightness. Press [+] or [-] to adjust.</p> <p>NOTE: When [MODE1] or [MODE2] is selected in [ROOM LIGHT SENSING], this function cannot be changed.</p>																				
BRIGHTNESS ³	Adjusts the image brightness in relationship to the background. Press [+] or [-] to adjust.																				
GAMMA ^{2, 3}	Select a monitor gamma correction for best picture quality. Selection depends on the desired usage.																				
NATIVE	Gamma correction is handled by the LCD panel.																				
2.2	Typical monitor gamma for use with a computer.																				
2.4	Typical gamma settings for use with videos, such as DVDs and Blu-rays.																				
S GAMMA	Special gamma for certain types of movies. Raises the light parts and lowers the dark parts of the image (S-Curve).																				
DICOM SIM.	DICOM GSDF curve simulated for LCD type.																				
HDR-ST2084 (PQ)	Gamma setting for HDR, typically for UHD disk media and streaming videos.																				
HDR-HYBRID LOG	Gamma setting for HDR, typically for UHD broadcasting.																				
PROGRAMMABLE1, 2, 3	A programmable gamma curve can be loaded using optional NEC software.																				
AUTO HDR SELECT HDMI input only	GAMMA correction of HDR signal automatically changes to [HDR-ST2084 (PQ)] or [HDR-HYBRID LOG].																				

*1: This function is available when [SPECTRAVIEW ENGINE] is set to [ON].

*2: This function is available when [SPECTRAVIEW ENGINE] is set to [OFF].

*3: This function is not available when [sRGB] is selected at [PICTURE MODE].

PICTURE MENU	
COLOR ^{*2, *3}	
COLOR	Adjusts the color saturation of the screen. Press + or - button to adjust.
COLOR TEMP	Adjusts the color temperature of the entire screen. A low color temperature will result in a reddish screen. A high color temperature will make the screen bluish. If TEMPERATURE needs further adjustment, the individual R/G/B/ levels of the white point can be adjusted. To adjust the R/G/B levels, set [CUSTOM] as [COLOR TEMP] selection. NOTE: When [PROGRAMMABLE1], [PROGRAMMABLE2] or [PROGRAMMABLE3] is selected in [GAMMA CORRECTION], this function cannot be changed.
COLOR CONTROL	Adjusts the hue of the Red, Yellow, Green, Cyan, Blue and Magenta colors individually. Adjust the hue of the specified color. For example, you can change red to yellow or purple.
HUE ^{*6} MP, VIDEO inputs only	Adjusts the hue for all colors with compatible video input signals. Press + or - button to adjust.
CONTRAST ^{*2, *3}	Adjusts the image brightness in relationship to the input signal. Press + or - button to adjust.
SHARPNESS	Adjusts the crispness of the image. Press + or - button to adjust.
UHD UPSCALING	Controls how non-UHD signal is scaled up to achieve a high-definition effect.
ADJUST	
AUTO SETUP VGA (RGB) input only	Automatically adjusts Screen Size, H position, V position, Clock, Phase and White Level.
AUTO ADJUST VGA (RGB) input only	[H POSITION], [V POSITION] and [PHASE] are adjusted automatically when new timing is detected.
H POSITION VGA (RGB), VGA (YPbPr) inputs only	Controls the horizontal position of the image within the display area of the LCD. Press + button to move right. Press - button to move left.
V POSITION VGA (RGB), VGA (YPbPr) inputs only	Controls the vertical position of the image within the display area of the LCD. Press + button to move up. Press - button to move down.
CLOCK VGA (RGB) input only	Press + button to expand the width of the image on the right of the screen. Press - button to narrow the width of the image on the left of the screen.
PHASE VGA (RGB), VGA (YPbPr) inputs only	Adjusts the visual "noise" in the image.
H RESOLUTION ^{*7} VGA (RGB) input only	Adjusts the horizontal size of the image.
V RESOLUTION ^{*7} VGA (RGB) input only	Adjusts the vertical size of the image.
COLOR SYSTEM VIDEO input only	The selected Color System depends on the video format of the input signal.
AUTO	Automatically chooses the Color System setting based on the input signal.
NTSC	Select a signal format.
PAL	
SECAM	
4.43 NTSC	
PAL-60	
INPUT RESOLUTION VGA (RGB) input only	If there is a problem with signal detection, this function forces the monitor to display the signal at the desired resolution. After selection, execute [AUTO SETUP] if required. If no problem is detected, the only available option will be [AUTO].

*2: This function is available when [SPECTRAVIEW ENGINE] is set to [OFF].

*3: This function is not available when [sRGB] is selected at [PICTURE MODE].

*6: This function is not available for still image on the MP input.

*7: We recommended running [AUTO SETUP] after individually adjusting this option.

PICTURE MENU	
ASPECT	<p>Select the aspect ratio of the screen image.</p> <p>NOTE:</p> <ul style="list-style-type: none"> When selecting an image flip option with the [ASPECT] set to [DYNAMIC], the aspect will automatically change to [FULL]. Aspect will return to [DYNAMIC] after [NONE] is set to the [IMAGE FLIP]. When starting tile matrix in multi-display installations, if the [ASPECT] is [DYNAMIC] or [ZOOM] it will be changed to [FULL] before tile matrix starts. After tile matrix is complete, the aspect will return to [DYNAMIC] or [ZOOM]. If you change [H POSITION] and [V POSITION] settings with a reduced image, the image would not be changed. The ASPECT automatically changes to FULL when the SCREEN SAVER starts. When the SCREEN SAVER stops, the ASPECT returns to its previous setting. This function is not available when [MOTION] in [SCREEN SAVER] is active. The [POINT ZOOM] function has limitations when [ASPECT] is changed. Please refer to Point Zoom on page 36. ZOOM is not available for an image with an input resolution of 3840 x 2160 (60 Hz). When [HDMI] of the [TERMINAL SETTINGS] is set to [MODE2], [POINT ZOOM] is not available. If the [ASPECT] is [DYNAMIC] or [ZOOM] while tile matrix is active, when tile matrix is released, the [ASPECT] will be either [DYNAMIC] or [ZOOM].
NORMAL	Shows the aspect ratio as it is sent from the source.
FULL	Fills the entire screen.
WIDE	Expands a 16:9 letterbox signal to fill the entire screen.
DYNAMIC	Expands 4:3 pictures to fill the entire screen with non-linearity image. Part of the outside image area will be cut off due to expansion.
1:1	Shows the image in a 1 by 1 Pixel format. (If the input resolution is higher than the recommended resolution, the image will be scaled down to fit the screen).
ZOOM	<p>Expands/reduces the image.</p> <p>NOTE: The areas of the expanded image that are outside of the active screen area are not shown. The reduced image may have some image degradation.</p>
ZOOM	Maintains the aspect ratio while zooming.
HZOOM	Horizontal zoom value.
VZOOM	Vertical zoom value.
H POS	Horizontal position.
V POS	Vertical position.
ADVANCED	
OVERSCAN HDMI1, HDMI2, VGA (YPbPr), VIDEO, MP, OPTION*5 inputs only	Some video formats may require different scanning modes in order to best display the image.
ON	<p>The image is scaled to best fit the screen without changing the aspect ratio. Some images will have cropped edges.</p> <p>Approximately 95 % of the image will be shown on the screen.</p>
OFF	<p>The whole image is displayed within the screen area. This setting may cause distorted image at the edges.</p> <p>NOTE: When you use a computer with HDMI out, please set [OFF].</p>
AUTO	<p>Image size is set automatically.</p> <p>NOTE: This function is not available if input signal is VGA (YPbPr), VIDEO or MP.</p>

*5: When you select OPTION for signal input, this function depends on which Option Board is installed in the monitor.

PICTURE MENU	
DEINTERLACE	Selects the IP (Interlace to Progressive) conversion function. NOTE: <ul style="list-style-type: none"> [IMAGE FLIP] is not available. When [SUPER] is selected in [INPUT CHANGE] and displayed, this function cannot be changed.
ON	Converts interlaced signals to progressive. Depending on the movie, images may flicker. This is the default setting.
OFF	Disables IP conversion. This setting is best suited for motion pictures, but increases the risk of image retention.
NOISE REDUCTION VIDEO input only	Adjusts the amount of noise reduction. Press + button or - button to adjust.
TELECINE HDMI1, HDMI2, VIDEO, VGA (YPbPr), MP inputs only	Automatically senses the sources frame rate for optimal picture quality. AUTO: It automatically detects images of 24 frames/sec such as movies, and reduces flicker of images. When selecting [AUTO], please set [DEINTERLACE] to [ON]. OFF: Try if the motion of the image is unnatural.
ADAPTIVE CONTRAST*2 HDMI1, HDMI2, VIDEO, VGA (YPbPr), MP inputs only	Sets the level of adjustment for dynamic contrast. If HIGH is set, the image is displayed clearly but it makes brightness unstable due to the wide gap in contrast variation.
UNIFORMITY*2	Improves the color reproduction and evens out the non-uniformity in luminance of the monitor.
ROTATION	Changes the orientation of the image to left/right, up/down, or rotated. Press + button or - button to select. NOTE: This function is not available when MOTION in [SCREEN SAVER] is [ON].
IMAGE FLIP	NOTE: <ul style="list-style-type: none"> When the [ASPECT] is set to [DYNAMIC], the image will be changed to [FULL] before [ROTATE] starts. When an IMAGE FLIP option is selected, except for [NONE], the following functions are disabled: [MULTI PICTURE MODE], [TEXT TICKER], [STILL], [POINT ZOOM] and [TILE MATRIX]. When the input signal is interlaced, the image may be distorted.
NONE	Normal mode. AB
H FLIP	Flips the image left/right. BA
V FLIP	Flips the image up/down. VB
180° ROTATE	Rotates the image 180 degrees. AB
OSD FLIP	Determines the OSD menu direction. If [ON] is selected, the OSD orientation will be adjusted based on the selection for [IMAGE FLIP].
SPECTRAVIEW ENGINE	Select [ON] to activate [SPECTRAVIEW ENGINE] (see page 47).
NUMBER OF PICT. MODES	Limits the number of selectable Picture Modes. Limiting the number of selectable Picture Modes can be used for the following purposes: <ul style="list-style-type: none"> Locking By setting to [1], it will prevent other Picture Modes from being accessed and adjusted. Skip If there are unused Picture Modes that aren't needed, they can be skipped when using the Picture Mode button on the remote control to toggle modes. For example, if [3] is set for [NUMBER OF PICT. MODES], the available picture modes are [1, 2, 3] and the other modes will be skipped.
METAMERISM	Improves the white point color matching when the display is used side-by-side with a standard gamut display monitor. This feature compensates for the way the human eye perceives colors slightly differently compared to the scientific instrument used to adjust the display during calibration. This function should be disabled in color critical applications.
COLOR STABILIZER (Not available)	
CALIBRATION	Starts the "Stand-Alone Calibration" when using a USB color sensor.
RESET	Resets all PICTURE settings back to factory settings except for [SPECTRAVIEW ENGINE].

*2: This function is available when [SPECTRAVIEW ENGINE] is set to [OFF].

AUDIO

AUDIO MENU	
VOLUME	Increase or decrease output volume level.
BALANCE	Select [STEREO] or [MONO] for the audio output.
BALANCE	STEREO: Independent audio channels for routing audio signal. Sound balance between the left and right speakers can be adjusted. - Press the + button to move the audio signal to the right. - Press the - button to move the audio signal to the left. MONO: Audio signals are routed through a single audio channel. Balance cannot be adjusted and the slider will be unavailable.
SURROUND	Artificially produces surround sound audio. NOTE: [LINE OUT] is disabled when this function is set to [ON].
EQUALIZER	
TREBLE	Accentuates or reduces the high frequency range of audio signals. Press the + button to increase [TREBLE]. Press the - button to decrease [TREBLE].
BASS	Accentuates or reduces the low frequency sound. Press the + button to increase [BASS]. Press the - button to decrease [BASS].
AUDIO INPUT	Selects the audio input source: [DVI], [HDMI1], [HDMI2], [DisplayPort1], [DisplayPort2], [IN1], [IN2], [VIDEO], [MP], [OPTION]*1 and [C MODULE].
MULTI PICTURE AUDIO	Selects which audio source to use when MULTI-PICTURE is enabled. When either picture is selected, the sound of that picture is output.
LINE OUT	Selecting [VARIABLE] enables control of the line out level with the VOLUME button on the remote control or monitor control panel.
AUDIO DELAY	
AUDIO DELAY	Select this option if there is a noticeable delay between the video image and the audio signal output. When this option is on, the audio signal can be delayed between 0 to 100 milliseconds. This allows delays in the video, that may occur due to video processing such as DEINTERLACE, to be matched by an equal delay in the audio signal to avoid lip-sync errors.
DELAY TIME	
RESET	Resets all AUDIO options back to factory settings, except for [VOLUME].

*1: This function depends on which Option Board installed in the monitor.

SCHEDULE

SCHEDULE MENU	
SCHEDULE SETTINGS	Creates a working schedule for the monitor (see page 46). Press the ▲, ▼, +, - buttons to navigate and change the schedule settings. Press the SET/POINT ZOOM button on the remote control or Input change buttons on the monitor to select settings. NOTE: <ul style="list-style-type: none"> • The [DATE & TIME] needs to be set before adding schedules. • Schedules you configure are saved when exiting the [SCHEDULE SETTINGS] window. • If multiple schedules are set to start at the same time, the conflicting schedule with the highest number is given priority. • Schedules will not run when the [OFF TIMER] is set to [ON]. • If an input signal or picture mode is no longer valid, it will display its text in red. Highlight the red text and press SET to change to a valid setting. For example, an input signal may become invalid if the Terminal Settings are changed for that input after it was selected for the schedule. • Schedules do not run while the [SCHEDULE SETTINGS] menu is open.
SETTINGS	Highlight the number and press SET/POINT ZOOM button to activate the schedule. The box next to the number has an outline when the schedule is enabled. Up to 30 schedules can be created and enabled. Press the + or - button to cycle through schedule numbers.
POWER	Sets the monitor's power state for the schedule. Select [ON] if you want the schedule to turn the monitor on at the specified time. Select [OFF] if you want the schedule to turn the monitor off at the specified time.

SCHEDULE MENU	
TIME	Set the start time for the schedule. NOTE: Fill in both fields for the TIME setting. If either field displays [--], the schedule does not run.
INPUT	Select which video input to use for the schedule. To keep the active input when the schedule starts, make sure the setting is [--]. If you do select a specific input, set [ON] at [POWER].
PIC. MODE ^{*1}	Select the picture mode to use for the schedule. To keep the active picture mode when the schedule starts, make sure the setting is [--]. If you do select a specific PIC. MODE, set [ON] at [POWER].
Select one item from below (only one item is available).	
DATE	Select this option if the schedule is only going to run on one day or it is an irregular schedule.
EVERY DAY	Select this option to have the schedule repeat every day.
EVERY WEEK	Select this option to have the schedule repeat every week.
WEEKDAY	Select this option to have the schedule run on weekdays only. NOTE: "Weekdays" are any day that is not a weekend day or a holiday day. Days which are not selected in the [WEEKEND] and [HOLIDAY] settings are automatically weekdays.
WEEKEND	Select this option to have the schedule run on weekends only. NOTE: "Weekend" days are chosen in the [WEEKEND SETTING] menu.
HOLIDAY	Select this option to have the schedule run only on the selected holiday. NOTE: "Holiday" days are added in the [HOLIDAY SETTINGS] menu.
SCHEDULE LIST	Shows the list of schedules and their current settings. Press the + or - button to scroll through the 30 schedules.
HOLIDAY SETTINGS	Defines which days are holidays for the SCHEDULE settings. Schedules configured with the selection to run on a [HOLIDAY] use this list.
No.	Defines which days are holidays for the schedule settings. Press the + or - button to cycle through the numbers to configure different holidays.
YEAR	Press the + or - button to cycle through to the year you want to use for the holiday. If the holiday repeats on the same day yearly, leave the field blank [--].
MONTH	Press the + or - button to cycle through to the month you want to use for the holiday. If the holiday repeats on the same day monthly, leave the field blank [--].
DAY	If the holiday is on a specific day in a month, such as the 5th, press SET to select DAY. Press the ▼ to highlight the day field, then press the + or - button to cycle through to the day you want to use for the holiday. NOTE: <ul style="list-style-type: none"> If the MONTH field is empty, the schedules that are configured to run on holidays will run on this day every month. If you select MONTH but do not set a specific day, the holiday is considered to be every day.
WEEK	If the holiday is on a specific week in a month, such as the 2nd Monday, press SET to select WEEK. Press the ▼ to highlight the week field, then press the + or - button to select which week in the month (select from: 1st, 2nd, 3rd, 4th, 5th). Press the ▼ button to highlight the day field, then press the + or - button to select which day in that week (select from: SUN, MON, TUE, WED, THU, FRI, SAT). NOTE: if the MONTH field is empty, the schedules that are configured to run on holidays will run on this week every month.
END DAY	Sets the last day of a multi-day holiday. NOTE: If a holiday that spans several days also splits across years, create separate holidays for each year. For example, if the holiday spans December 25th to January 7th, set two separate holidays. One for December 25th to the 31st, then another one for January 1st to the 7th.
SET/DELETE	Saves or deletes the current holiday. NOTE: If you are modifying an existing holiday, make sure to highlight SET then press SET on the remote to save the changes. If you press the EXIT button on the remote control without saving the changes, the settings will be discarded.
WEEKEND SETTING	Defines which days of the week are considered weekend days for the SCHEDULE settings. Schedules configured with the selection to run on either a WEEKDAY or WEEKEND use this list.
WEEKEND	Highlight the day you want to select as a weekend day, then press SET on the remote control.

*1: If SPECTRAVIEW ENGINE is ON, this function is grayed out.

SCHEDULE MENU	
DATE & TIME	<p>Set the date and time for the real-time clock. Date & time must be set in order for the [SCHEDULE] function to operate. After setting the date and time, press the SET button on the remote control to save the settings. Press EXIT to cancel the changes.</p> <p>NOTE: If the monitor's main power has been turned off for two weeks, the [DATE & TIME] setting goes back to the default setting and the clock function stops working.</p>
YEAR	Sets the current year. Press the + or - button on the remote control to cycle to the current year.
MONTH	Sets the current month. Press the + or - button on the remote control to cycle to the current month.
DAY	Sets the current day of the month. Press the + or - button on the remote control to cycle to the current day.
TIME	<p>Sets the current time. Highlight the hour field, then press the + or - button on the remote control to cycle to the current hour, then repeat this for the minutes field.</p> <p>NOTE:</p> <ul style="list-style-type: none"> The monitor's clock is a 24-hour format. If the monitor is at a location that is currently in Daylight Savings, set the TIME field to what the current time would be when Daylight Savings is not in effect. Then enable the [DAYLIGHT SAVING] function to have the clock automatically adjust to the current time.
CURRENT DATE TIME	Shows the current date and time. This data does not reflect changes to the Date and Time settings until SET is pressed on the remote control.
DAYLIGHT SAVING	<p>Automatically changes the real-time clock to match Daylight Savings hours.</p> <p>NOTE: Set the [DATE & TIME] before enabling the [DAYLIGHT SAVING] setting.</p>
DAYLIGHT SAVING	Automatically adjusts the current time, when Daylight Saving hours are in effect, based on the start and end dates selected in this menu.
BEGIN MONTH	Set the month, day and time for when Daylight Saving begins.
END MONTH	Set the month, day and time for when Daylight Saving ends.
TIME DIFFERENCE	Set the time difference for the real-time clock adjustment. When Daylight Saving starts, this is the amount of time the real-time clock will be adjusted.
OFF TIMER	<p>Powers off the monitor after the time period shown next to the slider. Press the + or - button on the remote control to adjust the timer from 1 to 24 hours.</p> <p>NOTE: Schedules do not run when the [OFF TIMER] is set to [ON].</p>
RESET	Resets all SCHEDULE options back to factory setting, except for [DATE & TIME] and [DAYLIGHT SAVING].

MULTI-INPUT

MULTI-INPUT MENU	
KEEP MULTI PICTURE MODE ^{*1}	<p>When this function is on, the [MULTI PICTURE MODE] or [TEXT TICKER] function automatically resumes when the monitor is powered off then on again.</p> <p>When this function is off, the [MULTI PICTURE MODE] and [TEXT TICKER] are automatically turned off when the monitor is powered off. They must be turned back on from their settings in the MULTI-INPUT menu or pressing the MULTI-PICTURE ON/OFF button on the Remote control.</p>
MULTI PICTURE MODE ^{*1, *3}	Displays content from multiple inputs.
MULTI PICTURE	<p>When this option is off, the current input is displayed.</p> <p>When this option is on, multiple inputs are displayed.</p> <p>Highlight ON and press SET on the remote control to enable this feature. Select either PIP (Picture-In-Picture) or PBP (Picture-By-Picture).</p> <p>PIP - a second input is displayed in an inset picture on the screen. The size and position of the inset picture can be adjusted.</p> <p>PBP - the different inputs are viewed next to each other.</p> <p>NOTE: When this option is enabled, these functions in the OSD are automatically released if they are currently enabled: [TEXT TICKER], [CLOSED CAPTION], [TILE MATRIX], [MOTION] in [SCREEN SAVER], any [IMAGE FLIP] option except [NONE], and [SUPER] in [INPUT CHANGE].</p>

*1: This function is released when selecting [SUPER] in [INPUT CHANGE], [MOTION] in [SCREEN SAVER], [TILE MATRIX] and [IMAGE FLIP] except for [NONE].

*3: When you select [OPTION] for input, this function depends on which Option Board installed in the monitor.

MULTI-INPUT MENU	
ACTIVE PICTURE ^{*1, *2}	<p>Selects which input is currently being configured for the MULTI-PICTURE MODE settings. When the OSD menu is closed, this is the input that is controlled by the remote control.</p> <p>NOTE:</p> <ul style="list-style-type: none"> When [MULTI PICTURE MODE] is on, the active picture can be switched between inputs by pressing the ACTIVE PICTURE button on the remote control instead of opening the OSD menu. When [ACTIVE FRAME] is [ON] (which is the default setting), press the ACTIVE PICTURE button one time to show a frame around the current active picture. Press the button again to switch between inputs. If one of the selected inputs is MP (Media Player), the player will not respond to button presses unless it is the active picture. When [MULTI PICTURE MODE] is turned off, whichever input is the current [ACTIVE PICTURE] is the input that will be displayed.
ACTIVE	When [MULTI PICTURE] is [OFF], [PICTURE 1] is the active picture. Selects the input to configure for the multi-picture settings and be controlled by the remote control.
ACTIVE FRAME	Turns off or on the red frame that shows around the active picture. This frame is shown when the OSD menu is open or when the ACTIVE PICTURE button on the remote control is pressed.
INPUT SELECT ^{*3, *5}	<p>Selects which input to use for each PICTURE displayed when [MULTI PICTURE MODE] is [ON].</p> <p>NOTE:</p> <ul style="list-style-type: none"> When changing the input for the PICTURE number that is the current ACTIVE PICTURE, for example [PICTURE1], the input is not changed unless SET is pressed on the remote control. When navigating away without pressing SET, the input name shown for that PICTURE will revert back to the current input for the ACTIVE PICTURE. When changing the input for the PICTURE that is not active, the change is immediately saved. This function is not available when [MULTI PICTURE MODE] is [OFF].
PICTURE1	
PICTURE2	
PICTURE SIZE ^{*1, *2, *4}	<p>Sets the size of the Active Picture. In PIP mode, only the inset picture (PICTURE2) can be adjusted. In PBP mode, as the Active Picture size is increased the other picture will automatically decrease, and vice versa when the Active Picture size is decreased.</p> <p>Use the + and - buttons on the remote control to increase or decrease the size of the Active Picture.</p>
PICTURE POSITION ^{*1, *2, *4}	<p>Sets the position of the Active Picture on the screen.</p> <p>Pressing the + button moves the Active Picture to the right, and pressing the - button moves it to the left. Pressing the ▲ button moves the Active Picture up, and pressing the ▼ button moves it down.</p> <p>NOTE: The Active Picture's position can be moved using the remote control without opening the OSD menu. Press the ACTIVE PICTURE button on the remote control to select the picture to move. Use the same buttons on the remote control to change the picture position. Note that when ACTIVE FRAME is on, a red outline will show around the Active Picture.</p> <p>In PIP mode, the inset picture window can be moved in all directions. In PBP mode, the Active Picture will only move either up/down (when the inputs are displayed side by side) or left/right (when the inputs are displayed top and bottom).</p>
PICTURE ASPECT ^{*1, *2, *4}	<p>Sets the aspect ratio for the Active Picture's frame content.</p> <p>To change aspect ratio of the screen image, see page 35.</p>
TEXT TICKER ^{*1, *3}	<p>Shows a portion of [PICTURE2] displayed either horizontally or vertically across the image of PICTURE1. This can be used to display, for example, a text ticker application.</p> <p>NOTE:</p> <ul style="list-style-type: none"> If [MULTI PICTURE MODE] is [ON], it will automatically turn [OFF] when [TEXT TICKER] is enabled. [TEXT TICKER] is automatically turned [OFF] when any of the following functions are enabled: [MULTI PICTURE MODE], [TILE MATRIX], [SCREEN SAVER], [IMAGE FLIP], [SUPER] in [INPUT CHANGE], [CLOSED CAPTION]. [POINT ZOOM] and [STILL] are not available when [TEXT TICKER] is enabled.
MODE	Select Horizontal or Vertical and press SET to enabled [TEXT TICKER].
POSITION	Moves the Text Ticker area.
SIZE	Adjusts the size of the Text Ticker area. The Text Ticker displays the top (when horizontal) or left (when vertical) portion of the second source. Adjusting the Text Ticker size determines how much of the top or left portion of the second source is displayed.
DETECT	Automatically turns the Text Ticker function on or off based on the presence of the input signal selected for [PICTURE2].
INPUT SELECT	Selects which inputs to use for the main picture (PICTURE1) and the secondary picture (PICTURE2).

*1: This function is released when selecting [SUPER] in [INPUT CHANGE], [MOTION] in [SCREEN SAVER], [TILE MATRIX] and [IMAGE FLIP] except for [NONE].

*2: When [TEXT TICKER] is active or multi picture is [OFF], this function is not available.

*3: When you select [OPTION] for input, this function depends on which Option Board installed in the monitor.

*4: This function is not available if [PIP] is set at [MULTI PICTURE MODE] and then [PICTURE1] is set at [ACTIVE PICTURE].

*5: This function is released when selecting [SUPER] in [INPUT CHANGE] or [TEXT TICKER] is active.

MULTI-INPUT MENU	
INPUT DETECT ^{*6}	<p>When enabled, this option can detect and change inputs when a signal is applied or lost.</p> <p>NOTE: This option is unavailable when these OSD menu options are enabled:</p> <ul style="list-style-type: none"> • [SUPER] is selected in the [INPUT CHANGE] settings. • [HUMAN SENSING] is [ENABLED] in the [AUTO DIMMING] settings in the [CONTROL] menu.
NONE	<p>The monitor does not search for video signal on the other input connections.</p> <p>If video signal is lost on the current input, or if the monitor is manually switched to an input that does not have video signal, the screen will go black and the LED will flash green. If [POWER SAVE] is enabled, the monitor will enter power saving mode after the period of time set for [POWER SAVE] has passed.</p>
FIRST DETECT ^{*3, *5}	<p>The monitor does not search for a video signal on the other input connections while the current input has a video signal.</p> <p>If the current input connection does not have video signal present, the monitor will search for video signal on the other video input connections. If a video signal is found, the monitor will switch from the current input to the input with the active video source automatically.</p>
LAST DETECT ^{*3, *5}	<p>The monitor actively searches for a video signal on the other input connections, even while the current video signal is present. When a new video signal source is applied to another input connection, the monitor automatically switches to the new found video source.</p> <p>If the video signal is lost on the current input connection, the monitor will search for video signal on the other video input connections. If a video signal is found, the monitor will switch from the current input to the input with the active video source automatically.</p>
CUSTOM DETECT ^{*3}	<p>The monitor only searches for video signal on the inputs selected for the priority numbers. If the signal is lost, the monitor searches for signal in the priority order and automatically switch to the highest priority input it finds with an active video signal. The monitor actively searches these input. If the current signal input is not Priority 1 and a new signal is applied to the input assigned to Priority 1, the monitor will automatically switch to the higher priority input.</p> <p>NOTE:</p> <ul style="list-style-type: none"> • Priority of an option board input signal is only available in [PRIORITY 3], except for a slot 2 type PC option. • If DisplayPort1 is set to PRIORITY [1], [2], or [3], the [OPTION] (slot 2 type PC option (DP)) input cannot be chosen for any of the priority settings. If [OPTION] (slot 2 type PC option (DP)) is set to PRIORITY [1], [2], or [3], the DisplayPort1 input cannot be chosen for any of the priority settings.
INPUT CHANGE	<p>Sets the speed at which the monitor changes to a different video input.</p> <p>Selecting QUICK increases the speed of changing inputs. Note that there may be image noise when switching signals.</p> <p>Selecting SUPER enables high-speed switching between the two input connections selected for INPUT1 and INPUT2. Power cycle the monitor after selecting this option.</p> <p>NOTE:</p> <ul style="list-style-type: none"> • Depending on the option board being used, OPTION may not be available to use with SUPER. The OPTION input will not show as selection for INPUT1 and INPUT2. • These options are not available when [SUPER] is active: [MULTI PICTURE MODE], [TEXT TICKER], [STILL], [POINT ZOOM]. • When you set [QUICK] then change input signal to DisplayPort, displaying image is distorted. • When a cable is connected to the HDMI OUT port, speed of changing input may not be faster. • When a cable is connected to the HDMI OUT port, if [QUICK] or [SUPER] is set, this setting causes image distorted while switching signals.
TERMINAL SETTINGS	Adjusts settings specific to the type of signal input.
DVI MODE	<p>Sets the type of DVI-D input signal.</p> <p>DVI-HD: Select this option if the input signal requires HDCP authentication. Use this option if the connected equipment is a DVD-player or a computer that is displaying HDCP content.</p> <p>DVI-PC: Select this option if the input signal does not require HDCP authentication.</p>
VGA MODE	Sets the type of analog input. Select either [RGB] or [YPbPr] based on the type of connected equipment.
SYNC TYPE	<p>Sets the type of sync signal for the RGB VGA analog input.</p> <p>AUTO: Select this option to have the monitor automatically identify the video signal's sync type.</p> <p>If the image is unstable when using the [AUTO] setting, select the specific sync type of the input signal.</p> <p>H/V SYNC: Select this option when the input signal requires H/V SYNC (Horizontal/Vertical Sync).</p> <p>SOG: Select this option when the input signal requires SOG (Sync-On-Green).</p> <p>NOTE: [SYNC TYPE] is disabled when the [VGA MODE] is set to [YPbPr].</p>

^{*3}: When you select OPTION for multi picture input, this function depends on which Option Board installed in the monitor.

^{*5}: Except for MP

^{*6}: Depending on the device, it may not be detected correctly.

MULTI-INPUT MENU	
DisplayPort	<p>Selects the DisplayPort mode [1.1a] or [1.2].</p> <p>DisplayPort 1.1a is selected, [SST] is set automatically.</p> <p>DisplayPort 1.2 is selected, set [SST] or [MST*].</p> <p>* DisplayPort 1.2 should be selected when using Multi-Stream Transport. Multi-Stream Transport requires a corresponding display card. Contact your supplier for limitations of this function.</p> <p>NOTE: MST is not available with DisplayPort2 signal input.</p>
BIT RATE	<p>DisplayPort 1.1a is selected at DisplayPort, [HBR] is set automatically.</p> <p>DisplayPort1.2 and SST are selected at DisplayPort, set [HBR] or [HBR2].</p> <p>DisplayPort1.2 and MST are selected at DisplayPort, [HBR2] is set automatically.</p>
HDMI	<p>Sets the HDMI mode.</p> <p>MODE1: Max resolution is 3840 x 2160 (30 Hz).</p> <p>MODE2: Max resolution is 3840 x 2160 (60 Hz), HDCP 2.2, or HDR.</p>
VIDEO LEVEL	<p>Adjust the gradation range to be displayed according to the video signal to improve the whiteout and blackout of the image.</p> <p>RAW: For computer settings. Show all input signals of 0-255 gray levels.</p> <p>EXPAND: For audio-visual equipment settings. Expands the input signals from 16-235 gray levels to 0-255 gray levels.</p> <p>AUTO: Automatically sets input signals by adjusting connected equipment.</p> <p>NOTE: This function is available only in [HDMI] or [DisplayPort] or [OPTION] and is selected at [INPUT SIGNAL].</p>
SIGNAL FORMAT HDMI1, HDMI2, DisplayPort1, DisplayPort2, COMPUTE MODULE, OPTION only	<p>Selects the color space setting and RGB for the HDMI/DisplayPort signal.</p> <p>NOTE: If [SLOT2 CH SETTING] is [CH2], this function is grayed out.</p>
RESET	<p>Resets MULTI INPUT options back to factory settings, except for [INPUT DETECT] (priority of input signals only), [INPUT CHANGE] (INPUT1 and INPUT2), [INPUT SELECT], [PICTURE ASPECT] and [BIT RATE].</p>

OSD

OSD MENU	
LANGUAGE	Select the language used by the OSD.
ENGLISH	
DEUTSCH	
FRANÇAIS	
ITALIANO	
ESPAÑOL	
SVENSKA	
РУССКИЙ	
中文	
日本語	
OSD TIME	Turns off the OSD after a period of inactivity. The preset choices are 10-240 seconds.
OSD POSITION	Determines the location where the OSD appears on the screen.
UP	
DOWN	
RIGHT	
LEFT	

OSD MENU	
INFORMATION OSD	<p>Selects whether or not to automatically show information about the monitor when it powers on, changes input, or the current input signal changes.</p> <p>The information includes the current input, audio source, aspect ratio, resolution, and refresh rate. The monitor's ID and IP address are also displayed unless their setting is OFF.</p> <p>The amount of time the Information OSD is displayed on-screen can be adjusted between 3 to 10 seconds.</p> <p>Note that the information OSD is also displayed when pressing the DISPLAY button on the remote control. The remote control function cannot be turned off.</p>
COMMUNICATION INFO.	Selects whether or not to show the [MONITOR ID] and [IP ADDRESS] when the [INFORMATION OSD] is [ON] or when pressing the DISPLAY button on the remote control.
OSD TRANSPARENCY	Makes the OSD partially transparent.
OSD ROTATION	Changes the OSD orientation between landscape and portrait.
LANDSCAPE	Shows the OSD in landscape orientation.
PORTRAIT	Shows the OSD in portrait orientation. NOTE: [CLOSED CAPTION] is not available when the [OSD ROTATION] is [PORTRAIT].
KEY GUIDE	<p>Shows the monitor's button controls Key Guide when displaying the OSD Menu.</p> <p>The Key Guide is aligned to the monitor's button control panel and does not move if the OSD POSITION changes. It is a visual guide to indicate the position of the buttons so that features can be easily adjusted when not using a remote control.</p> <p>NOTE: This function is not available when [OSD FLIP] is [ON].</p>
MEMO	Displays the MEMO title and message set via the HTTP server. For more detail, please refer to the "MEMO Settings" on page 88 .
INPUT NAME	<p>Renames the current input.</p> <p>Custom names with a maximum of 14 characters, including spaces, can be set. The characters can be a mix of letters (A-Z), numbers (0-9), and some symbols.</p>
CLOSED CAPTION VIDEO input only	<p>Activates closed captioning.</p> <p>NOTE: This function is disabled if any of the following functions are enabled: [MULTI PICTURE MODE], [TEXT TICKER], [PORTRAIT] in [OSD ROTATION], [TILE MATRIX], [SCREEN SAVER], [STILL], [POINT ZOOM], [SUPER] in [INPUT CHANGE].</p>
RESET	Resets the following functions within the OSD menu back to the factory settings: [OSD TIME], [OSD POSITION], [INFORMATION OSD], [OSD TRANSPARENCY], [CLOSED CAPTION].

MULTI-DISPLAY

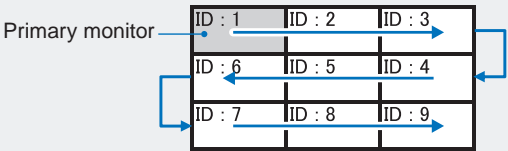
MULTI-DSP MENU	
AUTO TILE MATRIX SETUP	<p>AUTO TILE MATRIX sets the Tile Matrix settings automatically for all monitors in the chain, starting from the primary monitor. On the primary monitor, input the number of monitors arranged horizontally and vertically then select [ACTIVATE].</p> <p>The following settings are configured automatically on the connected monitors: [MONITOR ID], [TILE MATRIX], [TILE MATRIX MEM], [input signal], video out setting, [DisplayPort] in [TERMINAL SETTINGS].</p> <p>NOTE:</p> <ul style="list-style-type: none"> [AUTO ID] assigns a unique Monitor ID to each monitor, consecutively, starting from the primary monitor's ID. DisplayPort is the recommended connection for chaining the monitors together. This function does not execute [AUTO IP]. Automatically assigning IP addresses to all monitors can be activated in the [AUTO ID/IP SETTING] settings. [TILE MATRIX] is automatically deactivated if [MOTION] in [SCREEN SAVER] is activated. <p>Example of installation via LAN:</p> <p>H MONITORS 3 V MONITORS 3</p> 

MULTI-DSP MENU	
SETTING COPY	Copies some of the OSD menu categories to the other monitors when they are chained together. NOTE: When you use this function, monitors should be daisy chained by LAN cables. The selection of which settings to copy will be reset to default when the monitor is powered off. The number of monitors that the settings can be copied to may be reduced based on the quality of the LAN cables being used. Please see the "Setting copy.pdf" file on the NEC website.
COPY START	Highlight and press SET to select each setting that needs to be copied to the other monitors, or select [ALL INPUT]. Highlight [YES] and press SET to start copying the settings.
ALL INPUT	When this option is selected, all input terminal settings are copied.
TILE MATRIX	Allows one image to be expanded and displayed over multiple screens (up to 100) through a distribution amplifier. This option is for manually configuring the TILE MATRIX settings that are automatically configured when using [AUTO TILE MATRIX SETUP]. NOTE: <ul style="list-style-type: none"> • Low resolution is not suitable for tiling to a large number of monitors. • You can operate without a distribution amplifier at a lower number of screens. These functions are not available when [TILE MATRIX] is active: [MULTI PICTURE MODE], [TEXT TICKER], and [CLOSED CAPTION] in the OSD menu, and the STILL and POINT ZOOM remote control buttons. • The tile matrix automatically deactivates when enabling any of the following functions: <ul style="list-style-type: none"> - Selecting an [IMAGE FLIP] option in the [ROTATION] menu (except for [NONE]). - Activating [MOTION] in the [SCREEN SAVER] menu. • If [DYNAMIC] or [ZOOM] is the selected aspect setting, they function as [FULL] aspect when the tile matrix is active. While the tile matrix is active, changing the aspect setting to [DYNAMIC] or [ZOOM] or changing the zoom level, does not affect the picture. When the tile matrix deactivates, any settings changed while the tile matrix was active are immediately applied. • [POINT ZOOM] function automatically deactivates when [TILE MATRIX] is activated. Please refer to the [POINT ZOOM] function for more detail. • If Media Player contents are played while [TILE MATRIX] is active, the image play timing might have a gap within monitors. • When input signal is HDMI signal with 3840 x 2160 (60 Hz), [TILE MATRIX] is not available.
H MONITORS	Number of monitors arranged horizontally.
V MONITORS	Number of monitors arranged vertically.
POSITION	Select the section of the tiled image to display on the current monitor.
TILE COMP	Adjusts the image to compensate for the gap between displays. When activated, the displayed image size and position can be adjusted by pressing the + or - button on the remote control.
TILE CUT	Selects part of the displayed image and displays it on the full screen. Adjust the frame size by [H MONITORS] and [V MONITORS], then choose a frame [POSITION]. The frame position can be adjusted by pressing the + or - button on the remote control.
TILE MATRIX ENABLE	Starts the Tile Matrix.
FRAME COMP	Adds a delay to the displayed video in order to reduce frame gaps between tiled rows when showing moving images. NOTE: <ul style="list-style-type: none"> • The image may be distorted when turning the power on or changing the settings. • If [FRAME COMP] is set to [AUTO] or [MANUAL], [V SCAN REVERSE] is not available. <div style="text-align: center;"> </div>
NONE	FRAME COMP is not used.
AUTO	Sets display timing to vertical direction of all monitors automatically.
MANUAL	Sets display timing to individual monitor.

MULTI-DSP MENU	
V SCAN REVERSE	<p>Panels are normally scanned top to bottom. Reversing the direction on alternate rows of tiled displays can reduce frame gaps between rows when showing moving images.</p> <div style="text-align: center;"> </div> <p>NOTE: If [V SCAN REVERSE] is set to [AUTO] or [MANUAL], [FRAME COMP] is not available.</p>
NONE	[V SCAN REVERSE] is not available.
AUTO	Sets automatically calculated image scanning direction to all monitors.
MANUAL	Sets scanning direction to individual monitor.
NON REVERSE	Sets normal scanning direction and delays 1 frame display image timing.
REVERSE	Reverse scanning direction to individual monitor.
TILE MATRIX MEM	Selects whether or set the Tile Matrix options, configured on the current input, to all of the monitor's inputs.
COMMON	All settings in the [TILE MATRIX] are saved for all signal inputs.
INPUT	All settings in the [TILE MATRIX] are saved for the selected signal input.
ID CONTROL	Sets the monitor's ID number, assigns the monitor to groups, and provides the option for automatic monitor ID and IP address numbering in multi-display installations when daisy chained with LAN cables.
MONITOR ID	<p>Sets the monitor's ID number between 1-100. This number is used to uniquely identify the monitor in multi-display installations. This number is also used by the remote control when in ID mode, to control a single monitor in a multi-display installation.</p> <p>NOTE: It is strongly recommended so that the monitor can be individually identified and controlled.</p>
GROUP ID	<p>This function assigns monitors to groups, which gives you the ability to send commands to all displays, however, only monitors with the matching Group ID perform the command. Group IDs allow specific groups of monitors to be targeted using a single command, providing high-speed parallel operation on daisy-chained displays. It is useful for scenarios such as rapid switching of video inputs or tile matrix configurations within a video wall. The [GROUP ID] function is used only via LAN or RS-232C commands from your software or control system. Monitors can be assigned to any of the 10 available Group IDs, labeled A-J. Refer to the External_Control.pdf file (see page 98) for the monitor's command codes.</p>
AUTO ID/IP SETTING	<p>Automatically sets all of the monitor IDs and/or IP addresses in a LAN chain. Highlight [START] and press SET on the remote control to show the [AUTO ID/IP SETTING] menu.</p> <p>NOTE:</p> <ul style="list-style-type: none"> All changes to the [AUTO ID/IP SETTING] menu should be made on the master monitor, which is the first monitor in the LAN chain. Automatic numbering consecutively counts up by 1 starting from the master monitor. Do not turn off the monitors' main power switch or put it into standby while [AUTO ID/IP SETTING] or [AUTO ID/IP RESET] is in progress. Do not interrupt the monitors' LAN chain by connecting network devices between the monitors.
SETTING ITEM	Selects which function to automatically number in the LAN chain. Each number is assigned consecutively starting from the base numbers set in this menu.
MONITOR ID	<p>Monitor ID numbers are automatically assigned for all monitors in the LAN chain, starting from the number set for [BASE NUMBER].</p> <p>This option does not change the current IP addresses.</p>
IP ADDRESS	<p>IP addresses are automatically assigned for all monitors in the LAN chain. The first three octets are set using the format in [BASE ADDRESS], the fourth octet starts at the BASE NUMBER and counts up by 1 for each subsequent monitor in the LAN chain.</p> <p>This option does not change the current Monitor IDs.</p>
ID and IP	Both the monitor ID and the IP address are assigned for all monitors in the LAN chain, starting from the [BASE NUMBER] and [BASE ADDRESS].

MULTI-DSP MENU	
BASE NUMBER	<p>Sets the starting number for the monitor ID and/or IP address.</p> <p>This is the number that is assigned to the master monitor. The automatic numbering assigns consecutive numbers, starting from this number and counting up by 1, to each monitor in the LAN chain.</p> <p>When running AUTO ID:</p> <ul style="list-style-type: none"> - Monitor numbers can be between 1-100. However, the master monitor must have a starting number low enough to include all monitors in the LAN chain. The automatic numbering counts up by 1 until it reaches 100. For example, if there are 20 monitors in the LAN chain, the BASE NUMBER must be 80 or lower. <p>When running AUTO IP:</p> <ul style="list-style-type: none"> - This is the fourth octet in the IP address. Octets one to three are set at BASE ADDRESS. The BASE NUMBER is automatically assigned to the master monitor and counts up by 1 until the end of the LAN chain. - If the master monitor is connected to a network, make sure there are no IP address conflicts before running AUTO IP. <p>When running IP and ID:</p> <ul style="list-style-type: none"> - The BASE NUMBER is the starting number for both the monitor ID and the fourth octet of the IP address. Due to this, if the master monitor is going to be connected to a network, and a block of IP addresses are not available at a number that is low enough for starting automatic ID, then it is recommended that AUTO ID and AUTO IP be run separately instead of using the grouped auto ID and IP function.
BASE ADDRESS	<p>Sets the first octet to the third octet for the IP addresses assigned during automatic numbering. If the master monitor is connected to a network, these fields must match the network IP numbers for the monitors to be accessed over a LAN, such as 192.168.0 or 10.0.0.</p> <p>The fourth octet is set at [BASE NUMBER] and counts up by 1 starting from the master monitor.</p> <p>NOTE: [BASE ADDRESS] is only available when [IP ADDRESS] or [ID and IP] is selected for the [SETTING ITEM].</p>
ID/IP SETTING START	Highlight YES then press SET on the remote control to activate the automatic number function, which first detects the number of monitors connected in the LAN chain before proceeding.
DETECTED MONITORS	<p>Shows the number of detected monitors connected in the LAN chain. If the number is correct, highlight CONTINUE then press SET on the remote control to start automatic numbering.</p> <p>If the number of monitors is incorrect, make sure all monitors are powered on and verify the LAN cable connection between monitors. Then highlight RETRY and press SET to restart the monitor detection.</p> <p>When the [AUTO ID/IP SETTING] is complete, the status FINISH! will show on screen.</p> <p>NOTE: Do not turn off the monitors' main power switch or put it into standby while [AUTO ID/IP SETTING] is in progress.</p>
AUTO ID/IP RESET	Resets all of the monitor IDs and/or IP addresses in a LAN chain. Highlight START and press SET on the remote control to show the [AUTO ID/IP RESET] menu.
RESET ITEM	Select which item to reset for all displays in the LAN chain.
ID/IP RESET START	<p>Highlight YES and press SET to reset the selected [RESET ITEM].</p> <p>[MONITOR ID] will change all of the monitor IDs to 1 (default setting).</p> <p>[IP ADDRESS] will change all of the monitor IP addresses back to their previous setting.</p> <p>[ID and IP] will reset both the monitor IDs and IP addresses.</p>
DETECTED MONITORS	Displays the number of detected monitors.
COMMAND TRANSFER	When [ON] is selected, commands sent to the master monitor are transferred to the other monitors in the LAN chain.
RESET	Resets all settings within the MULTI DISPLAY menu back to factory setting.

DISPLAY PROTECTION

PROTECT MENU	
POWER SAVE	<p>Places the monitor in power save (low power) after a period of time has passed with no input signal detected or signal loss has occurred. When the monitor is in low power mode, the LED power indicator will change color. Refer to the Power LED indicator table (see page 93).</p> <p>Please refer to the monitor's specifications (see "UN552" on page 96 and "UN552V" on page 97) for power consumption information.</p> <p>NOTE:</p> <ul style="list-style-type: none"> When the monitor is connected to a computer, the computer's display adapter may not stop sending digital data even though there is no image on-screen. If this occurs the monitor will not switch into standby mode. The [POWER SAVE] function is disabled when [AUTO OFF] is turned on in the SCHEDULE menu, or when [HUMAN SENSING]*¹ is enabled in the [AUTO DIMMING] section of the CONTROL menu. When a cable is connected to the HDMI OUT port, this function is not available.
AUTO POWER SAVE TIME SETTING	Sets the amount of time the monitor should wait for input signal before going into power save mode.
POWER SAVE MESSAGE	Displays a message as the monitor is entering low power mode.
FAN CONTROL	<p>When [AUTO] is selected, the fans will only turn on when the internal temperature reaches the temperature set at any one of the sensors in this menu. The fans will automatically turn off when the monitor is cooler. When [ON] is selected the fans are always on. The fans cannot be turned off manually.</p> <p>The [FAN SPEED] can be adjusted between LOW and HIGH.</p> <p>Use the + and - button on the remote control to adjust the maximum internal temperature the monitor can reach before the fan turns on when [AUTO] is selected.</p>
HEAT STATUS	Shows the actual status of the fans, backlight and temperature sensors.
SCREEN SAVER	<p>Use the [SCREEN SAVER] function to reduce the risk of Image Persistence.</p> <p>NOTE:</p> <ul style="list-style-type: none"> When the screen saver starts, the image aspect is changed to [FULL]. When the screen saver stops, the aspect will return to the current [ASPECT] setting. The screen saver cannot be selected for signal input of 3840 x 2160 at 60 Hz. When the [MOTION] option is set to [ON], these functions are not available: [MULTI PICTURE MODE], [TEXT TICKER], [IMAGE FLIP] (except for [NONE]), [TILE MATRIX], [CLOSED CAPTION], [STILL], [POINT ZOOM].
GAMMA ²	Switches to a gamma that is good for reducing image persistence.
BACKLIGHT ²	<p>Decreases the brightness of the backlight when [ON].</p> <p>NOTE: Do not turn this function on when [ROOM LIGHT SENSING] is set to [MODE1] or [MODE2].</p>
MOTION ³	<p>Slightly expands the screen image to the pre-set zoom level then moves the image in four directions (up, down, right, left) at the pre-set interval. Use the + and - button on the remote control to set the time on the [INTERVAL] slider, and the zoom percentage on the [ZOOM] slider.</p> <p>NOTE: If [HDMI] in the [TERMINAL SETTINGS] is set to [MODE 2], this function is not available.</p>
SIDE BORDER COLOR	<p>Adjusts the color of the borders that show when an image does not fill the entire screen.</p> <p>For example, these borders are shown when a 4:3 image is displayed, Picture-By-Picture in Multi-Picture Mode is on and the two inputs do not entirely fill the screen, the Media Player when it plays images or videos, etc.</p> <p>Press the + button to make the borders lighter, the level can be increased until the color is white.</p> <p>Press the - button to make the borders darker, the level can be decreased until the color is black.</p> <p>NOTE: This also changes the background color of the Slideshow window.</p>

*¹: The function is available only when connecting the optional control unit.

*²: If [SPECTRAVIEW ENGINE] is [ON], this function is grayed out.

*³: When you select [OPTION] for signal input, this function depends on which Option Board installed in the monitor.

PROTECT MENU	
POWER ON DELAY	Delays the monitor from turning on for the amount of time set when the POWER ON button is pressed.
DELAY TIME	The delay can be set between 0 and 50 seconds.
LINK TO ID	Links the [DELAY TIME] to the monitor's ID. This helps to prevent power surges that may occur if all monitors in a multi-display installation were to turn on at the same time. The higher the Monitor ID, the longer the delay is before the monitor powers on. For example, if the Monitor ID is 20 and the [DELAY TIME] is 5 seconds, the amount of time that passes between when the POWER ON button is pressed and when the power actually turns on is 95 seconds. This allows the 19 monitors in the multi-display installation to turn on with 5-second intervals between each power on. NOTE: if the [DELAY TIME] is set to 0 seconds, there will be no extended delay for [LINK TO ID]. The delay time must be 1 second or higher to delay power on.
ALERT MAIL	When set to [ON] and the monitor is connected to a network, the monitor can send an email message when an error occurs. The email settings must be configured in the monitor's HTTP server settings for an ALERT MAIL to be sent. See page 85 .
INTELLI. WIRELESS DATA	Allows wireless communication with the monitor from an Android mobile device. Select [ON] to activate [INTELLIGENT WIRELESS DATA] function (see page 88). A password is required when using this function.
RESET	Resets all settings within the DISPLAY PROTECTION menu back to factory setting except for [POWER ON DELAY] and [INTELLI.WIRELESS DATA].

CONTROL

CONTROL MENU	
NETWORK INFORMATION	Shows the current network settings.
LAN	Configures the monitor's network settings either automatically or manually. NOTE: When changing the LAN settings, it will take several seconds for the new LAN settings to be applied.
IP SETTING	When [AUTO] is selected, the IP address is automatically obtained from the DHCP server. When [MANUAL] is selected, the network settings must be entered manually. Contact the Network Administrator for this information. NOTE: Consult your network administrator for the IP address when [AUTO] is selected for [IP SETTING].
IP ADDRESS	Set the IP address for the monitor connected to the network when [MANUAL] is selected for [IP SETTING].
SUBNET MASK	Set the subnet mask data for the monitor connected to the network when [MANUAL] is selected for [IP SETTING].
DEFAULT GATEWAY	Set the default gateway for the monitor connected to the network when [MANUAL] is selected for [IP SETTING]. NOTE: Enter [0.0.0.0] to delete the setting.
DNS	Set the IP addresses of DNS servers. [AUTO]: The DNS server, which is connected with the monitor, will automatically assign its IP address. [MANUAL]: Manually enter the IP address of the DNS server which is connected with the monitor. NOTE: Consult your network administrator for the IP address when [AUTO] is selected for [DNS].
DNS PRIMARY	Enter the primary DNS server settings of the network connected with the monitor. NOTE: Enter [0.0.0.0] to delete the setting.
DNS SECONDARY	Enter the secondary DNS server settings of the network connected with the monitor. NOTE: Enter [0.0.0.0] to delete the setting.
CHANGE PASSWORD	Allows the security password to be changed. NOTE: The factory preset password is [0000].

CONTROL MENU	
SECURITY	Requires a password to be entered to use the monitor. NOTE: This function is for restricting displaying on this monitor. This is not for restricting or preventing access from virus to this monitor through the connected external devices or signal inputs.
PASSWORD	Input the current password to change the settings in this menu. The default password is 0000.
SECURE MODE	Selects when a security password is required to use the monitor.
OFF	No password is required to power on and control the monitor.
START-UP LOCK	The password is required when powering on the monitor.
CONTROL LOCK	The password is required when pressing a button on the display's button panel or remote control.
BOTH LOCK	The password is required for both powering on the monitor and controlling the monitor using the button panel or remote control.
IR LOCK SETTINGS	Prevents the monitor from being controlled by the wireless remote control. When [ACTIVATE] is selected, all settings are activated. NOTE: <ul style="list-style-type: none"> [IR LOCK SETTINGS] is a function intended only for the wireless remote control buttons. This function does not lock out access to the buttons on the monitor. To return to normal operation, press the DISPLAY button on the remote control and hold it down for more than 5 seconds.
MODE SELECT	Selects the mode [UNLOCK], [ALL LOCK] or [CUSTOM LOCK].
UNLOCK	All buttons on the remote control are available for normal operation.
ALL LOCK	Locks all remote control buttons.
CUSTOM LOCK	All remote buttons are locked except for the following buttons, which can be individually set to be locked or unlocked. <p>POWER: Select [UNLOCK] to be able to use the POWER button when the IR Remote is locked. Select [LOCK] to lock the button.</p> <p>VOLUME: Select [UNLOCK] to be able to control the volume with the VOL +/- button when the IR Remote is locked. The volume can only be adjusted within the range set for MIN VOL and MAX VOL. Select [LOCK] to prevent volume adjustment. When activating the volume lock, the display volume will immediately change to the MIN VOL value.</p> <p>MIN VOL and MAX VOL: The volume buttons are unlocked and the volume level can only be adjusted within the MIN and MAX range set. VOLUME must be set to [UNLOCK] for this function.</p> <p>INPUT: Select [UNLOCK] and then select up to 3 input buttons to remain unlocked. Select [LOCK] to lock all input buttons.</p> <p>CHANNEL: Select [UNLOCK] to be able to change channels with the CH/ZOOM +/- button when the IR remote is locked. Select [LOCK] to lock these buttons.</p> <p>ACTIVATE / DEACTIVATE: Select [ACTIVATE] to activate all settings. To return to normal operation press-and-hold the DISPLAY button for more than 5 seconds.</p>

CONTROL MENU	
KEY LOCK SETTINGS	Prevents the monitor from being controlled by the button on the monitor. When [ACTIVATE] is selected, all of the settings are activated. NOTE: <ul style="list-style-type: none"> • [KEY LOCK SETTINGS] is a function intended only for the buttons of the monitor. This function does not lock out access to the buttons on the remote control. • To activate the control key lock function, press the ▲ button and the ▼ button and hold down simultaneously for more than 3 seconds. To resume user mode, press the ▲ button and the ▼ button and hold simultaneously for more than 3 seconds.
MODE SELECT	Selects the mode [UNLOCK], [ALL LOCK] or [CUSTOM LOCK].
UNLOCK	All buttons are available for normal operations.
ALL LOCK	Locks all buttons on the monitor control panel.
CUSTOM LOCK	All remote buttons are locked except for the following buttons, which can be individually set to be locked or unlocked. POWER: Select [UNLOCK] to be able to use the POWER button when the IR Remote is locked. Select [LOCK] to lock the button. VOLUME: Select [UNLOCK] to be able to control the volume with the VOL +/- button when the IR Remote is locked. The volume can only be adjusted within the range set for MIN VOL and MAX VOL. Select [LOCK] to prevent volume adjustment. When activating the volume lock, the display volume will immediately change to the MIN VOL value. MIN VOL and MAX VOL: The volume buttons are unlocked and the volume level can only be adjusted within the MIN and MAX range set. VOLUME must be set to [UNLOCK] for this function. INPUT: Select [UNLOCK] and then select up to 3 input buttons to remain unlocked. Select LOCK to lock all input buttons. CHANNEL: Select [UNLOCK] to be able to change channels with the CH/ZOOM +/- button when the IR remote is locked. Select [LOCK] to lock these buttons. ACTIVATE / DEACTIVATE: Select [ACTIVATE] to activate all settings. To return to normal operation press-and-hold the DISPLAY button for more than 3 seconds.
DDC/CI DisplayPort2, DVI, VGA (RGB) inputs only	ENABLE/DISABLE: Turns [ON] or [OFF] the two-way communication and control of the monitor.
PING	Confirm successful connection with the network by communicating with a preset IP address.
IP ADDRESS	Sets an [IP ADDRESS] for sending [PING].
EXECUTE	Checks a reply can be sent to the monitor or not from the [IP ADDRESS] by sending [PING].
IP ADDRESS RESET	Resets [IP ADDRESS SETTINGS] back to factory settings.
AUTO DIMMING	Adjusts the backlight of the LCD automatically depending on the amount of ambient light.
AUTO BRIGHTNESS ^{*2} DVI, DisplayPort1, DisplayPort2, VGA (RGB), MP, OPTION ^{*3} inputs only	Adjusts the brightness level according to the input signal. NOTE: Do not select this function when [ROOM LIGHT SENSING] function is any setting other than [OFF].
BACKLIGHT DIMMING ^{*2}	Automatically adjusts each of the clusters of the backlight of the LCD independently, according to the input signal. NOTE: If [AUTO BRIGHTNESS] is set to [MODE 2], this function is not available.

*2: The function is available only when connecting the optional sensor unit.

*3: When you select [OPTION] for signal input, this function depends on which Option Board installed in the monitor.

CONTROL MENU

ROOM LIGHT SENSING^{*1, *2}

The backlight of the LCD panel can be set to increase or decrease depending on the amount of ambient light within the room. If the room is bright, the monitor becomes correspondingly bright. If the room is dim, then the monitor will dim accordingly. The purpose of this function is to make the viewing experience more comfortable to the eye in a variety of lighting conditions.

[AMBIENT] parameter setting:

[ROOM LIGHT SENSING] in OSD, select [MODE1] or [MODE2] and set [MAX LIMIT], [IN BRIGHT] and [IN DARK] in each mode.

MAX LIMIT: Set the maximum level of backlight.

IN BRIGHT: Set the maximum level the backlight can increase to when the ambient light level is high.

IN DARK: Set the minimum level the backlight can decrease to when the ambient light level is low.

When the [ROOM LIGHT SENSING] is enabled the Backlight level of the screen changes automatically according to the lighting conditions of the room (see figure below).

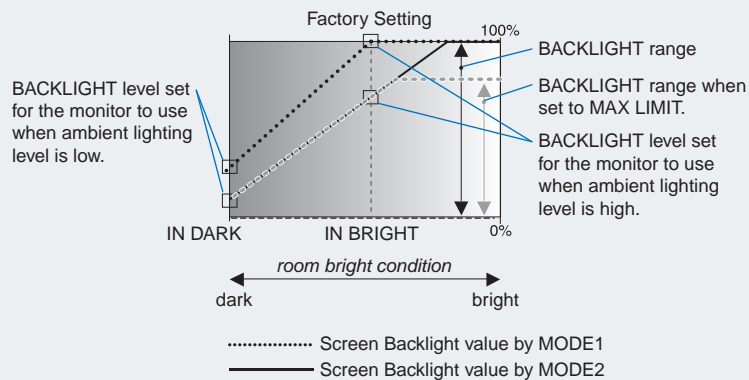

MAX LIMIT: BACKLIGHT level is limited to your set level.

IN DARK: BACKLIGHT level set for the monitor to use when ambient lighting level is low.

IN BRIGHT: BACKLIGHT level set for the monitor to use when ambient lighting level is high.

- NOTE:
- When [ROOM LIGHT SENSING] is set, the [BACKLIGHT], [AUTO BRIGHTNESS] and [BACKLIGHT] in [SCREEN SAVER] functions are disabled.
 - Do not select this function when [AUTO BRIGHTNESS] function is any setting other than [OFF].
 - Do not cover the room light sensor when [ROOM LIGHT SENSING] is enabled. [ROOM LIGHT SENSING] is enabled when it is set to [MODE1] or [MODE2].

HUMAN SENSING^{*2}

Automatically adjusts the backlight and volume levels based on whether or not a human presence is detected in front of the monitor.

NOTE: Human sensing is automatically disabled if [INPUT DETECT] is set while [HUMAN SENSING] is active. [POWER SAVE] is disabled when [AUTO OFF] or [CUSTOM] is selected in HUMAN SENSING.

DISABLE

Human sensing function is off.

AUTO OFF

The monitor's backlight automatically turns off, and the volume mutes when no human presence is detected during the period set at [WAITING TIME].
When a person is near the monitor again, the monitor will automatically return to normal mode.

CUSTOM

The monitor's backlight and volume levels automatically shift to the values set for [BACKLIGHT] and [VOLUME] when no human presence is detected during the period set at [WAITING TIME].
When a person is near the monitor again, the monitor will automatically return the backlight and volume to normal levels and reproduce the input signal selected for [INPUT SELECT].

POWER INDICATOR

POWER INDICATOR

Turns [OFF] or [ON] the LED that indicates the monitor is powered on and in active mode. The monitor's power LED will not glow when this setting is [OFF].

SCHEDULE INDICATOR

Turns [OFF] or [ON] the LED that indicates the monitor is running a schedule, which is set in the [SCHEDULE SETTINGS]. When [OFF] is selected, this monitor will not glow when a schedule is running.

*1: If [SPECTRAVIEW ENGINE] is [ON], this function is grayed out.

*2: The function is available only when connecting the optional sensor unit.

CONTROL MENU	
NETWORK FUNCTIONS	<p>Individually enable or disable the networking component for these monitor functions:</p> <p>DISPLAY: Enables or disables the network function for controlling the monitor remotely. When disabled, these functions do not work: External Control, Mail, Daisy chain functions, HTTP server, SNMP, Crestron, AMX, PJLink.</p> <p>NOTE: If you disable DISPLAY, monitor control in a daisy chain configuration is not available. Please be aware of the impact in multi-monitor installations before disabling it.</p> <p>COMPUTE MODULE: Enables or disables the network function for the Compute Module Interface Board only.</p> <p>MEDIA PLAYER: Enables or disables the network function for the Media Player only.</p> <p>When disabled, these functions do not work: [SHARED FOLDER SETTINGS] and [SHARED SD CARD SETTINGS].</p> <p>Under APPLY, Highlight YES then press SET/POINT ZOOM button to save your selection. If you do not press SET/POINT ZOOM button when [YES] is highlighted, your selections are not saved.</p> <p>NOTE: To apply a firmware version update over the network, [DISPLAY] and [MEDIA PLAYER] must be enabled.</p>
USB	
TOUCH POWER (Not available)	
EXTERNAL CONTROL	When enabled, the monitor can be controlled by a device connected to the USB2 port.
PC SOURCE	<p>Select the connected device to control the monitor with. And select a device connected to USB1 (SENSOR) port which controls the monitor.</p> <p>AUTO: Automatically selects the PC SOURCE type.</p> <p>EXTERNAL PC: Select this option to use a PC when it is connected to the USB2 port.</p> <p>OPTION: Select this option to use an Option board. If a slot 2 type option board is not installed, OPTION will not be available as a selection.</p> <p>C MODULE: Select this option when a Raspberry Pi Compute Module and Interface Board is installed. If a Raspberry Pi Compute Module is not installed, C MODULE will not be available as a selection.</p>
USB POWER	<p>Select [ON] to supply power to the USB CM1 (2A) port.</p> <p>NOTE: Power consumption by devices connected to this port depends on the USB devices.</p>
CEC	
CEC	<p>Provides CEC (Consumer Electronics Control) compatible media players, connected via HDMI, the ability to communicate and allows limited control between the device and the monitor.</p> <p>Only available for HDMI inputs.</p> <p>When [ON] is selected, the following functions are automatically activated:</p> <ul style="list-style-type: none"> - When a connected CEC media device plays, the monitor will turn on and/or change to the HDMI input with the connected media device. - The monitor's wireless remote control can be used to control some of the media player device functions. <p>The wireless remote control CEC functions are: 1 (⏮), 2 (▶), 3 (⏭), 5 (■), 6 (⏪), ENT, EXIT, ▲, ▼, +, -</p> <p>Depending on the type of the connected device, the CEC functions may not work as described. Not all manufacturers provide the same level of CEC integration and control, or they may only provide support for their products.</p>
AUTO TURN OFF	<p>The CEC device goes into standby at the same time as the monitor when the STANDBY button is pressed on the remote control, or when the  button is pressed on the monitor.</p> <p>NOTE: The connected HDMI CEC device may not go into standby if it is recording.</p>
AUDIO RECEIVER	<p>When YES is selected, the monitor sound mutes and audio from the connected HDMI CEC device is output to the CEC audio amplifier.</p> <p>When NO is selected, the CEC audio amplifier mutes and audio from the connected HDMI CEC device is output to the monitor's speakers.</p> <p>NOTE: This option is not available if there is no CEC audio amplifier connected.</p>
SEARCH DEVICE	<p>Searches the HDMI input for a connected CEC device. If a device is found, the connected HDMI CEC device's type and registered device name are shown.</p> <p>After detecting HDMI CEC devices, you can switch the device input by selecting the device.</p>
RESET	Resets all the settings within the CONTROL menu back to factory setting except for [LAN], [CHANGE PASSWORD], [SECURITY] and [PING].

OPTION

OPTION MENU	
OPTION POWER	Allows the monitor to supply power to an Option Board slot during power save mode or standby mode. [AUTO]: Power supply depends on whether or not an Option Board is connected. [ON]: Power is continuously supplied to the Option Board slot, even during power save and standby modes. [OFF]: Power to the Option Board slot stops during power save and standby modes. NOTE: To activate the power management function with no signal input from a connected slot 2 type Option Board, please set [OPTION POWER] to [AUTO] or [ON].
AUDIO ^{*1}	Selects the sound input signal according to the slot2 type option specifications. To activate [DIGITAL], select [OPTION] for input signal and [OPTION] for [AUDIO INPUT]. NOTE: [DIGITAL] is activated only when [OPTION] is selected for input signal and [OPTION] for [AUDIO INPUT].
INTERNAL PC ^{*1}	The function is available for a slot 2 type PC.
OFF WARNING	Shows a warning, when shutting down the power to the internal PC, that the PC should be turned off from within the OS of the PC. This message cannot be changed. This function is available when [OPTION POWER] is [OFF].
AUTO OFF	When [ON] is selected, the monitor automatically powers off when the internal PC is turned [OFF]. NOTE: If you select [OFF], the monitor power is not automatically [ON] when the internal PC is [ON].
START UP PC	When [YES] is selected, the internal PC will start.
FORCE QUIT	When [YES] is selected, a forced shutdown of the internal PC will be carried out. Please use this function only when the operating system cannot be shut down manually.
SLOT2 CH SETTING	Selects signal type according to the slot 2 type option specifications.
AUTO	Sets the signal type automatically.
CH1	Fills the screen entirely with the signal which is selected in [SLOT2 CH SELECT].
CH2	The DisplayPort signal is displayed on the left half of the screen, the TMDS signal is displayed on the right half. If the internal PC does not support either one of the signal types, the existing signal will automatically be displayed on the full screen.
SLOT2 CH SELECT	This function is available only when [SLOT2 CH SETTING] is [CH1].
DisplayPort	Shows the DisplayPort signal from a slot 2 type PC option on the full screen.
TMDS	Shows the [TMDS] signal from a slot 2 type PC option on the full screen.
RESET	Resets the [AUDIO] setting back to the factory setting within the OPTION menu.

*1: This function depends on which Option Board installed in the monitor. When changing the setting, turn the monitor's main power switch off and on again.

SYSTEM

SYSTEM MENU	
MONITOR INFORMATION	Shows the model name, serial number and firmware version of the monitor. [CARBON SAVINGS]: Display the estimated carbon saving information in kg-CO2. The carbon footprint factor in the carbon saving calculation is based on the OECD (2008 Edition). [CARBON USAGE]: Display the estimated carbon usage information in kg-CO2. This is the arithmetic estimation, not actual measurement value. This estimation is based without any options.
FIRMWARE	Shows the monitor's current firmware version.
MAC ADDRESS	Shows the monitor's [MAC ADDRESS].
FACTORY RESET	All items are returned to factory shipment state. NOTE: This will reset all items in all daisy chained monitors. Please be careful to avoid resetting all items inadvertently.

COMPUTE MODULE

When a Raspberry Pi Compute Module Interface Board and Raspberry Pi Compute Module are installed, additional OSD menu items will be available for configuring the related settings. Please do not change settings in COMPUTE MODULE yourself. See [page 98](#).

C MODULE MENU	
POWER	
POWER SUPPLY	Controls power to the Compute Module. ON: Immediately powers on the Compute Module. OFF: Immediately powers off the Compute Module. NOTE: If the Compute Module [SHUTDOWN SIGNAL] is [ENABLED] in the [SERVICE MENU], the power to the Compute Module will be turned off once the timer has finished.
AUTO POWER ON	ENABLE – the Compute Module will be turned on automatically when the display power is turned on. DISABLE – power to the Compute Module is manually controlled via the [POWER SUPPLY] setting, the HTTP interface to the display, or via a LAN command to the display.
SERVICE MENU	
SETTING LOCK	Requires a password to set options in the [SERVICE MENU]. The password is [ON] by default and needs to be input to disable the [SETTING LOCK].
USB BOOT MODE	When set to Enable, the Compute Module will appear as a USB device to a PC connected to the USB2 input on the display and can be programmed with an Operating System. When set to Disable, the Compute Module will boot normally.
IR SIGNAL	Enables or disables the forwarding of IR remote control signals.
MONITOR CONTROL	Enables or disables the internal serial connection between the display and the Compute Module.
SHUTDOWN SIGNAL	Enables or disables the use of GPIO 23 to signal that power to the compute module will be shutting down.
POWER SUPPLY OFF DELAY	This sets the time delay after the Shutdown Signal is set until the power to the Compute Module is turned off. Configure this to allow adequate time for any software to shutdown safely.
WDT	Enables or disables the monitor's built-in Watchdog Timer function for the Compute Module. When enabled, the monitor will expect to receive a periodic reset command from the Compute Module via the internal UART. If the command isn't received for three consecutive timeout periods, the monitor will restart the Compute Module.
START UP TIME	Sets the time delay for when the monitor should start receiving WDT reset commands after the Compute Module powers up.
PERIOD TIME	Sets the maximum amount of time within which the monitor must receive WDT reset commands from the Compute Module.
CHANGE PASSWORD	

Appendix C Manufacturer's Recycling and Energy Information

This Chapter Includes:

- ⇒ "Disposing of your old NEC product" on page 125
- ⇒ "Energy Saving" on page 125
- ⇒ "WEEE Mark (European Directive 2012/19/EU and amendments)" on page 125

NEC DISPLAY SOLUTIONS is strongly committed to environmental protection and sees recycling as one of the company's top priorities in trying to minimize the burden placed on the environment. We are engaged in developing environmentally-friendly products, and always strive to help define and comply with the latest independent standards from agencies such as ISO (International Organisation for Standardization) and TCO (Swedish Trades Union).

Disposing of your old NEC product

The aim of recycling is to gain an environmental benefit by means of re-use, upgrading, reconditioning or reclamation of material. Dedicated recycling sites ensure that environmentally harmful components are properly handled and securely disposed. To ensure the best recycling of our products, NEC DISPLAY SOLUTIONS offers a variety of recycling procedures and gives advice on how to handle the product in an environmentally sensitive way, once it has reached the end of its life.

All required information concerning the disposal of the product and country-specific information on recycling facilities can be found on our following websites:

<https://www.nec-display-solutions.com/p/greenvision/en/greenvision.xhtml> (in Europe)

<https://www.nec-display.com> (in Japan)

<https://www.necdisplay.com> (in USA).

Energy Saving

This monitor features an advanced energy saving capability. When a Display Power Management signal is sent to the monitor, the Energy Saving mode is activated. The monitor enters a single Energy Saving mode.

For additional information visit:

<https://www.necdisplay.com/> (in USA)

<https://www.nec-display-solutions.com/> (in Europe)

<https://www.nec-display.com/global/index.html> (Global)

WEEE Mark (European Directive 2012/19/EU and amendments)



Disposing of your used product: In the European Union

EU-wide legislation as implemented in each Member State requires that used electrical and electronic products carrying the mark (left) must be disposed of separately from normal household waste. This includes monitors and electrical accessories, such as signal cables or power cords. When you dispose of such products, please follow the guidance of your local authority or ask the shop where you purchased the product, or if applicable, follow applicable legislation or agreement you may have. The mark on electrical and electronic products may only apply to the current European Union Member States. If you are outside the European Union, or if applicable, follow applicable legislation or agreement you may have. The mark on electrical and electronic products may only apply to the current European Union Member States.

Outside the European Union

If you wish to dispose of used electrical and electronic products outside the European Union, please contact your local authority and ask for the correct method of disposal.