

R&S®NGP800

Power Supply Series

User Manual



5601561002
Version 14

ROHDE & SCHWARZ
Make ideas real



This manual describes the following R&S®NGP800 models with firmware version 2.025 or higher:

- R&S®NGP802 Two-channel 32V/20A power supply 400 W (5601.4007.05)
- R&S®NGP822 Two-channel 64V/10A power supply 400 W (5601.4007.06)
- R&S®NGP804 Four-channel 32V/20A power supply 800 W (5601.4007.02)
- R&S®NGP824 Four-channel 64V/10A power supply 800 W (5601.4007.03)
- R&S®NGP814 Four-channel 32V/20A & 64V/10A power supply 800 W (5601.4007.04)

In addition to the base unit, the following options are described:

- R&S®NG-B105 option IEEE-488 (GPIB) Interface (5601.6000.02)
- ¹ R&S®NGP-K102 option Wireless LAN (5601.6400.03)
- R&S®NGP-K103 option Digital I/O (5601.6300.03)
- R&S®NGP-K107 option Analog Input (5601.6200.03)

¹ Only available for instrument with serial number below 110000

© 2026 Rohde & Schwarz

Muehldorfstr. 15, 81671 Muenchen, Germany

Phone: +49 89 41 29 - 0

Email: info@rohde-schwarz.com

Internet: www.rohde-schwarz.com

Subject to change – data without tolerance limits is not binding.

R&S® is a registered trademark of Rohde & Schwarz GmbH & Co. KG.

Trade names are trademarks of the owners.

5601.5610.02 | Version 14 | R&S®NGP800

Throughout this manual, products from Rohde & Schwarz are indicated without the ® symbol, e.g. R&S®NGP800 is indicated as R&S NGP800.

Contents

1	Safety and regulatory information.....	9
1.1	Safety instructions.....	9
1.2	Labels on R&S NGP800.....	13
1.3	Warning messages in the documentation.....	14
1.4	Where to find key documents on Rohde & Schwarz.....	14
1.5	Korea certification class A.....	14
2	Welcome to R&S NGP800.....	15
2.1	Documentation overview.....	16
2.1.1	Getting started manual.....	16
2.1.2	User manual.....	16
2.1.3	Instrument security procedures.....	16
2.1.4	Printed safety instructions.....	16
2.1.5	Specifications and product brochures.....	17
2.1.6	Calibration certificate.....	17
2.1.7	Release notes and open source acknowledgment (OSA).....	17
2.1.8	Application notes, application cards, white papers, etc.....	17
2.1.9	Remote control driver.....	17
3	Getting started.....	18
3.1	Preparing for use.....	18
3.1.1	Lifting and carrying.....	18
3.1.2	Unpacking and checking.....	18
3.1.3	Choosing the operating site.....	19
3.1.4	Setting up the R&S NGP800.....	19
3.1.4.1	Placing the R&S NGP800 on a bench top.....	19
3.1.4.2	Mounting the R&S NGP800 in a rack.....	20
3.1.5	Considerations for test setup.....	21
3.1.6	Connecting to power.....	23
3.1.7	Switching on or off.....	24
3.1.8	Connecting to LAN.....	25
3.1.9	Connecting USB devices.....	26
3.2	Instrument tour.....	26

3.2.1	Front panel.....	26
3.2.2	Rear panel.....	28
3.3	Trying out the instrument.....	31
3.3.1	Selecting the channels.....	32
3.3.2	Setting the output voltage and current limit.....	32
3.3.3	Activating the channel output.....	33
3.3.4	Saving/Recalling of instrument settings.....	34
3.4	Instrument control.....	35
3.4.1	Ways to operate the instrument.....	35
3.4.2	Means of manual interaction.....	35
3.4.2.1	Understanding the display information.....	36
3.4.2.2	Accessing the functionality.....	46
3.4.2.3	Entering data.....	47
3.4.3	Remote control.....	48
4	Operating basics.....	50
4.1	Using the touchscreen.....	50
4.1.1	Accessing functionality in the home window.....	50
4.1.1.1	Settings softkey.....	50
4.1.1.2	Voltage and current inputs.....	51
4.1.1.3	Expand/Collapse softkey.....	52
4.1.2	Input data.....	53
4.2	Front panel keys.....	54
4.2.1	Menu control keys.....	54
4.2.1.1	Home key.....	54
4.2.1.2	Settings key.....	54
4.2.1.3	User key.....	60
4.2.2	Navigation controls.....	60
4.2.3	Output and channel controls.....	60
4.3	Output power auto-ranging.....	61
4.4	Modes of operation.....	62
4.4.1	Constant voltage mode (CV).....	62
4.4.2	Constant current mode (CC).....	62
5	Instrument functions.....	63

5.1	Voltage and current.....	63
5.2	Channel output.....	64
5.3	Output setting.....	66
5.3.1	Delay.....	66
5.3.2	Remote sensing.....	68
5.3.3	High impedance mode.....	69
5.3.4	Slew rate control.....	70
5.4	Analog input.....	71
5.5	Protection.....	73
5.5.1	Overcurrent protection (OCP).....	73
5.5.2	Overvoltage protection (OVP).....	75
5.5.3	Overpower protection (OPP).....	76
5.5.4	Safety limits.....	77
5.6	Tracking function.....	79
5.7	Digital trigger I/O.....	80
5.8	User key.....	86
5.9	Measurement function.....	87
5.9.1	Statistics.....	87
5.9.2	Data logging.....	88
5.9.3	CSV settings.....	92
5.10	Advanced features.....	94
5.10.1	QuickArb.....	94
5.10.2	EasyRamp.....	99
5.11	Graphical view window.....	101
5.12	Adjustment.....	105
5.12.1	Analog In adjustment.....	105
5.12.2	Channel adjustment.....	109
6	File and data management.....	113
6.1	Accessing, retrieving and handling data.....	113
6.2	File manager.....	114
6.3	Save and recall.....	116
6.4	Screenshot.....	120
6.5	Device documentation.....	121

7	General instrument functions.....	122
7.1	Licenses management.....	122
7.2	Appearance settings.....	124
7.3	Sound settings.....	126
7.4	Date and time.....	127
7.5	Device information.....	129
7.5.1	Device information settings.....	129
7.6	Update device.....	131
8	Network operation and remote control.....	134
8.1	Remote control interfaces and protocols.....	134
8.1.1	Network connection.....	136
8.1.2	LAN interface.....	138
8.1.3	Wireless LAN interface.....	142
8.1.4	VNC interface.....	144
8.1.5	FTP interface.....	147
8.1.6	USB interface.....	150
8.1.7	GPIB interface (IEC/IEEE bus interface).....	153
8.1.8	SCPI.....	154
8.1.9	VISA.....	155
8.2	Setting up remote control connection.....	155
8.2.1	LAN connection.....	155
8.2.2	USB connection.....	157
8.2.3	GPIB connection.....	157
8.3	Starting and stopping remote control.....	158
8.4	Status reporting system.....	159
8.4.1	Structure of a SCPI status register.....	159
8.4.2	Contents of the status registers.....	161
8.4.2.1	Event status register (ESR) and event status enable register (ESE).....	161
8.4.2.2	STATus:OPERation register.....	162
8.4.2.3	STATus:QUESTionable register.....	162
8.4.2.4	Application of the status reporting system.....	163
8.4.3	Error queue.....	164
9	Remote control commands.....	165

9.1	Common setting commands.....	165
9.2	System settings commands.....	168
9.3	Display commands.....	176
9.4	Trigger commands.....	177
9.5	Configuration commands.....	181
9.5.1	Channel selection.....	181
9.5.2	Safety limit setting.....	183
9.5.3	Remote sense setting.....	187
9.5.4	Voltage setting.....	189
9.5.5	Current setting.....	192
9.5.6	Combined setting of voltage and current settings.....	195
9.5.7	Output setting.....	196
9.5.8	OCP setting.....	200
9.5.9	OVP setting.....	205
9.5.10	OPP setting.....	208
9.5.11	Reset protection tripped state.....	211
9.5.12	Tracking setting.....	212
9.5.13	Interface setting.....	213
9.6	Measurement commands.....	213
9.7	Advanced operating commands.....	218
9.7.1	Arbitrary.....	218
9.7.2	EasyRamp.....	227
9.7.3	Analog input.....	228
9.7.4	Adjustment.....	229
9.8	Data and file management commands.....	235
9.9	Status reporting commands.....	241
9.9.1	STATus:OPERation registers.....	242
9.9.2	STATus:QUEStionable registers.....	244
10	Troubleshooting.....	247
10.1	Displaying status information.....	247
10.2	Problems during firmware update.....	247
10.3	Problems with remote control over LAN.....	248
10.3.1	Cannot establish a LAN connection.....	248

10.3.2	Cannot communicate over LAN.....	248
10.4	Contacting customer support.....	248
11	Transport.....	250
12	Maintenance, storage and disposal.....	251
12.1	Cleaning.....	251
12.2	Changing fuses.....	251
12.3	Internal battery replacement.....	251
12.4	Storage.....	252
12.5	Disposal.....	252
13	Applications.....	253
13.1	Series mode.....	253
13.2	Parallel mode.....	253
	Glossary.....	255
	List of commands.....	256
	Index.....	261

1 Safety and regulatory information

The product documentation helps you use the product safely and efficiently. Follow the instructions provided here and in the following sections.

Intended use

The product is intended for the development, production and verification of electronic components and devices in industrial, administrative, and laboratory environments by personnel familiar with the potential risks of measuring electrical quantities.

Use the product only for its designated purpose. Observe the operating conditions and performance limits stated in the specifications document.

Target audience

Only connect, set up and use a power supply if you are an electrically skilled person. An electrically skilled person has the relevant education and experience to identify electrical risks and take appropriate actions to prevent related hazards.

This document targets at all users, including installers, operators, technicians, maintenance and service personnel.

Follow the safety instructions provided in [Section 1.1, "Safety instructions"](#), on page 9 and the additional information provided during setup or operation procedures.

Where do I find safety information?

Safety information is part of the product documentation. It warns you of potential dangers and gives instructions on how to prevent personal injury or damage caused by dangerous situations. Safety information is provided as follows:

- In [Section 1.1, "Safety instructions"](#), on page 9. The same information is provided in many languages as printed "Safety Instructions". The printed "Safety Instructions" are delivered with the product.
- Throughout the documentation, safety instructions are provided when you need to take care during setup or operation.

1.1 Safety instructions

Products from the Rohde & Schwarz group of companies are manufactured according to the highest technical standards. To use the products safely, follow the instructions provided here and in the product documentation. Keep the product documentation nearby and offer it to other users.

Use the product only for its intended use and within its performance limits. Intended use and limits are described in the product documentation such as the data sheet, manuals and the printed "Safety Instructions". If you are unsure about the appropriate use, contact Rohde & Schwarz customer service.

Only people skilled in electrical work should connect, set up and use the product. Such persons have the education and experience needed to recognize risks and avoid hazards of working with electricity. These users also need sound knowledge of at least one of the languages in which the user interfaces and the product documentation are available.

Reconfigure or adjust the product only as described in the product documentation or the data sheet. Any other modifications can affect safety and are not permitted.

Never open the casing of the product. Only service personnel authorized by Rohde & Schwarz are allowed to repair the product. If any part of the product is damaged or broken, stop using the product. Contact Rohde & Schwarz customer support at <https://www.rohde-schwarz.com/support>.

Lifting and carrying the product

Look up the maximum weight in the data sheet. A single person can only carry a maximum of 18 kg safely depending on age, gender and physical condition. If your product is heavier than 18 kg, do not move or carry it by yourself.

To move the product safely, you can use lifting or transporting equipment such as lift trucks and forklifts. Follow the instructions provided by the equipment manufacturer.

Choosing the operating site

Only use the product indoors. The product casing is not waterproof. Water that enters can electrically connect the casing to live parts, which can lead to electric shock, serious personal injury or death if you touch the casing.

Unless otherwise specified, you can operate the product up to an altitude of 2000 m above sea level. The product is suitable for pollution degree 2 environments where nonconductive contamination can occur. For more information on environmental conditions such as ambient temperature and humidity, see the data sheet.

Setting up the product

Always place the product on a stable, flat and level surface with the bottom of the product facing down. If the product is designed for different positions, secure the product so that it cannot fall over.

If the product has foldable feet, always fold the feet completely in or out to ensure stability. The feet can collapse if they are not folded out completely or if the product is moved without lifting it. The foldable feet are designed to carry the weight of the product, but not an extra load.

If stacking is possible, keep in mind that a stack of products can fall over and cause injury.

If you mount products in a rack, ensure that the rack has sufficient load capacity and stability. Observe the specifications of the rack manufacturer. Always install the products from the bottom shelf to the top shelf so that the rack stands securely. Secure the product so that it cannot fall off the rack.

Connecting to power

The product is an overvoltage category II product. Connect the product to a fixed installation used to supply energy-consuming equipment such as household appliances and similar loads. Keep in mind that electrically powered products have risks, such as electric shock, fire, personal injury or even death. Replace parts that are relevant to safety only by original parts, e.g. power cables or fuses.

Take the following measures for your safety:

- Before switching on the product, ensure that the voltage and frequency indicated on the product match the available power source. If the power adapter does not adjust automatically, set the correct value and check the rating of the fuse.
- If a product has an exchangeable fuse, its type and characteristics are indicated next to the fuse holder. Before changing the fuse, switch off the product and disconnect it from the power source. How to change the fuse is described in the product documentation.
- Only use the power cable delivered with the product. It complies with country-specific safety requirements. Only insert the plug into an outlet with protective conductor terminal.
- Only use intact cables and route them carefully so that they cannot be damaged. Check the power cables regularly to ensure that they are undamaged. Also ensure that nobody can trip over loose cables.
- Only connect the product to a power source with the safety fuse specified in the data sheet.
- Ensure that you can disconnect the product from the power source at any time. Pull the power plug to disconnect the product. The power plug must be easily accessible. If the product is integrated into a system that does not meet these requirements, provide an easily accessible circuit breaker at the system level.

Working with hazardous voltages

Voltages higher than 30 V RMS, or 42 V peak, or 60 V DC are regarded as hazardous contact voltages. Direct contact with them can cause serious injuries.

When working with hazardous contact voltages, use protective measures to preclude direct contact with the measurement setup:

- Before each measurement, inspect all components for damage and replace them if necessary.
- Do not touch exposed connections and components when power is applied.
- Casing, chassis and all measuring terminals are connected to a grounding connection. Never disconnect a grounding connection on the product.
- Switch off the power before connecting or disconnecting the terminal block to the rear panel connector. Tighten all wires connected to the terminal block.
- Only use the wires and terminal blocks delivered with the product.
- Only use insulated wires, not stripped wires, for the terminal connections.
- Turn the mains switch off when the product is not in use.

- When operating measuring accessories, only use the cables delivered with the accessory. If you have to use cables from other manufacturers, make sure that they are of the required overvoltage category.

Do not operate the product in series or parallel unless that setup is supported. If accessories are provided for a product, only use them for that product. See the data sheet.

In series or parallel setups, protect yourself against electric shock before connecting access ports such as the Ethernet port or the USB port using one of the following measures:

- Ensure that all products are grounded by connecting them to the AC power.
- Disconnect all power connections to the product, including outputs.

Measurement categories

IEC 61010-2-030 defines measurement categories that rate instruments on their ability to resist short transient overvoltages that occur in addition to the working voltage. Use the measurement setup only in electrical environments for which they are rated.

- 0 - Instruments without rated measurement category
For measurements performed on circuits not directly connected to mains, for example, electronics, circuits powered by batteries, and specially protected secondary circuits. This measurement category is also known as CAT I.
- CAT II:
For measurements performed on circuits directly connected to the low-voltage installation by a standard socket outlet, for example, household appliances and portable tools.
- CAT III:
For measurements performed in the building installation, such as junction boxes, circuit breakers, distribution boards, and equipment with permanent connection to the fixed installation.
- CAT IV:
For measurements performed at the source of the low-voltage installation, such as electricity meters and primary overcurrent protection devices.

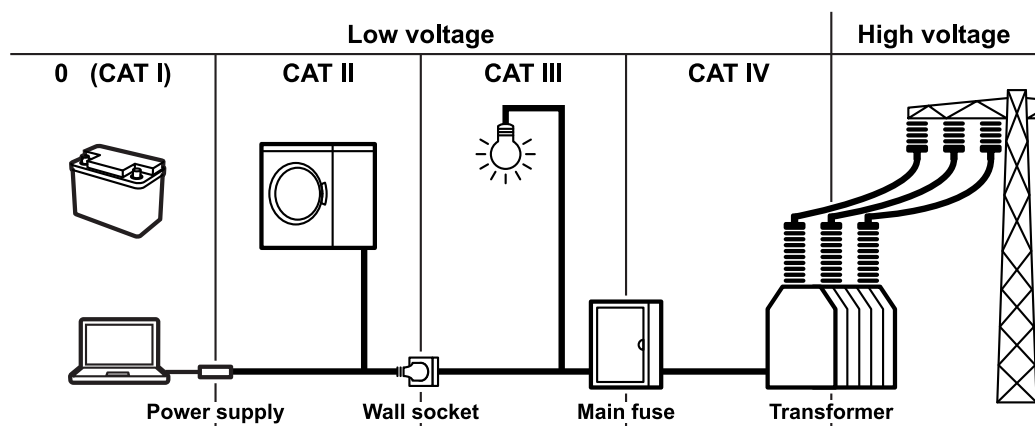





Cleaning the product

Use a dry, lint-free cloth to clean the product. When cleaning, keep in mind that the casing is not waterproof. Do not use liquid cleaning agents.

Meaning of safety labels

Safety labels on the product warn against potential hazards.





	Potential hazard Read the product documentation to avoid personal injury or product damage.
	Electrical hazard Indicates live parts. Risk of electric shock, fire, personal injury or even death.
	Hot surface Do not touch. Risk of skin burns. Risk of fire.
	Protective conductor terminal Connect this terminal to a grounded external conductor or to protective ground. This connection protects you against electric shock if an electric problem occurs.

1.2 Labels on R&S NGP800

Labels on the casing inform about:

- Personal safety, see "[Meaning of safety labels](#)" on page 13.
- Product and environment safety, see [Table 1-1](#).
- Device information is provided on a sticker attached to the [rear panel](#) of R&S NGP800. The sticker contains a barcode and the device ID. The device ID is a combination of the order number and the serial number.

Table 1-1: Labels regarding R&S NGP800 and environment safety

	Labeling in line with EN 50419 for disposal of electrical and electronic equipment after the product has come to the end of its service life. For more information, see " Disposing of electrical and electronic equipment " on page 252.
	Grounding terminal (earth ground contact)
	ON (supply voltage)
	OFF (supply voltage)
	Chassis grounding terminal

1.3 Warning messages in the documentation

A warning message points out a risk or danger that you need to be aware of. The signal word indicates the severity of the safety hazard and how likely it will occur if you do not follow the safety precautions.

DANGER

Imminently hazardous situation. Will result in death or serious injury if not avoided.

WARNING

Potentially hazardous situation. Could result in death or serious injury if not avoided.

CAUTION

Potentially hazardous situation. Could result in minor or moderate injury if not avoided.

NOTICE

Potential risks of damage. Could result in damage to the supported product or to other property.

1.4 Where to find key documents on Rohde & Schwarz

Certificates issued to Rohde & Schwarz that are relevant for your country are provided at www.rohde-schwarz.com/key-documents, e.g. concerning:

- Quality management
- Environmental management
- Information security management
- Accreditations

1.5 Korea certification class A



이 기기는 업무용(A급) 전자파 적합기기로서 판매자 또는 사용자는 이 점을 주의하시기 바라며, 가정외의 지역에서 사용하는 것을 목적으로 합니다.

2 Welcome to R&S NGP800

The two or four-channel power supply series are based on a primary switched-mode regulator with power factor correction. This concept allows the instrument to achieve the highest accuracy and lowest residual ripple.

The R&S NGP800 power supply series feature galvanically isolated, overload and short-circuit proof outputs. The outputs can be connected in parallel and serial to achieve higher currents or voltages.

Multi-purpose protection functions, such as overcurrent protection (OCP), overvoltage protection (OVP) and overpower protection (OPP) can be set separately for each channel. If the set limit is reached, the affected output channel is automatically turned off with an indicator icon (🔴, 🟡, 🟢) flashes on the display. The overcurrent protection can also be linked to the other channels. If the current exceeds the limit on the affected channel, all linked channels are switched off.

The R&S NGP800 power supply series are also protected from overheating (OTP). Each channel is equipped with a temperature sensor that monitors the channel operating temperature for controlling the fan speed and overtemperature protection. If the safe limit is exceeded, the output of the affected channel is switched off. The channel must cool down to a defined threshold before the output can be switched on again. Operations of the other channels are not affected. Also, the actual operating speed of the fans is monitored. If a fan is not running, e.g. rotor locked condition, all the outputs are switched off to prevent overheating.

The R&S QuickArb function allows freely definable voltage and current sequences with a timeframe as short as 1 ms, e.g. to simulate different charging conditions of a battery. The voltage and current points can also be grouped in different blocks which can be sequenced and repeated independently to achieve a flexible arbitrary function generation.

With the R&S EasyRamp function, the R&S NGP800 power supply provides the operating condition to ramp up the supply voltage within a defined timeframe up to 10 s with 1 ms step size and it can be set independently for each channel. Furthermore, the channels can be sequenced to ramp up the voltage output applied at different times. With different slew rates and delays between channel outputs, it is easy to test multi-voltage systems reliability. For the four-channel power supplies, the outputs can also be arranged into two independent subgroups.

The analog input and digital I/O interfaces at the rear panel can be activated with an option key. The analog input allows you to control the output directly using voltage signals (0 V to 5 V analog input corresponds to 0 to V_{max} or 0 to I_{max}) and can be set independently for each channel. The analog inputs are galvanically isolated from the channel outputs, making the connection simpler. The digital I/O provides an 8-bit control port for various control functions. Each pin can be configured as an input or output port, to control any output channel or to trigger an event, e.g. start an arbitrary function or to indicate various conditions, e.g. over current protections.

The R&S NGP800 power supplies are equipped with a color 800 x 480 5" TFT LCD touchscreen and a USB and LAN interfaces to control the instrument remotely. The R&S NGP800 power supplies can also be remote-controlled using the GPIB option.

The user manual describes all instrument functionalities. The latest version is available for download from the product homepage (<http://www.rohde-schwarz.com/product/ngp800>).

2.1 Documentation overview

This section provides an overview of the R&S NGP800 user documentation. Unless specified otherwise, you find the documents at:

www.rohde-schwarz.com/manual/ngp800

Further documents are available at:

www.rohde-schwarz.com/product/ngp800

2.1.1 Getting started manual

Introduces the R&S NGP800 power supply series and describes how to set up and start working with the product. Includes basic operations, typical measurement examples, and general information, e.g. safety instructions, etc. A printed version is delivered with the instrument.

2.1.2 User manual

Contains the description of all instrument modes and functions. It also provides an introduction to remote control, a complete description of the remote control commands with programming examples, and information on maintenance and instrument interfaces. Includes the contents of the getting started manual.

The *online version* of the user manual provides the complete contents for immediate display on the internet.

2.1.3 Instrument security procedures

Deals with security issues when working with the R&S NGP800 in secure areas. It is available for download on the internet.

2.1.4 Printed safety instructions

Provides safety information in many languages. The printed document is delivered with the product.

2.1.5 Specifications and product brochures

The specifications document, also known as the data sheet, contains the technical specifications of the R&S NGP800. It also lists the firmware applications and their order numbers, and optional accessories.

The brochure provides an overview of the instrument and deals with the specific characteristics.

See www.rohde-schwarz.com/brochure-datasheet/ngp800

2.1.6 Calibration certificate

The document is available on <https://gloris.rohde-schwarz.com/calcert>. You need the device ID of your instrument, which you can find on a label on the rear panel.

2.1.7 Release notes and open source acknowledgment (OSA)

The release notes list new features, improvements and known issues of the current software version, and describe the software installation.

The software uses several valuable open source software packages. An open source acknowledgment document provides verbatim license texts of the used open source software.

See www.rohde-schwarz.com/firmware/ngp800

2.1.8 Application notes, application cards, white papers, etc.

These documents deal with special applications or background information on particular topics.

www.rohde-schwarz.com/application/ngp800

2.1.9 Remote control driver

The instrument drivers enable remote control via the corresponding interfaces. The drivers and installation instructions are available for download on the product page at:

www.rohde-schwarz.com/driver/ngp800

3 Getting started

3.1 Preparing for use

Here, you can find basic information about setting up the product for the first time.

3.1.1 Lifting and carrying

See "[Lifting and carrying the product](#)" on page 10.

3.1.2 Unpacking and checking

1. Unpack the R&S NGP800 carefully.
2. Retain the original packing material. Use it when transporting or shipping the R&S NGP800 later.
3. Using the [delivery package](#) list, check the equipment for completeness.
4. Check the equipment for damage and loose parts.

If the delivery is incomplete or equipment is damaged, contact Rohde & Schwarz.

See also [Section 11, "Transport"](#), on page 250.

Delivery package

The delivery package contains the following items:

- R&S NGP800 power supply
- Four power cables
- Two 8-pin plugs (PN: 3639.1002.00) for digital I/O and analog input connections
- Depending on the power supply models:
 - For two-channel models: one 8-pin terminal block plug (PN: 3639.1025.00) for output connections
 - For four-channel models: two 8-pin terminal block plugs (PN: 3639.1025.00) for output connections
- One printed Getting Started manual
- One document folder with multilingual safety instruction and CE certificate

3.1.3 Choosing the operating site

Specific operating conditions ensure proper operation and avoid damage to the product and connected devices. For information on environmental conditions such as ambient temperature and humidity, see the specifications document.

For safety information, see "[Choosing the operating site](#)" on page 10.

Electromagnetic compatibility classes

The electromagnetic compatibility (EMC) class indicates where you can operate the product. The EMC class of the product is given in the specifications document.

- Class B equipment is suitable for use in:
 - Residential environments
 - Environments that are directly connected to a low-voltage supply network that supplies residential buildings
- Class A equipment is intended for use in industrial environments. It can cause radio disturbances in residential environments due to possible conducted and radiated disturbances. It is therefore not suitable for class B environments. If class A equipment causes radio disturbances, take appropriate measures to eliminate them.

3.1.4 Setting up the R&S NGP800

Adequate air circulation must be ensured during operation. For continuous operation, a horizontal or inclined position (integrated stand) is preferable.

See also:

- "[Setting up the product](#)" on page 10
- "[Intended use](#)" on page 9

3.1.4.1 Placing the R&S NGP800 on a bench top

To place the product on a bench top

1. Place the product on a stable, flat and level surface. Ensure that the surface can support the weight of the product. For information on the weight, see the specifications document.
2. **CAUTION!** Foldable feet can collapse. For safety information, see "[Setting up the product](#)" on page 10.
Always fold the feet completely in or out. With folded-out feet, do not place anything on top or underneath the product.
3. **WARNING!** A stack of products can fall over and cause injury. Never stack more than three products on top of each other. Instead, mount them in a rack.

Stack as follows:

- If the products have foldable feet, fold them in completely.
- All products must have the same dimensions (width and length).
- Do not exceed a total load of 50 kg placed on the product at the bottom of the stack.

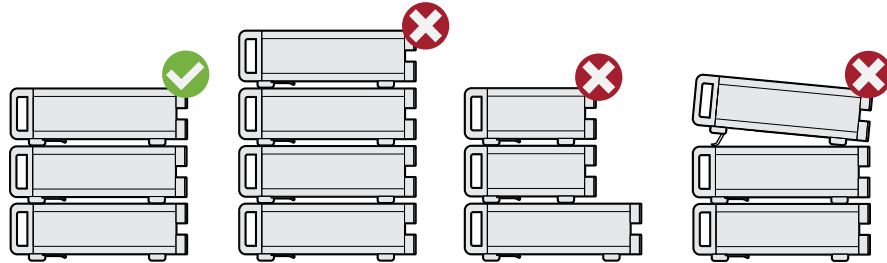

Left = Stacked correctly
 Middle left = Stacked incorrectly, too many products
 Middle right = Stacked incorrectly, different dimensions
 Right = Stacked incorrectly, folded-out feet

4. **NOTICE!** Overheating can damage the product.

Prevent overheating as follows:

- Keep a minimum distance of 10 cm between the fan openings of the product and any object in the vicinity to provide sufficient airflow and ventilation.
- Do not place the product next to heat-generating equipment such as radiators or other products.

3.1.4.2 Mounting the R&S NGP800 in a rack

To prepare the rack

1. Observe the requirements and instructions in "[Setting up the product](#)" on page 10.
2. **NOTICE!** Insufficient airflow can cause overheating and damage the product.

The heat produced inside the instrument is guided to the exterior via a temperature-controlled fan. The R&S NGP800 has multiple temperature sensors that check the heat generation in the instrument and control the fan speed.

It is necessary to ensure that there is sufficient space around the sides of the instrument for heat exchange. Ensure that fan openings and ventilation holes are unobstructed and airflow vents are unimpeded.

If the temperature inside the instrument increases more than the allowed limit, overtemperature protection is triggered and the affected outputs are switched off automatically.

To mount the R&S NGP800 in a rack

1. Use an adapter kit that fits the dimensions of the R&S NGP800 to prepare the R&S NGP800 for rack mounting.

- a) Order the R&S ZZA-GE23 rack adapter kit (PN: 5601.4059.00) designed for the R&S NGP800.
 - b) Mount the adapter kit. Follow the assembly instructions provided with the adapter kit.
2. Lift the R&S NGP800 to shelf height.
 3. Push the R&S NGP800 onto the shelf until the rack brackets fit closely to the rack.
 4. Tighten all screws at the rack brackets with a tightening torque of 1.2 Nm to secure the R&S NGP800 at the rack.

To unmount the R&S NGP800 from a rack

1. Loosen the screws at the rack brackets.
2. Remove the R&S NGP800 from the rack.
3. If placing the R&S NGP800 on a bench top again, unmount the adapter kit from the R&S NGP800. Follow the instructions provided with the adapter kit.

3.1.5 Considerations for test setup

The product is built in compliance with DIN EN 61010-1 (VDC 0411 part 1), EN 61010-1 and IEC 61010-1. It is designed with the regulations of protection class 1, for supplying power-on circuits that are only indirectly connected to the low voltage mains or not connected at all.

The instrument is not intended for measurements within the measurement categories II, III or IV; the maximum potential against earth generated by the user must not exceed 250 VDC in this application.

See also "[Measurement categories](#)" on page 12.

General instrument specifications

Table 3-1: General data on instrument specifications

General data	
Mains nominal voltage	100 VAC to 250 VAC 50 Hz / 60 Hz
Maximum input power	650 W for 2 channels 1125 W for 4 channels
Mains fuses	Internal 16 A 250 V IEC 60127-2/7 fast-acting Not user accessible
Operating temperature range	+5 °C to +40 °C
Storage temperature range	-20 °C to +70 °C
Humidity noncondensing	5 % to 95 %
Display	TFT 5" 800 pixels x 480 pixels WVGA touchscreen
Rack installation	R&S ZZA-GE23 rack adapter 2U (PN: 5601.4059.00)

General data		
Dimensions (W x H x D)	362 mm x 100 mm x 451 mm (14.25 in x 3.94 in x 17.76 in)	
Weight	R&S NGP802 R&S NGP822	7.5 kg (16.5 lb)
	R&S NGP804 R&S NGP814 R&S NGP824	8.0 kg (17.6 lb)

Operating limits

The R&S NGP800 is equipped with a protective overload feature. The protective overload feature prevents damage to the instrument and is designed to protect against possible electrical shocks. The maximum values for the instrument must not be exceeded. The protection limits are listed on the front panel of the R&S NGP800 to ensure safe operation of the instrument.

See [Table 3-2](#) for protection limits of the R&S NGP800.

Table 3-2: Protection limits for R&S NGP800

Specification	Limits
Maximum output voltage	32 V module: 32 VDC 64 V module: 64 VDC
Maximum output current	32 V module: 20 ADC 64 V module: 10 ADC
Maximum voltage against earth	250 VDC
Maximum counter voltage (same polarity)	32 V module: 35 VDC 64 V module: 70 VDC
Maximum reverse voltage (opposite polarity)	0.4 VDC
Maximum reverse current (through protection diode, instrument must be operating)	20 A
AC input	100 VAC to 250 VAC, 50 Hz / 60 Hz
Maximum power output	400 W for R&S NGP802 & R&S NGP822 800 W for R&S NGP804, R&S NGP814 & R&S NGP824

Cable selection and electromagnetic interference (EMI)

Electromagnetic interference (EMI) can affect the measurement results.

To suppress electromagnetic radiation during operation:

- Use high-quality shielded cables, for example double-shielded USB and LAN cables.
- Use at least a CAT6+ LAN cable with a length ≤ 3 m and passive USB cable with a length ≤ 1 m.
- Use insulated wires for output supply/terminal connections.

- Always terminate open cable ends.
- Ensure that connected external devices comply with EMC regulations.
- Check regularly that all cables, including power cables are in perfect conditions.

Signal input and output levels

Information on voltage levels is provided in the specifications document. Keep the voltage levels within the specified ranges to avoid damage to the product and connected devices.

See also "[Output terminals](#)" on page 31.

3.1.6 Connecting to power

For safety information, see "[Connecting to power](#)" on page 11 and "[Working with hazardous voltages](#)" on page 11.

Before connecting the instrument to the mains, check that the mains voltage conforms to the range specified on the label located below the [AC power connector](#).

The power supply module covers a wide power supply range and normally does not require adjustment. See [Table 3-1](#) for the supported mains voltage and the corresponding fuse types and ratings. If the power supply exceeds the permissible range, contact Rohde & Schwarz customer service.

To connect to power

1. Ground the R&S NGP800 using the ground terminal on the rear panel. See "[To ground terminal](#)" on page 23.
2. Plug the AC power cable into the AC power connector.
Use a power cable that complies with the IEC 60320-1 standard.
3. Plug the AC power cable into a power outlet with ground contact.
The required ratings are listed next to the AC power connector and in the specifications document.

To replace the power fuse

- ▶ The instrument is protected by internal fuses which are not user accessible. If the instrument is not powering on, this may indicate an open fuse.
Send the instrument for servicing.

To ground terminal

If necessary, ground the instrument using the grounding connection,  located at the [rear panel](#):

1. Unscrew the screw of the ground terminal using a cross-recess screwdriver.
2. Attach a ground cable with a ring terminal and pass the screw through it.

3. Fasten the screw with a tightening torque of 1.2 Nm.
4. Connect the cable to ground.

3.1.7 Switching on or off



Specifications with tolerance data apply after a warm-up period of at least 30 minutes at a temperature of 23 °C (tolerance: -3 °C / +7 °C).

See also [Section 3.1.6, "Connecting to power"](#), on page 23.

To switch on the product

The product is off but connected to power.

1. Set the switch on the power supply to position [I].
For the location of the switch, see [Section 3.2.2, "Rear panel"](#), on page 28.
The LED of the [Power] key is lighted red.

2. Press [Power] key on the [front panel](#) of the R&S NGP800.

The LED of the [Power] key turns off.

The instrument performs a system check, boots the operating system and starts the R&S NGP800 firmware.

By default, the output channel is turned off when the instrument is switched on to prevent connected loads from being damaged unintentionally.

During startup, the R&S NGP800 is loaded with the last saved instrument settings from internal memory and auto-saved parameters. See [Section 6.3, "Save and recall"](#), on page 116 in the user manual.

To shut down the product

- **NOTICE!** Risk of data loss. If you disconnect the product from power when it is in the ready state, you can lose settings and data. Shut it down first.

Press [Power] key.

All current settings are saved and the operating system shuts down. The LED of the power key changes to red.

To disconnect from power

The product is in the standby state.

1. Set the switch on the power supply to position [0].
The LED of the [Power] key is switched off.
2. Disconnect the product from the power source.

3.1.8 Connecting to LAN

To establish LAN connection

The R&S NGP800 provides Ethernet (LAN) connectivity. Provided the corresponding rights are assigned, you can use these interfaces for remote control and data transfer from a controller PC. The controller PC must also be connected in the network.

The LAN connector is at the [rear panel](#) of R&S NGP800.

1. **NOTICE!** Recommendation on secure operation. The R&S NGP800 is designed to operate at local workplaces or in secured networks (LAN). It should not be accessible from the internet because of a potential security risk, e.g. attackers could misuse or damage your device.

Always install the latest firmware.

By default, the R&S NGP800 configuration uses DHCP that assigns the IP address automatically.

2. Connect the LAN socket using an RJ-45 cable to the LAN.
3. **NOTICE!** If the R&S NGP800 cannot obtain an IP address automatically, or cannot establish the connection, the LAN interface icon,  in the status bar turns red. Possible reasons are that the LAN does not support DHCP or requires a specific TCP/IP configuration, or that the connection is missing.

To troubleshoot the problem, proceed as follows:

- a) Check if you have connected both the R&S NGP800 and the controller PC to the LAN.
- b) Consult your network administrator to request support for an IP address, if necessary.
- c) If necessary, assign the IP address manually as described in [Section 8.1.2, "LAN interface"](#), on page 138.

If switched on and connected, the R&S NGP800 indicates the address information and LAN parameters in the LAN settings dialog. See [Figure 3-1](#).

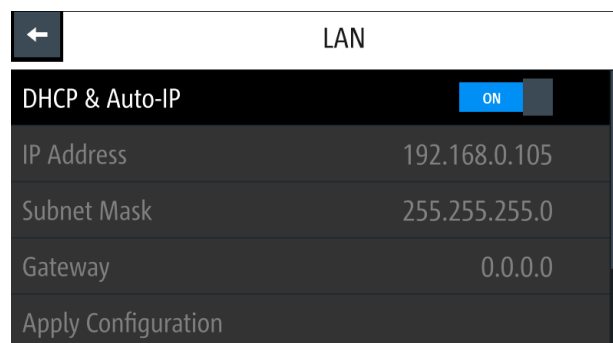

Figure 3-1: LAN settings dialog

3.1.9 Connecting USB devices

The USB Type-A interface is at the [front panel](#). You can connect or disconnect all USB devices from the R&S NGP800 during operation. But do not remove an external USB flash drive while the instrument is performing firmware update, data logging and storing of screen captures, since it leads to unsuccessful updates and loss of data.

To connect USB storage devices

USB storage devices, such as thumb drives, allow easy data transfer from or to the R&S NGP800. You can also use them for firmware updates.

- ▶ Connect the USB storage device to the USB Type-A interface.
If you use the front panel connectors, connect the USB storage device directly, without connecting cable. Connecting cables can cause electromagnetic radiation and impair the measurement result.

3.2 Instrument tour

The following sections help you to get familiar with the instrument and perform the first steps:

- [Section 3.2.1, "Front panel"](#), on page 26
- [Section 3.2.2, "Rear panel"](#), on page 28

These sections explain the controls and connections on the front and rear panel of the R&S NGP800. For details of the interfaces, see the specifications document.

The meanings of the labels on the R&S NGP800 are described in [Section 1.2, "Labels on R&S NGP800"](#), on page 13.

3.2.1 Front panel

Depending on the model of R&S NGP800, the number of channels and controls on front panel varies. The function keys and navigation controls are located on both sides of the display. The various connectors are located on the right side of the display.

Apart from the number of channels and controls, the front view description is similar for the different models of R&S NGP800. For simplicity, the four-channel model is shown in [Figure 3-2](#).

Table 3-3: Power supply models

Models	Number of output channels
R&S NGP802, R&S NGP822	2
R&S NGP804, R&S NGP814, R&S NGP824	4



Figure 3-2: Front panel of R&S NGP800 power supply

- 1 = Menu control keys
- 2 = Display with touchscreen
- 3 = Navigation controls
- 4 = Output and channel keys
- 5 = Chassis ground terminal (4mm socket)
- 6 = Output terminals (see [Table 3-3](#))
- 7 = USB connector
- 8 = Power key

Menu control keys (1)

The menu control keys include the [Home], [Settings] and [User] keys. These keys allow you to access the home window, instrument menu window and user-defined functions in the instrument respectively.

For a detailed description on menu control keys, see [Section 4.2.1, "Menu control keys"](#), on page 54.

Touchscreen display (2)

The display is a color TFT touchscreen. Depending on the instrument models, up to four channels are shown on the display. The respective measurement readings and access to instrument settings are displayed in the individual channel display area.

There are two information status bars, providing the overall instrument operating mode and channel settings of the instrument located respectively at the device level (top-right-hand corner of the display area) and channel level (on top of individual channel display area) of the instrument.

For a detailed description of the on-screen layout, see [Section 3.4.2.1, "Understanding the display information"](#), on page 36.

Navigation controls (3)

The navigation controls include a rotary knob and [Back] key. These keys are used for menu navigation and value adjustment in the instrument.

For a detailed description on the navigation controls, see [Section 3.4.2, "Means of manual interaction"](#), on page 35.

Output and channel keys (4)

Depending on the instrument models, up to four channels and one output key are provided to select individual channel and enable/disable the output(s).

Chassis ground terminal (5)

A 4 mm socket protective ground terminal is provided for the user to connect to earth ground through the instrument ground/chassis, see [Section 1.2, "Labels on R&S NGP800"](#), on page 13.

Output terminals (6)

The number of output terminals varies between the different models of the R&S NGP800 power supply series. See [Table 3-3](#).

Two-channel instrument models: R&S NGP802 and R&S NGP822 are equipped with 8 terminals for outputs and remote sense connections. Four-channel instrument models: R&S NGP804, R&S NGP814 and R&S NGP824 are equipped with 16 terminals for outputs and remote sense connections.

For 32 V models, each output is capable to source 200 W of power at 0 V to 32 V with a maximum current of 20 A.

For 64 V models, each output is capable to source 200 W of power at 0 V to 64 V with a maximum current of 10 A.

See also ["Output terminals"](#) on page 31.

USB connector (7)

A USB Type-A connector is provided for connecting a USB flash drive to perform software update, store logging data or screen captures. It can also be used for an external USB mouse connector. See [Section 3.1.9, "Connecting USB devices"](#), on page 26.

Power key (8)

The [Power] key toggles the instrument between standby state and normal state. In standby state, the [Power] key is illuminated in red and the instrument internal circuits are operated in powered down state. In normal state, all the internal modules are powered up and the instrument starts up to operate normally. The LED illumination is turned off in normal state. See [Section 3.1.7, "Switching on or off"](#), on page 24.

3.2.2 Rear panel

On the rear panel, the instrument models do not vary in design significantly. Therefore, the description refers to all models and points out existing differences. For technical data of the connectors, see the instrument specification.

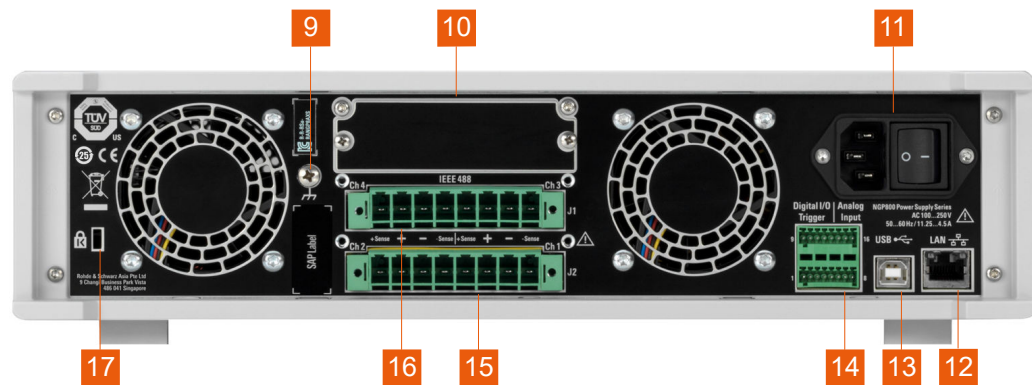

Figure 3-3: Rear panel of R&S NGP800 power supply

- 9 = Ground terminal
- 10 = Optional IEEE-488 (GPIB) interface
- 11 = AC inlet with integrated 2-pole rocker switch
- 12 = Ethernet (LAN) connector
- 13 = USB-B connector (device)
- 14 = Analog input and digital I/O connector
- 15 = Channel 1 and channel 2 rear panel connector
- 16 = Channel 3 and channel 4 rear panel connector (for R&S NGP804, R&S NGP814 and R&S NGP824 models only)
- 17 = Kensington lock

Ground terminal (9)

Protective ground terminal to secure the R&S NGP800, e.g. with a ground external conductor, see [Section 1.2, "Labels on R&S NGP800"](#), on page 13.

Optional IEEE-488 (GPIB) interface (10)

An optional IEEE-488 (GPIB) interface can be ordered (R&S NG-B105).

To install IEEE-488 (GPIB) interface

1. **DANGER!** Shock Hazard. Risk of electric shock if AC power is turned on when installing IEEE-488 (GPIB) interface.
Turn off AC power when installing IEEE-488 (GPIB) interface.
2. Loosen the two screws on the IEEE-488 (GPIB) interface to remove the interface cover.
3. Insert the IEEE-488 GPIB interface into the empty slot.
4. Tighten the two screws on the IEEE-488 (GPIB) interface.

AC inlet with integrated 2-pole rocker switch (11)



Main supply cord

Use a detachable mains supply cord according to IEC60320-1 standard.
Never use the product if the power cable is damaged.

The built-in 2-pole rocker switch is the main power switch of the instrument which connects/disconnects the R&S NGP800 from the AC supply, see [Section 3.1.6, "Connecting to power"](#), on page 23.

Ethernet connector (12)

This RJ-45 connector is used to establish remote control via SCPI.

For more information on the connection setup, see [Section 8.1.2, "LAN interface"](#), on page 138.

USB connector (13)

The USB connector is a Type-B connector for remote control operation.

For more information, see [Section 8.1.6, "USB interface"](#), on page 150.

Digital I/O & analog input connector (14)

NOTICE

Risk of instrument damage

Do not exceed the maximum voltage rating of the digital I/O pins (5.25 V max) when supplying voltages to the pins.

For more information, see the specifications document (PN: 3609.1927.32).

A 16-pin terminal block provides connection to both digital I/O (option R&S NGP-K103) and analog input (option R&S NGP-K107). See [Table 3-4](#).

Table 3-4: Pin configurations

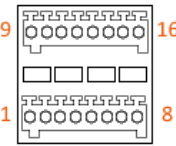
DIO & analog input connector	Signal	Logical name	Value range	Pin number
	Analog input 1 to 4	ANA1	0 Vdc to 5 Vdc	16
		ANA2		8
		ANA3		15
		ANA4		7
	Analog ground	GND	0 Vdc	6, 14
	Digital ground	GND	0 Vdc	5, 13
	Digital trigger 1 to 8	DIO1	TTL	12
		DIO2		4
		DIO3		11
		DIO4		3
DIO5		10		
DIO6		2		

DIO & analog input connector	Signal	Logical name	Value range	Pin number
		DIO7		9
		DIO8		1

For more information, see [Section 5.7, "Digital trigger I/O"](#), on page 80 and [Section 5.12.1, "Analog In adjustment"](#), on page 105.

Rear panel connectors (15, 16)

NOTICE

Output terminals

Either the output terminals at the front panel or the rear panel connector at the back panel can be used.

Both terminals cannot be used at the same time as it can cause the instrument to malfunction.

The rear panel connector contains both outputs ("+", "-") and remote sense ("Sense+", "Sense-") connections. Connectors for channel 3 and channel 4 are only available for the 4-channel instrument models.

To connect rear panel connector

1. **DANGER!** Shock Hazard. Risk of electric shock if AC power is turned on when connecting wires to the rear panel connector.
Turn off AC power when connecting wires to the rear panel connector.
2. Insert shielded wire to the pluggable terminal block.
3. Tightened all the wires with the screw on the pluggable terminal block.
4. Connect the pluggable terminal block to the output terminal.

Kensington security slot (17)

A Kensington lock can be anchored to the R&S NGP800 power supply housing to secure it to a workstation mechanically.

3.3 Trying out the instrument

This section describes some basic functions that you can perform with the R&S NGP800 power supply series.

3.3.1 Selecting the channels

To select a channel, press the corresponding channel key. The selected channel key illuminates.

3.3.2 Setting the output voltage and current limit

1. Press [Home] key, .

The R&S NGP800 displays the home window.

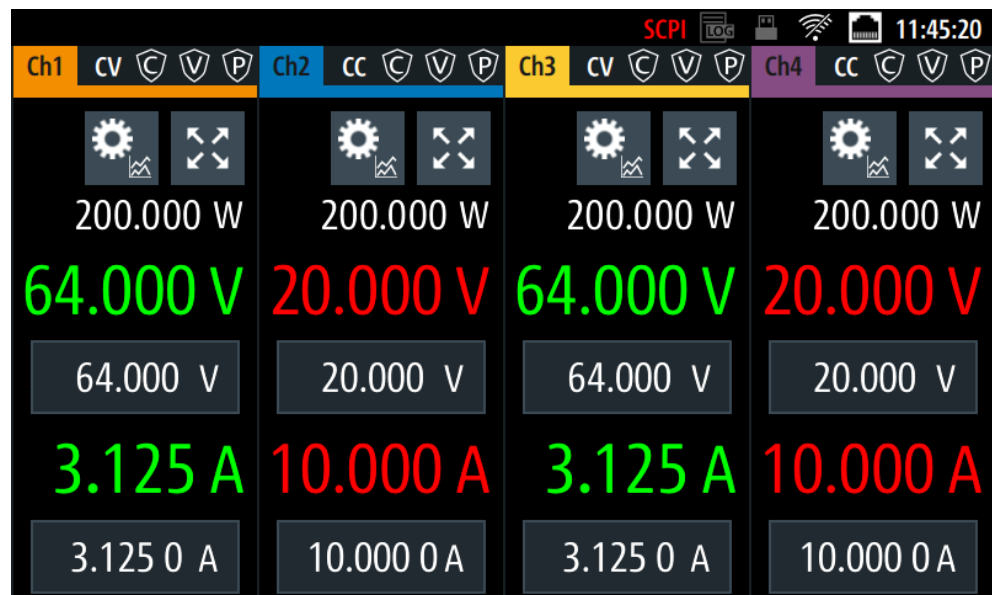

Figure 3-4: Home window of a 4-channel model

2. Select the voltage or current parameter of the desired channel.
The R&S NGP800 displays an on-screen keyboard to set the value.

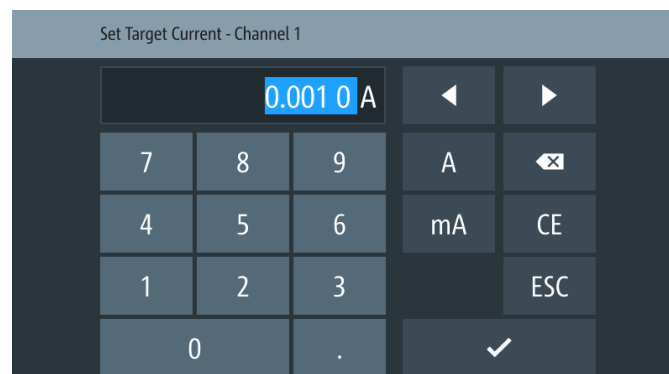



Figure 3-5: On-screen keyboard

3. Enter the required value.

- Confirm the value with either the unit softkey ("V"/"mV" or "A"/"mA"). Alternatively, select "Enter" softkey,  to confirm your value. The home window shows the updated voltage and current settings (see changes of voltage and current values in "Ch1").

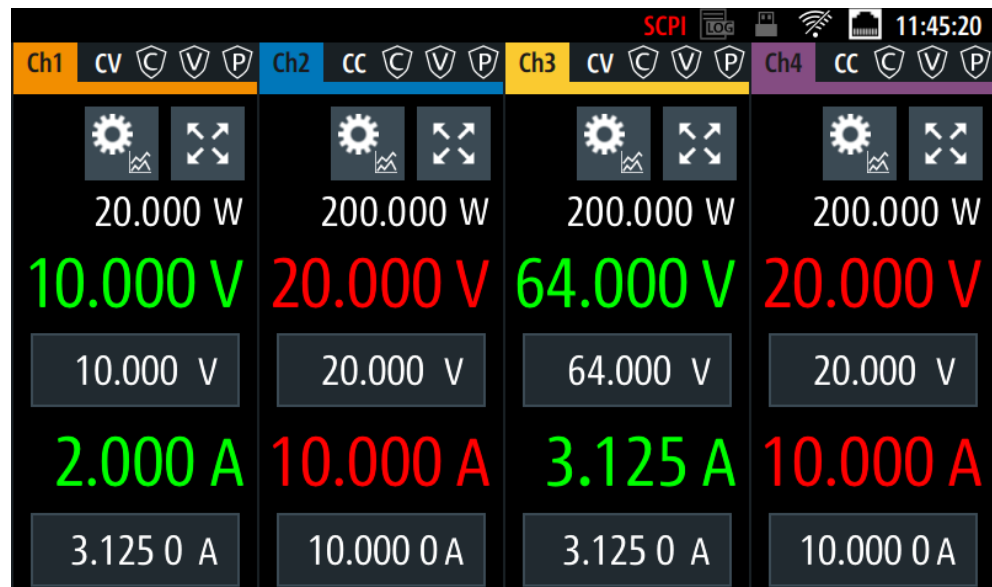

Figure 3-6: Updated voltage and current settings

- Repeat for another channel, if desired.

3.3.3 Activating the channel output

The output can be switched on or off regardless of the instrument's operating mode.

To activate the channel output, press [Output] key on the front panel followed by the desired channel key or vice versa.

The R&S NGP800 power supply displays the actual voltage on the output channel and the actual current drawn by the load connected to the output. Depending on the instrument operating mode, the display font color changes to green in CV (constant voltage) mode and red in CC (constant current) mode.

See the highlighted areas in [Figure 3-7](#).

By default, the output is turned off when the instrument is switched on.

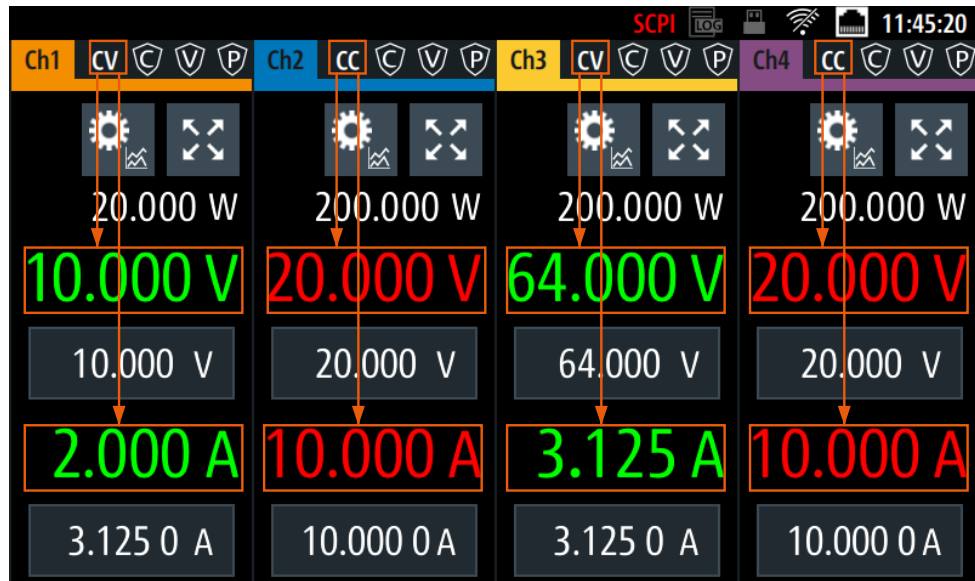

Figure 3-7: Font color in highlighted areas changes to green or red depending on the different operating modes of the instrument

3.3.4 Saving/Recalling of instrument settings

The R&S NGP800 can save instrument settings and screenshots. Both instrument settings and screenshots can be saved on a USB flash drive or internally in the instrument to non-volatile storage media.

To save or recall instrument settings

1. Select [Settings] > "Device" > "Save/Recall Device Settings" > "Save Settings to File" to save current instrument settings.
2. Select the desired storage location and filename.
Default path `/int/settings/newSetting.rds` is used if no location and filename are entered.
3. Confirm the selection by using the "Save" softkey.
The instrument settings are saved.
4. Select [Settings] > "Device" > "Save/Recall Device Settings" > "Recall Settings from File" to load instrument settings.
5. Select the desired file location and filename.
The file manager dialog of the selected location is displayed.
6. Select the desired filename and use "Load" to load the instrument settings.
The selected instrument settings are loaded.

To retrieve the factory default settings, select [Settings] > "Device" > "Save/Recall Device Settings" > "Default Settings" to load back the factory default settings.

For more information, see [Section 6.3, "Save and recall"](#), on page 116.

See also [Section 6.4, "Screenshot"](#), on page 120.

3.4 Instrument control

This section provides an overview on how to work with the R&S NGP800. It introduces the possibilities for operating the instrument and describes the basic functionality of the control elements. If a measurement configuration requires specific operating steps, the corresponding settings description in the user manual points it out separately.

- [Ways to operate the instrument](#)..... 35
- [Means of manual interaction](#)..... 35
- [Remote control](#)..... 48

3.4.1 Ways to operate the instrument

You can operate the R&S NGP800 in two ways:

- Manual operation
Use the touchscreen and front panel controls to configure the R&S NGP800 settings.
See [Section 3.4.2, "Means of manual interaction"](#), on page 35 for basic information on the manual operation of the instrument.
- Remote control
Create programs to automatize repeating settings, tests and measurements. A controller PC with remote access to the instrument runs the programs.
See [Section 3.4.3, "Remote control"](#), on page 48 for an overview of the interfaces provided for remote control.

3.4.2 Means of manual interaction

For manual interaction with the R&S NGP800, you have several methods that you can use as an alternative to perform a task:

- Touchscreen
Touchscreen operation is the most direct way to interact with the instrument. Almost all control elements and actions on the screen are based on the standard operating system concept. You can tap any user interface element, set parameters in dialogs, enter data using on-screen keyboards and swipe to scroll within a dialog.

- Tapping



Tap on the screen to select or toggle the value.

– **Swipe up and down**



Swipe up to scroll down and swipe down to scroll up the content in the menu or dialog box.

For more information on touchscreen behavior, see [Section 4.1, "Using the touchscreen"](#), on page 50 in the user manual.

- **Menu control, channel and output keys**

The menu control keys provide you with quick access to home window, instrument menu and shortcut key to user-defined functions. You can also access the instrument menu via the "Settings" softkey in the home window, see [Section 3.4.2.1, "Understanding the display information"](#), on page 36.

Instrument channel selection and output activation are only accessible via the respective front panel keys, these keys illuminate when activated.

For a detailed description on the front panel keys, see [Section 4.2.1, "Menu control keys"](#), on page 54.

- **Navigation controls**

The navigation controls include a rotary knob and [Back] key which allow you to navigate in the home window, instrument menus or dialogs and also make value adjustment in the entry field.

This manual describes the manual interaction with the instrument using the touchscreen. It mentions the alternative methods using the keys on the instrument or the on-screen keyboards if it deviates from the standard operating procedures.



Throughout the manual, the term "select" refers to any of the described methods, i.e. using a finger on the touchscreen or a key on the instrument or on a keyboard.

For basic instructions on how to control the R&S NGP800, see [Section 3.4.2.2, "Accessing the functionality"](#), on page 46.

3.4.2.1 Understanding the display information

Depending on the instrument models, up to two or four channels are shown on the screen layout. The respective channel settings and device status are displayed for each channel.

The home window of the R&S NGP800 shows the [channel display area](#) and [status bar information](#) for each channel. With the access of "Expand/Collapse" softkey in the channel display area, the [historical channel information](#) of the respective channel is displayed.

The channel display area shows the output power, voltage, current level and [operating mode](#) of the output.

For a detailed information on the output operating modes, see [Section 4.4, "Modes of operation"](#), on page 62.

Table 3-5: Home window of the R&S NGP800 models

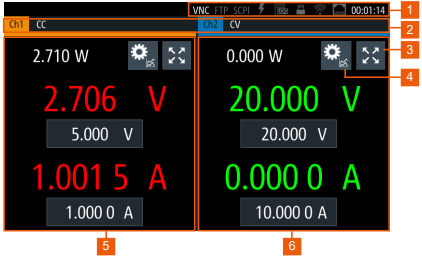
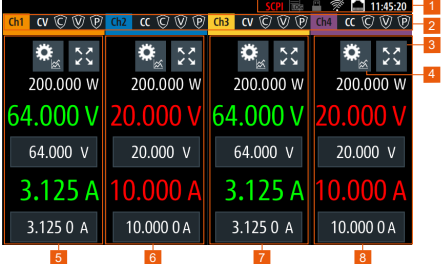
Two-channel models: R&S NGP802, R&S NGP822	Four-channel models: R&S NGP804, R&S NGP824, R&S NGP814
	
<ul style="list-style-type: none"> • 1 = Device status bar • 2 = Channel status bar • 3 = Expand/Collapse softkey • 4 = Settings softkey • 5 = Channel display area of Ch1 • 6 = Channel display area of Ch2 • 7 = Channel display area of Ch3 • 8 = Channel display area of Ch4 	

The following sections explain the information areas as labeled.

Status bar information

There are two types of status bar information located at the top of the screen layout:

- Device status
- Channel status



Device status







The device status displays the state of the functions activated in the device.



Figure 3-8: Device status bar

Table 3-6: Device status bar information

Function	Description
Touchscreen 	If touch input is disabled, the icon is displayed and highlighted in yellow. See Section 4.2.1.3, "User key" , on page 60.
Virtual networking computing, VNC 	If VNC is enabled, the icon is highlighted in white. See Section 8.1.4, "VNC interface" , on page 144
File transfer protocol, FTP 	If FTP is enabled, the icon is highlighted in white. See Section 8.1.5, "FTP interface" , on page 147.

Function	Description
SCPI command 	<p>If a SCPI command is received successfully, the icon blinks once in white.</p> <p>If an error is in the SCPI error queue, the icon is highlighted in red.</p> <p>If no activity, the icon is displayed in gray.</p> <p>See Section 9, "Remote control commands", on page 165.</p>
Trigger event 	<p>Icon blinks once in white when a trigger event occurs.</p> <p>See Section 5.7, "Digital trigger I/O", on page 80.</p>
Data logging 	<p>If data logging is enabled, the icon is highlighted in white.</p> <p>If an error is present, the icon is highlighted in red.</p> <p>See Section 5.9.2, "Data logging", on page 88.</p>
USB interface 	<p>If the USB device is busy, the icon is highlighted in white.</p> <p>If the USB device is idle, the icon is highlighted in gray.</p> <p>See Section 8.1.6, "USB interface", on page 150.</p>
Wireless LAN interface 	<p>Only visible if the software option Wireless LAN is active and an instrument with serial number below 110000.</p> <p>If a connection is present, the icon is highlighted in white. If both WLAN and LAN connections are present, the icon is highlighted with a line cross over.</p> <p>If no connection or WLAN is disabled, the icon is highlighted in gray.</p> <p>See Section 8.1.3, "Wireless LAN interface", on page 142.</p>
LAN interface 	<p>If connected, the icon is highlighted in white.</p> <p>If not connected, the icon is highlighted in gray.</p> <p>If an error is present in connection, the icon is highlighted in red.</p> <p>See Section 8.1.2, "LAN interface", on page 138.</p>
Time 	<p>Time displays in hh:mm:ss format.</p> <p>See Section 7.4, "Date and time", on page 127.</p>











Channel status



The channel status displays the state of the indicators available in the device channel.



Figure 3-9: Channel status bar

Table 3-7: Channel status bar information

Function	Description
Channel number	Channel number indication.
Operating mode	The R&S NGP800 has two operating modes: <ul style="list-style-type: none"> CV: Constant voltage mode CC: Constant current mode See Section 4.4, "Modes of operation" , on page 62.
OCP 	If enabled, the icon is highlighted in white. If triggered, the icon blinks. See Section 5.5.1, "Overcurrent protection (OCP)" , on page 73.
OVP 	If enabled, the icon is highlighted in white. If triggered, the icon blinks. See Section 5.5.2, "Overvoltage protection (OVP)" , on page 75.
OPP 	If enabled, the icon is highlighted in white. If triggered, the icon blinks. See Section 5.5.3, "Overpower protection (OPP)" , on page 76.
Arbitrary mode 	If enabled, the icon is highlighted in white. See Section 5.10.1, "QuickArb" , on page 94.
Ramp mode 	If enabled, the icon is highlighted in white. See Section 5.10.2, "EasyRamp" , on page 99.
"Safety Limits" 	If enabled, the icon is highlighted in white. See Section 5.5.4, "Safety limits" , on page 77.
"Output Delay" 	If enabled, the icon is highlighted in white. The delay is the time between activation of the output and applying voltage to the output. See Section 5.3.1, "Delay" , on page 66.
Adjustment mode 	If user adjustment is active, the icon is highlighted in red. See Section 5.12, "Adjustment" , on page 105.
Sense connection 	If sense connection is set to "Ext" mode, the icon is highlighted in white. See Section 5.3.2, "Remote sensing" , on page 68.
High impedance 	If enabled, the icon is highlighted in white. See Section 5.3.3, "High impedance mode" , on page 69.

Function	Description
Reduce slew rate 	If enabled, the icon is highlighted in white. See Section 5.3.4, "Slew rate control" , on page 70.
Tracking 	If tracking is enabled, the icon is highlighted in white. See Section 5.6, "Tracking function" , on page 79.

Settings softkey

The "Settings" softkey, , navigates to the instrument menu window. The alternate access to the instrument menu is via the [Settings] key on the front panel. See [Section 4.2.1.2, "Settings key"](#), on page 54 in the user manual.

Long-press the "Settings" softkey navigates to the graphical view window. For details, see [Section 5.11, "Graphical view window"](#), on page 101 in the user manual.

For more information on the "Settings" softkey behavior, see [Section 4.1, "Using the touchscreen"](#), on page 50 in the user manual.

Expand/Collapse softkey

The "Expand/Collapse" softkey, , opens/closes the detailed channel display window which provides additional information, such as the channel historical information and the optional digital I/O trigger configuration. See [Figure 3-11](#).

For more information on "Expand/Collapse" softkey behavior, see [Section 4.1, "Using the touchscreen"](#), on page 50 in the user manual.

Channel display area

The channel display area shows the output power, voltage and current values and the corresponding operating mode (CC, CV) of R&S NGP800 when the device output is turned on. See ["Operating mode"](#) on page 42 for the different operating modes that the R&S NGP800 supported.

Each channel display area contains the [Settings](#) softkey and the [Expand/Collapse](#) softkey. The [Settings](#) softkey provides you with the access to the instrument menu and the [Expand/Collapse](#) softkey extends the channel display area with additional information, such as the channel historical information and the optional digital I/O trigger configuration.

See ["Historical channel information"](#) on page 41 and [Section 5.7, "Digital trigger I/O"](#), on page 80.

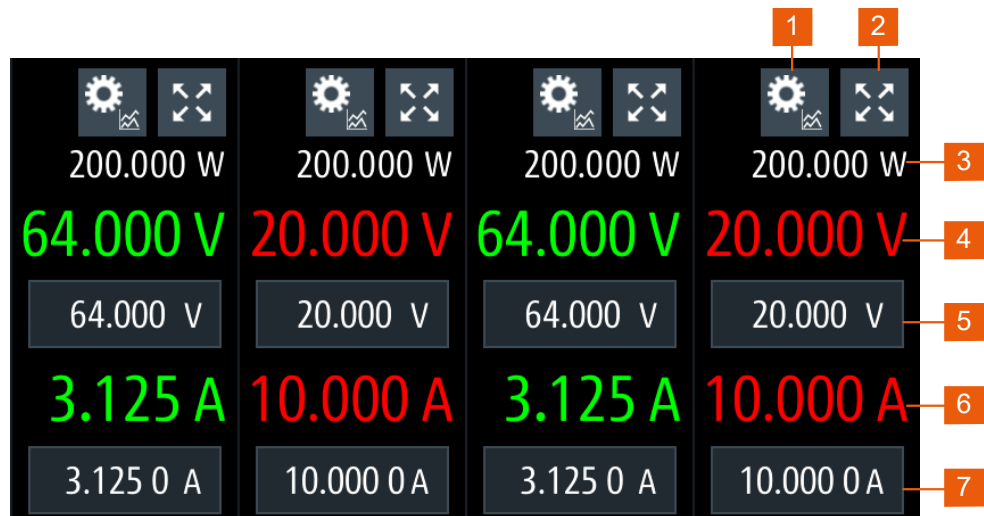



Figure 3-10: Channel display area for a four-channel model

- 1 = Settings softkey
- 2 = Expand/Collapse softkey
- 3 = Output power displays in watt
- 4 = Output voltage displays in volt with display resolution of three decimal points
- 5 = Set voltage level with level limit defined in "Safety Limits"
- 6 = Output current displays in ampere with display resolution of up to four decimal points
- 7 = Set current level with level limit defined in "Safety Limits"

Historical channel information

The historical channel information shows the minimum, maximum and average values for power ("W"), voltage ("V") and current ("A") values. It also performs the calculation of energy result ("Wh") and number of samples collected for the result. To reset the historical channel information to zero value, select the reset softkey, .

The statistics provides valid data for up to 365 days of continuous operation, after which the statistics is reset to zero.

For more information, see [Section 5.9.1, "Statistics"](#), on page 87.

The historical channel information is displayed in the detailed channel display window. Tap the [Expand/Collapse](#) softkey on the home window to access the detailed channel display window.

To return to the home window, tap the [Expand/Collapse](#) softkey.

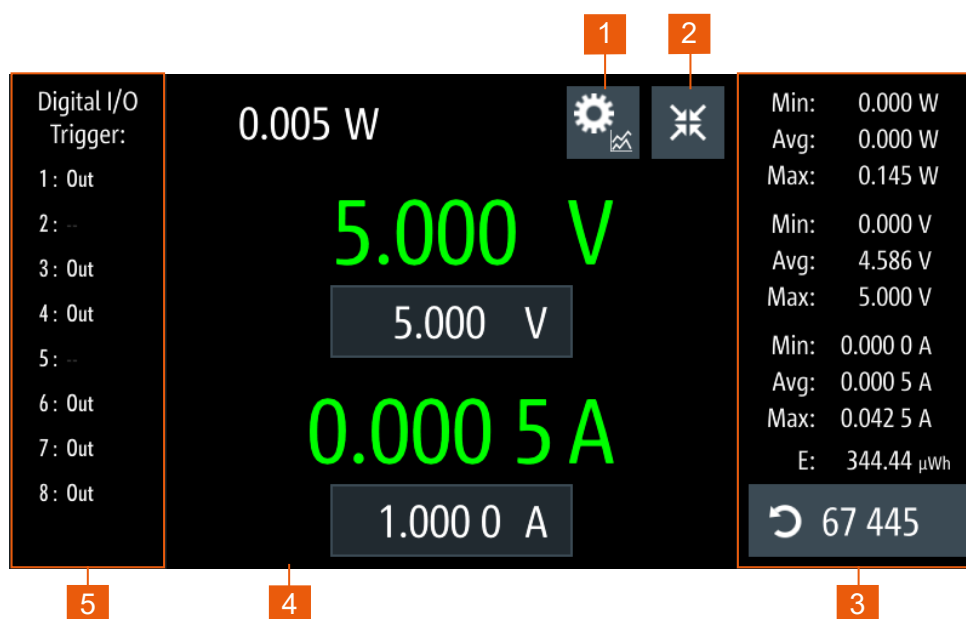

Figure 3-11: Detailed channel display window

- 1 = Settings softkey
- 2 = Expand/Collapse softkey
- 3 = Historical channel information
- 4 = Channel display area of respective channel
- 5 = Digital I/O trigger configuration, R&S NGP-K103 option

Operating mode

Different font colors on the screen are used to differentiate the various output status and operating conditions of the instrument. By looking at the font colors, it is easy to know and confirm the different output status and operating conditions of the instrument.

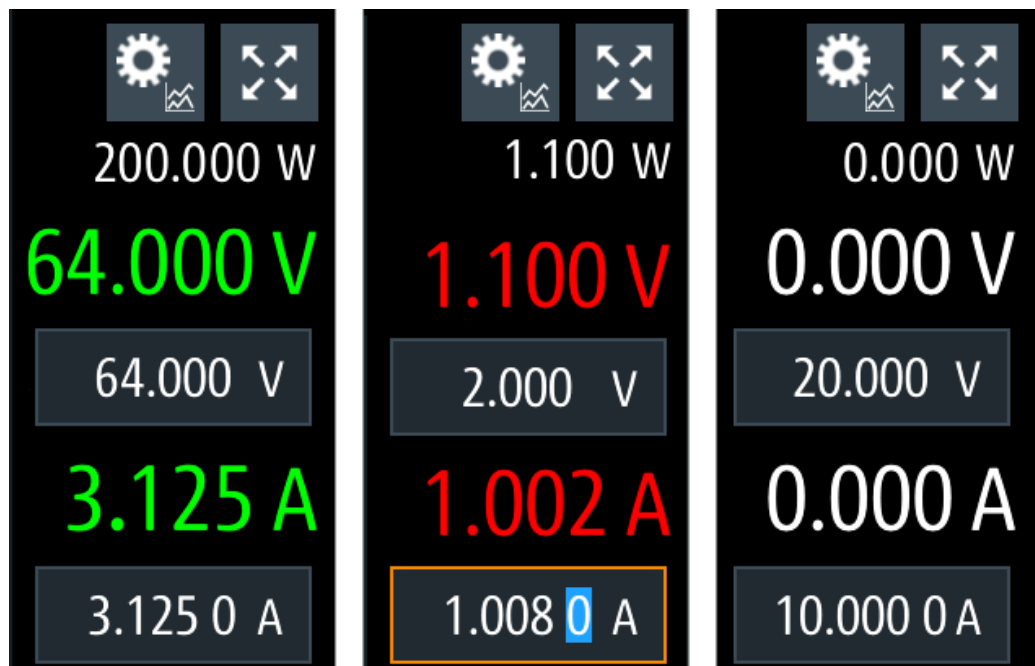

Figure 3-12: Color coding of difference operating conditions

Color	Operating mode	Description
□	OFF mode	Output is OFF
■	Editing mode	A solid blue cursor is shown when an item is selected.
■	CV mode	Active outputs are operated in a constant voltage mode.
■	CC mode	Active outputs are operated in a constant current mode.

Additional display characteristics

The following section provides a short insight on the indication of the screen in general for dialogs and settings.

- Appearance of active elements
 - Active elements like "ON"/"OFF" switches and selected softkeys display a blue background. In the channel display area, the selected element ("Voltage" or "Current") is in editing mode.
 - Selected element is framed or highlighted in orange.
 - Inactive elements are gray.



Figure 3-13: Appearance of active elements

- Menus and dialogs

Both menus and dialogs appear similar and contain selection lists. Throughout this manual, a list of functions that lead you to the settings of this function is referred to as a menu. The term dialog refers to the views that cover the parameters of a certain function. Some dialogs are divided into tabs with logically grouped parameters. The instrument functions are grouped into various menus based on the categories of "Device" and respective channel. See [Figure 3-14](#).



Figure 3-14: Example of a menu

The term dialog refers to the views that cover the parameters of a certain function. See [Figure 3-15](#).

#	Voltage	Current	Duration	Interpolation
1	1.000 V	1.000 0 A	1.000 s	<input type="checkbox"/>
2	2.000 V	1.000 0 A	1.000 s	<input checked="" type="checkbox"/>
3	5.000 V	1.000 0 A	1.000 s	<input checked="" type="checkbox"/>

Figure 3-15: Example of a dialog

- Wizards

The measurement wizard is provided to perform a sequence of standardized and recurring measurements with guided instructions during the measurement. All relevant parameters are set before the actual measurements and cannot be changed once the actual measurement procedure has begun. See [Figure 3-16](#).

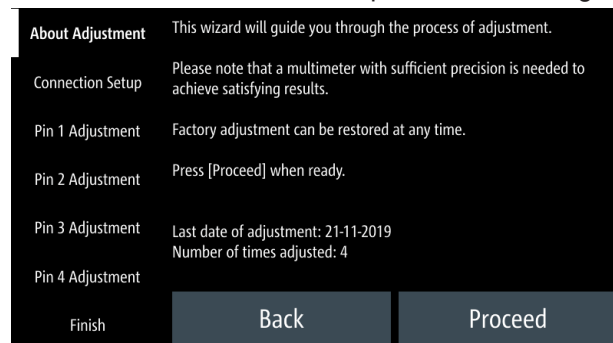

Figure 3-16: Example of an adjustment wizard

- On-screen keyboard

The on-screen keyboard appears if alphanumeric or numeric entry is required. See ["Entering numeric parameters"](#) on page 48. For alphanumeric entry, you can select "_&123" or "ABC" on the on-screen keyboard to toggle between the numeric and alphabetical entry.



Figure 3-17: On-screen keyboard for alphanumeric and numeric entry field

- Info dialogs

An "Info dialog" appears when an event generates a message. The generically assigned header shows the affected topic. The message describes the event and short instructions that lead you through the next steps.

- **Scrollbar**

The scrollbar appears when the list of selection parameters exceeds the size of the screen. Touch and swipe on the screen to scroll up and down the list.

3.4.2.2 Accessing the functionality

The main output control of the respective channels is only possible via the front panel keys. All other instrument functionalities are accessible via dialogs, menus or keyboards. You can control the instrument intuitively with the touchscreen. This section provides an overview of the accessing methods.

Apart from the instrument menus, we use the term "dialog" to refer to the editable windows in the instrument.

To open the menu

1. Press [Settings] key at the front panel or select "Settings" softkey in the channel display area.
 - If selection is via the [Settings] key, the "Device" menu is displayed.
 - If selection is via the "Settings" softkey, the respective channel menu is displayed.
2. To alternate between the "Device" and respective channel menu, select the corresponding tab on the top of the screen.
The selection leads you to their respective menus.

To open the dialog

- ▶ Select the corresponding menu item from the displayed menu, i.e. "Interfaces" > "Network" > "LAN".
The corresponding dialog is displayed.

To close or exit a dialog or menu

To close or exit a dialog or menu, you have several options.

1. To return to the home window, press [Home] key.
2. To return to the previous menu level or exit the menu if it is already at the main menu level, the R&S NGP800 provides several methods:
 - Softkey that prompts you to confirm or abort your selection, e.g. "Set" or "Cancel" automatically closes a dialog.
 - Select "Back" softkey,  in the left upper corner of the menu.
 - Press [Back] key or the rotary knob at the front panel.

To select a parameter in a dialog

If many parameters are available, they are often provided in a list:

1. If necessary, scroll through the list.

Tip: You do not need the focus exactly on the bar, touch and swipe the list.

2. As an alternative, you can use the rotary knob:
 - a) Turn the rotary knob to select the parameter.
 - b) Press the rotary knob to confirm your selection.

3.4.2.3 Entering data

For data input in dialogs, the instrument provides an on-screen keyboard for entering numeric and alphanumeric values. Thus, you can always set the parameters using the touchscreen. However, if the touchscreen is locked, data entry via navigation controls at the front panel works only in the home window and the detailed channel display window, see ["To enter values by using the front panel controls"](#) on page 48.

Data can be entered using one of the following methods:

- ["To correct an entry"](#) on page 47
- ["To confirm an entry"](#) on page 47
- ["To abort an entry"](#) on page 47

To correct an entry

1. To delete an entry, set the cursor to the right of the entry you want to delete.
To select the position:
 - Select directly in the entry field.
 - Use the cursor softkeys of the on-screen keyboard.
2. On the on-screen keyboard, select "Delete" softkey, .
The R&S NGP800 deletes the entry to the left of the cursor.
3. Enter your correction.

To confirm an entry

- ▶ On the on-screen keyboard, confirm your entry with the "Enter" softkey, .
Alternatively, you can also confirm your entry with the respective unit key (if any) on the on-screen keyboard.
Pressing the rotary knob also confirms the data entry.

To abort an entry

- ▶ On the on-screen keyboard, select "ESC" softkey.
Alternatively, you can also press [Back] key on the front panel to abort the data entry.
The on-screen keyboard closes without changing the settings.

Entering numeric parameters

To enter values with the on-screen keyboard

For numeric settings, the instrument displays the numeric keyboard. The units specified correspond to the units of the parameter.

1. Enter the numeric value.
2. Select the unit (if any) to complete the entry.
The value changes according to the unit entry.
If an entry does not require a unit, confirm the value with the "Enter" softkey, .
See also "To confirm an entry" on page 47.

To enter values by using the front panel controls

You can also change the parameters with the navigation controls on the front panel, e.g. if you have locked the touchscreen. However, these front panel controls work only in the home window and detailed channel display window.

For details on locking and unlocking the touchscreen, see [Section 5.8, "User key"](#), on page 86 in the user manual.

1. Navigates to the corresponding entry (voltage or current) by rotating the rotary knob on the front panel.
The selected entry field is highlighted with an orange frame.
2. Press the rotary knob to select the entry.
The on-screen keyboard opens.
3. Press again the rotary knob to go into edit mode.
The R&S NGP800 returns to home screen.
To enter a value, use the controls as follows:
 - a) Turning the rotary knob decreases or increases the currently selected digit (highlighted in blue).
 - b) Pressing the rotary knob again switches to the next digit.
4. Press [Back] or [Enter] key to complete the entry.

Entering alphanumeric parameters

If a field requires alphanumeric input, you can use the on-screen keyboard to enter letters and (special) characters.

Access and control are similar as described above, see ["To enter values with the on-screen keyboard"](#) on page 48.

3.4.3 Remote control

In addition to operating the R&S NGP800 directly on the instrument, it is also possible to operate and control it from a remote PC.

Remote control interfaces

The R&S NGP800 provides several interfaces for remote control:

- Ethernet (LAN) interface
- USB standard interface
- IEEE-488 bus interface (GPIB) (option: R&S NG-B105)

For detailed information on how to configure the remote control interfaces, see [Section 8, "Network operation and remote control"](#), on page 134.

See [Section 3.1.8, "Connecting to LAN"](#), on page 25 for an example of how to set up a LAN connection for remote control.

4 Operating basics

4.1 Using the touchscreen

The R&S NGP800 provides a touch-sensitive screen. Touchscreen can be disabled (see [Section 5.8, "User key"](#), on page 86) in the instrument settings. The following illustrates the touchscreen gestures and highlight the different touchscreen features that can be performed on the instrument.

See [Section 3.4, "Instrument control"](#), on page 35.

4.1.1 Accessing functionality in the home window

The following illustrates various ways of accessing functions in the home window.

4.1.1.1 Settings softkey



The "Settings" softkey navigates to the device and channel menu window where you can set device or individual channel settings on the instrument.

Long-press the "Settings" softkey brings you to the [graphical view window](#) for measurements. See [Section 5.11, "Graphical view window"](#), on page 101.

See [Section 4.2.1.2, "Settings key"](#), on page 54.

1. Select "Settings" softkey.

The R&S NGP800 displays device/channel menu window.

2. Select "Device" or the respective channel tab ("Ch 1", "Ch 2", "Ch 3" or "Ch 4") to open the menu.
3. Swipe up or down for the available items in the menu.
4. Select the required items to configure the settings.
5. Select the back arrow softkey or press [Back] key to close the menu.



Figure 4-1: Navigation on home window > device/channel menu window

Settings,

Configures the device or channel settings. See [Section 4.2.1.2, "Settings key"](#), on page 54.

Back, [Back]

Returns to the home window.

See [Figure 3-4](#).

4.1.1.2 Voltage and current inputs

You can directly change the target voltage and current level in the respective channel display area.

1. Select the voltage or current field in the channel display area to set the value.
The R&S NGP800 displays the on-screen keyboard to enter a value.
2. Set the required value.
See [Section 4.1.2, "Input data"](#), on page 53.
Note: The value is set within the value configured in the "Safety Limits" dialog.
3. Confirm the value by selecting a unit softkey ("V"/"mV" or "A"/"mA").
Alternatively, select "Enter" softkey,  to confirm your value.

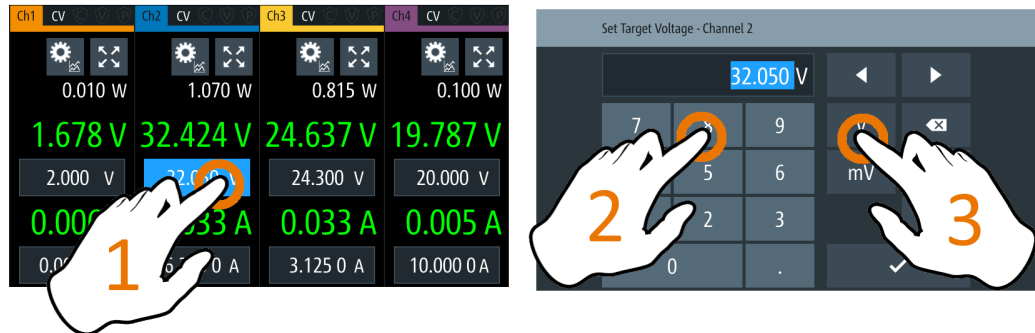

Figure 4-2: Set voltage and current in the home window

Set voltage level / Set current limit

Sets the output voltage level or current limit for the channel. See [Section 5.1, "Voltage and current"](#), on page 63.

4.1.1.3 Expand/Collapse softkey



You can expand the selected channel display area by using the "Expand/Collapse" softkey. The "Expand/Collapse" icon changed when toggled.

1. Select "Expand/Collapse" softkey.
The R&S NGP800 expands the selected channel to a full screen displaying the statistics ("Min", "Avg" and "Max" values of power, voltage and current readings, energy calculation and count of samples recorded).
2. To reset the statistics, select "Reset" softkey, 
The statistical values are reset to zero.
Note: The statistics provide valid data for up to 365 days of continuous operation, after which the statistics are reset to zero.
3. Select "Expand/Collapse" softkey to return to the home window.

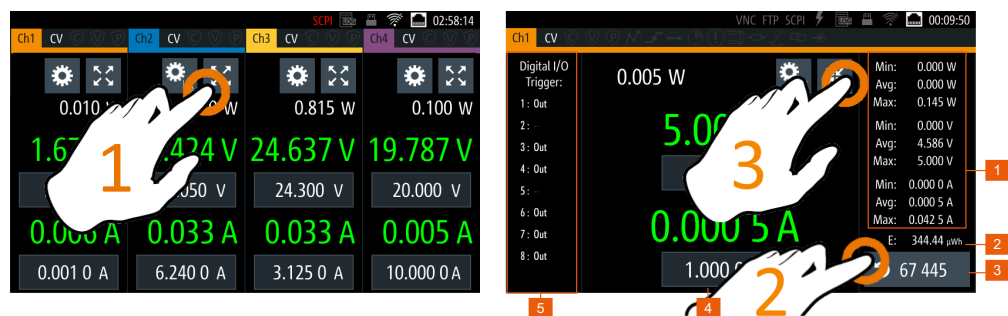



Figure 4-3: Display of detailed channel display window

- 1 = Minimum, maximum and average values for power, voltage and current
- 2 = Calculation of energy result
- 3 = Number of samples collected
- 4 = Channel display area of the selected channel
- 5 = Digital I/O trigger of selected channel

Expand/Collapse

Toggles between the home window and the detailed channel display window which additionally displays the statistical measurements.

4.1.2 Input data

The R&S NGP800 provides an on-screen keyboard for you to enter numerical values. Use the "Back" softkey,  on the on-screen keyboard to delete the numerical entries.

1. Select a menu item to enter the numeric value.
The R&S NGP800 displays the on-screen keyboard.
2. Enter the required value.
3. Depending on the type of numeric value, confirm the value with the appropriate unit softkey ("V"/"mV" or "A"/"mA" or "s"/"ms").
Alternatively, select "Enter" softkey,  to confirm your value.

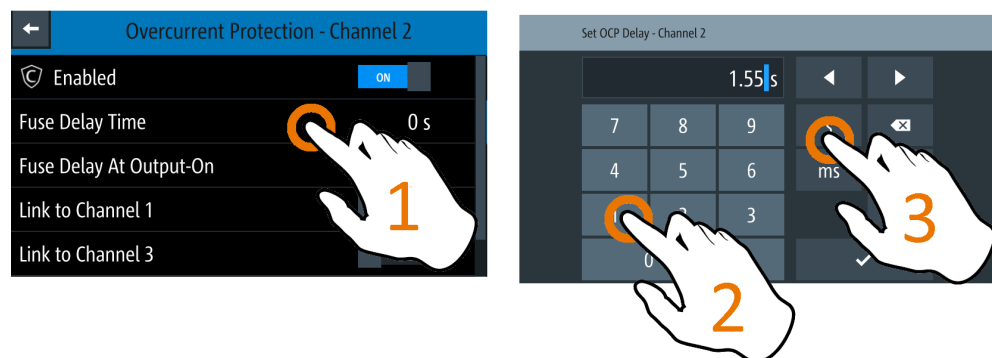



Figure 4-4: Enter numerical value and unit

For alphanumeric input, the on-screen keyboard works the same way.

1. Select "Caps Lock" softkey,  to switch between capital letters and small letters.
The "Caps Lock" softkey is highlighted in blue.
2. Select "_ & 123" or "ABC" softkey to switch between alphabet and numeric input data.

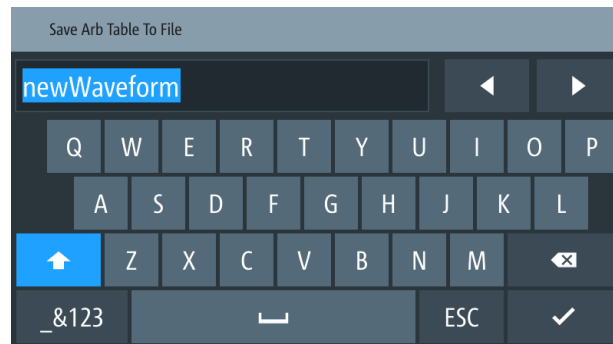

Figure 4-5: Alphanumeric input data

<input_data>

Data entries are entered via the on-screen keyboard.

4.2 Front panel keys

For an overview of the front panel keys, see [Figure 3-2](#).

4.2.1 Menu control keys

The menu control keys provide navigation on the available menus in the instrument.

4.2.1.1 Home key



The [Home] key navigates to the instrument home window. See the display of the home window in [Figure 3-4](#).

4.2.1.2 Settings key



The [Settings] key navigates to the device/channel menu window which consists of the "Device" menu and up to two or four channel menus ("Channel 1", "Channel 2", "Channel 3", "Channel 4").

Long-press the [Settings] key also navigates to the graphical view window. For more information, see [Section 5.11, "Graphical view window"](#), on page 101.

- [Device menu](#)..... 54
- [Channel menu](#)..... 57

Device menu

The "Device" menu provides access to general instrument settings, file arrangement and user key configuration. You can also obtain the instrument information via the menu.

Access:

1. Press [Home] key.
The R&S NGP800 displays the home window.
2. Select "Settings" softkey on the required channel display area.
Alternatively, press [Settings] key.
3. Select "Device" tab to access the device menu.

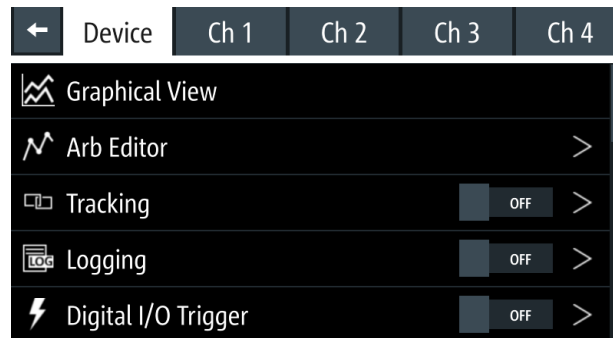

Figure 4-6: Device menu

Settings

Graphical View.....	55
Arb Editor.....	55
Tracking.....	56
Logging.....	56
Digital I/O Trigger.....	56
File Manager.....	56
Interfaces.....	56
User Button.....	56
Screenshot.....	56
CSV Settings.....	57
Date & Time.....	57
Appearance.....	57
Sound.....	57
Licenses.....	57
Device Information.....	57
Update Device.....	57
Save/Recall Device Settings.....	57
Analog In Adjustment.....	57

Graphical View

Graphical display of available data source (e.g. voltage, current, etc.).

See [Section 5.11, "Graphical view window"](#), on page 101.

Arb Editor

Programs the waveform of voltage and current settings for the channel output.

See ["Arbitrary editor"](#) on page 95.

Tracking

Changes made on voltage and current are applied to the tracked channels.

See [Section 5.6, "Tracking function"](#), on page 79.

"ON" Enables tracking.

"OFF" Disables tracking.

Remote command:

[TRACking\[:ENABle\]:GENeral](#) on page 212

Logging

Logs data such as instrument timestamp, voltage, current and power.

See [Section 5.9.2, "Data logging"](#), on page 88.

"ON" Enables data logging.

"OFF" Disables data logging.

Remote command:

[LOG\[:STATe\]](#) on page 237

Digital I/O Trigger

Available only with option R&S NGP-K103.

Configures the digital I/O pins trigger modes and its associated settings.

See [Section 5.7, "Digital trigger I/O"](#), on page 80.

"ON" Enables the digital I/O trigger.

"OFF" Disables the digital I/O trigger.

Remote command:

[TRIGger\[:ENABle\]:DIO<IO>](#) on page 180

File Manager

Transfers file between instrument internal memory and USB flash drive.

See [Section 6.2, "File manager"](#), on page 114.

Interfaces

Configures the network (LAN or wireless LAN), USB interface and GPIB (IEEE-488 interface) address.

Wireless LAN is available only with option R&S NGP-K102 and instrument with serial number below 110000.

IEEE-488 (GPIB) interface is available only with option R&S NG-B105.

See [Section 8.1, "Remote control interfaces and protocols"](#), on page 134.

User Button

Configures the shortcut key action (e.g. screenshot, toggle logging, reset statistics, toggle touch).

See [Section 5.8, "User key"](#), on page 86.

Screenshot

Configures the storage location for the captured screenshot of the instrument.

See [Section 6.4, "Screenshot"](#), on page 120.

CSV Settings

Configures the file formatting for CSV file.

See [Section 5.9.3, "CSV settings"](#), on page 92.

Date & Time

Configures the date, time and clock format of the instrument.

See [Section 7.4, "Date and time"](#), on page 127.

Appearance

Configures the brightness level of the display screen and front panel keys.

See [Section 7.2, "Appearance settings"](#), on page 124.

Sound

Enables or disables beeper for triggered events (e.g. error, fuse tripped, cc-mode continuous).

See [Section 7.3, "Sound settings"](#), on page 126.

Licenses

Displays license information and install license options.

See [Section 7.1, "Licenses management"](#), on page 122.

Device Information

Displays instrument information.

See [Section 7.5.1, "Device information settings"](#), on page 129.

Update Device

Performs firmware update on the instrument.

See [Section 7.6, "Update device"](#), on page 131.

Save/Recall Device Settings

Saves, recalls or resets instrument settings.

See [Section 6.3, "Save and recall"](#), on page 116.

Analog In Adjustment

Available only with option R&S NGP-K107.

Provides user adjustment to the analog input connector and restore factory adjustment.

See [Section 5.12.1, "Analog In adjustment"](#), on page 105.

Channel menu

Depending on instrument models, the channel menu provides access to channel output settings, channel protection features, arbitrary and ramp functions, and safety limits settings.

Access:

1. Press [Home] key.
The R&S NGP800 displays the home window.
2. Select "Settings" softkey on the required channel display area.
Alternatively, press [Settings] key.
3. Select the respective channel tab to access the channel menu.

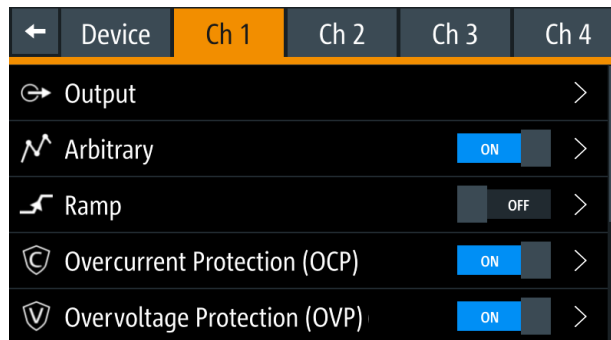

Figure 4-7: Channel 1 menu

Settings

Output.....	58
Arbitrary.....	58
Ramp.....	58
Overcurrent Protection (OCP).....	59
Overvoltage Protection (OVP).....	59
Overpower Protection (OPP).....	59
Analog Input.....	59
Adjustment.....	59
Safety Limit.....	59

Output

Sets the output parameters for the selected channel.

See [Section 5.3, "Output setting"](#), on page 66.

Arbitrary

Configures the arbitrary sequence, sequence repeatability response and the sequence ending behavior.

See [Section 5.10, "Advanced features"](#), on page 94.

"ON" Enables the QuickArb function.

"OFF" Disables the QuickArb function.

Remote command:

[ARbitrary\[:STATe\]](#) on page 222

Ramp

Configures the time taken to ramp up the voltage on the channel output.

See [Section 5.10, "Advanced features"](#), on page 94.

"ON" Enables the EasyRamp function.

"OFF" Disables the EasyRamp function.

Remote command:

[\[SOURCE:\]VOLTage:RAMP\[:STATe\]](#) on page 227

Overcurrent Protection (OCP)

Configures the OCP protection settings ("Blowing Delay", "Initial Delay" and linking channel) for the instrument.

See [Section 5.5.1, "Overcurrent protection \(OCP\)"](#), on page 73.

"ON" Enables the OCP function.

"OFF" Disables the OCP function.

Remote command:

[FUSE\[:STATe\]](#) on page 205

Overvoltage Protection (OVP)

Configures the OVP protection settings (OVP level) for the instrument.

See [Section 5.5.2, "Overvoltage protection \(OVP\)"](#), on page 75.

"ON" Enables the OVP function.

"OFF" Disables the OVP function.

Remote command:

[\[SOURCE:\]VOLTage:PROTection\[:STATe\]](#) on page 207

Overpower Protection (OPP)

Configures the OPP protection settings (OPP level) for the instrument.

See [Section 5.5.3, "Overpower protection \(OPP\)"](#), on page 76.

"ON" Enables the OPP function.

"OFF" Disables the OPP function.

Remote command:

[\[SOURCE:\]POWer:PROTection\[:STATe\]](#) on page 209

Analog Input

Available only with option R&S NGP-K107.

Regulate the output settings for voltage or current via the applied analog input voltage at the rear panel.

See [Section 5.4, "Analog input"](#), on page 71.

Adjustment

Available only with option R&S NGP-K107.

Performs channel adjustment and restores factory adjustment.

See [Section 5.12, "Adjustment"](#), on page 105.

Safety Limit

Configures the voltage and current limit of the channel output.

See [Section 5.5.4, "Safety limits"](#), on page 77.

4.2.1.3 User key



The [*] key provides a shortcut function to one of the followings:

- Screenshot
- Data logging
- Reset statistics
- Toggle touchscreen input

The shortcut key is configurable in the "Device" > "User Button" menu. See [Section 5.8, "User key"](#), on page 86.

4.2.2 Navigation controls



Navigation in the menu and setting of values can be done via the rotary knob and [Back] key.

For more information on how to navigate menus, dialogs and data entry in the instrument, see [Section 3.4.2.2, "Accessing the functionality"](#), on page 46 and [Section 3.4.2.3, "Entering data"](#), on page 47.

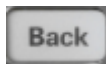

4.2.3 Output and channel controls



Depending on the instrument models, up to four channel keys control the channel output settings of the instrument.

Function keys	Description
[Ch 1] [Ch 2] [Ch 3] [Ch 4]	Selects the respective channel for output.
[Output]	Primary output switch - it turns output for all selected channels on or off.

Settings

[Ch 1] / [Ch 2] / [Ch 3] / [Ch 4]	60
[Output]	61

[Ch 1] / [Ch 2] / [Ch 3] / [Ch 4]

Selects the respective channel for output.

Remote command:

[INSTRument:NSElect](#) on page 182

[INSTRument\[:SElect\]](#) on page 182

[Output]

Primary output switch - it turns output for all selected channels on or off.

Remote command:

`OUTPut:GENeral[:STATe]` on page 198

`OUTPut[:STATe]` on page 199

`OUTPut:SElect` on page 200

4.3 Output power auto-ranging

The R&S NGP800 power supply series provides a maximum output power of 200 W for each channel. Depending on the instrument models, up to 800 W of output power is provided for models with four identical channels with a continuous voltage range of 0 V to 32 V or 64 V.

Combination of the set voltage and current limit results in the following output performance graph.

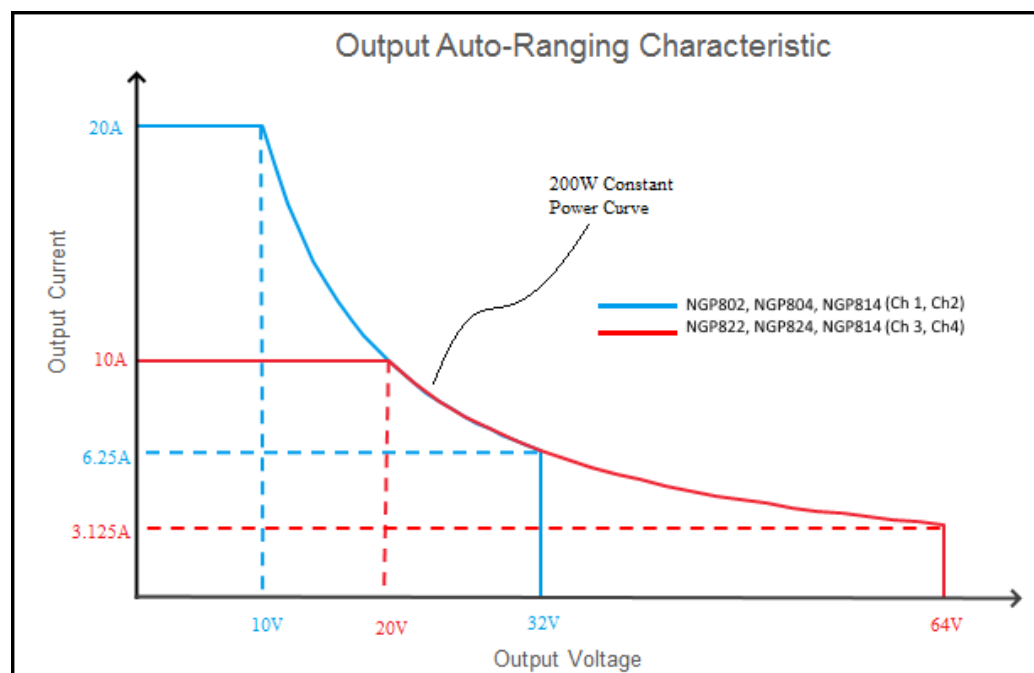

Figure 4-8: Output performance graph

According to the electrical basis formula for power ($P = I \times V$), the following results for the maximum power per channel:

- R&S NGP802, R&S NGP822: 200 W per channel (400 W max for the combination of two channels)
- R&S NGP804, R&S NGP824, R&S NGP814: 200 W per channel (800 W max for the combination of four channels)

For more information on the combination of channels, see [Section 13, "Applications"](#), on page 253.

4.4 Modes of operation

The R&S NGP800 supports two operating modes, i.e. [constant voltage \(CV\)](#) and [constant current \(CC\)](#). The instrument automatically switches between CV and CC depending on the connected load conditions.

4.4.1 Constant voltage mode (CV)

[Figure 4-9](#) shows that the instrument is in the range of voltage regulation. The output voltage V_{out} remains constant while the current may increase to its maximum value I_{max} when the connected load is increasing. In CV mode, the font text in the channel display area changes to green.

See also [Figure 3-12](#).

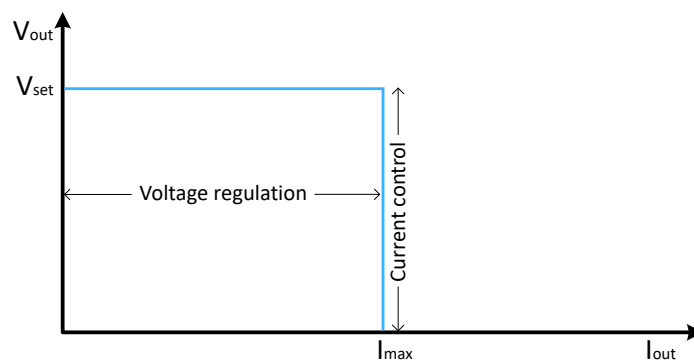

Figure 4-9: Current limit

4.4.2 Constant current mode (CC)

The current I_{max} corresponds to the current setting adjustable in the instrument.

If I_{out} reaches I_{max} , the instrument switches to CC mode, i.e. the output current remains constant and limited to I_{max} even if the load increases, the output voltage V_{out} decreases below V_{set} . In a short circuit, the output voltage drops towards zero. In CC mode, the font text in the channel display area changes to red.

See [Figure 3-12](#) and [Section 5.5.1, "Overcurrent protection \(OCP\)"](#), on page 73.

5 Instrument functions

5.1 Voltage and current

The R&S NGP800 comes with the following instrument models:

Models	Channels
R&S NGP802, R&S NGP822	Ch 1, Ch 2
R&S NGP804, R&S NGP824, R&S NGP814	Ch 1, Ch 2, Ch 3, Ch 4

Toggle the respective channel key ([Ch 1], [Ch 2], [Ch 3], [Ch 4]) on the front panel to select these channels. When a channel is selected, the respective channel key illuminates.

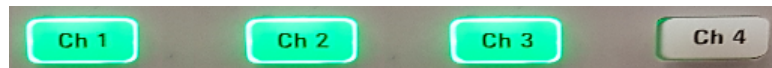

Figure 5-1: Respective channel key illuminates when selected



Voltage, current settings

If [Analog input](#) or [QuickArb](#) function of a selected channel is enabled, the respective channel voltage or current setting is disabled.

Depending on the instrument models, the R&S NGP800 adjusts the following voltage and current values with a voltage step size of 1 mV and current step size of 0.5 mA.

Model	Voltage	Current
R&S NGP802, R&S NGP804, R&S NGP814 (Ch 1, Ch 2)	0 V to 32.05 V	0 A to 20.01 A
R&S NGP822, R&S NGP824, R&S NGP814 (Ch 3, Ch 4)	0 V to 64.05 V	0 A to 10.01 A

The setting of current value corresponds to the I_{\max} of the respective channel. It is recommended to set the current limit before operating the instrument to prevent damage to the load and instrument in the case of malfunction such as a short-circuit.

Access:

- ▶ Press [Home] key.
The R&S NGP800 displays the home window.

To configure voltage and current settings

1. Set the voltage or current in the respective channel display area.

The R&S NGP800 displays the on-screen keyboard to set the value.

2. Enter the required voltage or current value.
3. Confirm the value with the unit softkey ("V"/"mV" or "A"/"mA").
Alternatively, select "Enter" softkey,  to confirm your value.
4. Press the required channel key ([Ch 1], [Ch 2], [Ch 3] or [Ch 4]) on the front panel.
The selected channel key is illuminated.
See [Figure 5-1](#).
5. Press [Output] key on the front panel.
The R&S NGP800 outputs the set voltage of the selected channel and displays the corresponding values in the home window.
For more information on the operation modes, see [Section 4.4, "Modes of operation"](#), on page 62.

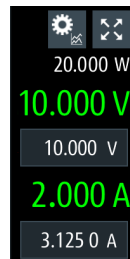

Figure 5-2: Voltage and current settings in the instrument

Settings

[Voltage and current](#)..... 64

Voltage and current

Sets output voltage and current limit for the selected channel.

See also [Section 5.2, "Channel output"](#), on page 64.

Remote command:

[APPLY](#) on page 195

[\[SOURCE:\]VOLTage\[:LEVEL\] \[:IMMEDIATE\] \[:AMPLITUDE\]](#) on page 191

[\[SOURCE:\]VOLTage\[:LEVEL\] \[:IMMEDIATE\]:STEP\[:INCREMENT\]](#) on page 192

[\[SOURCE:\]CURRENT\[:LEVEL\] \[:IMMEDIATE\] \[:AMPLITUDE\]](#) on page 194

[\[SOURCE:\]CURRENT\[:LEVEL\] \[:IMMEDIATE\]:STEP\[:INCREMENT\]](#) on page 194

5.2 Channel output

Depending on the instrument models, the outputs of the channels (Ch 1, Ch 2, Ch 3, Ch 4) can be switched on or off by toggling the [Output] key on the front panel.

By default, the output is turned off when the instrument is switched on. This design prevents a connected load from being damaged unintentionally.

Access:

- ▶ Press the required channel key.
Selected channel key ([Ch 1], [Ch 2], [Ch 3], [Ch 4]) illuminates.

To activate a channel output

- ▶ Press [Output] key.
The R&S NGP800 outputs the set voltage of the selected channel.
Depending on the operating modes, the font color in the channel display area shows green in CV mode and red in CC mode.
See [Section 4.4, "Modes of operation"](#), on page 62.
See also [Section 4.3, "Output power auto-ranging"](#), on page 61.

Multiple outputs can be turned on or off at the same time. See more information in [Section 13, "Applications"](#), on page 253.

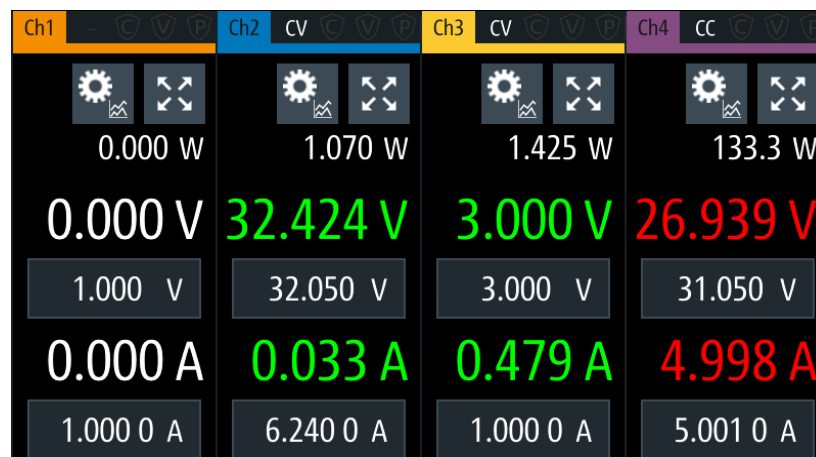

Figure 5-3: Output channels in different operating modes

Settings

[Output]..... 65

[Output]

Activates or deactivates the channel output.

See details in [Section 4.2.3, "Output and channel controls"](#), on page 60.

Remote command:

[OUTPut:GENeral\[:STATE\]](#) on page 198

[OUTPut:SElect](#) on page 200

[OUTPut\[:STATE\]](#) on page 199

5.3 Output setting



The "Output" menu provides the settings for [output delay](#), [remote sensing](#), [high impedance mode](#) and [slew rate control](#).

Access:

- ▶ Select [Settings] > channel tab > "Output" to set the output controls. The R&S NGP800 displays the "Output" dialog.

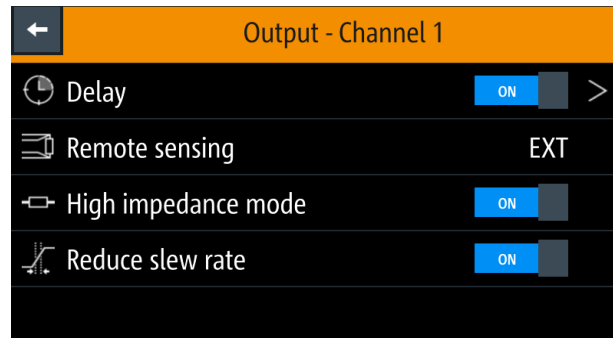

Figure 5-4: Output dialog

5.3.1 Delay

The output delay is the time between the "Output On" event and the available voltage at the output terminals. See [Figure 5-5](#).

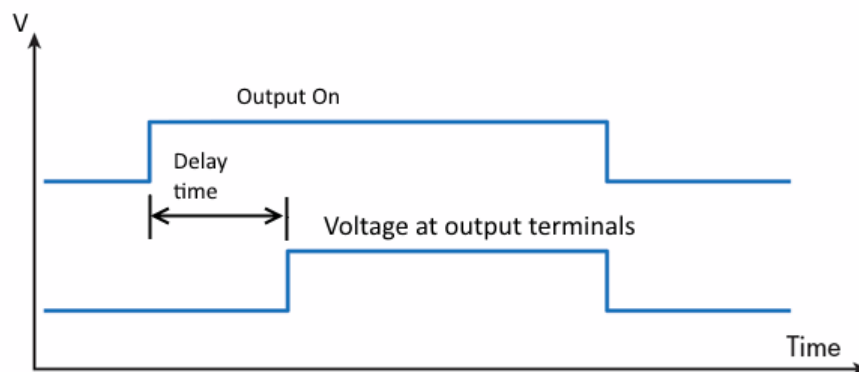

Figure 5-5: Output delay at the output terminals

When the instrument output delay is activated, the front panel of the respective channel key (i.e. [Ch 1], [Ch 2], [Ch 3], [Ch 4]) blinks in green and a "DLY" red text is displayed in the channel display area of the respective channel. See [Figure 5-7](#).

These operating behaviors resume to normal after the delay time.

Access:

- ▶ Select [Settings] > channel tab > "Output" > "Delay" to configure the required values.

The R&S NGP800 displays the "Output Delay" dialog.

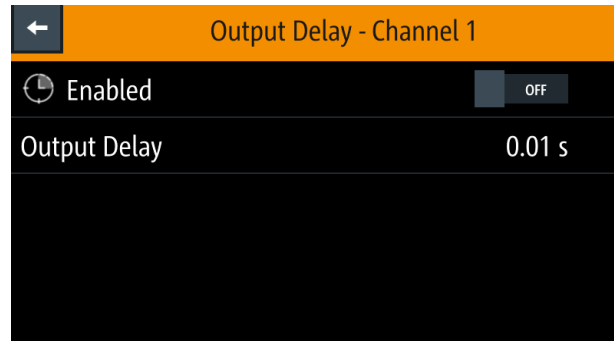



Figure 5-6: Output delay dialog

To configure output delay

1. Set the required value.
The R&S NGP800 displays the on-screen keyboard for entry.
2. Confirm the value with the unit softkey ("ms" or "s").
Alternatively, select "Enter" softkey,  to confirm your value.
3. Set "Enabled" to "ON".
The R&S NGP800 enables the output delay function.

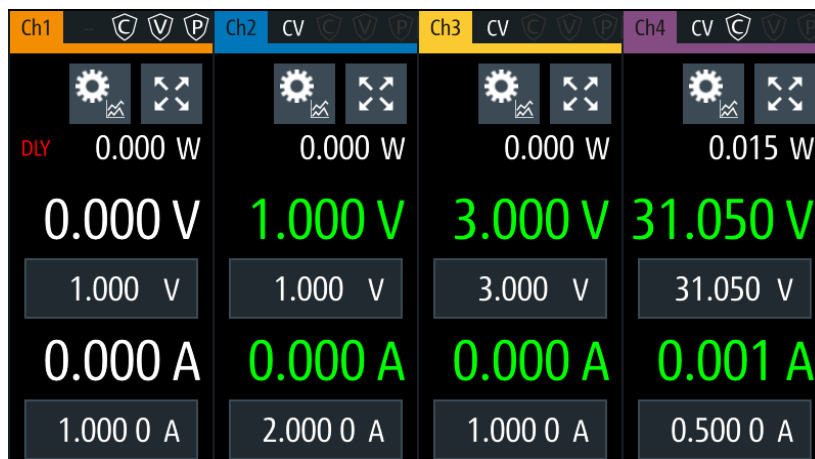

Figure 5-7: Delay text at channel display area

Settings

Enabled.....	68
Delay.....	68

Enabled

Enables or disables output delay.

"ON" Enables output delay.

"OFF" Disables output delay.

Remote command:

[OUTPut:DELaY\[:STATe\]](#) on page 200

Delay

Sets the delay time before the voltage is available at the output terminals.

Remote command:

[OUTPut:DELaY:DURation](#) on page 199

5.3.2 Remote sensing

The "Remote sensing" is a mechanism used to monitor and compensate the voltage drops on the cables connected to the load.

Access:

- ▶ Select [Settings] > channel tab > "Output" > "Remote sensing" to configure the remote sensing mode.
The R&S NGP800 displays the "Select Remote Sense" dialog.

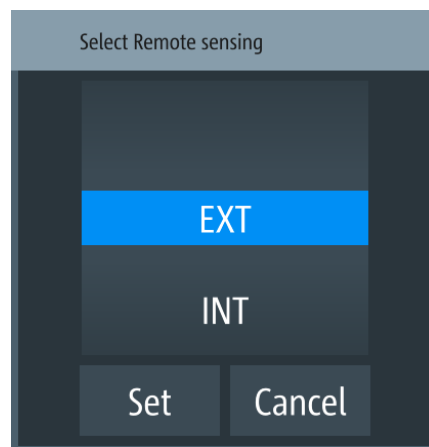

Figure 5-8: Select remote sense dialog

To set the remote sensing mode

1. Select the required remote sensing mode.
See details in ["Remote sensing"](#) on page 69.
2. Select "Set" to configure the remote sensing mode.

Once the remote sense is activated, it becomes part of the output feedback path for R&S NGP800. Disconnection or shorting of the remote sense lines causes a mismatch in the actual output voltage versus the reported value of the instrument. The error of

differences is detected by the instrument and the output is turned off automatically with a corresponding error displayed to instruct the user to check on the connection.



Excessive voltage drops on the loading cables, e.g. using too small wires, can also trigger remote sense protection.

For optimum connection, maintain a maximum voltage drop of 1 V on loading cables is recommended.

Settings

[Remote sensing](#) 69

Remote sensing

Sets remote sense mode for the selected channel.

EXT	The internal voltage sense relay in the instrument is switched on and the connection of remote sensing wires (S+, S-) to the input of the load become necessary. Failure to connect remote sense can cause overvoltage or unregulated voltage output from the R&S NGP800. The voltage sensing relay remains switched on even when the output is turned off.
INT	The internal voltage sense relay in the instrument is switched off. Remote sense is disabled.

Remote command:

[\[SOURCE:\]VOLTage:SENSe\[:SOURCE\]](#) on page 187

[\[SOURCE:\]VOLTage:SENSe:TRIPped?](#) on page 188

[\[SOURCE:\]VOLTage:SENSe:TRIPped:CLEar](#) on page 188

5.3.3 High impedance mode

The "High Impedance Mode" only affects the output behavior when switching off the R&S NGP800 output. With the default settings, the output is discharged quickly using the active current sinking circuit. But if "High Impedance Mode" is enabled, the circuit is disabled when switching off the output, and the output capacitors discharge is determined by the instrument internal resistors ($\sim 900 \Omega$ for 32 V models and $\sim 3400 \Omega$ for 64 V models) and the connected load.

The "High Impedance Mode" does not affect the instrument functions when the output is turned on. Voltage down-programming is still assisted by the active current sinking circuit. If the output is disabled by protection trigger like OVP, OCP, the active current sinking circuit automatically discharges the output capacitors for safety reasons.



Due to circuit biases and offsets, the active current sinking circuit can still draw a small current of up to a few milliamps even if high impedance mode is enabled.

Access:

- ▶ Select [Settings] > channel tab > "Output" > "High Impedance Mode" to activate/deactivate the high impedance mode.
See "[High Impedance Mode](#)" on page 70.

Settings

[High Impedance Mode](#)..... 70

High Impedance Mode

Activates or deactivates the high impedance mode.

"ON" Activates the high impedance mode.

"OFF" Deactivates the high impedance mode.

Remote command:

[OUTPut:IMPedance\[:STATe\]](#) on page 198

5.3.4 Slew rate control

The "Reduce Slew Rate" is a mechanism used to control the rate at which the output of voltage changes. If activated, the voltage slew rate up-programming and down-programming are reduced when changing voltage on the fly. The reducing of slew rate control helps to minimize overshoot over wide output and load configuration.



Slew rate control

- The slew rate control does not affect the output turn-on slew rate programmed via the [EasyRamp](#) function.
- The slew rate control mode is not compatible with [Analog Input](#) and [QuickArb](#) functions. The reduce slew rate function is automatically disabled if any of these functions is used and vice versa.
- The minimum setting voltage is 0.003 V if "Reduce Slew Rate" is activated, e.g. the output voltage is automatically set to 0.003 V if setting value is < 0.003 V.

Access:

- ▶ Select [Settings] > channel tab > "Output" > "Reduce Slew Rate" to activate the slew rate control.

To activate the slew rate control

- ▶ Set the required slew rate control.
See "[Reduce Slew Rate](#)" on page 71.

Settings

[Reduce Slew Rate](#)..... 71

Reduce Slew Rate

Activates or deactivates the slew rate control.

"ON" Activates the slew rate control.

"OFF" Deactivates the slew rate control.

Remote command:

`OUTPut:SRATe[:STATe]` on page 197

5.4 Analog input

**Instrument option**

R&S NGP-K107 (PN: 5601.6200.03) option is required for the "Analog Input".

**Analog input**

If "Analog Input" of a selected channel (voltage or current) is enabled, the respective channel voltage or current setting is disabled.

See [Section 5.1, "Voltage and current"](#), on page 63.



With "Analog Input", you can regulate the channel output (voltage or current) settings with an input voltage of 0 V to 5 V.

Analog input mode	NGP output for 64 V channels	NGP output for 32 V channels
Voltage mode	0 V to 64 V	0 V to 32 V
Current mode	0 A to 10 A	0 A to 20 A

Access:

- ▶ Select [Settings] > channel tab > "Analog Input" to configure the required values. The R&S NGP800 displays the selected "Analog Input" dialog.

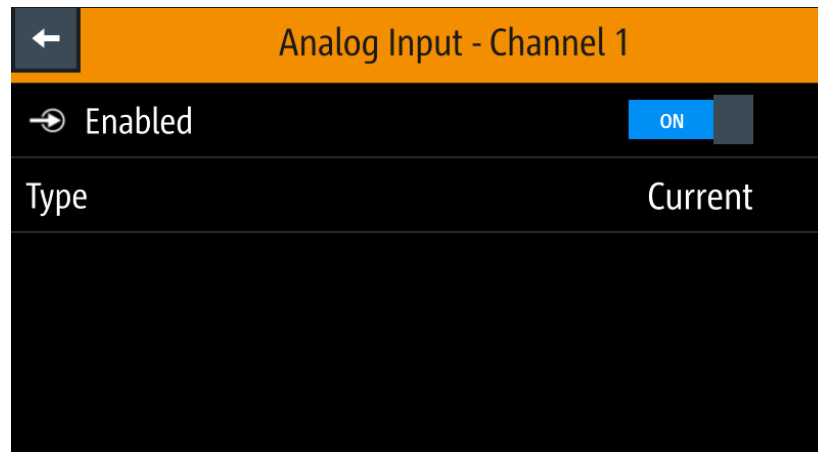

Figure 5-9: Analog input dialog

To set analog input type

1. Select the required type to regulate the channel output setting.
The R&S NGP800 displays the "Select Analog Input Type" dialog.
See also "Type" on page 73.

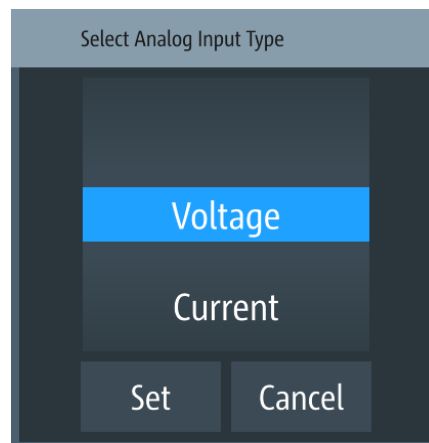

Figure 5-10: Select analog input type dialog

2. Select "Set" to confirm the required type.
3. Set "Enabled" to "ON".
The R&S NGP800 enables the "Analog in" input and disables the selected channel settings (voltage or current).

Settings

Enabled.....	73
Type.....	73
L Set.....	73
L Cancel.....	73

Enabled

Allows configuration of the analog input type.

"ON" Enables the analog input type.

"OFF" Disables the analog input type.

Remote command:

[[SOURce:](#)] [VOLTagE:AINPut\[:STATe\]](#) on page 229

See also [[SOURce:](#)] [VOLTagE:AINPut:TRIGgered\[:STATe\]](#) on page 229.

Type

Sets analog input type (voltage or current) when enabled.

"Voltage" Sets the analog input type as "Voltage".

"Current" Sets the analog input type as "Current".

Remote command:

[[SOURce:](#)] [VOLTagE:AINPut:INPut](#) on page 228

Set ← Type

Applies the configuration settings.

Cancel ← Type

Cancels the configuration settings.

5.5 Protection

There are various ways in which the R&S NGP800 protects itself and the connected load from damage due to overvoltage, overcurrent and overpower drawn by the load during testing.

- [Overcurrent protection \(OCP\)](#)..... 73
- [Overvoltage protection \(OVP\)](#)..... 75
- [Overpower protection \(OPP\)](#)..... 76
- [Safety limits](#)..... 77

5.5.1 Overcurrent protection (OCP)



When the drawn current exceeds the limit set for the respective channels, an alert is triggered and the affected channels are turned off according to the settings configured in the [OCP](#) dialog.

Access:

- ▶ Select [[Settings](#)] > channel tab > "Overcurrent Protection (OCP)" to set OCP controls.

The R&S NGP800 displays the OCP dialog.

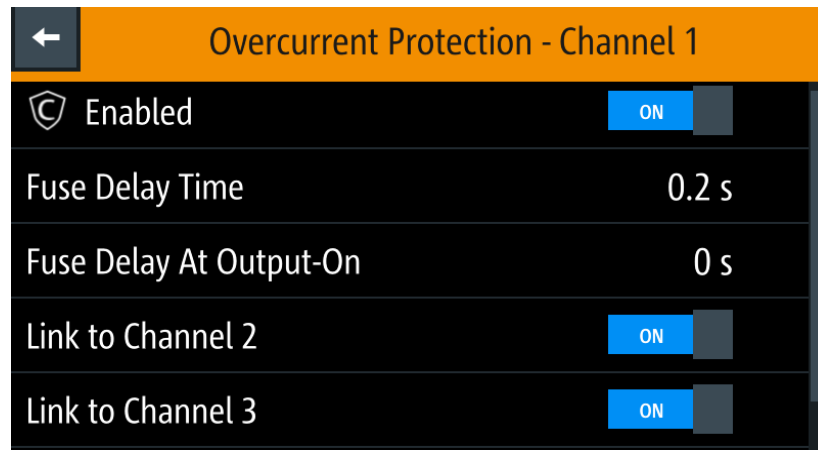



Figure 5-11: Overcurrent protection dialog

To configure overcurrent protection (OCP)

1. Set "Enabled" to "ON".
The R&S NGP800 enables the OCP and displays the OCP icon on the selected channel status bar information.
2. Set the required "Fuse Delay Time" and "Fuse Delay At Output-On".
The R&S NGP800 displays the on-screen keyboard to set the values.
3. Confirm the value with the unit softkey ("ms" or "s").
Alternatively, select "Enter" softkey,  to confirm your value.
4. Activate the required linked channels for over current protection.
The linked channels are turned off when an OCP event is triggered.

Settings

Enabled.....	74
Fuse Delay Time.....	75
Fuse Delay At Output-On.....	75
Link to Channel 1 / Link to Channel 2 / Link to Channel 3 / Link to Channel 4.....	75

Enabled

Enables or disables the overcurrent protection feature.

"ON" Enables the OCP and displays the OCP icon on the selected channel status bar information.

"OFF" Disables the OCP feature.

Remote command:

[FUSE \[: STATE\]](#) on page 205

[FUSE:TRIPped?](#) on page 204

[FUSE:TRIPped:CLEar](#) on page 202

[\[SOURCE:\]PROTECTION:CLEar](#) on page 211

Fuse Delay Time

Time taken to turn off the affected channel after OCP is triggered.

Remote command:

`FUSE:DElAy[:BLOWing]` on page 203

Fuse Delay At Output-On

Time taken after channel output is turned on before OCP is put into operation.

Remote command:

`FUSE:DElAy:INITial` on page 203

Link to Channel 1 / Link to Channel 2 / Link to Channel 3 / Link to Channel 4

Depending on the instrument models, up to three channels can be linked.

Activates the required linked channel when an OCP event is triggered.

"ON" The linked channels are turned off when an OCP event is triggered.

"OFF" The linked channels are not affected when an OCP event is triggered.

Remote command:

`FUSE:LINK` on page 204

`FUSE:UNLink` on page 204

5.5.2 Overvoltage protection (OVP)

When the output voltage exceeds the limit set for the respective channel, an alert is triggered and the affected channel is turned off according to the settings configured in the **OVP** dialog.

Access:

- ▶ Select [Settings] > channel tab > "Overvoltage Protection (OVP)" to set OVP controls.

The R&S NGP800 displays the OVP dialog.

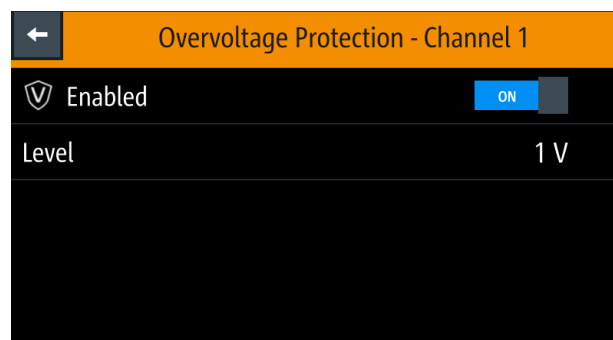



Figure 5-12: Overvoltage protection dialog

To configure overvoltage protection (OVP)

1. Set "Enabled" to "ON".

The R&S NGP800 enables the OVP and displays the OVP icon on the selected channel status bar information.

2. Set the required level for OVP.
The R&S NGP800 displays the on-screen keyboard to set the value.
3. Confirm the value with the unit softkey ("mV" or "V").
Alternatively, select "Enter" softkey,  to confirm your value.

Settings

Enabled	76
Level	76

Enabled

Enables or disables the overvoltage protection feature.

"ON" Enables the OVP and displays the OVP icon on the selected channel status bar information.

"OFF" Disables the OVP feature.

Remote command:

[\[SOURCE:\]VOLTage:PROTection\[:STATe\]](#) on page 207

[\[SOURCE:\]VOLTage:PROTection:CLEar](#) on page 207

[\[SOURCE:\]VOLTage:PROTection:TRIPped?](#) on page 208

[\[SOURCE:\]PROTection:CLEar](#) on page 211

Level

Sets the required level for OVP.

Remote command:

[\[SOURCE:\]VOLTage:PROTection:LEVel](#) on page 207

5.5.3 Overpower protection (OPP)



When the output power exceeds the limit set for the respective channels, an alert is triggered and the affected channels are turned off according to the settings configured in the [OPP](#) dialog.

Access:

- ▶ Select [Settings] > channel tab > "Overpower Protection (OPP)" to set OPP controls.

The R&S NGP800 displays the OPP dialog.

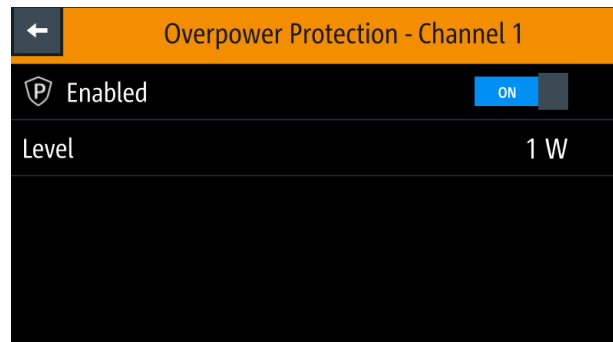



Figure 5-13: Overpower protection dialog

To configure overpower protection (OPP)

1. Set "Enabled" to "ON".
The R&S NGP800 enables the OPP and displays the "Overpower Protection (OPP)" icon on the selected channel status bar information.
2. Set the required level for OPP.
The R&S NGP800 displays the on-screen keyboard to set the value.
3. Confirm the value with the unit softkey ("mW" or "W").
Alternatively, select "Enter" softkey,  to confirm your value.

Settings

Enabled.....	77
Level.....	77

Enabled

Enables or disables the overpower protection feature.

"ON" Enables the OPP and displays the OPP icon on the selected channel status bar information.

"OFF" Disables the OPP feature.

Remote command:

[SOURCE:]POWER:PROTECTION[:STATE] on page 209

[SOURCE:]POWER:PROTECTION:CLEAR on page 210

[SOURCE:]POWER:PROTECTION:TRIPPED? on page 211

[SOURCE:]PROTECTION:CLEAR on page 211

Level

Sets the required level for OPP.

Remote command:

[SOURCE:]POWER:PROTECTION:LEVEL on page 210

5.5.4 Safety limits



With safety limits set in the instrument, the range of the output voltage and/or output current can be limited. The safety limit prevents inadvertently setting dangerous values for the connected DUT.



The "Safety Limits" function is disabled if [QuickArb](#) function or [Analog input](#) function is in use.

Access:

- ▶ Select [Settings] > channel tab > "Safety Limits" to set safety limits. The R&S NGP800 displays the "Safety Limits" dialog.



Figure 5-14: Safety limits dialog

To configure safety limits

1. Set the required minimum and maximum value for voltage and current level. The R&S NGP800 displays an on-screen keyboard to set the value.
2. Confirm the value with the unit softkey ("V"/"mV" or "A"/"mA"). Alternatively, select "Enter" softkey,  to confirm your value.
3. Set "Enabled" to "ON". The R&S NGP800 limits the set voltage and current level and displays the "Safety Limits" icon on the selected channel status bar information.

Settings

Enabled.....	78
Voltage Limit Min / Voltage Limit Max.....	79
Current Limit Min / Current Limit Max.....	79

Enabled

Enables or disables setting the safety limits of the instrument.

"ON"	Limits the set voltage and current level and displays the "Safety Limits" icon on the selected channel status bar information.
"OFF"	Disables the safety limit of the instrument.

Remote command:

[\[SOURCE:\]ALIMit\[:STATE\]](#) on page 185

Voltage Limit Min / Voltage Limit Max

Sets the maximum or minimum voltage level of the output channels.

Remote command:

[SOURce:]VOLTage[:LEVel][:IMMediate]:ALIMit:LOWer on page 185

[SOURce:]VOLTage[:LEVel][:IMMediate]:ALIMit[:UPPer] on page 186

Current Limit Min / Current Limit Max

Sets the maximum or minimum current level of the output channels.

Remote command:

[SOURce:]CURRent[:LEVel][:IMMediate]:ALIMit:LOWer on page 186

[SOURce:]CURRent[:LEVel][:IMMediate]:ALIMit[:UPPer] on page 187

5.6 Tracking function

For power supplies with multiple channels, the channels can be linked such that changes made on the selected tracked channel are applied to other channels.

Access:

- ▶ Select [Settings] > "Device" tab > "Tracking" to configure tracking.
The R&S NGP800 displays the "Tracking" dialog.

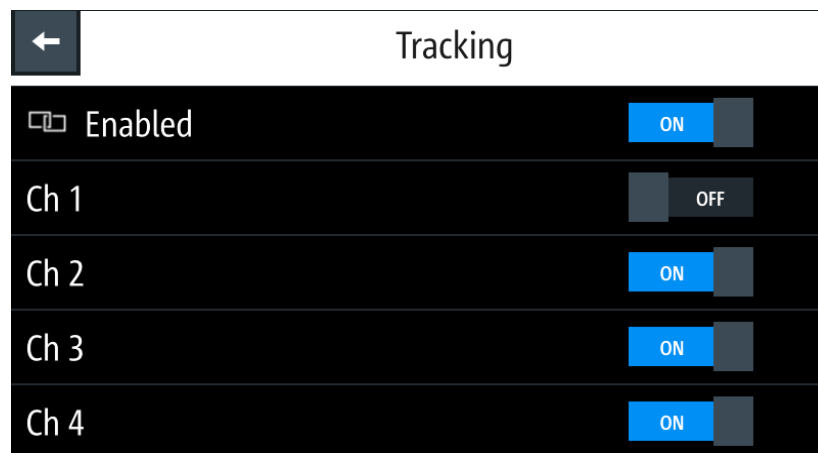

Figure 5-15: Tracking dialog

To set a tracking function

1. Activate the "Enabled" to enable the tracking function.
2. Set the required channels to be tracked.
The R&S NGP800 tracks the voltage and/or current values to the selected tracked channels.

Settings

Enabled.....	80
Ch 1 / Ch 2 / Ch 3 / Ch 4.....	80

Enabled

Activates or deactivates the tracking function.

"ON" Activates the tracking function.

"OFF" Deactivates the tracking function.

Remote command:

[TRACking\[:ENABle\]:SElect:CH<CHANNEL>](#) on page 212

[TRACking\[:ENABle\]:CH<CHANNEL>](#) on page 212

Ch 1 / Ch 2 / Ch 3 / Ch 4

Sets tracking function for the selected channel.

"ON" Activates the tracking function for the selected channel.

"OFF" Deactivates the tracking function for the selected channel.

Remote command:

[TRACking\[:ENABle\]:SElect:CH<CHANNEL>](#) on page 212

[TRACking\[:ENABle\]:CH<CHANNEL>](#) on page 212

[TRACking\[:ENABle\]:GENeral](#) on page 212

5.7 Digital trigger I/O

NOTICE**Risk of instrument damage**

Do not exceed the maximum voltage rating of the digital I/O pins (5.25 V max) when supplying voltages to the pins.

For more information, see the instrument specification.

**Instrument option**

R&S NGP-K103 (PN: 5601.6300.03) option is required for the digital I/O signals.



The eight data lines of the digital I/O interface are mutually independent and can be used as trigger input or trigger output separately. See [Table 3-4](#) and also [Figure 5-16](#).

- [Trigger input](#)
- [Trigger output](#)

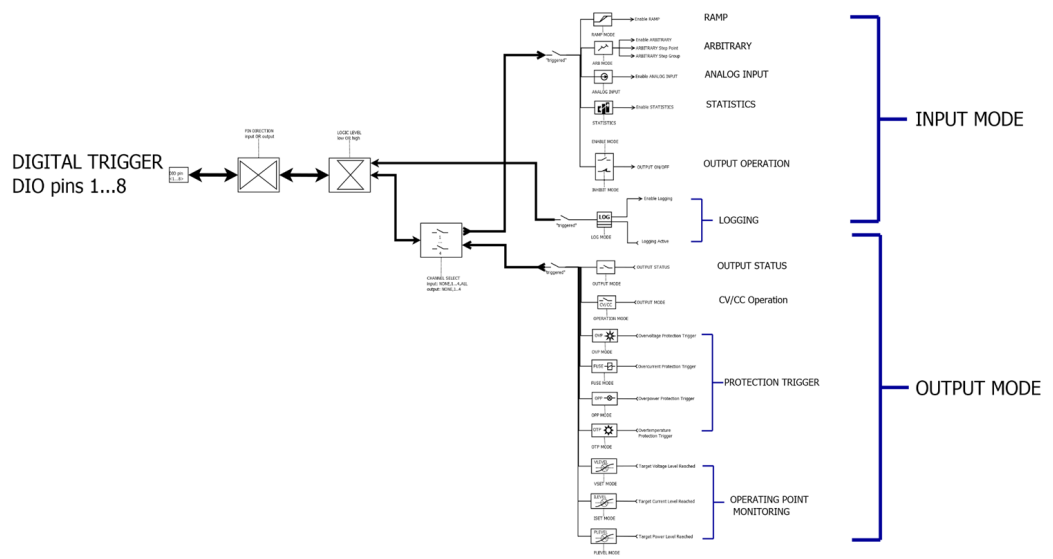

Figure 5-16: DIO trigger block diagram

Trigger input

The data lines of the digital I/O interface receive an external trigger signal. The external trigger signal triggers the selected channel ("Ch 1", "Ch 2", "Ch 3", "Ch 4" or "All") with the set response when the trigger logic ("Active High" or "Active Low") is met.

Table 5-1: Trigger in parameters and conditions

Trigger in parameters	Trigger conditions	Description
Channel	"--", "Ch 1", "Ch 2", "Ch 3", "Ch 4" or "All"	Target output channel selected for trigger response. If "--" is selected, no channel is selected for trigger response.
Mode	"Enable"	Selected channel output is turned on when the selected logic level is met.
	"Arb Enable"	Selected channel QuickArb function is enabled when the selected logic level is met.
	"Arb Step Point"	Selected channel QuickArb function steps to the next point when the selected logic level is met.
	"Arb Step Group"	Selected channel QuickArb function steps to the next group when the selected logic level is met.
	"Ramp"	Selected channel EasyRamp function is enabled when the selected logic level is met.
	"Logging"	Selected channel logging function is enabled when the selected logic level is met.
	"Statistics"	Selected channel Statistics function is enabled when the selected logic level is met.

Trigger in parameters	Trigger conditions	Description
	"AnalogIn"	Selected channel analog input is enabled when the selected logic level is met.
	"Inhibit"	Selected channel output is inhibited when the selected logic level is met. If the selected channel output is put to "inhibit" state, manual or remote operation on the selected channel output is no longer possible. To reverse the "inhibit" state, remove the source of the trigger signal. You can either disable the affected digital I/O interface or remove the source from the affected digital I/O interface at the rear panel.
Active Level	"High"	Set the logic level of the trigger in signal.
	"Low"	

Trigger output

The data lines of the digital I/O interface output an "Active High" or "Active Low" signal when the trigger logic of the selected channel ("Ch 1", "Ch 2", "Ch 3", "Ch 4") is met.

Table 5-2: Trigger out parameters and conditions

Trigger out parameters	Trigger conditions	Description
Channel	"--", "Ch 1", "Ch 2", "Ch 3", "Ch 4"	Output channel selected to monitor for trigger conditions. If "--" is selected, no channel is selected for trigger response.
Mode	"Output"	Output the selected logic level when the output is turned on at the selected channel.
	"Fuse"	Output the selected logic level when a fuse tripped event occurs on the selected channel. See Section 5.5.1, "Overcurrent protection (OCP)" , on page 73.
	Operation Mode, "OperationMode"	<ul style="list-style-type: none"> "CC": Output the selected logic level when the selected channel operates in the CC mode. See Section 4.4.2, "Constant current mode (CC)", on page 62. "CV": Output the selected logic level when the selected channel operates in the CV mode. See Section 4.4.1, "Constant voltage mode (CV)", on page 62.
	Voltage Level, "Vset"	>= "Voltage Level"
Current Level, "Iset"	>= "Current Level"	Output the selected logic level when the current level of the selected channel is greater or equal to the set current level.

Trigger out parameters	Trigger conditions		Description
	Power Level, "Plevel"	>= "Power Level"	Output the selected logic level when the power level of the selected channel is greater or equal to the set power level.
	Critical event	"OVP"	Output the selected logic level when the selected critical event ("OVP", "OPP", "OTP") occurs on the selected channel. See Section 5.5, "Protection" , on page 73.
		"OPP"	
		"OTP"	
	"Logging"		Output the selected logic level when the logging is enabled.
Active Level	"High"		Set the logic level of the trigger out signal.
	"Low"		

Access:

- ▶ Select [Settings] > "Device" tab > "Digital Trigger Menu" to configure digital I/O trigger.
The R&S NGP800 displays the "Digital Trigger Menu" dialog.

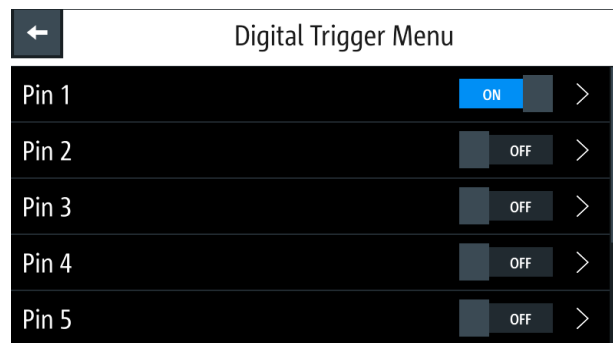

Figure 5-17: Digital trigger menu

To configure digital I/O triggers

1. Set the required pins to "ON" to enable the respective trigger settings for the selected pins.
2. Select the respective pins to configure the trigger settings.
The R&S NGP800 displays the respective pin dialog for configuration.

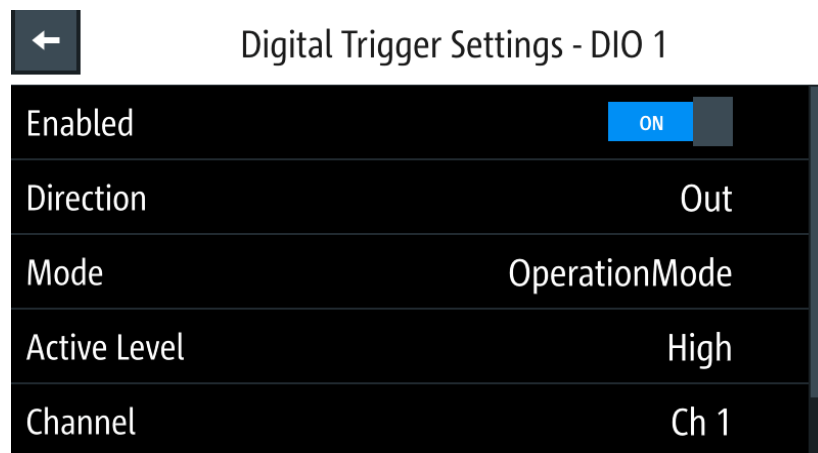

Figure 5-18: Digital trigger settings for pin 1

- Set the required pin "Direction".
Depending on the pin direction, different operating modes are available for trigger settings.
See [Table 5-1](#) and [Table 5-2](#).
- Set the required "Active Level" and "Channel" settings.
- Select "Back" softkey > "Enabled" to "ON" to enable the digital I/O trigger.
The R&S NGP800 monitors the digital I/O trigger conditions and feedback to the respective channels or pins.

Settings

Pin 1 / ... / Pin 8.....	84
L Enabled.....	84
L Direction.....	85
L Mode.....	85
L Active Level.....	85
L Channel.....	85
L Operation Mode.....	85

Pin 1 / ... / Pin 8

Sets the selected digital I/O pin settings.

- "ON" Enables the selected digital I/O pin settings.
"OFF" Disables the selected digital I/O pin settings.

Remote command:

[TRIGger\[:ENABLE\]:SElect:DIO<IO>](#) on page 181

[TRIGger\[:ENABLE\]:DIO<IO>](#) on page 180

Enabled ← Pin 1 / ... / Pin 8

Enables or disables the digital I/O trigger.

- "ON" Activates the selected digital I/O trigger.
"OFF" Deactivates the selected digital I/O trigger.

Remote command:

`TRIGger[:ENABLE]:DIO<IO>` on page 180

`TRIGger[:ENABLE]:SElect:DIO<IO>` on page 181

Direction ← Pin 1 / ... / Pin 8

Sets the trigger direction.

See [Table 5-1](#) and [Table 5-2](#).

Remote command:

`TRIGger:DIRection:DIO<IO>` on page 179

Mode ← Pin 1 / ... / Pin 8

Sets the trigger mode for the selected digital I/O interface.

See [Table 5-1](#) and [Table 5-2](#).

Remote command:

`TRIGger:CONDItion:DIO<IO>` on page 178

`[SOURce:]VOLTage:AINPut:TRIGgered[:STATe]` on page 229

`LOG:TRIGgered[:STATe]` on page 241

`ARBItrary:TRIGgered[:STATe]` on page 226

`ARBItrary:TRIGgered:GROup[:STATe]` on page 225

`ARBItrary:TRIGgered:POINt[:STATe]` on page 226

Active Level ← Pin 1 / ... / Pin 8

Sets the trigger logic of the selected digital I/O interface.

"High" Trigger logic is set to active high for the selected digital I/O interface.

"Low" Trigger logic is set to active low for the selected digital I/O interface.

Remote command:

`TRIGger:LOGic:DIO<IO>` on page 180

Channel ← Pin 1 / ... / Pin 8

Sets the channel for monitoring of the trigger conditions.

For details, see [Table 5-1](#) and [Table 5-2](#).

Remote command:

`TRIGger:CHANnel:DIO<IO>` on page 177

Operation Mode ← Pin 1 / ... / Pin 8

Available only for trigger output and "Mode" is set to "OperationMode".

Outputs the selected logic level when the selected channel operates in the CC or CV mode.

See also [Section 4.4, "Modes of operation"](#), on page 62.

Remote command:

`TRIGger:CONDItion:DIO<IO>` on page 178

5.8 User key



The R&S NGP800 allows you to configure the user action for one of the following functions:

- Screenshot image from instrument
- [Reset statistical data](#)
- Data logging
- Enable/Disable touchscreen function

Access:

- ▶ Select [Settings] > "Device" tab > "User Button" > "User Button Action" to configure the user key action.

Alternatively, long-press [*] key to configure the user key action.

The R&S NGP800 displays the "Select A User Button Action" dialog.

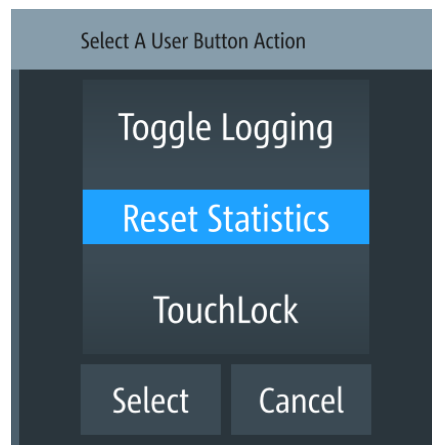

Figure 5-19: User key action

To configure a user key action

1. Select the required user action.
For details, see "[Settings](#)" on page 86.
2. Select "Select" to confirm the action.

Settings

Screenshot	87
Toggle Logging	87
Reset Statistics	87
TouchLock	87
Select	87
Cancel	87

Screenshot

Captures the current screen image of the instrument.

Remote command:

n.a.

Toggle Logging

Enables or disables the data logger function.

Remote command:

[LOG\[:STATe\]](#) on page 237

Reset Statistics

Resets sample count, energy result, power, voltage and current values.

Remote command:

[MEASure\[:SCALar\]:STATistic:RESet](#) on page 214

TouchLock

Enables or disables the touchscreen function of the instrument.

Remote command:

[SYSTem:TOUCh\[:STATe\]](#) on page 175

Select

Applies the configuration.

Remote command:

n.a.

Cancel

Cancels the configuration.

Remote command:

n.a.

5.9 Measurement function

5.9.1 Statistics

The R&S NGP800 includes a statistic function which is able to determine statistic values (Min/Max/Avg) for power, current and voltage for each channel.

For details, see ["Historical channel information"](#) on page 41.

See also [Section 4.1.1.3, "Expand/Collapse softkey"](#), on page 52.

To reset statistics settings

- ▶ Select "Reset",  to reset all statistical values in respective channel. The R&S NGP800 resets all statistic values to 0.

Alternatively, you can configure a user short key to reset all statistical values from all channels. For details, see [Section 5.8, "User key"](#), on page 86.

Settings

Min	88
Max	88
Avg	88
E	88
Reset, 	88

Min

Displays the minimum value for power, voltage and current measurements.

Remote command:

[MEASure\[:SCALar\]:POWer:MIN?](#) on page 217

[MEASure\[:SCALar\]\[:VOLTagE\]\[:DC\]:MIN?](#) on page 218

[MEASure\[:SCALar\]:CURRent\[:DC\]:MIN?](#) on page 215

Max

Displays the maximum value for power, voltage and current measurements.

Remote command:

[MEASure\[:SCALar\]:POWer:MAX?](#) on page 216

[MEASure\[:SCALar\]\[:VOLTagE\]\[:DC\]:MAX?](#) on page 218

[MEASure\[:SCALar\]:CURRent\[:DC\]:MAX?](#) on page 215

Avg

Displays the average value for power, voltage and current measurements.

Remote command:

[MEASure\[:SCALar\]:POWer:AVG?](#) on page 216

[MEASure\[:SCALar\]\[:VOLTagE\]\[:DC\]:AVG?](#) on page 217

[MEASure\[:SCALar\]:CURRent\[:DC\]:AVG?](#) on page 215

E

Displays the energy consumption of the channel.

Remote command:

[MEASure\[:SCALar\]:ENERgy?](#) on page 214

Reset,

The "Reset" softkey resets the statistic values of the channel.

Remote command:

[MEASure\[:SCALar\]:STATistic:RESet](#) on page 214

[MEASure\[:SCALar\]:STATistic:COUNt?](#) on page 214

5.9.2 Data logging



When data logging is activated, the R&S NGP800 records the voltage, current and power data and stores it in the predefined target folder. The measurement data can be stored on the USB flash drive or in the instrument internal memory location.

The logging interval can be set in the range from 8 ms to 600 s with a step size of 8 ms.



External USB hard disc drives (or USB extension) are not supportable. Only FAT32 formatted USB flash drives can be used.

The following shows a sample of a log file captured from R&S NGP800.

#Device	NGP802						
#Calibration Ch1	factory						
#Calibration Ch2	factory						
Timestamp	U1[V]	I1[A]	P1[W]	U2[V]	I2[A]	P2[W]	
12:51.3	5.1801	0.00161	0.00835	11.0004	0.00059	0.00652
12:51.4	5.1801	0.0016	0.00831	11.0003	0.0006	0.00665
12:51.5	5.1801	0.00161	0.00836	11.0004	0.0006	0.00657
12:51.6	5.1801	0.0016	0.0083	11.0004	0.0006	0.00658
12:51.7	5.1801	0.00161	0.00832	11.0004	0.00062	0.00679
12:51.8	5.1801	0.00162	0.00838	11.0003	0.00062	0.00682
12:51.9	5.1801	0.00161	0.00836	11.0003	0.0006	0.00660
12:52.0	5.1801	0.00161	0.00835	11.0004	0.0006	0.00662
12:52.1	5.1801	0.00161	0.00834	11.0004	0.0006	0.00663
12:52.2	5.1801	0.00162	0.00837	11.0004	0.00062	0.00683
12:52.3	5.1801	0.00162	0.00838	11.0004	0.00062	0.00686
12:52.4	5.1801	0.00161	0.00836	11.0004	0.00063	0.00695
12:52.5	5.1801	0.00161	0.00836	11.0004	0.00062	0.00681
12:52.6	5.1801	0.00161	0.00834	11.0004	0.00062	0.00683
12:52.7	5.1801	0.00161	0.00833	11.0004	0.00062	0.00684
12:52.8	5.1801	0.0016	0.00829	11.0003	0.00062	0.00682
12:52.9	5.1801	0.00159	0.00825	11.0004	0.00062	0.00683
12:53.0	nan	nan	nan	nan	nan	nan	
12:53.1	nan	nan	nan	nan	nan	nan	
12:53.2	nan	nan	nan	nan	nan	nan	

Figure 5-20: Sample of data logging

Access:

1. If available, attach a USB storage to the USB connector on the front panel.
If no USB flash drive is available, the device stores the data in its internal memory.
2. Select [Settings] > "Device" tab > "Logging" to configure the data logger.
The R&S NGP800 displays the "Logging" dialog.

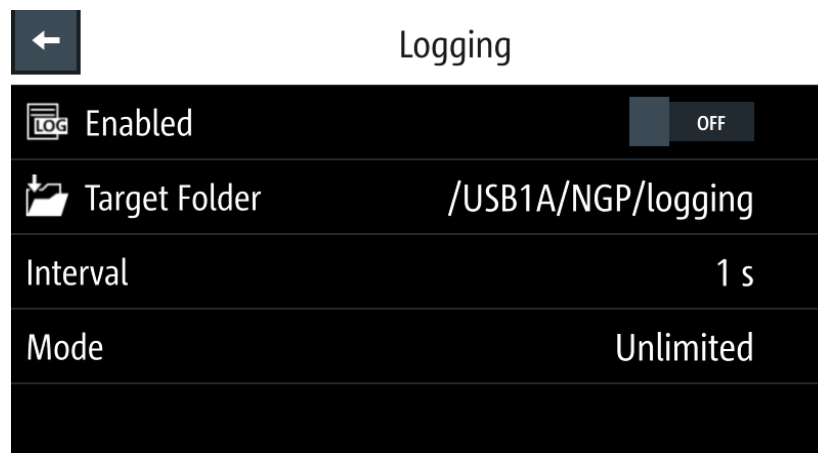

Figure 5-21: Logging dialog

To configure data logging

1. Select "Target Folder" to set the predefined target folder for data logging. If no USB flash drive is detected, the "Target Folder" is set to an internal memory ("int") partition. By default, the "USB1A" partition is selected if the USB flash drive is detected.

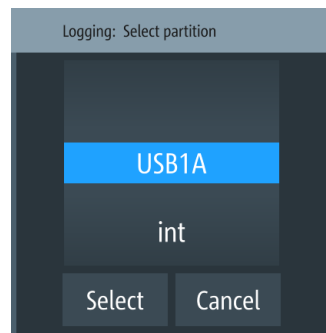

Figure 5-22: Target folder dialog

2. Set the required "Target Folder".
3. Select "Mode" to set the logging duration. See details in ["Mode"](#) on page 91.
4. Depending on the selected mode, configure the required settings for the data logging duration.
5. Set "Enabled" to "ON" to enable data logging. The R&S NGP800 activates the logging and locks the file saved location and logging mode settings.
6. Configure the "CSV Settings". See [Section 5.9.3, "CSV settings"](#), on page 92.

Settings

Enabled	91
Target Folder	91
Interval	91
Mode	91

Enabled

Enables or disables data logging events.

"ON" Enables data logging.

"OFF" Disables data logging.

Remote command:

[LOG\[:STATe\]](#) on page 237

Target Folder

Selects the predefined target folder for data logging.

"USB1A" Selects /USB1A/NGP/logging as the target folder.

"int" Selects /int/logging as the target folder.

Remote command:

[LOG:LOCation](#) on page 240

[LOG:FNAME?](#) on page 239

Interval

Sets the time interval for data logging.

Remote command:

[LOG:INTERval](#) on page 239

Mode

Sets logging duration.

"Duration" Time taken for data logging with duration and time interval setting.

"Span" Time taken for data logging with start time, time interval and duration setting.

"Unlimited" Data logging with time interval setting. The data is logged continuously until the function is deactivated.

"Count" Data logging with number of counts and time interval setting.

Remote command:

[LOG:MODE](#) on page 240

[LOG:COUNT](#) on page 238

[LOG:DURATION](#) on page 239

[LOG:STIME](#) on page 241

5.9.3 CSV settings



The CSV file stores tabular data (numbers and text) in plain text. Each line of the file is a data record and each record consists of one or more fields, separated by a file delimiter. The "CSV Settings" provides you with ways to format the fields that are stored in the data logging. See [Figure 5-20](#).

Access:

- ▶ Select [Settings] > "Device" tab > "CSV Settings" to configure the CSV parameters. The R&S NGP800 displays the "CSV Settings" dialog.

← CSV Settings	
Field Delimiter	Comma
Decimal Separator	Dot
Error Designator	IEEE Float (NaN)
Line End Marker	CR/LF

Figure 5-23: CSV settings dialog

To set CSV parameters

1. Set the required CSV parameters.
The R&S NGP800 displays the respective dialog to set the CSV parameter.
For details, see ["Settings"](#) on page 92.
2. Select "Set" to confirm the value.

Settings

Field Delimiter.....	92
L Set.....	93
L Cancel.....	93
Decimal Separator.....	93
L Set.....	93
L Cancel.....	93
Error Designator.....	93
L Set.....	93
L Cancel.....	93
Line End Marker.....	93
L Set.....	93
L Cancel.....	93

Field Delimiter

Sets the field delimiter.

"Comma" Sets comma as the field separator.

"Semicolon" Sets semicolon as the field separator.

Set ← Field Delimiter

Applies the changes.

Cancel ← Field Delimiter

Cancels the changes.

Decimal Separator

Sets the decimal separator.

"Dot" Sets dot as the decimal separator.

"Comma" Sets comma as the decimal separator.

Set ← Decimal Separator

Applies the changes.

Cancel ← Decimal Separator

Cancels the changes.

Error Designator

Sets the error designator.

"IEEE Float (NaN)" Sets "IEEE Float (NaN)" as the error designator.

"Empty" Sets empty value as the error designator.

Set ← Error Designator

Applies the changes.

Cancel ← Error Designator

Cancels the changes.

Line End Marker

Sets the line end marker.

"CR/LF" Sets CR/LF as the line end marker.

"LF" Sets LF as the line end marker.

Set ← Line End Marker

Applies the changes.

Cancel ← Line End Marker

Cancels the changes.

5.10 Advanced features

Apart from providing the correct voltage and current to load, setting limits and load protection during testing, the R&S NGP800 provides advanced features such as the QuickArb and EasyRamp functions to control the waveform of voltage and current output.

5.10.1 QuickArb



The arbitrary function allows you to generate freely programmable waveforms for voltage and current.



QuickArb function

If the arbitrary function of a selected channel is enabled, the respective channel voltage, current setting and safety limit settings are disabled.

See [Section 5.1, "Voltage and current"](#), on page 63.

Access:

- ▶ Select [Settings] > channel tab > "Arbitrary" to configure the arbitrary function. The R&S NGP800 displays the "Arbitrary" dialog.

#	File	Data Points	Repetitions
5	/int/newWaveform500R1.csv	500	1
6	/int/newWaveform.csv	4	1
7	/int/newWaveformRep2.csv	4	2
8	/int/newWaveform.csv	4	1

Figure 5-24: Arbitrary dialog

To configure the arbitrary function

1. Select any of the rows to load or change the arbitrary file in the arbitrary sequence. Up to eight arbitrary files with a maximum of 1024 data points can be loaded. The R&S NGP800 opens a dialog to select the file location.
2. Select the desired file location.
3. Select "Select" to load the selected file. The R&S NGP800 loads the selected arbitrary file.

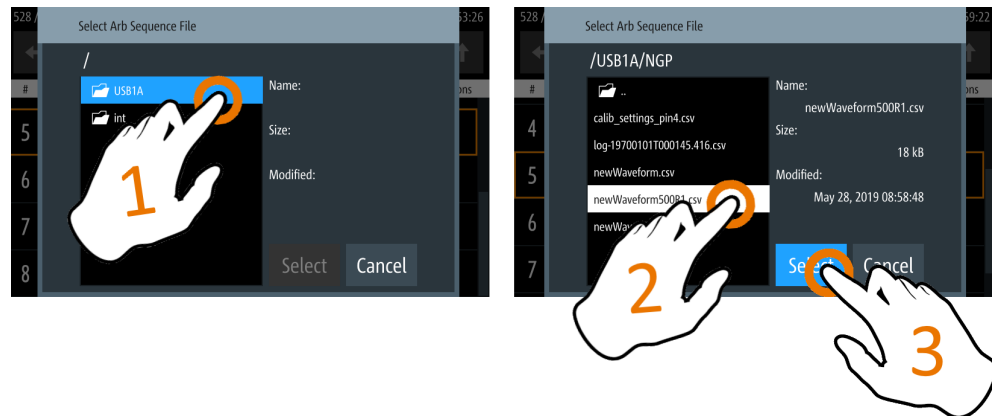

Figure 5-25: Select an arbitrary file location

4. Select delete and up/down softkey, to navigate the arbitrary test sequence.
5. Select "Load Sequence" to load the arbitrary test sequence.
6. Set "Seq. Rep." and "End Behavior" to configure the arbitrary sequence behavior.
7. Select "Back" softkey > "Arbitrary" to "ON".

The R&S NGP800 enables the arbitrary function and displays the arbitrary icon on the selected channel status bar information.

Arbitrary editor



The "Arb Editor" dialog allows you to edit the arbitrary profile of a test sequence.



Figure 5-26: Arbitrary editor dialog

To configure the arbitrary editor

1. To view or open the list of available arbitrary files, select to open the arbitrary file.
2. Configure the "Arb Editor" with the required voltage, current and duration.
The R&S NGP800 displays the on-screen keyboard for data entry.
3. Confirm values with the unit softkey (V/mV or A/mA).

4. Select the interpolation checkbox to toggle on/off the interpolation function on the arbitrary data.
5. Select **+** or **-** icon to add or delete the arbitrary data from the dialog.
6. Set the "Rep." to configure the repetition cycle for the arbitrary data. By default, the repetition cycle is set to infinity.
7. Set the "End Behavior" to handle the way to end the automation of the arbitrary function.
8. Select  (existing file) or  (new file) to save the arbitrary data. The R&S NGP800 displays a popup message to show that the file saved successfully.

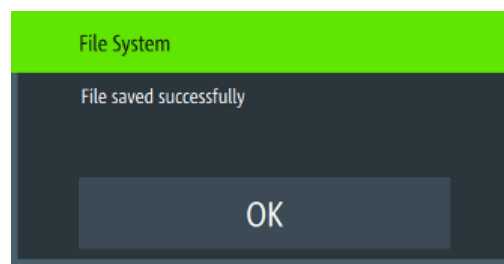





Figure 5-27: File system message

Settings

Back.....	97
Seq. Rep.....	97
End Behavior.....	97
Load Sequence.....	97
Delete, 	97
Up / Down, 	97
<Arbitrary test sequence>.....	97
L #.....	97
L File.....	98
L Data Points.....	98
L Repetitions.....	98
Arbitrary editor.....	98
L Back.....	98
L Open folder.....	98
L Save / Save as.....	98
L Rep.....	98
L End Behav.....	98
L +, 	98
L -, 	99
L <Arbitrary data points>.....	99
L #.....	99
L Voltage.....	99

L	Current	99
L	Time	99
L	Interpolate	99

Back

Returns to the previous menu.

Remote command:

n.a.

Seq. Rep.

Sets the number of times the waveform is output in the arbitrary table. If "Seq. Rep." is set to infinity, the waveform is output continuously.

Remote command:

[ARbitrary:SEquence:REPetitions](#) on page 225

End Behavior

Sets end behavior of the automation of the arbitrary function.

"Off" Output of the selected channel is turned off after performing the arbitrary function.

"Hold" Last voltage and current values output at the instrument.

Remote command:

[ARbitrary:SEquence:BEHavior:END](#) on page 224

Load Sequence

Loads the selected arbitrary file into the arbitrary test sequence.

Remote command:

[ARbitrary:SEquence:TRANsfer](#) on page 225

Delete, 

Delete the selected arbitrary file from the arbitrary test sequence.

Remote command:

[ARbitrary:BLOCK:CLEar](#) on page 220

[ARbitrary:SEquence:CLEar](#) on page 225

Up / Down, 

Navigates up and down the rows in the arbitrary test sequence.

Remote command:

n.a.

<Arbitrary test sequence>

Displays the list of loaded arbitrary files in the arbitrary test sequence.

← <Arbitrary test sequence>

Index numbering of the block in an arbitrary test sequence.

Remote command:

[ARbitrary:BLOCK](#) on page 220

File ← <Arbitrary test sequence>

File directory of the loaded arbitrary file.

Remote command:

[ARbitrary:BLOCK:FNAME](#) on page 221

Data Points ← <Arbitrary test sequence>

Number of data points in an arbitrary file.

Remote command:

n.a.

Repetitions ← <Arbitrary test sequence>

Repetition cycle of the arbitrary file.

Remote command:

[ARbitrary:BLOCK:REPetitions](#) on page 221

Arbitrary editor

Configures the arbitrary points in the loaded arbitrary file.

Back ← **Arbitrary editor**

Returns to the previous menu.

Remote command:

n.a.

Open folder ← **Arbitrary editor**

Opens an arbitrary file.

Remote command:

[ARbitrary:LOAD](#) on page 223

[ARbitrary:FNAME](#) on page 223

Save / Save as ← **Arbitrary editor**

Saves the arbitrary data.

Remote command:

[ARbitrary:SAVE](#) on page 224

Rep. ← **Arbitrary editor**

Configures the repetition cycle for the loaded arbitrary file.

By default, the repetition cycle is set to infinity.

Remote command:

[ARbitrary:REPetitions](#) on page 224

End Behav. ← **Arbitrary editor**

See details in "[End Behavior](#)" on page 97.

+, + ← **Arbitrary editor**

Adds a new row of data points at the end of the table. It is initially filled with the data of the currently selected row.

Remote command:

[ARbitrary:DATA](#) on page 222

-,  ← Arbitrary editor

Removes the currently selected data point from the table.

Remote command:

[ARbitrary:DATA](#) on page 222

<Arbitrary data points> ← Arbitrary editor

Displays the arbitrary data points of the loaded arbitrary file.

← <Arbitrary data points> ← Arbitrary editor

Index numbering of the arbitrary data point in the loaded arbitrary file.

Remote command:

[ARbitrary:DATA](#) on page 222

Voltage ← <Arbitrary data points> ← Arbitrary editor

Data points for voltage in the loaded arbitrary file.

Remote command:

[ARbitrary:DATA](#) on page 222

Current ← <Arbitrary data points> ← Arbitrary editor

Data points for current in the loaded arbitrary file.

Remote command:

[ARbitrary:DATA](#) on page 222

Time ← <Arbitrary data points> ← Arbitrary editor

Duration of the selected data point in the loaded arbitrary file.

Remote command:

[ARbitrary:DATA](#) on page 222

Interpolate ← <Arbitrary data points> ← Arbitrary editor

Checkbox to enable or disable interpolation for the selected data point.

Remote command:

[ARbitrary:DATA](#) on page 222

5.10.2 EasyRamp



The ramp function configures a constant rise of supply voltage within a set timeframe. The output voltage can be increased continuously within a range of 10 ms to 10 s with a step size of 1 ms. Each channel has an independent ramp configuration. See [Figure 5-28](#).

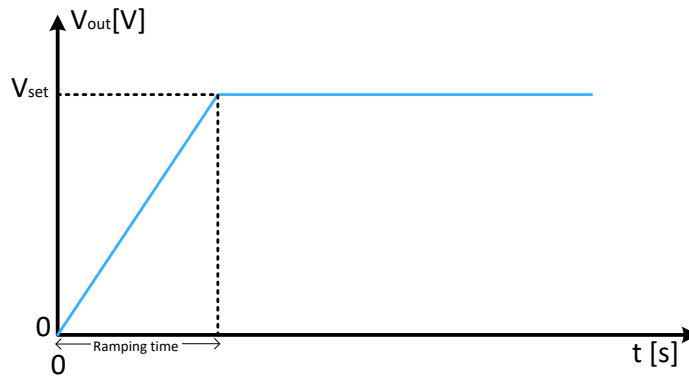

Figure 5-28: Ramping voltage output

Access:

- ▶ Select [Settings] > channel tab > "Ramp" to configure the ramp function. The R&S NGP800 displays the "Ramp" dialog.

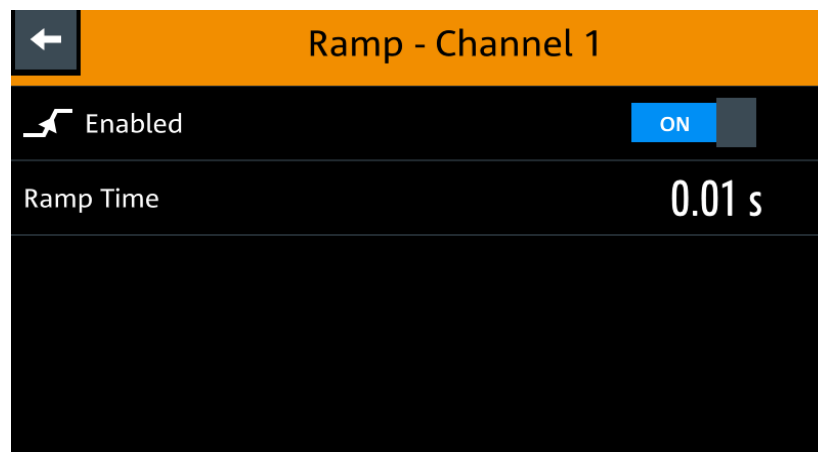

Figure 5-29: Ramp dialog

To configure the ramp function

1. Set "Enabled" to "ON" to configure the ramp function. The R&S NGP800 enables the ramp function and displays the ramp icon on the selected channel status bar information.
2. Set the required "Ramp Time". The R&S NGP800 displays the on-screen keyboard to set the value.
3. Confirm the value with the unit softkey (ms or s).

Settings

Enable	101
Ramp Time	101

Enable

Activates or deactivates the ramp function.

"ON" Ramp function is activated.

"OFF" Ramp function is deactivated.

Remote command:

[\[SOURce:\]VOLTage:RAMP\[:STATe\]](#) on page 227

Ramp Time

Sets the ramp time.

Remote command:

[\[SOURce:\]VOLTage:RAMP:DURation](#) on page 227

5.11 Graphical view window



The graphical view measurement is a time-based measurement that allows you to visualize measurements on available data sources.

The graph illustrated below shows the output of voltage "U1" 4.0 V, current "I1" 600 mA at channel 1 with output power of "P1" 2395 mW from 42.5 seconds ago. Each measurement trace is represented with an individual color.

The time-based scale is adjustable with a time duration display from 60 seconds up to the last 12 hours.

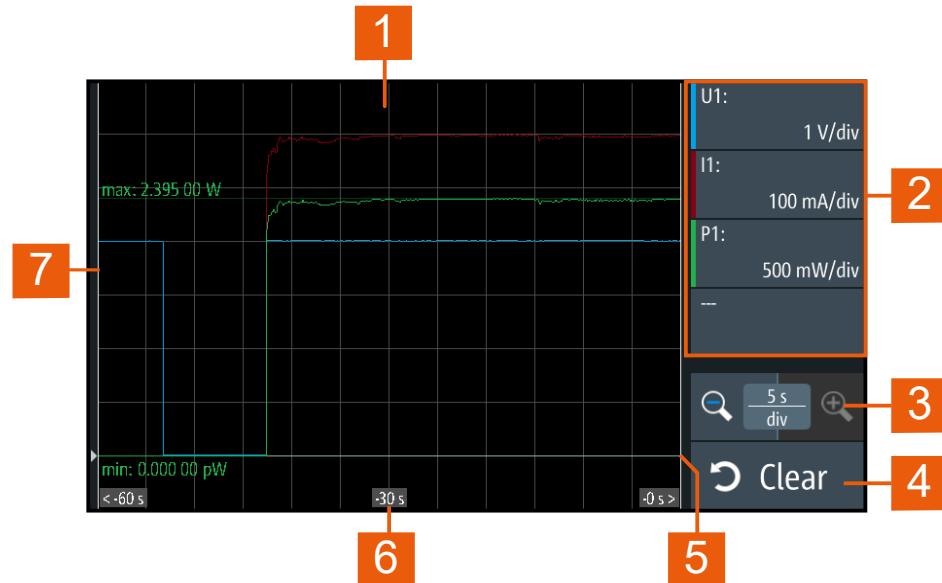

Figure 5-30: Graphical view window

- 1 = Display window for measurement
- 2 = Configuration slot for measurement
- 3 = Adjustable time scale using the "+" and "-" icon
- 4 = Reset measurements in display window
- 5 = Zero-origin of the graph
- 6 = Time axis
- 7 = Measurement axis

Access:

1. Long-press the [Settings] key or the "Settings" button in "Channel display area" on page 40.
The R&S NGP800 displays the graphical view window. See [Figure 5-30](#).
2. Alternatively, select [Settings] > "Device" tab > "Graphical View" to access the graphical view window.
See [Figure 5-30](#).

To configure the graphical view

1. Select any of the [configuration slots \(2\)](#) to configure the measurement parameters.
The R&S NGP800 displays the configuration dialog.

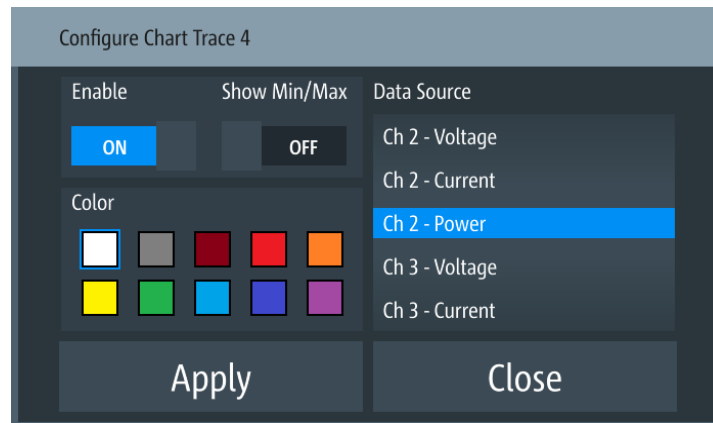

Figure 5-31: Configuration dialog

2. Select the available "Data Source" for configuration.
3. Set "Enable" to "ON" to activate the selected "Data Source" for measurement.
4. Select the available "Color" to configure the "Data Source" measurement trace.
5. Set "Show Min/Max" to "ON" to display the minimum and maximum value of the selected "Data Source".

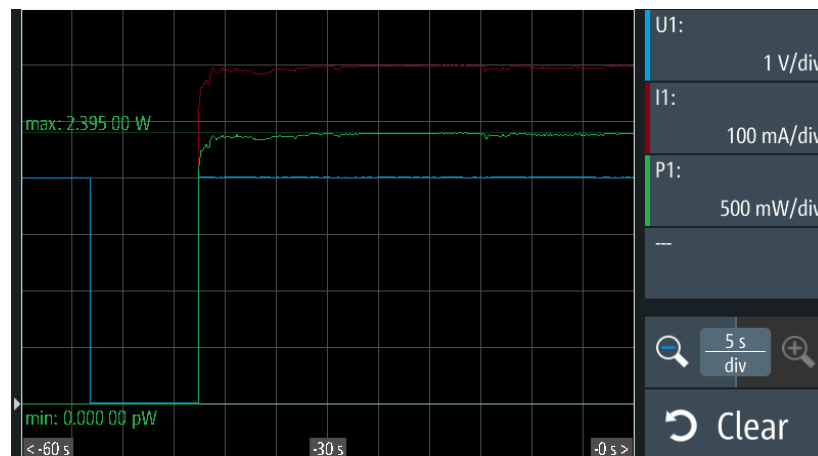

Figure 5-32: Display of minimum and maximum value of selected data source

6. Select "Apply" to confirm the configuration.
7. Select "Close" to exit the configuration dialog.

Settings

Enable.....	104
Show Min/Max.....	104
Color.....	104
Data Source.....	104
Apply.....	104
L Configuration slot.....	104

L Time scale.....	104
L Clear.....	104
Close.....	104

Enable

Activates or deactivates the selected "Data Source" for measurement.

"ON" Activates the selected "Data Source".

"OFF" Deactivates the selected "Data Source".

Show Min/Max

Enables displaying the minimum and maximum value of the selected "Data Source".

"ON" Displays the minimum and maximum value of the selected "Data Source".

"OFF" Hide the minimum and maximum value of the selected "Data Source".

Color

Configures the color of the measurement trace.

Data Source

Selects the data source for measurement.

Apply

Sets the configuration.

Configuration slot ← Apply

Configures the selected data source.

Time scale ← Apply

Configures the time scale on the time axis.

 + Increases the time scale per division.

 - Reduces the time scale per division.

Clear ← Apply

Resets the display to start a new measurement.

Close

Closes the configuration window.

5.12 Adjustment



Adjustment is done at ambient temperature of $25\text{ °C} \pm 2\text{ °C}$.

The instrument must be operated for at least 30 minutes before executing the adjustment.

Thick wires are recommended for connecting the shunt resistor to avoid huge voltage drops and excessive heating.

Adjustments must be performed using only calibrated instruments that are recommended, see ["Analog input adjustment setup"](#) on page 105 and ["Channel adjustment setup"](#) on page 109.

For ease of maintenance, the R&S NGP800 provides the following adjustment procedures which you can apply on the instrument:

- [Section 5.12.1, "Analog In adjustment"](#), on page 105
- [Section 5.12.2, "Channel adjustment"](#), on page 109

5.12.1 Analog In adjustment

The "Analog In Adjustment" adjusts the output channel voltage and current when a 0 V to 5 V is applied at the analog input of the terminal block, see ["Digital I/O & analog input connector \(14\)"](#) on page 30.

Depending on the instrument models, up to four analog input pins are adjusted independently.

Table 5-3: Output channel voltage, current for different instrument models

Models	Output channel voltage with 0 V to 5 V applied to analog input pins (ANA IN1, ANA IN2, ANA IN3, ANA IN4)
NGP802, NGP804, NGP814 (Ch 1, Ch 2)	0 V to 32 V, 0A - 20A
NGP822, NGP824, NGP814 (Ch 3, Ch 4)	0 V to 64 V, 0A - 10A

Analog input adjustment setup

Recommended instruments:

- Digital multimeter (DMM): 6 ½ digits.
- External DC power supply: 1 mV resolution, 0.05 % accuracy with < 500 uVrms ripple.

Connect the external DC power supply to the [analog input channel](#) (e.g. ANA_IN1) with respect to the analog ground (AND_GND). Monitor the voltage using a digital multimeter.

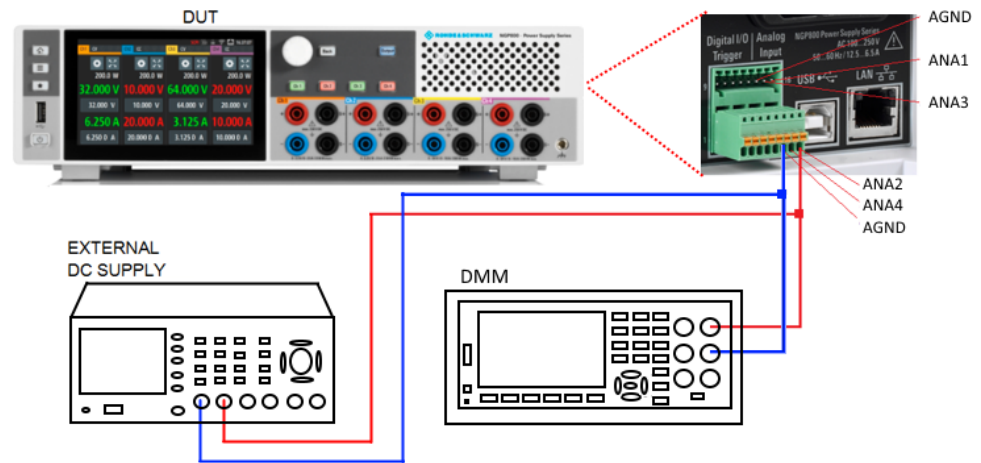

Figure 5-33: Analog input adjustment setup

Access:

- ▶ Select [Settings] > "Device" tab > "Adjustment - Analog In" to perform the analog input adjustment.

The R&S NGP800 displays the selected "Adjustment - Analog In" dialog.

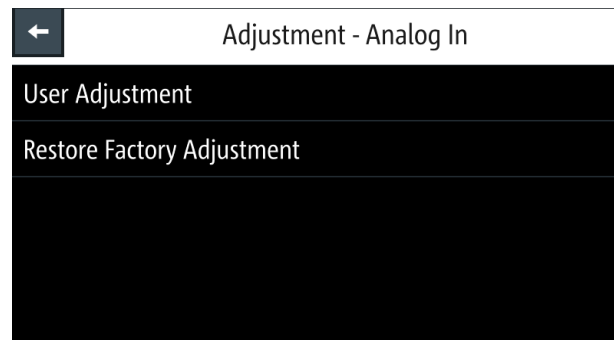

Figure 5-34: Adjustment - Analog In dialog

To perform analog input adjustment

1. To overwrite user adjustment, select "Restore Factory Adjustment" to restore the analog input adjustment factory settings.

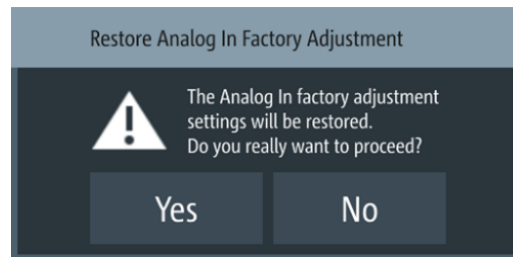

Figure 5-35: Restore Analog In factory adjustment message

Select "Yes" to restore factory adjustment.

- To proceed analog input adjustment, select "User Adjustment" in [Figure 5-34](#). The R&S NGP800 displays the "ANALOG IN ADJUSTMENT" wizard to guide the adjustment procedures.

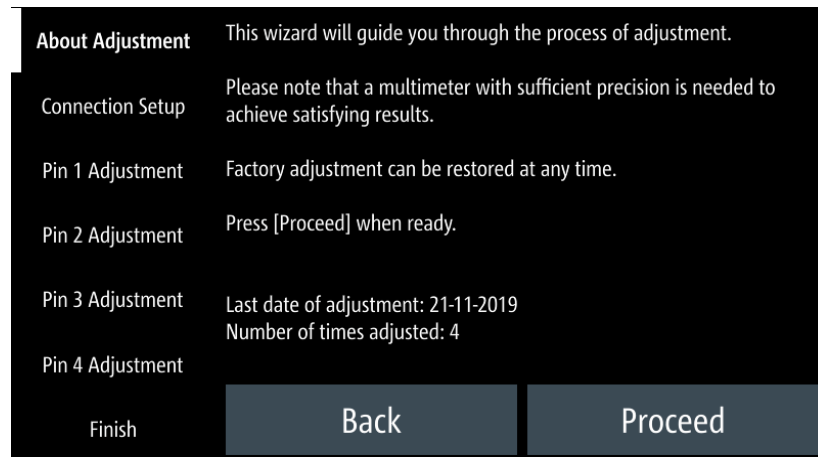

Figure 5-36: Analog In adjustment wizard

- Set up the adjustment with instruments illustrated in [Figure 5-33](#).
- Follow the on-screen instructions displayed in [Figure 5-36](#). Supply the required voltage to the analog input and key in the measured value from DMM using the on-screen keyboard. See [Figure 5-37](#).

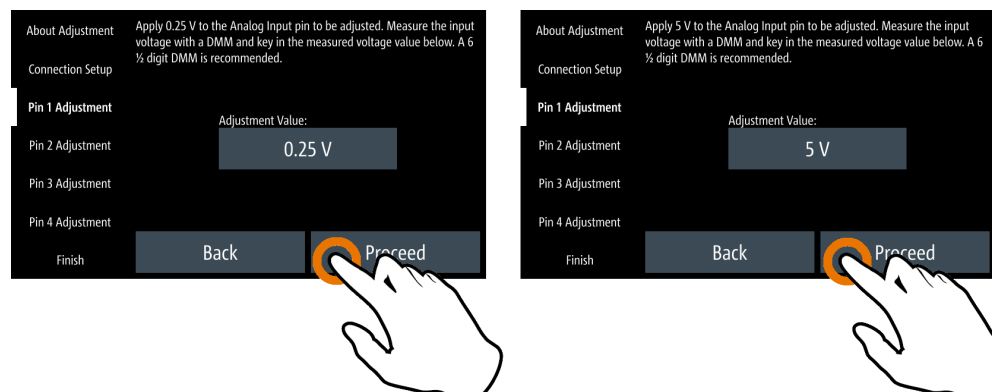



Figure 5-37: Analog In adjustment procedure

5. Confirm the entry with .
6. Leave the setup connection as open.
Select  to start the adjustment automatically.
7. If the adjustment is successful, the R&S NGP800 displays a message to indicate that the adjustment is successful.
The R&S NGP800 overwrites the last analog input adjustment.

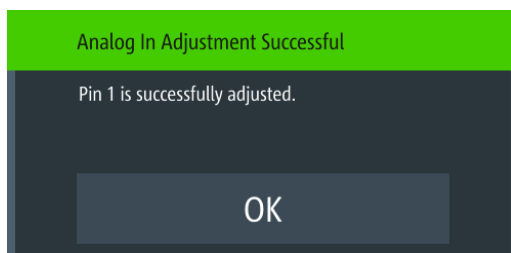

Figure 5-38: Analog In adjustment successful message

8. If adjustment failed after repeated tries, contact your local service partner for support.

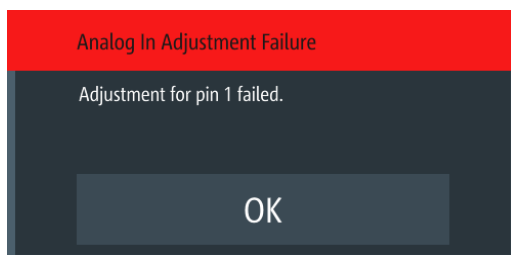

Figure 5-39: Analog In adjustment failure message

Settings

User Adjustment	108
Restore Factory Adjustment	109

User Adjustment

Activates user-defined adjustment.

Remote command:

CALibration:AINPut:DATA	on page 230
CALibration:AINPut:START	on page 231
CALibration:AINPut:COUNT?	on page 230
CALibration:AINPut:SAVE	on page 231
CALibration:AINPut:STATe?	on page 231
CALibration:AINPut:UMAX	on page 232
CALibration:AINPut:UMIN	on page 232
CALibration:AINPut:CANCel	on page 230
CALibration:AINPut:END	on page 231

Restore Factory Adjustment

Restores the analog input adjustment factory settings.

Remote command:

[CALibration:AINPut:FACTory:REStore](#) on page 231

5.12.2 Channel adjustment

The "Adjustment" calculates the required adjustment coefficient internally for voltage and current on the selected channel.

Channel adjustment setup

Recommended instruments:

- Digital multimeter (DMM): 6 ½ digits.
- Shunt resistor: 10 mΩ, at least 25 A rating and 0.02 % accuracy.
- Connect the DMM to the instrument and monitor the measured voltage or current. See [Figure 5-40](#) and [Figure 5-41](#).

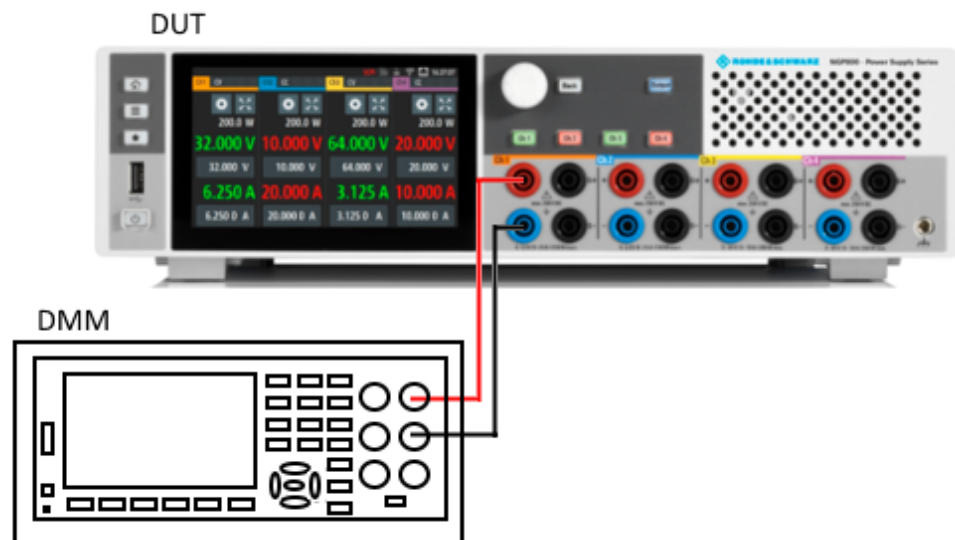

Figure 5-40: Voltage adjustment setup

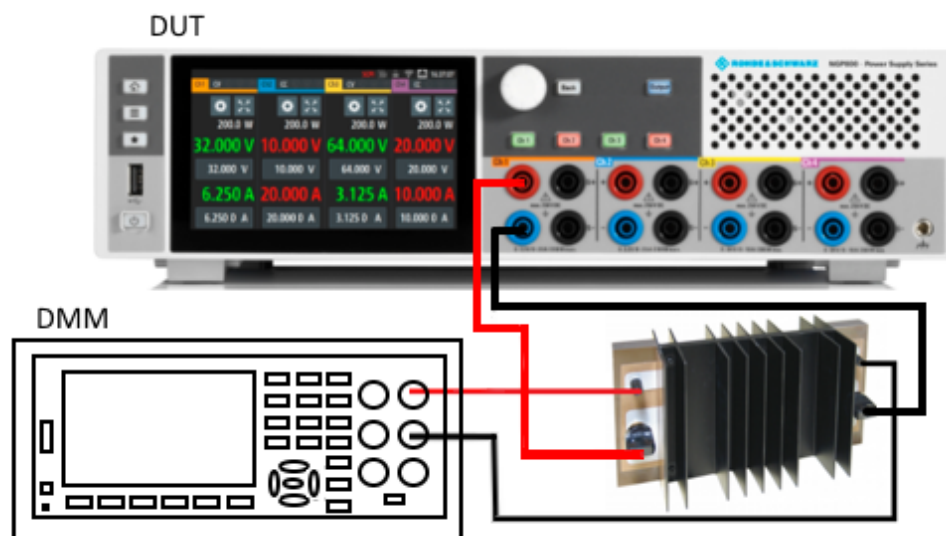

Figure 5-41: Current adjustment setup

Access:

- ▶ Select [Settings] > channel tab > "Adjustment" to perform the channel adjustment. The R&S NGP800 displays the selected channel adjustment dialog.



Figure 5-42: Adjustment dialog

To perform channel adjustment

1. Select "User Adjustment" to perform channel adjustment. The R&S NGP800 displays the "ADJUSTMENT" wizard to guide the channel adjustment procedures.

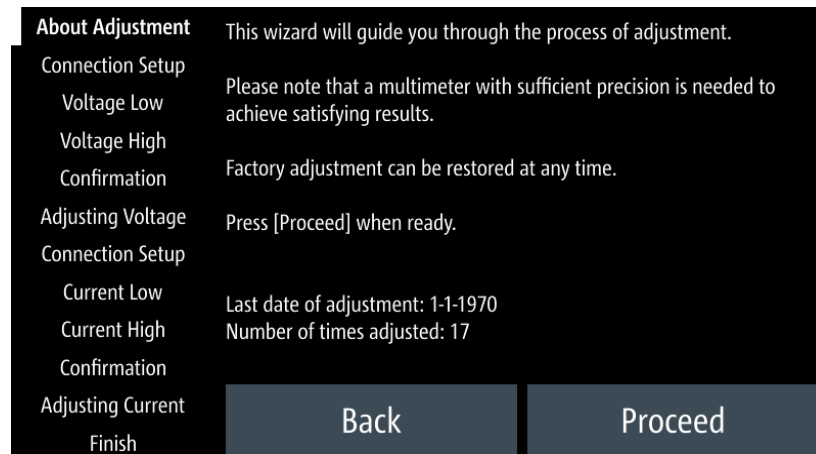

Figure 5-43: Channel adjustment wizard

2. Select "Yes" to continue the channel adjustment procedures. Select "No" to return to the channel adjustment wizard, see [Figure 5-43](#).
3. Depending on the types of adjustment (voltage or current), set up the instruments illustrated in [Figure 5-40](#) or [Figure 5-41](#).
4. Follow the on-screen instructions displayed in the [Figure 5-43](#). The R&S NGP800 applies a low voltage/current followed by a high voltage/current for voltage/current adjustment. Key in the measured value from DMM using the on-screen keyboard. See [Figure 5-44](#).

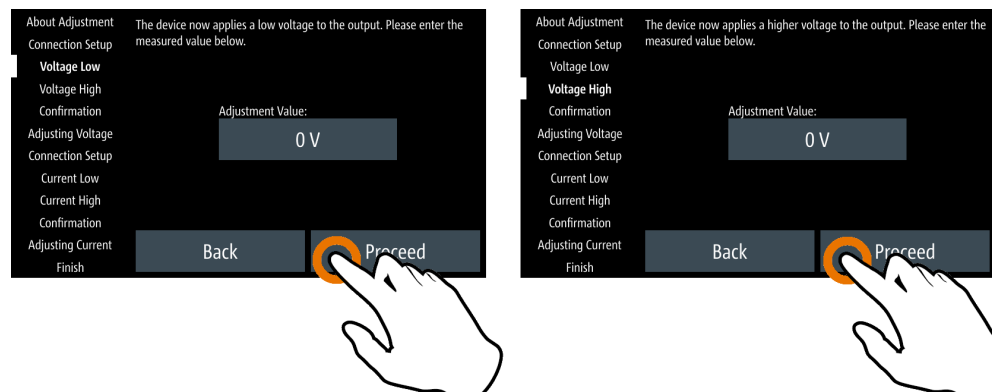

Figure 5-44: Channel adjustment procedure

5. Confirm the entry with .
6. Leave the setup connections as open. Select to start the voltage adjustment automatically.
7. Follow the on-screen instructions for current adjustment.
8. If the adjustment is successful, the R&S NGP800 displays a message to indicate that the adjustment is successful. The R&S NGP800 overwrites the last channel adjustment.

- If the adjustment fails after repeated tries, contact your local service partner for support.

To restore factory adjustment

- Select "Restore Factory Adjustment" to restore the channel factory adjustment settings.
The R&S NGP800 displays the "Restore Channel Factory Adjustment" dialog.

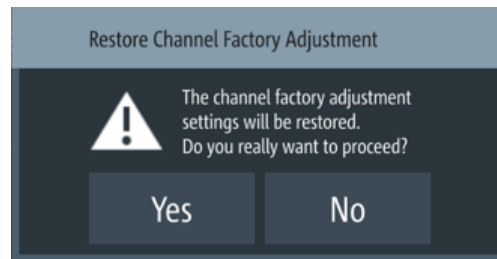

Figure 5-45: Restore channel factory adjustment dialog

- Select "Yes" to restore factory adjustment.
The R&S NGP800 restores the channel factory adjustment settings.

Settings

User Adjustment.....	112
Restore Factory Adjustment.....	112

User Adjustment

Activates user-defined adjustment.

Remote command:

[CALibration:USER](#) on page 234
[CALibration:STATE?](#) on page 234
[CALibration:CURREnt:DATA](#) on page 232
[CALibration:VOLTage:DATA](#) on page 234
[CALibration:VOLTage:UMIN](#) on page 235
[CALibration:VOLTage:UMAX](#) on page 235
[CALibration:CURREnt:IMAX](#) on page 233
[CALibration:CURREnt:IMIN](#) on page 233
[CALibration:SAVE](#) on page 233
[CALibration:CANCel](#) on page 232
[CALibration:COUNT?](#) on page 232
[CALibration:DATE?](#) on page 233
[CALibration:END](#) on page 233

Restore Factory Adjustment

Restores the factory channel adjustment.

Remote command:

[CALibration:FACTory:RESTore](#) on page 233

6 File and data management

The R&S NGP800 enables you to save instrument configurations, settings and screenshots of the current screen. Depending on the type of data, you can use the internal memory or save the data to an external USB memory device.

Type of data files

Data files include measurement configurations and records, screenshots and instrument settings.

Depending on the content, user data is roughly categorized in the following data types:

- *Settings*: instrument settings of a measurement configuration saved and recalled for later reuse, see [Section 3.3.4, "Saving/Recalling of instrument settings"](#), on page 34.
- *Measurement readings*: recorded measurement results saved for evaluation, see [Section 5.9, "Measurement function"](#), on page 87.
- *Screenshots*: screen captures of settings or measurement mode windows, see [Section 6.4, "Screenshot"](#), on page 120.
- *Device documentation*: open source acknowledgment of the device documentation, see [Section 6.5, "Device documentation"](#), on page 121.

File memory location

The R&S NGP800 saves user files on internal memory or, if connected, on a USB flash drive. With the "File Manager" functions, you can exchange files between the internal and external memory, provided you have connected a USB flash drive.

The memory locations on the internal memory are predefined, on an external USB flash drive, you can create, define or delete directories as known from common file explorers.

6.1 Accessing, retrieving and handling data

Depending on the origin and content, this description distinguishes between the following data types:

- Operational data
- Non-operational data

Operational data (data for intended use)

Your instrument uses and creates this data because of its intended use and according to the settings and configuration you have made. Thus, this data makes up most of the data that the R&S NGP800 creates, such as user files that contain user-defined configurations or data, like instrument settings or measurement data.

The R&S NGP800 saves this data in the configuration file, see [Section 6.3, "Save and recall"](#), on page 116.

Non-operational data (usage data)

The R&S NGP800 does not generate non-operational data during and through its use.

6.2 File manager



The "File Manager" provides file transfer functions between the USB flash drive and the internal memory of the instrument. You can copy and delete files in both the USB flash drive and internal memory of the instrument.

Access:

- ▶ Select [Settings] > "Device" tab > "File Manager" to access the file manager function.

The R&S NGP800 displays the file manager dialog.

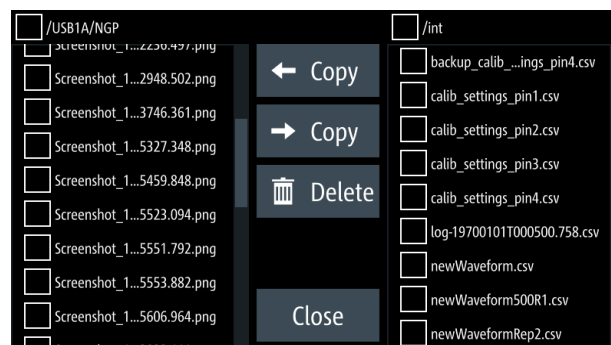

Figure 6-1: File manager dialog

To manage files

1. Select the file that you want to copy or delete.
2. Select the required action in the file manager dialog.
3. To view the selected file information, long-press the selected filename in the file manager dialog.

A pop-up message box displays the selected file information.

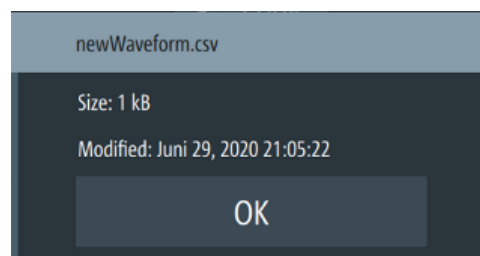

Figure 6-2: File information

Settings

<USB_directory>.....	115
<Internal_memory>.....	115
Int to USB copy, 	115
USB to Int copy, 	115
Delete, 	115
Close.....	115

<USB_directory>

Lists all the files available in the USB flash drive for file operations. Selected files are marked in the checkbox.

Remote command:

n.a.

<Internal_memory>

Lists all the files available in the internal memory for file operations. Selected files are marked in the checkbox.

Remote command:

n.a.

Int to USB copy, 

Copies from internal memory to USB.

Remote command:

n.a.

USB to Int copy, 

Copies from USB to internal memory.

Remote command:

n.a.

Delete, 

Deletes the selected file.

Remote command:

[DATA:DELeTe](#) on page 236

Close

Closes the file manager dialog, .

Remote command:

n.a.

6.3 Save and recall



Upon power-up, the instrument loads the last saved settings from an internal memory location. Auto saved parameters are also applied during startup.

The R&S NGP800 output states of all channels are disabled when the recall function is activated.



In the event of external power loss, the R&S NGP800 powers up with the auto saved instrument settings in the next power cycle. See ["Auto saved instrument settings"](#) on page 116.



Auto saved instrument settings

Auto saved of the instrument settings is applied when any of the following parameters are changed:

- [Section 7, "General instrument functions"](#), on page 122
- USB connection mode
- Ethernet settings



Instrument settings

In addition to the auto saved instrument settings, the following instrument settings are saved or recalled in internal memory:

- [Set voltage and current level](#)
- [Settings in the protection function, safety limits](#)
- [Data logging settings](#)

Access:

- ▶ Select [Settings] > "Device" tab > "Save/Recall Device Settings" to configure the save and recall functions.

The R&S NGP800 loads the "Save/Recall Device Settings" dialog.

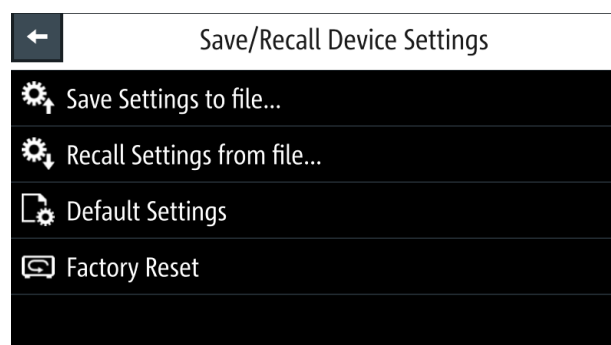

Figure 6-3: Save/Recall device settings dialog

To save and recall instrument settings

1. Select "Save Settings to file..." to save current instrument settings.
The R&S NGP800 opens a dialog to select the file location.
You can save to existing file or create a file for saving.

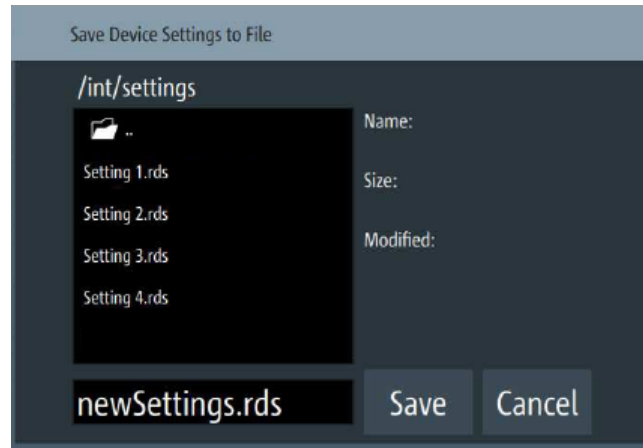

Figure 6-4: Save device settings to file dialog

2. Set the desired file location and filename.
3. Confirm the selection by using the "Save" softkey.
The R&S NGP800 saves the current instrument settings.
4. Similar, you can select "Recall Settings from file..." to load instrument settings.
The R&S NGP800 opens a dialog to select the file location.

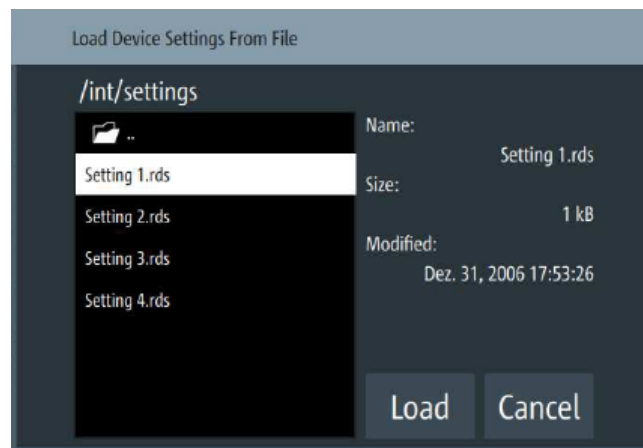

Figure 6-5: Load device settings from file dialog

5. Set the desired file location.
6. Confirm the selection using "Load" to load the instrument settings.
The R&S NGP800 resets the instrument with the loaded instrument settings.

To reset the instrument to default settings

1. Select "Default Settings" from the "Save/Recall Device Settings" dialog.
The R&S NGP800 displays a popup message.

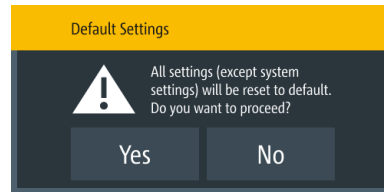

Figure 6-6: Default settings warning message

2. Select "Yes" to overwrite instrument settings to default.
The R&S NGP800 resets current instrument settings to default.
3. The R&S NGP800 displays a popup message to show that all settings reset to default.

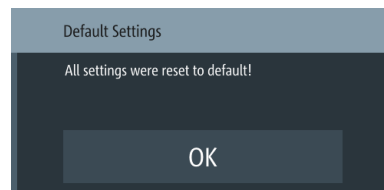

Figure 6-7: Default settings completion message

To reset the instrument to factory settings

1. To proceed to reset instrument settings to factory settings with a reboot, select "Factory Reset" from the "Save/Recall Device Settings" dialog.

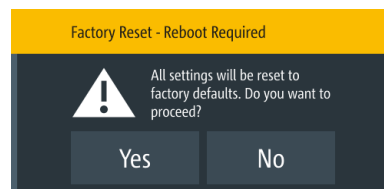

Figure 6-8: Factory reset - reboot message

2. Select "Yes" to proceed factory reset.

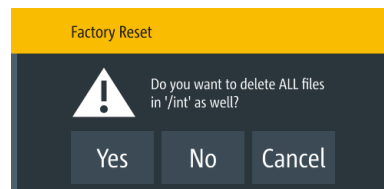

Figure 6-9: Factory reset - all files delete message

3. Select "No" to keep all files in the `/int` directory.

Select "Yes" to remove all files (arbitrary, logging, screenshots, settings) except the files in the documentation folder under the `/int` directory.

Settings

Save Settings to file.....	119
L Save Device Settings To File.....	119
L Save.....	119
L Cancel.....	119
Recall Settings from file.....	119
L Load Device Settings From File.....	119
L Load.....	119
L Cancel.....	119
Default Settings.....	119
Factory Reset.....	120

Save Settings to file

Saves current instrument settings.

Remote command:

*[SAV](#) on page 168

Save Device Settings To File ← Save Settings to file

File manager dialog to save instrument settings.

Save ← Save Device Settings To File ← Save Settings to file

Saves the current instrument settings to selected location and filename.

Cancel ← Save Device Settings To File ← Save Settings to file

Cancels the saving of instrument settings.

Recall Settings from file

Loads instrument settings.

Remote command:

*[RCL](#) on page 168

Load Device Settings From File ← Recall Settings from file

File manager dialog to load instrument settings.

Load ← Load Device Settings From File ← Recall Settings from file

Loads the instrument settings from the selected location and filename.

Cancel ← Load Device Settings From File ← Recall Settings from file

Cancels the loading of instrument settings.

Default Settings

Overwrites instrument settings to default.

Remote command:

*[RST](#) on page 166

Factory Reset

Resets instrument to factory settings, with a reboot.

Remote command:

n.a.

6.4 Screenshot



With screenshot, you can capture image easily from the instrument. The images can be stored in the USB flash drive or internal memory of the instrument. By default, screen images are stored on the USB device if a USB flash drive is detected.

Access:

- ▶ Select [Settings] > "Device" tab > "Screenshot" to configure screenshot file location.

The R&S NGP800 displays the "Screenshot" dialog.

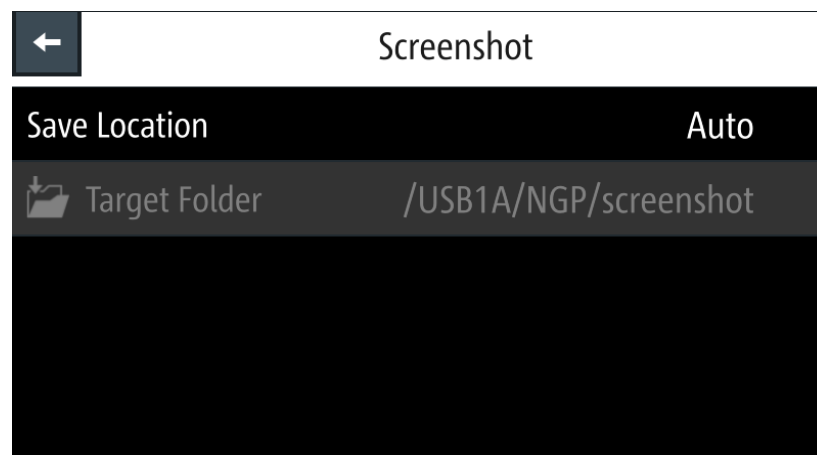

Figure 6-10: Screenshot dialog

To save a screenshot

1. Select "Save Location" to configure the screenshot save partition.
See details in ["Save Location"](#) on page 120.
2. Select the required save location.

Settings

Save Location	120
Target Folder	121

Save Location

Sets the saved location for the screenshot.

See also ["Target Folder"](#) on page 121.

Auto "Target Folder" is auto-selected.
If no USB flash drive is detected, "Target Folder" is set to an internal memory ("int") partition. Otherwise, "USB1A" partition is selected.

Manual Choice of "Target Folder".

Remote command:
n.a.

Target Folder

Selects the predefined target folder for the screenshot.

"USB1A" Selects `/USB1A/NGP/screenshot` for R&S NGP800 instrument models.

"int" Selects `/int/screenshot` as the target folder.

Remote command:
n.a.

6.5 Device documentation

You can retrieve the R&S NGP800 open source acknowledgment documentation from the instrument documentation folder: `/int/documentation`.

Access:

- ▶ Select [Settings] > "Device" tab > "File Manager" to access the file manager.
The R&S NGP800 displays the file manager dialog.
See [Section 6.2, "File manager"](#), on page 114.

1. Select the documentation folder in the file manager dialog.
The R&S NGP800 displays the available files in the documentation folder.
2. Select the file that you want to copy from the documentation folder.

Settings

For details, see ["Settings"](#) on page 115.

7 General instrument functions

The following sections provide the general instrument information and utilities services in R&S NGP800, regardless of the selected operating mode and measurement.

7.1 Licenses management

Options are enabled by entering a registered license keycode.

You may choose to install from an XML file on USB or by manually entering the key-code.

For unregistered license keycode, see also the supplement note delivered together with the unregistered keycode.

Access:

- ▶ Select [Settings] > "Device" tab > "Licenses" to install the license keycode. The R&S NGP800 displays the license dialog.



Figure 7-1: License dialog

To install an XML file

1. Copy the XML file containing the registered keycode into the USB flash drive.
2. Connect the USB flash drive to the USB port of the instrument.
3. Select "Load File" to load the license file from the USB flash drive.
4. Select the license file to install in the instrument.
The R&S NGP800 install the license option accordingly.
If the installation is successful, the option is displayed in the "Active" window.

To enter the keycode manually

1. Select "Add" softkey to invoke the license key on-screen keyboard.

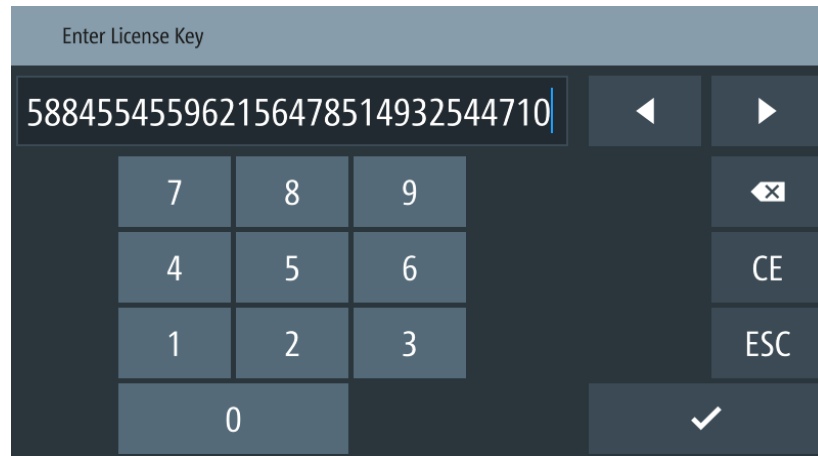



Figure 7-2: License key on-screen keyboard

2. Enter the keycode (30-digit number) of the option in the entry box.
3. Confirm entries with the "Enter" softkey, .

If the correct keycode is entered, the R&S NGP800 displays a message "Device-key is installed" and the option is displayed in the "Active" window.
4. To remove the option, select "Remove" from the license dialog.

The R&S NGP800 displays the license key on-screen keyboard. See [Figure 7-2](#).
5. Enter the keycode (30-digit number) of the option in the entry box.
6. Confirm entries with the "Enter" softkey, .

If the correct keycode is entered, the R&S NGP800 displays a message "Device-key is removed" and the option is displayed in the "Deactivation" window.

Settings

Active.....	123
Inactive.....	123
Deactivation.....	124
Add,  Add.....	124
Remove,  Remove.....	124
Load File,  Load File.....	124

Active

Displays options that are currently active in the instrument.

Remote command:

n.a.

Inactive

Displays options that are currently not active in the instrument.

Remote command:
n.a.

Deactivation

Displays options that are exported or removed in the instrument.

Remote command:
n.a.

Add,

Adds new licenses.

Remote command:
n.a.

Remove,

Removes existing licenses.

Remote command:
n.a.

Load File,

Loads license file from a USB flash drive.

Remote command:
n.a.

7.2 Appearance settings



Access:

- ▶ Select [Settings] > "Device" tab > "Appearance" to set the display and key brightness.

The R&S NGP800 displays the appearance dialog.



Figure 7-3: Appearance dialog

To configure display and key brightness

1. Select "Display Brightness" or "Key Brightness" to set the desired instrument brightness.
The R&S NGP800 displays the "Set Display Brightness" or "Set Key Brightness" dialog.

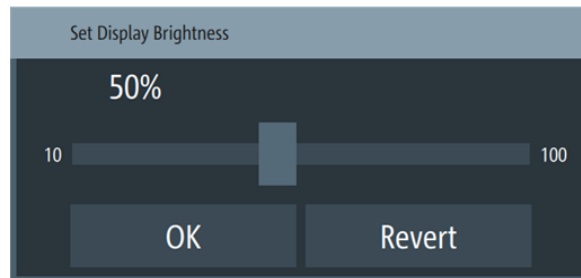

Figure 7-4: Display brightness dialog

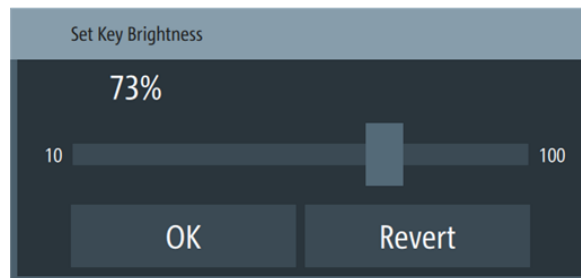

Figure 7-5: Key brightness dialog

2. Drag the indicator along the brightness indicator bar to set the desired brightness.
3. Select "OK" to confirm the setting or "Revert" to undo the changes.

Settings

Display Brightness.....	125
L OK.....	125
L Revert.....	126
Key Brightness.....	126
L OK.....	126
L Revert.....	126

Display Brightness

Sets the display brightness.

Range: 10 % to 100 %

Remote command:

[DISPlay:BRIGhtness](#) on page 176

OK ← Display Brightness

Confirms brightness settings.

Remote command:
n.a.

Revert ← Display Brightness

Undo brightness settings.

Remote command:
n.a.

Key Brightness

Sets the brightness of the keys.

Range: 10 % to 100 %

Remote command:
[SYSTem:KEY:BRIGhtness](#) on page 174

OK ← Key Brightness

Confirms brightness settings.

Remote command:
n.a.

Revert ← Key Brightness

Undo brightness settings.

Remote command:
n.a.

7.3 Sound settings



Access:

- ▶ Select [Settings] > "Device" tab > "Sound Settings" to set sound settings. The R&S NGP800 displays the sound settings dialog.

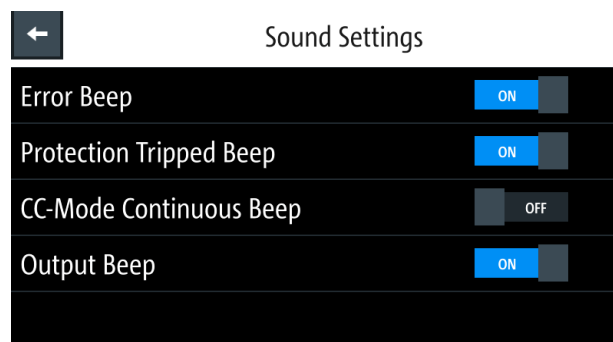

Figure 7-6: Sound settings dialog

- ▶ Select the required fields to set an alert. See details in ["Settings"](#) on page 127.

Settings

Error Beep.....	127
Protection Tripped Beep.....	127
CC-Mode Continuous Beep.....	127
Output Beep.....	127

Error Beep

It sounds a single beep alert when an error occurs.

"ON" Activates the single beep alert.

"OFF" Deactivates the single beep alert.

Remote command:

[SYSTem:BEEPer:WARNing:STATe](#) on page 170

[SYSTem:BEEPer:WARNing\[:IMMediate\]](#) on page 170

Protection Tripped Beep

It sounds a single beep alert when a protection tripped occurs. See [Section 5.5, "Protection"](#), on page 73.

"ON" Activates the single beep alert.

"OFF" Deactivates the single beep alert.

Remote command:

[SYSTem:BEEPer:PROTection:STATe](#) on page 170

[SYSTem:BEEPer:PROTection\[:IMMediate\]](#) on page 170

CC-Mode Continuous Beep

It sounds a continuous beep sound when any channel goes into CC mode. See [Section 4.4.2, "Constant current mode \(CC\)"](#), on page 62.

"ON" Activates the continuous beep alert.

"OFF" Deactivates the continuous beep alert.

Remote command:

[SYSTem:BEEPer:CURRent:STATe](#) on page 169

Output Beep

It sounds a single beep alert when the output state of any channel changes.

"ON" Activates the single beep alert.

"OFF" Deactivates the single beep alert.

Remote command:

[SYSTem:BEEPer:OUTPut:STATe](#) on page 169

7.4 Date and time



The time is regarded as UTC. There is no time zone selectable.



Access:

1. Select [Settings] > "Device" tab > "Date & Time" to set the system date and time. The R&S NGP800 displays the date and time dialog.

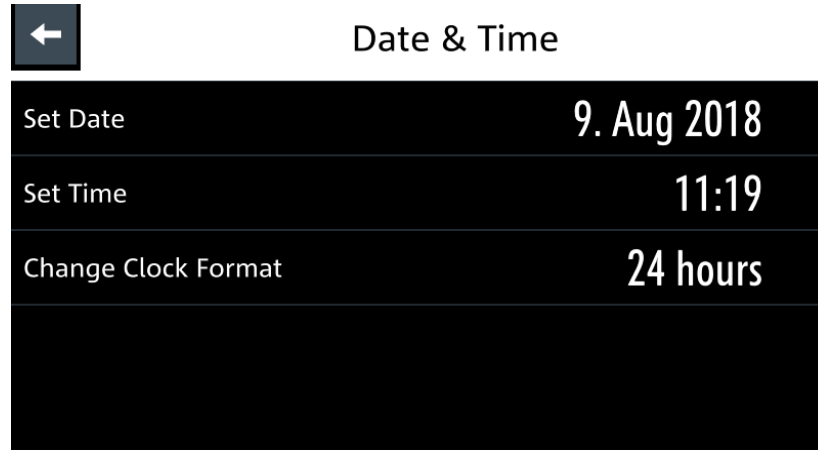

Figure 7-7: Date and time setting dialog

2. Select the required field to configure. The R&S NGP800 reset the instrument date and time accordingly.

Settings

Set Date	128
Set Time	128
Change Clock Format	128

Set Date

Sets the system date.

Remote command:

[SYSTem:DATE](#) on page 173

Set Time

Sets the system time.

Remote command:

[SYSTem:TIME](#) on page 175

Change Clock Format

Switches the clock format between 12 hours and 24 hours.

Remote command:

n.a.

7.5 Device information



The "Device Information" allows you to get an overview of the configuration of your instrument. You can retrieve information on the instrument model, its hardware components and interfaces using the device information function.

7.5.1 Device information settings

Access:

- ▶ Select [Settings] > "Device" tab > "Device Information" to display the device information.

The R&S NGP800 displays the device information dialog.

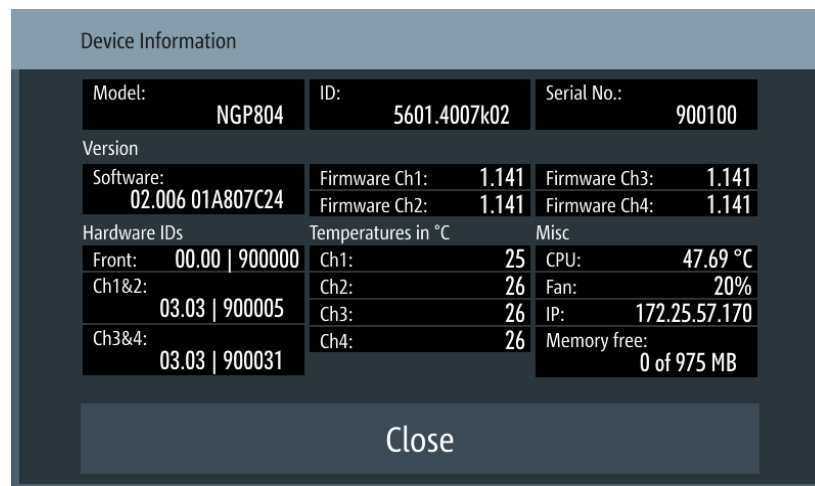

Figure 7-8: Device information dialog

Settings

Device Info.....	129
L Model.....	129
L ID.....	130
L Serial No.....	130
L Version.....	130
L Firmware.....	130
L Hardware IDs.....	130
L Temperatures in °C.....	130
L Misc.....	130

Device Info

Displays device information.

Model ← Device Info

Model of the instrument.

Remote command:
[*IDN?](#) on page 166

ID ← Device Info

Instrument's order number.

Remote command:
[*IDN?](#) on page 166

Serial No. ← Device Info

A unique identification number for the instrument.

Remote command:
[*IDN?](#) on page 166

Version ← Device Info

Software version that is installed in the instrument.

Remote command:
[*IDN?](#) on page 166

Firmware ← Device Info

Currently installed firmware version.

See also [Section 7.6, "Update device"](#), on page 131.

Hardware IDs ← Device Info

A unique serial number of the front and channel boards of the instrument.

Remote command:
n.a.

Temperatures in °C ← Device Info

Temperature in degrees measured in both Ch 1, Ch 2, Ch 3 and Ch 4.

If the temperature exceeded the specification, "Over Temperature Protection" (OTP) is triggered and the respective output channel is turned off.

Remote command:
[CALibration:TEMPerature?](#) on page 234

Misc ← Device Info

Miscellaneous information of the instrument, such as the CPU temperature, instrument IP address, fan speed and memory capacity.

Remote command:
[SYSTem:COMMunicate:SOCKet:IPADdress](#) on page 171
[CALibration:TEMPerature?](#) on page 234

7.6 Update device



Using the USB interface at the front panel, you can update the firmware.

We recommend that you use the latest firmware available on the product page at <http://www.rohde-schwarz.com/product/ngp800>.



Do not power off or operate the instrument during a firmware update.

Required equipment

- Software:
Firmware update file in RSU format.
If the downloaded file is in ZIP format, unpack it to obtain the RSU update file.
Copy the RSU update file to a USB flash drive and connect the USB flash drive to the USB port of the power supply.
- Hardware:
USB flash drive with enough free space to save the update file.
The USB flash drive does not need to be bootable and previous data on the USB flash drive is not affected. During update procedure, the USB flash drive is not modified by the instrument.
The USB flash drive file system supports FAT32 only. See also [Section 3.1.9, "Connecting USB devices"](#), on page 26.

To update the instrument firmware

1. Download the latest version of the R&S NGP800 firmware from the Rohde & Schwarz website. If the downloaded file is in ZIP format, unpack it to obtain the RSU update file.
2. Save the file in the USB flash drive.
3. Connect the USB flash drive to the USB port of the instrument.
4. Select [Settings] > "Device" > "Update Device" to update instrument firmware. The R&S NGP800 displays the update device dialog.

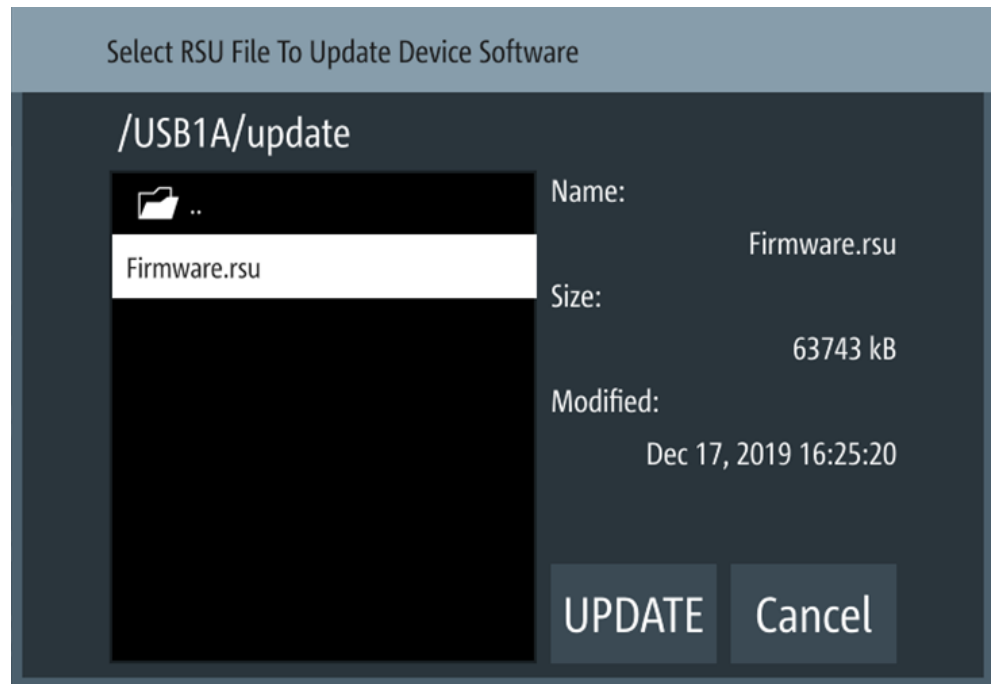

Figure 7-9: Update device dialog

5. Select the file to update the instrument firmware.
6. **NOTICE!** Risk of potential damage to the firmware. Disconnecting the power supply while an update is in progress leads to missing or faulty firmware. Take special care not to disconnect the power supply while the update is in progress. Interrupting the power supply during the firmware update can lead to an unusable instrument that needs to be sent in for maintenance.
Select "UPDATE" to update the instrument firmware.
The R&S NGP800 updates the instrument firmware accordingly.
7. Alternatively, press "Cancel" to cancel the firmware update process.
8. Wait for the completion of the update process.
It takes a few minutes to complete the firmware update process.

Settings

<Firmware_list>.....	132
UPDATE.....	132
Cancel.....	133

<Firmware_list>

Displays all firmware contained in the selected storage location.

UPDATE

Updates the instrument firmware.

Remote command:

n.a.

Cancel

Cancels the instrument firmware update.

Remote command:

n.a.

8 Network operation and remote control

As an alternative to interactive operation directly at the instrument, the R&S NGP800 can also be operated remotely, for example a controller PC.

The interfaces of the R&S NGP800 provide flexible access to the instrument. [Figure 8-1](#) illustrates the physical interface configurations available.



The following descriptions provide information required for operating the R&S NGP800 remotely. The information applies to all applications and operating modes supported by the instrument. Definitions specified in the SCPI standard are not provided.

For basic knowledge on remote control operation and additional information, see the following documents available on the Rohde & Schwarz website:

- [Remote control via SCPI](#)
- [1MA171: How to use Rohde & Schwarz Instruments in MATLAB](#)
- [1SL374: How to communicate with R&S devices using VISA](#)
- [Rohde-Schwarz - Remote control examples](#)

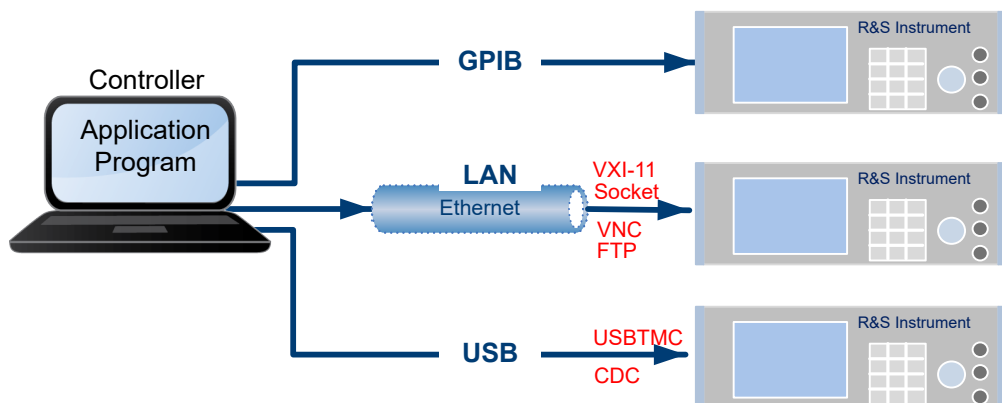

Figure 8-1: Supported remote connections

- [Remote control interfaces and protocols](#)..... 134
- [Setting up remote control connection](#)..... 155
- [Starting and stopping remote control](#)..... 158
- [Status reporting system](#)..... 159

8.1 Remote control interfaces and protocols

The R&S NGP800 comes with the following interfaces for remote control:

- [Ethernet \(LAN\) interface](#)
- [Wireless LAN interface](#)
- [VNC interface](#)
- [FTP interface](#)

- [USB standard interface](#)
- [IEEE-488 bus interface \(GPIB\)](#) (instrument option: R&S NG-B105)

Establish a remote connection between the R&S NGP800 and the controller PC using a supported interface. An application software that supports communication over the used interfaces must be installed on the controller PC. [Table 8-1](#) gives an overview on the connectivity:

Table 8-1: Remote control interfaces and protocols

Interface	Protocols, VISA ¹ address string and library	Remarks
Local area network (LAN / WLAN)	<ul style="list-style-type: none"> • VXI-11 TCP/IP::host address[:: LAN device name][::INSTR] VISA • Socket communication (Raw Ethernet, simple Telnet) TCP/IP::host address[:: LAN device name]::<port>::SOCKET VISA or socket controller 	<p>The LAN connector at the rear panel of the instrument.</p> <p>The interface is based on TCP/IP, see Section 8.1.2, "LAN interface", on page 138 and Section 8.1.3, "Wireless LAN interface", on page 142.</p>
USB	<ul style="list-style-type: none"> • USBTMC USB::<vendor ID>::<product ID>:: <serial number>[::INSTR] VISA • CDC (communications device class, corresponds to VCP (virtual COM port)) 	<p>The USB Type-B connector is at the rear panel of the instrument.</p> <p>For a description of the interface, refer to Section 8.1.6, "USB interface", on page 150.</p>
GPIB (IEC/IEEE Bus Interface) (instrument option: R&S NG-B105)	<ul style="list-style-type: none"> • – GPIB::<address>[::INSTR] (no secondary address) VISA (optional) 	<p>The GPIB bus interface according to standard IEC 625.1/IEEE 488.1 is at the rear panel.</p> <p>For a description of the interface, see Section 8.1.7, "GPIB interface (IEC/IEEE bus interface)", on page 153.</p>

¹ VISA (Virtual Instrument Software Architecture) is a standardized software interface library providing input and output functions to communicate with instruments. A VISA installation on the controller is a prerequisite for remote control over LAN and USB interface. For remote control over socket communication VISA installation is optional. When using socket communication or the GPIB interface (if applicable), VISA installation is optional. For basic information, see [Remote control via SCPI](#).



Rohde & Schwarz provides the standardized I/O software library R&S VISA for download at the Rohde & Schwarz website <http://www.rohde-schwarz.com/rsvisa>.

There are various ways how the R&S NGP800 can be remotely accessed and controlled.

Access:

1. Select [Settings] > "Device" tab > "Interfaces" to configure the required interface. The R&S NGP800 displays the "Interfaces" dialog.

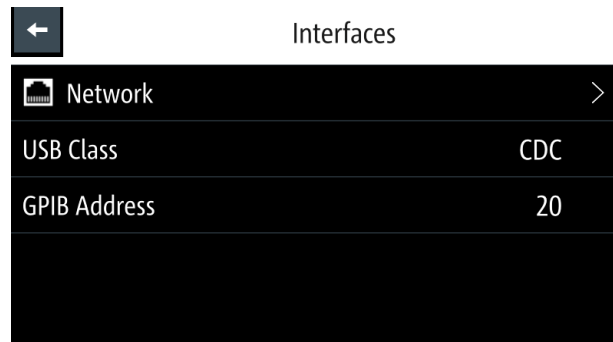

Figure 8-2: Interfaces dialog

2. Select the connected interface ([Network](#), [USB Class](#) or [GPIB Address](#)) to configure the necessary parameters for remote access.

• Network connection	136
• LAN interface	138
• Wireless LAN interface	142
• VNC interface	144
• FTP interface	147
• USB interface	150
• GPIB interface (IEC/IEEE bus interface)	153
• SCPI	154
• VISA	155

8.1.1 Network connection



The "Network" configures the remote access via the following interfaces:

- [LAN](#)
- [Wireless LAN](#)
- [VNC](#)
- [FTP](#)

Access:

- ▶ Select "Network" from [Figure 8-2](#).
The R&S NGP800 displays the "Network" dialog.

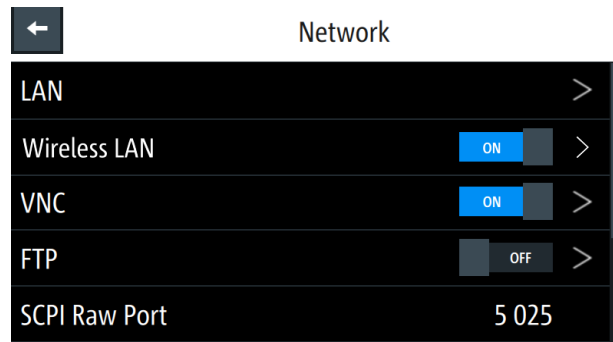

Figure 8-3: Network dialog

To configure network parameters

1. Select the required network interface for configuration.
For details, see the respective section in [LAN interface](#), [Wireless LAN](#), [VNC interface](#) or [FTP](#).
2. Set the required "SCPI Raw Port" and hostname.
The R&S NGP800 displays the on-screen keyboard to enter the port number and hostname.

When the connection is available, the network icon is highlighted in white on the device status bar information.

Settings

LAN	137
Wireless LAN	137
VNC	138
FTP	138
SCPI Raw Port	138
Desired Hostname	138
DNS Hostname / mDNS Hostname	138

LAN

Configures LAN network.

See [Section 8.1.2, "LAN interface"](#), on page 138.

Remote command:

n.a.

Wireless LAN

Enables or disables wireless LAN.

See [Section 8.1.3, "Wireless LAN interface"](#), on page 142.

"ON" Enables wireless LAN.

"OFF" Disables wireless LAN.

Remote command:

[SYSTem:COMMunicate:WLAN\[:STATe\]](#) on page 173

VNC

Enables or disables VNC connection.

See [Section 8.1.4, "VNC interface"](#), on page 144.

"ON" Enables VNC.

"OFF" Disables VNC.

Remote command:

`SYSTem:VNC:STATe` on page 176

FTP

Enables or disables FTP connection.

See [Section 8.1.5, "FTP interface"](#), on page 147.

"ON" Enables FTP.

"OFF" Disables FTP.

Remote command:

n.a.

SCPI Raw Port

A port number used to open a raw TCP/IP connection to send raw SCPI commands to the instrument.

Remote command:

n.a.

Desired Hostname

The name assigned to the instrument used to identify it in the network.

Remote command:

n.a.

DNS Hostname / mDNS Hostname

The name assigned to the domain name is used to identify it in the network.

Remote command:

n.a.

8.1.2 LAN interface

The R&S NGP800 is equipped with a network interface and can be connected to an Ethernet LAN (local area network). If you are assigned the corresponding rights, you can use this interface for remote control and data transfer from a controller PC. Make sure that you have connected the controller PC in the same network.

To establish a network connection, connect a commercial RJ-45 cable to the LAN port of the instrument and to a PC or network switch.

For more information on the connection, see [Section 8.2.1, "LAN connection"](#), on page 155.

Depending on the network capacities, the TCP/IP address information for the instrument can be obtained in different ways.

- If the network supports dynamic TCP/IP configuration using the Dynamic Host Configuration Protocol (DHCP), and a DHCP server is available, all address information can be assigned automatically.
- Otherwise, the address must be set manually. Automatic Private IP Addressing (APIPA) is not supported.

By default, the instrument is configured to use dynamic TCP/IP configuration and obtain all address information automatically. This means that it is safe to establish a physical connection to the LAN without any previous instrument configuration.

Access:

1. **NOTICE!** Risk of network failure. Before connecting the instrument to the network or configuring the network, consult your network administrator. Connection errors may affect the entire network.

If your network does not support DHCP, or if you choose to disable dynamic TCP/IP configuration, you must assign valid address information before connecting the instrument to the LAN. Contact your network administrator to obtain a valid IP address.

2. Connect the LAN cable to the [LAN port](#).
See also [Section 8.2.1, "LAN connection"](#), on page 155.
3. For manual configuration, select [Settings] > "Device" tab > "Interfaces" > "Network" > "LAN" to set LAN connection.

The R&S NGP800 displays the "LAN" dialog.

Note: The "MAC Address" is fixed.

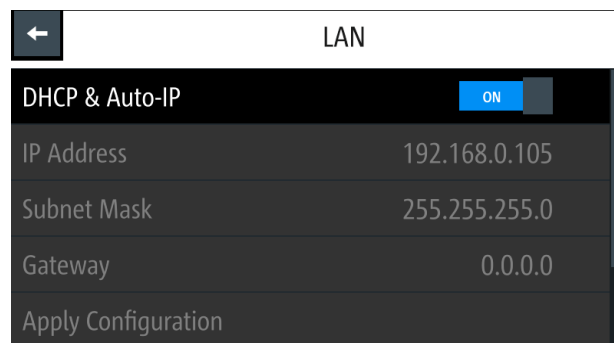

Figure 8-4: Ethernet settings dialog

In this dialog, you can configure the settings of the general network environment and specific identification parameters of the instrument in the network. The R&S NGP800 displays additional parameters for information on the LAN interface and the status of the connection.

To manually configure Ethernet settings

By default, the R&S NGP800 is configured to use a dynamic TCP/IP configuration and to obtain the whole address information automatically. If the network does not support DHCP, you can assign the IP address manually.

1. Configure the required Ethernet settings, see [Settings](#).
The R&S NGP800 displays the on-screen keyboard to set the IP address.

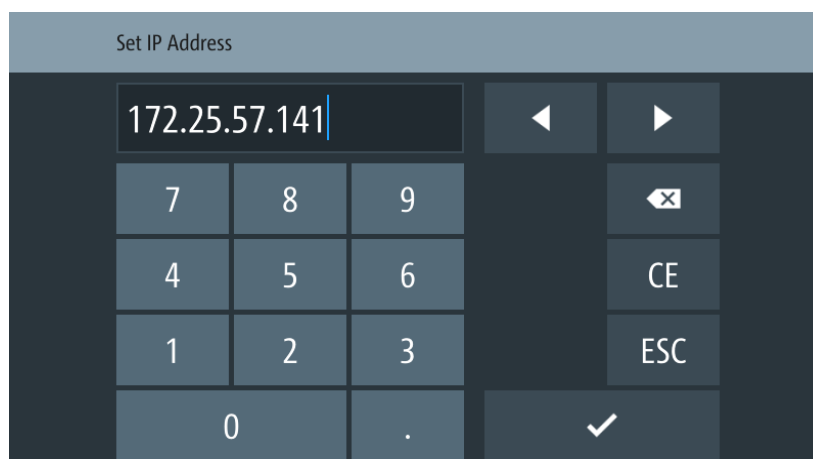



Figure 8-5: On-screen keyboard to set IP address

2. Confirm the value with the "Enter" softkey, .
3. Select "Apply Configuration" to apply the changes.

To assign the IP address manually on the controller PC

- ▶ Obtain the necessary information from your network administrator. If you use more than one LAN connector, you need separate address information for each connector.
For information on how to configure the LAN settings, refer to the documentation of the operating system the PC uses.

To check the LAN connection

You have several possibilities to validate if the LAN connection is established and working properly:

1. Check the LAN connection using ping: `ping <IP address>`.
2. If the PC can access the instrument, enter the IP address of the address line of the internet browser on your computer: `http//:xxx.yyy.zzz.xxx`

The "Instrument Home Page" appears. It provides information on the instrument and the LAN connection.

See [Figure 8-10](#).

Settings

DHCP & Auto-IP	141
IP Address	141
Subnet Mask	141
Gateway	141
Apply Configuration	141

DHCP & Auto-IP

Sets IP address via DHCP or manually.

- "ON" Enables DHCP for automatic network parameter distribution and shows the values of the IP Address. By default, the instrument is configured to use dynamic configuration and obtain all address information automatically.
- "OFF" If the network does not support DHCP, the IP addresses must be set manually.

Remote command:

[SYSTem:COMMunicate:SOCKet:DHCP](#) on page 171

IP Address

Address used in communication with the network.

This address is manually configured if "DHCP & Auto-IP" is set "OFF".

Remote command:

[SYSTem:COMMunicate:SOCKet:IPAdDress](#) on page 171

Subnet Mask

Secondary address used in communication with the network.

This address is manually configured if "DHCP & Auto-IP" is set "OFF".

Remote command:

[SYSTem:COMMunicate:SOCKet:MASK](#) on page 172

Gateway

Gateway address to connect to the network.

This address is manually configured if "DHCP & Auto-IP" is set "OFF".

Remote command:

[SYSTem:COMMunicate:SOCKet:GATeway](#) on page 171

Apply Configuration

Applies the changes made to "[IP Address](#)" on page 141, "[Subnet Mask](#)" on page 141 and "[Gateway](#)" on page 141.

Remote command:

[SYSTem:COMMunicate:SOCKet:APPLY](#) on page 170

[SYSTem:COMMunicate:SOCKet:DISCard](#) on page 171

[SYSTem:COMMunicate:SOCKet:RESet](#) on page 172

8.1.3 Wireless LAN interface



Wi-Fi transmitter performance

- Frequency range: 2412 MHz to 2472 MHz
- Power: 19.5 dBm typical



Instrument option

R&S NGP-K102 (PN: 5601.6400.03) option is required to connect the R&S NGP800 to a network via a wireless LAN connection.

Wireless LAN option is only available for instrument with serial number below 110000.

An alternative to connection in a local area network is a wireless LAN connection. With the presence of an authenticated Wi-Fi signal, the R&S NGP800 automatically connects to a network and navigation can be made via the web browser according to the WLAN IEEE 802.11 b/g/n standards.

Access:

1. **WARNING!** Risk of RF exposure. This is a class A product. In a domestic environment, this product may cause radio interference in which case the user may be required to take adequate measures.
 - When WLAN is active, a minimum separation distance of 20 cm from front panel of the instrument must be observed at all times.
 - When WLAN is active, no operation of the antenna or transmitter should be co-located with the instrument.
2. Select [Settings] > "Device" tab > "Interfaces" > "Network" > "Wireless LAN" to set WLAN connection.

The R&S NGP800 displays the "Wireless LAN Settings" dialog.

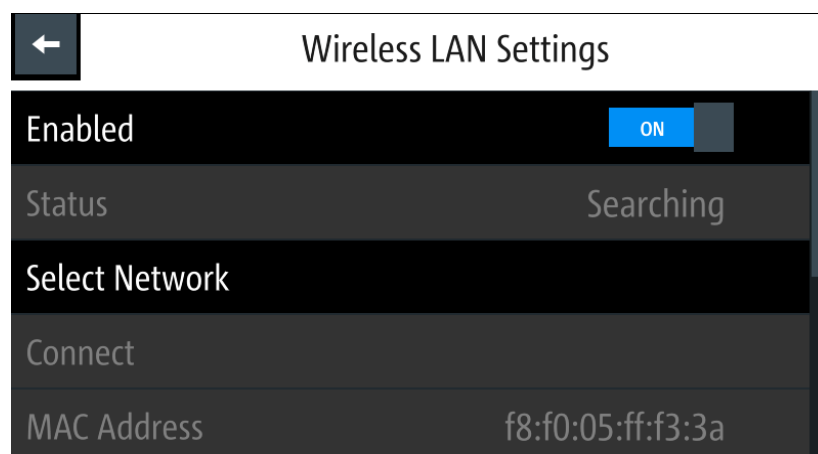
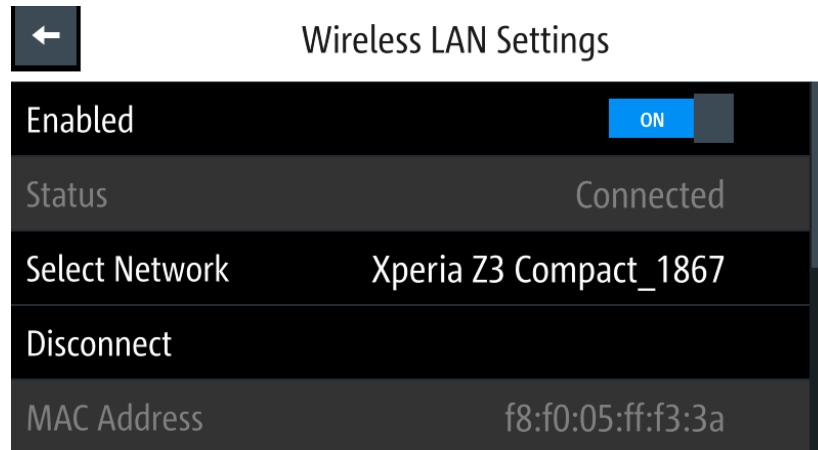

Figure 8-6: Wireless LAN settings dialog

To configure wireless LAN

1. Set "Enabled" to "ON" to enable the "Wireless LAN Settings".
The R&S NGP800 began searching the available Wi-Fi network and the "Status" shows "Searching".
2. Select the "Select Network" to connect to the required Wi-Fi network.
If the connection is successful, the "Status" shows "Connected". See [Figure 8-7](#).
When the connection is alive, the WLAN icon turns white on the device status bar.
See ["Device status"](#) on page 37.

*Figure 8-7: WLAN connected*

3. To disconnect, select the "Disconnect" in the "Wireless LAN Settings" dialog.

Settings

Enabled	143
Status	143
Select Network	144
Connect / Disconnect	144
MAC Address	144

Enabled

Enables or disables WLAN state.

"ON" Enables WLAN.

"OFF" Disables WLAN.

Remote command:

[SYSTEM:COMMunicate:WLAN\[:STATe\]](#) on page 173

Status

Displays the WLAN connection status.

"Searching" The instrument is searching for a WLAN network.

"Connected" The instrument is connected to a WLAN network.

Remote command:
n.a.

Select Network

Selects the Wi-Fi network to connect.

Remote command:

[SYSTem:COMMunicate:WLAN:IPADdress?](#) on page 172

[SYSTem:COMMunicate:WLAN:PASSword](#) on page 173

[SYSTem:COMMunicate:WLAN:SSID](#) on page 173

Connect / Disconnect

Connects or disconnects to the predefined wireless access point.

Remote command:

[SYSTem:COMMunicate:WLAN:CONNECTION\[:STATe\]](#) on page 172

MAC Address

Displays the MAC address of the instrument.

Remote command:

n.a.

8.1.4 VNC interface

Using a [VNC](#) client tool on a computer, you can control the R&S NGP800 remotely. Alternatively, the R&S NGP800 has an integrated web server which you can access the instrument with its corresponding IP address or hostname in the address line of the web browser.

Establish a connection between the computer and R&S NGP800 via same network using [LAN](#) or [WLAN](#).

Access:

- ▶ Select [Settings] > "Device" tab > "Interfaces" > "Network" > "VNC" to set [VNC](#) connection.
The R&S NGP800 displays the "VNC" settings dialog.

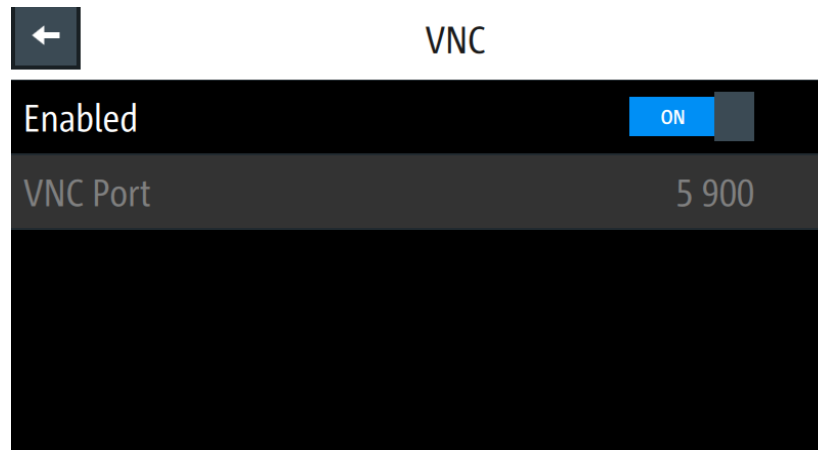

Figure 8-8: VNC settings dialog

To enable VNC connection

1. Select "VNC Port" to set the desired port number.
Configuring the "VNC Port" is only possible if "Enabled" is set "OFF".
All settings are reset to default after a factory reset. See ["To reset the instrument to default settings"](#) on page 118.
2. Set "Enabled" to "ON" to enable VNC connection.
3. On the VNC client tool, connect to R&S NGP800 using the device IP address and VNC port number. If connected successfully, the instrument VNC interface is displayed on the VNC client tool.



Figure 8-9: VNC client of respective instrument model

4. Alternatively, connect to the instrument webpage using the IP address or hostname on the web browser URL bar. If connected successfully, the "Instrument Home" webpage is displayed. See [Figure 8-10](#).

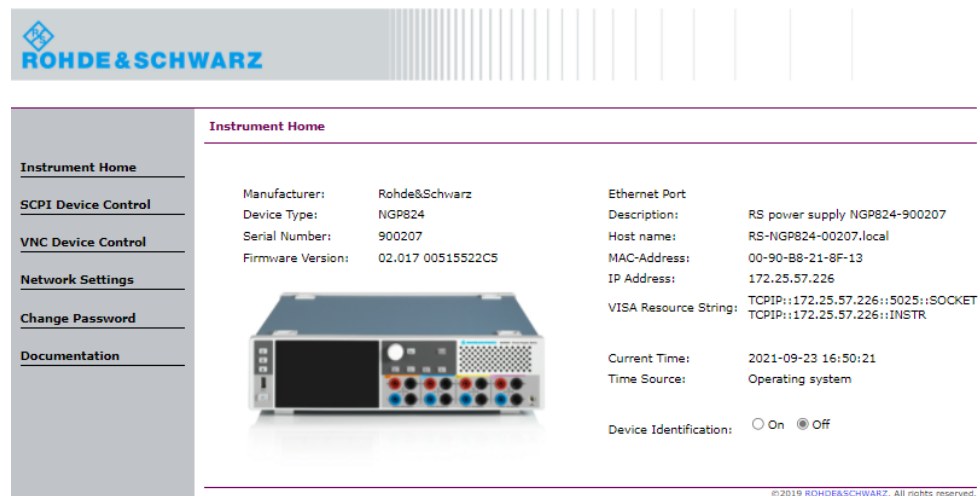

Figure 8-10: Instrument home webpage of a power supply model

- Select the desired function in the instrument home webpage to configure the instrument.
See details in "Settings" on page 146.

Settings

Instrument home webpage.....	146
L Instrument Home.....	146
L SCPI Device Control.....	146
L VNC Device Control.....	146
L Network Settings.....	147
L Change Password.....	147
L Documentation.....	147
Enabled.....	147
VNC Port.....	147

Instrument home webpage

Instrument home webpage provides information and configuring functions for the instrument.

Instrument Home ← Instrument home webpage

Displays instrument information (e.g. model, serial number, firmware version). See [Figure 8-10](#).

SCPI Device Control ← Instrument home webpage

Displays a command and response text box for sending SCPI commands and provides screenshot capture of the instrument display. To view the latest screen capture, select "Refresh screen data".

VNC Device Control ← Instrument home webpage

Displays the virtual instrument for operation. See [Figure 8-9](#).

By default, the VNC port number is 5900 on the webpage. Set the correct port number if it is different from the default and click "Connect" button.

To expand the instrument view, click the "Open in fullscreen" link.

Network Settings ← Instrument home webpage

Displays IPv4 configurations and settings dialog. The "Advanced IP configuration" provides setting to enable or disable the "ICMP Ping" service and "mDNS and DNS-SD" service.

Click "Submit" to send changes to the instrument.

Change Password ← Instrument home webpage

Displays a dialog to change the access password to instrument webpage.

Documentation ← Instrument home webpage

Displays links to the Getting Started manual and product homepage.

Enabled

Enables or disables [VNC](#) connection.

"ON" Enables VNC connection.

"OFF" Disables VNC connection.

Remote command:

[SYSTem:VNC:STATe](#) on page 176

VNC Port

Sets the desired VNC port number.

By default, the VNC port is 5900.

Remote command:

[SYSTem:VNC:PORT](#) on page 175

8.1.5 FTP interface

[FTP](#) (file transfer protocol) provides you with remote file access on the instrument via an Ethernet connection. It generally allows you the following operations:

- Download and upload files from the remote instrument.
- Browse the content (file system) on the remote instrument.

Remote access is limited to the content of the instrument file manager section. See [Section 6.2, "File manager"](#), on page 114.

Access:

- ▶ Select [Settings] > "Device" tab > "Interfaces" > "Network" > "FTP" to set [FTP](#) connection.

The R&S NGP800 displays the "FTP - Remote Access" dialog.

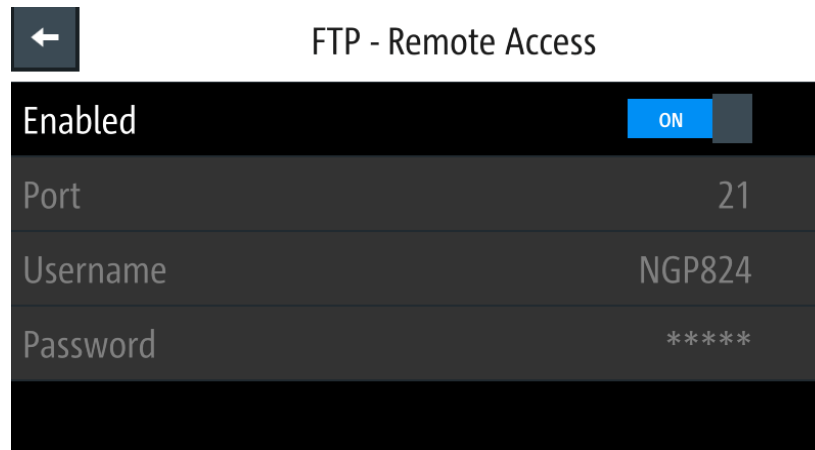

Figure 8-11: FTP settings dialog

To configure FTP access

1. Set "Enabled" to "OFF" to configure the [FTP](#) access.
See details in ["Settings"](#) on page 149.
All settings are reset to default after a factory reset. See ["To reset the instrument to default settings"](#) on page 118. Username is reset to device model (e.g. NGP824) and password is reset to device serial number (e.g. 123456).

2. Set "Enabled" to "ON" to enable FTP access.

3. Run the FTP client of your preference and key in the username, password, device IP or hostname and FTP port (default port number: 21) in your FTP client. Some FTP clients (File Explorer, Internet Explorer, etc.) allow connection via a URL-address.

The usual syntax for FTP connection is `ftp://`

`<Username>:<Password>@<ip or hostname>[:<port>].`

If connected successfully, the instrument root directory and USB root directory (if connected) are displayed.

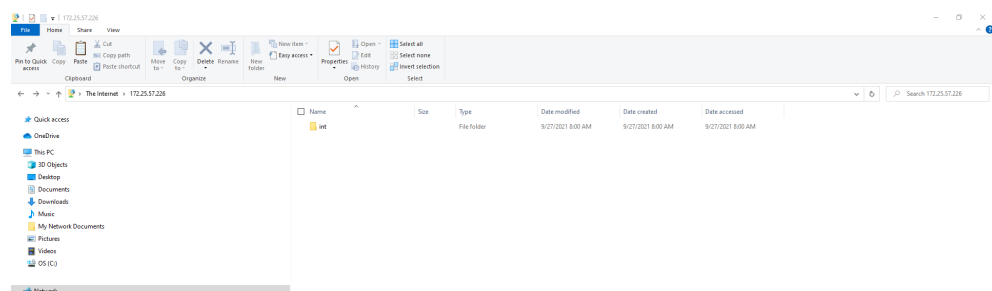

Figure 8-12: Root directory of the instrument using File Explorer

4. For ease of future connections, you can add the connection as a remote network address in the File Explorer.
 - a) Go to the navigation pane on the left side of File Explorer.

- b) Right-click "This PC" > "Add a network location" to create a new network location.
- c) Follow the prompt and select a custom network location.
- d) Enter the URL address mentioned in step 3.
- e) Enter a name for the new network location, e.g. "FTP Remote Power Supply".
The new network location is created.

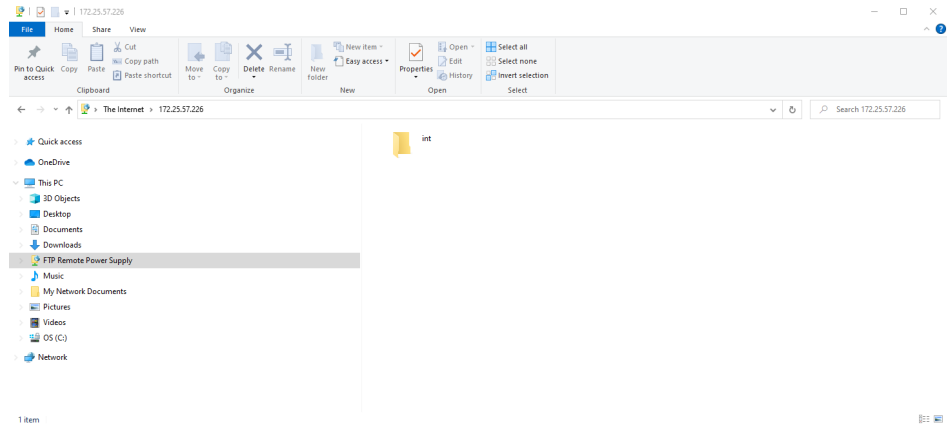

Figure 8-13: New network location

Settings

Enabled..... 149

Port..... 149

Username..... 149

Password..... 149

Enabled

Enables or disables FTP access.

"ON" Enables FTP access.

"OFF" Disables FTP access.

Port

Sets the port number for the FTP server.

Username

Sets the user name for login access.

Password

Sets the password for login access.

8.1.6 USB interface



Change of USB class

If a change in "USB Class" is detected (i.e. from [TMC](#) to [CDC](#) or vice versa), the rebooting of the instrument is necessary to load the correct USB driver.

- A popup message is displayed:

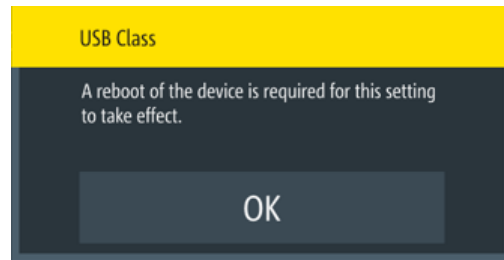

Figure 8-14: USB class - reboot message

You can use the USB-B interface for remote control and data transfer from a controller PC. Remote control over USB requires the VISA library.

Connect a double-shielded USB cable between the [USB Type-B connector](#) and PC for a USB connection. The R&S NGP800 supports "[CDC \(VCP\)](#)" on page 151 and "[USB TMC](#)" on page 151 connections.

For more information on the connection, see [Section 8.2.2, "USB connection"](#), on page 157.

Access:

- ▶ Select [Settings] > "Device" tab > "Interfaces" > "USB Class" to set the USB connection.

The R&S NGP800 displays the USB class dialog.



Figure 8-15: USB dialog

To configure the USB class

1. Set the desired USB class.

See details in "CDC (VCP)" on page 151 and "USB TMC" on page 151.

See also "Change of USB class" on page 150.

2. Select "Set" to confirm the selection.

CDC (VCP)



The following requirements for USB CDC driver installation are necessary:

- A PC with operating system Windows XP, VISTA, Windows 7, Windows 8 (32Bit or 64Bit), Windows 10 or Windows 11.
- Administrator rights are necessary for the installation of the driver.

The CDC (Communications Device Class) also known as VCP (Virtual COM Port) is a protocol that allows the communication to the R&S NGP800 using any terminal program (e.g. HMEexplorer) via SCPI commands once the corresponding Windows drivers have been installed. The driver and software HMEexplorer are available for download on the product homepage (<http://www.rohde-schwarz.com/product/ngp800>).

If a connection between the PC and the instrument has been established and no R&S NGP800 USB CDC driver is installed, the PC operating system displays a "Found New Hardware" wizard. In this case, the R&S NGP800 USB CDC driver must be installed.

The HMEexplorer window application provides the R&S NGP800 a terminal function and also the option to create screenshots and an editor function to create the arbitrary table.

For more information of the driver installation and HMEexplorer window application, see the installation guide of the driver file and the internal HMEexplorer help.

USB TMC

The USB Test & Measurement class (USB-TMC) is a protocol that allows GPIB-like communication via USB interfaces and is a separate instrument class of the USB specification. The USB-TMC protocol supports service queries, triggers, and other GPIB-specific instructions.

VISA drivers are installed and that it can be used directly in the corresponding environments. The driver is included in the NI-VISA package and can be downloaded at <http://www.ni.com/downloads/ni-drivers/>.

A major benefit of the USB TMC class is that by sampling specific registers, the controlling software can determine if commands have been terminated and if they have been processed correctly. With USB CDC, communication with instrument requires analysis and polling mechanisms within the controlling software which may significantly strain the interface of the measurement instruments. The TMC status registers solve this problem with the USB TMC in the same manner as in the case with the GPIB interface for the hardware via the corresponding control lines.



HMExplorer

The window application supports the communication via LAN, USB CDC and WLAN only.

For more information of the VISA driver installation, see the installation guide of the VISA driver file.

Once the driver is installed, the "USB Test and Measurement Device (IVI)" is displayed in the "Device Manager" window, see [Figure 8-16](#).

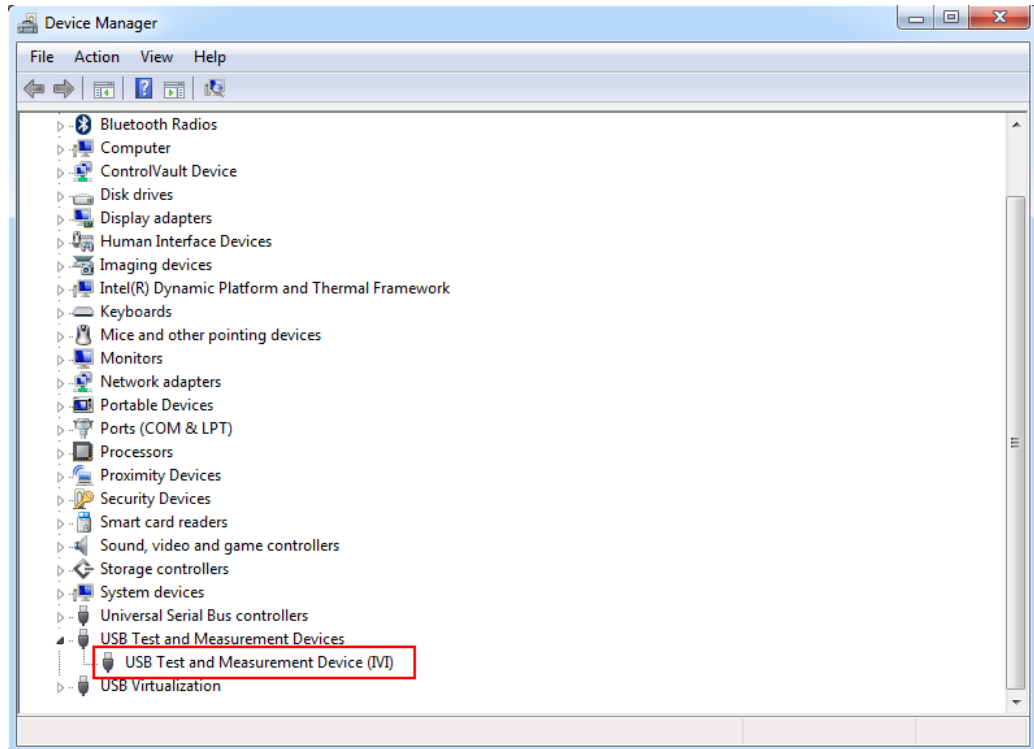

Figure 8-16: Device manager

Settings

USB Class.....	152
L Set.....	153
L Cancel.....	153

USB Class

Configures the USB class.

"CDC" Selects the USB communication device class.

"TMC" Selects the USB test and measurement class.

Remote command:

[INTerfaces:USB:CLASs](#) on page 213

Set ← USB Class

Applies the USB class.

Remote command:

n.a.

Cancel ← USB Class

Cancels the selection and close the window.

Remote command:

n.a.

8.1.7 GPIB interface (IEC/IEEE bus interface)

**Instrument option**

R&S NG-B105 (PN: 5601.6000.02) option needs to be installed for the remote command of R&S NGP800 via [GPIB](#) interface.

The GPIB interface, sometimes called the General Purpose Interface Bus (GPIB), is a general-purpose digital interface system that can be used to transfer data between two or more devices. Some of its key features are:

- Up to 15 instruments can be connected
- The total cable length is restricted to a maximum of 15 m; the cable length between two instruments should not exceed 2 m
- A wired "OR" connection is used if several instruments are connected in parallel

GPIB instrument address

To operate the instrument via remote control, it must be addressed using the [GPIB](#) address. Connect the IEC 625/IEEE 488 connector of the R&S NGP800 to the controller PC with a double-shielded GPIB bus interface cable.

For more information on the connection, see [Section 8.2.3, "GPIB connection"](#), on page 157.

Access:

- ▶ Select [Settings] > "Device" tab > "Interfaces" > "GPIB Address" to set the GPIB address of the instrument.

The R&S NGP800 displays an on-screen keyboard to set the value.

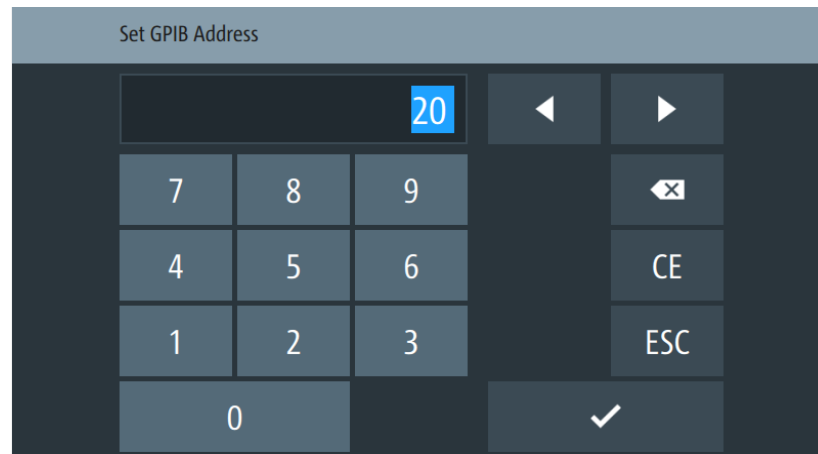



Figure 8-17: On-screen keyboard to set GPIB address

To assign the GPIB (IEEE488) address

1. Enter the required value.
2. Confirm the value with the [Enter] key, . The controller must address the instrument with the GPIB bus address.

To assign the IEEE488 address manually on the controller PC

- ▶ Obtain the necessary information from your network administrator. If you use more than one LAN connector, you need separate address information for each connector. For information on how to configure the LAN settings, refer to the documentation of the operating system the PC uses.

Settings

[GPIB Address](#)..... 154

GPIB Address

Sets the GPIB address of the instrument.

Remote command:

[SYSTem:INTerface:GPIB?](#) on page 174

8.1.8 SCPI

SCPI (Standard Commands for Programmable Instruments) commands - messages - are used for remote control. Commands that are not taken from the SCPI standard follow the SCPI syntax rules. The instrument supports the SCPI version 1999. The SCPI standard is based on standard IEEE 488.2 and aims at the standardization of device-specific commands, error handling and the status registers. The tutorial "Automatic Measurement Control" by John M. Pieper (R&S order number 0002.3536.00) provides detailed information on SCPI and IEEE 488.2 concepts and definitions.

The requirements that the SCPI standard places on command syntax, error handling and configuration of the status registers are explained in detail in the following sections. For more information, see [Section 9, "Remote control commands"](#), on page 165.

8.1.9 VISA

VISA is a standardized software interface library providing input and output functions to communicate with instruments. The I/O channel (LAN or USB) is selected at initialization time by means of a channel-specific resource string. For more information about VISA, refer to its user documentation.

8.2 Setting up remote control connection

The resource string represents an addressing scheme that is used to establish a communication session with the instrument. The following sections show the resource string format used when setting up a remote connection via the various interfaces.



The end character must be set to line feed (LF).

8.2.1 LAN connection

For remote control via a network, the PC and the instrument must be connected over the LAN interfaces to a common network with TCP/IP network protocol. The instruments are connected with a commercial RJ-45 cable (shielded or unshielded twisted-pair CAT 6+).

The TCP/IP network protocol and the associated network services are preconfigured on the instrument. Software for instrument control and (for specified protocols only) the VISA program library must be installed on the controller.



Identifying instruments in a network

If several instruments are connected to the network, each instrument has its own IP address and associated resource string. The controller identifies these instruments by the resource string.

See [Section 8.1.2, "LAN interface"](#), on page 138 and [Section 8.1.3, "Wireless LAN interface"](#), on page 142 for configuring the LAN and WLAN parameters.

The VISA resource string is required to establish a communication session between the controller and the instrument in a LAN. The resource string is a unique identifier, composed of the specific IP address of the instrument and some network and VISA-specific keywords.

To set up the connection, the IP address of the instrument is required. It is part of the resource string used by the program to identify and control the instrument. The resource string has the form:

TCPIP::<host address>[:<LAN device name>][:INSTR]

TCPIP = designates the network protocol
 host address = designates the IP address or hostname of the instrument
 [:<LAN device name>] = defines the protocol and the instance number of a subinstrument
 [:INSTR] = indicates the instrument resource class (optional)

The **IP address** (host address/computer name) is used by the programs to identify and control the instrument. It is automatically assigned by the DHCP server the first time that the device is registered on the network.

Example:

If the instrument has the IP address 192.1.2.3, the valid resource string is:

TCPIP::192.1.2.3::INST

See [Section 3.1.8, "Connecting to LAN"](#), on page 25.

VXI-11

TCPIP::<host address>[:inst0][:INSTR]

[:inst0] = LAN device name indicates that the VXI-11 protocol is used (optional)

[::inst0] selects the VXI-11 protocol by default and can be omitted.

Example:

TCPIP::192.1.2.3::INSTR

HISLIP

High-Speed LAN Instrument Protocol (HiSLIP) is a TCP/IP-based protocol for remote instrument control of LAN-based test and measurement instruments. It was specified by the IVI Foundation and is intended to replace the older VXI-11 protocol. To start a remote control session with HiSLIP, the valid resource string is:

TCPIP::192.1.2.3::HISLIP

Socket communication

TCPIP::<host address>::<port>::SOCKET

TCPIP = designates the network protocol
 host address = designates the IP address or hostname of the instrument
 port = determines the used port number
 SOCKET = indicates the raw network socket resource class

Socket communication requires the specification of the port (commonly referred to as port number) and of "SOCKET" to complete the VISA resource string with the associated protocol used.

The registered port for socket communication is fixed at port 5025.

Example:

```
TCPIP:::192.1.2.3::5025::SOCKET
```

8.2.2 USB connection

See [Section 8.1.6, "USB interface"](#), on page 150 for configuring the USB parameters.

For remote control over the USB connection, the PC and the instrument must be connected over the USB Type-B interface at the rear panel of the instrument. Depending on the used USB port, the connection requires the VISA library or a USB VCP driver to be installed.

On the controller, you need to install any application for instrument control, for example the R&S HME Explorer, and if available, a VISA program library. VISA detects and configures the Rohde & Schwarz instrument automatically when the USB connection is established. You do not have to enter an address string or install a separate driver.

The resource string represents an addressing scheme that is used to establish a communication session with the instrument. It is based on the instrument address and some instrument- and vendor-specific information. The USB resource string syntax is as follows:

- USB TMC

```
USB::<vendor ID>::<product ID>::<serial number>[:INSTR]
```

USB	= denotes the used interface
<vendor ID>	= is the manufacturer ID
<product ID>	= is the product identification of the instrument
<serial number>	= is the individual serial number on the rear of the instrument
[:INSTR]	= indicates the instrument resource class (optional)

Example:

```
USB0::0x0AAD::
0x0197::4007.0005<device_variant>-<device_serial_number>::
INSTR
```

- USB VCP

ASRL<COM>::INSTR, where "COM" refers to the COM port number shown on the controlling PC (e.g. ASRL15::INSTR).

8.2.3 GPIB connection

Available with option R&S NG-B105, the R&S NGP800 provides an IEEE-488 (GPIB) bus interface.

To control the instrument over the GPIB bus interface, the instrument and the controller must be connected with a GPIB bus cable. A GPIB bus card, the card drivers and the program libraries for the programming language used must be provided in the controller.

The controller addresses the instrument within the GPIB bus channel, providing addresses from 0 to 30. The R&S NGP800 has the factory-set address of 20, which you can adjust it according to your environment manually. An instrument preset does not affect the GPIB address.



See [Remote control via SCPI](#) for additional information on the characteristics, control commands and messages of the GPIB interface.

See [Section 8.1.7, "GPIB interface \(IEC/IEEE bus interface\)"](#), on page 153 for configuring the GPIB parameters.

To set up the connection, the GPIB address of the instrument is required. It is part of the resource string used by the program to identify and control the instrument over the GPIB interface. The resource string has the form:

```
GPIB<controller_card>::<GPIB_address>::INSTR
```

You can distinguish between the different GPIB controller cards with "GPIB0", "GPIB1", "GPIB2" and etc.



If the VISA implementation supports the GPIB interface, you can optionally define the VISA Instrument Control Resource (INSTR). It is used to define the basic operations and attributes for a device, such as reading, writing, or triggering.

Example:

```
GPIB::28
```

28 is the selected GPIB bus channel.

To change the GPIB address, see [Section 8.1.7, "GPIB interface \(IEC/IEEE bus interface\)"](#), on page 153.

8.3 Starting and stopping remote control

When you switch on the instrument, it is always in manual operation state ("local" state). You can operate it using the controls on the front panel. To switch to remote control operation, proceed as follows.

Starting a remote control session

To start remote control:

1. Send a command from the controller, or

2. Use SCPI command `SYSTem:REMOte` or `SYSTem:RWLock`.

The instrument switches to remote control and executes the command.

Returning to manual operation

You can return to manual operation either manually or via remote control.

To return to manual control:

1. Press [*] key on the front panel (only if device is locked with `SYSTem:REMOte` command), or
2. Use SCPI command `SYSTem:LOCAl`.

The instrument switches to manual control.

8.4 Status reporting system

The status reporting system stores all information on the current operating state of the instrument and errors which have occurred. This information is stored in the status registers and in the error queue. You can query both via RS-232, USB, GPIB or LAN interface (`STATus...` commands).

8.4.1 Structure of a SCPI status register

Each standard SCPI register consists of 2 or 3 parts (Event, Condition and Enable register). Each part has a width of 16 bits and has different functions. The individual bits are independent of each other, i.e. each hardware status is assigned a bit number which is valid for all 2 or 3 parts. Bit 15 (the most significant bit) is set to zero for all parts. Thus the controller can process contents of the register parts as positive integers.

`STATus:QUEStionable:INSTRument:ISUMmary1` exists as often as device channels are available (e.g. R&S NGP802 / R&S NGP822 = 2 channels = 2 status register). Accordingly, the description text of the channel information changes in [Figure 8-18](#) (e.g. instrument 1 = channel 1, instrument 2 = channel 2 etc.).



Depending on the value of the read register, you can draw conclusions on the current status of the device. For example, when the unit operates in constant voltage, the result of the returned ISUM register is a decimal "2" which corresponds to the binary value of "0000000000000010".

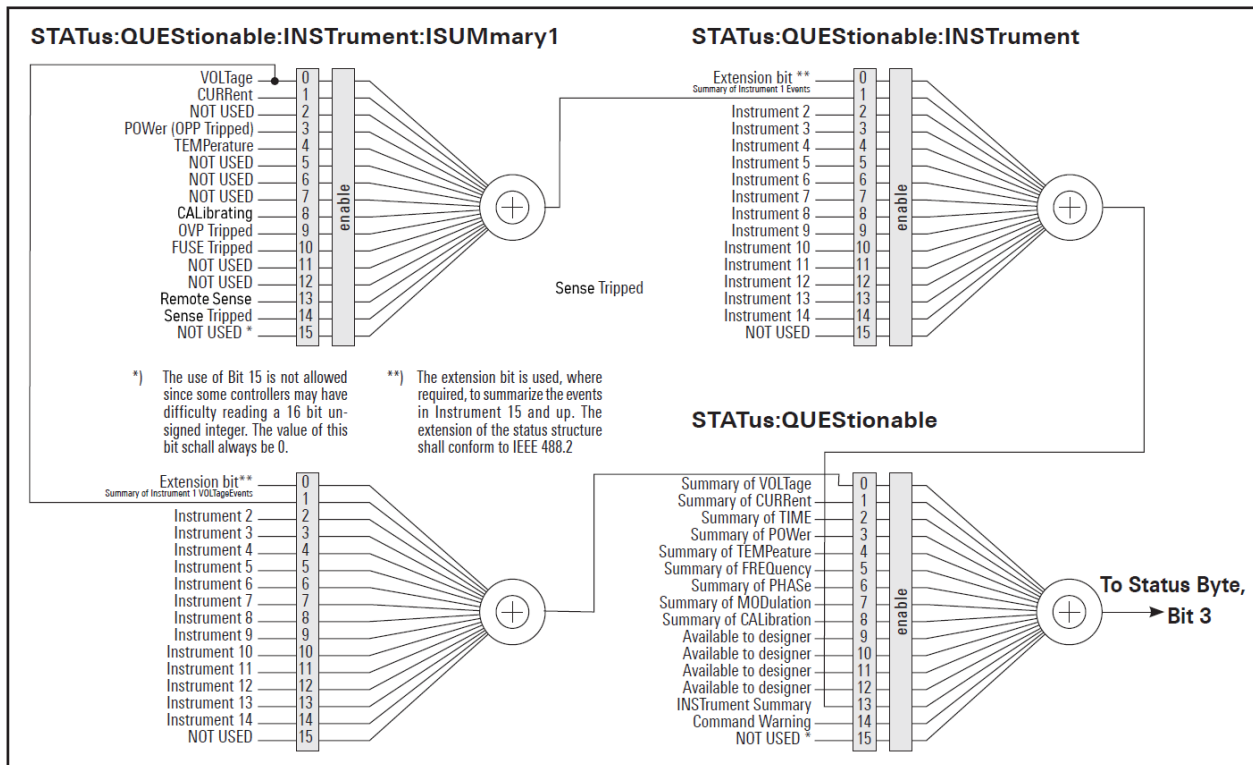

Figure 8-18: Structure of the STATUS:QUESTIONABLE register

Any part of a status register system can be read by query commands. A decimal value is returned and represents the bit pattern of the requested register. Each SCPI register is 16 bits wide and has various functions. The individual bits are independent, i.e. each hardware status is assigned to a bit number.

Bits 9 to 12 are still "free" resp. unused (always return a "0"). Certain areas of the registers are not used. The SCPI standard defines only the "basic functions". Some devices offer an advanced functionality.

Each channel of the power supply is considered as separate "instrument" (SCPI standard definition). Therefore, e.g. the register

STATUS:QUESTIONABLE:INSTRUMENT:ISUMmary of the R&S NGP802 / R&S NGP822 / R&S NGP804 / R&S NGP824 / R&S NGP814 is also present four times (Isummary1 - Isummary4).

Description of the status register parts

The SCPI standard provides two different status registers:

CONDition

- The CONDition register queries the actual state of the instrument. If you want to query the constant voltage or current mode, you have to use the CONDition register.



The CONDition register delivers a "1" (first bit set) in constant current mode (CC) and a "2" (second bit set) in constant voltage mode (CV).

If the correct channel is selected and the red LED of the channel button lights up (CC mode), the query of the `CONDition` register must deliver a "1".

Example:

```
STAT:QUES:INST:ISUM1:COND?
```

EVENT

- The `EVENT` status register is set (1) until it is queried. After reading (query), the `EVENT` status register is set to zero.



The description of registers is only used for general explanation. Due to the complexity, we recommend the generally accessible SCPI standard document for more detailed information.

For further description of the status register, see [Section 9.9, "Status reporting commands"](#), on page 241.

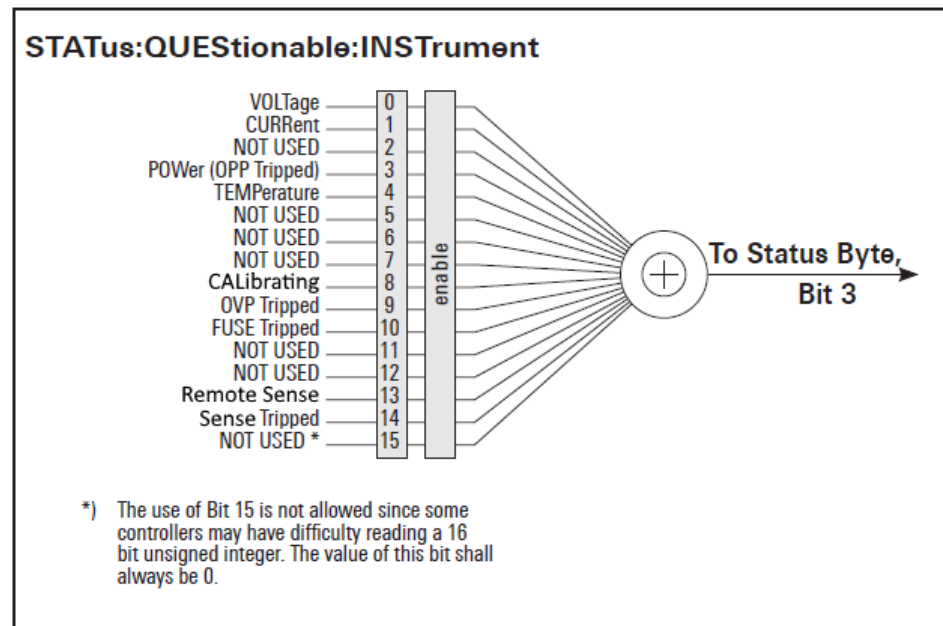

Figure 8-19: Structure of the `status:QUESTIONable:INSTrument` register

8.4.2 Contents of the status registers

8.4.2.1 Event status register (ESR) and event status enable register (ESE)

The ESR is defined in IEEE 488.2. It can be compared with the `EVENT` part of a SCPI register. The event status register can be read out using the command `*ESR?`. The ESE corresponds to the `ENABLE` part of a SCPI register. If a bit is set in the ESE and the associated bit in the ESR changes from 0 to 1, the ESB bit in the STB is set. The

ESE register can be set using the command *ESE and read using the command *ESE?.

8.4.2.2 STATus:OPERation register

In the CONDition part, this register contains information on which actions the instrument is being executing or, in the EVEnt part, information on which actions the instrument has executed since the last reading. It can be read using the commands STATus:OPERation:CONDition? or STATus:OPERation[:EVEnt]?

Bit No.	Meaning
0	Not used
1 to 3	Not used
4	MEASuring This bit is set on event new measurement available.
5 to 9	Not used
10	Logging This bit is set as long as "Logging" is enabled
11	Not used
12	Not used
13 to 14	Not used
15	This bit is always 0

8.4.2.3 STATus:QUESTionable register

This register contains information about different states which can occur. It can be read using the commands STATus:QUESTionable:CONDition? and STATus:QUESTionable[:EVEnt]?. See [Figure 8-18](#).

Table 8-2: Bits of the STATus:QUESTionable register

Bit No.	Meaning
0	Voltage This bit is set while the instrument is in constant current mode (CC). The voltage is regulated and the current is constant.
1	Current This bit is set while the instrument is in constant voltage mode (CV). The current is variable and the voltage is constant.
2	Not used
3	POWER (OPP Tripped) This bit is set if an over power protection has tripped.

Bit No.	Meaning
4	Temperature Overrange This bit is set if an over temperature occurs.
5 to 7	Not used
8	CALibrating This bit is set when the instrument is performing calibration.
9	OVP Tripped This bit is set if the over voltage protection has tripped.
10	Fuse Tripped This bit is set if the fuse protection has tripped.
11 to 12	Not used
13	Remote Sense This bit is set if EXT sense mode is enabled.
14	Sense Tripped This bit is set if the remote sense has tripped
15	This bit is always 0

8.4.2.4 Application of the status reporting system

The purpose of the status reporting system is to monitor the status of one or several instruments in a test system. In particular, it monitors continuous measurements to detect errors in the signal. The controller must receive and evaluate the information of all devices.

The following standard methods are used:

- Query of a specific register by commands
- Query of the error queue

These methods are described in the following sections.

Query of an instrument status

Each part of any status register can be read using queries.

There are two types of commands:

- The common commands `*ESR?`, `*IDN?`, `*STB?` query the higher-level registers.
- The commands of the `STATus` system query the SCPI registers (`STATus:QUEStionable`)

The returned value is always a decimal number that represents the bit pattern of the queried register. This number is evaluated by the controller program.

Decimal representation of a bit pattern (binary weights)

The STB and ESR registers contain 8 bits, the status registers 16 bits. The contents of a status register are specified and transferred as a single decimal number. To make

this possible, each bit is assigned a weighted value. The decimal number is calculated as the sum of the weighted values of all bits in the register that are set to 1.

Bits	0	1	2	3	4	5	6	7	...
Weight	1	2	4	8	16	32	64	128	...

Figure 8-20: Decimal representation of a bit pattern

8.4.3 Error queue

Each error state in the instrument leads to an entry in the error queue. The entries of the error queue are detailed plain text error messages. You can look them up in the error log or via remote control using `SYSTem:ERRor[:NEXT]?`. Each call of `SYSTem:ERRor[:NEXT]?` provides one entry from the error queue. If no error messages are stored, the instrument responds with 0, "No error".

For further description of the error queue and the device error codes, please refer to [Section 9.1, "Common setting commands"](#), on page 165.

9 Remote control commands

This section provides the description of all remote commands available for the R&S NGP800 series. The commands are sorted according to the menu structure of the instrument. A list of commands in alphabetical order is given in the "List of Commands" at the end of this documentation.

9.1 Common setting commands

Common commands are described in the IEEE 488.2 (IEC 625-2) standard. These commands have the same effect and are employed in the same way on different devices. The headers of these commands consist of "*" followed by three letters.

Many common commands are related to the status reporting system.

*CLS.....	165
*ESE.....	165
*ESR?.....	166
*IDN?.....	166
*OPC.....	166
*OPT?.....	166
*RST.....	166
*SRE.....	167
*STB?.....	167
*TST?.....	167
*WAI.....	167
*SAV.....	168
*RCL.....	168

*CLS

Clear status

Sets the status byte (STB), the standard event register (ESR) and the `EVENT` part of the `QUESTIONABLE` and the `OPERATION` registers to zero. The command does not alter the mask and transition parts of the registers. It clears the output buffer.

Usage: Setting only

*ESE <Value>

Event status enable

Sets the event status enable register to the specified value. The query returns the contents of the event status enable register in decimal form.

Parameters:

<Value> Range: 0 to 255

***ESR?**

Event status read

Returns the contents of the event status register in decimal form and then sets the register to zero.

Return values:

<Contents> Range: 0 to 255

Usage: Query only

***IDN?**

Identification

Returns the instrument identification.

Return values:

<ID> "Rohde&Schwarz,<device type>,<part number>/<serial number>,<firmware version>"

Example: Rohde&Schwarz,NGP802,5601.4007k05/900213,02.02000EEED429B

Manual operation: See "[Model](#)" on page 129
 See "[ID](#)" on page 130
 See "[Serial No.](#)" on page 130
 See "[Version](#)" on page 130

***OPC**

Operation complete

Sets bit 0 in the event status register when all preceding commands have been executed. This bit can be used to initiate a service request. The query writes a "1" into the output buffer when all preceding commands have been executed, which is useful for command synchronization.

The R&S NGP800 does not support parallel processing of remote commands. If the query *OPC? returns a „1“, the device is able to process new commands.

***OPT?**

Option identification query

Queries the options included in the instrument. For a list of all available options and their description, refer to the specifications document.

Usage: Query only

***RST**

Reset

Sets the instrument to a defined default status. The default settings are indicated in the description of commands.

We recommend to start a program by *RST in order to set the instrument to a defined status prior to starting a program.

Usage: Setting only

Manual operation: See "[Default Settings](#)" on page 119

*SRE <Contents>

Service request enable

Sets the service request enable register to the indicated value. This command determines the condition that a service request is triggered.

The SRE is an enable register. Consequently, there are no denotations about the bits. This register conduces for the "OR" combination of the bits in the status byte.

Parameters:

<Contents> Contents of the service request enable register in decimal form.
Bit 6 (MSS mask bit) is always 0.
Range: 0 to 255

*STB?

Status byte query

Reads the contents of the status byte in decimal form.

Usage: Query only

*TST?

Self-test query

Initiates self-tests of the instrument and returns an error code.

Return values:

<ErrorCode> **integer > 0 (in decimal format)**
An error occurred.
0
No errors occurred.

Usage: Query only

*WAI

Wait to continue

Prevents servicing of the subsequent commands until all preceding commands have been executed and all signals have settled (see also command synchronization and *OPC).

Usage: Event

***SAV** <Number>

Save

Stores the current instrument settings under the specified number in an internal memory. The settings can be recalled using the command *RCL with the associated number.

Parameters:

<Number> Range: 0..9

Manual operation: See "Save Settings to file" on page 119

***RCL** <Number>

Recall

Loads the instrument settings from an internal memory identified by the specified number. The instrument settings can be stored to this memory using the command *SAV with the associated number.

Parameters:

<Number> Range: 0..9

Manual operation: See "Recall Settings from file" on page 119

9.2 System settings commands

The SYSTem subsystem contains the commands for general functions, which do not affect signal generation directly.

SYSTem:BEEPer:CURRent:STATe.....	169
SYSTem:BEEPer:OUTPut:STATe.....	169
SYSTem:BEEPer:PROTection:STATe.....	170
SYSTem:BEEPer:PROTection[:IMMediate].....	170
SYSTem:BEEPer:WARning:STATe.....	170
SYSTem:BEEPer:WARning[:IMMediate].....	170
SYSTem:COMMunicate:SOCKet:APPLY.....	170
SYSTem:COMMunicate:SOCKet:DHCP.....	171
SYSTem:COMMunicate:SOCKet:DISCard.....	171
SYSTem:COMMunicate:SOCKet:GATeway.....	171
SYSTem:COMMunicate:SOCKet:IPADdress.....	171
SYSTem:COMMunicate:SOCKet:MASK.....	172
SYSTem:COMMunicate:SOCKet:RESet.....	172
SYSTem:COMMunicate:WLAN:CONNECTION[:STATe].....	172

SYSTem:COMMunicate:WLAN:IPADdress?	172
SYSTem:COMMunicate:WLAN:PASSword	173
SYSTem:COMMunicate:WLAN:SSID	173
SYSTem:COMMunicate:WLAN[:STATe]	173
SYSTem:DATE	173
SYSTem:KEY:BRIGhtness	174
SYSTem:INTerface?	174
SYSTem:INTerface:GPIB?	174
SYSTem:LOCal	174
SYSTem:REMote	175
SYSTem:RWLock	175
SYSTem:TIME	175
SYSTem:TOUCh[:STATe]	175
SYSTem:VNC:PORT	175
SYSTem:VNC:STATe	176
SYSTem:UPTime?	176

SYSTem:BEEPer:CURRent:STATe <arg0>**SYSTem:BEEPer:CURRent:STATe?**

Sets or queries "current control" beeper tone state.

Parameters:

<mode>	1
	Control beeper is activated.
	0
	Control beeper is deactivated.

Example:

SYSTem:BEEPer:CURRent:STATe 1

The "CC-Mode Continuous Beep" is activated, a continue beep sound alert when any output channel goes into CC mode.

Manual operation: See "[CC-Mode Continuous Beep](#)" on page 127

SYSTem:BEEPer:OUTPut:STATe <arg0>**SYSTem:BEEPer:OUTPut:STATe?**

Sets or queries "output" beeper tone state.

Parameters:

<state>	1
	Output beeper is activated.
	0
	Output beeper is deactivated.

Example:

SYSTem:BEEPer:OUTPut:STATe 1

The "Output Beep" is activated, a single beep alert when the output state of any channel is changed.

Manual operation: See "[Output Beep](#)" on page 127

SYSTem:BEEPer:PROTection:STATe <arg0>
SYSTem:BEEPer:PROTection:STATe?

Sets or queries "protection" beeper tone state.

Parameters:

<mode> **1**
 Protection beeper is activated.
0
 Protection beeper is deactivated.

Example: SYSTem:BEEPer:PROTection:STATe 1
 The "Protection Tripped Beep" is activated, a single beep alert
 when a protection tripped event occurs.

Manual operation: See "[Protection Tripped Beep](#)" on page 127

SYSTem:BEEPer:PROTection[:IMMEDIATE]

Returns a single "protection" beep immediately.

Usage: Event

Manual operation: See "[Protection Tripped Beep](#)" on page 127

SYSTem:BEEPer:WARNIing:STATe <arg0>
SYSTem:BEEPer:WARNIing:STATe?

Sets or queries "error/warning" beeper tone state.

Parameters:

<state> **1**
 Beep sound for "error/warning" is enabled.
0
 Beep sound for "error/warning" is disabled.

Manual operation: See "[Error Beep](#)" on page 127

SYSTem:BEEPer:WARNIing[:IMMEDIATE]

Returns a single "error/warning" beep immediately.

Usage: Event

Manual operation: See "[Error Beep](#)" on page 127

SYSTem:COMMunicate:SOCKet:APPLY

Apply LAN configuration settings.

Usage: Event

Manual operation: See "[Apply Configuration](#)" on page 141

SYSTem:COMMunicate:SOCKet:DHCP <arg0>

Sets the LAN interface mode.

Parameters:

<mode> **1**
DHCP is enabled.
Automatic IP address from DHCP server.

0
DHCP is disabled.
Manually set IP address.

Manual operation: See "[DHCP & Auto-IP](#)" on page 141

SYSTem:COMMunicate:SOCKet:DISCard

Discards LAN settings.

Usage: Event

Manual operation: See "[Apply Configuration](#)" on page 141

SYSTem:COMMunicate:SOCKet:GATeway <arg0>**SYSTem:COMMunicate:SOCKet:GATeway?**

Sets or queries gateway for LAN.

Parameters:

<address> Gateway address.

Example: SYSTem:COMMunicate:SOCKet:GATeway?
Return gateway address from LAN.

Manual operation: See "[Gateway](#)" on page 141

SYSTem:COMMunicate:SOCKet:IPADdress <arg0>**SYSTem:COMMunicate:SOCKet:IPADdress?**

Sets or queries IP address of the LAN interface.

Parameters:

<address> IP address.

Example: SYSTem:COMMunicate:SOCKet:IPADdress
"192.168.1.128"
Set IP address 192.168.1.128 for the LAN interface.

Manual operation: See "[Misc](#)" on page 130
See "[IP Address](#)" on page 141

SYSTem:COMMunicate:SOCKet:MASK <arg0>
SYSTem:COMMunicate:SOCKet:MASK?

Sets or queries the subnet mask for LAN.

Parameters:

<address> Subnet address.

Example: SYSTem:COMMunicate:SOCKet:MASK "255.255.0.0"
Set subnet mask 255.255.0.0.

Manual operation: See "[Subnet Mask](#)" on page 141

SYSTem:COMMunicate:SOCKet:RESet

Resets LAN settings.

Usage: Event

Manual operation: See "[Apply Configuration](#)" on page 141

SYSTem:COMMunicate:WLAN:CONNECTION[:STATE] <arg0>
SYSTem:COMMunicate:WLAN:CONNECTION[:STATE]?

Sets or queries WLAN connection state.

Parameters:

<mode> **1**
Connect WLAN to the predefined wireless access point.
0
Disconnect WLAN from the predefined wireless access point.

Example: SYSTem:COMMunicate:WLAN:CONNECTION 0
Disconnect WLAN from the predefined wireless access point.

Options: R&S NGP-K102
Instrument with serial number below 110000

Manual operation: See "[Connect / Disconnect](#)" on page 144

SYSTem:COMMunicate:WLAN:IPADdress?

Queries IP address for WLAN.

Example: SYSTem:COMMunicate:WLAN:IPADdress?
Return IP address for WLAN.

Usage: Query only

Options: R&S NGP-K102
Instrument with serial number below 110000

Manual operation: See "[Select Network](#)" on page 144

SYSTem:COMMunicate:WLAN:PASSword <arg0>

Sets password for WLAN.

Parameters:

<password> WLAN password.

Example: SYSTem:COMMunicate:WLAN:PASSword "Password01"
Set WLAN password.

Options: R&S NGP-K102
Instrument with serial number below 110000

Manual operation: See ["Select Network"](#) on page 144

SYSTem:COMMunicate:WLAN:SSID <arg0>**SYSTem:COMMunicate:WLAN:SSID?**

Sets or queries SSID of the access point when wireless interface works as a client.

Parameters:

<ssid> SSID of access point.

Example: SYSTem:COMMunicate:WLAN:SSID?
Return SSID of access point for WLAN.

Options: R&S NGP-K102
Instrument with serial number below 110000

Manual operation: See ["Select Network"](#) on page 144

SYSTem:COMMunicate:WLAN[:STATe] <arg0>**SYSTem:COMMunicate:WLAN[:STATe]?**

Sets or queries the WLAN state.

Parameters:

<state> **1**
Enable WLAN.

0
Disable WLAN.

Options: R&S NGP-K102
Instrument with serial number below 110000

Manual operation: See ["Wireless LAN"](#) on page 137
See ["Enabled"](#) on page 143

SYSTem:DATE <arg0>, <arg1>, <arg2>**SYSTem:DATE?**

Sets or queries the system date.

Parameters:

<year> Sets year of the date.
 <month> Sets month of the date.
 <arg2> Sets day of the date.

Example: `SYSTem:DATE 2018, 10, 15`
`SYSTem:DATE? -> 2018, 10, 15`
 Returns the system date.

Manual operation: See "[Set Date](#)" on page 128

SYSTem:KEY:BRIGhtness <arg0>

SYSTem:KEY:BRIGhtness?

Sets or queries the front panel key brightness.

Parameters:

<brightness> Sets the key brightness.
 Range: 0.0 to 1.0
 Increment: 0.1
 *RST: 1.0

Example: `SYSTem:KEY:BRIGhtness 1.0`
`SYSTem:KEY:BRIGhtness? -> 1.0`
 Returns key brightness value: 1.0.

Manual operation: See "[Key Brightness](#)" on page 126

SYSTem:INTerface?

Queries the available system interface.

Usage: Query only

SYSTem:INTerface:GPIB?

Queries the GPIB interface information.

Usage: Query only

Manual operation: See "[GPIB Address](#)" on page 154

SYSTem:LOCal

Sets the system to front panel control. The front panel control is unlocked. If the front panel control was locked with the SCPI command `SYSTem:RWLock`, the message box of the locked front panel on the instrument display will be disappeared.

Usage: Event

SYSTem:REMOte

Sets the system to remote state. The front panel control is locked. By pushing the soft-key button [*] key, the front panel control will be activated.

Usage: Event

SYSTem:RWLock

Sets the system to remote state. The front panel control is locked and a message box is shown on the instrument display. You are only able to unlock the front panel control via SCPI command `SYSTem:LOCal`.

Usage: Event

SYSTem:TIME <arg0>, <arg1>, <arg2>**SYSTem:TIME?**

Sets or queries the system time.

Parameters:

<hh> Sets the hours of the system time.
 <mm> Sets the minutes of the system time.
 <ss> Sets the seconds of the system time.

Example: `SYSTem:TIME 12, 30, 59`
`SYSTem:TIME? -> 12, 30, 59`
 Returns system time.

Manual operation: See "[Set Time](#)" on page 128

SYSTem:TOUCH[:STATe] <arg0>**SYSTem:TOUCH[:STATe]?**

Sets or queries the touch interface state.

Parameters:

<state> **1**
 Touch interface is activated.
0
 Touch interface is deactivated.

Manual operation: See "[TouchLock](#)" on page 87

SYSTem:VNC:PORT <arg0>**SYSTem:VNC:PORT?**

Sets or queries the VNC port number.

Parameters:

<Port> Range: 100 to 65535

Manual operation: See "VNC Port" on page 147

SYSTem:VNC:STATe <arg0>
SYSTem:VNC:STATe?

Sets or queries the VNC state.

Parameters:

<state> **1**
 Enable VNC.
 0
 Disable VNC.

Manual operation: See "VNC" on page 138
 See "Enabled" on page 147

SYSTem:UPTime?

Queries system uptime.

Usage: Query only

9.3 Display commands

The `DISPlay` subsystem contains the commands for display functions, which do not affect signal generation directly.

<code>DISPlay:BRIGhtness</code>	176
<code>DISPlay[:WINDow]:TEXT:CLEar</code>	177
<code>DISPlay[:WINDow]:TEXT[:DATA]</code>	177

DISPlay:BRIGhtness <arg0>
DISPlay:BRIGhtness?

Sets or queries the display brightness.

Parameters:

<brightness> Displays brightness for the instrument.
 Range: 0.0 to 1.0
 Increment: 0.1
 *RST: 0.8

Example: `DISPlay:BRIGhtness 0.5`
 `DISPlay:BRIGhtness? -> 0.5`
 Returns the display brightness value.

Manual operation: See "Display Brightness" on page 125

DISPlay[:WINDow]:TEXT:CLEar

Clears the text message box on the front display.

Usage: Event

DISPlay[:WINDow]:TEXT[:DATA] <arg0>

Shows the text message box on the front display.

Setting parameters:

<text> New value for text message box.

Usage: Setting only

9.4 Trigger commands

The TRIGger subsystem contains the commands for DIO signal triggering.

TRIGger:CHANnel:DIO<IO>.....	177
TRIGger:CONDition:DIO<IO>.....	178
TRIGger:DIRection:DIO<IO>.....	179
TRIGger:LOGic:DIO<IO>.....	180
TRIGger[:ENABle]:DIO<IO>.....	180
TRIGger[:ENABle]:GENeral.....	180
TRIGger[:ENABle]:SELect:DIO<IO>.....	181

TRIGger:CHANnel:DIO<IO> <arg0>**TRIGger:CHANnel:DIO<IO>?**

Sets or queries the trigger channel of the specified digital I/O line.

Suffix:

<IO> 1..8

Parameters:

<channel> NONE | CH1 | CH2 | CH3 | CH4 | ALL

NONE

No channel is set as the trigger channel.

CH1

Ch 1 is set as the trigger channel.

CH2

Ch 2 is set as the trigger channel.

CH3

Ch 3 is set as the trigger channel.

CH4

Ch 4 is set as the trigger channel.

CHALI

All channels are set as the trigger channel.

Manual operation: See "[Channel](#)" on page 85

TRIGger:CONDition:DIO<IO> <arg0>[, <arg1>]
TRIGger:CONDition:DIO<IO>?

Sets or queries the trigger condition of the specified digital I/O line.

Suffix:

<IO> 1..8

Parameters:

<mode> OUTPUT | OVP | FUSE | OTP | OPP | VMODe | CMODe |
 VLEVel | ILEVel | ENABle | INHibit | ARB | ARBPoint |
 ARBGroup | RAMP | ANINput | STATistics | LOG | PLEVel

OUTPUT

Output the selected logic level when the output is turned on at the selected channel.

OVP

Output the selected logic level when the selected critical event (OVP) occurs on the selected channel.

FUSE

Output the selected logic level when a fuse tripped event occurs on the selected channel.

OTP

Output the selected logic level when the selected critical event (OTP) occurs on the selected channel.

OPP

Output the selected logic level when the selected critical event (OPP) occurs on the selected channel.

VMODe

Output the selected logic level when the selected channel operates in the CV mode.

CMODe

Output the selected logic level when the selected channel operates in the CC mode.

VLEVel

Output the selected logic level when the voltage level of the selected channel is greater or equal to the set voltage level, i.e. $V_{set} \geq \text{set value}$.

ILEVel

Output the selected logic level when the current level of the selected channel is greater or equal to the set current level, i.e. $I_{set} \geq \text{set value}$.

ENABle

Selected channel output is turned on when the selected logic level is met.

INHibit

Selected channel output is inhibited when the selected logic level is met.

Note 1: If the selected channel output is put to inhibit state, manual or remote operation on selected channel output is no longer possible.

Note 2: To reverse the inhibit state, remove the source of the trigger signal. You can either disable the affected DIO interface or remove the source from the affected DIO interface at the rear panel.

ARB

Selected channel QuickArb function is enabled when the selected logic level is met.

ARBPoint

Selected channel QuickArb function is stepped to the next point when the selected logic level is met.

ARBGroup

Selected channel QuickArb function is stepped to the next group when the selected logic level is met.

RAMP

Selected channel ramp is enabled when the selected logic level is met.

ANINput

Selected channel analog input is enabled when the selected logic level is met.

STATistics

Selected channel statistic is enabled when the selected logic level is met.

LOG

For output mode - output the selected logic level when logging is enabled.

For input mode - Logging is enabled when the selected logic level is met.

PLEVel

Output the selected logic level when the power level of the selected channel is greater or equal to the set power level, i.e. PLEVel >= set value.

<value>

Mode value.

Manual operation: See "[Mode](#)" on page 85
See "[Operation Mode](#)" on page 85

TRIGger:DIRection:DIO<IO> <arg0>

TRIGger:DIRection:DIO<IO>?

Sets or queries the specified digital I/O line to function as trigger input/output.

Suffix:
 <IO> 1..8

Parameters:
 <logic> OUTPut | INPut
 *RST: OUTPut

Example: TRIGger:DIRection:DIO2 OUT

Manual operation: See "[Direction](#)" on page 85

TRIGger:LOGic:DIO<IO> <arg0>
 TRIGger:LOGic:DIO<IO>?

Sets or queries the trigger logic ("Active High" / "Active Low") of the specified digital I/O line.

Suffix:
 <IO> 1..8

Parameters:
 <logic> LOW | HIGH
 *RST: HIGH

Manual operation: See "[Active Level](#)" on page 85

TRIGger[:ENABle]:DIO<IO> <arg0>
 TRIGger[:ENABle]:DIO<IO>?

Sets or queries the enable state of the specified digital I/O line.

Suffix:
 <IO> 1..8

Parameters:
 <state> 1
 Selected digital I/O line is enabled.
 0
 Selected digital I/O line is disabled.
 *RST: 0

Manual operation: See "[Digital I/O Trigger](#)" on page 56
 See "[Pin 1 / ... / Pin 8](#)" on page 84
 See "[Enabled](#)" on page 84

TRIGger[:ENABle]:GENeral <arg0>
 TRIGger[:ENABle]:GENeral?

Sets or queries the enable state of the primary on/off of digital I/O trigger.

Parameters:
 <state>

1
Primary state of digital I/O trigger is enabled.

0
Primary state of digital I/O trigger is disabled.

*RST: 0

TRIGger[:ENABLE]:SElect:DIO<IO> <arg0>
TRIGger[:ENABLE]:SElect:DIO<IO>?

Sets or queries the enable state of the specified digital I/O line.

Suffix:

<IO> 1..8

Parameters:

<state> **1**
The specified digital I/O line is enabled.

0
The specified digital I/O line is disabled.

Manual operation: See "Pin 1 / ... / Pin 8" on page 84
 See "Enabled" on page 84

9.5 Configuration commands

The following subsystems contain the commands for channel selection, voltage and current settings for the instrument.

9.5.1 Channel selection

The `INSTRument:Select` subsystem contains the commands for selecting the output channels.

Each channel of the power supply is considered as separate "instrument", which is required by the SCPI standard. Therefore, the SCPI commands use the `INSTRument` node to select a channel.



You can only address the number of channels a device is equipped with, e.g. a maximum of four channels for the NGP804, NGP824, NGP814 or two channels for the NGP802, NGP822.

Example: Selecting a channel

You can select a channel either with an `OUTput` parameter, or just by the channel number. This example lists all ways how you can select and query a selected channel.

```
// *****
// Select a channel
// *****
// selects channel 1
INST OUT1
// queries the channel selection
INST?
// response: "OUT1"
// *****
// Select a channel by its number
// *****
// selects channel number 1
INST:NSEL 1
// queries number of the channel selection
INST:NSEL?
// response: "1"
```

INSTrument:NSElect	182
INSTrument[:SElect]	182

INSTrument:NSElect <arg0>**INSTrument:NSElect?**

Selects or queries the channel by number.

Setting parameters:

<channel> 1 | 2 | 3 | 4
 Range: 1 to 4

Example: See [Example "Selecting a channel"](#) on page 182.

Manual operation: See "[\[Ch 1\] / \[Ch 2\] / \[Ch 3\] / \[Ch 4\]](#)" on page 60

INSTrument[:SElect] <arg0>**INSTrument[:SElect]?**

Selects or queries the channel by keyword.

Setting parameters:

<channel> OUT1 | OUTP1 | OUTPut1 | CH1 | OUT2 | OUTP2 | OUTPut2 |
 CH2 | OUT3 | OUTP3 | OUTPut3 | CH3 | OUT4 | OUTP4 |
 OUTPut4 | CH4
OUT1 | OUTP1 | OUTPut1 | CH1
 Selects Channel 1 (Ch 1)
OUT2 | OUTP2 | OUTPut2 | CH2
 Selects Channel 2 (Ch 2)

OUT3 | OUTP3 | OUTPut3 | CH3

Selects Channel 3 (Ch 3)

OUT4 | OUTP4 | OUTPut4 | CH4

Selects Channel 4 (Ch 4)

Example: See [Example "Selecting a channel"](#) on page 182.

Manual operation: See "[Ch 1] / [Ch 2] / [Ch 3] / [Ch 4]" on page 60

9.5.2 Safety limit setting

The `SOURCE:ALIM` subsystem contains the commands for setting the safety limits of the output channels.

Example: Configuring the safety limit

This example contains all commands to configure and query the voltage and current safety limit.

```
// *****
// Select the channel
// *****
// selects channel 1
INST OUT1
// *****
// Set upper or lower voltage safety limit
// *****
//sets the safety limits to enable
ALIM 1
//queries the safety limits state
ALIM?
//response: "1"
//sets the safety limits for the upper voltage
VOLT:ALIM 15
//queries the safety limits for the upper voltage
VOLT:ALIM?
//response: "15.000"
//sets the safety limits for the lower voltage
VOLT:ALIM:LOW 5
//queries the safety limits for the lower voltage
VOLT:ALIM:LOW?
//response: "5.000"
*****
// Set upper or lower current safety limit
// *****
//sets the safety limits for the upper current
CURR:ALIM 3
//queries the safety limits for the upper current
CURR:ALIM?
//response: "3.0000"
//sets the safety limits for the lower current
CURR:ALIM:LOW 0.005
//queries the safety limits for the lower current
CURR:ALIM:LOW?
//response: "0.005"
```

[SOURCE:]ALIMit[:STATe].....	185
[SOURCE:]VOLTage[:LEVel][:IMMediate]:ALIMit:LOWer.....	185
[SOURCE:]VOLTage[:LEVel][:IMMediate]:ALIMit:UPPer.....	186
[SOURCE:]CURRent[:LEVel][:IMMediate]:ALIMit:LOWer.....	186
[SOURCE:]CURRent[:LEVel][:IMMediate]:ALIMit:UPPer.....	187

```
[SOURce:]VOLTage[:LEVel][:IMMediate]:ALIMit[:UPPer] <arg0>[, <Channel list>]
[SOURce:]VOLTage[:LEVel][:IMMediate]:ALIMit[:UPPer]? [<Channel list>]
```

Sets or queries the upper safety limit for voltage.

Setting parameters:

```
<voltage>          <numeric value> | MIN | MINimum | MAX | MAXimum
                    <numeric value>
                    Numeric value for upper safety limit.
                    MIN | MINimum
                    Min value for upper safety limit.
                    MAX | MAXimum
                    Max value for upper safety limit.
                    Range:      For up to 32 V models: 0.000 to 32.050. For up to
                               64 V models: 0.000 to 64.050.
                    Increment:  0.001
                    *RST:      32.050 or 64.050
```

Parameters for setting and query:

```
<Channel list>    <list>
```

Example: `VOLT:ALIM:UPP? (@1)`
Queries the upper safety limit for voltage at channel 1.

Example: See [Example "Configuring the safety limit"](#) on page 184.

Manual operation: See "[Voltage Limit Min / Voltage Limit Max](#)" on page 79

```
[SOURce:]CURRent[:LEVel][:IMMediate]:ALIMit:LOWer <arg0>[, <Channel list>]
[SOURce:]CURRent[:LEVel][:IMMediate]:ALIMit:LOWer? [<Channel list>]
```

Sets or queries the lower safety limit for current.

Setting parameters:

```
<current>         <numeric value> | MIN | MINimum | MAX | MAXimum
                    <numeric value>
                    Numeric value for lower safety limit.
                    MIN | MINimum
                    Min value for lower safety limit.
                    MAX | MAXimum
                    Max value for lower safety limit.
                    Range:      For up to 32 V models: 0.001 to 20.010. For up to
                               64 V models: 0.001 to 10.010.
                    Increment:  0.001
                    *RST:      0.001
```

Parameters for setting and query:

```
<Channel list>    <list>
```

Example: `CURR:ALIM:LOW? (@1)`
Queries the lower safety limit for current at channel 1.

Example: See [Example "Configuring the safety limit"](#) on page 184.

Manual operation: See ["Current Limit Min / Current Limit Max"](#) on page 79

**[SOURce:]CURRENT[:LEVel][:IMMediate]:ALIMit[:UPPer] <arg0>[, <Channel list>]
[SOURce:]CURRENT[:LEVel][:IMMediate]:ALIMit[:UPPer]? [<Channel list>]**

Sets or queries the upper safety limit for current.

Setting parameters:

<current> <numeric value> | MIN | MINimum | MAX | MAXimum

<numeric value>

Numeric value for upper safety limit.

MIN | MINimum

Min value for upper safety limit.

MAX | MAXimum

Max value for upper safety limit.

Range: For up to 32 V models: 0.001 to 20.010. For up to 64 V models: 0.001 to 10.010.

Increment: 0.001

*RST: 20.010 or 10.010

Parameters for setting and query:

<Channel list> <list>

Example: CURR:ALIM:UPP? (@1)

Queries the upper safety limit for current at channel 1.

Example: See [Example "Configuring the safety limit"](#) on page 184.

Manual operation: See ["Current Limit Min / Current Limit Max"](#) on page 79

9.5.3 Remote sense setting

The VOLTage:SENSe subsystem contains the command for setting the remote sense for the instrument.

[SOURce:]VOLTage:SENSe[:SOURce]..... 187

[SOURce:]VOLTage:SENSe:TRIPped?..... 188

[SOURce:]VOLTage:SENSe:TRIPped:CLEar..... 188

[SOURce:]VOLTage:SENSe[:SOURce] <arg0>[, <Channel list>]

[SOURce:]VOLTage:SENSe[:SOURce]? [<Channel list>]

Sets and queries the remote sense state of the selected channel.

Parameters:

<arg0> INT | EXT | <list>

INT

If remote sense detection is set to "INT", the voltage sense relay is disabled.

For query returns:

INT - Remote sense is disabled.

EXT

If remote sense detection is set to "EXT", internal voltage sense relay in the instrument is switched on and the connection of remote sense wires (S+, S-) to the input of the load become necessary. Failure to connect remote sense can cause overvoltage or unregulated voltage output from the R&S NGP800.

For query returns:

EXT - External, remote sense is activated manually.

Query parameters:

<Channel list> <list>

Example:

VOLT:SENS? (@1) -> EXT

Queries the remote sense detection at channel 1.

Manual operation: See "[Remote sensing](#)" on page 69

[SOURce:]VOLTage:SENSe:TRIPped? [<Channel list>]

Queries the remote sense tripped state of the selected channel.

Query parameters:

<Channel list> <list>

Example:

VOLT:SENS:TRIP? (@1)

Queries the remote sense tripped status at channel 1.

If response is 1, the remote sense is tripped. If response is 0, the remote sense is not tripped.

Usage:

Query only

Manual operation: See "[Remote sensing](#)" on page 69

[SOURce:]VOLTage:SENSe:TRIPped:CLEar [<Channel list>]

Resets the remote sense tripped state of the selected channel. If the remote sense tripped event has occurred before, the reset also erases the message on the display.

Setting parameters:

<Channel list> <list>

Example:

VOLT:SENS:TRIP:CLE (@1)

Resets remote sense tripped state at channel 1.

Usage:

Setting only

Manual operation: See "[Remote sensing](#)" on page 69

9.5.4 Voltage setting

The `SOURCE:VOLTage` subsystem contains the commands for setting the voltage of the output channels. The default unit is V.

Example: Configuring the output voltage

This example contains all commands to configure and query the output voltage.

```
// *****
// Select the channel
// *****
INST OUT1
// *****
// Set upper or lower voltage safety limit
// *****
//sets the safety limits to enable
ALIM 1
//queries the safety limits state
ALIM?
//response: "1"
//sets the safety limits for the upper voltage
VOLT:ALIM 15
//queries the safety limits for the upper voltage
VOLT:ALIM?
//response: "15.000"
//sets the safety limits for the lower voltage
VOLT:ALIM LOW 0
//queries the safety limits for the lower voltage
VOLT:ALIM?
//response: "0.000"
// *****
// Set the voltage value
// *****
// selects a channel and sets the voltage
VOLT 10
// queries the output voltage of a channel
VOLT?
// response: "10.000"
// sets the voltage to maximum or minimum respectively
VOLT MAX
VOLT MIN
// *****
// Query the range of the voltage values
// *****
// queries the upper and lower limit of the output voltage
VOLT? MIN
// response: "0.000"
VOLT? MAX
// response: "64.050"
// *****
// Increase or decrease the voltage stepsize
// *****
// selects the output channel, sets the step width
// and increases the voltage in the selected channel
// from 4 volts
```

```

INST OUT1
VOLT:STEP 4
VOLT UP
// decreases the voltage in the selected channel
// from 4 volts
VOLT DOWN
// queries the voltage step size
VOLT:STEP?
// response: "4.000"

```

[\[SOURce:\]VOLTage\[:LEVel\]\[:IMMediate\]\[:AMPLitude\]](#)..... 191

[\[SOURce:\]VOLTage\[:LEVel\]\[:IMMediate\]:STEP\[:INCRement\]](#)..... 192

[SOURce:]VOLTage[:LEVel][:IMMediate][:AMPLitude] <arg0>[, <Channel list>]

[SOURce:]VOLTage[:LEVel][:IMMediate][:AMPLitude]? [<Channel list>]

Sets or queries the voltage value of the selected channel.

Parameters:

<voltage> <numeric value> | MIN | MINimum | MAX | MAXimum | UP |
DOWN | <list>

<numeric value>

Numeric value in V.

MIN | MINimum

Minimum voltage at 0.000 V.

MAX | MAXimum

Maximum voltage at 64.050 V.

UP

Increases voltage by a defined step size. See [\[SOURce:\]VOLTage\[:LEVel\]\[:IMMediate\]:STEP\[:INCRement\]](#) on page 192.

DOWN

Decreases voltage by a defined step size. See [\[SOURce:\]VOLTage\[:LEVel\]\[:IMMediate\]:STEP\[:INCRement\]](#) on page 192.

Range: 0.000 to 64.050

Parameters for setting and query:

<Channel list> <list>

Example:

VOLT? (@1)

Queries the voltage at channel 1.

Example:

See [Example "Configuring the output voltage"](#) on page 190.

Manual operation:

See ["Voltage and current"](#) on page 64

[SOURce:]VOLTage[:LEVel][:IMMediate]:STEP[:INCRement] <arg0>[, <arg1>]
[SOURce:]VOLTage[:LEVel][:IMMediate]:STEP[:INCRement]? [<arg1>]

Sets or queries the incremental step size for the [VOLT UP](#) | [VOLT DOWN](#) command.

Setting parameters:

<stepsize> <numeric value> | DEF | DEFault

<numeric value>

Step value in V.

DEF | DEFault

Default value of stepsize.

Range: 0.001 to 5.000

Increment: 0.001

*RST: 0.100

Default unit: V

Parameters for setting and query:

<stepsize> DEF | DEFault

Queries the default voltage step size.

Example:

```
INST OUT1
```

```
VOLT:STEP 0.001
```

```
VOLT:STEP DEF
```

```
VOLT:STEP? DEF -> 0.10
```

Returns the default stepsize voltage.

See also [Example "Configuring the output voltage"](#) on page 190.

Manual operation: See "[Voltage and current](#)" on page 64

9.5.5 Current setting

The `SOURce:CURRent` subsystem contains the commands for setting the current limit of the output channels. The default unit is A.

Example: Configuring the current output

```

// *****
// Select the channel
// *****
INST OUT1
// *****
// Set upper or lower current safety limit
// *****
//sets the safety limits to enable
ALIM 1
//queries the safety limits state
ALIM?
//response: "1"
//sets the safety limits for the upper current
CURR:ALIM 3
//queries the safety limits for the upper current
CURR:ALIM?
//response: "3.0000"
//sets the safety limits for the lower current
CURR:ALIM LOW 0.0010
//queries the safety limits for the lower current
CURR:ALIM?
//response: "0.0010"
// *****
// Set the current value
// *****
// selects a channel and sets the current
CURR 2
// queries the current of the selected channel
CURR?
// response: "2.0000"
// *****
// Query the range of the current values
// *****
// queries the upper and lower limit of the current
CURR? MIN
// response: 0.001
CURR? MAX
// response: "20.0000"
// *****
// Increase or decrease the current stepsize
// *****
// selects the output channel, sets the step width
// and decreases the current in the selected channel
// by the set 1 ampere
INST OUT1
CURR:STEP 1
CURR DOWN
// increases the current in the selected channel
// by the set 1 ampere

```

```
CURR UP
// queries the current step size
CURR:STEP?
// response: "1.0000"
```

[SOURce:]CURRent[:LEVel][:IMMediate][:AMPLitude]..... 194
[SOURce:]CURRent[:LEVel][:IMMediate]:STEP[:INCRement]..... 194

[SOURce:]CURRent[:LEVel][:IMMediate][:AMPLitude] <arg0>[, <Channel list>]
[SOURce:]CURRent[:LEVel][:IMMediate][:AMPLitude]? [<Channel list>]

Sets or queries the current value of the selected channel.

Parameters:

<current> <numeric value> | MIN | MINimum | MAX | MAXimum | UP | DOWN | <list>

<numeric value>
Numeric value in the range of 0.001 to 20.0100.

MIN | MINimum
Minimum current at 0.001 A.

MAX | MAXimum
Depending on the set voltage level, the maximum set current is 20.0100 A.
For voltage range up to 32 V, maximum set current is 20.0100 A.
For voltage range up to 64 V, maximum set current is 10.0100 A.

UP
Increases current by a defined step size. See [SOURce:]CURRent[:LEVel][:IMMediate]:STEP[:INCRement] on page 194.

DOWN
Decreases current by a defined step size. See [SOURce:]CURRent[:LEVel][:IMMediate]:STEP[:INCRement] on page 194.

Parameters for setting and query:

<Channel list> <list>

Example: CURR? (@1)
Queries the current at channel 1.

Example: See [Example "Configuring the current output"](#) on page 193.

Manual operation: See ["Voltage and current"](#) on page 64

[SOURce:]CURRent[:LEVel][:IMMediate]:STEP[:INCRement] <arg0>[, <arg1>]
[SOURce:]CURRent[:LEVel][:IMMediate]:STEP[:INCRement]? [<arg1>]

Sets or queries the incremental step size for the CURR UP | CURR DOWN command.

Setting parameters:

<step size> <numeric value> | DEF | DEFault

<numeric value>

Step value in A.

DEF | DEFault

Default value of step size.

Range: 0.0001 to 2.000

Increment: 0.0001

*RST: 0.010

Default unit: A

Parameters for setting and query:

<Opt. default step DEF | DEFault

query> Queries the default voltage step size.

Example:

INST OUT1

CURR:STEP 0.005

CURR:STEP DEF

CURR:STEP? DEF -> 0.1000E+00

Returns the default step size for current.

See [Example "Configuring the current output"](#) on page 193.**Manual operation:** See ["Voltage and current"](#) on page 64

9.5.6 Combined setting of voltage and current settings

The `APPLY` subsystem provides a command that enables you to set the current and voltage of a channel in one step.



The combined voltage and current setting command takes approximately 100 ms, i.e. longer than the setting of a single value.

APPLY <arg0>[, <arg1>, <arg2>]**APPLY?**

Sets or queries the voltage and current value of the selected channel.

Parameters:

<voltage> numeric | MIN | MINimum | MAX | MAXimum | DEF | DEFault

numeric

Numeric value for voltage in the range of 0.000 to 64.050.

MIN | MINimum

Min voltage at 0.000 V.

MAX | MAXimum

Max value for voltage at 64.050V.

DEF | DEFault

Default voltage.

*RST: 1.000

Default unit: V

<current>

numeric | MIN | MINimum | MAX | MAXimum | DEF | DEFault

numeric

Numeric value for current in the range of 0.001 to 20.0100.

MIN | MINimum

Min current at 0.001 A.

MAX | MAXimum

Max value for current at 20.01 A.

DEF | DEFault

Numeric value for current.

*RST: 1.000

Default unit: A

<output>

OUT1 | OUTP1 | OUTPut1 | CH1 | OUT2 | OUTP2 | OUTPut2 |
CH2 | OUT3 | OUTP3 | OUTPut3 | CH3 | OUT4 | OUTP4 |
OUTPut4 | CH4

OUT1 | OUTP1 | OUTPut1 | CH1

Selects output for channel 1.

OUT2 | OUTP2 | OUTPut2 | CH2

Selects output for channel 2.

OUT3 | OUTP3 | OUTPut3 | CH3

Selects output for channel 2.

OUT4 | OUTP4 | OUTPut4 | CH4

Selects output for channel 4.

Example:

```
INST OUT1
```

```
APPL 6,2
```

Sets 6 V and 2 A to output of channel 1.

```
APPL? -> 6.000, 2.000
```

Queries the voltage and current of the selected channel.

Manual operation: See "[Voltage and current](#)" on page 64

9.5.7 Output setting

The `OUTPut` subsystem contains the commands for activating the output channels.

Example: Activating the channels

You can activate a selected channel and turn on or off the outputs either individually or all outputs simultaneously. This example lists all ways how you can activate and query the outputs.

```
// *****
// Activate a channel
// *****
INST OUT1
// activates the selected channel
OUTP:SEL 1
// activates channel 1 and its output
OUTP 1
// queries the output state
OUTP?
// response: "1"
// *****
// Turn on all selected channels simultaneously
// *****
// selects channels 1 and 2
// sets the voltage and current values for both channels
// activates both channels
INST:OUT1
VOLT 12
CURR 0.1
OUTP:SEL 1
INST:OUT2
VOLT 12
CURR 0.2
OUTP:SEL 1
// turns on the output of both channels
OUTP:GEN 1
```

OUTPut:SRATe[:STATe].....	197
OUTPut:IMPedance[:STATe].....	198
OUTPut:GENeral[:STATe].....	198
OUTPut[:STATe].....	199
OUTPut:DELay:DURation.....	199
OUTPut:DELay[:STATe].....	200
OUTPut:SELect.....	200

OUTPut:SRATe[:STATe] <arg0>[, <Channel list>]

OUTPut:SRATe[:STATe]? [<Channel list>]

Sets or queries the reduce slew rate option for the selected channel.

Parameters:

<state>	1	Activates reduce slew rate option for the selected channel.
	0	Deactivates reduce slew rate option for the selected channel.

Parameters for setting and query:

<Channel list> <list>

Example: `OUTPut:SRATe 1`
 `OUTPut:SRATe? -> 1`
 Returns reduce slew rate option as on.

Example: `OUTPut:SRATe? (@1)`
 Returns reduce slew rate option at channel 1.

Manual operation: See "[Reduce Slew Rate](#)" on page 71

OUTPut:IMPedance[:STATe] <arg0>[, <Channel list>]

OUTPut:IMPedance[:STATe]? [<Channel list>]

Sets or queries the output impedance state for the selected channel.

Parameters:

<state> **0**
 Deactivates output impedance for the selected channel.

1
 Activates output impedance for the selected channel.

Parameters for setting and query:

<Channel list> <list>

Example: `OUTPut:IMPedance 1`
 `OUTPut:IMPedance:STAT? -> 1`
 Returns output impedance state as on.

Example: `OUTPut:IMPedance? (@1)`
 Returns output impedance state at channel 1.

Manual operation: See "[High Impedance Mode](#)" on page 70

OUTPut:GENeral[:STATe] <arg0>

OUTPut:GENeral[:STATe]?

Sets or queries the primary output state.

Parameters:

<state> **0**
 Switches off the primary output.

1
 Switches on the primary output.

Example: See [Example "Activating the channels"](#) on page 197.

Manual operation: See "[\[Output\]](#)" on page 61
 See "[\[Output\]](#)" on page 65

OUTPut[:STATe] <arg0>[, <Channel list>]

OUTPut[:STATe]? [<Channel list>]

Sets or queries the output state of the previous selected channels.

Parameters:

<state> **0**
 Switches off previous selected channels.

1
 Switches on previous selected channels.

Parameters for setting and query:

<Channel list> <list>

Example: OUTP? (@1)
 Queries the output state at channel 1.

Example: See [Example "Activating the channels"](#) on page 197.

Manual operation: See "[\[Output\]](#)" on page 61
 See "[\[Output\]](#)" on page 65

OUTPut:DELAy:DURection <arg0>[, <Channel list>]

OUTPut:DELAy:DURection? [<Channel list>]

Sets or queries the duration for output delay.

Setting parameters:

<duration> <numeric value> | MIN | MINimum | MAX | MAXimum

<numeric value>
 Numeric value of the duration in seconds.

MIN | MINimum
 Minimum value of the duration at 0 seconds.

MAX | MAXimum
 Maximum value of the duration at 10 seconds.

 Range: 0, 0.01 to 10
 *RST: 0
 Default unit: s

Parameters for setting and query:

<Channel list> <list>

Example: OUTPut:DELAy:DURection 1
 OUTPut:DELAy:DURection? -> 1
 Returns output delay of 1 s.

Example: OUTPut:DELAy:DURection? (@1)
 Returns output delay at channel 1.

Manual operation: See "[Delay](#)" on page 68

OUTPut:DElay[:STATe] <arg0>[, <Channel list>]
OUTPut:DElay[:STATe]? [<Channel list>]

Sets or queries the output delay state for the selected channel.

Parameters:

<state> **0**
 Deactivates output delay for the selected channel.
 1
 Activates output delay for the selected channel.

Parameters for setting and query:

<Channel list> <list>

Example: OUTPut:DElay 1
 OUTPut:DElay? -> 1
 Returns output delay state as on.

Example: OUTPut:DElay? (@1)
 Returns output delay state at channel 1.

Manual operation: See "[Enabled](#)" on page 68

OUTPut:SElect <arg0>[, <Channel list>]
OUTPut:SElect? [<Channel list>]

Sets or queries the output state of selected channel.

Parameters:

<state> **0**
 Deactivates the selected channel.
 1
 Activates the selected channel.
 *RST: 0

Parameters for setting and query:

<Channel list> <list>

Example: OUTPut:SEL? (@1)
 Queries output state at channel 1.

Example: See [Example "Activating the channels"](#) on page 197.

Manual operation: See "[\[Output\]](#)" on page 61
 See "[\[Output\]](#)" on page 65

9.5.8 OCP setting

The FUSE subsystem contains the commands for overcurrent protection parameters such as activating fuses and setting fuse parameters of the output channels. The default unit is A.



The delay function of the fuses takes effect when the corresponding channel is activated (output on).

Example: Configuring fuses

This example contains all commands to configure and query the fuse states and settings.

```
// *****
// Activate a fuse
// *****
INST OUT1
// selects a channel and activates the overcurrent protection
FUSE 1
// queries the state of the overcurrent protection in the selected channel
FUSE?
// response: "1"
// *****
// Set a delay time for the overcurrent protection. The delay time
// takes effect when the channel output is turned on.
// *****
// sets 0.05 s delay for the overcurrent protection
FUSE:DEL 0.05
// queries the currently set delay time of the overcurrent protection
// in the selected channel
FUSE:DEL?
// response: "0.05"
// sets the delay time to maximum, minimum respectively
FUSE:DEL MAX
FUSE:DEL MIN
// *****
// Query the range of the overcurrent protection delay time
// *****
// queries the upper and lower limit of the
// overcurrent protection delay time in ms
FUSE:DEL? MIN
// response: "0"
FUSE:DEL? MAX
// response: "10"
// *****
// Set a initial delay time for the overcurrent protection. During
// the timeframe, overcurrent protection tripping is inhibited.
// *****
// sets 0.1 s for the initial overcurrent protection delay
FUSE:DEL:INIT 0.1
// queries the currently set initial overcurrent protection delay
// in the selected channel
FUSE:DEL:INIT?
// response: "0.1"
// sets the initial overcurrent protection delay to maximum, minimum respectively
```

```

FUSE:DEL:INIT MAX
FUSE:DEL:INIT MIN
// *****
// Query a tripped overcurrent protection
// *****
INST OUT1
//queries whether the OCP in channel 1 has tripped
FUSE:TRIP?
//response: "1" - OCP is tripped
//response: "0" - OCP is not tripped
//resets a tripped OCP in the selected channel
FUSE:TRIP:CLEAr
// *****
// Link the electronic overcurrent protection of the channels logically
// *****
INST OUT1
// links the overcurrent protection of channel 1 with channel 2
FUSE:LINK 2
// queries the combined overcurrent protection of the selected channel
FUSE:LINK?
// *****
// Unlink linked overcurrent protection
// *****
FUSE:UNLink 2
// queries the combined overcurrent protection of the selected channel
FUSE:LINK?
//response: "0"

```

FUSE:TRIPped:CLEAr.....	202
FUSE:DELAy:INITial.....	203
FUSE:DELAy[:BLOWing].....	203
FUSE:LINK.....	204
FUSE:TRIPped?.....	204
FUSE:UNLink.....	204
FUSE[:STATe].....	205

FUSE:TRIPped:CLEAr [<Channel list>]

Resets the OCP state of the selected channel. If an OCP event has occurred before, the reset also erases the message on the display.

Setting parameters:

<Channel list> <list>

Example: FUSE:TRIP:CLE (@1)
Reset OCP state at channel 1.

Example: See [Example "Configuring fuses"](#) on page 201.

Usage: Setting only

Manual operation: See ["Enabled"](#) on page 74

FUSE:DElay:INITial <arg0>[, <Channel list>]

FUSE:DElay:INITial? [<Channel list>]

Sets or queries the initial fuse delay time once output turns on.

Parameters:

<duration> <numeric value> | MIN | MINimum | MAX | MAXimum

<numeric value>

Numeric value for initial fuse delay.

MIN | MINimum

Min value for initial fuse delay.

MAX | MAXimum

Max value for initial fuse delay.

Range: 0, 0.01 to 60

*RST: 0

Default unit: s

Parameters for setting and query:

<Channel list> <list>

Example: FUSE:DEL:INIT? (@1)

Queries initial fuse delay time at channel 1.

Example: See [Example "Configuring fuses"](#) on page 201.

Manual operation: See ["Fuse Delay At Output-On"](#) on page 75

FUSE:DElay[:BLOWing] <arg0>[, <Channel list>]

FUSE:DElay[:BLOWing]? [<Channel list>]

Sets or queries the fuse delay time.

Parameters:

<duration> <numeric value> | MIN | MINimum | MAX | MAXimum

<numeric value>

Numeric value for the initial fuse delay.

MIN | MINimum

Min value for initial fuse delay.

MAX | MAXimum

Max value for initial fuse delay.

Range: 0, 0.01 to 10

*RST: 0

Default unit: s

Parameters for setting and query:

<Channel list> <list>

Example: FUSE:DEL? (@1)

Queries fuse delay time at channel 1.

Example: See [Example "Configuring fuses"](#) on page 201.

Manual operation: See ["Fuse Delay Time"](#) on page 75

FUSE:LINK <arg0>...

FUSE:LINK? <arg0>...

Sets or queries the fuses of several selected channels (fuse linking).

Parameters for setting and query:

<arg0> 0 | 1 | 2 | 3 | 4

0 - Link all other channels to the previously selected channel.

Example:

INST OUT1; :FUSE:LINK 2

Channel 2 is linked with channel 1.

INST OUT1; :FUSE:LINK?

Returns a comma-separated list of all channels linked to channel 1.

See [Example "Configuring fuses"](#) on page 201.

Manual operation: See ["Link to Channel 1 / Link to Channel 2 / Link to Channel 3 / Link to Channel 4"](#) on page 75

FUSE:TRIPped? [<Channel list>]

Queries the OCP state of the selected channel.

Query parameters:

<Channel list> <list>

Example:

FUSE:TRIP?

Response 1, the OCP is tripped.

Response 0, the OCP is not tripped.

Example:

FUSE:TRIP? (@1)

Queries fuse tripped status at channel 1.

Usage:

Query only

Manual operation: See ["Enabled"](#) on page 74

See [Example "Configuring fuses"](#) on page 201.

FUSE:UNLink <arg0>...

Unlinks fuse linking from the other channels (Ch 1, Ch 2, Ch 3 or Ch 4).

See [Example "Configuring fuses"](#) on page 201.

Parameters:

<arg0> 0 | 1 | 2 | 3 | 4

0 - Unlink all other channels to the previously selected channel.

Example:

FUSE:UNL 1

Fuse linking is unlinked from channel 1.

Usage: Setting only

Manual operation: See "[Link to Channel 1 / Link to Channel 2 / Link to Channel 3 / Link to Channel 4](#)" on page 75

FUSE[:STATe] <arg0>[, <Channel list>]

FUSE[:STATe]? [<Channel list>]

Sets or queries the state for over current protection (OCP).

See [Example "Configuring fuses"](#) on page 201.

Parameters:

<arg0>	1 0
	1
	Activates the OCP state.
	0
	Deactivates the OCP state.

Parameters for setting and query:

<Channel list>	<list>
----------------	--------

Example: FUSE 1
Activates the OCP.

Example: FUSE? (@1)
Queries fuse state at channel 1.

Manual operation: See "[Overcurrent Protection \(OCP\)](#)" on page 59
See "[Enabled](#)" on page 74

9.5.9 OVP setting

The `VOLTage:PROTection` subsystem contains the commands for setting the over-voltage protection parameters for the output channels. The default unit is V.

Example: Configuring the overvoltage protection

```

// *****
// Set the overvoltage protection value
// *****
INST OUT1
//activates the OVP of the previous selected channel
VOLT:PROT 1
// selects a channel and sets the OVP
VOLT:PROT:LEV 5
// queries the output overvoltage value of a channel
VOLT:PROT:LEV?
// response: "5"
// queries the OVP state of the previous selected channel
VOLT:PROT?
// response: "1"
// sets the overvoltage protection to maximum,
// or minimum respectively
VOLT:PROT:LEV MAX
VOLT:PROT:LEV MIN
// *****
// Query the range of the overvoltage protection values
// *****
// queries the upper and lower limit
VOLT:PROT:LEV? MIN
// response: "0.100"
VOLT:PROT:LEV? MAX
// response: "64.050"
// *****
// Query a tripped overvoltage protection
// *****
INST OUT1
// queries whether the OVP in channel 1 has tripped
VOLT:PROT:TRIP?
// response: "1" - OVP is tripped
// response: "0" - OVP is not tripped
// resets a tripped OVP in the selected channel
VOLT:PROT:CLEAr
// *****
// Set the overvoltage protection mode
// *****
INST OUT1
// sets OVP protected mode for channel1
VOLT:PROT:MODE PROT
// queries the OVP mode
VOLT:PROT:MODE PROT?
// response: "protected"

```

[SOURce:]VOLTage:PROTection[:STATe].....	207
[SOURce:]VOLTage:PROTection:CLEAr.....	207
[SOURce:]VOLTage:PROTection:LEVel.....	207
[SOURce:]VOLTage:PROTection:TRIPped?.....	208

[SOURce:]VOLTage:PROTection[:STATe] <arg0>[, <Channel list>]

[SOURce:]VOLTage:PROTection[:STATe]? [<Channel list>]

Sets or queries the OVP state of the previous selected channel.

Parameters:

<state>	0	OVP is deactivated.
	1	OVP is activated.

Parameters for setting and query:

<Channel list> <list>

Example: VOLT:PROT? (@1)
Queries OVP state at channel 1.

Example: See [Example "Configuring the overvoltage protection"](#)
on page 206.

Manual operation: See ["Overvoltage Protection \(OVP\)"](#) on page 59
See ["Enabled"](#) on page 76

[SOURce:]VOLTage:PROTection:CLEAr [<Channel list>]

Resets the OVP state of the selected channel. If an OVP event has occurred before, the reset also erases the message on the display.

Setting parameters:

<Channel list> <list>

Example: VOLT:PROT:CLEAR (@1)
Resets OVP state at channel 1.

Example: See [Example "Configuring the overvoltage protection"](#)
on page 206.

Usage: Setting only

Manual operation: See ["Enabled"](#) on page 76

[SOURce:]VOLTage:PROTection:LEVel <arg0>[, <Channel list>]

[SOURce:]VOLTage:PROTection:LEVel? [<Channel list>]

Sets or queries the overvoltage protection value of the selected channel.

Parameters:

<voltage>	<numeric value> MIN MINimum MAX MAXimum DEF DEFault
-----------	---

<numeric value>

Numeric value for the overvoltage protection value in V.

MIN | MINimum

Minimum value for the overvoltage protection value at 0.000 V.

MAX | MAXimum

Maximum value for the overvoltage protection value at 32.050 V (for up to 32 V models) or 64.050 V (for up to 64 V models).

Range: 0.000 to 32.050 or 0.000 to 64.050

*RST: 32.050 or 64.050

Default unit: V

Parameters for setting and query:

<Channel list> <list>

Example: VOLT:PROT:LEV? (@1)

Queries overvoltage protection value at channel 1.

Example: See [Example "Configuring the overvoltage protection"](#) on page 206.

Manual operation: See ["Level"](#) on page 76

[SOURce:]VOLTage:PROTection:TRIPped? [<Channel list>]

Queries the OVP state of the selected channel.

Query parameters:

<Channel list> <list>

Example: VOLT:PROT:TRIP?

Response 1, the OVP is tripped.

Response 0, the OVP is not tripped.

Example: VOLT:PROT:TRIP? (@1)

Queries OVP state at channel 1.

Usage: Query only

Manual operation: See ["Enabled"](#) on page 76

See [Example "Configuring the overvoltage protection"](#) on page 206.

9.5.10 OPP setting

The POWer:PROTection subsystem contains the commands for setting the over-power protection parameters for the output channels. The default unit is W.

Example: Configuring the overpower protection

```
// *****
// Set the overpower protection value
// *****
INST OUT1
//activates the OPP of the previous selected channel
POW:PROT 1
// selects a channel and sets the OPP
POW:PROT:LEV 5
// queries the output overvoltage value of a channel
POW:PROT:LEV?
// response: "5"
// queries the OPP state of the previous selected channel
POW:PROT?
// response: "1"
// sets the overvoltage protection to maximum,
// or minimum respectively
POW:PROT:LEV MAX
POW:PROT:LEV MIN
// *****
// Query the range of the overpower protection values
// *****
// queries the upper and lower limit
POW:PROT:LEV? MIN
// response: "0.0"
POW:PROT:LEV? MAX
// response: "60.0"
// *****
// Query a tripped overpower protection
// *****
INST OUT1
// queries whether the OPP in channel 1 has tripped
POW:PROT:TRIP?
// response: "1" - OPP is tripped
// response: "0" - OPP is not tripped
// resets a tripped OPP in the selected channel
POW:PROT:CLEAr
```

[SOURce:]POWer:PROTection[:STATe].....	209
[SOURce:]POWer:PROTection:CLEAr.....	210
[SOURce:]POWer:PROTection:LEVel.....	210
[SOURce:]POWer:PROTection:TRIPped?.....	211

[SOURce:]POWer:PROTection[:STATe] <arg0>[, <Channel list>]

[SOURce:]POWer:PROTection[:STATe]? [<Channel list>]

Sets or queries the OPP state of the previous selected channel.

Parameters:

<state>

0
OPP is deactivated.

1
OPP is activated.

Parameters for setting and query:

<Channel list> <list>

Example: POW:PROT? (@1)
Queries OPP state at channel 1.

Example: See [Example "Configuring the overpower protection"](#)
on page 209.

Manual operation: See ["Overpower Protection \(OPP\)"](#) on page 59
See ["Enabled"](#) on page 77

[SOURCE:]POWER:PROTECTION:CLEAR [<Channel list>]

Resets the OPP state of the selected channel. If an OPP event has occurred before, the reset also erases the message on the display.

Setting parameters:

<Channel list> <list>

Example: POW:PROT:CLEAR (@1)
Resets OPP state at channel 1.

Example: See [Example "Configuring the overpower protection"](#)
on page 209.

Usage: Setting only

Manual operation: See ["Enabled"](#) on page 77

[SOURCE:]POWER:PROTECTION:LEVEL <arg0>[, <Channel list>]

[SOURCE:]POWER:PROTECTION:LEVEL? [<Channel list>]

Sets or queries the overvoltage protection value of the selected channel.

Parameters:

<power> <numeric value> | MIN | MINimum | MAX | MAXimum | DEF |
DEFault

<numeric value>

Numeric value of the power protection level in watts.

MIN | MINimum

Minimum value of the power protection level at 1.00 W.

MAX | MAXimum

Maximum value of the power protection level at 200.00 W.

DEF | DEFault

Default value of the power protection level at 200.00 W.

Range: 1.00 to 200.00

*RST: 200.00
Default unit: W

Parameters for setting and query:

<Channel list> <list>

Example: POW:PROT:LEV? (@1)
Queries OPP value at channel 1.

Example: See [Example "Configuring the overpower protection"](#) on page 209.

Manual operation: See ["Level"](#) on page 77

[SOURce:]POWER:PROTection:TRIPped? [<Channel list>]

Queries the OPP state of the selected channel.

Query parameters:

<Channel list> <list>

Example: POW:PROT:TRIP?
Response 1, the OPP is tripped.
Response 0, the OPP is not tripped.

Example: POW:PROT:TRIP? (@1)
Queries OPP state at channel 1.

Usage: Query only

Manual operation: See ["Enabled"](#) on page 77

See [Example "Configuring the overpower protection"](#) on page 209.

9.5.11 Reset protection tripped state

The `Protection` subsystem contains the command to reset the protection tripped state.

[SOURce:]PROTection:CLEAr [<Channel list>]

Reset protection tripped state.

Setting parameters:

<Channel list> <list>

Example: PROT:CLE (@1)
Reset protection tripped state at channel 1.

Usage: Setting only

Manual operation: See ["Enabled"](#) on page 74
See ["Enabled"](#) on page 76
See ["Enabled"](#) on page 77

9.5.12 Tracking setting

The TRACking subsystem contains the commands for changes made on reference channel are applied to the tracked channels.

TRACking[:ENABle]:CH<CHANNEL>.....	212
TRACking[:ENABle]:GENeral.....	212
TRACking[:ENABle]:SELect:CH<CHANNEL>.....	212

TRACking[:ENABle]:CH<CHANNEL> <arg0>
TRACking[:ENABle]:CH<CHANNEL>?

Sets or queries the tracking status on selected channel.

Suffix:

<CHANNEL> 1..4

Parameters:

<arg0> **0**
 Tracking is disabled on specified channel.

1
 Tracking is enabled on specified channel.

Manual operation: See "Enabled" on page 80
 See "Ch 1 / Ch 2 / Ch 3 / Ch 4" on page 80

TRACking[:ENABle]:GENeral <arg0>
TRACking[:ENABle]:GENeral?

Sets or queries the status of the primary tracking state.

Parameters:

<arg0> **0**
 Primary tracking is disabled.

1
 Primary tracking is enabled.

Manual operation: See "Tracking" on page 56
 See "Ch 1 / Ch 2 / Ch 3 / Ch 4" on page 80

TRACking[:ENABle]:SELect:CH<CHANNEL> <arg0>
TRACking[:ENABle]:SELect:CH<CHANNEL>?

Sets or queries the status of tracking soft enable on specific channel.

Suffix:

<CHANNEL> 1..4

Parameters:

<arg0> **0**
 Tracking is disabled.

1

Tracking is enabled.

Manual operation: See "Enabled" on page 80
See "Ch 1 / Ch 2 / Ch 3 / Ch 4" on page 80

9.5.13 Interface setting

The `Interface` subsystem contains the commands for changes made on the USB class.

INTERfaces:USB:CLASs <arg0>

INTERfaces:USB:CLASs?

Sets or queries the USB class.

Parameters:

<USB class> CDC | TMC
CDC
 USB CDC connection.
TMC
 USB TMC connection.

Manual operation: See "USB Class" on page 152

9.6 Measurement commands

The `MEASure` subsystem provides commands to query the voltage and current values of a channel.

<code>READ?</code>	214
<code>MEASure[:SCALar]:ENERgy?</code>	214
<code>MEASure[:SCALar]:STATistic:COUNT?</code>	214
<code>MEASure[:SCALar]:STATistic:RESet</code>	214
<code>MEASure[:SCALar]:CURRent[:DC]?</code>	215
<code>MEASure[:SCALar]:CURRent[:DC]:AVG?</code>	215
<code>MEASure[:SCALar]:CURRent[:DC]:MAX?</code>	215
<code>MEASure[:SCALar]:CURRent[:DC]:MIN?</code>	215
<code>MEASure[:SCALar]:CURRent[:DC]:STATistic?</code>	216
<code>MEASure[:SCALar]:POWer?</code>	216
<code>MEASure[:SCALar]:POWer:AVG?</code>	216
<code>MEASure[:SCALar]:POWer:MAX?</code>	216
<code>MEASure[:SCALar]:POWer:MIN?</code>	217
<code>MEASure[:SCALar]:POWer:STATistic?</code>	217
<code>MEASure[:SCALar][:VOLTage][:DC]?</code>	217
<code>MEASure[:SCALar][:VOLTage][:DC]:AVG?</code>	217
<code>MEASure[:SCALar][:VOLTage][:DC]:MAX?</code>	218
<code>MEASure[:SCALar][:VOLTage][:DC]:MIN?</code>	218
<code>MEASure[:SCALar][:VOLTage][:DC]:STATistic?</code>	218

READ?

Queries for the next available readback for voltage and current of the selected channel.

Example: READ? -> 1.001000E+00,0.000000E+00

Usage: Query only

MEASure[:SCALar]:ENERgy? [<Channel list>]

Queries the measured the current released energy value of the previous selected channel.

Query parameters:

<Channel list> <list>

Example: MEAS:ENER? -> 5.382E+00 (value in Wh)

Example: MEAS:ENER? (@1)
Queries the measured accumulated energy value at channel 1.

Usage: Query only

Manual operation: See "E" on page 88

MEASure[:SCALar]:STATistic:COUNt? [<Channel list>]

Returns the number of samples measured in the statistics for voltage/current/power.

Query parameters:

<Channel list> <list>

Example: MEAS:STAT:COUN? (@1)
Queries the number of measurements at channel 1.

Usage: Query only

Manual operation: See "Reset,  on page 88

MEASure[:SCALar]:STATistic:RESet [<Channel list>]

Resets the minimum, maximum and average statistic values for voltage, current, and power.

Additionally, this command resets the measured energy.

Setting parameters:

<Channel list> <list>

Example: MEAS:STAT:RES (@1)
Resets all the statistic values at channel 1.

Usage: Setting only

Manual operation: See "Reset Statistics" on page 87
See "Reset,  on page 88

MEASure[:SCALar]:CURRent[:DC]? [<Channel list>]

Queries the currently measured current of the selected channel.

Query parameters:

<Channel list> <list>

Example: MEAS:CURR? -> 1.000E +00

Example: MEAS:CURR? (@1)
Queries the currently measured current at channel 1.

Usage: Query only

MEASure[:SCALar]:CURRent[:DC]:AVG? [<Channel list>]

Queries the average measured output current.

Query parameters:

<Channel list> <list>

Example: MEAS:CURR? (@1)
Queries the currently measured current at channel 1.

Usage: Query only

Manual operation: See "[Avg](#)" on page 88

MEASure[:SCALar]:CURRent[:DC]:MAX? [<Channel list>]

Queries the maximum measured output current.

Query parameters:

<Channel list> <list>

Example: MEAS:CURR:DC:MAX? (@1)
Queries the maximum measured output current at channel 1.

Usage: Query only

Manual operation: See "[Max](#)" on page 88

MEASure[:SCALar]:CURRent[:DC]:MIN? [<Channel list>]

Queries the minimum measured output power.

Query parameters:

<Channel list> <list>

Example: MEAS:CURR:DC:MIN? (@1)
Queries the minimum measured output current at channel 1.

Usage: Query only

Manual operation: See "[Min](#)" on page 88

MEASure[:SCALar]:CURRent[:DC]:STATistic? [<Channel list>]

Queries the current statistics of the selected channel.

Query parameters:

<Channel list> <list>

Example: MEAS:CURR:DC:STAT? (@1)
Queries the current statistics at channel 1.

Usage: Query only

MEASure[:SCALar]:POWER? [<Channel list>]

Queries the currently emitted power of the selected channel.

Query parameters:

<Channel list> <list>

Example: MEAS:POW? -> 3.00E+00

Example: MEAS:POW? (@1)
Queries the currently supplied power at channel 1.

Usage: Query only

MEASure[:SCALar]:POWER:AVG? [<Channel list>]

Queries the average measured output power.

Query parameters:

<Channel list> <list>

Example: MEAS:POW:AVG? (@1)
Queries the average measured output power at channel 1.

Usage: Query only

Manual operation: See "[Avg](#)" on page 88

MEASure[:SCALar]:POWER:MAX? [<Channel list>]

Queries the maximum measured output power.

Query parameters:

<Channel list> <list>

Example: MEAS:POW:MAX? (@1)
Queries the maximum measured output power at channel 1.

Usage: Query only

Manual operation: See "[Max](#)" on page 88

MEASure[:SCALar]:POWER:MIN? [<Channel list>]

Queries the minimum measured output power.

Query parameters:

<Channel list> <list>

Example: MEAS:POW:MIN? (@1)
Queries the minimum measured output power at channel 1.

Usage: Query only

Manual operation: See "[Min](#)" on page 88

MEASure[:SCALar]:POWER:STATistic? [<Channel list>]

Queries the power statistics of the selected channel.

Query parameters:

<Channel list> <list>

Example: MEAS:POW:STAT? (@1)
Queries the power statistics at channel 1.

Usage: Query only

MEASure[:SCALar][:VOLTage][:DC]? [<Channel list>]

Queries the currently measured voltage of the selected channel.

Query parameters:

<Channel list> <list>

Example: MEAS:VOLT? -> 1.000E+00

Example: MEAS:VOLT? (@1)
Queries the currently measured voltage at channel 1.

Usage: Query only

MEASure[:SCALar][:VOLTage][:DC]:AVG? [<Channel list>]

Queries the average measured output voltage.

Query parameters:

<Channel list> <list>

Example: MEAS:VOLT:AVG? (@1)
Queries the average measured output voltage at channel 1.

Usage: Query only

Manual operation: See "[Avg](#)" on page 88

MEASure[:SCALar][:VOLTage][:DC]:MAX? [<Channel list>]

Queries the maximum measured output voltage.

Query parameters:

<Channel list> <list>

Example:

MEAS:VOLT:MAX? (@1)

Queries the maximum measured output voltage at channel 1.

Usage:

Query only

Manual operation: See "[Max](#)" on page 88

MEASure[:SCALar][:VOLTage][:DC]:MIN? [<Channel list>]

Queries the minimum measured output voltage.

Query parameters:

<Channel list> <list>

Example:

MEAS:VOLT:MIN? (@1)

Queries the maximum measured output voltage at channel 1.

Usage:

Query only

Manual operation: See "[Min](#)" on page 88

MEASure[:SCALar][:VOLTage][:DC]:STATistic? [<Channel list>]

Queries the voltage statistics of the selected channel.

Query parameters:

<Channel list> <list>

Example:

MEAS:VOLT:STAT? (@1)

Queries the voltage statistics at channel 1.

Usage:

Query only

9.7 Advanced operating commands

The following shows the subsystem that contains the commands for configuring the [QuickArb](#), [EasyRamp](#), [Analog Input](#) and [Adjustment](#) functions.

9.7.1 Arbitrary

The `ARBITrary` subsystem contains the commands for configuring an arbitrary sequence for the output channels.

Example: Configuring an arbitrary sequence

This programming example generates an arbitrary sequence for a selected channel. The sequence starts at 1 V and 1 A for 1 sec, and both values are incremented each second by 1. The generated arbitrary waveform is transferred to Ch1. When activated, the R&S NGP800 provides the arbitrary waveform at the output of the selected channel, and repeats it 10 times.

```
// *****
// Define and start the arbitrary sequence
// *****
// selects channel 1
INST OUT1
// defines the sequence, i.e. starting at 1V, 1A for 1sec,
// and increments the voltage and current each second by 1
ARB:BLOC:DATA 1,1,1,0,2,2,1,0,3,3,1,0
// ARB:BLOC:DATA? queries the arb data
// sets the repetition rate
ARB:BLOC:REP 1
// queries the set number of repetitions
// ARB:BLOC:REP?
//sets the sequence repetition
ARB:SEQ:REP 10
// queries the set number of sequence repetitions
//ARB:SEQ:REP?
//sets the arbitrary endpoint behavior, when the QuickArb function is finished
ARB:SEQ:BEH:END HOLD
// queries the endpoint behavior
//ARB:SEQ:BEH:END?
// transfers the arbitrary points to channel
ARB:SEQ:TRAN
//Enable the arbitrary sequence
ARB ON
//ARB? queries the arb status
// starts the sequence in channel 1
//turns on the output
OUTP ON
```

ARbitrary:BLOCK:CLEAr.....	220
ARbitrary:BLOCK.....	220
ARbitrary:BLOCK:DATA.....	220
ARbitrary:BLOCK:ENDPoint?.....	221
ARbitrary:BLOCK:FNAME.....	221
ARbitrary:BLOCK:REPetitions.....	221
ARbitrary[::STATe].....	222
ARbitrary:CLEAr.....	222
ARbitrary:DATA.....	222
ARbitrary:SEQuence:ENDPoint?.....	223
ARbitrary:FNAME.....	223
ARbitrary:LOAD.....	223
ARbitrary:REPetitions.....	224

ARbitrary:SAVE.....	224
ARbitrary:SEquence:BEHavior:END.....	224
ARbitrary:SEquence:CLEar.....	225
ARbitrary:SEquence:REPetitions.....	225
ARbitrary:SEquence:TRANsfer.....	225
ARbitrary:TRIGgered:GROup[:STATe].....	225
ARbitrary:TRIGgered:POINt[:STATe].....	226
ARbitrary:TRIGgered[:STATe].....	226

ARbitrary:BLOCK:CLEar

Clears a file selected for the block under channel arbitrary settings.

See also [ARbitrary:BLOCK](#) on page 220.

Example:

```
INST OUT1
ARB:BLOC 1
ARB:BLCK:CLE
Clear the file in block 1 for Ch 1.
```

Usage: Event

Manual operation: See "[Delete, !\[\]\(acae3d82a2827fc6a290f08275511b0c_img.jpg\)](#)" on page 97

ARbitrary:BLOCK <arg0>

ARbitrary:BLOCK?

Sets or queries block number between 1 to 8 in an arbitrary sequence.

Parameters:

<block> 1..8

Manual operation: See "[#"](#)" on page 97

ARbitrary:BLOCK:DATA <arg0>

ARbitrary:BLOCK:DATA?

Sets or queries the data points for a whole block.

Parameters:

<data> voltage1, current1, time1, interpolation mode1, voltage2, current2, time2, interpolation mode2, ...

Voltage and current settings depending on the instrument type. If the interpolation mode is sets to 1, it indicates that the mode is activated. If the interpolation mode is sets to 0, it indicates that the mode is not activated.

Example:

```
INST OUT1
ARB:BLOC 1
ARB:BLOC:DATA 1,1,1,0,2,2,1,0,3,3,1,0
3 data points (voltage, current, time, interpolation) are written to data block 1, Ch 1.
```

ARbitrary:BLOCK:ENDPoint?

Queries the number of data points of the block of arbitrary data.

Example: INST OUT1
 ARB:BLOC 1
 ARB:BLOC:ENDP?
 Return the number of data points for block 1 of Ch 1.

Usage: Query only

ARbitrary:BLOCK:FNAME <arg0>[, <arg1>]**ARbitrary:BLOCK:FNAME?**

Sets or queries the filename for block of arbitrary data.

Parameters for setting and query:

<filename> Filename of the QuickArb function.

<location> INT | EXT | DEF

INT

Internal memory.

EXT

USB stick.

DEF

Internal memory.

Example: INST OUT1
 ARB:BLOC 1
 ARB:BLOC:FNAME "01.CSV"
 ARB:BLOC:FNAME? -> "01.CSV", INT

Manual operation: See "[File](#)" on page 98

ARbitrary:BLOCK:REPetitions <arg0>**ARbitrary:BLOCK:REPetitions?**

Sets or queries the number of repetitions of the block of arbitrary data.

Parameters:

<repetitions> Repetition of the block of arbitrary data.

Example: INST OUT1
 ARB:BLOC 1
 ARB:BLOC:REP 0
 Set repetition of infinity to block 1 of Ch 1.

Manual operation: See "[Repetitions](#)" on page 98

ARbitrary:STATe] <arg0>[, <Channel list>]
ARbitrary:STATe]? [<Channel list>]

Sets or queries the QuickArb function for the previous selected channel.

Parameters:

<state> **1**
 QuickArb function is activated.
 0
 QuickArb function is deactivated.
 *RST: 0

Parameters for setting and query:

<Channel list> <list>

Example: ARB ON
 ARB? -> 1
 QuickArb function of Ch1 is activated.
 See [Example "Configuring an arbitrary sequence"](#) on page 219.

Example: ARB ON, (@1)
 ARB? (@1)
 Sets and queries the state of QuickArb function at channel 1.

Manual operation: See ["Arbitrary"](#) on page 58

ARbitrary:CLEar

Clears the previous defined arbitrary waveform data for the selected channel.

Example: See [Example "Configuring an arbitrary sequence"](#) on page 219.

Usage: Event

ARbitrary:DATA <arg0>

ARbitrary:DATA?

Sets or queries the arbitrary points for the previous selected channel. Max. 1024 arbitrary points can be defined. The dwell time between 2 arbitrary points is specified from 1 ms to 60 ms.

Parameters:

<data> voltage1, current1, time1, interpolation mode1, voltage2, current2, time2, interpolation mode2, ...
 Voltage and current settings depending on the instrument type. If the interpolation mode is sets to 1, it indicates that the mode is activated. If the interpolation mode is sets to 0, it indicates that the mode is not activated.

- Example:** `ARB:DATA 10,1,0.5,0`
 Defines one arbitrary point with: Voltage1 = 10 V and Current1 = 1 A, Time1 = 500 ms and Interpolation mode1 = 0 (disabled).
`ARB:DATA? -> 10.000, 1.000, 0.50, 1`
 Returns defined arbitrary points for the previous selected channel.
 See [Example "Configuring an arbitrary sequence"](#) on page 219.
- Manual operation:** See ["+, +"](#) on page 98
 See ["-, -"](#) on page 99
 See ["#"](#) on page 99
 See ["Voltage"](#) on page 99
 See ["Current"](#) on page 99
 See ["Time"](#) on page 99
 See ["Interpolate"](#) on page 99

ARbitrary:SEquence:ENDPoint?

Queries the total number of points of the arbitrary sequence.

Usage: Query only

ARbitrary:FNAME <arg0>[, <arg1>]

ARbitrary:FNAME?

Sets or queries the filename and storage location for the QuickArb function.

Parameters for setting and query:

<filename> Filename of the QuickArb function.

<location> INT | EXT | DEF

INT

Internal memory.

EXT

USB stick.

DEF

Internal memory.

Example: `ARB:FNAME "01.CSV"`
`ARB:FNAME? -> "01.CSV", INT`

Manual operation: See ["Open folder"](#) on page 98

ARbitrary:LOAD

Loads an arbitrary table from a file (filename specified with `ARB:FNAME`).

Example: ARB:DATA 10,1,0.5,0
 ARB:REP 10
 ARB:FNAM "ARB03.CSV",INT
 ARB:SAVE
 ARB:LOAD
 Loads an arbitrary data from filename ARB03.CSV.

Usage: Event

Manual operation: See "[Open folder](#)" on page 98

ARbitrary:REPetitions <arg0> ARbitrary:REPetitions?

Sets or queries the repetition rate of the defined arbitrary waveform for the previous selected channel. Up to 65535 repetitions are possible. If the repetition rate "0" is selected the arbitrary waveform of the previous selected channel is repeated infinitely.

Parameters:

repetition_rate Range: 0 to 65535
 The "0" indicates infinite repetition.

Example: ARB:REP 10
 ARB:REP? -> 10
 The returned repetition rate of the Ch1 arbitrary waveform is 10.

Manual operation: See "[Rep.](#)" on page 98

ARbitrary:SAVE

Saves the current arbitrary table to a file (filename specified with ARB:FNAM).

Example: ARB:DATA 10,1,0.5,0
 ARB:REP 10
 ARB:FNAM "ARB03.CSV",INT
 ARB:SAVE
 Saves a predefined arbitrary data to a filename ARB03.CSV in the internal memory location.

Usage: Event

Manual operation: See "[Save / Save as](#)" on page 98

ARbitrary:SEquence:BEHavior:END <arg0> ARbitrary:SEquence:BEHavior:END?

Sets or queries the arbitrary endpoint behavior, when QuickArb function is finished.

Parameters:

<state> HOLD | OFF

OFF

If the QuickArb function is finished, the respective channel is deactivated automatically.

HOLD

If the QuickArb function is finished, the last arbitrary point of the user-defined arbitrary list is held.

*RST: OFF

Example: See [Example "Configuring an arbitrary sequence"](#) on page 219.

Manual operation: See ["End Behavior"](#) on page 97

ARbitrary:SEquence:CLEar

Clears the arbitrary sequence.

Usage: Event

Manual operation: See ["Delete, !\[\]\(da2ce5f32889f06fd2b80883550ab4cb_img.jpg\)](#)" on page 97

ARbitrary:SEquence:REPetitions <arg0>**ARbitrary:SEquence:REPetitions?**

Sets or queries the number of repetitions of the arbitrary sequence.

Parameters:

<repetition_rate> Range: 0 to 65535
The "0" indicates infinite repetition.

Example: See also [ARbitrary:REPetitions](#) on page 224.

Manual operation: See ["Seq. Rep."](#) on page 97

ARbitrary:SEquence:TRANsfer

Transfers the defined arbitrary table to the selected channel.

Example: See [Example "Configuring an arbitrary sequence"](#) on page 219.

Usage: Event

Manual operation: See ["Load Sequence"](#) on page 97

ARbitrary:TRIGgered:GROup[:STATe] <arg0>**ARbitrary:TRIGgered:GROup[:STATe]?**

Sets or queries the trigger condition of the arbitrary step group for the selected channel.

Parameters:

<condition> OFF | 1 | 2 | 3 | 4 | 5 | 6 | 7 | 8

OFF

There is no DIO pin that has a mode set to arbitrary step group for the selected channel.

1 | 2 | 3 | 4 | 5 | 6 | 7 | 8

DIO pin/s are enabled with a mode set to arbitrary step group for the selected channel.

When DIO pin is enabled with arbitrary step point mode, Quick-Arb function will step to the next point when the correct voltage is applied to the DIO pin.

Manual operation: See "[Mode](#)" on page 85

ARbitrary:TRIGgered:POINT[:STATe] <arg0>

ARbitrary:TRIGgered:POINT[:STATe]?

Sets or queries the trigger condition of the arbitrary step point for the selected channel.

Parameters:

<condition> OFF | 1 | 2 | 3 | 4 | 5 | 6 | 7 | 8

OFF

There is no DIO pin that has a mode set to arbitrary step point for the selected channel.

1 | 2 | 3 | 4 | 5 | 6 | 7 | 8

DIO pin/s are enabled with a mode set to arbitrary step point for the selected channel.

When DIO pin is enabled with arbitrary step point mode, Quick-Arb function will step to the next point when the correct voltage is applied to the DIO pin.

Manual operation: See "[Mode](#)" on page 85

ARbitrary:TRIGgered[:STATe] <arg0>

ARbitrary:TRIGgered[:STATe]?

Sets or queries the trigger condition of the arbitrary for the selected channel.

Parameters:

<condition> OFF | 1 | 2 | 3 | 4 | 5 | 6 | 7 | 8

OFF

There is no DIO pin that has a mode set to arbitrary for the selected channel.

1 | 2 | 3 | 4 | 5 | 6 | 7 | 8

DIO pin/s are enabled with a mode set to arbitrary for the selected channel.

When DIO pin is enabled with arbitrary mode, QuickArb function of the channel assigned to that pin will be enabled when the correct voltage is applied to the DIO pin.

Manual operation: See "[Mode](#)" on page 85

9.7.2 EasyRamp

The VOLTage:RAMP subsystem contains the commands for configuring the EasyRamp function for the output channels.

[SOURce:]VOLTage:RAMP[:STATe].....	227
[SOURce:]VOLTage:RAMP:DURation.....	227

[SOURce:]VOLTage:RAMP[:STATe] <arg0>[, <Channel list>]
[SOURce:]VOLTage:RAMP[:STATe]? [<Channel list>]

Sets or queries the state of ramp function for the previous selected channel.

Parameters:

<state> 0 | 1
0
 EasyRamp function is deactivated.
1
 EasyRamp function is activated.
 *RST: 0

Parameters for setting and query:

<Channel list> <list>

Example: INST OUT1
 VOLT:RAMP ON
 VOLT:RAMP? -> 1
 EasyRamp function of Ch1 is activated.

Example: VOLT:RAMP ON, (@1)
 VOLT:RAMP? (@1)
 Sets and queries the state of ramp function at channel 1.

Manual operation: See "Ramp" on page 58
 See "Enable" on page 101

[SOURce:]VOLTage:RAMP:DURation <arg0>[, <Channel list>]
[SOURce:]VOLTage:RAMP:DURation? [<Channel list>]

Sets or queries the duration of the voltage ramp.

Parameters:

<duration> <numeric value> | MIN | MINimum | MAX | MAXimum | DEF |
 DEFault
<numeric value>
 Duration of the ramp function in seconds.
MIN | MINimum
 Minimum duration of the ramp function at 0.00 s.
MAX | MAXimum
 Maximum duration of the ramp function at 60.00 s.

DEF | DEFault

Default duration of the ramp function at 0 s.

Range: 0, 0.01 to 60

*RST: 0

Default unit: s

Parameters for setting and query:

<Channel list> <list>

Example:

VOLT:RAMP:DUR 4

VOLT:RAMP:DUR? -> 4

Duration of the ramp function is set at 4 s.

Example:

VOLT:RAMP:DUR 4, (@1)

VOLT:RAMP:DUR? (@1)

Sets and queries the duration of ramp function at channel 1.

Manual operation: See "[Ramp Time](#)" on page 101

9.7.3 Analog input

The VOLTage:AINPut subsystem contains the commands for configuring the analog input.

[SOURce:]VOLTage:AINPut:INPut.....	228
[SOURce:]VOLTage:AINPut:TRIGgered[:STATe].....	229
[SOURce:]VOLTage:AINPut[:STATe].....	229

[SOURce:]VOLTage:AINPut:INPut <arg0>[, <Channel list>]

[SOURce:]VOLTage:AINPut:INPut? [<Channel list>]

Sets or queries the analog input mode.

Parameters:

<input> VOLT | CURR | <list>

VOLT

Voltage mode.

CURR

Current mode.

Parameters for setting and query:

<Channel list> <list>

Example:

VOLT:AINP:INP? (@1)

Queries the analog input mode at channel 1.

Manual operation: See "[Type](#)" on page 73

[SOURce:]VOLTage:AINPut:TRIGgered[:STATe] <arg0>
[SOURce:]VOLTage:AINPut:TRIGgered[:STATe]?

Sets or queries the trigger condition of the analog input for the selected channel.

Parameters:

<condition> OFF | 1 | 2 | 3 | 4 | 5 | 6 | 7 | 8

OFF

There is no DIO pin that has a mode set to Analog In for the selected channel.

1 | 2 | 3 | 4 | 5 | 6 | 7 | 8

DIO pin/s are enabled with a mode set to Analog In for the selected channel.

When DIO pin is enabled with Analog In mode, analog input of the channel assigned to that pin will be enabled when the correct voltage is applied to the DIO pin.

Manual operation: See "Enabled" on page 73
 See "Mode" on page 85

[SOURce:]VOLTage:AINPut[:STATe] <arg0>[, <Channel list>]
[SOURce:]VOLTage:AINPut[:STATe]? [<Channel list>]

Enables or disables the analog input for the selected channel.

Parameters:

<arg0> **1**
 Analog input for selected channel is enabled.
 0
 Analog input for selected channel is disabled.

Parameters for setting and query:

<Channel list> <list>

Example: VOLT:AINP? (@1)
 Queries the analog input state at channel 1.

Manual operation: See "Enabled" on page 73

9.7.4 Adjustment

The CALibration subsystem contains the commands for analog input and channel adjustment.

CALibration:AINPut:CANCel.....	230
CALibration:AINPut:COUNT?.....	230
CALibration:AINPut:DATA.....	230
CALibration:AINPut:DATE?.....	230
CALibration:AINPut:END.....	231
CALibration:AINPut:FACTory:RESTore.....	231
CALibration:AINPut:SAVE.....	231

CALibration:AINPut:START	231
CALibration:AINPut:STATe?	231
CALibration:AINPut:UMAX	232
CALibration:AINPut:UMIN	232
CALibration:CANcEl	232
CALibration:COUNt?	232
CALibration:CURRent:DATA	232
CALibration:CURRent:IMAX	233
CALibration:CURRent:IMIN	233
CALibration:DATE?	233
CALibration:END	233
CALibration:FACTory:RESToRe	233
CALibration:SAVE	233
CALibration:STATe?	234
CALibration:TEMPerature?	234
CALibration:USER	234
CALibration:VOLTage:DATA	234
CALibration:VOLTage:UMAX	235
CALibration:VOLTage:UMIN	235

CALibration:AINPut:CANcEl

Cancels the analog input adjustment.

Usage: Event

Manual operation: See "[User Adjustment](#)" on page 108

CALibration:AINPut:COUNt?

Queries the number of counts performed for analog input adjustment.

Usage: Query only

Manual operation: See "[User Adjustment](#)" on page 108

CALibration:AINPut:DATA <arg0>

CALibration:AINPut:DATA?

Sets or queries the analog input adjustment data.

Parameters:

<data> Measured value from DMM.

Manual operation: See "[User Adjustment](#)" on page 108

CALibration:AINPut:DATE?

Returns the analog input adjustment date ("DD-MM-YY").

Usage: Query only

CALibration:AINPut:END

Ends the analog input adjustment.

Usage: Event

Manual operation: See "[User Adjustment](#)" on page 108

CALibration:AINPut:FACTory:RESTore

Restores the analog input factory adjustment.

Usage: Event

Manual operation: See "[Restore Factory Adjustment](#)" on page 109

CALibration:AINPut:SAVE

Saves the analog input adjustment.

Usage: Event

Manual operation: See "[User Adjustment](#)" on page 108

CALibration:AINPut:START <arg0>

Selects the analog input pin for adjustment.

Setting parameters:

<pin> Input pin for adjustment.

Range: 1 to 4

Manual operation: See "[User Adjustment](#)" on page 108

CALibration:AINPut:STATe?

Queries the analog input adjustment state.

State	Descriptions
0-15	0x0 - 0xF (0b0000 - 0b1111) bit3 bit2 bit1 bit0 bit0 - pin 1 of analog input bit1 - pin 2 of analog input bit2 - pin 3 of analog input bit3 - pin 4 of analog input e.g. 15 - All analog input pins are adjusted. e.g. 9 - Pin 1 and pin 4 are adjusted.
16	Idle

State	Descriptions
17	Busy
18	Waiting

Example:

```
CAL:AINP:STAT? -> 9
```

Pin 1 and pin 4 are adjusted successful.

Usage: Query only

Manual operation: See "[User Adjustment](#)" on page 108

CALibration:AINPut:UMAX

Sets output voltage to high value 100 % of Vmax for analog input pin during adjustment.

Usage: Event

Manual operation: See "[User Adjustment](#)" on page 108

CALibration:AINPut:UMIN

Sets the output voltage to low value 1 % of Vmax for analog input pin during adjustment.

Usage: Event

Manual operation: See "[User Adjustment](#)" on page 108

CALibration:CANCel

Cancels the channel adjustment.

Usage: Event

Manual operation: See "[User Adjustment](#)" on page 112

CALibration:COUNT?

Queries the number of counts that the channel adjustment performed successfully.

Usage: Query only

Manual operation: See "[User Adjustment](#)" on page 112

CALibration:CURRent:DATA <arg0>**CALibration:CURRent:DATA?**

Sets or queries the DMM reading after setting the output current level in channel adjustment process.

Parameters:

<current> Measured value from DMM.

Manual operation: See "[User Adjustment](#)" on page 112

CALibration:CURRENT:IMAX

Sets the output current to high value 100 % of I_{max} during current adjustment.

Usage: Event

Manual operation: See "[User Adjustment](#)" on page 112

CALibration:CURRENT:IMIN

Sets the output current to low value 1 % of I_{max} during current adjustment.

Usage: Event

Manual operation: See "[User Adjustment](#)" on page 112

CALibration:DATE?

Returns the channel adjustment date.

Usage: Query only

Manual operation: See "[User Adjustment](#)" on page 112

CALibration:END

Ends the channel adjustment.

Usage: Event

Manual operation: See "[User Adjustment](#)" on page 112

CALibration:FACTory:RESTore

Restores the factory channel adjustment.

Usage: Event

Manual operation: See "[Restore Factory Adjustment](#)" on page 112

CALibration:SAVE

Saves the channel adjustment.

Usage: Event

Manual operation: See "[User Adjustment](#)" on page 112

CALibration:STATe?

Returns the current state of channel adjustment.

State	Descriptions
0	Idle
1	Busy
2	Waiting
12	Voltage adjustment completed
13	Current adjustment completed
16	Successful channel adjustment
17	Failed channel adjustment

Example: `CAL:STAT? -> 12`
Voltage adjustment is completed.

Usage: Query only

Manual operation: See "[User Adjustment](#)" on page 112

CALibration:TEMPerature?

Returns the temperature of selected channel.

Usage: Query only

Manual operation: See "[Temperatures in °C](#)" on page 130
See "[Misc](#)" on page 130

CALibration:USER

Starts the channel adjustment process.

Usage: Event

Manual operation: See "[User Adjustment](#)" on page 112

CALibration:VOLTage:DATA <arg0>
CALibration:VOLTage:DATA?

Sets or queries the DMM reading after setting the output voltage level in channel adjustment process.

Parameters:

<voltage> Measured value from DMM.

Manual operation: See "[User Adjustment](#)" on page 112

CALibration:VOLTage:UMAX

Sets the output voltage to high value 100 % of Vmax during voltage adjustment.

Usage: Event

Manual operation: See "[User Adjustment](#)" on page 112

CALibration:VOLTage:UMIN

Sets the output voltage to low value 1 % of Vmax during voltage adjustment.

Usage: Event

Manual operation: See "[User Adjustment](#)" on page 112

9.8 Data and file management commands

The `DATA` and `HCOPY` subsystem contain commands for managing the files in the instrument and external USB stick.

The `LOG` subsystem contains the commands for managing the data logging of the instrument.

<code>DATA:DATA?</code>	235
<code>DATA:DELeTe</code>	236
<code>DATA:LIST?</code>	236
<code>DATA:POINts?</code>	236
<code>HCOPY:DATA?</code>	237
<code>HCOPY:SIZE:X?</code>	237
<code>HCOPY:SIZE:Y?</code>	237
<code>LOG[:STATe]</code>	237
<code>LOG:COUNT</code>	238
<code>LOG:DATA?</code>	238
<code>LOG:DURation</code>	239
<code>LOG:FNAME?</code>	239
<code>LOG:INTerval</code>	239
<code>LOG:LOCation</code>	240
<code>LOG:MODE</code>	240
<code>LOG:STIMe</code>	241
<code>LOG:TRIGgered[:STATe]</code>	241

DATA:DATA? <arg0>

Returns the logging file data of the selected file.

If manual trigger mode (trigger via TRIG function) is used, the logging function has to be activated. Without activating the logging function in the manual trigger mode, the instrument is not able to save a logging file internally or on the USB stick.

Query parameters:

<filepath> Filepath of the logging file data.

Example:

```
DATA:DATA?
"/int/logging/log-20201203T095013.965.csv" ->
#Device,NGP802
#Calibration Ch1,factory
Timestamp,U1[V],I1[A],P1[W]
09:50:14.078,2.0003,0.00007,0.00013
09:50:14.177,2.0003,0.00007,0.00014
09:50:14.278,2.0003,0.00007,0.00014
09:50:14.376,2.0003,0.00008,0.00016
09:50:14.477,2.0003,0.00008,0.00015
09:50:14.575,2.0003,0.00008,0.00017
```

Usage: Query only

DATA:DELeTe <arg0>

Deletes the specified file from memory.

Setting parameters:

<filepath> Filepath of the file.

Example:

```
DATA:DEL
"/int/logging/log-20201203T095013.965.csv"
Deletes internal logging file 'log-20201203T095013.965.csv'.
```

Usage: Setting only

Manual operation: See "[Delete](#)",  on page 115

DATA:LIST?

Queries all files in internal memory ('/int/') and external memory ('/USB').

Example:

```
DATA:LIST? -> "/USB1A/NGP/logging/
log-20201203T101025.829.csv", "/int/arb/
newWaveform.csv", "/int/logging/log-20201203T101129.818.csv"
```

Usage: Query only

DATA:POINts? <arg0>

Queries the number of measurements from the selected logging file.

If manual trigger mode (trigger via TRIG function) is used, the logging function has to be activated. Without activating the logging function in the manual trigger mode, the instrument is not able to save a logging file internally or on the USB stick.

Query parameters:

<filepath> Filepath of the logging file data.

Example: DATA:POIN?
 "/USB1A/NGP/logging/log-20201203T101025.829.csv"
 -> 5
 Returns 5 log files counts from "/USB1A/NGP/logging/
 log-20201203T101025.829.csv".

Usage: Query only

HCOPY:DATA?

Returns the actual display content (screenshot).

Usage: Query only

HCOPY:SIZE:X?

Returns the horizontal dimension of the screenshots.

Usage: Query only

HCOPY:SIZE:Y?

Returns the vertical dimension of the screenshots.

Usage: Query only

LOG[:STATE] <arg0>

LOG[:STATE]?

Sets or queries the data logging state.

Parameters:

<state> **1**
 Data logging function is enabled.
0
 Data logging function is disabled.
 *RST: 0

Example: LOG ON
 LOG? -> 1
 Data logging function is activated.

Manual operation: See "[Logging](#)" on page 56
 See "[Toggle Logging](#)" on page 87
 See "[Enabled](#)" on page 91

LOG:DURation <Set new value>[, <Return min or max>]

LOG:DURation? [<Return min or max>]

Sets or queries the duration of the data logging.

Setting parameters:

<Set new value> <numeric value> | MIN | MINimum | MAX | MAXimum

<numeric value>

Duration of the data logging captured in the range of 0 s to $3.49 \cdot 10^5$ s.

MIN | MINimum

Minimum duration of the data logging captured at 0 s.

MAX | MAXimum

Maximum duration of the data logging captured at $3.49 \cdot 10^5$ s.

Default unit: s

Parameters for setting and query:

 MIN | MINimum | MAX | MAXimum

Returns the duration of the data logging.

Example:

LOG:DUR MAX

LOG:DUR? MAX -> 349000

Manual operation: See "[Mode](#)" on page 91

LOG:FNAME?

Queries the filename and storage location for the data logging.

Example:

LOG 0

LOG:FNAME? -> ""

LOG 1

LOG:FNAME? -> "/int/logging/log-20190318T1141853.407.csv"

Enables the data logging and queries the data log filename.

Usage:

Query only

Manual operation: See "[Target Folder](#)" on page 91

LOG:INTERval <Set new value>[, <Return min or max>]

LOG:INTERval? [<Return min or max>]

Sets or queries the data logging measurement interval. The measurement interval describes the time between the recorded measurements.

Setting parameters:

<interval> <numeric value> | MIN | MINimum | MAX | MAXimum

<numeric value>

Measurement interval in the range of 0.008 s to 600 s.

MIN | MINimum

Minimum measurement interval is set at 0.008 s.

MAX | MAXimum

Maximum measurement interval is set at 600 s.

Default unit: s

Parameters for setting and query:

<Return min or max> MIN | MINimum | MAX | MAXimum

Returns the measurement interval.

Example:

LOG:INT 10

LOG:INT? -> 10

Manual operation: See "[Interval](#)" on page 91

LOG:LOCation [<>]

LOG:LOCation? [<>]

Sets or queries the logging location.

Parameters for setting and query:

<location> INT | EXT | DEF

INT

Internal location, i.e. "int/logging".

EXT

External location, i.e. "USB1A/NGP/logging".

DEF

Default location, i.e. "int/logging".

Manual operation: See "[Target Folder](#)" on page 91

LOG:MODE <arg0>

LOG:MODE? <arg0>

Sets or queries the data logging mode.

Parameters for setting and query:

<mode> UNLlimited | COUNT | DURation | SPAN

UNLlimited

Infinite data capture.

COUNT

Number of measurement values to be captured.

DURation

Duration of the measurement values capture.

SPAN

Interval of the measurement values capture.

Example:

LOG:MODE DUR

LOG:MODE? -> DUR

Manual operation: See "[Mode](#)" on page 91

LOG:STIMe <Year>, <Month>, <Day>, <Hour>, <Minute>, <Second>
LOG:STIMe?

Sets or queries the start time of the data logging function.

Setting parameters:

<Year>	Sets the year for the data logging function.
<Month>	Sets the month for the data logging function.
<Day>	Sets the day for the data logging function.
<Hour>	Sets the hour for the data logging function.
<Minute>	Sets the minute for the data logging function.
<Second>	Sets the second for the data logging function.

Example: LOG:STIM 2018,08,18,08,18,18
 LOG:STIM? -> 2018,08,18,08,18,18

Manual operation: See "[Mode](#)" on page 91

LOG:TRIGgered[:STATe] <arg0>
LOG:TRIGgered[:STATe]?

Sets or queries the trigger conditions for logging.

Parameters:

<condition>	OFF 1 2 3 4 5 6 7 8
-------------	-------------------------------------

OFF
 There is no DIO pin that has a mode set to logging.

1 | 2 | 3 | 4 | 5 | 6 | 7 | 8
 DIO pin/s are enabled with a mode set to logging.
 When DIO pin is enabled with logging mode, logging of the channel assigned to that pin will be enabled when the correct voltage is applied to the DIO pin.

Manual operation: See "[Mode](#)" on page 85

9.9 Status reporting commands

The status reporting system stores all information on the present operating state of the instrument, and on errors which have occurred. This information is stored in the status registers and in the error queue. The `STATUS:OPERation` and `STATUS:QUESTionable` subsystems contains commands to control the status reporting structure of the instrument.

See [Section 8.4.1, "Structure of a SCPI status register"](#), on page 159.

9.9.1 STATus:OPERation registers

The commands of the STATus:OPERation subsystem control the status reporting structures of the STATus:OPERation register.

The suffix at <Channel> selects the instrument channel. Depending on the instrument models, the range is <1...4>.

STATus:OPERation:INSTrument:CONDition?	242
STATus:OPERation:INSTrument:ISUMmary<Channel>:CONDition?	242
STATus:OPERation:INSTrument:ENABle	242
STATus:OPERation:INSTrument:ISUMmary<Channel>:ENABle	242
STATus:OPERation:INSTrument[:EVENT]?	243
STATus:OPERation:INSTrument:ISUMmary<Channel>[:EVENT]?	243
STATus:OPERation:INSTrument:NTRansition	243
STATus:OPERation:INSTrument:ISUMmary<Channel>:NTRansition	243
STATus:OPERation:INSTrument:PTRansition	243
STATus:OPERation:INSTrument:ISUMmary<Channel>:PTRansition	243

STATus:OPERation:INSTrument:CONDition?

STATus:OPERation:INSTrument:ISUMmary<Channel>:CONDition?

Returns the contents of the CONDition part of the status register to check for operation instrument or measurement states. Reading the CONDition registers does not delete the contents.

Suffix:

<Channel> 1..n

Return values:

<Condition> Condition bits in decimal representation.
Range: 1 to 65535

Usage: Query only

STATus:OPERation:INSTrument:ENABle <arg0>

STATus:OPERation:INSTrument:ENABle?

STATus:OPERation:INSTrument:ISUMmary<Channel>:ENABle <arg0>

STATus:OPERation:INSTrument:ISUMmary<Channel>:ENABle?

Controls or queries the ENABle part of the STATus:OPERation register. The ENABle defines which events in the EVENT part of the status register are forwarded to the OPERation summary bit (bit 7) of the status byte. The status byte can be used to create a service request.

Suffix:

<Channel> 1..n

Parameters:

<Enable> Range: 1 to 65535
Increment: 1

Example: `STATus:OPERation:INSTrument:ISUMmary1:ENABle?`
 Reads the enable register for the Standard Operation Register group.

STATus:OPERation:INSTrument[:EVENT]?
STATus:OPERation:INSTrument:ISUMmary<Channel>[:EVENT]?

Returns the contents of the EVENT part of the status register to check whether an event has occurred since the last reading. Reading an EVENT register deletes its contents.

Suffix:
 <Channel> 1..n

Return values:
 <Event> Range: 1 to 65535

Usage: Query only

STATus:OPERation:INSTrument:NTRansition <arg0>
STATus:OPERation:INSTrument:NTRansition?
STATus:OPERation:INSTrument:ISUMmary<Channel>:NTRansition <arg0>
STATus:OPERation:INSTrument:ISUMmary<Channel>:NTRansition?

Sets or queries the negative transition filter. Setting a bit in the negative transition filter shall cause a 1 to 0 transition in the corresponding bit of the associated condition register to cause a 1 to be written in the associated bit of the corresponding event register.

Suffix:
 <Channel> 1..n

Parameters:
 <NegativeTransition> Range: 1 to 65535

Example: `STATus:OPERation:INSTrument:ISUMmary1:NTRansition?`
 Query for negative transition.

STATus:OPERation:INSTrument:PTRansition <arg0>
STATus:OPERation:INSTrument:PTRansition?
STATus:OPERation:INSTrument:ISUMmary<Channel>:PTRansition <arg0>
STATus:OPERation:INSTrument:ISUMmary<Channel>:PTRansition?

Sets or queries the positive transition filter. Setting a bit in the positive transition filter shall cause a 0 to 1 transition in the corresponding bit of the associated condition register to cause a 1 to be written in the associated bit of the corresponding event register.

Suffix:
 <Channel> 1..n

Parameters:
 <PositiveTransition> Range: 1 to 65535

Example: `STATUS:OPERation:INSTrument:ISUMmary1:PTRansition?`
 `PTRansition?`
 Query for positive transition.

9.9.2 STATUS:QUESTIONable registers

The commands of the `STATUS:QUESTIONable` subsystem control the status reporting structures of the `STATUS:QUESTIONable` registers.

The suffix at `<Channel>` selects the instrument channel. Depending on the instrument models, the range is `<1...4>`.

<code>STATUS:QUESTIONable:INSTrument:CONDition?</code>	244
<code>STATUS:QUESTIONable:INSTrument:ISUMmary<Channel>:CONDition?</code>	244
<code>STATUS:QUESTIONable:INSTrument:ENABle</code>	244
<code>STATUS:QUESTIONable:INSTrument:ISUMmary<Channel>:ENABle</code>	244
<code>STATUS:QUESTIONable:INSTrument[:EVENTt]?</code>	245
<code>STATUS:QUESTIONable:INSTrument:ISUMmary<Channel>[:EVENTt]?</code>	245
<code>STATUS:QUESTIONable:INSTrument:NTRansition</code>	245
<code>STATUS:QUESTIONable:INSTrument:ISUMmary<Channel>:NTRansition</code>	245
<code>STATUS:QUESTIONable:INSTrument:PTRansition</code>	245
<code>STATUS:QUESTIONable:INSTrument:ISUMmary<Channel>:PTRansition</code>	245

STATUS:QUESTIONable:INSTrument:CONDition?

STATUS:QUESTIONable:INSTrument:ISUMmary<Channel>:CONDition?

Returns the contents of the `CONDition` part of the status register to check for questionable instrument or measurement states. Reading the `CONDition` registers does not delete the contents.

Suffix:

`<Channel>` 1..n

Return values:

`<Condition>` Condition bits in decimal representation.
 Range: 0 to 65535

Usage: Query only

STATUS:QUESTIONable:INSTrument:ENABle <arg0>

STATUS:QUESTIONable:INSTrument:ENABle?

STATUS:QUESTIONable:INSTrument:ISUMmary<Channel>:ENABle <arg0>

STATUS:QUESTIONable:INSTrument:ISUMmary<Channel>:ENABle?

Sets or queries the enable mask that allows true conditions in the `EVENT` part to be reported in the summary bit.

If a bit in the `ENABle` part is 1, and the corresponding `EVENT` bit is true, a positive transition occurs in the summary bit. This transition is reported to the next higher level.

Suffix:

`<Channel>` 1..n

Parameters:

<Enable_Value> Bit mask in decimal representation.
Range: 0 to 65535

Example:

```
STATus:QUEStionable:INSTRument:ISUMmary1:
ENABLe?
```

Queries the event register for the Standard QUEStionable Register group.

STATus:QUEStionable:INSTRument[:EVENT]?**STATus:QUEStionable:INSTRument:ISUMmary<Channel>[:EVENT]?**

Returns the contents of the EVENT part of the status register to check whether an event has occurred since the last reading. Reading an EVENT register deletes its contents.

Suffix:

<Channel> 1..n

Return values:

<Event> Event bits in decimal representation
Range: 0 to 65535

Usage: Query only

STATus:QUEStionable:INSTRument:NTRansition <arg0>**STATus:QUEStionable:INSTRument:NTRansition?****STATus:QUEStionable:INSTRument:ISUMmary<Channel>:NTRansition <arg0>****STATus:QUEStionable:INSTRument:ISUMmary<Channel>:NTRansition?**

Sets or queries the negative transition filter. Setting a bit in the negative transition filter shall cause a 1 to 0 transition in the corresponding bit of the associated condition register to cause a 1 to be written in the associated bit of the corresponding event register.

Suffix:

<Channel> 1..n

Parameters:

<NegativeTransition> Range: 1 to 65535

Example:

```
STATus:QUEStionable:INSTRument:ISUMmary1:
NTRansition?
```

Query for negative transition.

STATus:QUEStionable:INSTRument:PTRansition <arg0>**STATus:QUEStionable:INSTRument:PTRansition?****STATus:QUEStionable:INSTRument:ISUMmary<Channel>:PTRansition <arg0>****STATus:QUEStionable:INSTRument:ISUMmary<Channel>:PTRansition?**

Sets or queries the positive transition filter. Setting a bit in the positive transition filter shall cause a 0 to 1 transition in the corresponding bit of the associated condition register to cause a 1 to be written in the associated bit of the corresponding event register.

Suffix:

<Channel> 1..n

Parameters:

<PositiveTransition> Range: 1 to 65535

Example:

```
STATUS:QUESTIONABLE:INSTRUMENT:ISUMMARY1:
```

```
PTRANSITION?
```

Query for positive transition.

10 Troubleshooting

- [Displaying status information](#)..... 247
- [Problems during firmware update](#)..... 247
- [Problems with remote control over LAN](#).....248
- [Contacting customer support](#)..... 248

10.1 Displaying status information

The R&S NGP800 displays notifications to inform you on current settings and states. It distinguishes between status, information, warning and error notifications.

Some information and messages are entered in the error/event queue of the status reporting system, see [Section 8.4, "Status reporting system"](#), on page 159.

10.2 Problems during firmware update

The firmware update is described in [Section 7.6, "Update device"](#), on page 131.

Solutions for potential problems that can occur during firmware update are described in the following sections.

Firmware update was interrupted

If, for example, a power cut happens during the firmware update, problems can occur.

1. Perform the firmware update again. Sometimes, repeating the update fixes the problems.
2. If the R&S NGP800 still cannot be updated, contact your local service representative, see [Section 10.4, "Contacting customer support"](#), on page 248.

Firmware update was aborted

If there is not enough free memory space, the firmware update will be aborted. The instrument will display an error message.

- ▶ Start the firmware update again.

10.3 Problems with remote control over LAN

10.3.1 Cannot establish a LAN connection

If you have problems establishing a LAN connection as described in [Section 3.1.8, "Connecting to LAN"](#), on page 25:

1. Check if the TCP/IP address information is valid.
2. Assign the IP address manually, e.g. if the network does not support DHCP configuration.

10.3.2 Cannot communicate over LAN

If you have problems establishing a LAN communication:

1. Refer to the application note [1SL374: How to communicate with R&S devices using VISA](#) that provides comprehensive information on configuring the interfaces, required drivers, and testing the communication.
2. If you still have problems, contact the customer support.

10.4 Contacting customer support

Technical support – where and when you need it

For quick, expert help with any Rohde & Schwarz product, contact our customer support center. A team of highly qualified engineers provides support and works with you to find a solution to your query on any aspect of the operation, programming or applications of Rohde & Schwarz products.

Contact information

Contact our customer support center at www.rohde-schwarz.com/support, or follow this QR code:



Figure 10-1: QR code to the Rohde & Schwarz support page

11 Transport

Lifting and carrying

See "[Lifting and carrying the product](#)" on page 10.

Packing

Use the original packaging material. It consists of antistatic wrap for electrostatic protection and packing material designed for the product.

If you do not have the original packaging, use similar materials that provide the same level of protection.

Securing

When moving the product in a vehicle or using transporting equipment, make sure that the product is properly secured. Only use items intended for securing objects.

Transport altitude

Unless otherwise specified in the specifications document, the maximum transport altitude without pressure compensation is 4500 m above sea level.

12 Maintenance, storage and disposal

We advise to check the nominal data from time to time.

- [Cleaning](#).....251
- [Changing fuses](#).....251
- [Internal battery replacement](#).....251
- [Storage](#).....252
- [Disposal](#).....252

12.1 Cleaning

How to clean the product is described in "[Cleaning the product](#)" on page 13.

Do not use any liquids for cleaning. Cleaning agents, solvents, acids and bases can damage the front panel labeling, plastic parts and display.

12.2 Changing fuses

If the product does not start, it is possible that a blown fuse is the cause. The fuse is located in the socket of the power supply.

For details on changing fuses, see "[To replace the power fuse](#)" on page 23.

12.3 Internal battery replacement

An internal CR2032 coin cell battery powers the real-time clock circuit which provides continuous time stamp for the instrument. If the battery fails, the system clock and time stamp for the logging function are not available but other instrument functions are not affected.

Under normal usage at room temperature, the battery is expected to last up to 10 years. However, the battery life expectancy is reduced if the device is stored at temperature above 40°C for an extended period of time.



If the instrument cannot retain the date and time settings after turning off the AC input, the battery is discharged.

Contact your local service partner for battery replacement.

12.4 Storage

Protect the product against dust. Ensure that the environmental conditions, e.g. temperature range and climatic load, meet the values specified in the specifications document.

12.5 Disposal

Rohde & Schwarz is committed to making careful, ecologically sound use of natural resources and minimizing the environmental footprint of our products. Help us by disposing of waste in a way that causes minimum environmental impact.

Disposing of electrical and electronic equipment

A product that is labeled as follows cannot be disposed of in normal household waste after it has come to the end of its life. Even disposal via the municipal collection points for waste electrical and electronic equipment is not permitted.



Figure 12-1: Labeling in line with EU directive WEEE

Rohde & Schwarz has developed a disposal concept for the eco-friendly disposal or recycling of waste material. As a manufacturer, Rohde & Schwarz completely fulfills its obligation to take back and dispose of electrical and electronic waste. Contact your local service representative to dispose of the product.

13 Applications

For safety information, see [Section 3.1.6, "Connecting to power"](#), on page 23.

To increase output voltage and current, it is possible to operate the channels in series or parallel mode. In general, the output voltages of R&S NGP800 to be combined are independent.

13.1 Series mode

This type of interconnection adds the individual output voltages. The same current flows through all outputs. The current limits for the outputs wired in series should be set to the identical value. If one of the outputs exceeded the current limit, the total voltage will naturally collapse. See [Section 4.4, "Modes of operation"](#), on page 62.

It is recommended to set the voltages of all connected channels to a similar value in order to distribute the loads evenly (not absolutely necessary). When all four channels are connected in a series mode and if a (low resistance) load is connected; there is a chance of damaging a channel when that channel is switched off. This is due to the protection diode working as a bypass to connect the other channel in a series mode. Once the protection diode is shorted, the channel will be defective.

Therefore, it is necessary to always have all channels or no channel switched on at all.



If the instrument switches to constant current (CC) mode during a series connection, the voltage display becomes inaccurate.

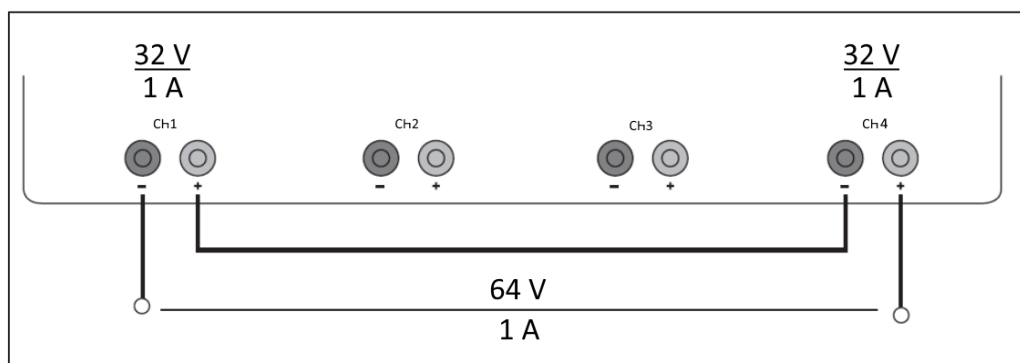

Figure 13-1: Example of series connection

13.2 Parallel mode

If it is necessary to increase the total current, the power supply outputs must be wired in parallel. The maximum total current is the sum of the individual currents of all sources connected in parallel.

The output voltages for the individual outputs should be set to the same voltage value as precisely as possible. For slight voltage differences, it is common in a parallel operating mode to first charge a voltage output up to the current limit; the other voltage output provides the remaining current. See "[Principles of operation in parallel mode](#)" on page 254.

For power supplies that are connected in parallel, it is possible that compensating currents flow within the power supplies. The use of power supplies by other manufacturers, which are potentially not overload proof, can cause destruction of these units as currents may be distributed unevenly.

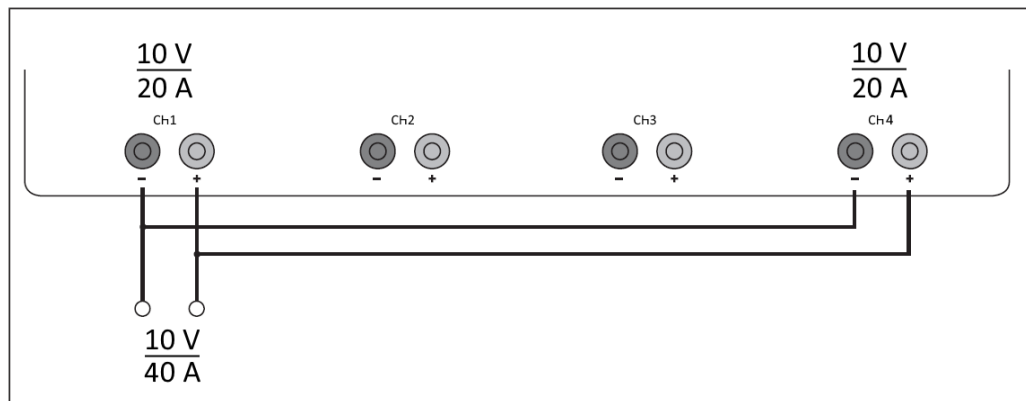

Figure 13-2: Example of parallel connection

Principles of operation in parallel mode

Generally, a higher current is first supplied from the channel with the higher output voltage. Once this channel reaches its power limit, the remaining current is made available by the channel that is connected in parallel. In this scenario, it is unpredictable which channel supplies the higher current because it is also possible for channels with identical voltage values to display a low voltage difference.

By increasing the voltage slightly, the load distribution can be manipulated. If the voltage for a channel is to be increased by 50 mV, for instance (by a set of identical cables), the current will initially be provided by this channel.

If you wish to distribute the load to multiple channels, it is recommended to set the current limit of the channel that is to supply the main current to a fraction of the current. This approach handles the semiconductor with care and improves the heat dissipation, as the power loss is distributed more evenly.

Glossary

C

CDC: USB communications device class. A composite universal serial bus device class.

D

DHCP: Dynamic host configuration protocol. A type of network management protocol used for automatically assigning IP addresses and other communication parameters to devices connected to the network.

F

FTP: File transfer protocol. A network protocol for file transfer between computers over [TCP/IP](#).

G

GPIO: General purpose interface bus, also known as IEEE 488. It is a short-range digital communications 8-bit parallel multi-master interface bus.

O

OCP: Overcurrent protection refers to a type of protection circuit that shuts down the instrument when the current exceeds the rated ampere capacity of a circuit or the connected equipment on that circuit.

OPP: Overpower protection refers to a type of protection circuit that shuts down the instrument when the output power exceeds its maximum rating.

OVP: Overvoltage protection refers to a type of protection circuit that shuts down the instrument when the voltage exceeds a preset level.

T

TCP/IP: Transmission control protocol/internet protocol connection. An internet protocol suite that allows devices in a network to communicate.

TMC: USB test and measurement class. Supports communications with test and measurement equipment.

V

VNC: Virtual network computing. A graphical desktop sharing system that uses the remote frame buffer protocol to remotely control another computer.

List of commands

[SOURce:]ALIMit[:STATe].....	185
[SOURce:]CURRent[:LEVel][:IMMediate]:ALIMit:LOWer.....	186
[SOURce:]CURRent[:LEVel][:IMMediate]:ALIMit[:UPPer].....	187
[SOURce:]CURRent[:LEVel][:IMMediate]:STEP[:INCRement].....	194
[SOURce:]CURRent[:LEVel][:IMMediate][:AMPLitude].....	194
[SOURce:]POWer:PROTection:CLEar.....	210
[SOURce:]POWer:PROTection:LEVel.....	210
[SOURce:]POWer:PROTection:TRIPped?.....	211
[SOURce:]POWer:PROTection[:STATe].....	209
[SOURce:]PROTection:CLEar.....	211
[SOURce:]VOLTage:AINPut:INPut.....	228
[SOURce:]VOLTage:AINPut:TRIGgered[:STATe].....	229
[SOURce:]VOLTage:AINPut[:STATe].....	229
[SOURce:]VOLTage:PROTection:CLEar.....	207
[SOURce:]VOLTage:PROTection:LEVel.....	207
[SOURce:]VOLTage:PROTection:TRIPped?.....	208
[SOURce:]VOLTage:PROTection[:STATe].....	207
[SOURce:]VOLTage:RAMP:DURation.....	227
[SOURce:]VOLTage:RAMP[:STATe].....	227
[SOURce:]VOLTage:SENSe:TRIPped:CLEar.....	188
[SOURce:]VOLTage:SENSe:TRIPped?.....	188
[SOURce:]VOLTage:SENSe[:SOURce].....	187
[SOURce:]VOLTage[:LEVel][:IMMediate]:ALIMit:LOWer.....	185
[SOURce:]VOLTage[:LEVel][:IMMediate]:ALIMit[:UPPer].....	186
[SOURce:]VOLTage[:LEVel][:IMMediate]:STEP[:INCRement].....	192
[SOURce:]VOLTage[:LEVel][:IMMediate][:AMPLitude].....	191
*CLS.....	165
*ESE.....	165
*ESR?.....	166
*IDN?.....	166
*OPC.....	166
*OPT?.....	166
*RCL.....	168
*RST.....	166
*SAV.....	168
*SRE.....	167
*STB?.....	167
*TST?.....	167
*WAI.....	167
APPLy.....	195
ARBitrary:BLOCK.....	220
ARBitrary:BLOCK:CLEar.....	220
ARBitrary:BLOCK:DATA.....	220
ARBitrary:BLOCK:ENDPoint?.....	221
ARBitrary:BLOCK:FNAME.....	221
ARBitrary:BLOCK:REPetitions.....	221
ARBitrary:CLEar.....	222

ARbitrary:DATA.....	222
ARbitrary:FNAME.....	223
ARbitrary:LOAD.....	223
ARbitrary:REPetitions.....	224
ARbitrary:SAVE.....	224
ARbitrary:SEQuence:BEHavior:END.....	224
ARbitrary:SEQuence:CLEar.....	225
ARbitrary:SEQuence:ENDPoint?.....	223
ARbitrary:SEQuence:REPetitions.....	225
ARbitrary:SEQuence:TRANsfer.....	225
ARbitrary:TRIGgered:GROup[:STATE].....	225
ARbitrary:TRIGgered:POINt[:STATE].....	226
ARbitrary:TRIGgered[:STATE].....	226
ARbitrary[:STATE].....	222
CALibration:AINPut:CANCel.....	230
CALibration:AINPut:COUNt?.....	230
CALibration:AINPut:DATA.....	230
CALibration:AINPut:DATE?.....	230
CALibration:AINPut:END.....	231
CALibration:AINPut:FACTory:RESTore.....	231
CALibration:AINPut:SAVE.....	231
CALibration:AINPut:START.....	231
CALibration:AINPut:STATe?.....	231
CALibration:AINPut:UMAX.....	232
CALibration:AINPut:UMIN.....	232
CALibration:CANCel.....	232
CALibration:COUNt?.....	232
CALibration:CURREnt:DATA.....	232
CALibration:CURREnt:IMAX.....	233
CALibration:CURREnt:IMIN.....	233
CALibration:DATE?.....	233
CALibration:END.....	233
CALibration:FACTory:RESTore.....	233
CALibration:SAVE.....	233
CALibration:STATe?.....	234
CALibration:TEMPerature?.....	234
CALibration:USER.....	234
CALibration:VOLTage:DATA.....	234
CALibration:VOLTage:UMAX.....	235
CALibration:VOLTage:UMIN.....	235
DATA:DATA?.....	235
DATA:DELeTe.....	236
DATA:LIST?.....	236
DATA:POINts?.....	236
DISPlay:BRIGhtness.....	176
DISPlay[:WINDow]:TEXT:CLEar.....	177
DISPlay[:WINDow]:TEXT[:DATA].....	177
FUSE:DELAy:INITIAL.....	203
FUSE:DELAy[:BLOWing].....	203
FUSE:LINK.....	204

FUSE:TRIPped:CLear.....	202
FUSE:TRIPped?.....	204
FUSE:UNLink.....	204
FUSE[:STATe].....	205
HCOPy:DATA?.....	237
HCOPy:SIZE:X?.....	237
HCOPy:SIZE:Y?.....	237
INSTrument:NSElect.....	182
INSTrument[:SElect].....	182
INTerfaces:USB:CLASs.....	213
LOG:COUNT.....	238
LOG:DATA?.....	238
LOG:DURation.....	239
LOG:FNAME?.....	239
LOG:INTerval.....	239
LOG:LOCation.....	240
LOG:MODE.....	240
LOG:STIme.....	241
LOG:TRIGgered[:STATe].....	241
LOG[:STATe].....	237
MEASure[:SCALar]:CURRent[:DC]:AVG?.....	215
MEASure[:SCALar]:CURRent[:DC]:MAX?.....	215
MEASure[:SCALar]:CURRent[:DC]:MIN?.....	215
MEASure[:SCALar]:CURRent[:DC]:STATistic?.....	216
MEASure[:SCALar]:CURRent[:DC]?.....	215
MEASure[:SCALar]:ENERgy?.....	214
MEASure[:SCALar]:POWER:AVG?.....	216
MEASure[:SCALar]:POWER:MAX?.....	216
MEASure[:SCALar]:POWER:MIN?.....	217
MEASure[:SCALar]:POWER:STATistic?.....	217
MEASure[:SCALar]:POWER?.....	216
MEASure[:SCALar]:STATistic:COUNT?.....	214
MEASure[:SCALar]:STATistic:RESet.....	214
MEASure[:SCALar][:VOLTage][:DC]:AVG?.....	217
MEASure[:SCALar][:VOLTage][:DC]:MAX?.....	218
MEASure[:SCALar][:VOLTage][:DC]:MIN?.....	218
MEASure[:SCALar][:VOLTage][:DC]:STATistic?.....	218
MEASure[:SCALar][:VOLTage][:DC]?.....	217
OUTPut:DELay:DURation.....	199
OUTPut:DELay[:STATe].....	200
OUTPut:GENeral[:STATe].....	198
OUTPut:IMPedance[:STATe].....	198
OUTPut:SElect.....	200
OUTPut:SRATe[:STATe].....	197
OUTPut[:STATe].....	199
READ?.....	214
STATus:OPERation:INSTrument:CONDition?.....	242
STATus:OPERation:INSTrument:ENABLE.....	242
STATus:OPERation:INSTrument:ISUMmary<Channel>:CONDition?.....	242
STATus:OPERation:INSTrument:ISUMmary<Channel>:ENABLE.....	242

STATus:OPERation:INSTrument:ISUMmary<Channel>:NTRansition.....	243
STATus:OPERation:INSTrument:ISUMmary<Channel>:PTRansition.....	243
STATus:OPERation:INSTrument:ISUMmary<Channel>[:EVENT]?.....	243
STATus:OPERation:INSTrument:NTRansition.....	243
STATus:OPERation:INSTrument:PTRansition.....	243
STATus:OPERation:INSTrument[:EVENT]?.....	243
STATus:QUEStionable:INSTrument:CONDition?.....	244
STATus:QUEStionable:INSTrument:ENABle.....	244
STATus:QUEStionable:INSTrument:ISUMmary<Channel>:CONDition?.....	244
STATus:QUEStionable:INSTrument:ISUMmary<Channel>:ENABle.....	244
STATus:QUEStionable:INSTrument:ISUMmary<Channel>:NTRansition.....	245
STATus:QUEStionable:INSTrument:ISUMmary<Channel>:PTRansition.....	245
STATus:QUEStionable:INSTrument:ISUMmary<Channel>[:EVENT]?.....	245
STATus:QUEStionable:INSTrument:NTRansition.....	245
STATus:QUEStionable:INSTrument:PTRansition.....	245
STATus:QUEStionable:INSTrument[:EVENT]?.....	245
SYSTem:BEEPer:CURRent:STATe.....	169
SYSTem:BEEPer:OUTPut:STATe.....	169
SYSTem:BEEPer:PROTection:STATe.....	170
SYSTem:BEEPer:PROTection[:IMMediate].....	170
SYSTem:BEEPer:WARNIing:STATe.....	170
SYSTem:BEEPer:WARNIing[:IMMediate].....	170
SYSTem:COMMunicate:SOCKeT:APPLY.....	170
SYSTem:COMMunicate:SOCKeT:DHCP.....	171
SYSTem:COMMunicate:SOCKeT:DISCard.....	171
SYSTem:COMMunicate:SOCKeT:GATeway.....	171
SYSTem:COMMunicate:SOCKeT:IPADdress.....	171
SYSTem:COMMunicate:SOCKeT:MASK.....	172
SYSTem:COMMunicate:SOCKeT:RESet.....	172
SYSTem:COMMunicate:WLAN:CONNection[:STATe].....	172
SYSTem:COMMunicate:WLAN:IPADdress?.....	172
SYSTem:COMMunicate:WLAN:PASSword.....	173
SYSTem:COMMunicate:WLAN:SSID.....	173
SYSTem:COMMunicate:WLAN[:STATe].....	173
SYSTem:DATE.....	173
SYSTem:INTerface:GPIB?.....	174
SYSTem:INTerface?.....	174
SYSTem:KEY:BRIGHtness.....	174
SYSTem:LOCal.....	174
SYSTem:REMote.....	175
SYSTem:RWLock.....	175
SYSTem:TIME.....	175
SYSTem:TOUCh[:STATe].....	175
SYSTem:UPTime?.....	176
SYSTem:VNC:PORT.....	175
SYSTem:VNC:STATe.....	176
TRACking[:ENABle]:CH<CHANNEL>.....	212
TRACking[:ENABle]:GENeral.....	212
TRACking[:ENABle]:SELect:CH<CHANNEL>.....	212
TRIGger:CHANnel:DIO<IO>.....	177

TRIGger:CONDition:DIO<IO>.....	178
TRIGger:DIRection:DIO<IO>.....	179
TRIGger:LOGic:DIO<IO>.....	180
TRIGger[ENABLE]:DIO<IO>.....	180
TRIGger[ENABLE]:GENeral.....	180
TRIGger[ENABLE]:SELect:DIO<IO>.....	181

Index

A

Access

Analog in	71
Analog input adjustment	106
Appearance	124
Channel adjustment	110
Channel menu	57
Channel output	65
Copy	114
Copy or delete	114
CSV settings	92
Data logging	89
Date and time	128
Delete	114
Device documentation	121
Device information	129
Device menu	54
Digital IO	83
EasyRamp	100
Ethernet settings	139
FTP mode	147
GPIB	153
Graphical view	102
High impedance mode	70
Instrument	46
Instrument information	129
Interface	135
Licenses	122
Network interface	136
Output setting	66
Overcurrent protection (OCP)	73
Overpower protection (OPP)	76
Overvoltage protection (OVP)	75
QuickArb	94
Remote sense	68
Safety limits	78
Save and recall	116
Screenshot	120
Slew rate control	70
Sound settings	126
Statistics	87
Tracking function	79
USB mode	150
User key action	86
VNC mode	144
Voltage and current	63, 66
WLAN settings	142
Activate channel output	64
Active elements	43
Adjustment	105
Analog input adjustment	105
Channel adjustment	109
Advanced features	
EasyRamp	94
QuickArb	94
Advanced functions	
EasyRamp	99
Advanced operating commands	
Adjustment	229
Analog input	228
Arbitrary	218
EasyRamp	227
Alert beep	126
Alphanumeric parameters	48
Analog in	
Access	71
How to: set	72
Analog input	71
Analog input adjustment	
Access	106
Adjustment	105
How to: adjust	106
Appearance	
Access	124
Application cards	17
Application notes	17
Applications	
Parallel mode	253
Series mode	253
Auto-IP	141
Autosave	
Instrument settings	116
B	
Bench top, placing the R&S NGP800	19
Brochures	17
C	
Calibration certificate	17
Carrying the instrument	18
Channel adjustment	
Access	110
Current adjustment	109
How to: adjust	110
Voltage adjustment	109
Channel menu	
Access	57
Channel output	
Access	65
How to: activating	65
Checking the instrument	18
Clear status	
Remote	165
Command sequence	
Remote	167
Configuration commands	
Channel selection	181
Combined setting of voltage and current settings	195
Current setting	192
OCP setting	200
OPP setting	208
Output setting	196
OVP setting	205
Reset protection tripped state	211
Safety limit setting	183
Tracking setting	212
USB class setting	213
Voltage setting	189
Connect to power	
How to:	23

Connecting			Display information	36
Power	23		Channel display area	40
USB devices	26		Expand/Collapse softkey	40
USB flash drive	26		Historical channel information	41
Connecting to LAN	25		Operating mode	42
Contents of the status registers			Settings softkey	40
Application of the status reporting system	163		Status bar information	37
Event status register (ESR) and event status enable register (ESE)	161		Documentation overview	16
Status operation register	162		Driver for remote control	17
STATus:QUESTIONable register	162			
Copy			E	
Access	114		EasyRamp	99
How to: manage files	114		Access	100
Copy or delete			How to: set	100
Access	114		EMI	
How to: manage files	114		Test considerations	22
CSV parameters			Ethernet settings	
How to: set	92		Access	139
CSV settings	92		Event status enable register (ESE)	
Access	92		Remote	165
Current	63		Event status register (ESR)	
Customer support	248		Remote	166
D			F	
Data			Factory adjustment	
Accessing	113		How to: restore	110
Handling	113		Factory default settings	
Retrieving	113		Instrument settings	116
Data entry	47		Factory settings	
Data logging	88		How to: reset	118
Access	89		File and data management	113
CSV settings	88		Data logging	113
How to: start/stop	90		Save recall	116
Data sheets	17		Screenshot	120
Date	127		File manager	
Date and time			Copy	114
Access	128		Delete	114
General instrument settings	127		Firmware	
Default settings			How to: update	131
How to: reset	118		Setup	131
Default values			Update	131
Remote	166		Firmware update	
Delete			Notifications	247
Access	114		Front panel	
How to: manage files	114		Chassis ground terminal	28
Device documentation	121		Display	27
Access	121		Menu control keys	27
How to: view	121		Navigation controls	27
Device information			Output and channel keys	28
Access	129		Output terminals	28
General settings	129		Power key	28
Settings	129		USB connector	28
Device menu			Front panel keys	54
Access	54		Menu control keys	54
Device/Channel menu window	54		Navigation controls	60
DHCP	141		Output and channel controls	60
DHCP & Auto-IP	141		Usage	36
Digital IO	80		FTP	
Access	83		Interface	147
How to: set	83		FTP access	
Digital trigger IO	80		How to: set	148
Display			FTP mode	
Active elements	43		Access	147
On-screen keyboard	43		Fuses	
Display brightness	124		How to replace the power fuse	23

G

Gateway	141
General instrument settings	122
Appearance settings	124
Date and time	127
Licenses management	122
Sound settings	126
Update device	131
General settings	
Device information	129
Getting started	16
GPIB	
Access	153
Characteristics	158
Interface	153
GPIB address	
How to: adjust address	154
How to: adjust address on the controller	154
Graphical view	101
Access	102
How to: configure	102
Graphical view window	101
Ground terminal	
How to: ground terminal	23

H

Help	16
High impedance mode	
Access	70
How to:	
Access settings	46
Activating channel output	65
Adjust the GPIB bus address	154
Adjust the GPIB bus address on the controller	154
Assign IP address on controller	140
Check LAN connection	140
Configure FTP access	148
Configure graphical view	102
Connect to LAN	25
Connect to power	23
Connect USB storage device	26
Copy	114
Copy or delete	114
Delete	114
Disconnect from power	24
Enter data	48
Ground terminal	23
Install a license manually	123
Install a license XML file	122
Manual configuring of Ethernet settings	140
Mount the instrument in a rack	20
Perform analog input adjustment	106
Perform channel adjustment	110
Replace the power fuse	23
Reset statistics	87
Reset to default settings	118
Reset to factory settings	118
Restore factory adjustment	110
Return to manual operation	159
Save	117
Save a screenshot	120
Set analog in	72
Set CSV parameters	92
Set digital IO	83
Set EasyRamp	100

Set instrument alert	126
Set instrument appearance	125
Set network interface	137
Set output delay	67
Set overcurrent protection (OCP)	74
Set overpower protection (OPP)	77
Set overvoltage protection (OVP)	75
Set QuickArb	94
Set QuickArb editor	95
Set remote sensing	68
Set safety limits	78
Set SCPI raw port and hostname	137
Set slew rate control	70
Set tracking function	79
Set user action	86
Set voltage and current	63
Shut down the product	24
Start remote control session	158
Start/Stop data logging	90
Switch on	24
Unmount the instrument from a rack	21
Update firmware	131
USB class	150
View device documentation	121
VNC connection	145
WLAN settings	143

I

Identification	
Remote	166
Instrument	
Carrying	18
Checking	18
Lifting	18
Operating site	19
Unpacking	18
Instrument alert	
How to: set	126
Instrument appearance	
How to: set	125
Instrument control	35
Manual operation	35
Remote control	35
Ways of operation	35
Instrument information	
Access	129
Instrument security procedures	16
Instrument settings	
Autosave	116
Factory default settings	116
Recall	116
Save	116
Instrument tour	26
Front panel	26
Rear panel	28
Interface	
Access	135
FTP	147
GPIB	153
LAN	138
Network connection	136
Remote control	134
USB	150
VNC	144
WLAN	142

- IP address 141, 155
 - How to: assign IP address manually on the controller 140
 - How to: manual configuring of Ethernet settings 140
- K**
- Key brightness 124
- Keyboard
 - On-screen 47
- L**
- LAN
 - How to: check connection 140
 - Interface 138
 - IP address 155
- LAN communication
 - Problems 248
- LAN connection
 - Problems 248
- License keycode
 - How to: install 123
- License XML file
 - How to: Install 122
- Licenses
 - Access 122
- Licenses management
 - General instrument settings 122
- Lifting the instrument 18
- M**
- Maintenance, storage and disposal 251
 - Changing fuses 251
 - Cleaning 251
 - Disposal 252
 - Internal battery replacement 251
 - Storage 252
- Manual interaction 35
- Manual operation 35
- Measurement functions
 - Statistics 87
- Menu control keys
 - Home key 54
 - Settings key 54
 - User key 60
- Menu controls 54
 - Settings key 54
- Modes of operation 62
 - Constant current (CC) 62
 - Constant voltage (CV) 62
- Mounting, in a rack 20
- N**
- Navigation controls
 - Rotary knob 27, 60
- Network
 - Wireless LAN 142
- Network connection
 - Interface 136
- Network interface
 - Access 136
 - How to: Set 137
- Network operation and remote control 134
- Non-operational data 113
- Numeric data entry 47
- Numeric parameters 48
- O**
- On-screen keyboard 43, 48
- Open source acknowledgment (OSA) 17
- Operating site
 - Choosing 19
 - Setting up the instrument 19
- Operation
 - Manually 35
 - Remotely 48
- Operation complete
 - Remote 166
- Operational data 113
- Options
 - Identification (remote) 166
- Output and channel controls 60
- Output auto-ranging 61
- Output delay
 - How to: set 67
- Output setting 66
 - Access 66
- Overcurrent protection 73
- Overcurrent protection (OCP)
 - Access 73
 - How to: set 74
- Overpower protection 76
- Overpower protection (OPP)
 - Access 76
 - How to: set 77
- Overvoltage protection 75
- Overvoltage protection (OVP)
 - Access 75
 - How to: set 75
- P**
- Parameters
 - Entering 48
- Power
 - Connecting the instrument 23
- Power states 24
- Preparing for use 18
- Protection 73
 - Fuse linking 73
 - Overcurrent protection (OCP) 73
 - Overpower protection (OPP) 73
 - Overvoltage protection (OVP) 73
 - Safety limits 73
- Protocol
 - SCPI 154
 - VISA 155
- Protocols
 - Remote control 134
- Q**
- QuickArb
 - Access 94
 - How to: set 94
- QuickArb editor
 - How to: set 95

R

Rack, mounting	20
Rear panel	
AC inlet with integrated 2-pole rocker switch	29
Analog input connector	30
Channel connectors	31
Digital I/O connector	30
Ethernet connector	30
Ground terminal	29
IEEE-488 (GPIB) interface	29
Kensington security slot	31
USB connectors	30
Recall	
Instrument settings	116
Release notes	17
Remote access	
DHCP & Auto-IP	141
IP address	141
Network gateway	141
Subnet mask	141
Remote command	
Status reporting commands	241
Remote control	35, 48
Driver	17
GPIB interface	153
Interface	134
Interfaces	49
Protocols	134
Start	158
Stop	158
Remote control commands	165
Advanced operating commands	218
Common setting commands	165
Configuration commands	181
Data and file management commands	235
Display commands	176
Measurement commands	213
Remote sense commands	187
Status reporting commands	241
System settings commands	168
Trigger commands	177
Remote control session	
How to: return to local	159
How to: start	158
Remote sense	
Access	68
Remote sensing	
How to: set	68
Replace the power fuse	
How to:	23
Reset values	
Remote	166
Resource string	
GPIB connection	157
LAN connection	155
USB connection	157
VISA	155

S

Safety information	9
Safety instructions	9, 16
Safety limits	77
Access	78
How to: set	78

Save

How to: save instrument settings	117
Instrument settings	116
Save and recall	
Access	116
Save recall	
Types of instrument settings	116
SCPI programmers manual	16
SCPI raw port and hostname	
How to: Set	137
Screenshot	
Access	120
How to: Save	120
Security procedures	16
Self-test	
Remote	167
Service request enable register (SRE)	
Remote	167
Set Current	63
Set Voltage	63
Setting up remote control connection	155
Settings	
Device information	129
Setup	
Firmware	131
Slew rate control	
Access	70
How to: set	70
Sound settings	
Access	126
General instrument settings	126
Specifications	17
Statistics	
Access	87
How to: reset	87
Status bar information	
Channel status	38
Device status	37
Status byte	
Remote	165, 167
Status information	
Notifications	247
Status reporting system	159
Contents of the status registers	161
Error queue	164
Structure of a SCPI status register	159
Subnet mask	141
Switching on or off	24

T

Test considerations	
EMI	22
General data on instrument specifications	21
Protection limits for R&S NGP800	22
Test setup	21
Test setup	
Test considerations	21
Text entry	47
Time	127
Tracking function	79
Access	79
How to: set	79
Transport	250
Trigger IO system	80
Trigger-in signals	81
Trigger-out signals	82

Troubleshooting	247	Welcome to R&S NGP800	15
Firmware update notifications	247	White papers	17
LAN communication problems	248	WLAN	
LAN connection problems	248	Interface	142
Status notifications	247	WLAN settings	
Trying out the instrument		Access	142
Activating the channels output	33	How to: set	143
Selecting the channels	32		
Setting the output voltage and current limit	32		
Storing/Recalling of instrument settings	34		
Types of instrument settings			
Save recall	116		
U			
Unpacking the instrument	18		
Update	131		
Firmware	131		
USB			
Interface	150		
USB class			
How to: set	150		
USB connection			
USB CDC	151		
USB TMC	151		
USB VCP	151		
USB mode			
Access	150		
User action			
How to: set	86		
User key	86		
Cancel	86		
Reset statistics	86		
Screenshot	86		
Select	86		
Toggle logging	86		
TouchLock	86		
User key action			
Access	86		
User manual	16		
Using the front panel keys	36		
Using the touchscreen	35, 50		
Accessing functionality using shortcuts	51		
Accessing functionality using the settings softkey	50		
Expand/Collapse softkey	52		
Input data	53		
V			
VISA	135		
Resource string	155		
VNC			
Interface	144		
VNC connection			
How to: set	145		
VNC mode			
Access	144		
Voltage	63		
Voltage and current			
Access	63, 66		
How to: set	63		
W			
Wait			
Remote	167		
Ways of operation	35		