

# ViewSonic®



---

## **NMP760** **Chromebox** **User Guide**

---

**IMPORTANT:** Please read this User Guide to obtain important information on installing and using your product in a safe manner, as well as registering your product for future service. Warranty information contained in this User Guide will describe your limited coverage from ViewSonic Corporation, which is also found on our web site at <http://www.viewsonic.com> in English, or in specific languages using the Regional selection box in the upper right corner of our website. "Antes de operar su equipo lea cuidadosamente las instrucciones en este manual"

---

**Model No. VS18614**

## Thank you for choosing ViewSonic

As a world leading provider of visual solutions, ViewSonic is dedicated to exceeding the world's expectations for technological evolution, innovation, and simplicity. At ViewSonic, we believe that our products have the potential to make a positive impact in the world, and we are confident that the ViewSonic product you have chosen will serve you well.

Once again, thank you for choosing ViewSonic !



# Compliance Information

## FCC Statement

This device complies with part 15 of FCC Rules. Operation is subject to the following two conditions: (1) this device may not cause harmful interference, and (2) this device must accept any interference received, including interference that may cause undesired operation.

This equipment has been tested and found to comply with the limits for a Class B digital device, pursuant to part 15 of the FCC Rules. These limits are designed to provide reasonable protection against harmful interference in a residential installation. This equipment generates, uses, and can radiate radio frequency energy, and if not installed and used in accordance with the instructions, may cause harmful interference to radio communications. However, there is no guarantee that interference will not occur in a particular installation. If this equipment does cause harmful interference to radio or television reception, which can be determined by turning the equipment off and on, the user is encouraged to try to correct the interference by one or more of the following measures:

- Reorient or relocate the receiving antenna.
- Increase the separation between the equipment and receiver.
- Connect the equipment into an outlet on a circuit different from that to which the receiver is connected.
- Consult the dealer or an experienced radio/TV technician for help.

You are cautioned that changes or modifications not expressly approved by the party responsible for compliance could void your authority to operate the equipment.

**Warning:** Use only power supplies listed in the user instructions.

**AVERTISSEMENT:** Utilisez uniquement les sources d'alimentation mentionnées dans les instructions d'utilisation.

## For Canada

- This Class B digital apparatus complies with Canadian ICES-003.
- Cet appareil numérique de la classe B est conforme à la norme NMB-003 du Canada.

## CE Conformity for European Countries

 The device complies with the EMC Directive 2014/30/EU, RED Directive 2014/53/EU and Low Voltage Directive 2014/35/EU.

### Following information is only for EU-member states:

The mark is in compliance with the Waste Electrical and Electronic Equipment Directive 2012/19/EU (WEEE).

The mark indicates the requirement NOT to dispose the equipment including any spent or discarded batteries or accumulators as unsorted municipal waste, but use the return and collection systems available.



If the batteries, accumulators and button cells included with this equipment, display the chemical symbol Hg, Cd, or Pb, then it means that the battery has a heavy metal content of more than 0.0005% Mercury or more than, 0.002% Cadmium, or more than 0.004% Lead.

## Declaration of RoHS2 Compliance

This product has been designed and manufactured in compliance with Directive 2011/65/EU of the European Parliament and the Council on restriction of the use of certain hazardous substances in electrical and electronic equipment (RoHS2 Directive), and is deemed to comply with the maximum concentration values issued by the European Technical Adaptation Committee (TAC) as shown below:

Substance	Proposed Maximum Concentration	Actual Concentration
Lead (Pb)	0.1%	< 0.1%
Mercury (Hg)	0.1%	< 0.1%
Cadmium (Cd)	0.01%	< 0.01%
Hexavalent Chromium (Cr <sup>6+</sup> )	0.1%	< 0.1%
Polybrominated biphenyls (PBB)	0.1%	< 0.1%
Polybrominated diphenyl ethers (PBDE)	0.1%	< 0.1%
Bis(2-ethylhexyl) phthalate (DEHP)	0.1%	< 0.1%
Butyl benzyl phthalate (BBP)	0.1%	< 0.1%
Dibutyl phthalate (DBP)	0.1%	< 0.1%
Diisobutyl phthalate (DIBP)	0.1%	< 0.1%

\*\*Certain components of products as stated above are exempted under the Annex III of the RoHS2 Directives as noted below:

Examples of exempted components are:

1. Lead as an alloying element in aluminium containing up to 0.4% lead by weight
2. Copper alloy containing up to 4% lead by weight
3. Lead in high melting temperature type solders (i.e. lead-based alloys containing 85% by weight or more lead)
4. Electrical and electronic components containing lead in a glass or ceramic other than dielectric ceramic in capacitors, e.g. piezoelectronic devices, or in a glass or ceramic matrix compound

## ENERGY STAR® compliance

As an ENERGY STAR Partner, has followed the EPA's enhanced product qualification and certification process to ensure that the products marked with the ENERGY STAR logo are ENERGY STAR qualified per the applicable ENERGY STAR guidelines for energy efficiency. The following logo appears on all ENERGY STAR-qualified computers:



The ENERGY STAR program for computers was created by the EPA to promote energy efficiency and reduce air pollution through more energy-efficient equipment in homes, offices, and factories. One way that products achieve this goal is by using a power management feature to reduce power consumption when the product is not in use. The power management feature allows the computer to initiate a low-power or "Sleep" mode after a period of user inactivity. When used with an external ENERGY STAR qualified monitor, this feature also supports similar power management features of the monitor. To take advantage of these potential energy savings, the power management feature has been preset to behave in the following way when the system is operating on AC power:

- Turn off the display / Initiate Sleep after  $\leq$  15 minutes (varies by model)
- Initiate Sleep after  $\leq$  30 minutes (varies by model)

The computer exits Sleep when the power/Sleep button is pressed. When the Wake On LAN (WOL) feature is enabled, the computer can also exit Sleep in response to a network signal.

Additional information on the potential energy and financial savings of the power management feature can be found on the EPA ENERGY STAR Power Management Web site at <http://www.energystar.gov/powermanagement>.

Additional information on the ENERGY STAR program and its environmental benefits are available on the EPA ENERGY STAR Web site at <http://www.energystar.gov>.

1. Please follow the guidance of web page:  
<http://www.chromium.org/chromium-os/developer-information-for-chrome-os-devices>  
to put your device to Developer mode.
2. In the Chrome OS UI, please press "Ctrl + Alt + F2" or "Ctrl + Alt + →" to enter console mode.
3. Login as "root".
4. Run "ethtool -s eth0 wol d" to disable WOL function.  
Run "ethtool -s eth0 wol g" to enable WOL function.

Press "Ctrl + Alt + F1" or "Ctrl + Alt + ←" to go back to Chrome OS UI.

# Contents

## Compliance Information

FCC Statement.....	i
CE Conformity for European Countries.....	i
Declaration of RoHS2 Compliance.....	ii
ENERGY STAR® compliance.....	iii

## Copyright Information

For Your Records.....	1
-----------------------	---

## 1. PRODUCT OVERVIEW

Package contents.....	2
Front view.....	3
Rear View.....	3
Status indicators.....	4

## 2. Getting Started

Connecting the AC power.....	5
Connecting a display device.....	5
Connecting a mouse and keyboard.....	6
Connecting a mouse and keyboard.....	6
Connecting a wireless mouse and keyboard.....	6

## 3. Performing additional connections

Connecting audio components.....	7
Connecting to local area network (LAN).....	7
Inserting a memory card.....	8
Connecting USB devices.....	8
Mounting the Chromebox.....	9
Powering on your Chromebox.....	10
Resetting the Chromebox.....	10

## 4. Operating the Chromebox

Navigating the desktop.....	11
Managing apps.....	11
Wireless connections .....	12
Connecting to a wireless access point .....	12
Connecting to Bluetooth devices.....	12
Managing notifications.....	13
Switching to Night Light mode.....	13
Adjusting volume .....	13
Adjusting brightness.....	13
Locking the screen .....	13
Configuring Chromebox settings.....	14

## 5. Troubleshooting

The power is switched on, but Chromebox does not start:.....	16
Cannot access the LAN:.....	16
Cannot connect to the Bluetooth device:.....	16
No audio is heard from the Chromebox:.....	16

## 6. Specifications

### Other Information

Customer Support.....	18
-----------------------	----

# Copyright Information

Copyright © ViewSonic Corporation, 2021. All rights reserved.

ViewSonic and the three birds logo are registered trademarks of ViewSonic Corporation.

Disclaimer:ViewSonic Corporation shall not be liable for technical or editorial errors or omissions contained herein; nor for incidental or consequential damages resulting from furnishing this material, or the performance or use of this product.

In the interest of continuing product improvement, ViewSonic Corporation reserves the right to change product specifications without notice. Information in this document may change without notice.

No part of this document may be copied, reproduced, or transmitted by any means, for any purpose without prior written permission from ViewSonic Corporation.

## For Your Records

**Product Name:** ViewSonic NMP760 Chromebox  
**Model Number:** VS18614  
**Document Number:** NMP760\_UG\_ENG\_1a\_20210105

**Serial Number:** \_\_\_\_\_

**Purchase Date:** \_\_\_\_\_

### Product disposal at end of product life

ViewSonic respects the environment and is committed to working and living green. Thank you for being part of Smarter, Greener Computing.

Please visit ViewSonic website to learn more.

USA & Canada: <http://www.viewsonic.com/company/green/recycle-program/>

Europe: <http://www.viewsoniceurope.com/eu/support/call-desk/>

Taiwan: <http://recycle.epa.gov.tw/>



# 1. PRODUCT OVERVIEW

## Package contents

Please take a moment to check if all the necessary items are included in the package. If anything is missing or damaged, please contact your dealer immediately.

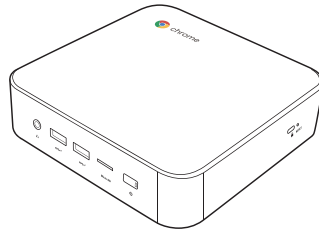

NMP760

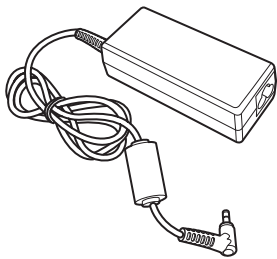

Power adapter

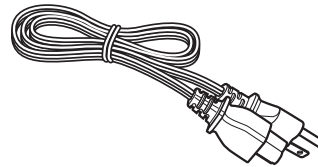

Power cord (by Region)

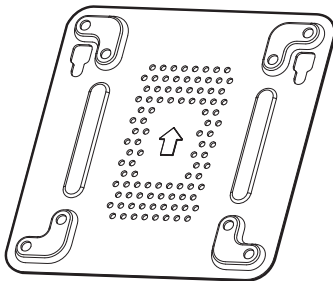

Wall Mount



Screw

## Front view

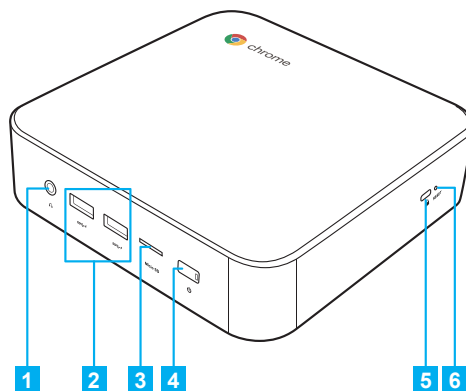

No.	Description	No.	Description
1	Audio jack (3.5mm)	4	Power button with LED
2	(2) USB type-A 3.0 ports*	5	Kensington lock port
3	MicroSD™ card reader	6	Reset hole

**Note:** \*Supports battery charging.

## Rear View

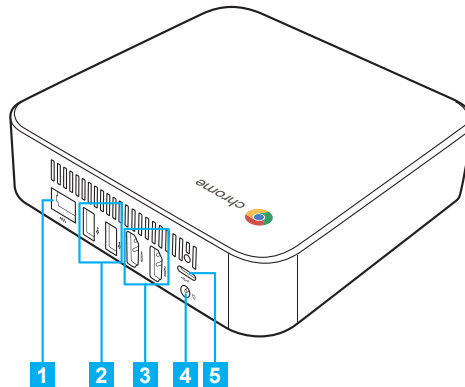

No.	Description	No.	Description
1	LAN port	4	DC-in jack
2	(2) USB 2.0 ports	5	USB type-C port
3	(2) HDMI port		

## Status indicators

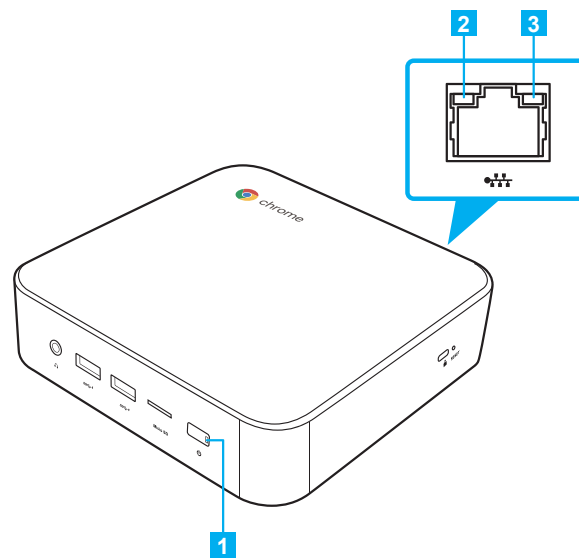

No.	Indicator	Color	Status	Description
1	Power button	White	On	Chromebox is switched on.
			Off	Chromebox is switched off.
2	LAN port	Orange	Flashing	Activity on the link.
			Off	No activity on the link.
3		Green	On	Active link connection.
			Off	No link connection.

## 2. Getting Started

### Connecting the AC power

To connect your Chromebox to the power outlet, do the following:

1. Connect one end of the power cord to the AC adapter and the other end to the power outlet.
2. Connect the AC adapter to the DC-in jack of your Chromebox.

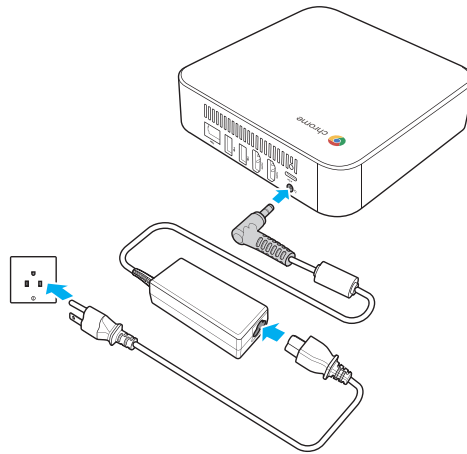

### Connecting a display device

To establish the connection, you need to use an HDMI cable (not supplied).

1. Connect one end of the HDMI cable to the HDMI port of your Chromebox.
2. Connect the other end of the HDMI cable to the HDMI port of a display device, for example monitor.

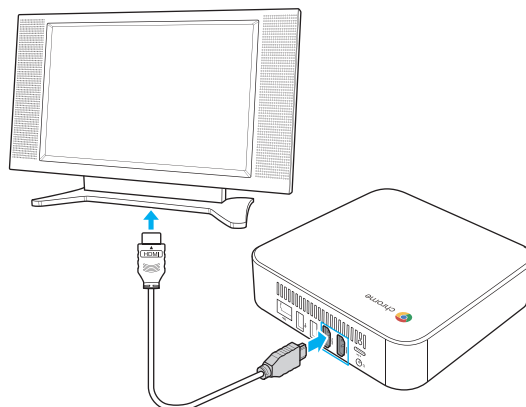

## Connecting a mouse and keyboard

Your Chromebox supports both wired and wireless mouse and keyboard.

## Connecting a mouse and keyboard

Connect the USB mouse and USB keyboard to the USB2.0 ports of your Chromebox.

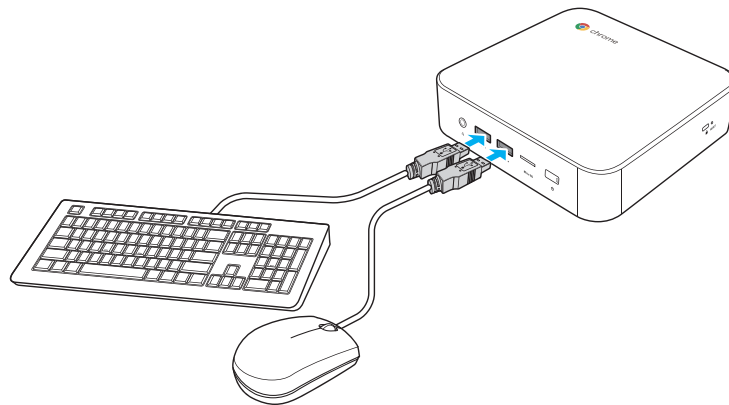

## Connecting a wireless mouse and keyboard

Connect the USB receiver that is supplied with your wireless mouse and keyboard to the USB port of your Chromebox.

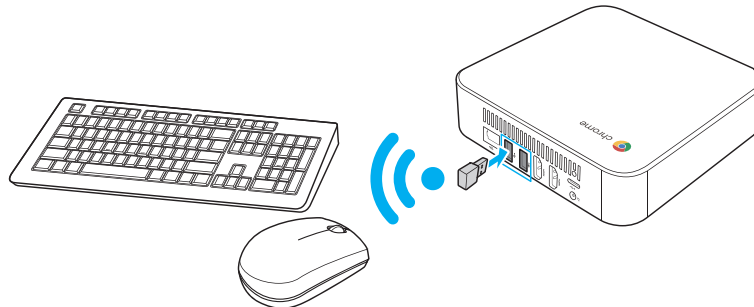

**Note:** After you power on the Chromebox, the wireless mouse and keyboard are usually paired automatically. If any additional steps are required, please refer to the manual that came with your accessories.

## 3. Performing additional connections

### Connecting audio components

Connect the audio component into the audio jack of your Chromebox.

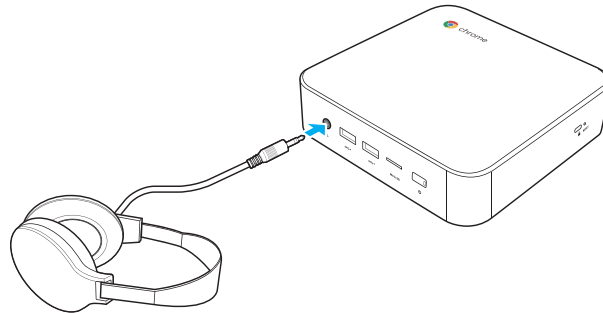

### Connecting to local area network (LAN)

1. Connect one end of the RJ-45 cable to the LAN port of your Chromebox.
2. Connect the other end of the RJ-45 cable to a network connection device or a network wall connector.

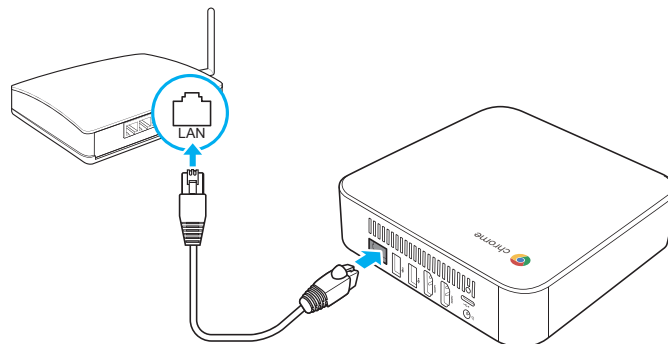

**Note:** For configuring LAN parameters, refer to page 23.

## Inserting a memory card

**Note:** Your Chromebox supports MicroSD™ cards.

1. With the gold contacts facing down, insert the memory card into the card reader.
2. Push the memory card all the way until you hear a locking sound.

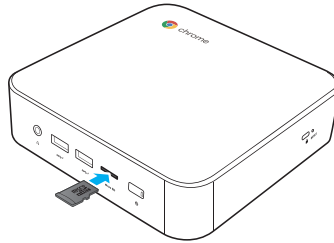

## Connecting USB devices

**Note:** Your Chromebox supports USB2.0, USB3.0, and USB type-C.

Depending on the supported USB type, connect the USB device to the respectful USB port of your Chromebox.

- USB2.0 and USB3.0 compatible device connect to one of the following USB ports:

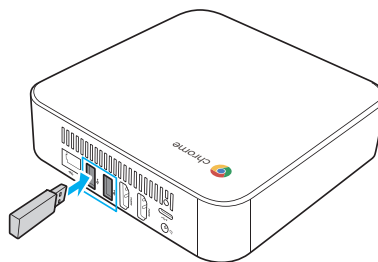

- USB type-C compatible device connect to the following USB port:

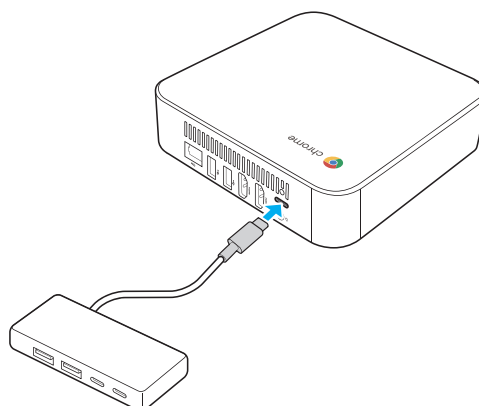

## Mounting the Chromebox

Mount the Chromebox to the back of your display device.

**Note:** Make sure your display device supports VESA mounting. Refer to the following illustration for size measurements:

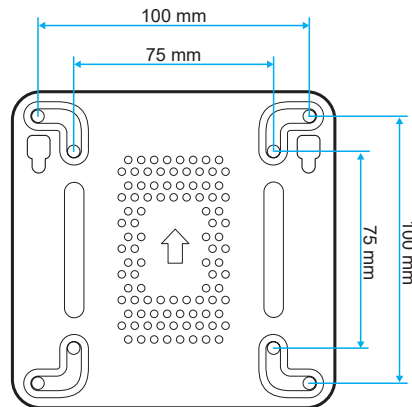

1. Secure the mounting plate (optional accessory) to the VESA mounting holes behind your display device with the four screws.

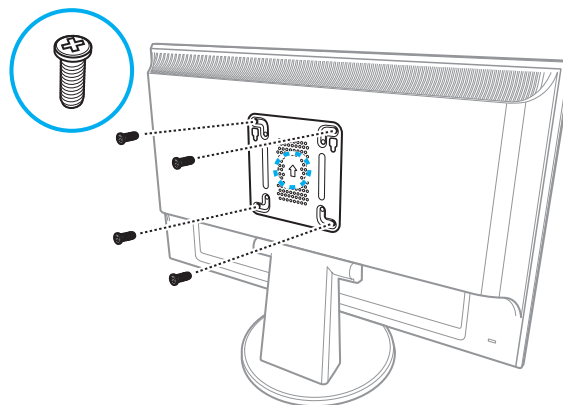

2. Remove the two rubber feet from the bottom side of the Chromebox. Then secure the two screws (optional accessories) to the mounting holes of your Chromebox as illustrated.

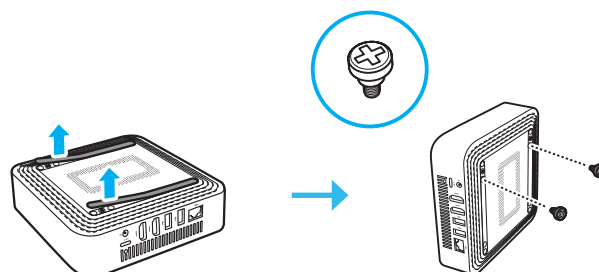



3. Align and install your Chromebox to the screw holes in the mounting plate.

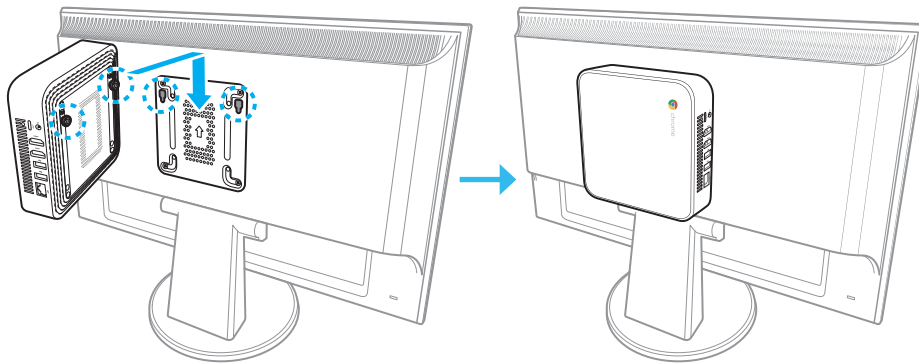

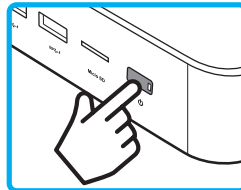

## Powering on your Chromebox

To power on your Chromebox, press the Power button on the front panel. The Power button LED lights solid white.

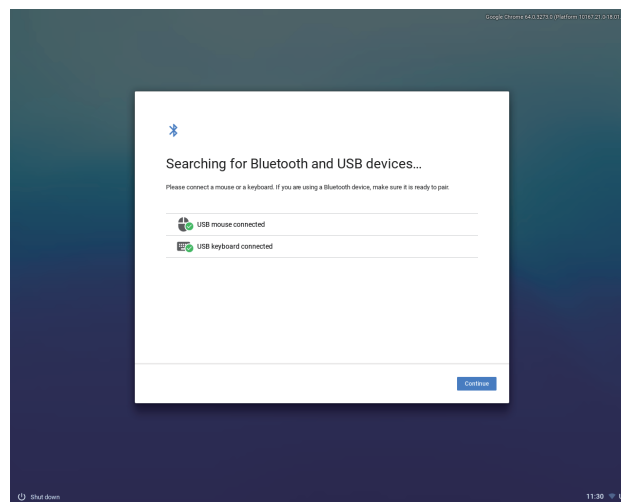

After you power on the Chromebox for the first time, you are asked to configure some device's basic settings, such as set the language, configure accessibility options, connect to the network, and finally sign in to your Chromebox. Follow the on-screen instructions to complete the initial setup.



**Note:** To shut down Chromebox, press the **Power** button and then click **Power off** .

## Resetting the Chromebox

To reset the Chromebox, insert a pointed tool into the reset hole on the side of the device.

# 4. Operating the Chromebox

## Navigating the desktop

After the initial setup is configured, you will see the desktop.

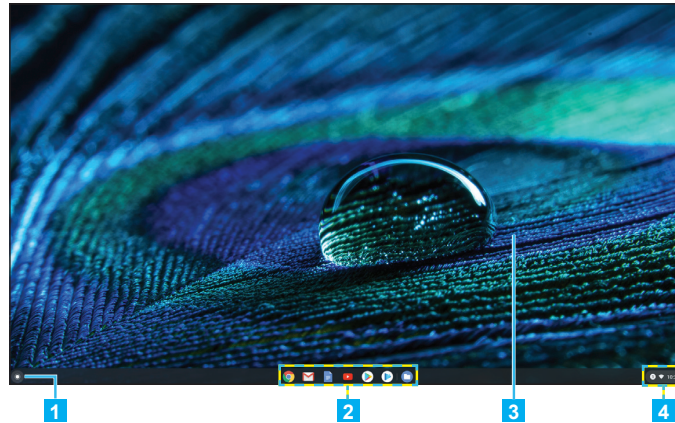

Click on any of the following items:

- **1 Launcher:** Manage installed apps and perform search.
- **2 App launcher:** Access most frequently used apps quickly.
- **3 Desktop:** Right click to manage shelf visibility, position, and set wallpaper.
- **4 Status tray:** View notifications (🔔), manage connections (📶), time (10:26), and other settings.

## Managing apps

To search, access, and manage apps in your Chromebox, do the following:

1. Click on the **Launcher** (🔍).

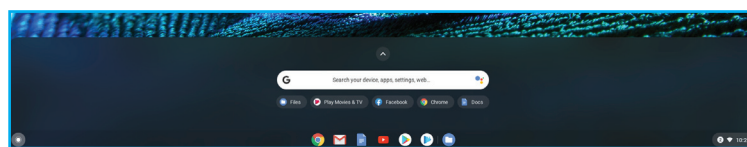

2. Do any of the following:

- Search for installed apps by typing the app name in the search bar (**Search your device, apps, settings, web...**).
- Review recently accessed apps (appear below search bar).
- Click on (⌵) to review and access all apps installed on your Chromebox. Then right click on the app icon and select to open the app in a new tab/window, pin to shelf, configure options, uninstall from Chrome, review app info, and access additional options that are related to the specific app.

**Note:** You can download new apps to your Chromebox from the Chrome Web Store (🌐) or Google Play Store (📺).

## Wireless connections

### Connecting to a wireless access point

1. Click anywhere on the Status tray to open the tray.
2. Click on  to automatically enable Wi-Fi function and start scanning for nearby wireless access points. After scanning, a list of available Wi-Fi networks is displayed on the screen.

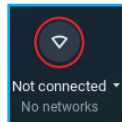

3. Click on the Wi-Fi network where you want to connect to.

**Note:** If the Wi-Fi network is protected with a password, enter the password at the prompt.

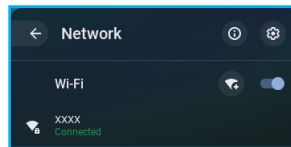

**Note:** Upon successful connection, the Wi-Fi icon in the Status tray changes from  (no signal) to  (maximum signal strength).

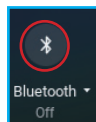

### Connecting to Bluetooth devices

1. Click anywhere on the Status tray to open the tray.
2. Click on  to automatically enable Bluetooth function and start scanning for nearby Bluetooth devices. After scanning, a list of available Bluetooth devices is displayed on the screen.



3. Click on the Bluetooth device you want to connect to and follow the on-screen instructions to complete pairing.

## Managing notifications

1. Click anywhere on the Status tray to open the tray.
2. Click  to switch to Do not disturb mode. Click again to disable the mode.
3. Click  next to Notifications to select apps that are allowed to send notifications.

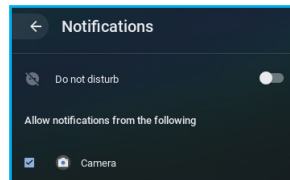
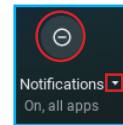

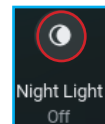

## Switching to Night Light mode

1. Click anywhere on the Status tray to open the tray.
2. Click  to tint the screen with a yellowish hue to reduce eyestrain late at night.



## Adjusting volume

1. Click anywhere on the Status tray to open the tray.
2. Click on the slider bar to adjust volume or click on  to mute audio (.



## Adjusting brightness

1. Click anywhere on the Status tray to open the tray.
2. Click on the slider bar to adjust brightness.



## Locking the screen

To lock the screen, click Status tray > .

# Configuring Chromebox settings

1. Click Status tray >  or Launcher  >  >  to open Settings page.

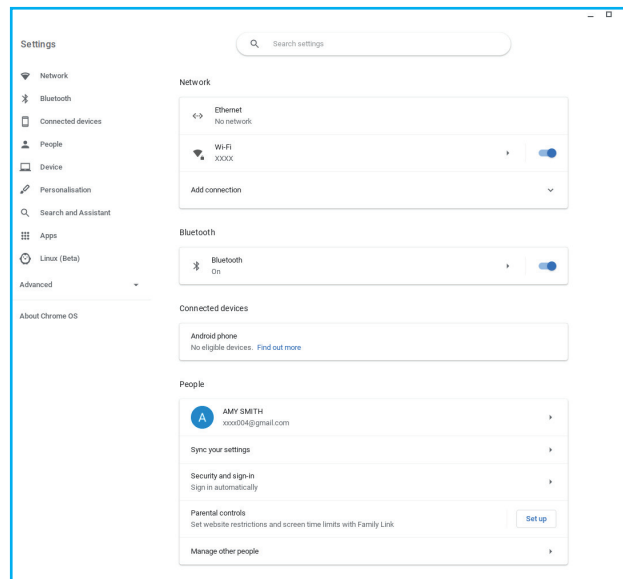

2. Configure any of the following:
  - **Network > Ethernet:** LAN connection parameters.  
**Note:** Make sure your Chromebox is connected to the LAN. Refer to page 15.
  - **Network > Wi-Fi:** Connect to a wireless access point.
  - **Bluetooth > Bluetooth:** Enable or disable Bluetooth function and pair with compatible devices.
  - **Connected devices:** List of connected devices.
  - **People > Your account:** Set your account picture.
  - **People > Sync your settings:** Manage sync settings.
  - **People > Security and sign-in:** Enable or disable to show lock screen when waking up from sleep mode and set lock screen password.
  - **People > Parental controls:** Set website restrictions and screen time limits with Family Link.
  - **People > Manage other people:** Manage other Chromebox user accounts.
  - **Device > Mouse:** Configure mouse settings.
  - **Device > Keyboard:** Configure keyboard settings.
  - **Device > Displays:** Configure display settings.
  - **Device > Storage management:** Manage Chromebox's storage.
  - **Device > Power:** Set Chromebox activity when the system is idle.
  - **Personalisation > Change device account image:** Select your preferred account image.

- **Personalisation > Wallpaper:** Select your preferred desktop wallpaper.
- **Search and Assistant > Preferred search engine:** Set the default search engine that is used in the address bar.
- **Search and Assistant > Google Assistant:** Enable or disable Google Assistant and configure its settings.
- **Apps > Manage your apps:** Uninstall apps, pin apps to shelf, configure notification settings and permissions.
- **Apps > Google Play Store:** Uninstall Google Play Store.
- **Linux (Beta) > Linux:** Run Linux tools, editors, and IDEs on your Chromebox.
- **Advanced:** Configure system advanced settings, such as date and time, privacy and security, passwords and forms, language and input, downloads, printing, accessibility settings, and perform system reset.

## 5. Troubleshooting

If you experience a problem with your Chromebox, refer to the following troubleshooting guide. If a problem persists, contact the service center.

### **The power is switched on, but Chromebox does not start:**

- Make sure that the AC adapter is properly plugged into the DC-in jack of the Chromebox and to the power outlet. Refer to page 13.

### **Cannot access the LAN:**

- Make sure you have connected one end of an RJ-45 cable to the LAN port of your Chromebox and the other end to the network connection device or a network wall connector. Refer to page 16.
- Make sure you have configured the LAN settings correctly. Refer to page 24.

### **Cannot connect to the Bluetooth device:**

- Make sure the Bluetooth device you want to connect to is near- by your Chromebox and is visible to other devices.

### **No audio is heard from the Chromebox:**

- Make sure audio is not muted. Refer to page 23.

## 6. Specifications

Item	Description
Processor	CPU Intel Celeron 5205U Dual Core 1.8GHz BGA 2MB L3 HD 610
Operating system	Google
Memory	8G DDR4, 2 slots
Memory type	2133 DDR4 SODIMM (DDR4-2133)
Storage	eMMC
Storage capacity	64G
Storage type	2242 type
LAN	Gigabit
Networking	10 / 100 / 1000M GbE LAN
WLAN and Bluetooth	802.11ac, BT Combo (2x2)
	Intel Dual Band Wireless-AX201 802.11 AX 2x2 WiFi + Bluetooth 5.0 M.2 non-vPro PCI-e WW with 2 antennas 802.11ax, Bluetooth 5.0
Connectors	Front: <ul style="list-style-type: none"> <li>• Audio jack (3.5mm)</li> <li>• (2) USB type-A 3.0 ports</li> <li>• MicroSD™ card reader</li> </ul> Rear: <ul style="list-style-type: none"> <li>• LAN port</li> <li>• (2) USB2.0 ports</li> <li>• (2) HDMI ports</li> <li>• DC-in jack</li> <li>• USB type-C port</li> </ul>
Temperature	32°F to 95°F (0°C to 35°C)
Humidity	30-80%
VESA mounting	100 x 100 mm
Dimensions	148 x 148.5 x 41.7 mm
Weight	620g
Voltage	19.5V

Item	Description
AC Adapter	65W
Output	19V DC, 3.42A
Input	100~240V AC, 50/60Hz universal
Power cord	Type by region
Security solution	Kensington lock



# Other Information

## Customer Support

For technical support or product service, see the table below or contact your reseller.

**NOTE:** You will need the product serial number.

Country/ Region	Website	Country/ Region	Website
<b>Asia Pacific &amp; Africa</b>			
Australia	<a href="http://www.viewsonic.com/au/">www.viewsonic.com/au/</a>	Bangladesh	<a href="http://www.viewsonic.com/bd/">www.viewsonic.com/bd/</a>
中国 (China)	<a href="http://www.viewsonic.com.cn">www.viewsonic.com.cn</a>	香港 (繁體中文)	<a href="http://www.viewsonic.com/hk/">www.viewsonic.com/hk/</a>
Hong Kong (English)	<a href="http://www.viewsonic.com/hk-en/">www.viewsonic.com/hk-en/</a>	India	<a href="http://www.viewsonic.com/in/">www.viewsonic.com/in/</a>
Indonesia	<a href="http://www.viewsonic.com/id/">www.viewsonic.com/id/</a>	Israel	<a href="http://www.viewsonic.com/il/">www.viewsonic.com/il/</a>
日本 (Japan)	<a href="http://www.viewsonic.com/jp/">www.viewsonic.com/jp/</a>	Korea	<a href="http://www.viewsonic.com/kr/">www.viewsonic.com/kr/</a>
Malaysia	<a href="http://www.viewsonic.com/my/">www.viewsonic.com/my/</a>	Middle East	<a href="http://www.viewsonic.com/me/">www.viewsonic.com/me/</a>
Myanmar	<a href="http://www.viewsonic.com/mm/">www.viewsonic.com/mm/</a>	Nepal	<a href="http://www.viewsonic.com/np/">www.viewsonic.com/np/</a>
New Zealand	<a href="http://www.viewsonic.com/nz/">www.viewsonic.com/nz/</a>	Pakistan	<a href="http://www.viewsonic.com/pk/">www.viewsonic.com/pk/</a>
Philippines	<a href="http://www.viewsonic.com/ph/">www.viewsonic.com/ph/</a>	Singapore	<a href="http://www.viewsonic.com/sg/">www.viewsonic.com/sg/</a>
臺灣 (Taiwan)	<a href="http://www.viewsonic.com/tw/">www.viewsonic.com/tw/</a>	ประเทศไทย	<a href="http://www.viewsonic.com/th/">www.viewsonic.com/th/</a>
Việt Nam	<a href="http://www.viewsonic.com/vn/">www.viewsonic.com/vn/</a>	South Africa & Mauritius	<a href="http://www.viewsonic.com/za/">www.viewsonic.com/za/</a>
<b>Americas</b>			
United States	<a href="http://www.viewsonic.com/us">www.viewsonic.com/us</a>	Canada	<a href="http://www.viewsonic.com/us">www.viewsonic.com/us</a>
Latin America	<a href="http://www.viewsonic.com/la">www.viewsonic.com/la</a>		
<b>Europe</b>			
Europe	<a href="http://www.viewsonic.com/eu/">www.viewsonic.com/eu/</a>	France	<a href="http://www.viewsonic.com/fr/">www.viewsonic.com/fr/</a>
Deutschland	<a href="http://www.viewsonic.com/de/">www.viewsonic.com/de/</a>	Қазақстан	<a href="http://www.viewsonic.com/kz/">www.viewsonic.com/kz/</a>
Россия	<a href="http://www.viewsonic.com/ru/">www.viewsonic.com/ru/</a>	España	<a href="http://www.viewsonic.com/es/">www.viewsonic.com/es/</a>
Türkiye	<a href="http://www.viewsonic.com/tr/">www.viewsonic.com/tr/</a>	Україна	<a href="http://www.viewsonic.com/ua/">www.viewsonic.com/ua/</a>
United Kingdom	<a href="http://www.viewsonic.com/uk/">www.viewsonic.com/uk/</a>		

# Limited Warranty

## VIEWSONIC Chromebox

### What the warranty covers:

ViewSonic warrants its products to be free from defects in material and workmanship, under normal use, during the warranty period. If a product proves to be defective in material or workmanship during the warranty period, ViewSonic will, at its sole option, repair or replace the product with a like product. Replacement product or parts may include remanufactured or refurbished parts or components.

### How long the warranty is effective:

ViewSonic Chromebox are warranted for 1 year for labor from the date of the first customer purchase.

### Who the warranty protects:

This warranty is valid only for the first consumer purchaser.

### What the warranty does not cover:

1. Any product on which the serial number has been defaced, modified or removed.
2. Damage, deterioration or malfunction resulting from:
  - a. Accident, misuse, neglect, fire, water, lightning, or other acts of nature, unauthorized product modification, or failure to follow instructions supplied with the product.
  - b. Repair or attempted repair by anyone not authorized by ViewSonic.
  - c. Causes external to the product, such as electric power fluctuations or failure.
  - d. Use of supplies or parts not meeting ViewSonic's specifications.
  - e. Normal wear and tear.
  - f. Any other cause which does not relate to a product defect.
3. Any product exhibiting a condition commonly known as "image burn-in" which results when a static image is displayed on the product for an extended period of time.

### How to get service:

1. For information about receiving service under warranty, contact ViewSonic Customer Support (please refer to Customer Support page). You will need to provide your product's serial number.
2. To obtain warranted service, you will be required to provide (a) the original dated sales slip, (b) your name, (c) your address, (d) a description of the problem, and (e) the serial number of the product.
3. Take or ship the product freight prepaid in the original container to an authorized ViewSonic service center or ViewSonic.
4. For additional information or the name of the nearest ViewSonic service center, contact ViewSonic.

### Limitation of implied warranties:

There are no warranties, express or implied, which extend beyond the description contained herein including the implied warranty of merchantability and fitness for a particular purpose.

### Exclusion of damages:

ViewSonic's liability is limited to the cost of repair or replacement of the product. ViewSonic shall not be liable for:

1. Damage to other property caused by any defects in the product, damages based upon inconvenience, loss of use of the product, loss of time, loss of profits, loss of business opportunity, loss of goodwill, interference with business relationships, or other commercial loss, even if advised of the possibility of such damages.
2. Any other damages, whether incidental, consequential or otherwise.
3. Any claim against the customer by any other party.

<b>Contact Information for Sales &amp; Authorized Service (Centro Autorizado de Servicio) within Mexico:</b>	
<b>Name, address, of manufacturer and importers:</b> México, Av. de la Palma #8 Piso 2 Despacho 203, Corporativo Interpalmas, Col. San Fernando Huixquilucan, Estado de México Tel: (55) 3605-1099 <a href="http://www.viewsonic.com/la/soporte/index.htm">http://www.viewsonic.com/la/soporte/index.htm</a>	
<b>NÚMERO GRATIS DE ASISTENCIA TÉCNICA PARA TODO MÉXICO: 001.866.823.2004</b>	
<b>Hermosillo:</b> Distribuciones y Servicios Computacionales SA de CV. Calle Juarez 284 local 2 Col. Bugambillas C.P: 83140 Tel: 01-66-22-14-9005 E-Mail: <a href="mailto:disc2@hmo.megared.net.mx">disc2@hmo.megared.net.mx</a>	<b>Villahermosa:</b> Compumantenimientos Garantizados, S.A. de C.V. AV. GREGORIO MENDEZ #1504 COL, FLORIDA C.P. 86040 Tel: 01 (993) 3 52 00 47 / 3522074 / 3 52 20 09 E-Mail: <a href="mailto:compumantenimientos@prodigy.net.mx">compumantenimientos@prodigy.net.mx</a>
<b>Puebla, Pue. (Matriz):</b> RENTA Y DATOS, S.A. DE C.V. Domicilio: 29 SUR 721 COL. LA PAZ 72160 PUEBLA, PUE. Tel: 01(52).222.891.55.77 CON 10 LINEAS E-Mail: <a href="mailto:datos@puebla.megared.net.mx">datos@puebla.megared.net.mx</a>	<b>Veracruz, Ver.:</b> CONEXION Y DESARROLLO, S.A DE C.V. Av. Americas # 419 ENTRE PINZÓN Y ALVARADO Fracc. Reforma C.P. 91919 Tel: 01-22-91-00-31-67 E-Mail: <a href="mailto:gacosta@qplus.com.mx">gacosta@qplus.com.mx</a>
<b>Chihuahua</b> Soluciones Globales en Computación C. Magisterio # 3321 Col. Magisterial Chihuahua, Chih. Tel: 4136954 E-Mail: <a href="mailto:Cefeo@soluglobales.com">Cefeo@soluglobales.com</a>	<b>Cuernavaca</b> Compusupport de Cuernavaca SA de CV Francisco Leyva # 178 Col. Miguel Hidalgo C.P. 62040, Cuernavaca Morelos Tel: 01 777 3180579 / 01 777 3124014 E-Mail: <a href="mailto:aquevedo@compusupportcva.com">aquevedo@compusupportcva.com</a>
<b>Distrito Federal:</b> QPLUS, S.A. de C.V. Av. Coyoacán 931 Col. Del Valle 03100, México, D.F. Tel: 01(52)55-50-00-27-35 E-Mail: <a href="mailto:gacosta@qplus.com.mx">gacosta@qplus.com.mx</a>	<b>Guadalajara, Jal.:</b> SERVICRECE, S.A. de C.V. Av. Niños Héroes # 2281 Col. Arcos Sur, Sector Juárez 44170, Guadalajara, Jalisco Tel: 01(52)33-36-15-15-43 E-Mail: <a href="mailto:mmiranda@servicrece.com">mmiranda@servicrece.com</a>
<b>Guerrero Acapulco</b> GS Computación (Grupo Sesicomp) Progreso #6-A, Colo Centro 39300 Acapulco, Guerrero Tel: 744-48-32627	<b>Monterrey:</b> Global Product Services Mar Caribe # 1987, Esquina con Golfo Pérsico Fracc. Bernardo Reyes, CP 64280 Monterrey N.L. México Tel: 8129-5103 E-Mail: <a href="mailto:aydeem@gps1.com.mx">aydeem@gps1.com.mx</a>
<b>MÉRIDA:</b> ELECTROSER Av Reforma No. 403Gx39 y 41 Mérida, Yucatán, México CP97000 Tel: (52) 999-925-1916 E-Mail: <a href="mailto:rrrb@sureste.com">rrrb@sureste.com</a>	<b>Oaxaca, Oax.:</b> CENTRO DE DISTRIBUCION Y SERVICIO, S.A. de C.V. Murguía # 708 P.A., Col. Centro, 68000, Oaxaca Tel: 01(52)95-15-15-22-22 Fax: 01(52)95-15-13-67-00 E-Mail: <a href="mailto:gpotai2001@hotmail.com">gpotai2001@hotmail.com</a>
<b>Tijuana:</b> STD Av Ferrocarril Sonora #3780 L-C Col 20 de Noviembre Tijuana, Mexico	<b>FOR USA SUPPORT:</b> ViewSonic Corporation 10 Pointe Dr. Suite 200. Brea, CA. 92821, UY.S.A Tel: 800-688-6688 E-Mail: <a href="http://www.viewsonic.com">http://www.viewsonic.com</a>



**ViewSonic®**