



# OneTouch™ AT G2 Network Assistant

## GETTING STARTED GUIDE

The OneTouch™ AT G2 Network Assistant is a rugged, easy to use, hand-held network analyzer.

This guide provides basic information to help you get started using the analyzer. For more detailed information, see the latest version of the *OneTouch AT G2 User Manual* provided online at [enterprise.netscout.com/support/manuals](http://enterprise.netscout.com/support/manuals).

### Warning

To prevent possible fire, electric shock, or personal injury:

- Read all safety information before you use the Product.
- Do not modify the Product.
- Use the Product only as specified, or the protection supplied by the Product can be compromised.
- Carefully read all instructions.
- Use only NETSCOUT approved power adapters.
- Do not use the Product around explosive gas, vapor, or in damp or wet environments.
- Do not use and disable the Product if it is damaged.
- Do not use the Product if it operates incorrectly.
- Examine the case before you use the Product. Look for cracks or missing plastic.
- Carefully look at the insulation around the terminals.
- Remove the input signals before you clean the Product.
- Have an approved technician repair the Product.
- Use only specified replacement parts.
- There are no user serviceable parts inside.
- The battery is the only user serviceable component.
- Do not open the case except to replace the battery.
- To clean the case, use a soft cloth that is moist with water or water and a mild detergent.



## Connectors, Keys, and LEDs

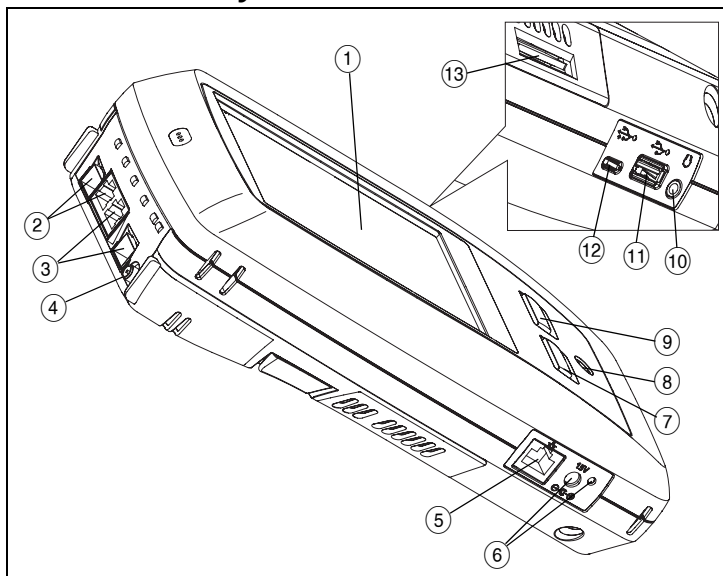





Figure 1. Connectors, Keys, and LEDs

- ① LCD display with touchscreen
- ② Wired Ethernet Port B and Fiber Port B SFP receptacle—Port B link and activity lights are located above. Port B is used for cable test, packet capture and VoIP analysis.
- ③ Wired Ethernet Port A and Fiber Port A SFP receptacle—Port A link and activity lights are located above. Connect the network under test to Port A.
- ④ External Antenna Connector—Link and activity lights are above.
- ⑤ Management Port—For remote control of the analyzer, copying files to or from the analyzer, browsing the web, SSH or telnet to switches, etc.
- ⑥ Connector for the AC adapter—The LED is red when the battery charges and green when the battery is fully charged.
- ⑦ —Press the HOME key to go to the home screen.
- ⑧ Power key. This key  turns the tester On or Off.
- ⑨ —The AutoTest key starts a test. You can also tap the AutoTest button  on the display to start a test.
- ⑩ Headset jack
- ⑪ Type A USB port—Import and export files, install software updates, connect a WebCam or video probe, or connect an optional Wi-Fi adapter.
- ⑫ Micro-AB USB port—This connector is reserved for future use.
- ⑬ SD card slot—Capture files are stored on the SD card. You can import or export Profiles and other files using the SD card.

# The HOME Screen

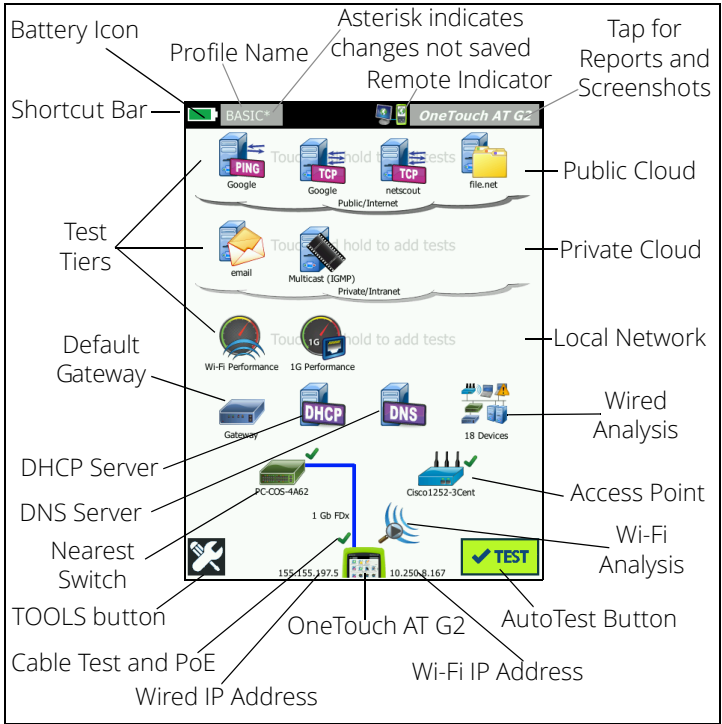

Figure 2. The HOME Screen

The Shortcut Bar is located at the top of the display. When all tests complete, the Shortcut Bar turns green if all tests passed, or red if any test failed.

- The **Battery Icon** turns red when the charge falls below 20%.
- Tap the **Profile Name** to save, load, and manage test profiles.
- An asterisk (\*) indicates that the Profile contains changes that have not been saved.
- The **Remote Indicator** appears when a remote connection to the OneTouch analyzer is established.
- Tap the **OneTouch AT G2** button to take a screen shot or to save test results to a report.

The **Test Tiers** contain User Tests, which are custom tests that you can create and modify.

- Touch and hold white space on a test tier to add a new **User Test**.
- Tap a User Test icon, and then tap the **SETUP** tab to configure the test. Tap the **RESULTS** tab to see the test's results.
- Touch and hold a User Test if you want to move, copy, or delete it.

**Network infrastructure tests** are located below the user tests.

- Tap the **Default Gateway** icon to identify the IP and MAC addresses of the current IPv4, IPv6, and Wi-Fi router, show routing protocols, etc. Configure SNMP for the most complete results. Tap the **TOOLS**

button , then tap **Analysis**.

- Tap the **DHCP Server** to view the process and results of acquiring an IP address via DHCP on both the wired and Wi-Fi connections.
- Tap the **DNS Server** button to view the performance of DNS servers resolving the specified URL.
- Tap the **Wired Analysis** icon to see wired devices discovered in the broadcast domain. See “Wired Analysis” in this guide.

The Nearest Switch and Wi-Fi Network Connect tests are below the network infrastructure tests.

- Tap the **Nearest Switch** to show the switch name, model, port and VLAN of the wired connection. If SNMP is enabled, additional information is available.
- Tap the **Access Point** icon for **Wi-Fi Network Connect** test results. The target SSID and its security credentials must be included in the loaded profile.

The media tests are next as you move down the screen.

- **Cable/Link/PoE** provides
  - cable test, if the analyzer cannot link
  - link speed, duplex, receive pair, level, and polarity
  - PoE class and type, unloaded voltage measurement, and TruePower™ loaded voltage and power measurements
- The **Wi-Fi Analysis** icon to see discovered devices in your wireless network. See “Wi-Fi Analysis” in this guide.

The following icons are at the bottom of the screen.

- **TOOLS**  are discussed later in this document.
- The **Wired IP Address** is shown to the left of the OneTouch AT G2 Instrument icon; the Wi-Fi IP address is to the right.
- Tap the **OneTouch AT G2 instrument icon** at the bottom of the screen for wired and Wi-Fi network connection details, errors, statistics, and more.
- The **AutoTest** button initiates link and runs infrastructure tests and user tests.

## How to Run an AutoTest

AutoTest provides a comprehensive test of network infrastructure tests, along with user-defined tests.

**The OneTouch G2 analyzer does not initiate any link, user test, or infrastructure test activity until you run AutoTest.**



### 1. Power the Analyzer

Connect the AC adapter to charge the battery if necessary.

### 2. Connect to the Network

Connect the network under test to Port A (Item ③ in Figure 1). You can use the RJ-45 Ethernet jack for copper cable, or an SFP inserted in the SFP receptacle for fiber cable.



### 3. Run AutoTest

Tap the **AutoTest** button  (located at the lower-right corner of the HOME screen), or press the **AutoTest** key (located on the front panel) . The OneTouch G2 analyzer will:

- Link on active ports (wired and/or Wi-Fi ports)
- Obtain IP addresses
- Run Network Infrastructure Tests
- Run User Tests - When multiple User Tests are present, they run starting with the lower-left test on the bottom test tier and finishing with the upper-right test on the top test tier.

### 4. View the Test Results.

To see a test's detailed results, tap its icon on the HOME screen. The test's **SETUP** or **RESULTS** tab is displayed. Tap a tab to open it

The test's status (pass  or fail ) is indicated at the lower left corner of the **RESULTS** tab.

When you tap the AutoTest key or the AutoTest button again, all test results are cleared and the tests run again.

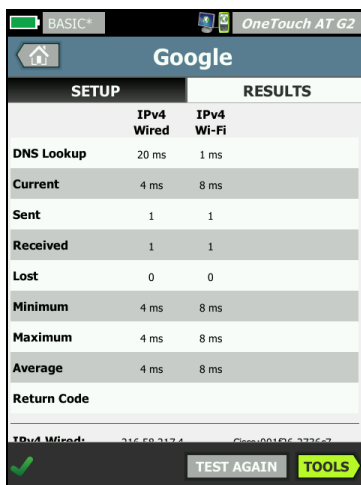

	RESULTS	
	IPv4 Wired	IPv4 Wi-Fi
DNS Lookup	20 ms	1 ms
Current	4 ms	8 ms
Sent	1	1
Received	1	1
Lost	0	0
Minimum	4 ms	8 ms
Maximum	4 ms	8 ms
Average	4 ms	8 ms
Return Code		

### 5. Create a Report

To create a comprehensive network performance report:

- 1 Tap the **OneTouch AT G2** button , which is in the shortcut bar at the top of the HOME screen.
- 2 Tap the **Save Report** button.
- 3 Change the file name if desired, then tap the **DONE** button.

You can also configure your OneTouch to **automatically upload** test results to the Link-Live Cloud Service. See ["How to Claim your OneTouch AT to the Link-Live Cloud Service"](#) on the next page.

To manage reports, tap the **TOOLS** button, then scroll down to the File Tools section. Select the **Reports** button to open the report file manager.

### 6. Add a User Test

Touch and hold white space on a test tier to add a new User Test. Run AutoTest again to view the results.

### 7. Save a Profile

To save a Profile:

- 1 Configure the analyzer as desired (add User Tests, change settings, etc.).

- 2 Tap the Profile name, which is in the shortcut bar at the top of the HOME screen.
- 3 Tap the **SAVE** button.
- 4 To create a new profile, enter its name and tap the **DONE** button. To use the existing name, tap the **DONE** button.

## Load a Different Profile

To load a profile, tap the profile name at the top of the screen and select the profile you want to load from the list.

## How to Claim your OneTouch AT to the Link-Live Cloud Service

Link-Live Cloud Service is a free, online system for viewing, tracking, and organizing your test results, which can be automatically uploaded once you claim your device.

- 1 Create an account at [Link-Live.com](http://Link-Live.com), or if you already have an account, sign in.

If you are a new Link-Live user, the pop-up box will appear automatically and prompt you to claim a device.

- 2 In the Link-Live **Claim Unit** pop-up box, select the OneTouch AT image.
- 3 Follow the on-screen instructions to finish claiming.

## Wired Analysis

During wired analysis, the OneTouch G2 discovers devices in the broadcast domain or connected to APs in the broadcast domain, the server specified in the DNS test, the servers specified in user tests, and additional devices, through passive discovery.

When the analyzer is connected to a trunk port and is not configured for a VLAN, all devices on the trunk are discovered. When the analyzer is connected to a trunk port and is configured for a VLAN, only devices in the same VLAN are discovered.

Devices are categorized and displayed on the WIRED ANALYSIS screen. A summary view of hosts, access devices, and servers provides an overview of devices on the network along with relevant details such as IP address, MAC address, switch slot and port, utilization, and problems.

## Wi-Fi Analysis

The OneTouch AT G2 analyzer's Wi-Fi analysis consists of discovery and analysis of 802.11 networks, access points, clients, and channels being used. It can also identify, classify, and locate non-802.11 interfering devices.

Tools are available for troubleshooting client connectivity. The analyzer supports 802.11 a/b/g/n/ac technologies, operating in the 2.4-GHz and/or 5-GHz bands. Wi-Fi must be enabled for Wi-Fi analysis to begin.

## How to configure the analyzer to link to a Wi-Fi network

- 1 On the HOME screen, tap **TOOLS** .
- 2 Tap the **Wi-Fi** button.
- 3 Ensure that **Enable Wi-Fi** and **Enable Connect** are **On**.
- 4 Tap the **SSID** button and select a network.
- 5 Tap the **Security** button and enter the network's credentials.
- 6 Run AutoTest.

The **Wi-Fi Analysis** icon on the Home screen changes to indicate Wi-Fi link or scanning status.



Stopped - Tap the icon to initiate Wi-Fi analysis.



Linked and Testing



Linked but not testing - When AutoTest completes, the link is maintained. Tap the icon to drop the Wi-Fi link, start Wi-Fi scanning, and view the Wi-Fi ANALYSIS screen.













Scanning - The analyzer is performing Wi-Fi analysis (scanning). Tap the icon to display the Wi-Fi ANALYSIS screen.

## Tools

Tap the **TOOLS** button  to access the following:

- **Setup Wizard**—guides you in configuring your device profiles
- **Test Settings**—wired and Wi-Fi connection settings
- **Cloud Tools**—use to interact with the Link-Live Cloud Service: AutoTest, Trending, Claim Unit, Unit Name, and Cloud Remote
- **Testing Tools**—packet capture, VoIP Analysis, Wi-Fi network validation, Performance Peer, web browser, Telnet/SSH, Toner, Flash Port, and FiberInspector/WebCam
- **File Tools**—use to manage profiles, AP authorization lists, reports, and screen captures
- **Maintenance Tools**—battery status, language, date and time, units, display brightness, etc.

## Symbols, Certification and Compliance

	Warning or Caution. Risk of damage or destruction to equipment or software.
	Warning: Risk of fire, electric shock, or personal injury.
	Warning: Class 1 laser when an SFP module is installed. Do not look directly into optical connectors. Risk of eye damage from hazardous radiation.
	Conformite Europeene. Conforms to the requirements of the European Union and the European Free Trade Association (EFTA).
	Listed by the Canadian Standards Association.
	This product complies with Australian standards.
	Meets RoHS directive.
	Do not put products containing circuit boards into the garbage. Dispose of circuit board in accordance with local regulations.
	Do not connect the device to a telephone line or an ISDN line.
	Conforms to relevant South Korean EMC Standards.

## Regulatory Statements

Brazil Regulatory Statement	Este equipamento opera em caráter secundário, isto é, não tem direito a proteção contra interferência prejudicial, mesmo de estações do mesmo tipo, e não pode causar interferência a sistemas operando em caráter primário.
Korea Electromagnetic Compatibility. Applies to use in Korea only. Class A Equipment (Industrial Broadcasting & Communications Equipment)	This product meets requirements for industrial (Class A) electromagnetic wave equipment and the seller or user should take notice of it. This equipment is intended for use in business environments and is not to be used in homes.
Mexico Cofetel Notice	La operación de este equipo está sujeta a las siguientes dos condiciones: (1) es posible que este equipo o dispositivo no cause interferencia perjudicial y (2) este equipo o dispositivo debe aceptar cualquier interferencia, incluyendo la que pueda causar su operación no deseada.



Taiwan  
Regulatory  
Compliance Warning  
for Access Points  
according to rule of  
LP0002

低功率電波輻射性電機管理辦法  
經型式認證合格之低功率射頻電機，非經許可，公司、商號或使用者均不得擅自變更頻率、加大功率或變更原設計之特性及功能。  
低功率射頻電機之使用不得影響飛航安全及干擾合法通信；經發現有干擾現象時，應立即停用，並改善至無干擾時方得繼續使用。  
前項合法通信，指依電信法規定作業之無線電通信。  
低功率射頻電機須忍受合法通信或工業、科學及醫療用電波輻射性電機設備之干擾。

## General Specifications

**Battery Type:** Rechargeable lithium ion battery pack

**Temperature:**

Operating: 32°F to 122°F (0°C to +50°C)

Charging: 0 C to +40 C

Storage: -40°F to 160°F (-40°C to +71°C)

**Operating altitude:** 13,123 ft (4,000 m) and 10,500 ft (3,200 m) with AC adapter

**Storage altitude:** 39,370 ft (12,000 m)

**Safety:** IEC 61010-1: CAT None, Pollution Degree 2

**EMC:** IEC 61326-1: portable

## Technical Specifications

You can find the Product's technical specifications in the User Manual, available online at [enterprise.netscout.com](http://enterprise.netscout.com).

## Registration

Registering your product gives you access to valuable information on product updates, troubleshooting tips, and other support services. To register online, visit [enterprise.netscout.com/registration](http://enterprise.netscout.com/registration).

The Setup Wizard, which appears when you initially power on the analyzer, guides you through registering the product and configuring the analyzer's settings and tests.

To check your Registration status, tap **TOOLS** , and under **Maintenance Tools**, tap **Product Registration**.

## Contact NETSCOUT



[enterprise.netscout.com](http://enterprise.netscout.com)



[customer care@netscout.com](mailto:customer care@netscout.com)



Toll free: +1-844-833-3713

International: 978-320-2150

For more contact information, go to our website.

## LEGAL NOTIFICATION

Use of this product is subject to the End User License Agreement available at <http://www.netscout.com/legal/terms-and-conditions/> or which accompanies the product at the time of shipment or, if applicable, the legal agreement executed by and between NETSCOUT SYSTEMS, INC., and the purchaser of this product ("Agreement").

Government Use and Notice of Restricted Rights: In U.S. government ("Government") contracts or subcontracts, Customer will provide that the Products and Documentation, including any technical data (collectively "Materials"), sold or delivered pursuant to this Agreement for Government use are commercial as defined in Federal Acquisition Regulation ("FAR") 2.101 and any supplement and further are provided with RESTRICTED RIGHTS. All Materials were fully developed at private expense. Use, duplication, release, modification, transfer, or disclosure ("Use") of the Materials is restricted by the terms of this Agreement and further restricted in accordance with FAR 52.227-14 for civilian Government agency purposes and 252.227-7015 of the Defense Federal Acquisition Regulations Supplement ("DFARS") for military Government agency purposes, or the similar acquisition regulations of other applicable Government organizations, as applicable and amended. The Use of Materials is restricted by the terms of this Agreement, and, in accordance with DFARS Section 227.7202 and FAR Section 12.212, is further restricted in accordance with the terms of NETSCOUT's commercial End User License Agreement. All other Use is prohibited, except as described herein.

This Product may contain third-party technology. NETSCOUT may license such third-party technology and documentation ("Third-Party Materials") for use with the Product only. In the event the Product contains Third-Party Materials, or in the event you have the option to use the Product in conjunction with Third-Party Materials (as identified by NETSCOUT in the applicable Documentation), then such third-party materials are provided or accessible subject to the applicable third-party terms and conditions contained in the "Read Me" or "About" file located on the Application CD for this Product. To the extent the Product includes Third-Party Materials licensed to NETSCOUT by third parties, those third parties are third-party beneficiaries of, and may enforce, the applicable provisions of such third-party terms and conditions.

Open-Source Software Acknowledgment: This product may incorporate open-source components that are governed by the GNU General Public License ("GPL") or licenses that are compatible with the GPL license ("GPL Compatible License"). In accordance with the terms of the GNU GPL, NETSCOUT will make available a complete, machine-readable copy of the source code components of this product covered by the GPL or applicable GPL Compatible License, if any, upon receipt of a written request. Please identify the product and send a request to:

NETSCOUT SYSTEMS, INC.  
GNU GPL Source Code Request  
310 Littleton Road  
Westford, MA 01886  
Attn: Legal Department

NETSCOUT SYSTEMS, INC. reserves the right, at its sole discretion, to make changes at any time in its technical information, specifications, service, and support programs.