

newline

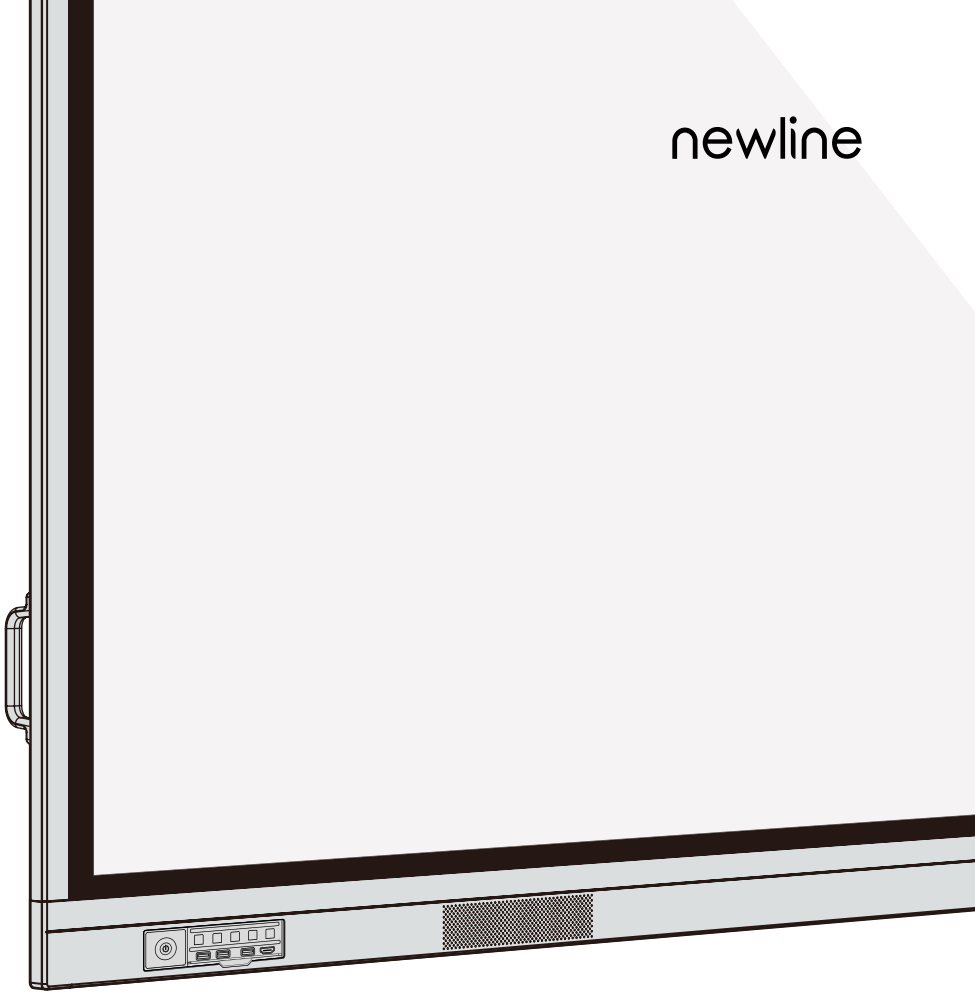

*VN Series*  
Interactive Touch Screen  
**Quick Start Manual**



Welcome to the world of Newline.

Thank you for choosing the Newline VN Series interactive display. Please use this document to get the most out of your display.

---

This device complies with part 15 of the FCC Rules. Operation is subject to the following two conditions:(1) This device may not cause harmful interference, and (2) this device must accept any interference received, including interference that may cause undesired operation.

NOTE 1:This equipment has been tested and found to comply with the limits for a Class B digital device, pursuant to part 15 of the FCC Rules. These limits are designed to provide reasonable protection against harmful interference in a residential installation. This equipment generates, uses and can radiate radio frequency energy and, if not installed and used in accordance with the instructions, may cause harmful interference to radio communications. However, there is no guarantee that interference will not occur in a particular installation. If this equipment does cause harmful interference to radio or television reception, which can be determined by turning the equipment off and on, the user is encouraged to try to correct the interference by one or more of the following measures:

- Reorient or relocate the receiving antenna.
- Increase the separation between the equipment and receiver.
- Connect the equipment into an outlet on a circuit different from that to which the receiver is connected.
- Consult the dealer or an experienced radio/TV technician for help.

NOTE 2: Any changes or modifications to this unit not expressly approved by the party responsible for compliance could void the user's authority to operate the equipment.

---



The symbol of the crossed out wheeled bin indicates this product should not be placed in municipal waste. Instead, dispose of waste equipment by handing it over to a designated collection point for the recycling of electrical and electronic equipment.



# Symbol Conventions

.....



Symbols are used in this document to indicate operations that need particular attention. The symbols are defined as follows:

 <b>NOTE</b>	Provides additional information to supplement operation in the main text.
 <b>CAUTION</b>	Indicates a potentially hazardous situation that, if not avoided, could result in equipment damage, data loss, performance deterioration, or unanticipated results.
 <b>WARNING</b>	Indicates a hazard with risk that, if not avoided, could result in death or injury.







# Safety Instruction

.....

For your safety, please read the following instruction before you use the product. Serious injury or property damage may be caused by improper operations. Do not try to repair the product on your own.

 <b>WARNING</b>	
	<p><b>Disconnect the product from power supply immediately if major failures occur.</b></p> <p>Major failures include the following:</p> <ul style="list-style-type: none"><li>• Smoke, peculiar smell or abnormal sound is discharged from the product.</li><li>• No image or sound is displayed, or the image error occurs.</li></ul> <p>In the preceding scenarios, do not continue to use the product. Disconnect power supply immediately and contact professional staff for troubleshooting.</p>
	<p><b>Do not drop liquid, metal or anything combustible into the product.</b></p> <ul style="list-style-type: none"><li>• If any liquid or metal is dropped into the product, power off the product and disconnect power supply, then contact professional staff for solutions.</li><li>• Pay attention to children when they are close to the product.</li></ul>

## **WARNING**

	<p><b>Put the product on a stable surface.</b></p> <p>An unstable surface includes and does not limited to an inclined plane, a shaky stand, desk or platform, which might cause turnover and damage.</p>
	<p><b>Do not open the cover or change the product on your own.</b></p> <p>High voltage components are installed in the product. When you open the cover, high voltage, electric shock, or other dangerous situations may occur.</p> <p>If inspection, adjustment, or maintenance is required, contact the local distributor for help.</p>
	<p><b>Use the specified power supply.</b></p> <ul style="list-style-type: none"><li>• To prevent the product from being damaged, do not use any cables other than the one provided with the product.</li><li>• Use a three-wire socket and ensure that it is properly grounded.</li><li>• Pull out the power plug from the socket if the product is not used for a long period.</li></ul>
	<p><b>Clean the dust and metal on the power plug regularly.</b></p> <ul style="list-style-type: none"><li>• Fire or electric shock may be caused if the product is powered on, when you are cleaning.</li><li>• Pull out the power plug before cleaning it with a dried cloth.</li></ul> <p>The voltage/current of the rear power output port is 5 V/2 A (maximum). Purchase the power code/AC adapter according to customer needs. The port can be used for Newline Android box X10D. Please do not connect any products with different power requirement. Otherwise, it may cause damage to products or fire.</p>
	<p><b>Do not put items on the top of the product.</b></p> <ul style="list-style-type: none"><li>• Do not put items, such as a container for liquid (a vase, flowerpot, cosmetics or liquid medicine) on the top of the product.</li><li>• If any water or liquid is spilled on the product, a short circuit may occur and cause fire or electric shock.</li><li>• Do not walk on or hang any items on the product.</li></ul>
	<p><b>Do not install the product in an improper place.</b></p> <ul style="list-style-type: none"><li>• Do not install the product in humid places, such as the bathroom, the shower room, near windows, or outdoor environments that experience rain, snow or other harsh weather. Avoid installation near hot spring vapor. The preceding environments may cause faults in the product or electric shock under extreme conditions.</li><li>• Do not put exposed fire source, such as an ignited candle, on the product.</li></ul>
	<p><b>Pull out the power plug during thunderstorms.</b></p> <ul style="list-style-type: none"><li>• Do not touch the product during a lighting storm to avoid electric shock.</li><li>• Install or place components that supply high enough voltage to cause personal injury out of the reach of children.</li></ul>

## **WARNING**



**Do not touch the power cable with wet hands.**

## **CAUTION**



**Do not install the product in high temperature environments.**

- Do not install the product near a heat source, such as a radiator, a heat reservoir, a stove or other heating products.
- Do not expose the product to direct sunlight, which may cause high temperatures and subsequent faults in the product.



**For transport.**

- Pack the product for transport or maintenance by using the cartons and cushioning material provided with the product.
- Vertically move the product during transport. The screen or other components are easily broken if the product is moved by an improper way.
- Before you move the product, disconnect all external connections and separate all toppling preventing products. Move the product carefully to prevent it from being hit or squeezed, especially the screen, which may cause injury if broken.



**Do not cover or block up any vents on the product.**

- Any overheated components may cause fire, damage the product, and shorten the service life.
- Do not lay the product down where the venting surface will be covered.
- Do not install the product on a carpet or cloth.
- Do not use a cloth such as table cloth to cover the product.



**Use the battery correctly.**

- Galvanic corrosion, electric leakage, and even fire may be caused by improper battery usage.
- It is recommended to use the designated type of battery and install the battery by correct electrodes (positive and negative).
- Do not install and use a new battery with a used one.
- Take out the batteries if the remote control is not used for a long period.
- Do not expose the batteries to overheated environments such as sunlight and firing.
- Dispose of the used batteries based on your local regulations.

**Do not damage the power cable.**

- Do not damage, change, twist, bend, or forcibly drag the power cable.
- Do not put weights (such as the product itself) on the power cable.
- Do not forcibly drag the cable when you pull out the power plug. If the power cable is damaged, please contact the local distributor to repair or replace it.

## CAUTION



- The power cable in the accessory box is for this product only. Do not use it on other products.

### **Additional advice:**

- Use the product in an environment with comfortable lighting. It is harmful to your eyes to watch in a too bright or too dark environment.
- Relax your eyes after a period of time for watching.
- Keep sufficient distance from the product to protect your eyes and prevent eyestrain.
- Adjust the volume to an appropriate level, especially at night.
- Use amplifier equipment as the audio input source with caution. If you must use amplifier equipment, the input power should not exceed the maximum of speaker power. Otherwise, the speaker can become overpowered and damaged.

### **About USB port.**

Front USB 2.0 ports and rear USB 3.0/USB 2.0 ports switch connections based on signal sources. If the current signal source is reading the data from an external product connecting to the port, please switch the signal source after the data reading is complete. Otherwise, the data or product may be damaged.

### **Screen glass is broken or falls off.**

- In case of screen glass breakage, keep all personnel 3 meters away from the screen to ensure safety.
- Do not perform any installation or disassembly when the screen glass is broken or falls off.

### **Keep away from the product when you use a radio.**

The product complies with the international EMI standard to prevent radio interference. However, interference may still exist and cause noise in the radio. If noise occurs in the radio, try the following solutions.

- Adjust the direction of the radio antenna to avoid the interference from the product.
- Keep the radio away from the product.

# A

# Parts and Functions

## Parts

### Front View

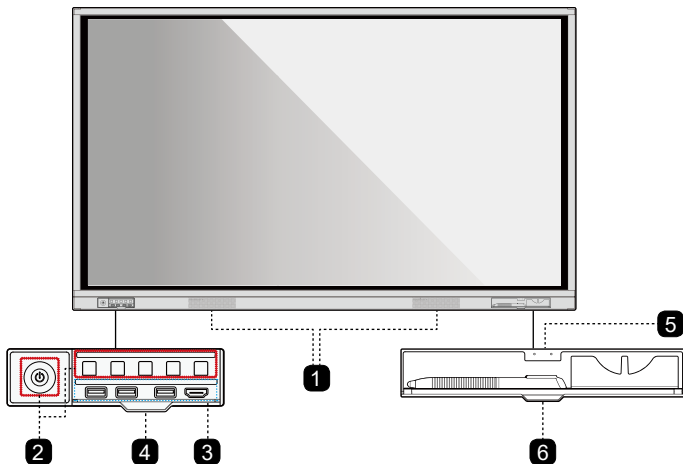

### Rear View

- TT-8618VN/TT-7518VN

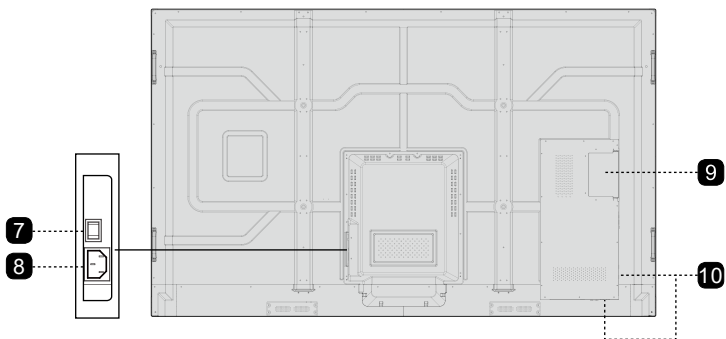



• TT-6518VN

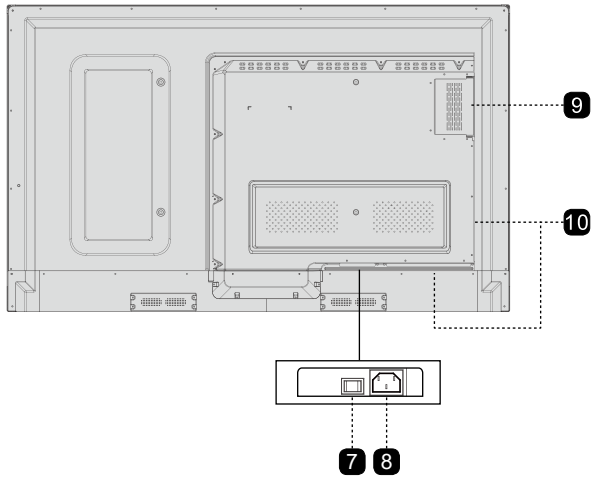

- |                                 |                                |
|---------------------------------|--------------------------------|
| <b>1</b> Speakers               | <b>2</b> Front Buttons         |
| <b>3</b> Front Ports            | <b>4</b> Button Cover          |
| <b>5</b> Pen/Eraser Tray        | <b>6</b> Pen/Eraser Tray Cover |
| <b>7</b> Power Switch           | <b>8</b> Power Supply Plug     |
| <b>9</b> Internal PC Port (OPS) | <b>10</b> Rear Ports           |

## Ports



### CAUTION

Front USB 2.0 ports and rear USB 3.0/USB 2.0 ports switch connections based on signal sources. If the current signal source is reading the data from an external product connecting to the port, please switch the signal source after the data reading is complete. Otherwise, the data or product may be damaged.

### Front Ports

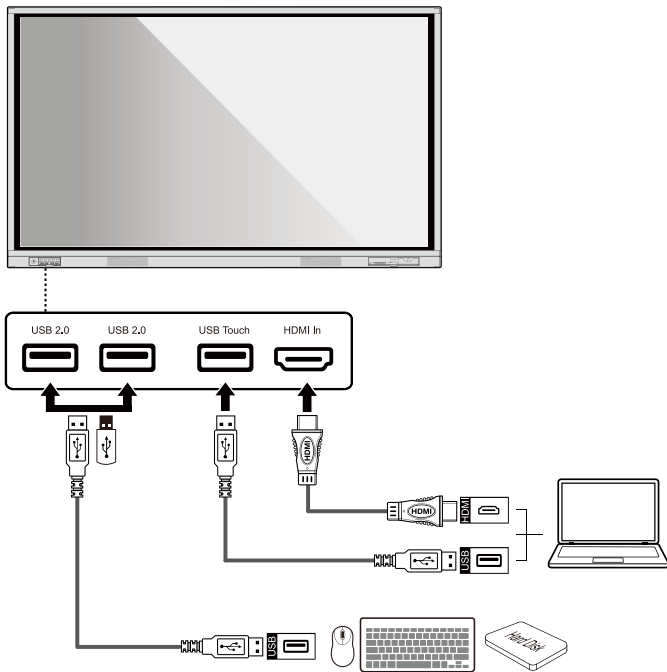

### Rear Ports



### WARNING

The voltage/current of the rear power output port is 5V/2A (maximum). Purchase the power code/AC adapter according to customer needs. The port can be used for Newline Android box X10D. Please do not connect any products with different power requirement. Otherwise it may cause the damage to products or fire.

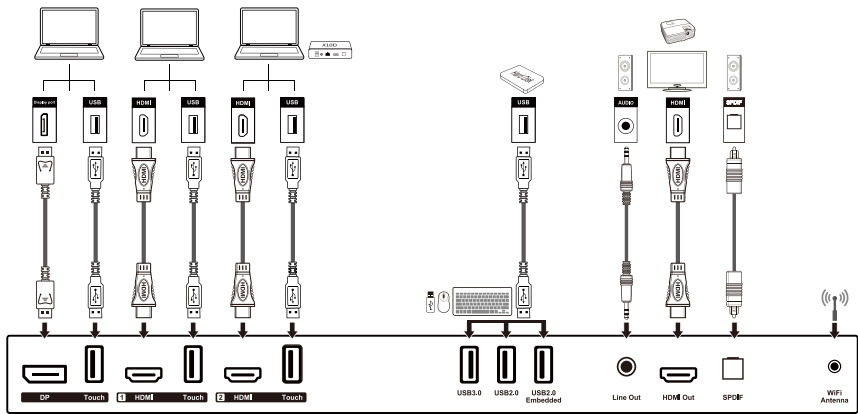

• TT-8618VN/TT-7518VN

• TT-6518VN

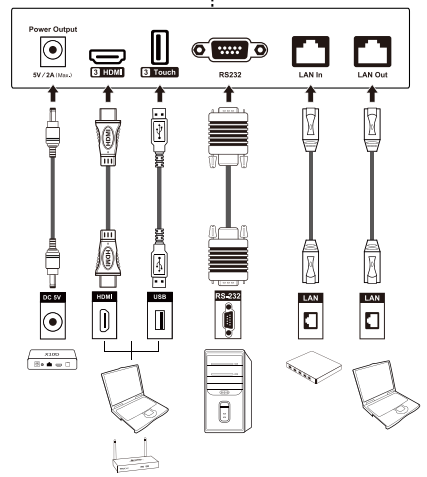
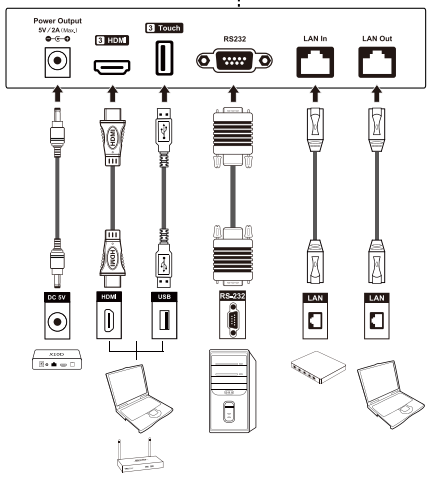
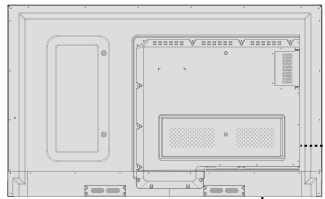
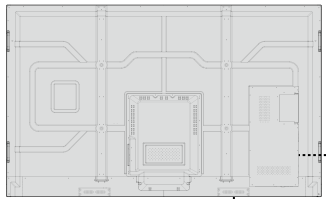

Tip:

You are advised to connect X10D to HDMI rear 2.

## Front Buttons

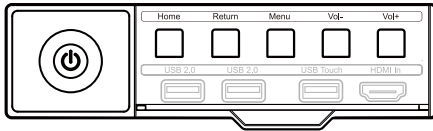

Buttons	Operations	Functions
Power	Short press	Power on/off Indicator LED status: <ul style="list-style-type: none"> <li>• Steady on red: shut down mode</li> <li>• Steady on blue: working state</li> </ul>
Home	Short press	Go to the home page
Return	Short press	Return to the last menu/Exit
Menu	Short press	Open the menu
Vol-	Short press	Decrease the sound volume
	Long press for more than 1 second	Decrease the sound volume continuously
Vol+	Short press	Increase the sound volume
	Long press for more than 1 second	Increase the sound volume continuously















## Remote Control



### CAUTION

Carefully read the following instructions before using the remote control to avoid possible faults:

- Do not drop or damage the remote control.
- Do not spill water or other liquids on the remote control.
- Do not place the remote control on a wet object.
- Do not place the remote control directly under sunlight or near an overheating heat source.

Buttons	Functions
	Power On/Off.
<b>PC</b>	Switch Source to Internal PC.
	Mute Audio.
	Freeze the Current Screen, Click Again to Exit Freeze Function.
<b>OK</b>	Confirm/OK.
	Up/Down/Left/Right.
	Return to Previous/Exit.
	<ul style="list-style-type: none"> <li>• Short Press: Go to the Home Page.</li> <li>• Long Press: View Currently Running Applications.</li> </ul>
	Take a Screenshot.
	Decrease the Sound Volume.
	Increase the Sound Volume.
	Open the System Settings.
	Page Up.
	Page Down.
	Zoom In.
	Zoom Out.
<b>Front</b>	Switch Source to HDMI Front.
<b>Rear 1</b>	Switch Source to HDMI Rear 1.
<b>Rear 2</b>	Switch Source to HDMI Rear 2.

Buttons	Functions
<b>Rear 3</b>	Switch Source to HDMI Rear 3.
	Toggle Display Backlight Mode (including Auto, Standard and EnergyStar mode).
<b>DP</b>	Switch Source to DisplayPort.
<b>Menu</b>	Open the Display Menu or External Source Menu.

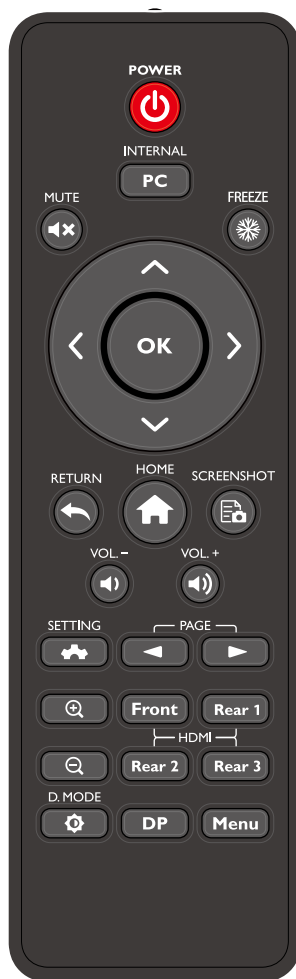

# B

# Installation Guide

## Safety Precautions

### Installation Environment



### Installation Direction

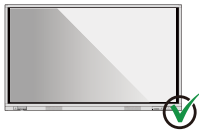

Hang the Product Horizontally



No Vertical Installation

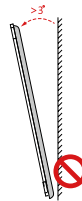

Do Not Install Tilted

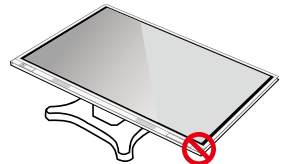

Do Not Lay Flat

## Installation Precautions

### Weight Loading

Weight of the product: 86 lb/39 kg (TT-6518VN), 111.3 lb/50.5 kg (TT-7518VN), 137.8 lb/62.5 kg (TT-8618VN)

- When using a mobile stand, please ensure the weight of the product is less than the loading capacity of the mobile stand.
- When using the wall-mount bracket, please ensure the wall can support the weight of the product. We recommend that the wall surface be reinforced and have a loading capacity 4 times of the weight of the product. Please consult a professional installer for wall-mount installation.

#### Note

The company does not undertake relevant legal responsibility for any problems caused by improper operation, if the third party mobile stand, or wall-mount bracket is beyond the scope of the product.

- Do not install the product where it might be hit by a door.

### Vertical installation

When installing, try to keep the product vertical. The vertical tilt range allowing for wall-mount installation is  $\pm 3$  degrees. Excessive tilt angle may cause the screen glass to fall off or the product to collapse.

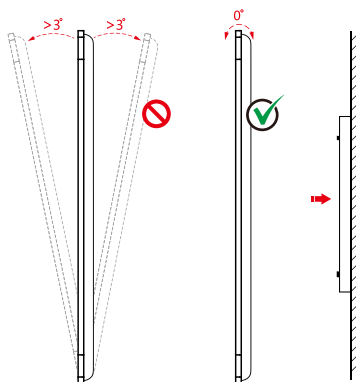

#### Note

For any problem, please contact our support desk. Our company is not responsible for any damage or losses incurred by users if the users fails to follow the instructions.

## Ventilation

Ensure adequate ventilation and/or air conditioning environment. We recommend keeping certain distances from the side of the product to the wall or panels. Ventilation requirement is shown in following figure.

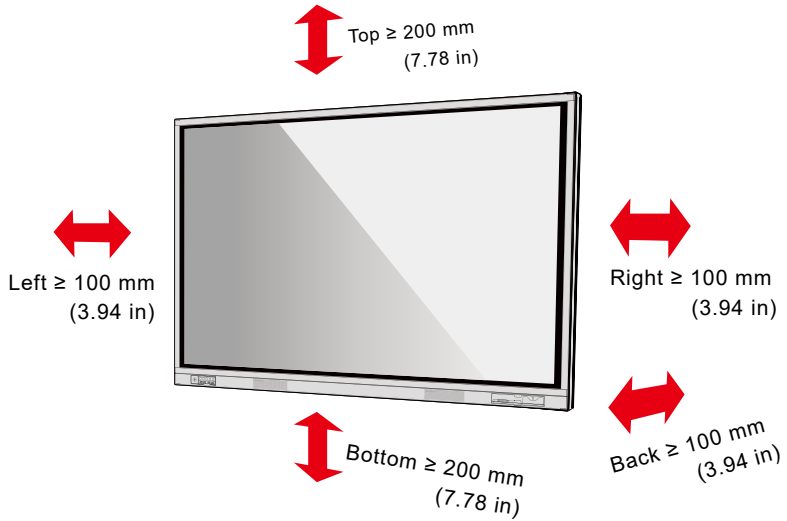



# Installation

The dimensions of the 4 bracket mounting holes on the back panel are VESA MIS-Fcompliant (TT-8618VN or TT-7518VN: 800 x 400 mm/31.50 x 15.75 in; TT-6518VN: 600 x 400 mm/23.62 x 15.75 in). Please use metric M8 screws with length of 10 to 15 mm (0.40 to 0.59 in) to secure the touch display with the mounting system. Dimensions of the mounting holes on the back panel are shown in the following figure.

## Note

Please consult a professional installer to install the display product.

- TT-8618VN/TT-7518VN

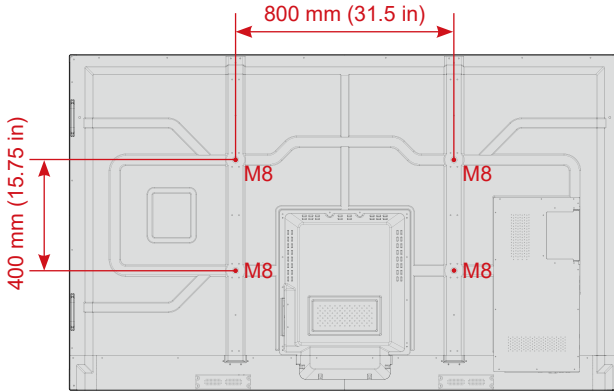

- TT-6518VN

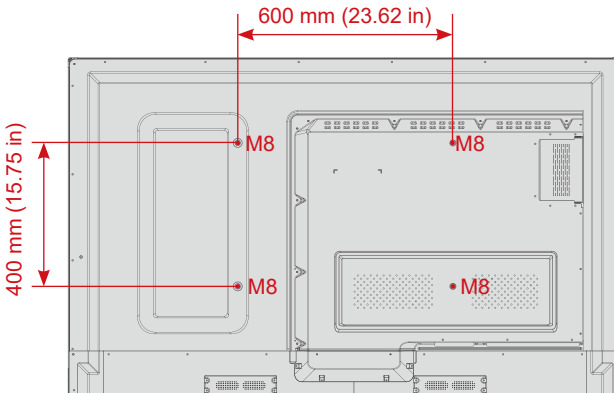

## Installing the Internal PC (Optional)

### CAUTION

The internal PC does not support hot plugging. Therefore, you must insert or remove it when the display is powered off. Otherwise, the display or internal PC may be damaged.

The internal PC is not configured by default. You will need to purchase the internal PC separately. Perform the following steps to install the internal PC.

Step 1: Unscrew the M3 screws by hand to remove the internal PC shielding cover.

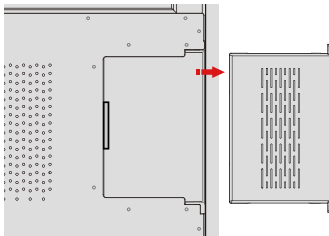

Step 2: Push the internal PC into the internal PC port at the rear of the display from right to left.

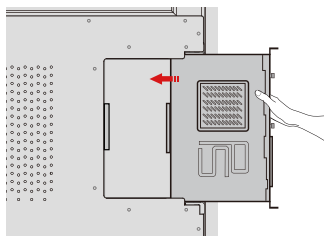

Step 3: Secure the internal PC to the display by using the M3 screws.

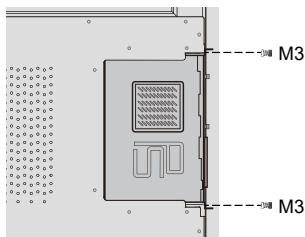

Step 4: Ensure the installation is correct before turning the power on again.

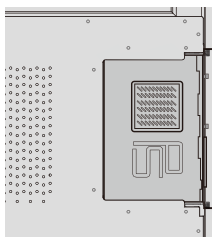

# C

## Turning On/Off

### Power On

Step 1: Plug the power supply into the power outlet fully and plug the power connector into the side of the product. Ensure the power is in the range of 100V to 240V with frequency at 50 Hz/60 Hz  $\pm$  5%. The power current must be grounded.

#### Note

The power outlet should be installed near the equipment and should be easily accessible.

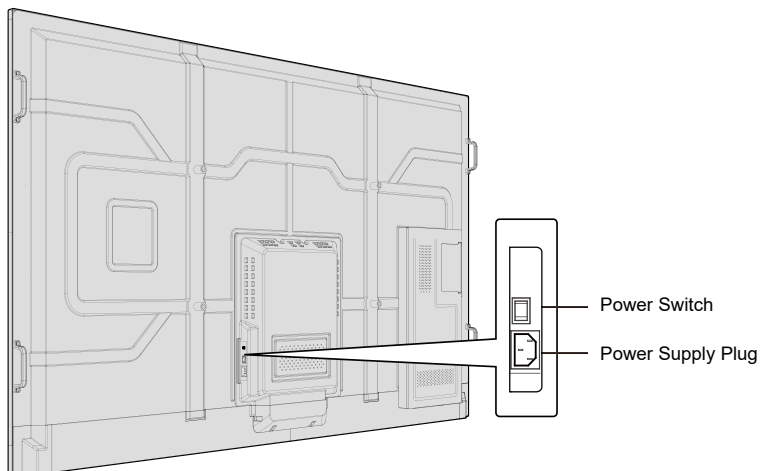

Step 2: Flip on the power switch located on the side of the product to "On".

- TT-8618VN/TT-7518VN



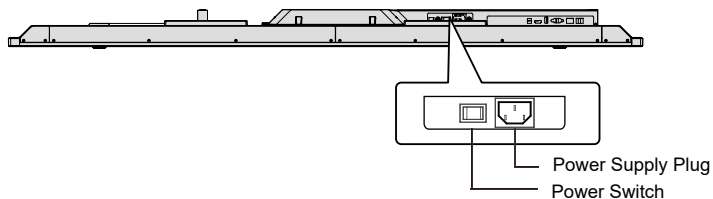

- TT-6518VN





Step 3: Press the power button  on the front control panel or  on the remote control.



## Power Off

Step 1: Power off the screen in the following situations:

- If there is no whiteboard data or screenshot(s), press the power button  on the front panel or the power button  on the remote control to power off the display. Go to Step 4.
- If there is whiteboard data or screenshot(s), store your meeting documentations before powering off the touch display. Otherwise, the product will delete your meeting documentations after the meeting is complete.

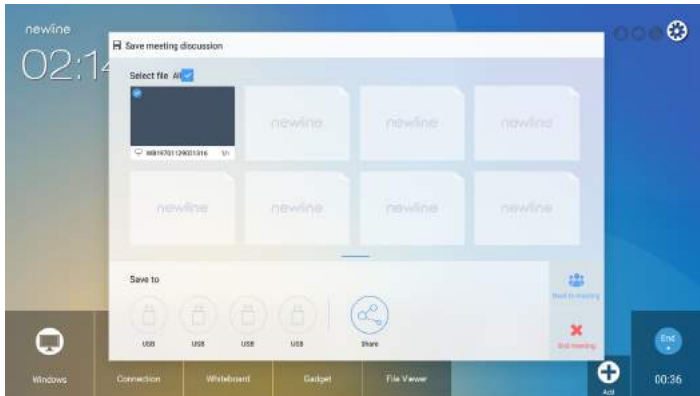
Press the power button  on the front panel or the power button  on the remote control. The **Save meeting discussion** page will be displayed as shown in the following figure.



Step 2: Press the power button  on the front panel or the power button  on the remote control again. The **Warning** dialog box will be displayed as shown in the following figure.

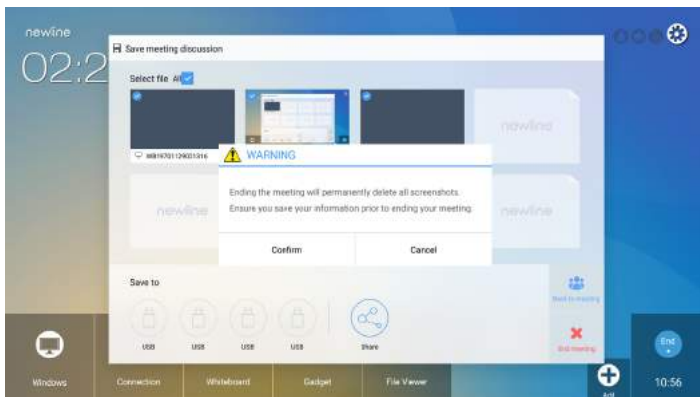

Step 3: In the **Warning** dialog box, click **Cancel**. You can save files if desired. After files are saved, return to Step 2. Click **Confirm**, and the power indicator will turn to red.

Step 4: If you are not going to use the product for an extended period of time, we recommend you to switch the power switch to “**Off**”.

 **Note**

- If an internal PC is equipped, the internal PC and the display are powered off simultaneously when you power off the system.
- Do not forcibly disconnect the power supply of the display when the internal PC is on.

# D

## Operating the Touch Screen

### Start Screen

When the product is turned on, the product will show the start screen page. As shown in the following figure.







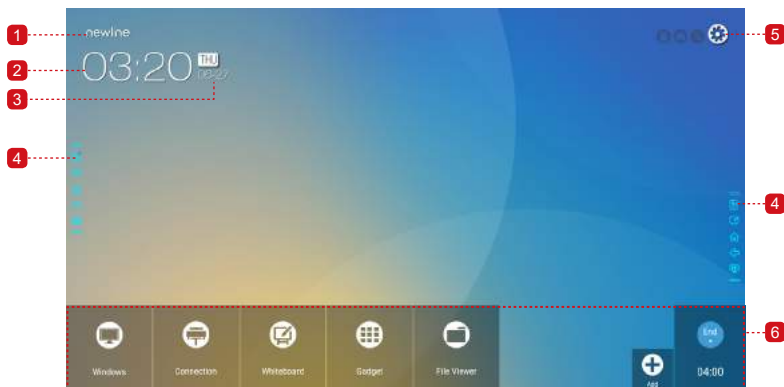

### Home

Touch the screen to start a meeting, and the product will go to the **Home** page. As shown in the following figure.



- 1 Logo (Shortcut to Settings)
- 2 Clock (Shortcut to World Clock)
- 3 Date and Week (Shortcut to Calendar)
- 4 Side Toolbar
- 5 Status Bar and Settings
- 6 Main Toolbar

## Main Toolbar

Icon	Functions
	Switch to the internal PC source.
	Click <b>Connection</b> to switch to the connected product, including cabled signal sources and wireless applications. <ul style="list-style-type: none"> <li>• Cabled signal sources include HDMI Front, HDMI Rear (1 to 3), and DisplayPort.</li> <li>• Wireless applications include Montage and Trucast.</li> </ul>
	<b>Discussion</b> provides discussion board function and screen annotation functions.
	Gadget displays all pre-installed applications, including <b>Calendar, World Clock, Browser, Settings, Viso, Newline Cast, Newline Broadcast, Display Management, Calculator, Office Viewer, File Commander</b> and <b>Email</b> . Click the icon of an application to run the application.
	Open the File Manager, and you can explore on internal and external files of the screen.
	Click <b>Add</b> to enter <b>Add</b> page, you can add up to 7 shortcuts to your favorite software, gadgets or connections to the Home page. (See more detail in “Add Shortcuts to Home Page”)
	Click <b>End</b> to end a meeting. Users will have the choice of saving the discussion boards screen captures and ending the meeting. Once a meeting is ended, all screenshots and discussion data are cleared.

### Note



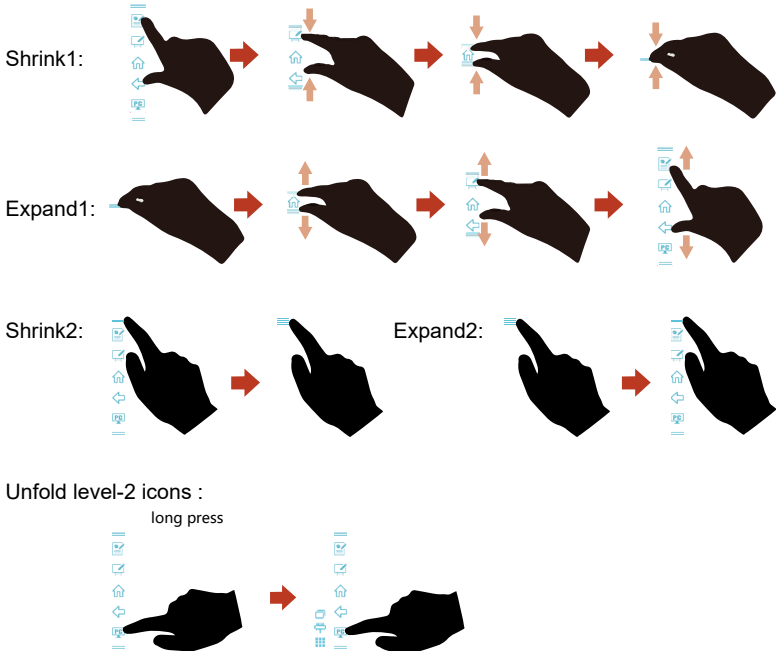

- The first time you turn the display on, only the cable connections appear in Connection. Wireless connection can be added in the **Newline Extension** setting. In this case, the name and icon of the HDMI Rear on the left cabled channel change as the Trucast application is enabled or an external product is connected.
- If the meeting notes cannot be saved to a USB flash memory successfully after the meeting, use a USB flash memory smaller than 16 GB and change the file system into FAT 32 format.

## Side Toolbar



The Annotation Mode/Discussion Mode/Home/Return/Windows icons are displayed by default in the toolbar at two sides of the screen. The bottom side toolbar can be customized as your choice (The default icon is Windows). You may also hide the side toolbar at the setting or move it up and down, shrink or expand by gestures. You may double-click the  to expand or shrink the toolbar. Long press the customized icon to unfold level-2 icons.



The functions of the side toolbar are as follows:





Icon	Functions
	Enter annotation mode, and click again to stop annotation and save screenshot.
	Enter discussion mode.
	Go to Home page.
	Return to the last menu/Exit.
	Enter the internal PC source.



Icon	Functions
	Manage currently running applications. Slide left/right the currently running application or click “x” at the upper right corner to close the application.
	Enter the favorite source.
	View all gadgets.

## Status Bar and Settings

The upper right corner of the home page displays three working status icons (including USB flash memory(s), Ethernet, and Wi-Fi), and system setting shortcut.

Icon	Functions
	If USB flash memory(s) is connected to the USB port, this icon will be turned on.
	If the product is connected to Ethernet, the icon will be turned on.
	If the product is connected to a wireless network, the icon will be turned on.
	Access the system setting page.

# E



# Add Shortcut

## Add Shortcuts to Home Page

Step 1: On **Home** page, click the **+** icon in the lower right corner. The interface for adding shortcuts will be displayed.



Step 2: Click the icons on top to switch the list between Windows programs, external signal sources, and pre-installed gadgets.

- Click  to view the Windows programs that the Newline Assistant uploads to the Smart system. For details, see "Add Quick Start Windows Programs in Smart System".
- Click  to view signal sources in **Connection**. You can set the Newline accessories to signal sources at Newline Extensions setting.

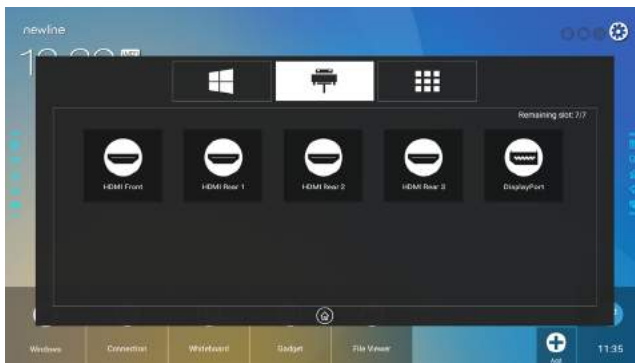

- Click  to view Gadget applications.

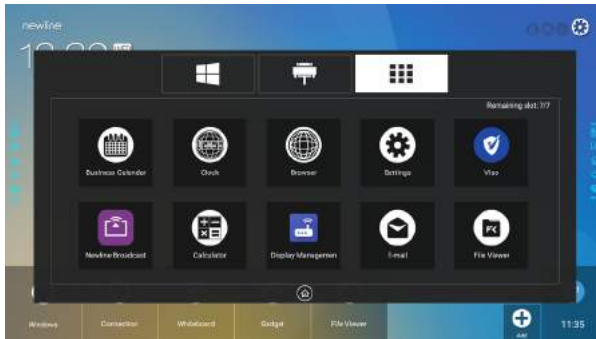

Step 3: Add or delete applications on the tab.

- In the list, click the icon to add it to the shortcut on the home page. The check icon will appear at the bottom of the shortcut icons. Up to 7 shortcuts can be added.
- Tap the icon with the check mark again, the check icon will disappear and the shortcut will be deleted from the **Home** page.

Step 4: At the **Home** page, click the shortcut icon and you can start the program/application or change to the external signal source.

## Newline Assistant

### Introduction

Newline Assistant is the tool used as a bridge between smart system and Internal PC (OPS). It helps to add windows software to smart system as well as to protect USB data/camera USB data/camera when switching between sources.

Therefore we strongly recommend users install Newline Assistant after installing the internal PC.

### Installation

Step 1: Connect Internal PC correctly (See also "Installing the Internal PC").

Step 2: On the **Home** page, click **Windows**. It will switch the signal source to Internal Windows system.

Step 3: Log in to the website [www.newline-interactive.com](http://www.newline-interactive.com) and choose **Products > VN series > Download** to download the Newline Assistant installation package.



Step 4: Install Newline Assistant as instructed.

## Add Quick Start Windows Programs in Smart System

Step 1: In Windows, run the **Newline Assistant** program and drag the software icons or folder shortcut icons that you want to add from desktop or menu to the **Newline Assistant** window. The applications added or deleted through the Windows system will be automatically updated to the smart system until the upload progress reaches 100%. If there is an application not updated, click  in the upper right corner to manually update all icons in the Newline assistant window to the smart system.

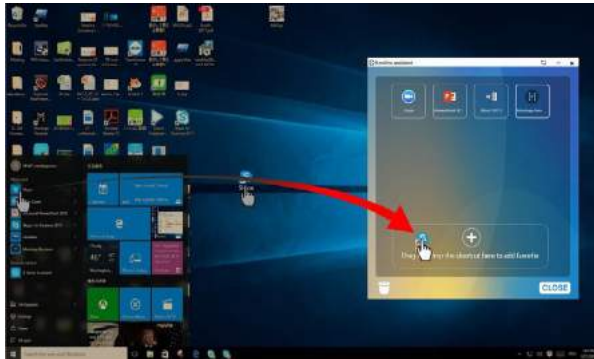
 **Tip:**  
Only .exe file and folder are supported.



Step 2: Click  to return to the **Home** page. Click the  icon and go to shortcut setting. The page for adding application program will be displayed.

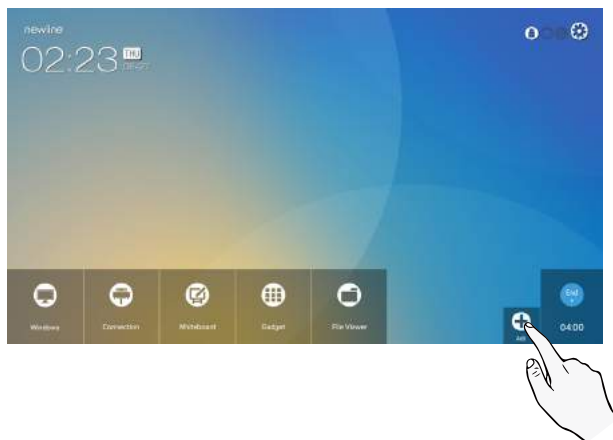

Step 3: At the shortcut setting page, click  icon to view all the Windows programs added by Newline Assistant in Step 1.

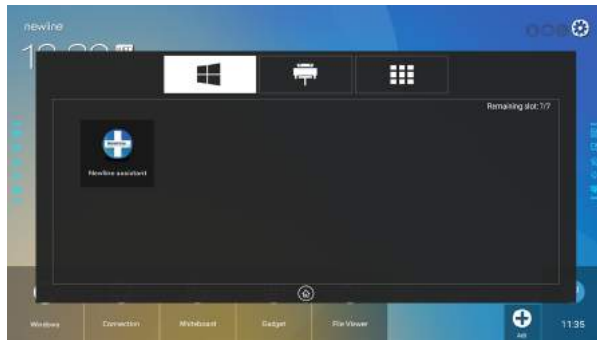

### Note

By default, the Newline Assistant application is added on the  tab.

Step 4: Tap the icon and add the shortcut at the Home page. Tap again and remove it.

Step 5: Return to **Home** page. Click the icon of an added Windows application to start the software.

# F

## Quick Setting Menu

Using two fingers to swipe up from the bottom of the screen, the quick setting menu will then show up, as shown in the following figure.



Icon	Functions
	Drag the slider to adjust the brightness.
	Drag the slider to adjust the volume.
	Click the icon to mute/unmute.
	Click the icon to turn on/off the beep sound.
	Click the icon to turn on/off the blue light filter.
	Click the icon to turn on/off the Smart system Wi-Fi.
	Click the icon to turn on/off the audio only function.
	Click the icon to turn on/off the left toolbar.
	Click the icon to turn on/off the right toolbar.
	Click the icon to enter the settings page.
	Click the icon to return to Home page.



# More Information

---

## **For more information**

Please visit our website ([www.newline-interactive.com](http://www.newline-interactive.com)) for detailed instruction manual.

## **Contact Us for Support**

Please email us at [support@newline-interactive.com](mailto:support@newline-interactive.com).

Our company is devoted to product innovation and technology enhancement. Therefore, we may change product specs and information without notice. Product pictures in the manual are for reference only, please refer to actual products.

20302-T6A8-001030