

Newline

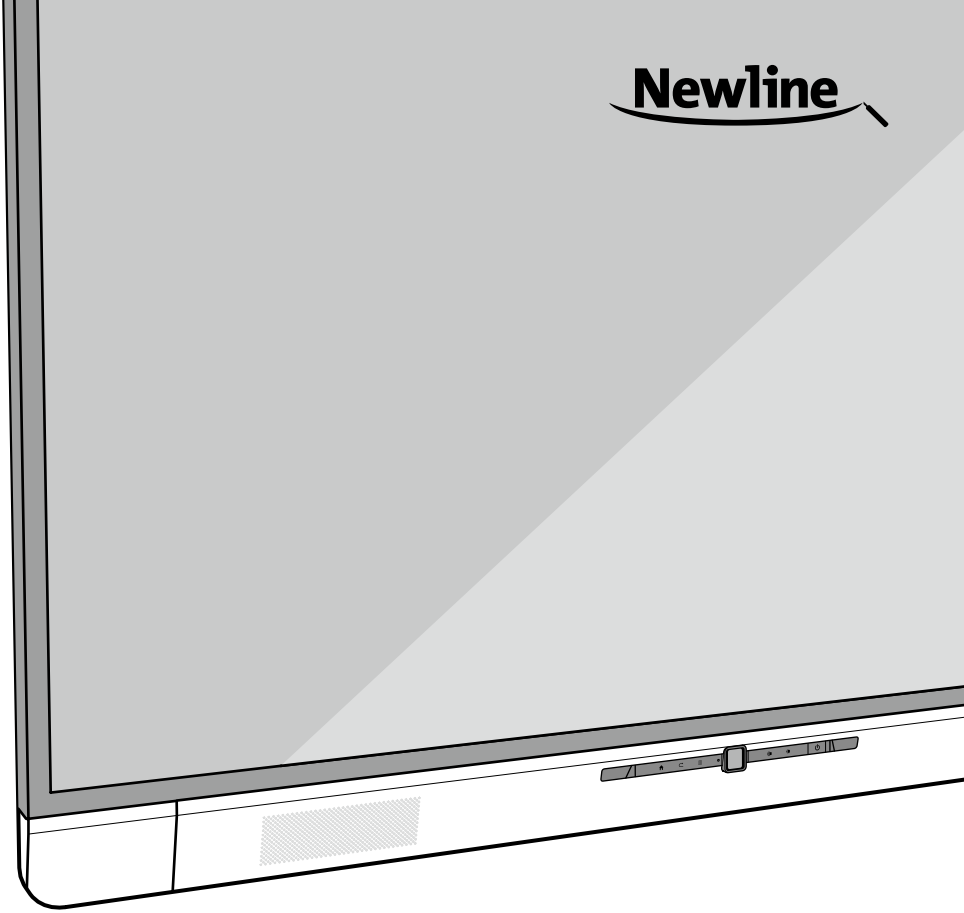

TRU TOUCH *X7*

Unified Collaboration Touch Screen

Quick Start Manual

Thanks for purchasing this product. Please read the instructions carefully before using this product.

This device complies with part 15 of the FCC Rules. Operation is subject to the following two conditions:

- (1) this device may not cause harmful interference, and
- (2) this device must accept any interference received, including interference that may cause undesired operation.

This equipment has been tested and found to comply with the limits for a Class B digital device, pursuant to part 15 of the FCC Rules. These limits are designed to provide reasonable protection against harmful interference in a residential installation. This equipment generates, uses and can radiate radio frequency energy and, if not installed and used in accordance with the instructions, may cause harmful interference to radio communications. However, there is no guarantee that interference will not occur in a particular installation. If this equipment does cause harmful interference to radio or television reception, which can be determined by turning the equipment off and on, the user is encouraged to try to correct the interference by one or more of the following measures:

- Reorient or relocate the receiving antenna.
 - Increase the separation between the equipment and receiver.
 - Connect the equipment into an outlet on a circuit different from that to which the receiver is connected.
 - Consult the dealer or an experienced radio/TV technician for help.
-

The symbol of the crossed out wheeled bin indicates this product should not be placed in municipal waste. Instead, you need to dispose of the waste equipment by handing it over to a designated collection point for the recycling of waste electrical and electronic equipment.



A

Parts and Functions

Parts

◆ Front Elevation

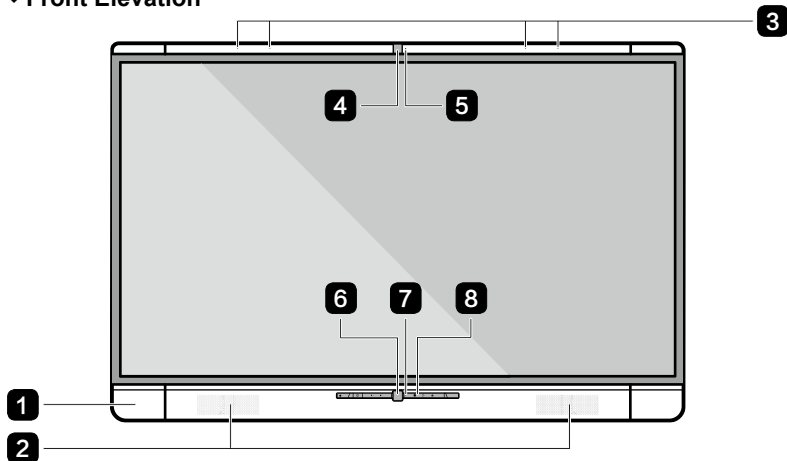

◆ Rear Elevation

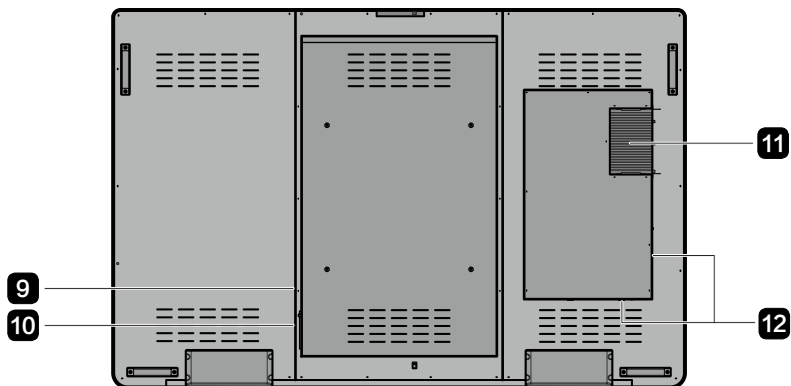

1 Front Ports

2 Speakers

3 Microphone Array

4 Top Camera

5 Camera Indicator

6 Bottom Camera

7 Camera Indicator

8 Front Buttons

9 General Power Switch

10 AC Power

11 Internal PC

12 Ports in the Back Panel

Ports

◆ Front Ports

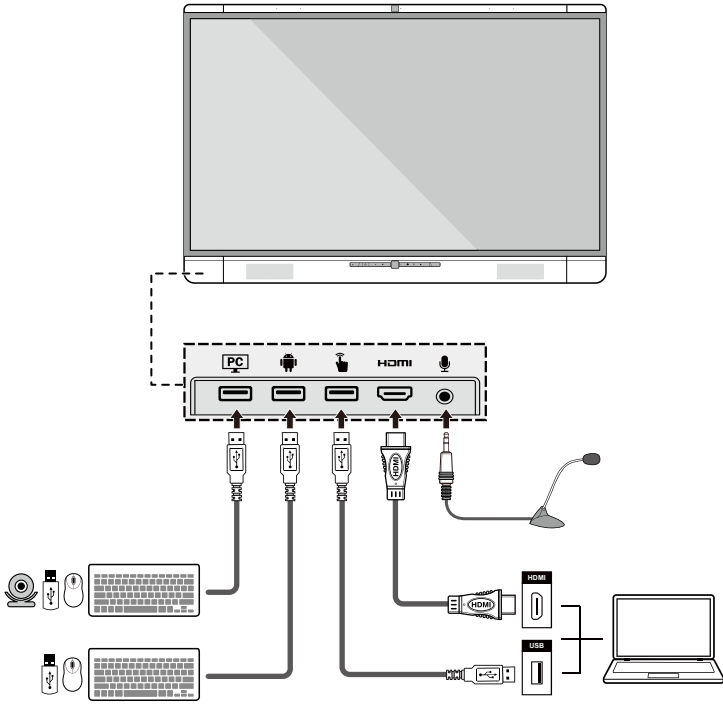

◆ Rear Ports

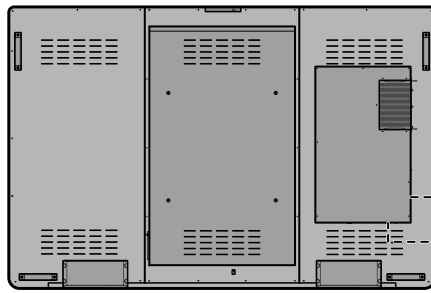
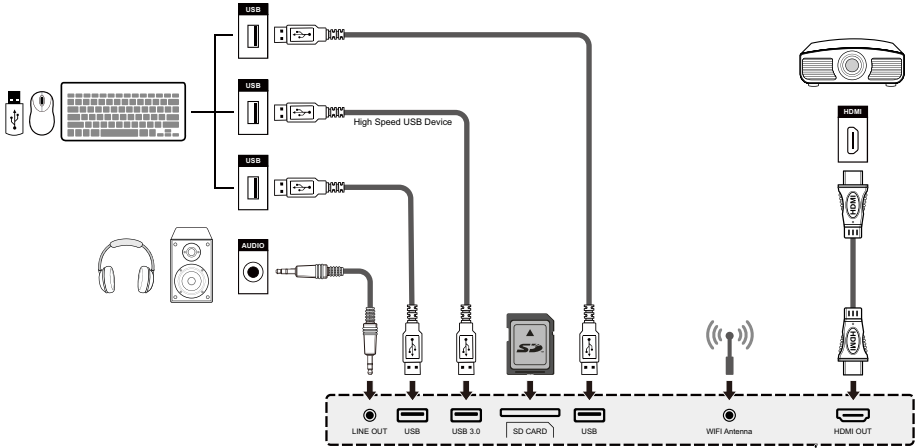



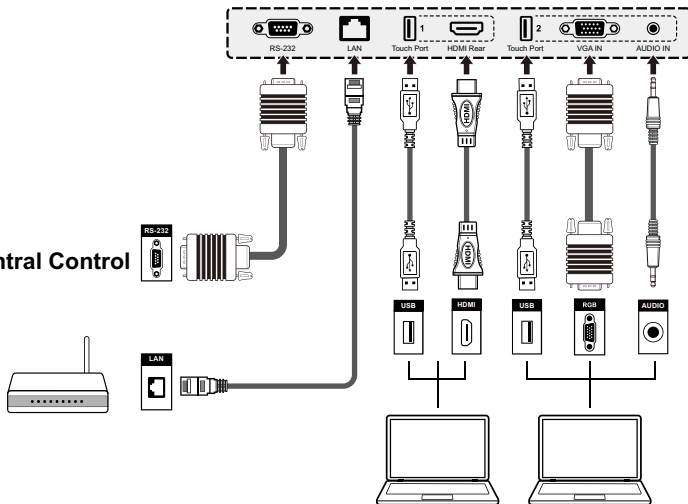



Central Control



















◆ Front Buttons



Buttons	Operations	Functions
	Short press	Power on/off
	Short press	Decrease volume
	Long press for more than 1 second	Decrease volume continuously
	Short press	Increase volume
	Long press for more than 1 second	Increase volume continuously
	Short press	Open the menu
	Short press	Go to the home page
	Short press	Return to last menu/Exit

Remote Control

Button	Function
	Power On/Off
UC	Start the Default UC Programs
	Mute
	Microphone Mute
OK	Confirm/OK
	Up/Down/Left/Right
	Return to Previous/Exit
	Go to the Home Page
	Open the Menu
	Decrease Volume
	Increase Volume
	Settings
	Page Up
	Page Down
	Switch to Top Camera
Rear	Switch Source to HDMI Rear
Front	Switch Source to HDMI Front
	Switch to Bottom Camera
VGA	Switch Source to VGA

Button	Function
PC	Switch Source to Internal PC
	Toggle Display Mode
	Zoom In (PC)
	Zoom Out (PC)



B

Installation

Safety Precautions

◆ Installation Environment



◆ Installation Direction

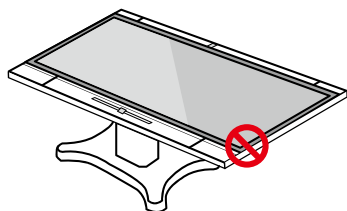
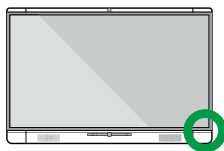

◆ Installation Height

Recommend installation height is 33" (838mm) from the floor to the bottom of the screen.

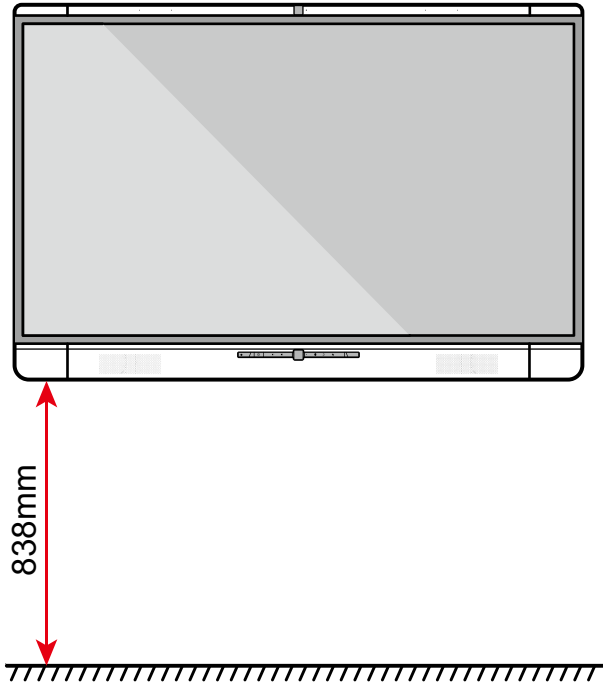

Installation Precautions

◆ Weight Loading

- The back of the panel is equipped with holes in VESA standard. Please use a VESA mounting system.
- When using a mobile cart, please ensure the mobile cart has no less than 80kg loading capacity.
Weight of the unit: 143.3 lb/65kg
- When using wall-mount bracket, please ensure the wall can support the weight of the unit. We recommend that the wall surface is reinforced, and have a loading capacity twice the weight of the unit. Please consult a professional installer for wall-mount installation.
- Do not install the unit where it might be hit by a door.

◆ Ventilation

Ensure adequate ventilation and/or air conditioning environment. We recommend to keep certain distance from the side of the unit to the wall or panels. Ventilation requirement is showed in following figure.

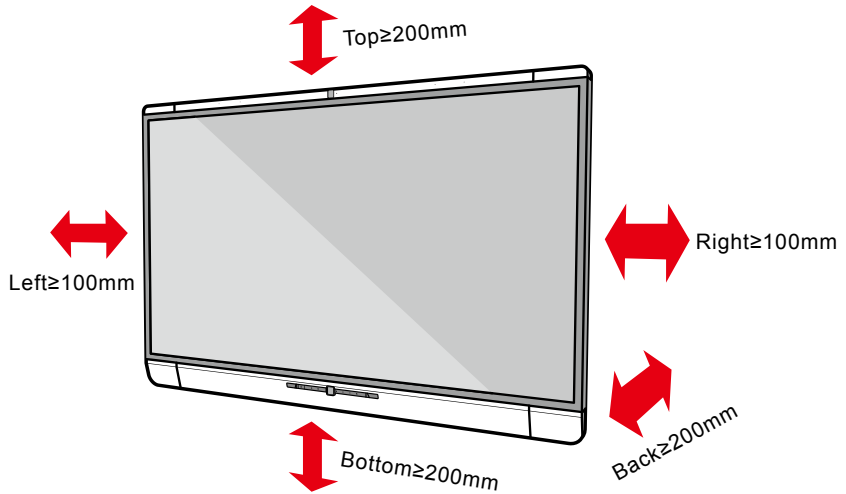

Installation

The dimensions of the 4 bracket mounting holes in the back panel is VESA MIS-F compliant (400 x 400mm). Please use the metric M8 screws with length of 10 to 15mm to secure the touch screen with the mounting system. Dimensions of the mounting holes in the back panel is shown in the next page.

Note

Please have a professional installer to install the display unit.

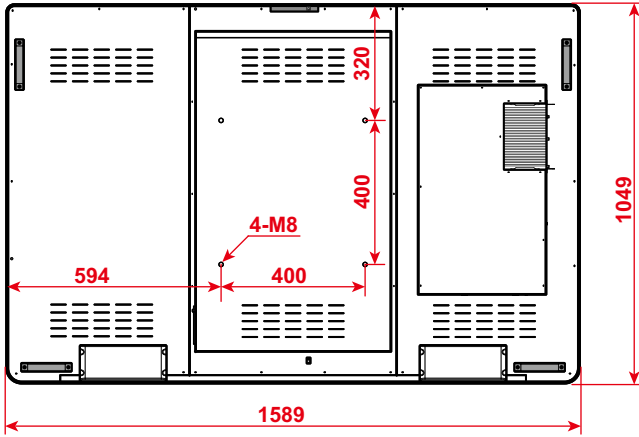

Unit: mm

C



Turning On/Off

Power On

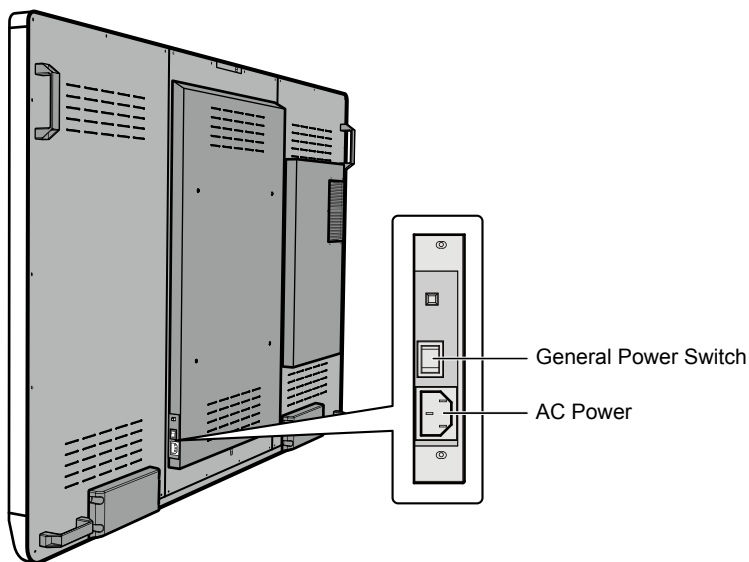

Step 1: Plug in the power plug to the power outlet, and plug in the power connector to the side of the unit. Please ensure the power is in the range of 100V-240V with frequency at 50Hz/60Hz $\pm 5\%$. The power current must be grounded.

Step 2: Turn on the general power switch located on the side of the unit.



Step 3: Press the power button  in the front control panel or  on the remote control.

Power Off

Step 1: If you are in the **Meeting Start** page, you can turn off the unit directly by pressing  in the front control panel or  on the remote.

Step 2: If you are not going to use the unit for an extended period of time, we recommend you to switch off the general power switch.

D

System Applications

When the unit is turned on, it will show the **Meeting Start** page. From here, the user can touch the screen to start a meeting, and the unit will go to the **Home** page. See the following figures.

Figure 1 Meeting Start Page

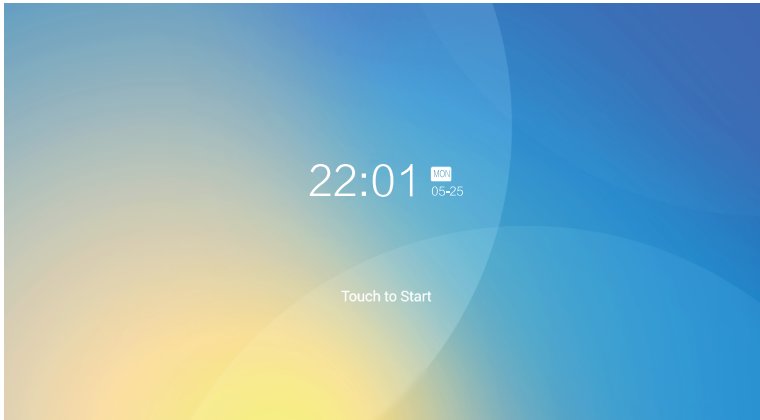
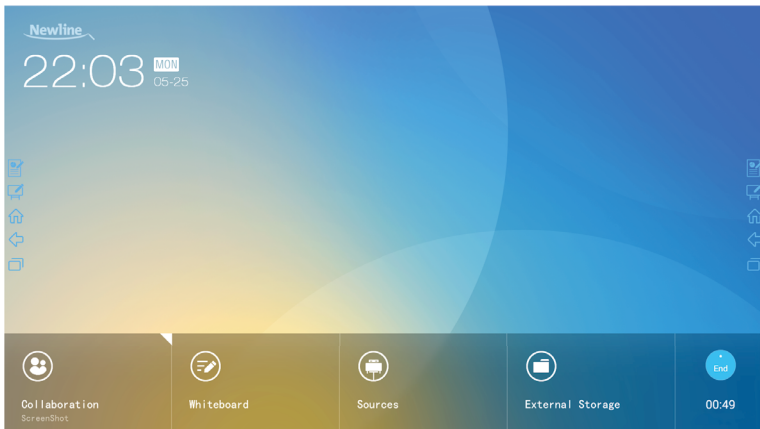

Figure 2 Home Page



- **Collaboration**

The user can touch here to start the default UC programs, or touch the small triangle to set three shortcuts for frequently used UC programs. The default UC program is the one used last time.

- **Whiteboard**

The **Whiteboard** provides whiteboard and screen annotation functions.

- **Sources**

The user can select one of the four sources to display, including HDMI Front, HDMI Rear, Internal PC and VGA.





- **External Storage**

Open up the file manager to open files from external USB disk.

- **End**

Press **End** to end a meeting. Users will have the choice of saving the whiteboard screen captures and ending the meeting. Once a meeting is ended, all screenshots will be cleared.

Quick Access Buttons on Both Sides

-  : Start Annotation
-  : Start Whiteboard
-  : Go to Home Page
-  : Return to Previous App/Exit
-  : Switch Apps

E

Easy Setting Menu

The easy setting menu can be accessed by sliding one finger down from the top of the screen.





More Information

For more information

Please visit www.newline-interactive.com.

Contact Us for Support

Please email us at support@newline-interactive.com.

Newline Interactive, Inc.
101 East Park Blvd. Suite 807
Plano, TX 75074
Tel: +1 (972) 468-9728
Fax: +1 (972) 422-4288