

newline

# USB Speakerphone

TM-A220Y

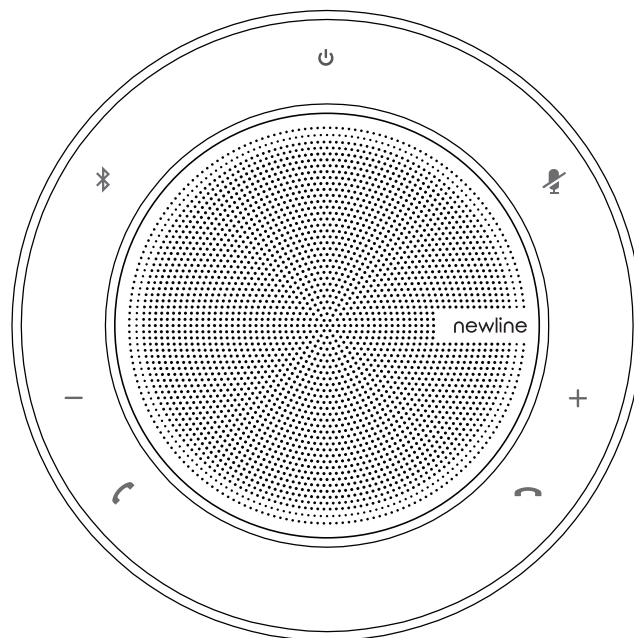

## Quick Start Guide

# Package Contents

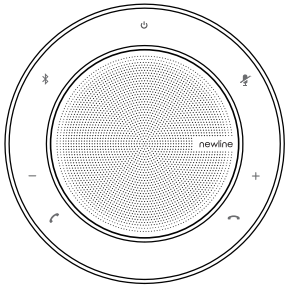

TM-A220Y

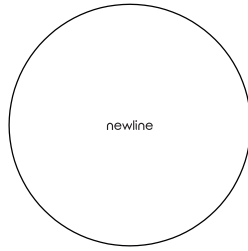

Carrying Case

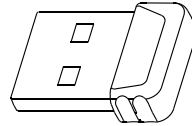

BT50

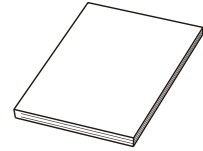

Quick Start Guide

# Charging Your TM-A220Y

Plug the TM-A220Y into a USB power source. The TM-A220Y battery lasts for up to 12 hours of talk time and takes approximately 3 hours (5V/1A) to fully charge.

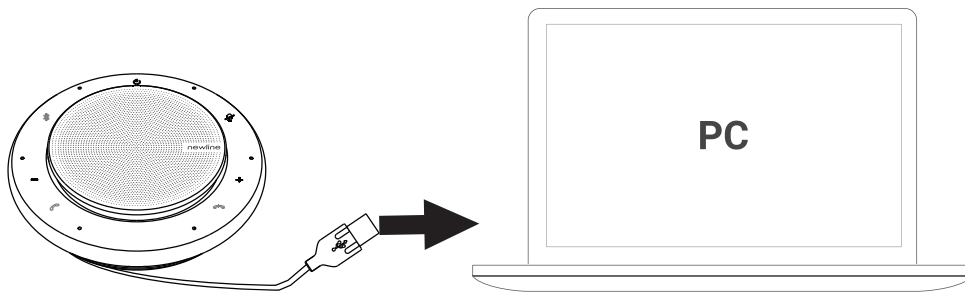

# Viewing the Battery Status

Tap  to view the battery status.

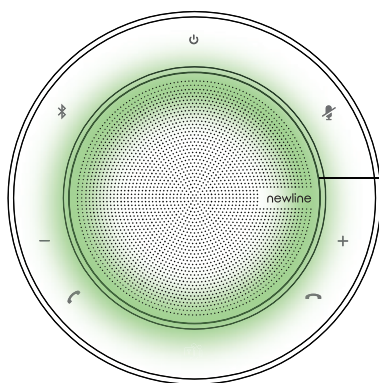

Full battery

green

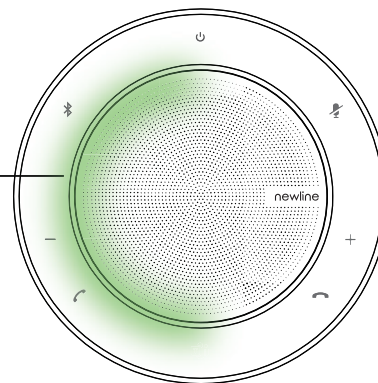

Medium battery

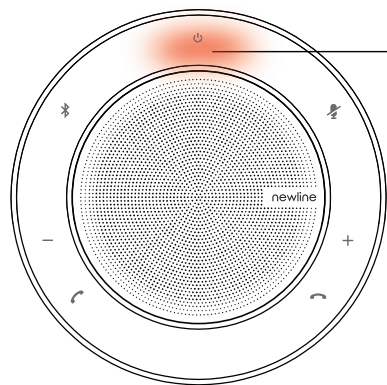

Extremely low on power, flashing red

Low battery

## Connecting Your TM-A220Y

### Connect to PC via USB Cable

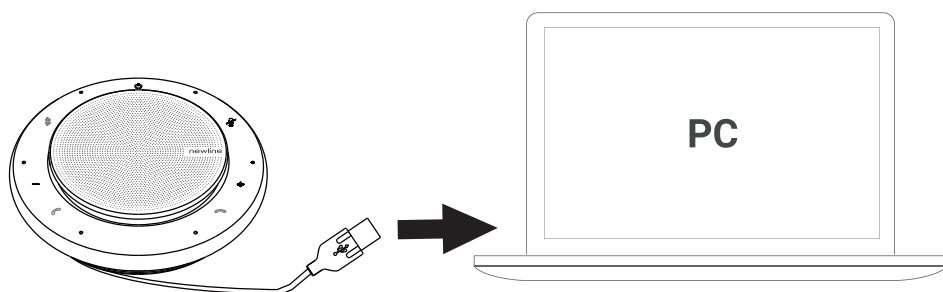

### Connect to IFPD via Bluetooth

Connect the BT50 into a USB port on your IFPD. The TM-A220Y and the BT50 are pre-paired and ready to use out of the box.

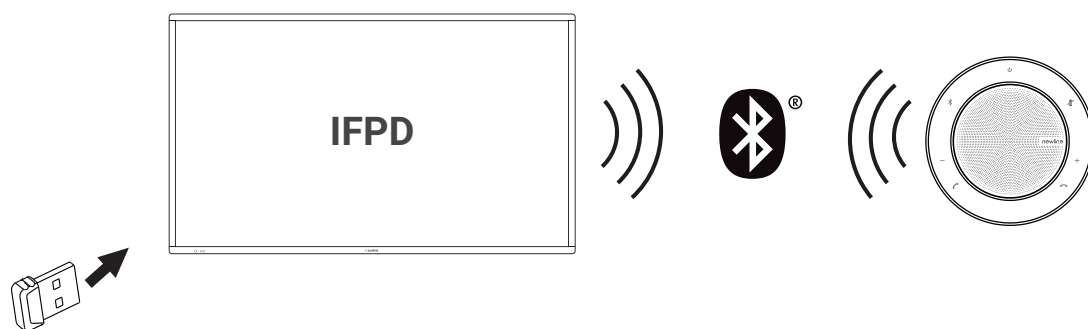



Note: If there is no sound coming from your TM-A220Y, you may need to set the TM-A220Y as the playback device in your operating system's audio settings.

### Connect to smartphone via Bluetooth

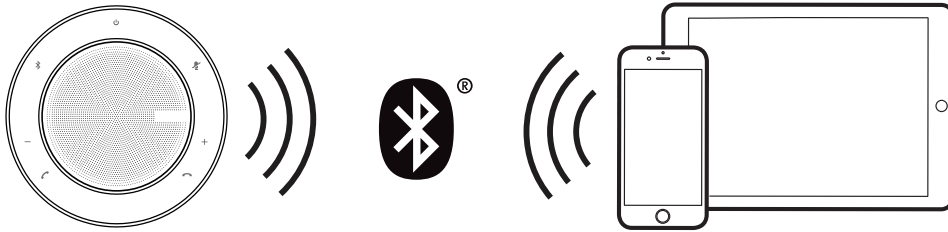
Hold  for 2 seconds to enter the pairing mode, and pair to your smartphone.



To disconnect, double-tap .  
 To reconnect, tap  again.

Note: You can connect your TM-A220Y to 2 Bluetooth devices at the same time.

## Placing Your TM-A220Y



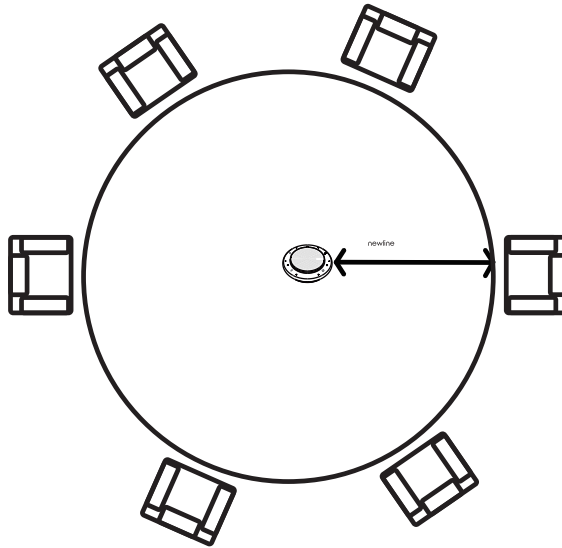



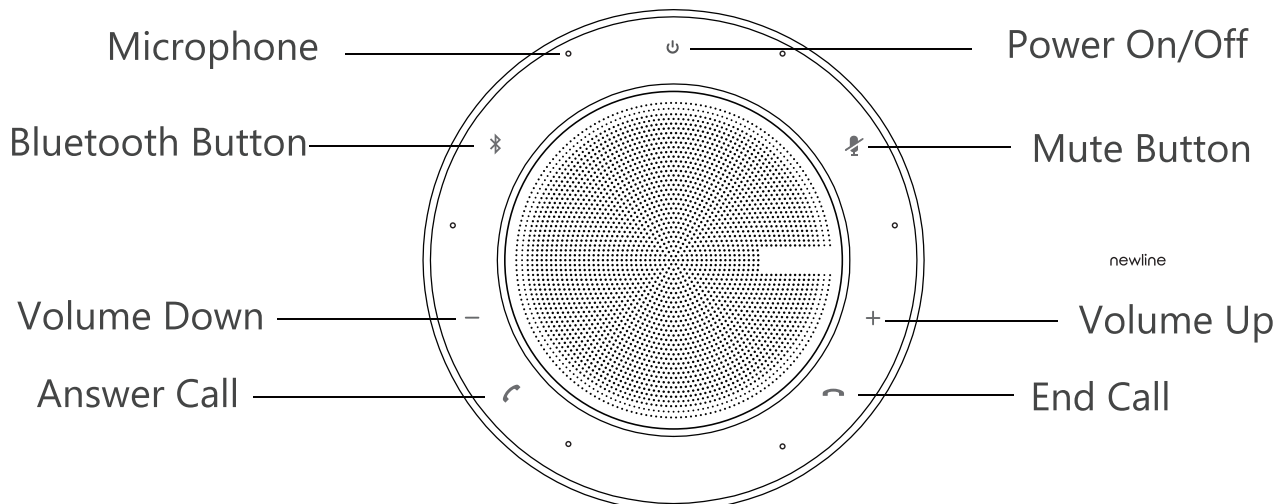



Place the speakerphone in the center of the table, up to 2m/6.5ft from each participant. A TM-A220Y is ideal for up to 6 people.



## Using Your TM-A220Y



The TM-A220Y can connect to PC via USB cable or Bluetooth, and to IFPD / smartphone via Bluetooth. After connected, you can control the calls on the TM-A220Y.

Task	Do
Power on or off	Hold  for 3 seconds.
Answer a call	Tap  .
End or reject a call	Tap  .
Volume up/down	Tap $+/-$ .
Mute/unmute microphone	During a call, tap  . The mute LED indicator and LED light-ring glow red.
Hold a call	During a call, tap  . The LED light-ring flashes green.
Reset to the factory	Hold  and  for 6 seconds.
Play/pause the music	When the connected smartphone is playing music, tap  to pause. Tap  again to resume.
Voice assistant	Hold the  for 2 seconds to activate the smartphone's voice assistant (Siri®, Google Now™, Cortana™). Note: It depends on whether the connected smartphone supported voice assistant function.

Note: If connected to IFPD or smartphone via Bluetooth, TM-A220Y will enter the power safe mode after 60 seconds without operation. In this mode, you can tap any key to awake TM-A220Y.  
The Bluetooth pairing information will be cleared after a factory reset.

## Regulatory Notices

### Operating Ambient Temperatures

- Operating temperature: +32 to 104°F (0 to 40°C)
- Relative humidity: 5% to 90%, noncondensing
- Storage temperature: -22 to +160°F (-30 to +70°C)

### Warranty

Our product warranty is limited only to the unit itself, when used normally in accordance with the operating instructions and the system environment. We are not liable for damage or loss resulting from the use of this product, or for any claim from a third party. We are not liable for problems with Newline device arising from the use of this product; we are not liable for financial damages, lost profits, claims from third parties, etc., arising from the use of this product.

### Explanation of the symbols

- DC symbol

⎓ is the DC voltage symbol.

- WEEE Warning symbol

 To avoid the potential effects on the environment and human health as a result of the presence of hazardous substances in electrical and electronic equipment, end users of electrical and electronic

equipment should understand the meaning of the crossed-out wheeled bin symbol. Do not dispose of WEEE as unsorted municipal waste and have to collect such WEEE separately.

### Restriction of Hazardous Substances Directive (RoHS)

This device complies with the requirements of the EU RoHS Directive. Statements of compliance can be obtained by contacting support@newline-interactive.com.

### Safety Instructions

Save these instructions. Read these safety instructions before use!

#### ⚠ General Requirements

- Before you install and use the device, read the safety instructions carefully and observe the situation during operation.
- During the process of storage, transportation, and operation, please always keep the device dry and clean, avoid collision and crash.
- Please attempt not to dismantle the device by yourself. In case of any discrepancy, please contact the appointed maintenance center for repair.
- Please refer to the relevant laws and statutes while using the device. Legal rights of others should be respected as well.

#### ⚠ Environmental Requirements

- Place the device at a well-ventilated place. Do not expose the device under direct sunlight.
- Keep the device dry and free of dusts.
- Do not place the device on or near any inflammable or fire-vulnerable object, such as rubber-made materials.
- Keep the device away from any heat source or bare fire, such as a candle or an electric heater.

#### ⚠ Operating Requirements

- Do not let a child operate the device without guidance.
- Do not let a child play with the device or any accessory in case of accidental swallowing.
- Please use the accessories provided or authorized by the manufacturer only.
- The power supply of the device shall meet the requirements of the input voltage of the device. Please use the provided surge protection power socket only.
- Before plugging or unplugging any cable, make sure that your hands are completely dry.
- Do not spill liquid of any kind on the product or use the equipment near water, for example, near a bathtub, washbowl, kitchen sink, wet basement or near a swimming pool.
- During a thunderstorm, stop using the device and disconnect it from the power supply. Unplug the power plug and the Asymmetric Digital Subscriber Line (ADSL) twisted pair (the radio frequency cable) to avoid lightning strike.

## About Newline Interactive

Headquartered in Plano, Texas, Newline Interactive is a leading supplier of interactive touch screens and innovative software that increase productivity and enable collaboration. Newline Interactive develops products that help organizations in a wide range of vertical markets including financial services, education, healthcare, law enforcement, manufacturing, municipalities, and legal services.

## Technical Support

Visit Newline (<https://newline-interactive.com/>) for the latest information, FAQ and product documents, or email us at support@newline-interactive.com for all your technical issues.

- If the device is left unused for a rather long time, disconnect it from the power supply and unplug the power plug.
- When there is smoke emitted from the device, or some abnormal noise or smell, disconnect the device from the power supply, and unplug the power plug immediately.
- Contact the specified maintenance center for repair.
- Do not insert any object into equipment slots that is not part of the product or auxiliary product.
- Before connecting a cable, connect the grounding cable of the device first. Do not disconnect the grounding cable until you disconnect all other cables.

#### ⚠ Cleaning Requirements

- Before cleaning the device, disconnect it from the power supply.
- Use a piece of soft, dry and anti-static cloth to clean the device.
- Keep the power plug clean and dry.

#### Troubleshooting

The unit cannot supply power to device other than Newline device.

There is a bad connection with the plug.

1. Clean the plug with a dry cloth.

2. Connect it to another wall outlet.

The usage environment is out of operating temperature range.

1. Use in the operating temperature range.

The cable between the unit and the Newline device is connected incorrectly.

1. Connect the cable correctly.

You cannot connect the cable properly.

1. You may have connected a wrong Newline device.

2. Use the correct power supply.

Some dust, etc., may be in the port.

1. Clean the port.

Contact your dealer or authorized service facility for any further questions.

#### FCC Statement

This device complies with part 15 of the FCC Rules. Operation is subject to the following two conditions:

(1) this device may not cause harmful interference, and

(2) this device must accept any interference received, including interference that may cause undesired operation.

Any Changes or modifications not expressly approved by the party responsible for compliance could void the user's authority to operate the equipment.

#### IC Statement

This device complies with Industry Canada's licence-exempt RSSs. Operation is subject to the following two conditions:

(1) this device may not cause interference; and

(2) this device must accept any interference, including interference that may cause undesired operation of the device. CAN ICES-3(B)

Le présent appareil est conforme aux CNR d'Industrie Canada applicables aux appareils radio exempts de licence. L'exploitation est autorisée aux deux conditions suivantes :

(1) l'appareil ne doit pas produire de brouillage;

(2) l'utilisateur de l'appareil doit accepter tout brouillage radioélectrique subi, même si le brouillage est susceptible d'en compromettre le fonctionnement. NMB-3(B)

#### Radiation Exposure Statement

This equipment complies with FCC and IC radiation exposure limits set forth for an uncontrolled environment. This equipment should be installed and operated with minimum distance 20cm between the radiator and your body.

Cet émetteur ne doit pas être Co-placé ou ne fonctionnant en même temps qu'aucune autre antenne ou émetteur. Cet équipement devrait être installé et actionné avec une distance minimum de 20 centimètres entre le radiateur et votre corps.

#### Contact Information

Newline Interactive Inc

101 East Park Blvd. Suite 807 Plano, TX 75074, USA

