

Optimum Components & Precision Dispense Tips

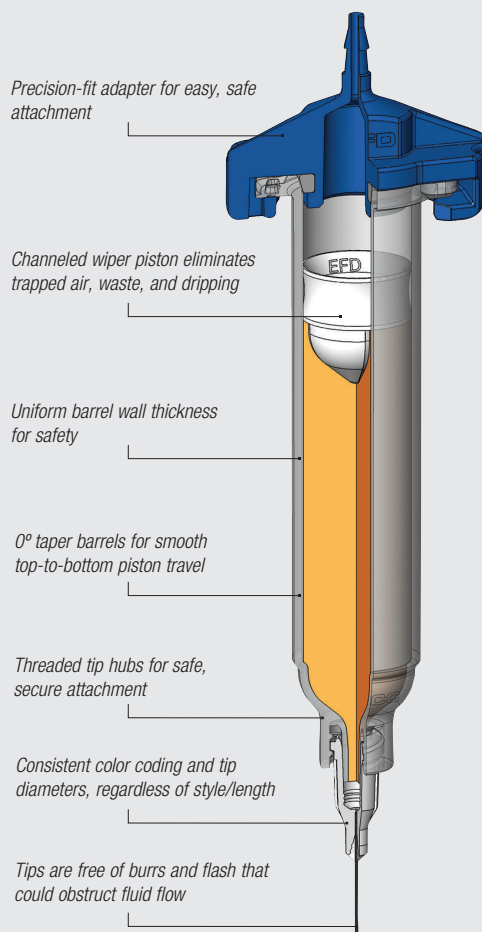

The Standard in Fluid Dispensing

What makes EFD's Optimum dispensing components better than the rest? Engineered Fluid Dispensing™.

Each patented component has been designed as part of a complete, integrated system that improves yields and reduces costs by producing the most accurate, repeatable fluid deposits possible.

Our syringe barrels are made of a proprietary polypropylene blend that delivers exceptional clarity and dimensional stability. The unique internal design enhances fluid flow and minimizes turbulence and shear during filling and dispensing.

Matching pistons are available in six styles to ensure control for virtually any fluid in any application. When fluid is dispensed, the close tolerance wiping action eliminates waste and residue.

Syringe barrel adapters have a design that facilitates installation/removal, and a positive safety locking action that prevents accidental disengagement.

Free of flash, burrs, or other contaminants, EFD dispensing tips are designed with engineered hub flats for easy twist on, twist off, and SafetyLok threads to ensure safe, positive attachment to the syringe barrel.

Dispensing Components



Optimum Syringe Barrels

EFD produces the highest quality syringe barrels and pistons in the industry. Syringe barrels and pistons are produced in our own silicone-free facilities, where they are subjected to stringent quality control inspections throughout the entire manufacturing process.

Features and Benefits

- Precision fit between syringe and piston ensures consistent fluid deposits
- Wiper piston improves fluid control, keeps fluids from dripping and eliminates waste by wiping the syringe wall clean
- Wide variety of styles and sizes
- Package labels include lot numbers for process control and traceability

"One stop shopping for syringes, barrel adapters, needles and tips along with excellent reference materials and pictures of actual applications to spark new ideas."

– Infinera

SYRINGE BARREL & PISTON SETS

Each box contains syringes and pistons in dust-free packaging.

| Size | MOST FLUIDS | UV/Light Block* | Opaque | QTY |
|------|--------------------------------|--------------------------------|--------------------------------|-------|
| | Clear Barrels White Pistons | Amber Barrels White Pistons | Black Barrels White Pistons | |
| 3cc | 7366044 | 7366041 | 7366042 | (100) |
| 5cc | 7366045 | — | — | (100) |
| 10cc | 7366040 | 7366039 | — | (100) |
| 30cc | 7366054 | 7366051 | 7366052 | (50) |
| 55cc | 7366056 | 7366055 | — | (50) |

Sets are available in clear for most fluids; transparent amber for UV- and light-sensitive materials (less than 12% visible light from 550 nm or less); and opaque black for complete light blockage.

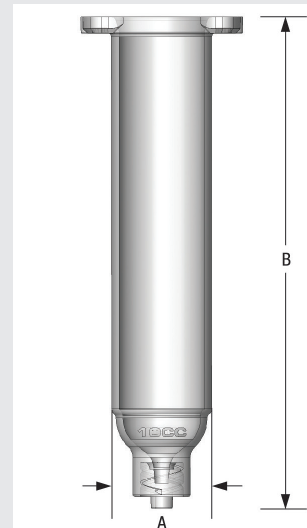

SYRINGE BARRELS

Each box contains syringes and pistons in dust-free packaging.

| Size | MOST FLUIDS | UV/Light Block* | Opaque | QTY |
|------|---------------|-----------------|---------------|-------|
| | Clear Barrels | Amber Barrels | Black Barrels | |
| 3cc | 7366095 | 7366092 | 7366093 | (100) |
| 5cc | 7366101 | 7366098 | 7366099 | (100) |
| 10cc | 7366089 | 7366086 | 7366087 | (100) |
| 30cc | 7366060 | 7366057 | 7366058 | (50) |
| 55cc | 7366066 | 7366063 | 7366064 | (50) |
| 70cc | 7366070 | 7366069 | — | (50) |

Note: 30cc, 55cc, and 70cc syringe barrels accept the same size barrel pistons, end caps, and adapters. Order pistons separately.

*Transparent amber for UV- and light-sensitive materials (less than 12% visible light from 550 nm or less); and opaque black for complete light blockage.

BARREL DIMENSIONS

| Size | A | B |
|------|-----------------|------------------|
| 3cc | 11.1 mm (0.44") | 73.0 mm (2.88") |
| 5cc | 14.3 mm (0.56") | 68.3 mm (2.69") |
| 10cc | 19.1 mm (0.75") | 88.9 mm (3.50") |
| 30cc | 25.4 mm (1.0") | 115.9 mm (4.56") |
| 55cc | 25.4 mm (1.0") | 173.0 mm (6.81") |
| 70cc | 25.4 mm (1.0") | 213.1 mm (8.39") |

Note: This data is typical and does not constitute a specification.



www.nordsonefd.com/1kOptimum

Dispensing Components

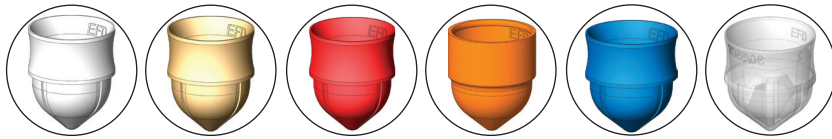

A piston is inserted into the syringe barrel after it has been loaded with fluid to ensure uniform dispensing, prevent dripping, and eliminate waste by wiping barrel walls clean as fluid is dispensed. Optimum pistons are molded from high-density polyethylene.*

SYRINGE BARREL PISTONS

| Size | White SmoothFlow | Beige SmoothFlow | Red SmoothFlow | Orange Flatwall | Blue LV Barrier | Clear Flex | QTY |
|------------|------------------|------------------|----------------|-----------------|-----------------|------------|-------|
| 3cc | 7366134 | 7366126 | 7366133 | 7366132 | 7366128 | 7366131 | (100) |
| 5cc | 7366141 | 7366135 | 7366140 | 7366139 | n/a | 7366138 | (100) |
| 10cc | 7366125 | 7366117 | 7366124 | 7366123 | 7366119 | 7366122 | (100) |
| 30/55/70cc | 7366084 | 7366076 | 7366083 | 7366082 | 7366078 | 7366081 | (50) |

*Clear Flex pistons are molded from LDPE (low-density polyethylene).

Optimum Pistons

Available in six styles:

White SmoothFlow wiper pistons are used with most fluids.

Beige SmoothFlow pistons are loose-fitting and used with air-entrapped fluids.

Red SmoothFlow pistons are tight-fitting and used with mechanical dispensers.

Orange Flat-walled pistons have a looser fit to prevent "bouncing" when dispensing stringy, air-entrapped fluids.

Blue LV Barrier pistons are for cyanoacrylates and very low viscosity fluids.

Clear Flex pistons are flexible and reduce "bouncing" in viscous fluids while maintaining excellent wall-wiping.



www.nordsonefd.com/Piston-How-To

End caps and tip caps provide an airtight seal that allows you to prefill syringe barrels or seal partially used syringes between shifts.

End caps feature a precision fit and use a convenient push-button to produce a snug, air-tight seal.

Tip caps have a large knurled gripping surface that simplifies attachment, and a vent that prevents air from being introduced into the syringe barrel during installation. The gripping action of the tip cap is designed to maximize the seal and yet be easily removed by the user. Available in blue or green.

Optimum End and Tip Caps

SNAP-TIGHT END AND TIP CAPS

Snap-on end caps provide tight seal.

| Size | Blue | Green | QTY |
|------------|---------|---------|-------|
| 3cc | 7366108 | 7366111 | (100) |
| 5cc | 7366113 | 7366116 | (100) |
| 10cc | 7366104 | 7366107 | (100) |
| 30/55/70cc | 7366071 | 7366074 | (50) |

Twist-on tip cap seals syringe barrel.

| One size | Blue | QTY | Green | QTY |
|----------|------|---------|--------|-----|
| 7012198 | (50) | 7362541 | (1000) | |

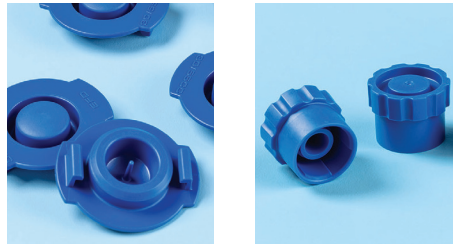

Lightweight adapters are designed for fast attachment and feature slots that lock securely onto matching tabs on the syringe barrel.

ADAPTER ASSEMBLIES

| Size | Blue 0.9 m (3 ft) Hose | Blue 1.8 m (6 ft) Hose | Blue 0.9 m (3 ft) Hose w/ filter trap | Quicksilver 1.8 m (6 ft) Hose |
|------------|------------------------|------------------------|---------------------------------------|-------------------------------|
| 3cc | 7012341 | 7012059 | 7012063 | 7364491 |
| 5cc | 7012054 | 7012058 | 7012062 | 7364490 |
| 10cc | 7012339 | 7012057 | 7012061 | 7364489 |
| 30/55/70cc | 7012338 | 7012056 | 7012060 | 7364488 |

Blue molded one-piece, acetal adapter head with NBR O-ring, flexible polyurethane air hose (5/32" OD X 3/32" ID), male quick-connect, and safety clip. For general use. Quicksilver for use with UltimiusPlus dispensers. See next page for Unity adapters.

Adapter Assemblies

Dispensing Components

Nordson EFD Optimum Class VI grade syringe barrels are made from biocompatible materials that meet the requirements for United States Pharmacopeia (USP) Class VI resin.

Features and Benefits

- Enhanced biocompatibility for medical use
- Ease of process validation for regulatory approvals
- Market-leading traceability for documentation requirements
- Ability to sterilize to ensure a bacteria-free product

| CLASS VI COMPONENTS | | | | |
|---------------------|------------------------|------------------------|-------------------------|---------|
| Size | Class VI Clear Barrels | Class VI Clear Pistons | Class VI Clear End Caps | Qty/Box |
| 3cc | 7366097 | 7366130 | 7366110 | 100 |
| 5cc | 7366103 | 7366137 | 7366115 | 100 |
| 10cc | 7366091 | 7366121 | 7366106 | 100 |
| 30cc | 7366062 | 7366080 | 7366073 | 50 |
| 55cc | 7366068 | 7366080 | 7366073 | 50 |
| CLASS VI TIP CAPS | | | | |
| 7364590 | | | | 50 |

Optimum Class VI pistons are designed for use with Class VI barrels only.

Optimum Class VI Components



Nordson EFD's Optimum ECO dispensing components are manufactured from sustainably-sourced polyethylene and feature a bio-based content rating of 94% to 96%. This eco-friendly system helps meet corporate sustainability initiatives by using raw resins derived from sugarcane stock versus byproducts of the petrochemical industry.

Features and Benefits

- Eco-friendly components are made from renewable resources
- Minimize consumption and greenhouse gases, reducing carbon footprint
- Barrel transparency allows operator to see fluid level
- Superior freezing properties for premixed fluids compared to standard polypropylene barrels

| ECO COMPONENTS | | | | |
|----------------|---------------------|---------------------|----------------------|---------|
| Size | ECO Natural Barrels | ECO Natural Pistons | ECO Natural End Caps | Qty/Box |
| 3cc | 7366096 | 7366129 | 7366109 | 100 |
| 5cc | 7366102 | 7366136 | 7366114 | 100 |
| 10cc | 7366090 | 7366120 | 7366105 | 100 |
| 30cc | 7366061 | 7366079 | 7366072 | 50 |
| 55cc | 7366067 | 7366079 | 7366072 | 50 |
| ECO TIP CAPS | | | | |
| 7364679 | | | | 50 |

Optimum ECO pistons are designed for use with ECO barrels only.

Optimum ECO Components



Dispensing Components

Nordson EFD's disposable Unity™ HiTemp™ syringe barrels provide a cost-effective alternative to syringes commonly used in pneumatic dispensing of hot melt adhesives. The barrels are compatible with Nordson's Unity IC Series and Unity PURJet™ 30 dispensing systems and other standard industry hot melt dispensers.

Features and Benefits

- Proprietary materials maintain integrity at high temperatures for up to eight hours
- Disposability reduces downtime and maintenance costs with better cost of ownership compared to standard metal syringes
- Reliable, repeatable hot melt adhesive dispensing at up to 180° C

Unity HiTemp Components



| UNITY COMPONENTS | | | | | | |
|------------------|--------------------|----------------------------|------------------------------------|-----------------------------------|-----------------------------------|-------------|
| Size | Syringe Barrels | | Tip Cap White Extreme HiTemp | Adapter Assembly 3ft Tubing | Adapter Assembly 6ft Tubing | Qty/ Box |
| | HiTemp (125° C) | Extreme HiTemp (180° C) | | | | |
| 30cc | 7360475 | 7360473 | 7360452 | 7362348* | 7362347* | 20 |

*Adapter assemblies sold individually.

Dial-A-Dose Industrial Syringes

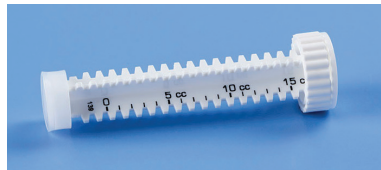

Dial-A-Dose plunger



One-piece plunger

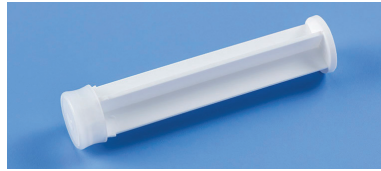

Two-piece plunger

Dial-A-Dose Industrial Syringes

For use with:

Adhesives

Epoxies & Silver Epoxies

Greases & Lubricants

Sealants

Solder Pastes

Nordson EFD offers a comprehensive selection of syringes used for fluid packagers in the electronics rework, industrial, dental, and do-it-yourself markets. Dial-A-Dose® syringes are an ideal packaging system for controlled placement of adhesives and sealants. For multi deposit use, EFD Dial-A-Dose syringes offer an innovative, customizable solution to tailor deposits based on application size and other requirements.

Features and Benefits

- Range of sizes, colors, and nozzles
- Self-venting barrels with “lead-in” aid for easy fill
- Single and multi deposit syringes allow manufacturers to make the deposit, cap the syringe, and save for next deposit
- Locking ring ensures exact amount is dispensed

DIAL-A-DOSE INDUSTRIAL SYRINGES

Syringes include integrated molded nozzle. Order plungers and caps separately. White caps molded in LDPE.

| Syringe | Size | Material | Color | Cap | Multi-Dose Plunger | Single-Dose Plunger Options | |
|--|------|----------|-------|---------|--------------------|-----------------------------|-----------|
| | | | | | Dial-A-Dose | One-Piece | Two-Piece |
| Nozzle Style: Short Taper 1/16" ID x 7/32" Length | | | | | | | |
| 7660308 | 15cc | PE | White | 7660192 | 7660343 | 7660329 | 7660333 |
| Nozzle Style: Thin Taper 1/16" ID x 1-1/18" Length | | | | | | | |
| 7660277 | 6cc | PE | White | 7660194 | — | 7660292 | — |
| 7022846 | 15cc | PE | White | 7660194 | 7660343 | 7660329 | 7660333 |
| 7026529 | 30cc | PE | White | 7660194 | — | 7660380 | — |
| Nozzle Style: Luer Lock 1/16" ID x 1/4" Length | | | | | | | |
| 7660228 | 3cc | PP | Clear | 7660246 | — | 7660263 | — |
| 7660392 | 32cc | PP | Amber | 7660246 | 7660452 | 7660427 | 7660436 |

Continued next page

Dial-A-Dose Syringes

From previous page

| DIAL-A-DOSE INDUSTRIAL SYRINGES | | | | | | | |
|--|-------|----------|-------|---------|--------------------|-----------------------------|-----------|
| Syringe | Size | Material | Color | Cap | Multi-Dose Plunger | Single-Dose Plunger Options | |
| | | | | | Dial-A-Dose | One-Piece | Two-Piece |
| Nozzle Style: Standard 3/16" ID x 1-13/32" Length | | | | | | | |
| 7660279 | 6cc | PE | White | 7660198 | 7661311 | – | – |
| 7660313 | 15cc | PE | White | 7660198 | 7660343 | 7660329 | 7660333 |
| 7660399 | 32cc | PE | White | 7660198 | 7660452 | 7660427 | 7660436 |
| 7660508 | 60cc | PE | White | 7660198 | 7660538 | – | 7660528 |
| 7660571 | 100cc | PP | Clear | 7660198 | 7660580 | – | 7660581 |
| Nozzle Style: Luer Slip 3/32" ID x 11/32" Length | | | | | | | |
| 7660229 | 3cc | PE | White | 7660201 | – | 7660263 | – |
| Nozzle Style: Medium 9/32" ID x 1-13/32" Length | | | | | | | |
| 7660419 | 32cc | PE | White | 7660207 | 7660452 | 7660427 | 7660436 |
| 7660482 | 34cc | PE | White | 7660207 | 7660452 | 7660427 | 7660436 |
| Nozzle Style: Cone 3/32" ID x 1-1/2" Length | | | | | | | |
| 7660371 | 30cc | PE | White | 7660201 | – | 7660380 | – |
| Nozzle Style: Medium 1/4" ID x 1-23/64" Length | | | | | | | |
| 7660517 | 60cc | PE | White | 7660207 | 7660538 | – | 7660528 |
| 7660552 | 80cc | PE | White | 7660207 | 7660557 | – | 7660938 |
| Nozzle Style: Wide 13/32" ID x 1-5/16" Length | | | | | | | |
| 7660522 | 60cc | PE | White | 7660191 | 7660538 | – | 7660528 |
| 7660553 | 80cc | PE | White | 7660191 | 7660557 | – | 7660938 |
| 7660572 | 100cc | PE | White | 7660191 | 7660580 | – | 7660581 |
| Nozzle Style: Wide Taper 1/4" ID x 7/8" Length | | | | | | | |
| 7660488 | 36cc | PE | White | 7660210 | – | – | 7660492 |
| Nozzle Style: Luer Slip Variant 1/16" ID x 21/32" Length | | | | | | | |
| 7660239 | 3cc | PE | White | 7660201 | – | 7660257 | – |

Optimum Cartridge Systems

Optimum cartridges and retainers have been designed to function as a complete, integrated system that improves yields and reduces costs in fluid packaging and dispensing processes.

Cartridge systems are designed for applications that require a reservoir larger than a 70cc syringe barrel. They are available in 2.5 fl oz, 6 fl oz, 12 fl oz, 20 fl oz, and 32 fl oz capacities, and can be used to make timed or visual deposits.

Features and Benefits

- Exceptional clarity to allow visual confirmation of fluid levels
- High-impact strength and dimensional stability
- ZeroDraft™ design ensures that internal diameter is consistent from top to bottom
- Excellent chemical compatibility with a wide range of fluids
- Available in clear, black, amber, and white
- White cartridges are molded from a proprietary blend and have better frozen temperature resistance

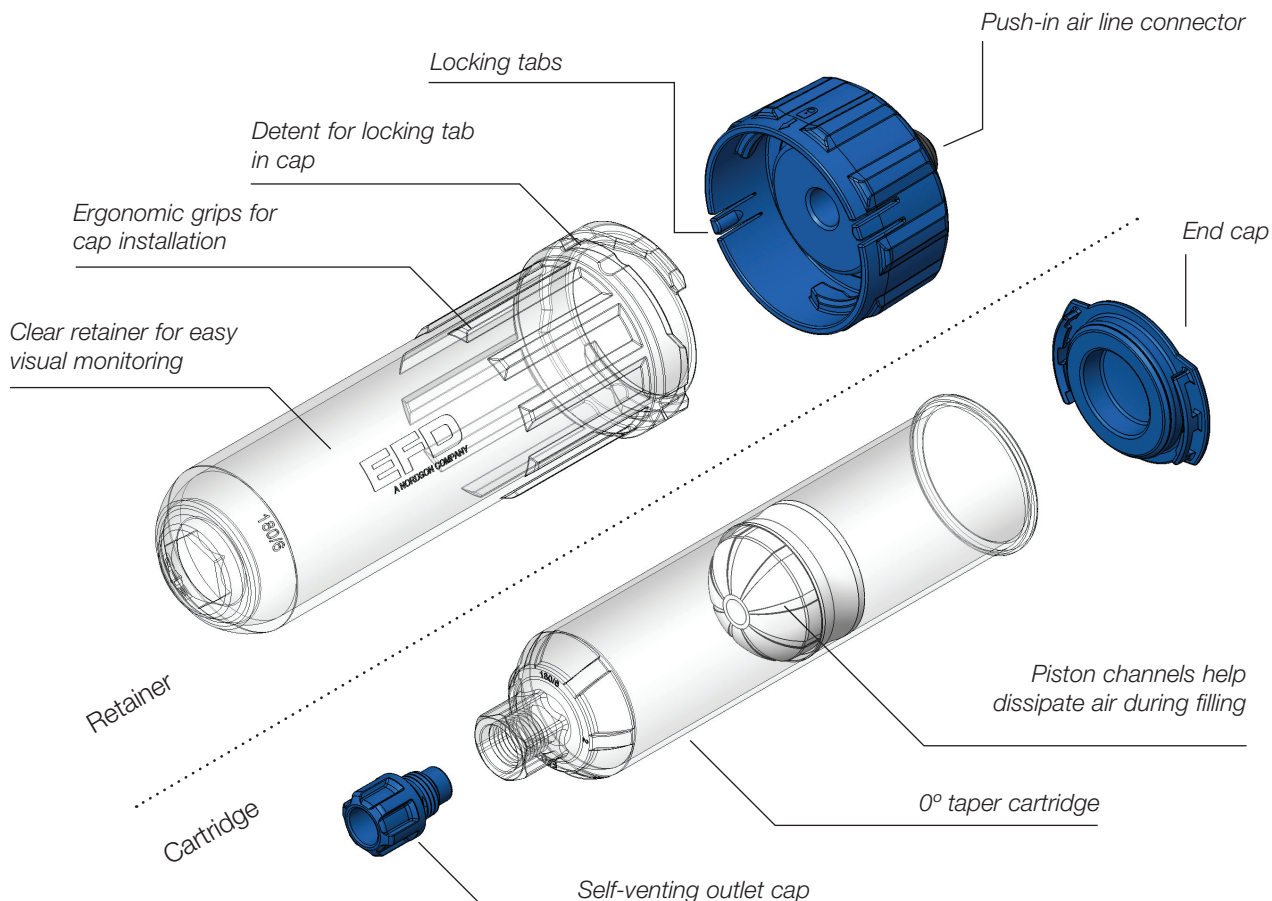





CARTRIDGES

| Size | Clear | White | Amber | Black | QTY |
|-------------------|---------|---------|---------|---------|-----|
| 2.5 fl oz (75 ml) | 7012389 | n/a | 7012390 | — | 25 |
| 6 fl oz (180 ml) | 7012398 | 7361311 | 7012399 | 7012400 | 25 |
| 12 fl oz (360 ml) | 7012407 | 7029498 | 7012408 | 7012409 | 25 |
| 20 fl oz (600 ml) | 7012416 | 7028361 | 7012736 | 7013878 | 10 |
| 32 fl oz (960 ml) | 7014088 | 7028392 | 7014089 | 7014091 | 10 |



Sets are available in clear for most fluids; transparent amber for UV- and light-sensitive materials (less than 12% visible light from 550 nm or less); and opaque black for complete light blockage.

CARTRIDGE FITTINGS

For both internal molded nozzle cartridges and external threaded cartridges.
For cartridge nozzles, see Precision Dispensing Tips.

| Fitting | Part # | Material | Description |
|---|---------|---------------------|--|
|  | 7022420 | Nylon | Barrel loader fitting 90° 1/4 NPT male Female luer lock to barrel elbow |
|  | 7022415 | Stainless Steel | Barrel loader fitting 1/4 NPT male Female luer lock |
|  | 7017020 | Black Polypropylene | 1/4 NPT x 3/8 compression |
|  | 7017014 | Black Polypropylene | 1/4 NPT x 1/4 compression |

TIP ADAPTERS

| Adapter | Part # | Material | Description |
|---|---------|---------------------|---|
|  | 7016941 | Polypropylene | 1/4 NPT standard cartridge tip adapter |
|  | 7016945 | Nickel-plated Brass | 1/4 NPT special purpose tip adapter for 725D Series, 725DA Series, 725HF-SS, 736HPA-NV, and cartridges |
|  | 7016948 | Black Polypropylene | 1/4 NPT tip adapter |

CARTRIDGE DIMENSIONS

| Size | A | B |
|-------------------|-----------------|-------------------|
| 2.5 fl oz (75 ml) | 43.2 mm (1.70") | 98.8 mm (3.89") |
| 6 fl oz (180 ml) | 43.2 mm (1.70") | 181.5 mm (7.15") |
| 12 fl oz (360 ml) | 43.2 mm (1.70") | 314.3 mm (12.38") |
| 20 fl oz (600 ml) | 68.3 mm (2.69") | 249.7 mm (9.83") |
| 32 fl oz (960 ml) | 68.3 mm (2.69") | 346.4 mm (13.69") |

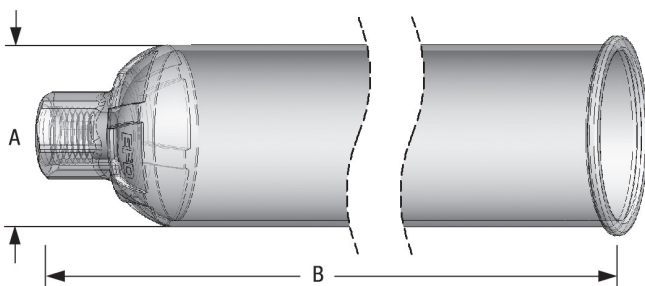

Note: This data is typical and does not constitute a specification.

Optimum Cartridge Systems



Cartridge Retainer Systems

Optimum cartridge retainers are molded from high-tensile, clarified resin that permits easy visual monitoring of fluid levels. Large textured ribs provide an ergonomic grip for cap installation.

Retainer caps feature locking tabs that snap securely into detents on the retainer body with an audible click. A push-in air line connector on top of the cap eliminates the need for bayonet connectors.

"EFD is our favorite vendor to deal with – fast, professional, and top notch products."
– Contract Packager

| RETAINER SYSTEMS | | | | |
|-----------------------------------|------------------------------------|------------------------------------|-------------------|--|
| Retainer Systems* | | Retainer Bodies | | |
| Part # | Size | Part # | Size | |
| 7012430 | 2.5 fl oz (75 ml) | 7013857 | 2.5 fl oz (75 ml) | |
| 7012433 | 6 fl oz (180 ml) | 7013858 | 6 fl oz (180 ml) | |
| 7012436 | 12 fl oz (360 ml) | 7013859 | 12 fl oz (360 ml) | |
| 7012439 | 20 fl oz (600 ml) | 7013860 | 20 fl oz (600 ml) | |
| 7013899 | 32 fl oz (960 ml) | 7013900 | 32 fl oz (960 ml) | |
| Retainer Cap Assemblies | | | | |
| Part # | Size | | | |
| 7012531 | 2.5, 6, 12 fl oz (75, 180, 360 ml) | | | |
| 7012532 | 20, 32 fl oz (600, 960 ml) | | | |
| Retainer Cap O-ring Kits (2/pkg.) | | | | |
| Part # | Material | Size | | |
| 7014373 | Buna | 2.5, 6, 12 fl oz (75, 180, 360 ml) | | |
| 7026914 | EPR | 2.5, 6, 12 fl oz (75, 180, 360 ml) | | |
| 7014372 | Buna | 20, 32 fl oz (600, 960 ml) | | |
| 7026916 | EPR | 20, 32 fl oz (600, 960 ml) | | |
| 7026917 | Viton | 20, 32 fl oz (600, 960 ml) | | |

*Note: For retainer systems with 100 psi and 15 psi regulators, see Tanks, Reservoirs, and Pumps. The retainer cap O-rings are available in three different materials. Please select the one most compatible with your fluid. Standard O-ring material is Buna.

Cartridge Pistons

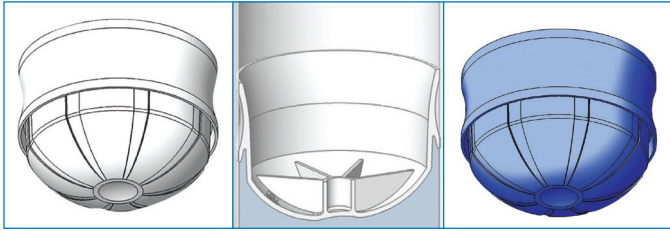

Optimum pistons are precision molded from high-density polyethylene. The consistent fit perfectly matches cartridge walls for smooth, unobstructed travel and ensures consistent results in fluid packaging and dispensing processes.

Unique channels help dissipate air during the filling process, reducing or eliminating the need to centrifuge. Dual wiping edges eliminate waste and residue to lower production costs and simplify disposal of used cartridges.

Blue pistons have a smaller leading edge wiper. The looser fit reduces dripping or stringing during the dispensing of very thick fluids and the color makes it easy to see the piston position inside the cartridge.

| CARTRIDGE PISTONS | | | |
|-------------------|---------------------------------------|-------|---------|
| Part # | Size | Color | Qty/Box |
| 7012419 | 2.5, 6, 12 fl oz (75, 180, 360 ml) | White | 25 |
| 7362087 | 2.5, 6, 12 fl oz (75, 180, 360 ml) | Blue | 25 |
| 7012421 | 20, 32 fl oz (600, 960 ml) | White | 10 |



Cartridge End/Outlet Caps

End caps snap securely over cartridge flanges to prevent leaks and fluid contamination. The center push-button presses the cap against the cartridge wall to form a positive, airtight seal.

Self-venting outlet caps feature a large ribbed gripping area that simplifies manual installation, along with precision molded threads and a tapered seat that provides a snug, leakproof seal.

| CARTRIDGE END CAPS | | | |
|--------------------|---------------------------------------|-------|---------|
| Part # | Size | Color | Qty/Box |
| 7012423 | 2.5, 6, 12 fl oz (75, 180, 360 ml) | Blue | 25 |
| 7012425 | 20, 32 fl oz (600, 960 ml) | Blue | 10 |

| CARTRIDGE OUTLET CAPS | | | |
|-----------------------|------|-------|---------|
| Part # | Size | Color | Qty/Box |
| 7012427* | All | Blue | 25 |

*Tighten to: 10 lbf-in

Precision Dispensing Tips



Optimum Dispensing Tips

EFD produces the highest quality dispensing tips in the industry. All tips are produced in our own silicone-free facilities and subjected to stringent quality control inspections throughout the entire manufacturing process.

Features and Benefits

- Free of flash, burrs, and contaminants
- Package labels include lot numbers for process control and traceability
- Consistent from style to style and lot to lot
- 360° SafetyLok™ thread ensures safe, positive attachment to syringe barrel
- Engineered hub flats for easy twist on, twist off

Available in multiple styles:

Precision Stainless Steel Passivated stainless steel tips handle a wide range of fluids and applications.

Tapered Smooth flow for application of medium- to high-viscosity fluids — especially thick or particle-filled materials like epoxies, RTVs, and braze pastes.

Flexible Polypropylene shafts reach into hard-to-access areas and will not scratch delicate surfaces. Easily cut to size or angled as needed.

Angled Stainless steel tips available with 45° and 90° bends. Custom bends available.

Brush For spreading glues and greases. Available with soft or stiff bristles.

Specialty For specific applications: Chamfered, PTFE-coated and PTFE-lined, microdot tips, and oval tips.

Ceramic MicroDot For precise micro-deposits as small as 100 µm. Compatible with wide range of fluids, even fine particle-filled materials.

Precision Nozzle For tight tolerance micro-dispensing in CCM, LED, semiconductor, and other high-precision industries.

“EFD components are more durable than others we have used. We have never encountered a problem with EFD tips and syringes, and that’s saying a lot.”

— Magnavox

DISPENSING TIP SAMPLE KIT

| Part # | Description |
|---------|--|
| 7013229 | Includes a selection of various types and styles of dispensing tips, pistons, tip and end caps — 150+ pieces |



www.nordsonefd.com/TipAdvice

Precision Dispensing Tips



| PRECISION STAINLESS STEEL TIPS | | | | | | | | | | | | | | |
|--------------------------------|-------|----------|------|-------|------|-------|--------------------|--------------------|-------------------|-------------------|-------------------|-------------------|-------------------|-------------|
| Gauge | Color | | ID | | OD | | Straight | Straight | Straight | Straight | 45° Bend | 90° Bend | 45° Bend | Qty/ Box |
| | | | mm | inch | mm | inch | 6.35 mm (0.25") | 12.7 mm (0.50") | 25.4 mm (1.0") | 38.1 mm (1.5") | 12.7 mm (0.5") | 12.7 mm (0.5") | 38.1 mm (1.5") | |
| 14 | | Olive | 1.54 | 0.060 | 1.83 | 0.072 | 7018029 | 7018043 | 7018032 | 7018035 | 7018044 | 7018045 | 7016906 | 50 |
| 15 | | Amber | 1.36 | 0.053 | 1.65 | 0.065 | – | 7018068 | 7018059 | 7018062 | 7018069 | – | n/a | 50 |
| 18 | | Green | 0.84 | 0.033 | 1.27 | 0.050 | 7018107 | 7018122 | 7018110 | 7018113 | 7018123 | 7018124 | 7016908 | 50 |
| 20 | | Pink | 0.61 | 0.024 | 0.91 | 0.036 | 7018163 | 7018178 | 7018166 | 7018169 | 7018179 | 7018180 | n/a | 50 |
| 21 | | Purple | 0.51 | 0.020 | 0.82 | 0.032 | 7005005 | 7018233 | 7018222 | 7018225 | 7018234 | – | 7016910 | 50 |
| 22 | | Blue | 0.41 | 0.016 | 0.72 | 0.028 | 7018260 | 7018272 | 7018263 | 7018266 | 7018273 | 7018274 | n/a | 50 |
| 23 | | Orange | 0.33 | 0.013 | 0.65 | 0.025 | 7018302 | 7018314 | 7018305 | 7018308 | 7018315 | 7018316 | n/a | 50 |
| 25 | | Red | 0.25 | 0.010 | 0.52 | 0.020 | 7018333 | 7018345 | 7018336 | 7018339 | 7018346 | 7018347 | n/a | 50 |
| 27 | | Clear | 0.20 | 0.008 | 0.42 | 0.016 | 7018395 | 7005008 | n/a | n/a | 7018404 | 7018405 | n/a | 50 |
| 30 | | Lavender | 0.15 | 0.006 | 0.31 | 0.012 | 7018424 | 7018433 | n/a | n/a | 7018434 | 7018435 | n/a | 50 |
| 32 | | Yellow | 0.10 | 0.004 | 0.24 | 0.009 | 7018462 | n/a | n/a | n/a | n/a | n/a | n/a | 50 |

Burr-free, polished, passivated stainless steel dispensing tips with polypropylene SafetyLok hubs for a secure fit to barrel reservoirs.

- 6.35 mm (0.25") tips: Fast point-to-point dispensing.
- 12.7 mm (0.50") tips: Standard all-around precision dispensing tips.
- 45° and 90° bent tips: Easy access into hard-to-reach areas.

| SMOOTHFLOW TAPERED TIPS | | | | | | | |
|-------------------------|-------|-------|------|-------|----------|--------------|-------------|
| Gauge | Color | | ID | | Standard | Opaque Rigid | Qty/ Box |
| | | | mm | inch | | | |
| 14 | | Olive | 1.60 | 0.063 | 7018052 | 7018049 | 50 |
| 16 | | Grey | 1.19 | 0.047 | 7018100 | 7018097 | 50 |
| 18 | | Green | 0.84 | 0.033 | 7018158 | 7018147 | 50 |
| 20 | | Pink | 0.58 | 0.023 | 7005009 | 7005006 | 50 |
| 22 | | Blue | 0.41 | 0.016 | 7018298 | 7005007 | 50 |
| 25 | | Red | 0.25 | 0.010 | 7018391 | 7018370 | 50 |
| 27 | | Clear | 0.20 | 0.008 | 7018417 | n/a | 50 |



Use with gel cyanoacrylates, UV-cure adhesives, sealants, and particle-filled materials or any medium- to high-viscosity fluid. Standard, flexible translucent tips are molded of polyethylene and the colored versions contain a light-block additive that protects UV-sensitive fluids. Rigid opaque tips are molded of polypropylene and the opacity of the material delivers light-blocking functionality to protect light-sensitive fluids. Standard tapered tips are recommended for best results.

| FLEXIBLE TIPS | | | | | | | |
|---------------|-------|-------|------|-------|--------------------|-------------------|-------------|
| Gauge | Color | | ID | | 12.7 mm (0.50") | 38.1 mm (1.5") | Qty/ Box |
| | | | mm | inch | | | |
| 15 | | Amber | 1.25 | 0.049 | 7018085 | 7018080 | 50 |
| 18 | | Green | 0.84 | 0.033 | 7018143 | 7018138 | 50 |
| 20 | | Pink | 0.48 | 0.019 | 7018205 | 7018201 | 50 |
| 25 | | Red | 0.36 | 0.014 | 7018366 | 7018362 | 50 |

Flexible polypropylene tubing for application into difficult-to-access areas. Easily drags along edges and around corners and prevents scratching. Tubing can be cut to length.

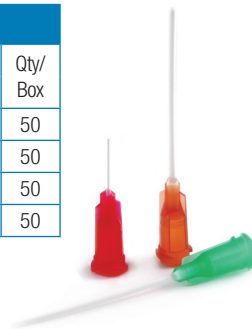





| BRUSH TIPS | | | |
|---------------|---------------------|-----------|-------------|
| Style | 50.8 mm (2") length | | Qty/ Box |
| | Standard | High Flow | |
| Soft bristle | 7022730 | 7022731 | 50 |
| Stiff bristle | 7015351 | 7015467 | 50 |



Spread glues and greases. Brush tips are made with high quality 6/12 nylon, known for its strength and wear resistance. Soft brush tips are 0.003" diameter level; stiff brush tips are 0.006".









Precision Dispensing Tips

| PTFE-COATED TIPS | | | | | | | | |
|------------------|---|--------|------|-------|------|-------|-----------------|---------|
| Gauge | Color | | ID | | OD | | 12.7 mm (0.50") | Qty/Box |
| | | | mm | inch | mm | inch | | |
| 21 |  | Purple | 0.51 | 0.020 | 0.84 | 0.033 | 7018243 | 20 |
| 22 |  | Blue | 0.41 | 0.016 | 0.74 | 0.029 | 7018290 | 20 |
| 23 |  | Orange | 0.33 | 0.013 | 0.66 | 0.026 | 7018326 | 20 |
| 25 |  | Red | 0.25 | 0.010 | 0.53 | 0.021 | 7018359 | 20 |





Controls wicking to stop drips in optical media applications.

| PTFE-LINED TIPS | | | | | | |
|---|------|------|-----------------|----------------|---------|----|
| Color | ID | | 12.7 mm (0.50") | 25.4 mm (1.0") | Qty/Box | |
| | mm | inch | | | | |
|  | Grey | 0.51 | 0.020 | 7018256 | 7005003 | 50 |
|  | Pink | 0.30 | 0.012 | 7018388 | 7005004 | 50 |

Resists clogging of cyanoacrylates. Use for microdot application of low viscosity fluids.



| CHAMFERED TIPS | | | | | | | | |
|----------------|---|--------|------|-------|-----------------|-----------------|-----------------|---------|
| Gauge | Color | | ID | | 38.1 mm (1.50") | 12.7 mm (0.50") | 6.35 mm (0.25") | Qty/Box |
| | | | mm | inch | | | | |
| 18 |  | Green | 0.84 | 0.033 | n/a | 7018129 | n/a | 50 |
| 20 |  | Pink | 0.61 | 0.024 | 7018188 | n/a | n/a | 50 |
| 22 |  | Blue | 0.41 | 0.016 | 7018281 | n/a | n/a | 50 |
| 23 |  | Orange | 0.33 | 0.013 | n/a | 7018321 | n/a | 50 |
| 25 |  | Red | 0.25 | 0.010 | n/a | 7018352 | n/a | 50 |
| 27 |  | Clear | 0.20 | 0.008 | n/a | n/a | 7015236 | 50 |
| 33 |  | Clear | 0.10 | 0.004 | n/a | n/a | 7018482 | 25 |

Use for microdot application of low viscosity fluids.



| CERAMIC MICRODOT TIPS | | | | | | |
|-----------------------|---|--------|------|-------|---------|---------|
| Gauge | Color | | ID | | Part # | Qty/Box |
| | | | mm | inch | | |
| 37 |  | Black | 0.05 | 0.002 | 7364054 | 1 |
| 37 |  | Black | 0.05 | 0.002 | 7364055 | 10 |
| 37 |  | Silver | 0.05 | 0.002 | 7364386 | 1 |
| 37 |  | Silver | 0.05 | 0.002 | 7364540 | 1 |

Part number 7364386 only for use with PICO contact dispense valve.

| PRECISION NOZZLES | | | | | |
|-------------------|------|-------|-------------------|--------------------|--|
| Gauge | ID | | Part # Qty: 1 pc. | Part # Qty: 10 pc. | |
| | mm | inch | | | |
| 21 | 0.50 | 0.020 | 7365112 | 7365121 | |
| 22 | 0.40 | 0.016 | 7365110 | 7365119 | |
| 24 | 0.30 | 0.012 | 7365108 | 7365117 | |
| 25 | 0.25 | 0.010 | 7365107 | 7365116 | |
| 27 | 0.20 | 0.008 | 7365106 | — | |
| 30 | 0.15 | 0.006 | 7365105 | 7365114 | |
| 32 | 0.10 | 0.004 | 7365104 | 7365113 | |

| OVAL TIPS | | | | |
|-----------|---|--------|-----------------|---------|
| Gauge | Color | | 12.7 mm (0.50") | Qty/Box |
| | | | | |
| 18 |  | Green | 7024653 | 50 |
| 23 |  | Orange | 7024656 | 50 |

Flat ribbon deposits of thick pastes, sealants & epoxies.

| TIP SHIELDS | | | | |
|-------------|---|-------|---------|---------|
| Size | Color | | Part # | Qty/Box |
| 3cc |  | Red | 7017715 | 10 |
| 5cc to 70cc |  | Black | 7017717 | 10 |

Reusable tip shields for light-sensitive and UV-cure adhesives. Fits over dispensing tip hub.

| POLYETHYLENE NOZZLES | | | | | | |
|----------------------|-------|------|--------|---------|--------|---------|
| Gauge | ID | | length | | Part # | Qty/Bag |
| | cm | inch | cm | inch | | |
| 0.318 | 0.125 | 6.35 | 2.5 | 7018555 | 10 | |
| 0.157 | 0.062 | 6.35 | 2.5 | 7018557 | 10 | |
| 0.157 | 0.062 | 10.6 | 4.0 | 7018559 | 10 | |
| 0.08 | 0.031 | 10.6 | 4.0 | 7018561 | 10 | |

Polyethylene nozzles thread into all cartridge sizes and 725 Series and 736HPA-NV valves. 1/4 NPT (6.35 mm) thread.

| METAL NOZZLES | | | | |
|---------------|-----|-------|---------|---------|
| Gauge | ID | | Part # | Qty/Bag |
| | mm | inch | | |
| 7 | 3.8 | 0.150 | 7014850 | 1 |
| 8 | 3.4 | 0.135 | 7014851 | 1 |
| 10 | 2.7 | 0.106 | 7014848 | 1 |
| 12 | 2.2 | 0.085 | 7014842 | 1 |
| 14 | 1.6 | 0.063 | 7014844 | 1 |
| 16 | 1.2 | 0.047 | 7014846 | 1 |

Metal nozzles thread into all cartridge sizes to fit 725 Series and 736HPA-NV valves. 38.1 mm (1 1/2") long metal nozzles with 1/4 NPT.

Precision Dispensing Tips

| Applications | DISPENSING TIPS | | | | | | |
|-----------------------------|-----------------|-----------------|------------|----------|------------------|--------------------------|------------------|
| | Tapered | Stainless Steel | PTFE-Lined | Flexible | MicroDot Ceramic | MicroDot Stainless Steel | Precision Nozzle |
| Very Low Viscosity Fluids | X | ● | ● | ● | ● | ● | ● |
| Particle-Filled Pastes | ● | ● | ▲ | X | ● | ▲ | ● |
| Microdot Deposits | X | ● | ▲ | ● | ● | ● | ● |
| Fluid is Reactive to Metal | ● | X | ● | ● | ● | X | X |
| Depositing in Recesses | ▲ | ● | ● | ▲ | ● | ● | X |
| Spreading/Smearing | ● | ▲ | ● | ▲ | ● | ● | ● |
| Fast-Curing Glues | ● | ▲ | ● | ● | ▲ | ▲ | X |
| Beading, Striping | ● | ● | ● | ▲ | ● | ▲ | ● |
| Easily Scratched Substrates | ● | ▲ | ● | ● | ● | ▲ | ▲ |
| Fluids | | | | | | | |
| Adhesives | ● | ● | ● | ● | ● | ● | ● |
| Anaerobics | ● | ▲ | ● | ▲ | ● | X | X |
| Conformal Coatings | ● | ▲ | ▲ | X | ▲ | ▲ | ● |
| Cyanoacrylates | ● | ▲ | ● | ● | ● | ▲ | ▲ |
| Gel Cyanoacrylates | ● | ▲ | ● | ▲ | ● | ▲ | ▲ |
| Epoxies | ● | ● | ● | X | ● | ● | ● |
| Greases | ● | ● | ● | X | ● | ● | ● |
| Light-Cure Adhesives | ● | ▲* | ▲* | X | ▲ | ● | ● |
| Oils | ● | ● | ● | ▲ | ● | ● | ● |
| Paints | ● | ● | ● | X | ● | ● | ● |
| Sealants | ● | ▲ | ▲ | X | ● | ● | ● |
| Silver Epoxy | X | ▲+ | X | X | ● | ▲ | ● |
| Solder Paste/Braze Pastes | ● | ● | ▲ | X | ● | ▲ | ● |
| Solder Masks | ● | ● | ▲ | X | ● | ● | ● |
| Solvents | X | ● | ● | ● | ● | ● | ● |
| UV-Cure Adhesives | ●** | ▲* | ▲* | ▲ | ▲ | ● | ● |

*OK if used with tip shield, part #7017715 or 7017717.

+Chamfered tips are recommended for best results.

**Standard tapered tips are recommended for best results.

Key

- Recommended
- ▲ Satisfactory
- X Do not use



World Leader in Precision Fluid Dispensing

Nordson EFD's worldwide network of experienced product application specialists are available to discuss your dispensing project and recommend a system that meets your technical requirements and budget.

Here are just a few things our customers have to say about working with us:

"We're producing better-looking parts in half the time."

– ECM Motor Co.

"Our product is critical. That's why our choice is EFD equipment."

– Ethicon Endo Surgery

"Your system has several benefits compared to what we used before. We're talking about 75% less consumption [of oil]."

– Gestamp Aveiro

"The quality of their product, as well as their knowledge and support, have been nothing short of excellent."

– Lorik Tool & Automation Inc.

"Better control means over \$50,000 in fluid savings annually."

– Mitsubishi

"It's not complicated. You set it up and it works."

– Texas Instruments

"Applications support from Nordson EFD has been exceptional. They are quick to respond & give us the information needed."

– Preh Ima Automation

"The quality of the packages that we put our products in matters. That's why we use EFD syringes and cartridges."

– Dymax



For Nordson EFD sales and service in over 40 countries, contact Nordson EFD or go to www.nordsonefd.com.

Global

800-556-3484; +1-401-431-7000
info@nordsonefd.com

Europe

00800 7001 7001
infoefd.europe@nordsonefd.com

Asia

China: +86 (21) 3866 9006; china@nordsonefd.com
India: +91 80 4021 3600; india@nordsonefd.com
Japan: +81 03 5762 2760; japan@nordsonefd.com
Korea: +82-31-736-8321; korea@nordsonefd.com
SEAsia: +65 6796 9522; sin-mal@nordsonefd.com

Viton is a trademark of E.I. DuPont.
©2023 Nordson Corporation 7014626 v022123