

You have selected a reliable, high-quality dispensing system from Nordson EFD, the world leader in fluid dispensing. The xQR41V Series needle valve was designed specifically for industrial dispensing and will provide you with years of trouble-free, productive service.

This manual will help you maximize the usefulness of your xQR41V needle valve.

Please spend a few minutes to become familiar with the controls and features. Follow our recommended testing procedures. Review the helpful information we have included, which is based on more than 50 years of industrial dispensing experience.

Most questions you will have are answered in this manual. However, if you need assistance, please do not hesitate to contact EFD or your authorized EFD distributor. Detailed contact information is provided on the last page of this document.

The Nordson EFD Pledge

Thank You!

You have just purchased the world's finest precision dispensing equipment.

I want you to know that all of us at Nordson EFD value your business and will do everything in our power to make you a satisfied customer.

If at any time you are not fully satisfied with our equipment or the support provided by your Nordson EFD Product Application Specialist, please contact me personally at 800.556.3484 (US), 401.431.7000 (outside US), or Srini.Subramanian@nordsonefd.com.

I guarantee that we will resolve any problems to your satisfaction.

Thanks again for choosing Nordson EFD.

Srini Subramanian
Srini Subramanian, General Manager

Contents

| | |
|---|----|
| Contents | 3 |
| Introduction | 4 |
| xQR41V Series Valve Options..... | 4 |
| BackPack Valve Actuator..... | 4 |
| Mounting Block Actuating Air Inlet..... | 4 |
| How the xQR41V Valve Operates..... | 5 |
| How the QR Clasp Works..... | 5 |
| How to Control the xQR41V Valve..... | 6 |
| Specifications..... | 7 |
| xQR41V Series Valve | 7 |
| BackPack Valve Actuator..... | 7 |
| Mounting Block Actuating Air Inlet | 7 |
| Operating Features..... | 8 |
| Installation | 9 |
| Mounting the Valve on the Dispensing Equipment..... | 9 |
| Installing a 90° Fluid Inlet Fitting..... | 9 |
| Making the System Connections..... | 10 |
| ValveMate 8000 System with an xQR41V Valve and BackPack Valve Actuator..... | 10 |
| ValveMate 8000 System with an xQR41V Valve and Mounting Block | 11 |
| ValveMate 7100 System with an xQR41V Valve | 12 |
| Dispensing Tip Change | 13 |
| Fluid Body Change..... | 13 |
| Valve Stroke Calibration | 14 |
| Service..... | 15 |
| Cleaning the Valve | 15 |
| Replacing the Piston and Needle Assembly or the Piston O-Ring..... | 16 |
| Replacing the Bullet Solenoid on the BackPack Valve Actuator | 17 |
| Part Numbers | 18 |
| Replacement Parts | 18 |
| Valve Components..... | 18 |
| Accessories | 19 |
| Troubleshooting..... | 20 |

Introduction

The xQR41V Series needle valve is a pneumatically operated, adjustable, modular valve designed to apply precise deposits of low-viscosity fluids (such as silicone oils, solvents, and UV-cure adhesives) in accurate, repeatable amounts onto a substrate. The xQR41V valve is ideal for automated assembly processes and can be used with the full range of Nordson EFD dispense tips, including general purpose stainless steel tips, SmoothFlow™ tapered tips, and PTFE-lined tips. The valve provides exceptional control as well as the absolute minimum of dead fluid volume, resulting in accurate, precise, and repeatable deposits.

The fluid body offers 360° rotational movement, allowing the fluid inlet to be positioned in the best orientation for fluid feed to the valve.

The xQR41V valve's unique quick-release (QR) clasp secures the fluid body to the air cylinder body and can be removed in seconds for fast change-out and easy cleaning and maintenance of the valve's wetted parts.

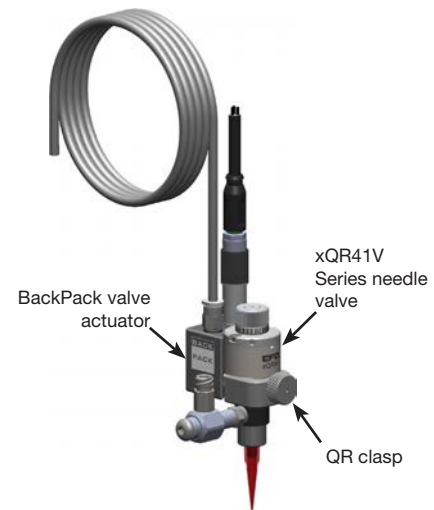

xQR41V Series Valve Options

The modular design of the xQR41V allows a variety of setup configurations to provide the best solution for fluid dispensing and production line installation.

BackPack Valve Actuator

The optional BackPack™ valve actuator can be mounted on the xQR41V valve's actuating air cylinder body to (1) provide faster valve response time and (2) to reduce the possibility of variations in deposit size due to a fluctuating plant air supply or different air line lengths.

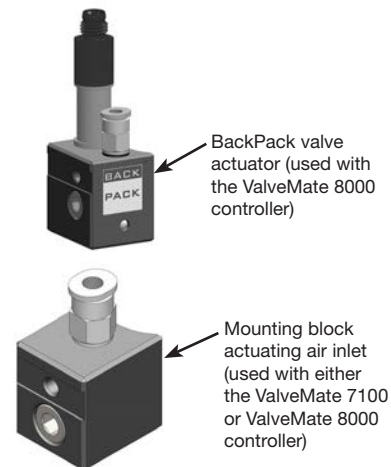

Mounting Block Actuating Air Inlet

The optional mounting block is a convenient push-in actuation air inlet fitting and flat mounting surface for easy installation onto fixture plates.

How the xQR41V Valve Operates

Input air pressure at 4.8 bar (70 psi) retracts the piston and needle from the needle seat in the dispensing tip, permitting fluid flow through the fluid body. Once the cycle is complete, air pressure is exhausted, causing the piston spring to return the needle back to its position in the fluid body seat, stopping fluid flow.

The amount of fluid dispensed will depend on the time the valve is open, fluid reservoir pressure, dispensing tip size, needle stroke, and fluid viscosity.

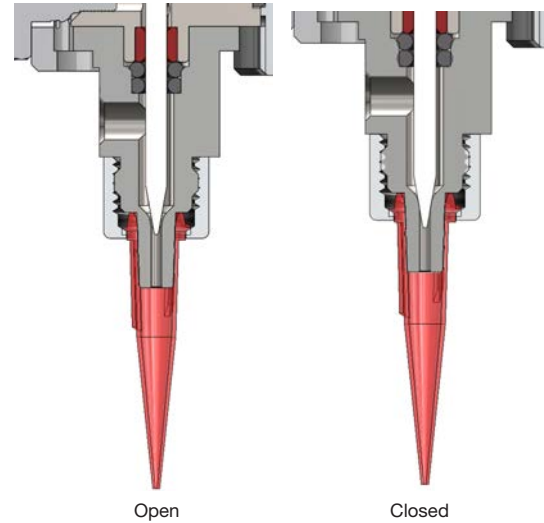

How the QR Clasp Works

The QR clasp slides into grooves on the body of the fluid valve to wedge the fluid body against the air actuator. A thumbscrew secures the entire valve assembly to prevent movement during cycling. The thumbscrew also acts like a jack screw to ease QR clasp removal.

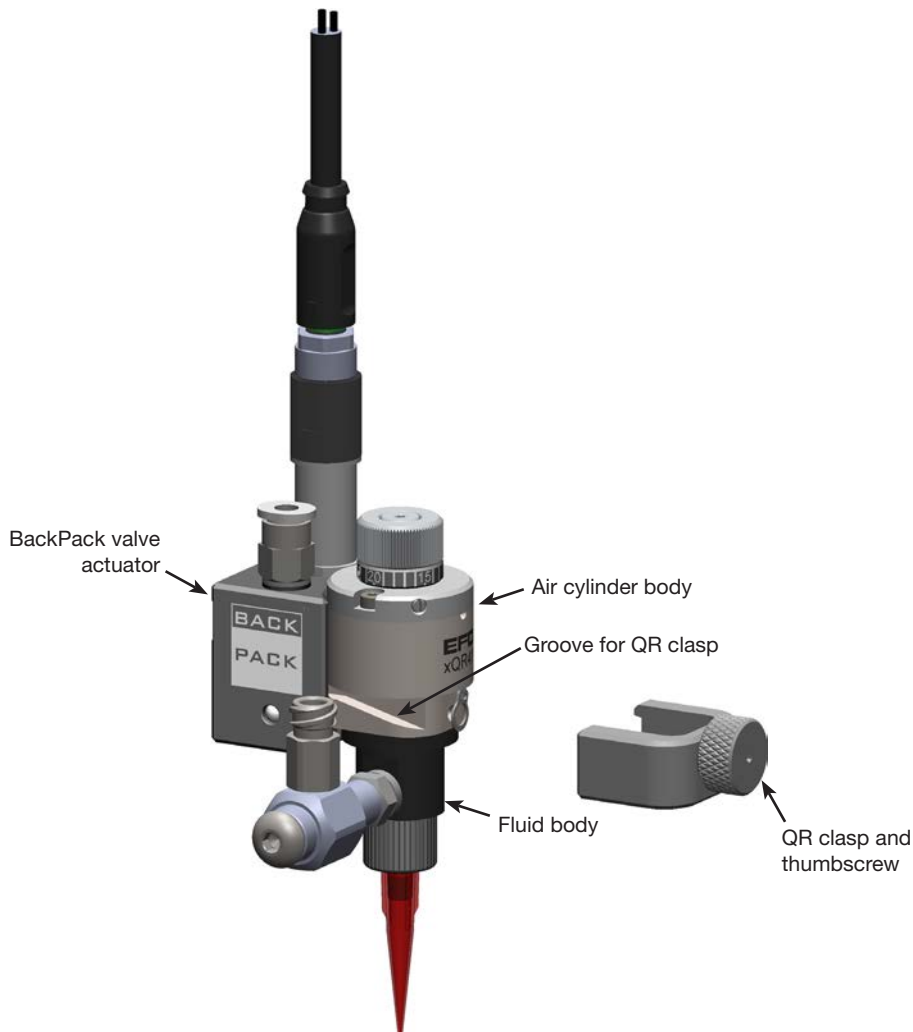

How to Control the xQR41V Valve

Two controllers are recommended for use with the xQR41V Series Microdot needle valves: the ValveMate™ 8000 and the ValveMate 7100.

For multi-valve installations using the Backpack valve actuator, mounting block, or 90° low-profile air inlet fitting, use the ValveMate 8000 controller to provide easy adjustment of valve output for maximum end-user convenience and efficiency. Valve open time is the primary control of deposit size. The ValveMate 8000 controller puts push-button adjustment of valve open time where it needs to be — at the valve.



The ValveMate 8000 features micro-processor circuitry for extremely precise control of deposit size. Feed lines can be purged, initial deposit sizes set, and adjustments made quickly and easily at the dispensing station, without stopping the production line.

For single valve installations using the mounting block or 90° low-profile air inlet, use the ValveMate 7100 controller. Incorporating programmable dispense time, digital time readout, keypad programming for easy user interface, and input / output communication with host machine PLCs, the ValveMate 7100 has been designed with the machine builder and operator in mind. The objectives are to bring dispensing control close to the point of application and to provide the features necessary to make setup and operation as easy and precise as possible.



NOTE: The ValveMate 7100 controller cannot be used with the xQR41V Backpack valve actuator.

Specifications

NOTE: Specifications and technical details are subject to engineering changes without prior notification.

xQR41V Series Valve

| Item | Specification |
|---|---|
| Size | 64 mm length x 23.7 mm diameter (2.5 x 0.93") |
| Weight | Valve only: 115 g (4.1 oz) With BackPack actuator: 170 g (6.0 oz) With mounting block: 140 g (4.9 oz) |
| Actuating air pressure required | 4.8–6.2 bar (70–90 psi) |
| Maximum fluid pressure | 7.0 bar (100 psi) |
| Fluid inlet | M5 |
| Fluid outlet | Luer taper with retaining nut |
| Mounting | M4 (BackPack valve actuator or mounting block) |
| Cycle rate | Exceeds 400 per minute |
| Air cylinder body | 303 stainless steel |
| Fluid body | PEEK (Polyetheretherketone) |
| Piston | 303 stainless steel |
| Needle | 303 stainless steel |
| Tip retaining nut | Hard-coated aluminum |
| Maximum operating temperature | 80° C (176° F) |
| US Patent No. 9,816,849 for QR clasp | |
| All stainless steel valve parts are passivated. | |

BackPack Valve Actuator

| Item | Specification |
|---|---|
| Size | 26.2w x 26.7h x 18.4d mm (1.03w x 1.05h x 0.72d") |
| Weight | Valve actuator only: 53.8 g (1.9 oz) Installed on xQR41V valve: 170 g (6.0 oz) |
| Actuating air pressure required | 4.8–6.2 bar (70–90 psi) |
| Input voltage | 24 VDC, 4 W |
| Minimum actuation time | 5 ms |
| Maximum actuation time | Continuous ON |
| Operating frequency | 60–80Hz |
| Housing | Anodized aluminum |
| Mounting bolt | 303 stainless steel |
| All stainless steel valve parts are passivated. | |

Mounting Block Actuating Air Inlet

| Item | Specification |
|---|---|
| Size | 18.4w x 21.6h x 21.4d mm (0.72w x 0.85h x 0.84d") |
| Weight | Mounting block only: 25.0 g (0.9 oz) Installed on xQR41V valve: 140 g (4.9 oz) |
| Housing | Anodized aluminum |
| Mounting bolt | 303 stainless steel |
| All stainless steel valve parts are passivated. | |

Operating Features

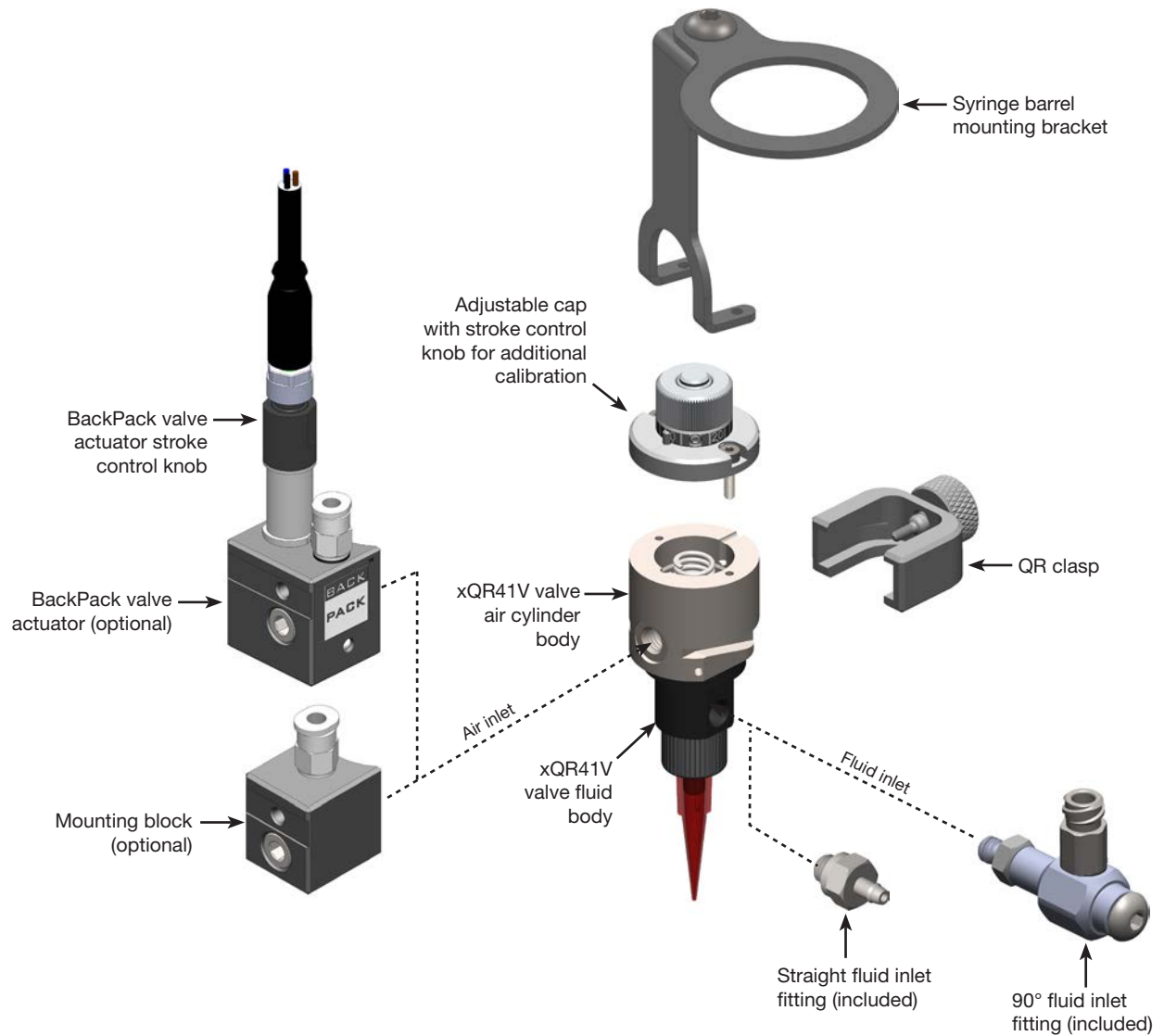

Installation

NOTE: Prior to installing the valve, read the associated reservoir and valve controller operating manuals to become familiar with the operation of all components of the dispensing system.

Mounting the Valve on the Dispensing Equipment

1. Secure the xQR41V valve to the Backpack valve actuator or to the mounting block, as applicable.
2. (Optional) Secure the valve and Backpack / mounting block assembly to the mounting bracket. There are multiple mounting holes to allow for adjustment.
3. Install the complete assembly on the dispensing equipment.

⚠ CAUTION

Do not over-tighten the QR clasp thumb screw. Doing so can break the screw.

4. Orient the fluid body and install the QR clasp as follows:
 - a. Partially thread the QR clasp thumbscrew into the air cylinder body.
 - b. When the thumbscrew is engaged, rotate the fluid body to the required alignment based on the use of a 90° fluid inlet fitting.
 - c. Finger-tighten the thumbscrew to fully secure fluid body to the air actuator.

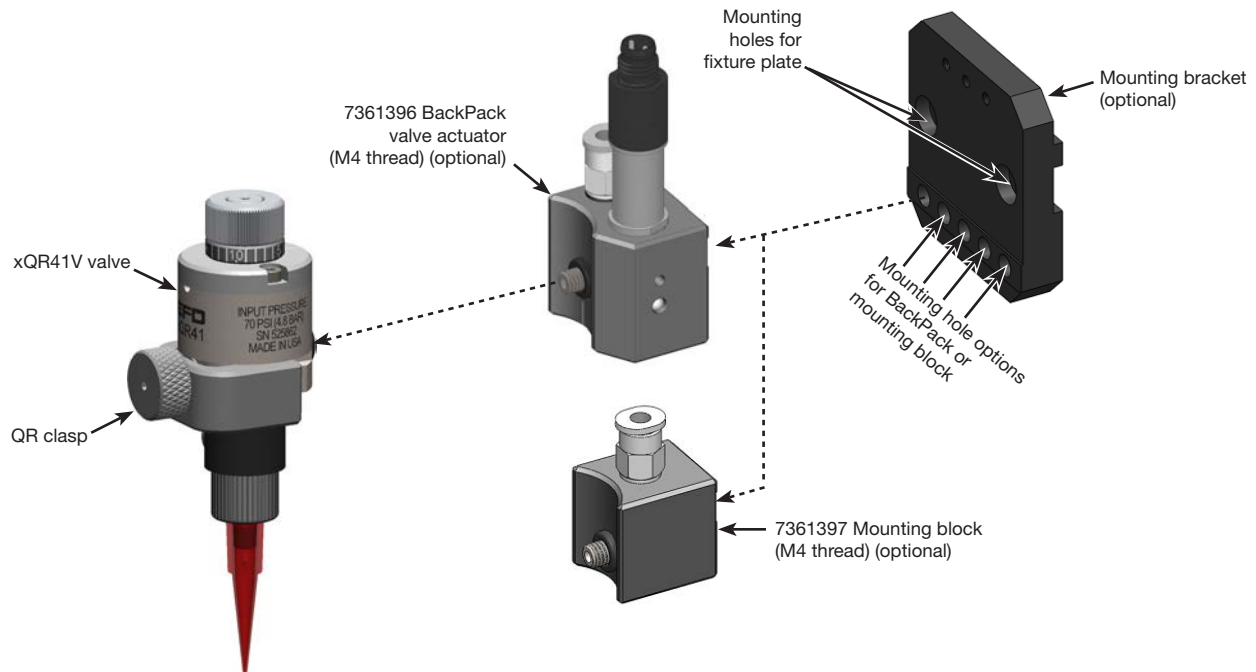

Installing a 90° Fluid Inlet Fitting

1. Thread the fitting nut fully onto the 90° fluid inlet fitting (towards the luer fitting).
2. Fully thread the 90° fluid inlet fitting assembly into the valve fluid body, then unthread the assembly until the luer fitting is at the desired orientation.

NOTE: Do not unthread the 90° fluid inlet fitting more than one (1) turn.

3. Use an 8-mm wrench to tighten the fitting nut against the fluid body.

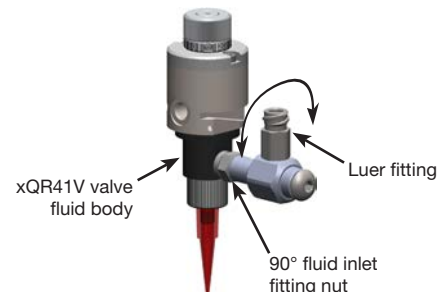

Making the System Connections

For complete installation, set up, and testing instructions, refer to the controller operating manual.

ValveMate 8000 System with an xQR41V Valve and Backpack Valve Actuator

This illustration shows a complete installation using the ValveMate 8000 controller and the Backpack valve actuator option.

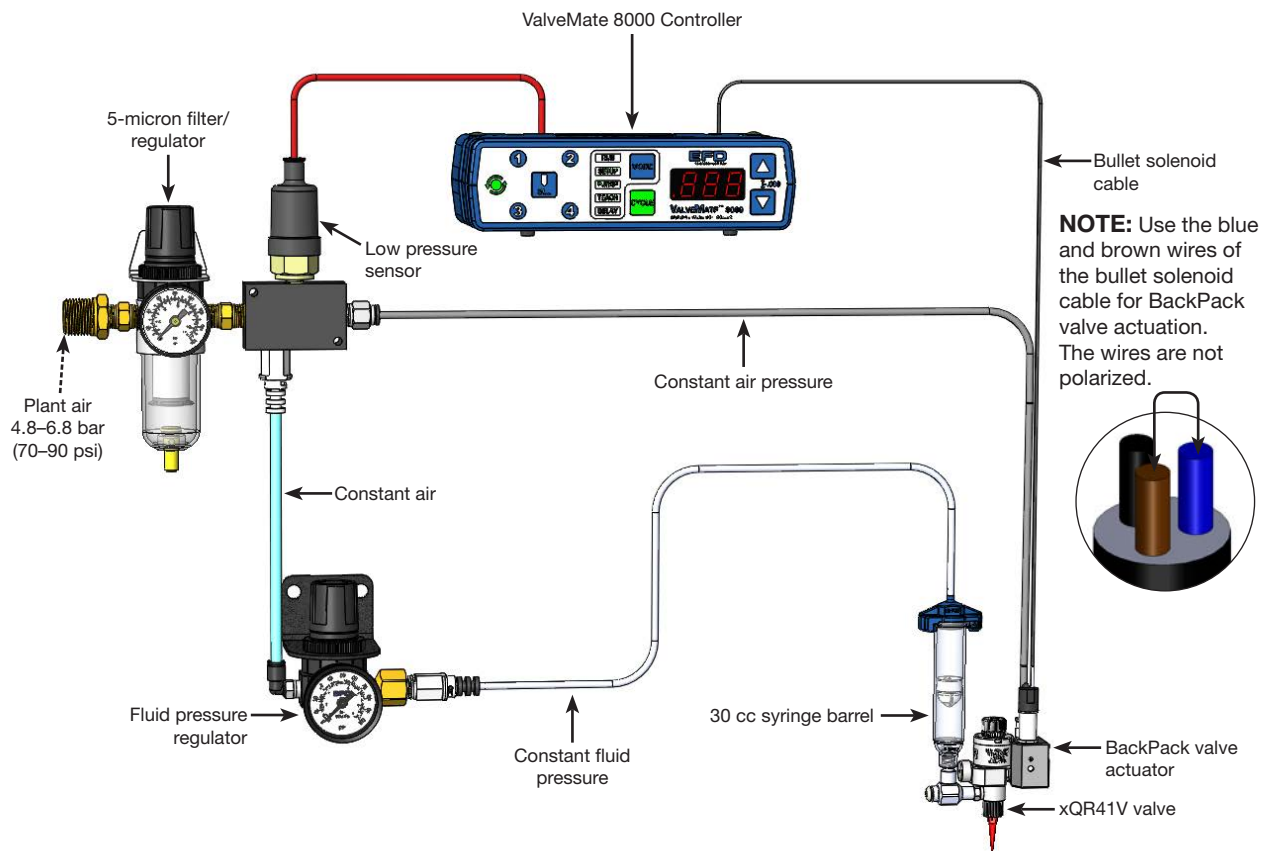

Making the System Connections (continued)

For complete installation, set up, and testing instructions, refer to the controller operating manual.

ValveMate 8000 System with an xQR41V Valve and Mounting Block

This illustration shows a complete installation using the ValveMate 8000 controller and the mounting block option.

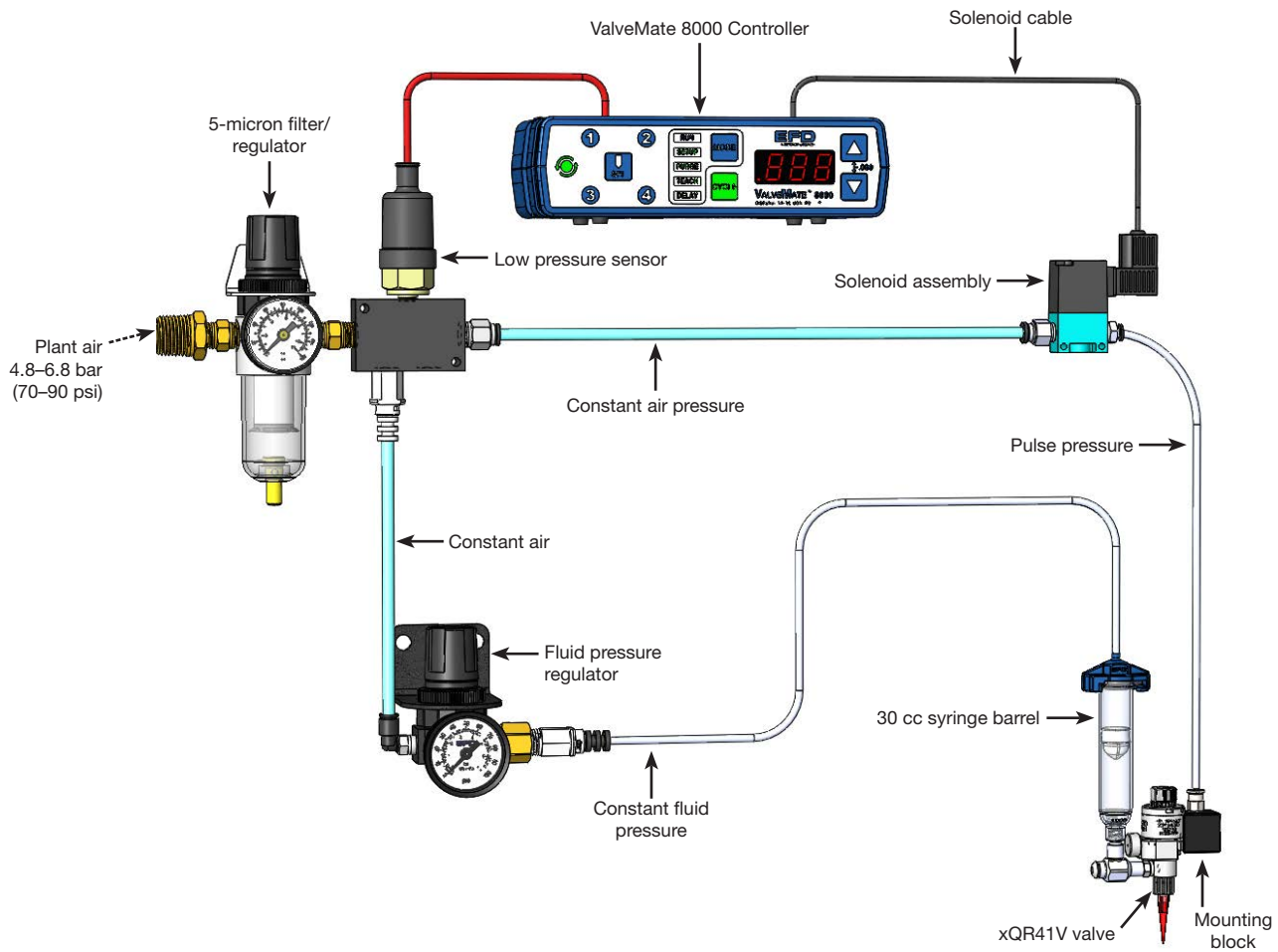

Making the System Connections (continued)

For complete installation, set up, and testing instructions, refer to the controller operating manual.

ValveMate 7100 System with an xQR41V Valve

This illustration shows a complete installation using the ValveMate 7100 controller.

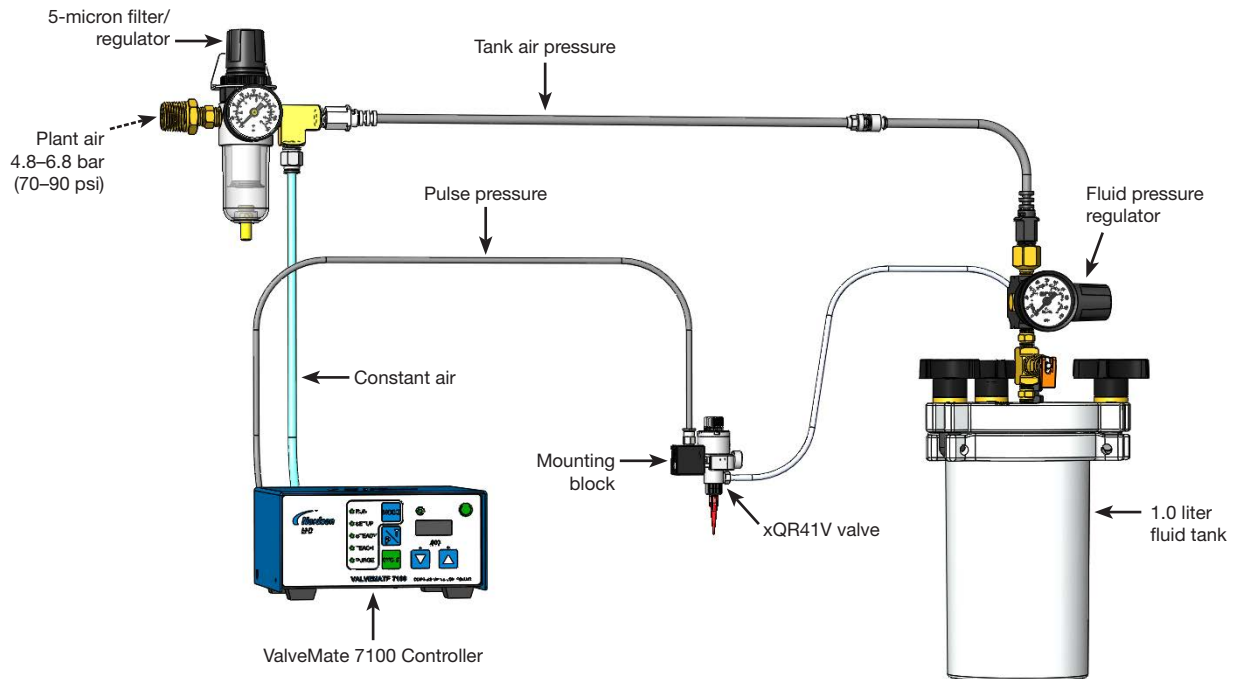

CAUTION

Always de-pressurize the fluid reservoir before opening it. To do this, slide the shutoff valve on the air line away from the reservoir. Before opening the reservoir, check the pressure gauge to verify that pressure is zero (0). If using an EFD tank, also open the pressure relief valve.

On all EFD cartridge reservoirs, the unique threaded design provides fail-safe air pressure release during cap removal.

Dispensing Tip Change

⚠ CAUTION

Before any component change or service activity, relieve air pressure from the fluid reservoirs.

1. Remove the retaining nut and then remove the dispensing tip.
2. Install the new dispensing tip and secure it with the retaining nut. Ensure that the retaining nut is fully tightened.



Fluid Body Change

You can quickly remove the fluid body of the xQR41V valve and install a replacement fluid body, thus greatly minimizing downtime. The removed fluid body can be serviced and ready for use for the next required fluid body change-out.

NOTE: The xQR41V valve has an adjustable cap with a stroke control knob. On this knob, the stroke control reference ring is factory calibrated to the zero (0) position. Replacement of the fluid body may require the stroke control to be recalibrated when a fluid body is changed.

⚠ CAUTION

Before any component change or service activity, relieve air pressure from the fluid reservoirs.

1. Remove the syringe barrel from the 90° fluid inlet fitting.
2. Make a note of the current stroke number setting.
3. Turn the stroke control knob counterclockwise to fully open.
4. Turn the QR clasp thumbscrew counterclockwise to disengage the clasp.
5. Carefully move the fluid body downward until it clears the air actuator / needle assembly.

⚠ CAUTION

Do not wipe the needle with an abrasive material, specifically in chemically sensitive applications. Doing so can damage the needle.

6. Remove the double-stacked O-rings or spring-energized seal from either the needle assembly or the fluid body cavity. Wipe the needle clean of any remaining fluid.
7. Apply a lubricant compatible with the dispensing fluid to new double-stacked O-rings (if applicable) and install the new double-stacked O-rings or a new spring-energized seal on the needle.

NOTE: If a spring-energized seal is used, install the seal with the spring facing the fluid flow.

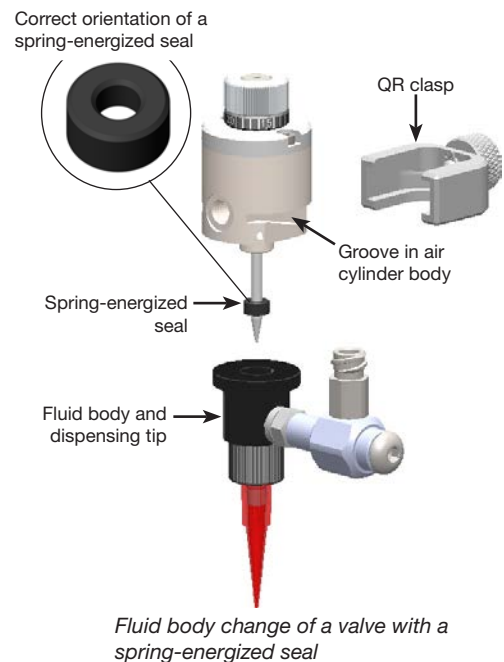
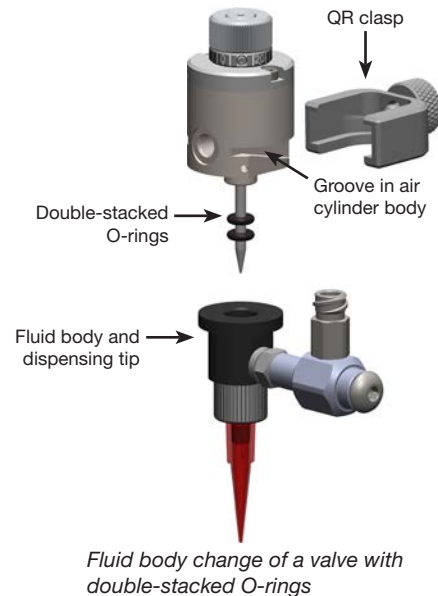

Fluid Body Change (continued)

8. Use one hand to position a replacement fluid body on the air actuator / needle assembly and then slide the QR clamp into the grooves on the cylinder body.

⚠ CAUTION

Do not over-tighten the QR clamp thumb screw. Doing so can break the screw.

9. Fully install the QR clamp as follows:
 - a. Partially thread the QR clamp thumbscrew into the air cylinder body.
 - b. When the thumbscrew is engaged, rotate the fluid body to the required alignment.
 - c. Finger-tighten the thumbscrew to fully secure fluid body to the air actuator.
10. Set the stroke reference ring to the desired stroke setting or continue to “Valve Stroke Calibration” on this page to calibrate the stroke control.

Valve Stroke Calibration

⚠ CAUTION

Do not over-tighten the stroke control knob. Tightening the knob past 2.6 N•m (20 in.-lb) of torque can damage the knob.

1. Turn the stroke control knob clockwise until it stops (at the internal piston).
2. If necessary, use an 0.035" hex wrench to re-zero the reference ring by aligning the zero mark with the reference mark on the air cylinder body.
3. Tighten the set screw to lock the stroke reference ring in position.
4. Reset the stroke number setting to the position noted in step 1.

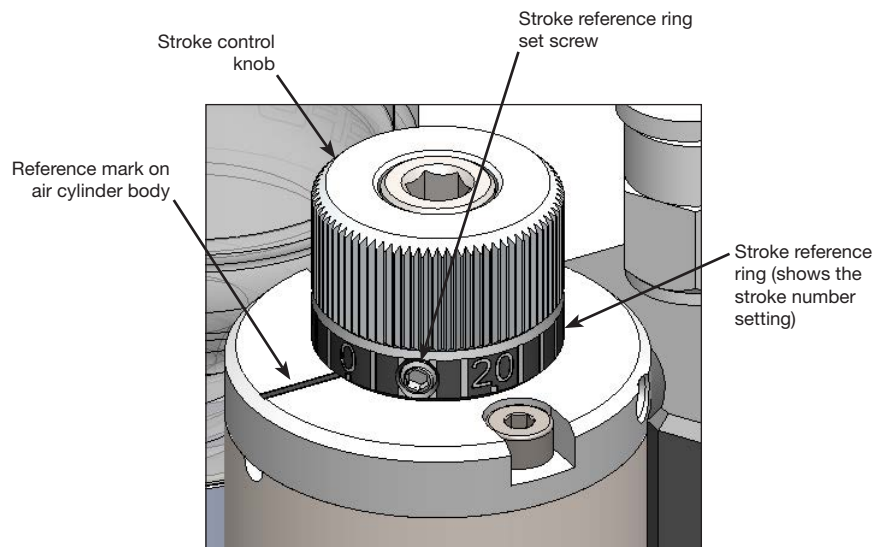

Service

Perform these service procedures as needed for the best valve operation.

⚠ CAUTION

Before any component change or service activity, relieve air pressure from the fluid reservoirs.

⚠ CAUTION

To prevent damage, begin disassembly of the valve at the fluid outlet end.

Cleaning the Valve

Follow this procedure to thoroughly clean the fluid body and to replace the fluid body O-ring seal.

1. Turn the QR clasp thumbscrew counterclockwise to disengage the clasp.
2. Carefully move the fluid body downward until it clears the air actuator / needle assembly.
3. If the fluid body O-ring seal (not shown) remains on the piston needle, gently slide it off the needle.

⚠ CAUTION

Do not wipe the needle with an abrasive material, specifically in chemically sensitive applications. Doing so can damage the needle.

4. Clean the needle with a cloth dampened in solvent.
5. Install a replacement double-stacked O-ring set or spring-energized seal on the needle.

NOTE: Lubricate double-stacked O-rings before installing. Use the supplied fluorocarbon grease only if the assembly fluid being dispensed is compatible with it.

NOTE: If a spring-energized seal is used, install the seal with the spring facing the fluid flow.
6. Use one hand to position the fluid body on the air actuator / needle assembly and then slide the QR clasp into the grooves on the air cylinder body.

⚠ CAUTION

Do not over-tighten the QR clasp thumb screw. Doing so can break the screw.

7. Fully install the QR clasp as follows:
 - a. Partially thread the QR clasp thumbscrew into the air cylinder body.
 - b. When the thumbscrew is engaged, rotate the fluid body to the required alignment.
 - c. Finger-tighten the thumbscrew to fully secure fluid body to the air actuator.

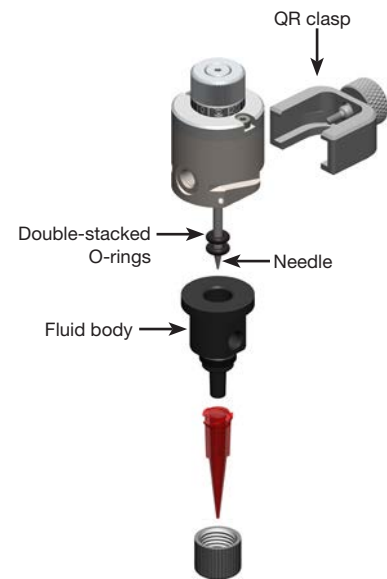

Cleaning a valve with double-stacked O-rings

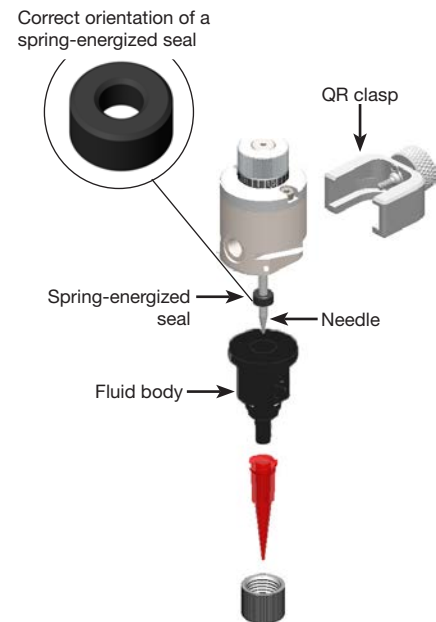

Cleaning a valve with a spring-energized seal

Service (continued)

⚠ CAUTION

Before any component change or service activity, relieve air pressure from the fluid reservoirs.

Replacing the Piston and Needle Assembly or the Piston O-Ring

Follow this procedure to clean the air cylinder body and replace the piston O-ring.

1. Make a note of the current stroke setting number.
2. Turn the stroke control knob counterclockwise to fully open.
3. Remove the cap.
4. Remove the piston return spring.
5. Using small pliers, grasp the spring pilot of the piston and needle assembly and then pull the assembly out of the air cylinder body.
NOTE: The piston and needle assembly is one unit and cannot be disassembled.
6. Remove the piston O-ring from the piston and needle assembly.
7. Clean the inside wall of the air cylinder body.
8. Lubricate the piston O-ring with Nye Lubricant #865 gel (P/N 7014917, included in the General Maintenance Kit) and reinstall the O-ring.
9. Reassemble the valve in the reverse order of disassembly, ensuring that the U-cup seal is in place.
10. Set the stroke reference ring to the desired stroke setting or go to "Valve Stroke Calibration" on page 14 to recalibrate the stroke control.

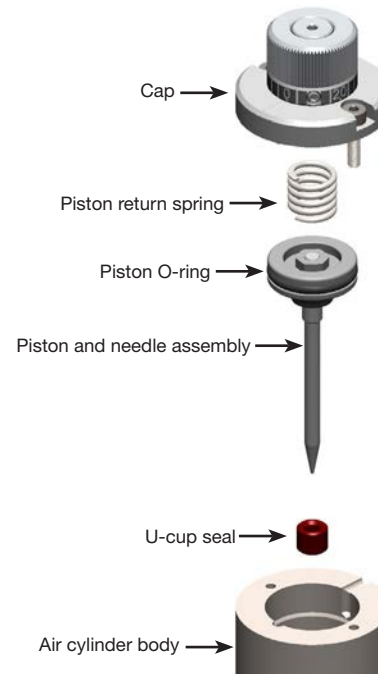

Service (continued)

CAUTION

Do not fully remove the mounting screw from the valve actuator housing. Be careful not to lose the BackPack mounting O-ring that is located between the BackPack and the xQR41V air cylinder body.

Replacing the Bullet Solenoid on the BackPack Valve Actuator

1. Loosen the housing / mounting bolt to release the BackPack valve actuator from the xQR41V valve air cylinder body.
2. Remove the spiral wrap (if used) around the BackPack valve actuator wires and air hose.
3. Disconnect the air line.
4. Unthread the cable connector from the bullet solenoid (cable not shown).
5. Engage the wrench flats on the bullet solenoid and rotate it counterclockwise. When the bullet solenoid is loose, pull up on the solenoid to release it.
6. Install a replacement bullet solenoid by rotating the solenoid clockwise until it is fully tightened.
7. Tighten the housing / mounting bolt and reconnect bullet solenoid cable connector and air line.

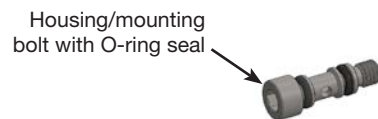
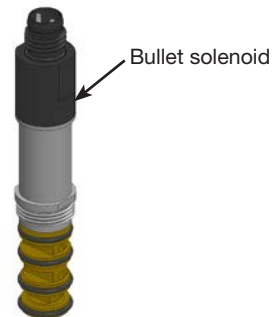

Part Numbers

| Part # | Description |
|---------|--|
| 7362489 | xQR41V valve with Backpack and stroke control knob |
| 7362488 | xQR41V valve with mounting block and stroke control knob |

Replacement Parts

Valve Components

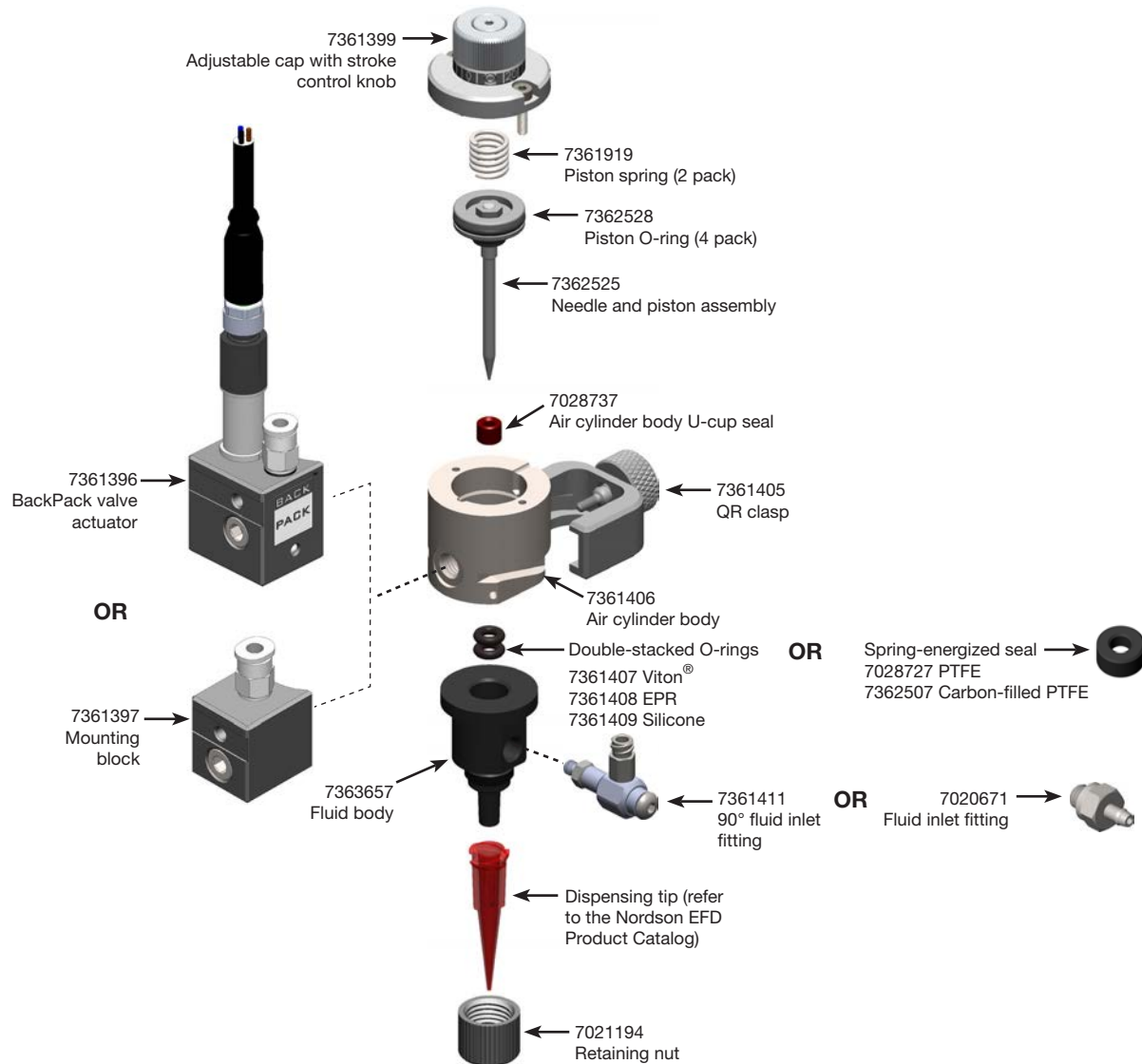

xQR41V valve replacement parts (valve with double-stacked O-rings shown)

Replacement Parts (continued)

Valve Components (continued)

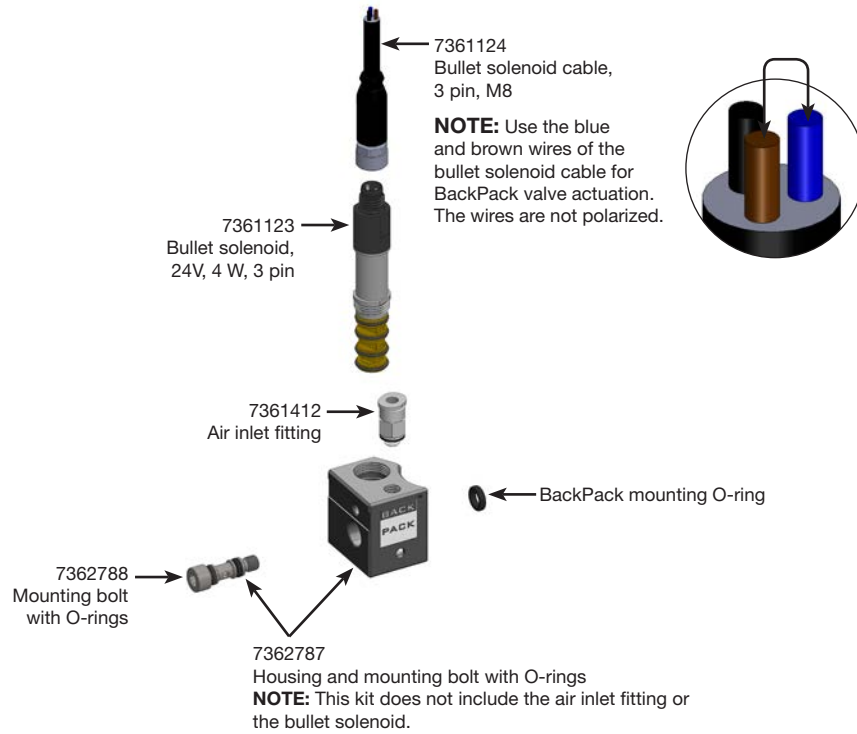

Replacement parts for the BackPack valve actuator

Accessories



Optional syringe barrel bracket support kit for the xQR41V valve

Troubleshooting

| Problem | Possible Cause | Corrective Action |
|------------------------------------|--|--|
| No fluid flow | Valve operating air pressure too low | Increase air pressure to 4.8 bar (70 psi) minimum. |
| | Reservoir air pressure too low | Increase the air pressure to the reservoir. |
| | Needle stroke adjusted to the closed position | Adjust the needle stroke. Refer to "Valve Stroke Calibration" on page 14. |
| | Clogged fluid body or output tip adapter | Clean the valve. Refer to "Cleaning the Valve" on page 15. |
| | Dispensing tip retaining nut not tightened enough to unseat the needle | Tighten the dispensing tip retaining nut. |
| Steady drip | Needle or fluid body damaged | Remove the tip adapter/seat assembly. Clean and inspect the needle and fluid body for damage. If either the needle or fluid body is damaged, replace both components. Replace the dispensing tip. |
| Fluid leaks from drain hole | Worn O-ring seals | Replace the double-stacked O-rings. Refer to "Cleaning the Valve" on page 15. |
| Inconsistent deposit size | Air pressure controlling the valve and/or supplying the reservoir fluctuating or valve operating pressure less than 4.8 bar (70 psi) | Make sure the air pressures are constant and the valve operating pressure is 4.8 bar (70 psi). |
| | Valve open time inconsistent | The time the valve is open must be constant. Make sure the valve controller is providing a consistent output. |
| | Air bubble in dispensing tip (causes drooling at the end of a dispense cycle) | Try any of the following solutions: <ul style="list-style-type: none"> • Purge the valve. • Prefill the tip. • If dispensing thin fluids, turn the valve upside down and then right side up. • Change to a different size or type of dispensing tip. |
| Stroke control knob rotates freely | Over-tightened stroke control knob damaged the internal stop assembly, or a stuck knob forced to turn | Replace the adjustable cap, which includes the stroke control assembly. |
| <i>Continued on next page</i> | | |

Troubleshooting (continued)

| Problem | Possible Cause | Corrective Action |
|---|--|--|
| Stroke control knob stuck | Knob over-tightened in either the open or closed direction | <p>Determine whether the knob is stuck in the fully open or fully closed position by actuating the valve.</p> <p>NOTE: When the valve is fully closed, the needle does not move when the valve is actuated. When the valve is fully open, the needle moves when the valve is actuated.</p> <ul style="list-style-type: none"> • If the valve does not actuate, the knob is stuck fully closed. Turn the knob counterclockwise to correct the problem. • If the valve actuates, the knob is stuck fully open. Turn the knob clockwise to correct the problem. <p>Once the knob is turning freely, recalibrate if needed. Refer to “Valve Stroke Calibration” on page 14.</p> |
| BackPack valve actuator not cycling | No air supply | Confirm that the main air supply is ON. |
| | Cable wires loose or damaged | Inspect the cable wires for loose connections or damage and tighten connections or repair damage. |
| | Bullet solenoid cable wires incorrectly connected | Ensure that the blue and brown cable wires are connected for BackPack valve actuation. The wires are not polarized. |
| | Failed bullet solenoid | Replace the bullet solenoid. Refer to “Replacing the Bullet Solenoid on the BackPack Valve Actuator” on page 17. |
| Air leaks from BackPack valve actuator housing | Loose housing | Tighten the housing. |
| | Damaged mounting bolt O-ring seals | Check the mounting bolt for damaged O-ring seals. Replace if needed. |
| | Damaged bullet solenoid O-rings | Check the bullet solenoid for damaged O-rings. Replace if needed. |
| BackPack actuator bullet solenoid not actuating | Bullet solenoid cable wires broken | Replace the bullet solenoid. Refer to “Replacing the Bullet Solenoid on the BackPack Valve Actuator” on page 17. |
| | Bullet solenoid cable wires incorrectly connected | Ensure that the blue and brown cable wires are connected for BackPack valve actuation. The wires are not polarized. |

NORDSON EFD ONE YEAR LIMITED WARRANTY

Nordson EFD products are warranted for one year from date of purchase to be free from defects in material and workmanship (but not against damage caused by misuse, abrasion, corrosion, negligence, accident, faulty installation or by dispensing material incompatible with equipment) when the equipment is installed and operated in accordance with factory recommendations and instructions. Nordson EFD will repair or replace free of charge any part of the equipment thus found to be defective, on authorized return of the part prepaid to our factory during the warranty period. In no event shall any liability or obligation of Nordson EFD arising from this warranty exceed the purchase price of the equipment. This warranty is valid only when oil-free, clean, dry, filtered air is used.

Nordson EFD makes no warranty of merchantability or fitness for a particular purpose. In no event shall Nordson EFD be liable for incidental or consequential damages.



For Nordson EFD sales and service in over 40 countries, contact Nordson EFD or go to www.nordsonefd.com.

Global

East Providence, RI USA
800-556-3484; +1-401-431-7000
info@nordsonefd.com

Europe

Dunstable, Bedfordshire, UK
0800 585733; +44 (0) 1582 666334
europe@nordsonefd.com

Asia

China: +86 (21) 3866 9006; china@nordsonefd.com
India: +91 80 4021 3600; india@nordsonefd.com
Japan: +81 03 5762 2760; japan@nordsonefd.com
Korea: +82-31-736-8321; korea@nordsonefd.com
SEAsia: +65 6796 9522; sin-mal@nordsonefd.com

Viton® is a registered trademark of E.I. DuPont.
The Wave Design is a trademark of Nordson Corporation.
©2018 Nordson Corporation 7362836 v040518