

Operating Instructions

OAKTON pH/ORP 220

pH/ORP Controller

OAKTON Instruments

PO Box 5136, Vernon Hills, Illinois 60061

Toll-free: 1-888-462-5866

Fax: 1-847-247-2984

www.4oakton.com

CONTENTS

GENERAL INTRODUCTION	3
INITIAL INSPECTION	3
USING THE pH/ORP 220	4
a. Mounting procedure	4
b. Front panel	6
c. LCD screen	9
d. Rear connectors	12
e. Measure mode	14
f. Setting mode	16
g. pH calibration mode	23

h. RmV calibration mode.....	26
i. Controlling the relays.....	27
j. 4~20mA output.....	29
ERROR DISPLAY AND TROUBLESHOOTING	32
pH BUFFERS.....	37
SPECIFICATIONS.....	39
WARRANTY.....	42

GENERAL INTRODUCTION

Thank you for selecting the Oakton pH/ORP 220. The pH/ORP Controller is a rugged microprocessor based instrument assembled in a watertight 1/8 DIN case, designed for use in laboratories and process control applications.

The system displays pH or ORP or Temperature and relay status in one large LCD screen.

The pH/ORP 220 is equipped with 2 control relays and an isolated 4-20mA analog output. All control relays are programmable and hysteresis driven.

INITIAL INSPECTION

Carefully unpack the unit and accessories. Inspect for damages made in shipment. If any damage is found, notify your **Oakton** representative immediately. All packing materials should be saved until satisfactory operation is confirmed.

USING THE pH/ORP 220

a. Mounting Procedure

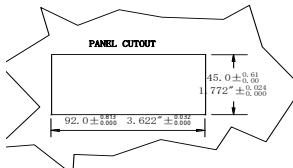

DRAWING 1

- Make a cutout on any panel, with a thickness of 1/16 inch (1.5mm) to 3/8 inch (9.5mm). Refer to DRAWING 1.

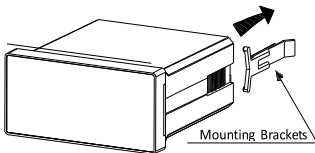

DRAWING2

- Remove the mounting assembly from the controller and insert the controller into the cutout. Refer to DRAWING 2.

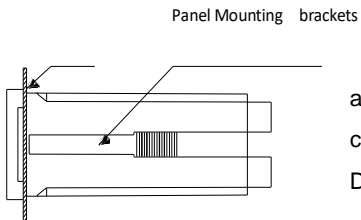

- Replace the mounting bracket assembly onto the controller and secure the controller to the mounting panel. Refer to DRAWING 3.

DRAWING3

[Note] :

If the equipment is used in a manner not specified by the manufacturer, the protection provided by the equipment may be impaired.

USING THE pH/ORP 220

b. Front Panel

The front panel consists of a 4-digit LCD display and 4 keys.

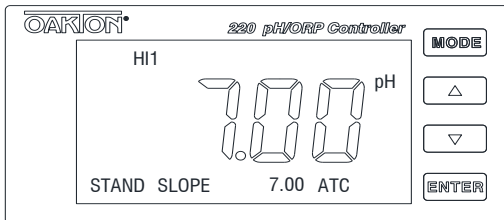

- [**MODE**] key:

1a. In **Measure mode**, pressing and releasing the [**MODE**] key will show in sequence the 4 measure mode displays: pH, Temperature, ORP absolute mV, ORP relative mV.

1b. In **Calibration or Setting mode**, pressing the **[MODE]** key will move back to **Measure mode**.

- **[UP]** key:

2a. In **RmV Calibration mode**, pressing the **[UP]** key will increment the shown value.

2b. In the **Setting mode**, pressing the **[UP]** key will show the next option or increment the shown value.

2c. In the **Measure mode**, pressing the **[UP]** key and **[ENTER]** key at the same time will enter **Calibration mode**.

2e. In **Temperature Measure mode**, if the **Temperature Compensation select** is in **MANUAL** mode, pressing the **[UP]** key will increment the shown value.

- **[DOWN]** key:

3a. In **RmV Calibration mode**, pressing the **[DOWN]** key will decrement the shown value.

3b. In the **Setting mode**, pressing the **[DOWN]** key will show the previous option or decrement the shown value.

3c. In the **Measure mode**, pressing the **[DOWN]** key and **[ENTER]** key at the same time will enter **Setting mode**.

3e. In **Temperature Measure mode**, if the **Temperature Compensation select** is in **MANUAL** mode, pressing the **[DOWN]** key will increment the shown value.

- **[ENTER]** key:

4a. In **Calibration mode**, pressing the **[ENTER]** key will continue the calibration

process.

4b. In **Setting mode**, pressing the [ENTER] key will save the new settings. If no change has been made then pressing this key will just skip the saving and move to the next setting.

c. **LCD Screen**

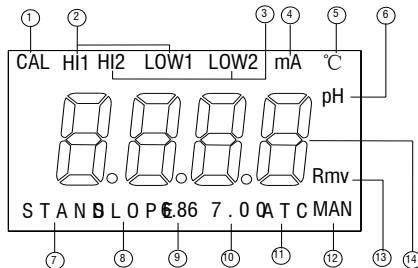

1. **CAL** – This icon will be displayed if the meter is in **Calibration or Setting mode**.
2. **HI1 & LOW1** – These icons, when displayed, indicate relay action and relay number.
3. **HI2 & LOW2** –These icons, when displayed, indicate relay action and relay number.
4. **mA** – This icon will indicate that the unit is in **4mA or 20mA Setting mode**
5. **°C** – Temperature unit display.
6. **pH** – Unit indicator.
7. **STAND** – This icon will blink after switching-over to pH Calibration mode and also indicates the start of Buffer 1 calibration. The icon will stop blinking and stay on while Buffer 1 is being calibrated.
8. **SLOPE** – This icon will blink to indicate the start of Buffer 2 calibration. The icon will

stop blinking and stay on while Buffer 2 is being calibrated.

9. **6.86** – The 6.86 buffer group: 6.86, 4.00, 9.18.
10. **7.00** – The 7.00 buffer group: 7.00, 4.01, 10.01.
11. **ATC** – This icon will be displayed when any ATC probe is selected as the temperature source in the **Setting Mode**.
12. **MAN** – This icon will be displayed when manual temperature is selected as the temperature source in the **Setting Mode**.
13. **RmV – Relative ORP mV** unit indicator.
14. The 7-segment display.

d. Rear Connectors

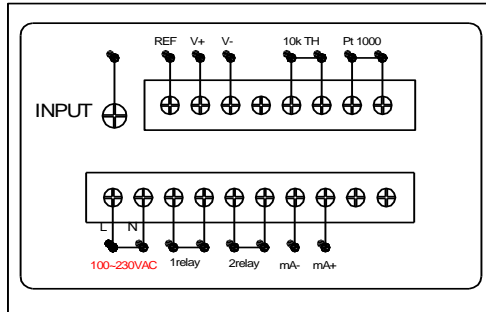

- The pH/ORP 220 can accept between 100 and 240 VAC at 50/60 Hz. Make sure to connect the AC power cord to the correct AC terminals.

- Connect the proper load to the output relays. Make sure that the load does not exceed the relay rating of 5 Amp at 115 VAC and 2.5 Amp at 230 VAC.
- The **V+**(+3.3VDC) and **V-** (-3.3VDC) outputs are provided as source of excitation voltage for the pH/ORP pre-amplifier only.

[Note] : Make sure that the power is unplugged before wiring your probes, relay etc. Connecting incorrectly may damage the unit permanently.

e. **Measure Mode**

Turning on the unit will always display in **Measure mode**. This instrument is designed to provide 4 distinct measurements: Press and release the [MODE] key to display each of the measurements. See figure below.

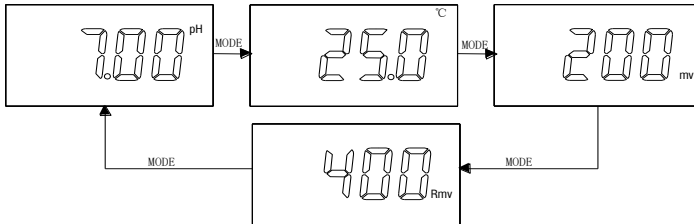

- **pH** – The degree of acidity or alkalinity of the solution.
- **Temperature** – Current temperature of the solution.
- **ORP mV** – A measurement of absolute ORP mV.
- **ORP RmV**– A measurement of relative ORP mV. The offset value at the RmV calibration will be added to the ORP absolute value to display the ORP relative value.

f. Setting Mode

Pressing **[DOWN]** key and **[ENTER]** key at the same time will enter the **Setting mode**.

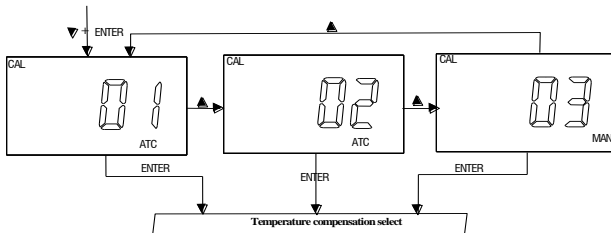

Pressing **[UP]** key or **[DOWN]** key will cycle the display from 01 (Thermistor: 10k ohm), 02 (Resistor: PT1000)、03 (Manual) modes as shown above.

Select the preferred temperature compensation mode, press **[ENTER]** key to save and move to the next setting screen.

- **pH buffer 1 select:**

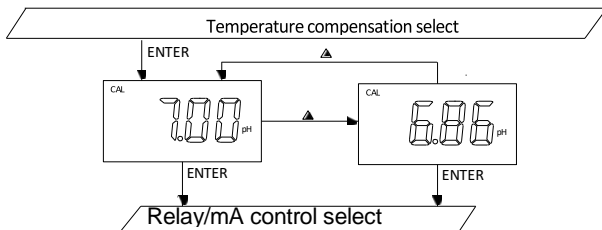

Pressing **[UP]** key or **[DOWN]** key will cycle the display from 7.00 and 6.86 buffer as shown.

Select your preferred buffer group, press **[ENTER]** key to save, and move to the next setting screen.

- **Relay/mA control select:**

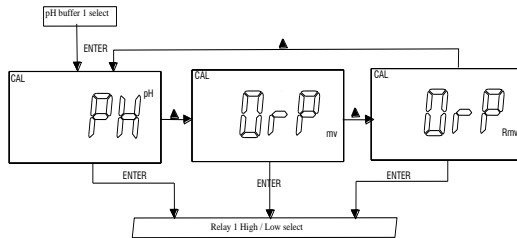

Pressing **[UP]** key or **[DOWN]** key in this screen will cycle the display from pH, ORP mV, ORP RmV modes shown above.

Select the preferred mode, press **[ENTER]** key to save, and move to the next setting screen.

[Note] : The relay and mA output will only be affected by the chosen option.

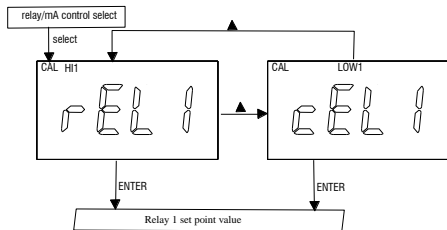

- **Relay 1 High / Low select:**

Pressing **[UP]** key or **[DOWN]** key in this screen will cycle the display from “**HI1**” and “**LOW2**” modes. Select the preferred mode, press **[ENTER]** key to save, and move to the next setting screen.

[Note] : See “**i. Controlling the relays**” page.

- **Relay 1 set point value:**

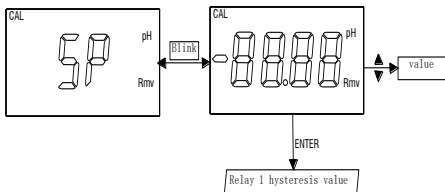

“**SP**” and the value of the option will blink alternately to indicate that this is the set point option, once you press the **[UP]** or **[DOWN]** keys to adjust, only the value will blink so as not to distract the user with the alternating “**SP**”

screen while changing the value. Press the **ENTER** key to save or skip, and move to the next setting screen.

- **Relay 1 hysteresis value:**

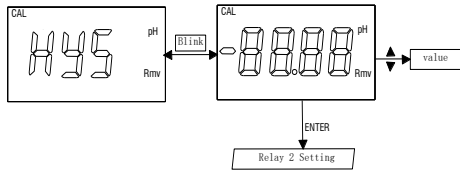

“HYS” and the value of the option will blink alternately to indicate that this is the hysteresis option, once you press the [UP] or [DOWN] keys to adjust, only

the value will blink so as not to distract the user with the alternating “HYS” screen while changing the value. Press the **ENTER** key to save or skip, and move to the next setting screen.

- **Relay 2 High / Low select:**

See instructions for **Relay 1 High/Low select**.

- **Relay 2 set point value:**

See instructions for **Relay 1 set point value**.

- **Relay 2 hysteresis value:**

See instructions for **Relay 1 hysteresis value**.

- **4 mA output setting:**

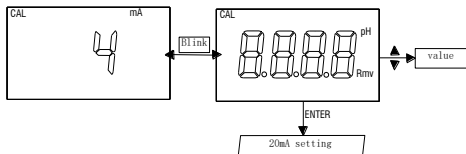

“4” and the value of the option will blink alternately to indicate that this is the 4 mA option, once you press the [UP] or [DOWN] keys to adjust, only

the value will blink so as not to distract the user with the alternating “4” screen while adjusting the value. Press the **ENTER** key to save or skip, and move to the next setting screen.

- **20 mA output setting:**

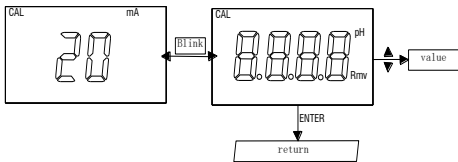

“20” and the value of the option will blink alternately to indicate that this is the 20 mA option, once you press the **[UP]** or **[DOWN]** keys to adjust, only the value will blink so as not to distract the user

with the alternating “20” screen while adjusting the value. Press the **ENTER** key to save or skip, and return to **Measure mode**.

g. **pH Calibration Mode**

The pH/ORP 400 uses a 2-point calibration for pH. The first point must be 6.86 (if using 6.86 buffer group)/ 7.00(if using 7.00 buffer group), and the second point can either be 4.00 or 9.86 (if 6.86 buffer group) or 4.01 or 10.01 (if using 7.00 buffer group).

In the **pH Measure mode**, pressing **[UP]** key and **[ENTER]** key at the same time will

enter pH **Calibration mode**.

- **Buffer 1 (STAND) calibration:**

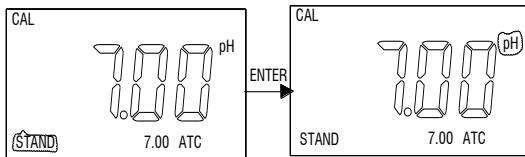

After entering **pH Calibration mode**, the “**STAND**” icon will blink indicating the probe is ready to be standardized at the first buffer. Rinse the pH and ATC/Temp probes in distilled water and immerse them in the first buffer solution (either 7.00 or 6.86). Allow temperature reading to stabilize, then press **[ENTER]** key to calibrate. The “**pH**” icon will blink until the unit detects a stable reading. Once the unit calibrates the first point, the

“**SLOPE**” icon will blink to indicate the unit is ready to calibrate the 2nd buffer.

- **Buffer 2 (SLOPE) calibration:**

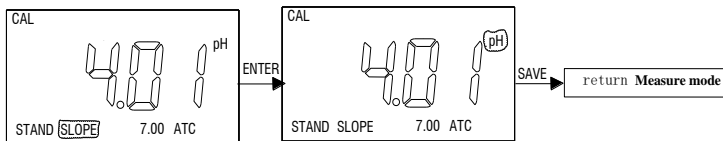

Rinse the pH and ATC/Temp probe in distilled water and immerse them in the second buffer solution (either 4.00/9.18 or 4.01/10.01). During the second point calibration the unit can automatically detect the corresponding pH buffer solution (4.00 or 9.18 if 6.86 buffer group) or (4.01 or 10.01 if 7.00 buffer group). Allow the temperature reading to stabilize, then press “**ENTER**” key to calibrate. The “**pH**” icon will blink until the unit detects a stable reading. Once the unit calibrates the second point the unit will automatically exit the **Calibration mode** and goes back to pH **Measure mode**. The

2- point pH calibration is complete.

[Note]:

If the user is calibrating pH without a temperature probe, first go to **Setting mode** (1. Temperature compensation select), select **03** (Manual temperature compensation mode) and save. Go to **Measure mode – Temperature display** and use the **UP** and **DOWN** keys to adjust the value to the approximate temperature value of the buffer solutions before starting the pH Calibration.

h. RmV Calibration Mode

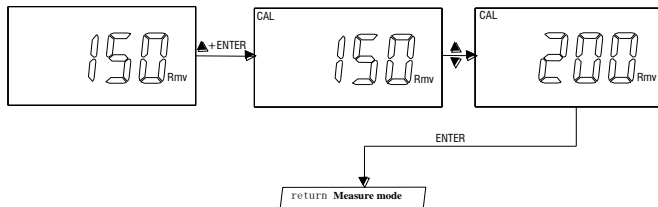

The pH/ORP 220 uses 1-point calibration for RmV. In the **RmV Measure mode**, pressing **[UP]** key and **[ENTER]** key at the same time will enter RmV Calibration mode.

Rinse the ORP probe in distilled water and immerse it in the ORP standard solution, then press **[UP]** or **[DOWN]** key and adjust the ORP value to the ORP standard solution value. Press the **[ENTER]** key to save. The unit beeps to indicate a successful calibration. Calibration is now complete and the unit will automatically switch back to **Measure mode in ORP relative mV**.

i. **Controlling the Relays**

- **Isolation voltage:**

The maximum isolation voltage of the relay output contacts is 1500 VDC. The voltage differential between the relay output contacts and the load should not exceed 1500 VDC.

- **Output load:**

The current through the relay output contacts should not exceed 5 Amp at 115 VAC and 2.5 Amp at 230 VAC in order not to cause permanent damage to the relay contacts. This rating is specified for resistive loads only.

- **Relay action, relay set point and hysteresis value:**

Relay Action	Effective RELAY-ON Set Point	Effective RELAY-OFF Set Point
HI	S.P. + (1/2 H.V)	S.P. – (1/2 H.V)
LOW	S.P. – (1/2 H.V)	S.P. + (1/2 H.V.)

S.P. = Relay Set point H.V. = Hysteresis value (Dead Band)

If the relay action is set to **HIGH**, the relay will turn **ON** at (Set Point +1/2 Hysteresis), and will turn **OFF** at (Set Point -1/2 Hysteresis).

If the relay action is set to **LOW**, the relay will turn **ON** at (Set Point -1/2 Hysteresis), and will turn **OFF** at (Set Point +1/2 Hysteresis).

There are two Independent relays the user can bind to the **pH, ABSOLUTE mV** or **RELATIVE mV mode (Temperature not included)**. The user can only bind the two relays to one of three measure modes at a time. The user can change this anytime by changing **Relay control parameters select** at the **Setting mode**.

j. **4-20 mA output**

- **Isolation voltage:**

The maximum isolation voltage of the 4-20mA output contacts is 500 VDC. The voltage differential between the 4-20mA output contacts and the load should not exceed 500 VDC.

- **Output load:**

The maximum load is 500 ohm. Output current inaccuracies may occur for load impedance in excess of 500 ohm.

The analog output will produce a linear analog output. The user can only bind the **ANALOG OUTPUT** to one reading at a time. The user can change this anytime by changing option at the **Calibration/Setting mode** screen.

The analog output will be restricted on the 4 mA setting, 20 mA setting and the current bound display.

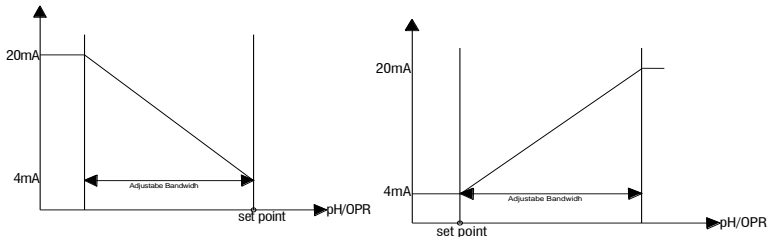

Decreasing current for increasing pH or ORP

Increasing current for increasing pH or ORP

The above figure shows the relationship between Reading, U_{4mA} & U_{20mA} . The analog output is based on the following equation:

$$mA(\text{output}) = 4mA + (16mA) * (D - U_{4mA}) / (U_{20mA} - U_{4mA})$$

Where:

$mA(\text{output})$ = analog output

D = current bound display

U_{4mA} = user setting for 4 mA for current bound display

U_{20mA} = user setting for 20 mA for current bound display

[Note] :

- The set point range for pH is -2.00 to 16.00 pH.
- The set point range for absolute mV is -1999 to 1999 mV.
- The set point range of for relative mV is -2999 to 2999 mV.

ERROR DISPLAY AND TROUBLESHOOTING

pH/ORP Display	Temperature Display	Display Mode	Possible cause(s)	[Action(s)]
"OvEr"	-10.0~120.0°C	pH measure mode	pH > 16.00pH [Recalibrate]	
"undr"	-10.0~120.0°C	pH measure mode	pH < -2.00pH [Recalibrate]	

"OvEr"	"OvEr"	pH measure mode	<p>a. Temperature > 120.0°C.</p> <p>[Bring buffer solution to lower temperature.]</p> <p>[Replace temperature probe.]</p> <p>b. No temperature sensor.</p> <p>[Adjust the manual temperature to -10~120°C.]</p>
--------	--------	-----------------	--

"OvEr"	"undr"	pH measure mode	<p>a. Temperature < -10.0°C. [Bring buffer solution to higher temperature.] [Replace temperature probe.]</p> <p>b. No temperature sensor. [Adjust the manual temperature to -10~120°C.]</p>
"OvEr"	Temperature reading	Absolute ORP mV or relative ORP	Absolute ORP mV > +1999 mV [Bring solution to a lower ORP reading]
"undr"	Temperature reading	Absolute ORP mV or relative ORP	Absolute ORP mV < -1999 mV [Bring solution to a higher ORP reading]

<p>ORP reading</p>	<p>"OvEr"</p>	<p>Absolute ORP mV or relative ORP</p>	<p>a. Temperature > 120.0°C. [Bring buffer solution to lower temperature.] [Replace temperature probe.]</p> <p>b. No temperature sensor. [Adjust the manual temperature to -10~120°C.]</p>
<p>ORP reading</p>	<p>"undr"</p>	<p>Absolute ORP mV or relative ORP</p>	<p>a. Temperature < -10.0°C. [Bring buffer solution to higher temperature.] [Replace temperature probe.]</p> <p>b. No temperature sensor. [Adjust the manual temperature to -10~120°C.]</p>

"OvEr"	0~60°C	<p>A. pH calibration mode, buffer 1 calibration (7.00 buffer group)</p> <p>B. pH calibration mode, buffer 1 calibration (6.86 buffer group)</p> <p>C. pH calibration mode, buffer 2 calibration</p>	<p>A. Offset < -100 or > 100 mV</p> <p>B. Offset < -91.7 or > 108.3 mV</p> <p>C. Slope > ideal slope by 30% or slope < ideal slope by 30%</p> <p>[Use a new buffer solution.]</p> <p>[Replace electrode.]</p>
--------	--------	--	--

pH BUFFERS

The temperature characteristics of pH calibration buffers pH4.00, pH4.01, pH6.86, pH7.00, pH9.18 & pH10.01 are stored inside the instrument. The buffers used to calibrate the instrument must exhibit the same temperature characteristics as the stored values.

°C	4.00	6.86	9.18	4.01	7.00	10.01
0	4.01	6.98	9.46	4.01	7.11	10.32
5	4.00	6.95	9.39	4.01	7.08	10.25
10	4.00	6.92	9.33	4.00	7.06	10.18
15	4.00	6.90	9.28	4.00	7.03	10.12
20	4.00	6.88	9.23	4.00	7.01	10.06
25	4.00	6.86	9.18	4.01	7.00	10.01
30	4.01	6.85	9.14	4.01	6.98	9.97
35	4.02	6.84	9.10	4.02	6.98	9.93

40	4.03	6.84	9.07	4.03	6.97	9.89
45	4.04	6.83	9.04	4.04	6.97	9.86
50	4.06	6.83	9.02	4.06	6.97	9.83
55	4.07	6.83	8.99	4.08	6.97	9.80
60	4.09	6.84	8.97	4.10	6.98	9.78

[Note] : The actual reading of the instrument can differ from the values shown by ± 0.01 pH.

SPECIFICATIONS

Mode	Range	Resolution	Accuracy
pH	-2.00 to 16.00 pH	0.01 pH	$\pm 0.1\% \pm 1$ digit
ORP Absolute mV	-1999 to 1999 mV	1 mV	$\pm 0.1\% \pm 1$ digit
ORP Relative mV	-2999 to 2999 mV	1 mV	$\pm 0.1\% \pm 1$ digit
Temperature	-10.0 to 120.0 °C	0.1 °C	± 0.3 °C

pH:

Recognized pH buffers

US (4.01, 7.00, 10.00) or
NIST (4.00, 6.86, 9.18)

pH Temperature compensation

Manual/Auto -10.0°C to 120.0 °C pH

Buffer Temperature range

0.0°C to 60.0 °C

pH Electrode Offset recognition

± 100 mV at pH 7.00
 $+108.3$ mV/ -91.7 mV at pH 6.86

pH Electrode Slope recognition $\pm 30\%$ at pH 4.00, 4.01, 9.18, 10.01

Input impedance $>10^{12}$

Calibration end point sensing Yes

Temperature:

Temperature sensor (User selectable) Thermistor(10k ohm at 25 °C),
Resistor (PT1000) or Manual

Controller:

Control type Two ON/OFF control

Relay output (Resistive load only) 5 A at 115 VAC or 2.5 A at 220 VAC

4-20 mA Output:

Output range 4 to 20 mA (isolated)

Output scale user programmable

Maximum load 500 ohm

Accuracy ± 0.03 mA

Isolation voltage 500 VDC

General:

Keys Audio feedback in all keys

Power: 100 VAC to 240 VAC , 50/60Hz

Ambient Temperature range 0.0 to 50.0 °C

Case IP65, 1/8DIN case, depth 90mm

Weight 290 g

WARRANTY

The Oakton Instruments warrants this product to be free from significant deviations in material and workmanship for a period of one year. If repair or adjustment is necessary and has not been the result of abuse or misuse, within the twelve month period, please return, freight-prepaid, and correction will be made without charge (see note on return of items). Oakton Instruments alone will determine if the product problem is due to deviations or customer misuse.

Out of warranty products will be repaired for a nominal charge.

RETURN OF ITEMS

Authorization must be obtained from our Customer Service Department before returning items for any reason. When applying for authorization, please include data regarding the reason the items are to be returned. A restocking charge will be made on all unauthorized returns.

For your protection, items being returned must be carefully packed to prevent damage in shipment and insured against possible damage or loss. Oakton Instruments will not be responsible for damage resulting from careless or insufficient packing.

【Note】 : Oakton Instruments reserves the right to make improvements in design, construction and appearance of our products without notice.

We stand behind our products. For additional information on our products, warranty, or returns please contact our office or visit our website listed on front page.

