

# Instruction Manual

## DO 700 Dissolved Oxygen/°C/°F Bench Meter



**OAKTON®**

**EUTECH  
INSTRUMENTS**

*Technology Made Easy...*

**ISO 9001**  
CERTIFIED





# TABLE OF CONTENTS

<b>1. INTRODUCTION</b> .....	<b>1</b>
<b>2. GETTING STARTED</b> .....	<b>2</b>
2.1 Keypad Functions .....	2
2.2 LCD Annunciators .....	3
2.3 Meter Connections .....	3
<b>3. DISSOLVED OXYGEN / ATC ELECTRODE</b> .....	<b>4</b>
<b>4. CALIBRATION</b> .....	<b>5</b>
4.1 Temperature Calibration .....	6
4.2 % Saturation Calibration .....	7
4.3 100% Calibration .....	7
4.4 0% Calibration .....	7
4.5 mg/L or ppm (Concentration) Calibration .....	8
<b>5. SETUP FUNCTIONS</b> .....	<b>10</b>
5.1 1.0 CAL (Calibration).....	10
5.2 2.0 ELE (Electrode Information).....	10
5.3 3.0 ConF (Configuration).....	11
5.4 3.1 rdY (Ready Stability Indicator / Auto Hold).....	11
5.5 3.2 °C °F (Celsius or Fahrenheit) .....	11
5.6 3.3 dPr (Barometric Pressure Adjustment).....	11
5.7 3.4 SAlT (Salinity Adjustment) .....	12
5.8 3.5 OFS (Offset Adjustment) from % mode.....	12
5.9 3.5 Unit (Unit Adjustment) from concentration mode.....	12
5.10 4.0 rSt (Reset).....	13
5.11 5.0 CLr (Clear Stored Memory) .....	13
<b>6. TAKING MEASUREMENTS</b> .....	<b>14</b>
6.1 HOLD Function .....	15
6.2 Storing and Recalling Data .....	15
<b>7. ELECTRODE MAINTENANCE</b> .....	<b>16</b>
<b>8. DISSOLVED OXYGEN THEORY</b> .....	<b>19</b>

<b>9. REPLACEMENTS AND ACCESSORIES.....</b>	<b>23</b>
<b>10. TROUBLESHOOTING GUIDE.....</b>	<b>24</b>
<b>11. SPECIFICATIONS.....</b>	<b>26</b>
<b>12. WARRANTY.....</b>	<b>27</b>
<b>13. RETURN OF ITEMS.....</b>	<b>28</b>



## **1. INTRODUCTION**

Thank you for purchasing our DO 700 series benchtop meter. This microprocessor-based meter is economical and simple to use. The design incorporates a large LCD for clear viewing, yet offers a small footprint to conserve space.







The DO 700 measures Dissolved Oxygen in % saturation or concentration (mg/L or ppm) with temperature (°C or °F).

Each meter includes a convenient slide-out card for quick reference. Also included is an electrode arm and metal bracket which can be easily attached to the left or right side of the meter according to your preference.

**We take great pride in every instrument we manufacture and hope this one serves you well.**

## 2. GETTING STARTED

### 2.1 Keypad Functions

	Powers the meter on and off. Upon power on, the meter automatically begins in the mode that was last used. Calibration and memory values are retained even if meter is unplugged.
	Toggle between available measurement modes—% saturation or concentration (mg/L or ppm). Also used to switch to Temperature calibration during DO calibration modes.  <b>Press and hold for 5 seconds to enter SETUP mode.</b>
	Toggles between measurement and calibration modes. In SETUP mode, returns user to the measurement mode.
	Confirms calibration values in CAL mode. Confirms selections in SETUP mode. View recalled values in memory mode.
	▲ Increase value. Scroll up in SETUP & CAL modes. <b>MI</b> (Memory Insert) stores values into memory.
	<b>MR</b> (Memory Recall) recalls values from memory. ▼ Decrease value. Scroll down in SETUP & CAL modes.
	Freezes measured reading. Press again to resume live reading.



## 2.2 LCD Annunciators

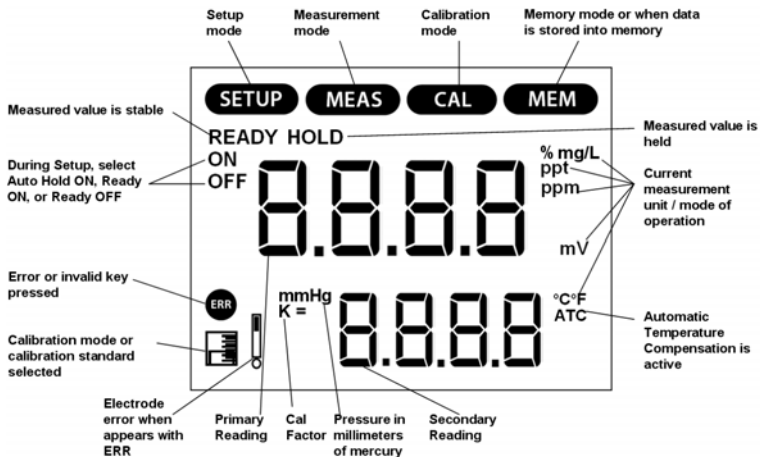

## 2.3 Meter Connections

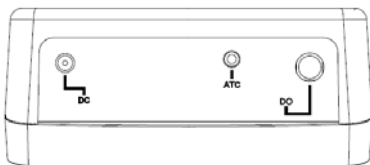

<b>DC</b>	Power supply
<b>ATC</b>	Temperature connection of Dissolved Oxygen electrode
<b>DO</b>	BNC connection of Dissolved Oxygen electrode

### 3. DISSOLVED OXYGEN / ATC ELECTRODE

The DO 700 includes a galvanic DO electrode with built in temperature measurement.

The electrode has a dual cable; a BNC connector for DO measurement and a mini-phono plug for temperature. The electrode is pre-filled with electrolyte that is separated from the sample by an oxygen permeable membrane. The membrane is pre-assembled for you and fixed to a detachable cap. The pre-assembled cap design allows simple replacement and fast conditioning.

The electrode is light-weight with a 12-mm body diameter and a 16-mm tip diameter from at the detachable Noryl cap. The compact sensing area reduces air entrapment resulting in quick, accurate, and stable readings.

Provide simple stirring for best results—ideally achieve a minimum water flow rate of 2 inch/second on the membrane.

The probe is not recommended for samples beyond 0 to 50 °C.

The membrane is thin and can be replaced if damaged. Use care to protect from scratches, abrasion, or contact with solids. For best results keep membrane clean by rinsing after daily use. See [Section 7 – Electrode Maintenance](#).



## 4. CALIBRATION

The DO 700 has three measurement modes; DO as % saturation, DO as mg/L (or ppm) concentration, and temperature.

Dissolved oxygen levels vary with temperature, barometric pressure, and salinity, so calibration must be performed with consideration of these factors. ***It is necessary to set the proper temperature, barometric pressure and salinity values prior to performing any DO calibration or measurement.***

See [Section 4.1 — Temperature Calibration](#).

See [Section 5.6 — Barometric Pressure Adjustment](#).

See [Section 5.7 — Salinity Adjustment](#).

The DO 700 will accept two % saturation calibration points; 100% using saturated air or air-saturated water, and 0% using zero oxygen solution. When 100% or 0% calibration is performed, the concentration value is adjusted accordingly. Therefore, it is not necessary to calibrate the concentration mode. If calibrating for 0% oxygen, note that the meter will take several minutes to reach 0% saturation value and constant stirring is not required.

The following table lists calibration values in % saturation calibration mode with two different barometric pressures. Note that the saturation value (92.1%) has decreased due to the lower barometric pressure entered.

% Saturation (of factory default value)	Calibration Value (760mmHg)	Calibration Value (700mmHg)
less than 10%	0%	0%
10.1% to 49.9%	CAL ERR	CAL ERR
50% to 150%	100%	92.1%

If calibration is attempted from 10.1% to 49.9%, CAL Err message is shown—calibration is rejected and the display will return to calibration mode.

The DO 700 will accept one calibration point in concentration mode. The minimum value is 2 mg/L (ppm), and the calibration window is +/- 40% of the factory default value.

Temperature and % saturation calibration should take place **before** attempting to perform mg/L (ppm) concentration calibration.

Calibration of the concentration mode will only replace the previous concentration calibration and does not affect the % saturation calibration.







To offset your % saturation reading to match another instrument, see [Section 5.8 – Offset Adjustment](#).

Perform daily calibration for best results. New calibration values will automatically override the existing data. To completely recalibrate the meter and when installing a replacement electrode, it is best to clear all calibration data. See [Section 5.10 – Reset](#).

#### 4.1 Temperature Calibration

For best DO accuracy, ensure that the temperature is accurate. The thermistor sensor used for automatic temperature compensation and measurement is accurate and stable, so frequent calibration isn't required. Temperature calibration is recommended upon probe replacement, whenever the temperature reading is suspect, or if matching against a certified thermometer is desired.

The DO 700 will default to 25 °C / 77 °F when the ATC plug is not connected.





- 1) Place the probe into a solution with a known accurate temperature such as a constant temperature bath.
- 2) Press  followed by . The primary display shows the measured temperature while the secondary display shows the factory default temperature.
- 4) Adjust the temperature using  or . Press  to accept or  to cancel. The meter allows an adjustable maximum value of  $\pm 5^{\circ}\text{C}$  (or  $\pm 9^{\circ}\text{F}$ ) from the factory default temperature.

## 4.2 % Saturation Calibration

The DO700 can be easily calibrated in air. For best accuracy, ensure that the barometric pressure value is accurate.



The barometric pressure factory default is 760 mm Hg (1.013 bar), which results in a theoretical calibration value of 100% saturation in air. If the barometric pressure setting has been changed from 760 mm Hg, the meter will automatically adjust to a new % saturation calibration value instead of 100%. This new value is correct for the adjusted barometric pressure.

## 4.3 100% Calibration

- 1) Rinse the probe well with clean water (do not dry).
- 2) Press  to select % saturation.
- 3) Hold the probe in the air with the tip facing downwards. Wait for the reading to stabilize.
- 4) Press . The CAL indicator will blink and secondary display will indicate the calibration point, 100.0.
- 5) Press  to confirm the calibration. The primary display will blink briefly before calibrating to 100.0%.
- 6) Press  to return to measurement mode, or continue with 0% calibration if desired.

## 4.4 0% Calibration





- 1) Rinse the probe well with clean water (do not dry).
- 2) Press  to select % saturation.
- 3) Submerge probe in zero oxygen calibration solution and stir slowly. **Wait for the reading to stabilize—this can often take more than 10 minutes!**

- 4) Press . The CAL indicator will blink and the secondary display will indicate the calibration point, 0.0.
- 5) Press  to confirm the calibration. The primary display will blink briefly before calibrating to 0.0%.
- 6) Press  to return to measurement mode, or continue with 100% calibration if desired (note 0% calibration followed by 100% calibration is not recommended---always perform 100% calibration first).

#### **4.5 mg/L or ppm (Concentration) Calibration**

Performing a saturation calibration at 100% or 0% will simultaneously calibrate the corresponding mg/L (ppm) concentration value. Therefore, additional mg/L (ppm) calibration isn't required in most circumstances.

If desired, you can perform a calibration adjustment in mg/L (ppm) without affecting your % saturation calibration value.



- 1) Rinse the probe well with clean water (do not dry).
- 2) Press  to select concentration mg/L (ppm).
- 3) Dip the probe into a sample of known oxygen concentration (i.e. determined by titration or another instrument). Wait for the reading to stabilize.
- 4) Press . The CAL indicator and current concentration display briefly, before CAL flashes. The concentration value based on the factory default calibration is shown.
- 5) Press  or  to adjust the reading to match the known oxygen concentration value.
- 6) Press  to confirm the calibration. The primary display will blink briefly before returning to measurement mode.



**NOTE:** The minimum calibration value is 2 mg/L. In addition, the calibration is limited to  $\pm 40\%$  adjustment of the factory default value to prevent erroneous calibrations.

## 5. SETUP FUNCTIONS

Use the setup feature to customize your instrument operation.

There are two setup menus; one menu is derived from the % saturation mode and the other from the mg/L (or ppm) concentration mode.

First, select the appropriate measurement mode you wish to adjust by pressing  until the desired units are displayed. During measurement, press and hold  for 5 seconds to enter SETUP mode of the parameter being measured.

Press  or  to change programs or change options.

Press  to select the program or confirm selection.

Press  to go back one level or return to measurement mode.

### 5.1 1.0 CAL (Calibration)

Press  to view stored calibration points.

**Note:** % saturation mode will list two points, while concentration mode has only one point.

### 5.2 2.0 ELE (Electrode Information)

Press  to view calibration factor (CAL.F)

**TIP:** The factor is an indication of the probe's efficiency. It is the ratio of the actual mV produced by the probe to the theoretical mV value. The ratio displays from 0.5 to 1.999.

Press  to view mV output for 100% (HI).

Press  to view mV output for 0% (LO).



Press  to view Offset % (OFS)—% saturation mode only.

### 5.3 3.0 ConF (Configuration)

Press  to access set-up programs 3.1 thru 3.5.

### 5.4 3.1 rdY (Ready Stability Indicator / Auto Hold)

Press  .

Press  or  to choose READY “On”, READY “OFF”, or Auto HOLD.

Press  to confirm.

### 5.5 3.2 °C °F (Celsius or Fahrenheit)

Press  .

Press  or  to select °C or °F.



Press  to confirm.

### 5.6 3.3 dPr (Barometric Pressure Adjustment)

Press  .

Press  or  to select units; **Hg** (mm Mercury) or **bAr**.



Press  to confirm.

Press  or  to adjust the value, press  to accept.

### 5.7 3.4 SALt (Salinity Adjustment)

For best accuracy, enter the actual salinity value if your samples are at least 0.1 ppt (100 ppm). Maximum adjustment is 50 ppt (50,000 ppm or 5% salt).

Press .

Press  or  to adjust the value (in parts per thousand).

**Tip:** 0.1 ppt = 100 ppm salinity



Press  to confirm.

### 5.8 3.5 OFS (Offset Adjustment) from % mode

Use this feature to offset the meter's value to another DO meter. Using the % saturation mode, observe the reading a sample solution after it has stabilized. Similarly, observe the reading of the same sample using another DO meter as a reference. The probe of the reference meter should be immersed in the same sample at the same depth.

The DO 700 allows +/- 10.0% offset adjustment. Note that subsequent user calibrations will reset the offset adjustment back to the factory default value of 0.0 %.



Press .

Press  or  to adjust the % offset.

Press  to confirm.

### 5.9 3.5 Unit (Unit Adjustment) from concentration mode



Press .



Press  or  to select ppm or mg/L units.

Press  to confirm.

### 5.10 4.0 rSt (Reset)

Press .



Press  or  to select “Yes” (Reset) or “No” (Cancel).

If “Yes”, press  or  to select “Cal” (calibration reset only) or “Fct” (complete reset to factory default settings).

Press  to confirm.

### 5.11 5.0 CLr (Clear Stored Memory)

Press .

Press  or  to select “Yes” (Erase memory) or “No”.

Press  to confirm.

## 6. TAKING MEASUREMENTS

During measurement the dissolved oxygen reading is automatically compensated for pressure and salinity. For best accuracy, ensure the pressure and salinity settings are adjusted accordingly from the setup menu. The factory default value for barometric pressure is 760 mm Hg or 101.3 bar (sea level). The factory default value for salinity is 0.0 ppt (no salinity).

See [Section 5.6 — Barometric Pressure Adjustment](#).

See [Section 5.7 — Salinity Adjustment](#).



Press  to select the desired measurement mode:

- Percentage Saturation (%) and Temp (°C or °F)
- Concentration (mg/L or ppm) and Temp (°C or °F)

Follow these general rules when taking measurements:







- Keep the membrane free from contact with solid objects.
- Provide stirring of your solution—this helps to overcome oxygen consumption of the probe and prevents air bubble entrapment.
- Do not submerge the cable for extended periods.
- Use with aqueous solutions only.
- The pre-assembled cap must be completely submersed to obtain an accurate reading in solutions.
- Rinse the probe well with DI water or rinse solution between measurements.

## 6.1 HOLD Function

For prolonged observation of a reading, press  during measurement mode to freeze the display. The “HOLD” indicator will display when the reading is held. To release the held value and resume measurement, press  again or insert the held value into memory by pressing .

## 6.2 Storing and Recalling Data

The DO 700 can retain up to 100 data points into memory for later retrieval.

- 1) In the measurement mode, press  to insert the measured value into memory. The stored memory location value (StO) is briefly displayed.
- 2) To recall data from memory, press . The location of the most recent stored data is displayed first. Press  or  to select the location of the desired data, then press  to accept.
- 3) Press  to return to the stored data location. Press  to return to measurement mode. To erase stored data, see [Section 5.11 — Clear Stored Memory](#).

## 7. ELECTRODE MAINTENANCE

The DO 700 electrode produces an output proportional to the oxygen present in the medium in which it is placed. The galvanic probe design allows for immediate use—unlike the typical 15 minute warm-up period required for polarographic electrodes.

The probe consists of two parts. The upper part consists of the anode, cathode, and dual cable. The lower part consists of a pre-assembled cap, and electrolyte solution.

Oxygen diffuses through the membrane onto the cathode, where it is consumed. This process produces an electrical current which flows through the cable to the meter. The electric current produced is proportional to the oxygen that passes through the membrane and the layer of electrolyte. This makes it possible to measure the partial pressure of oxygen in the sample at a given temperature.

Since the DO in the sample is consumed by the cathode it is essential to have flow past the membrane of the probe to prevent the occurrence of false readings. The probe uses very little oxygen for its measurement. This enables it to function correctly with liquid movement as low as 2 inch/sec across membrane.

The permeability of the membrane to oxygen varies greatly with temperature. Therefore compensation is needed for this variation. The DO 700 probe comes with built-in temperature compensation for the membrane variation.

Proper maintenance will help you maximize probe life and achieve most accurate readings.

Deposits on the membrane surface act as a barrier to oxygen diffusing through the membrane, so clean the membrane to assure maximum reliability. After each use, rinse the probe with clean water to avoid any hardening of deposits or bacterial growth.

**NOTE:** Although the membrane is strong and not easily damaged, wipe it gently while cleaning it. If the membrane is punctured, damaged, or torn, the probe will not function properly.

There are no special probe storage requirements.

### Cap and Electrolyte Replacement

Replacement of the pre-assembled cap is required only when you cannot calibrate the probe, or if the membrane is damaged. Typical membrane damages are punctures or wrinkles caused during measurements or cleaning.

- 1) Unscrew the cap counter clockwise from the probe sensing tip.
- 2) Rinse the probe under running water.
- 3) Mount the nozzle tip onto the syringe provided. Fill the syringe with the refill solution through the tip of the plastic bottle.
- 4) Hold the probe upside down. Insert the nozzle tip into one of the 4 holes surrounding the silver cathode. Inject the fill solution into the probe body until solution leaks out from the fill hole (approximately 5 mL).
- 5) Replace pre-assembled cap by tightening clockwise until hand tightened.
- 6) Allow at least 1 hour for the electrode to equilibrate before usage.

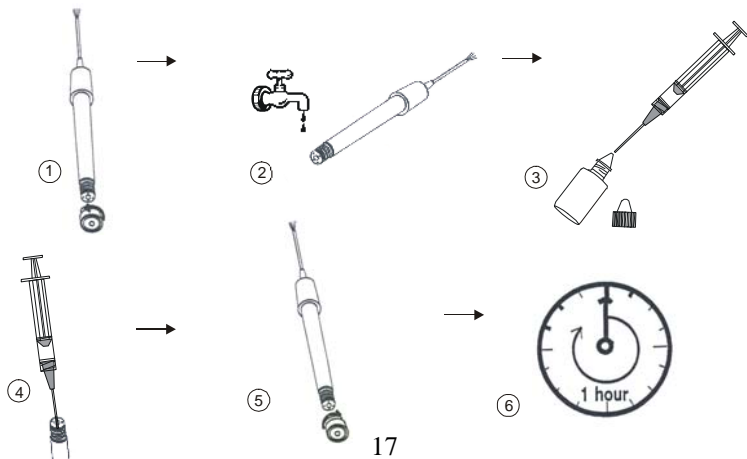

## **Electrolyte Solution**

The electrolyte solution in your probe's cap will deplete on usage and will need to be replaced periodically. The replacement electrolyte solution included with your probe comes premixed and ready to use. To order more electrolyte solution, see [Section 9 – Replacements and Accessories](#).



## 8. DISSOLVED OXYGEN THEORY

Dissolved Oxygen (DO) refers to the volume of oxygen that is contained in water. There are two main sources of DO in water; atmosphere and photosynthesis. Waves and tumbling water mix air into the water where oxygen readily dissolves until saturation occurs. Oxygen is also produced by aquatic plants and algae during photosynthesis.

The amount of DO that can be held by water depends on 3 factors:

1) **TEMPERATURE:**

DO increases with decreasing temperature  
(colder water holds more oxygen)

2) **SALINITY:**

DO increases with decreasing salinity  
(freshwater holds more oxygen than saltwater does)

3) **ATMOSPHERIC PRESSURE:**

DO decreases with decreasing atmospheric pressure  
(amount of DO absorbed in water decreases as altitude increases)

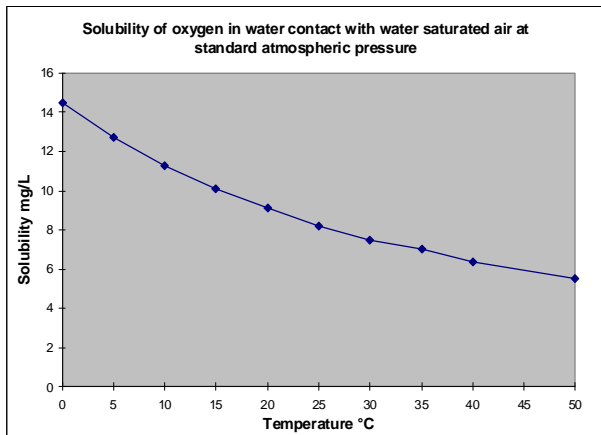

**DO Solubility in Water vs. Temperature**

## Measurement Units

One measure of DO in water is parts per million (ppm) which is the number of oxygen molecules (O<sub>2</sub>) per million total molecules in a sample. The “mg/L” unit is equivalent to ppm (a liter of water weighs 1 million milligrams—one part in a million is similar to one milligram in a liter). Calculating the % saturation is another way to analyze DO levels. % saturation is the measured DO level divided by the greatest amount of oxygen that the water could hold under various temperature and atmospheric pressure conditions multiplied by 100.

## What Is Being Measured?

DO probes respond to the partial pressure of oxygen in liquid or gas being measured—they measure the “pressure” of oxygen rather than concentration. All of the oxygen entering the probe is consumed at the cathode where it is electrochemically reduced to hydroxyl ions producing an electrical current within the probe:

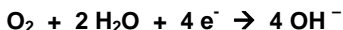

Since all oxygen entering the probe is chemically consumed, the partial pressure of oxygen in the electrolyte is zero. Therefore, a partial pressure gradient exists across the membrane and the rate at which oxygen enters the probe is a function of the partial pressure of oxygen in the gas or in liquid being measured.

When a probe is placed in air saturated water, the current it produces will not be affected by the temperature or salinity of the water. The DO concentration in the water, however, will vary with temperature and salinity. Because it is convenient to report DO concentration in mg/L or ppm, it is necessary to adjust for temperature and salinity of the water to get correct readings in these units.

If DO were to be reported in terms of partial pressure or % Saturation, then temperature and/or salinity compensation for oxygen solubility would not be necessary. Most probes are temperature compensated—i.e. they convert the “partial pressure measurement” to mg/L of DO at whatever temperature the water happens to be at for a given salinity and barometric pressure.

## **Air Calibration**

Understanding the principle of air calibration is easy, once you know that it is partial pressure that the probe is responding to. When the probe is in air, it is measuring the partial pressure of oxygen in air. If water is air saturated, then the partial pressure of oxygen in the water will be the same as it is in air. Therefore, all you need to know is the temperature of the air in which the probe is placed. By consulting solubility tables for oxygen at the particular barometric pressure and salinity of the water being measured, the corresponding concentration (mg/L or ppm) can be found for air saturated water at the air calibration temperature, and the meter can be set accordingly. Because most meters are temperature compensated, they will still give correct readings in mg/L even though the actual water temperature may be different to the air calibration temperature. Note: The closer the air calibration temperature is to the water temperature, the more accurate the calibration.

## **Applications**

Oxygen is essential for fish, invertebrate, plant, and aerobic bacteria respiration. DO levels below 3 ppm are stressful to most aquatic organisms. Levels below 2 or 1 ppm will not support fish. Fish growth and activity usually require 5 to 6 ppm of DO, an important consideration for Aqua-culture industry.

Low DO indicates a demand on the oxygen of the system. Natural organic material such as leaves accumulate in the stream and create an oxygen demand as it is decomposed. Organic materials from human activities also create an oxygen demand in the system. Micro-organisms consume oxygen as they decompose sewage, urban and agricultural run-off, and discharge from food-processing plants, meat-packing plants and dairies. There is an optimum DO level for this process and if the DO level falls too low, the micro-organisms die and the decomposition ceases. When DO level is too high, this indicates too much power is used than necessary for aeration resulting in an inefficient process.

In boiler water application, presence of oxygen in the water will increase corrosion and helps build up boiler scale that inhibits heat transfer. In such instance it is critical to keep DO concentration to a minimum.



Some pollutants such as acid mine drainage produce direct chemical demands on oxygen in the water. DO is consumed in the oxidation-reduction reactions of introduced chemical compounds such as nitrate ( $\text{NO}_3^{1-}$ ) and ammonia ( $\text{NH}_4^{1+}$ ), sulfate ( $\text{SO}_4^{2-}$ ), and sulfite ( $\text{SO}_3^{2-}$ ) and ferrous ( $\text{Fe}_2^+$ ) and ferric ( $\text{Fe}_3^+$ ) ions.





These are important consideration for water and wastewater treatment industry.

## 9. REPLACEMENTS AND ACCESSORIES

Item Description	Part number Ordering Code	
	Eutech Instruments	Oakton Instruments
DO 700 meter with DO/ATC probe and 1-m cable, (2) Pre-assembled caps, electrolyte, integral stand, & 100/240 VAC adapter.	ECDO70042S 01X543501	35415-00
DO/ATC probe, 1-m cable, (2) Pre-assembled caps, electrolyte, & plastic syringe.	DO6HANDY 01X233913	35642-50
DO/ATC probe, 3-m cable, (2) Pre-assembled caps, electrolyte, & plastic syringe.	DO6HANDY3M 01X233916	35462-52
Pre-assembled cap	01X241608	—
Pre-assembled cap, 10 mL electrolyte, plastic syringe	01X241609	35642-55
SMPS, 100/240 VAC, 9V, 6W power adapter	60X030130	35615-07
Zero Oxygen Solution (500 mL)	—	00653-00
DO probe electrolyte refilling solution (60 mL)	01X211226	—

## 10. TROUBLESHOOTING GUIDE

PROBLEM	CAUSE	SOLUTION
No display	Main power not switched on. AC Adapter socket not inserted properly.	Switch on the power supply. Re-insert AC Adapter.
“Ur” (Under range) “Or” (Over range) in primary or secondary display	DO or Temperature value is out of range. Probe is not connected. Electrode dirty or broken. Meter not calibrated.	Confirm measurement condition, ensure temp is within range. Check electrode connections. Check electrode-add electrolyte &/or replace membrane. Reset meter & recalibrate.
Meter not responding to key press	Manual HOLD or Auto HOLD is active.  Worn keypad.	Press  to deactivate manual HOLD. See <a href="#">Section 5.4 — Auto Hold</a> to disable Auto Hold feature if enabled. Contact Technical Service.
 Secondary display continually shows 0 and 100, during % calibration	Invalid key; Button is not functional in the current operation mode.  The calibration value is too high to be accepted as a 0% standard, and too low to be accepted as a 100% standard (10.1% to 49.9%), compared against factory default value.	Press alternate key. Select valid key depending on current mode.  Service probe. Check calibration solution. Check sample conditions (temp, salinity and pressure settings). Reset meter.

PROBLEM	CAUSE	SOLUTION
<b>CAL</b>  	% calibration value is not acceptable. Electrode is disconnected or failing.	Check electrode connections. Check that correct DO unit is selected & repeat cal procedure. Service electrode. Reset meter. Replace electrode.
<b>CAL</b>  	ppm or mg/L calibration is attempted when the factory calibrated absolute value is below 2.00	Use concentration calibration solution higher than 2.00. Check electrode connections. Check that correct DO unit is selected & repeat cal procedure. Service electrode. Reset meter. Replace electrode.
Slow response or unstable readings	External noise pickup or induction caused by nearby electric motor	Remove or switch off interfering device
	Insufficient electrolyte in probe	Fill probe with electrolyte & / or replace pre-assembled cap
	Air bubbles near sensor	Stir or tap probe to remove bubbles, reduce stirring
	Dirty or damaged probe	Clean the probe and re-calibrate
	Probe not deep enough in sample	Submerge sensor cap into sample
	Broken probe	Replace probe or membrane

## 11. SPECIFICATIONS

DO % Saturation Range Resolution Relative accuracy Offset adjustment Calibration Points	0 to 300% 0.1 % (0.0 to 199.9%); 1% (200 to 300%) $\pm 0.5\%$ of value $\pm 10.0\%$ of reading (2 points) 100% in saturated air or air-saturated water, 0% in zero oxygen solution
DO mg/L or ppm Range Resolution Relative accuracy Calibration	0.0 to 30.0 0.01 $\pm 0.5\%$ of value (1 point) $\pm 40\%$ from the factory default value. Minimum reading allowed is 2.00.
Temperature Range Resolution Relative accuracy Calibration	0.0 to 50.0 °C / 32.0 to 122.0 °F 0.1 °C / °F $\pm 0.5^{\circ}\text{C}$ / $\pm 0.9^{\circ}\text{F}$ Offset in 0.1 ° increments; Offset range: $\pm 5^{\circ}\text{C}$ / $9^{\circ}\text{F}$
Salinity Correction Range Resolution Method	0.0 to 50.0 ppt 0.1 ppt Automatic correction after manual input
Pressure Correction Range Resolution Method	450 to 825 mmHg / 0.6 to 1.1 bar 1 mm Hg / 0.1 bar Automatic correction after manual input
Probe (DO / Temp)	Galvanic / Thermistor
Avg. Response Time	60 seconds to achieve 95% of the reading
Hold Function	Yes
Memory	100 data sets
Input	BNC for DO & 2.5 mm phono plug for temperature
Power	AC/DC 9V, 6W Adapter (100/240 VAC, 50-60Hz)
Dimensions (mm)	meter only = 175 (L) x 155 (W) x 69 (H)



## 12. WARRANTY

This meter is supplied with a warranty against significant deviations in material and workmanship for a period of THREE years from date of purchase whereas probe with a SIX month warranty.

If repair or adjustment is necessary and has not been the result of abuse or misuse within the designated period, please return – freight prepaid – and correction will be made without charge. Eutech Instruments/Oakton Instruments will determine if the product problem is due to deviations or customer misuse.

Out of warranty products will be repaired on a charged basis.

The warranty on your instrument shall not apply to defects resulting from:

- Improper or inadequate maintenance by customer
- Unauthorized modification or misuse
- Operation outside of the environment specifications of the products

### **13. RETURN OF ITEMS**

Authorization must be obtained from our Customer Service Department or authorized distributor before returning items for any reason. A “Return Material Authorization” (RMA) form is available through our authorized distributor. Please include data regarding the reason the items are to be returned. For your protection, items must be carefully packed to prevent damage in shipment and insured against possible damage or loss. Eutech Instruments will not be responsible for damage resulting from careless or insufficient packing. A restocking charge will be made on all unauthorized returns.

**NOTE:** Eutech Instruments Pte Ltd /Oakton Instruments reserve the right to make improvements in design, construction, and appearance of products without notice.



**For more information on our products, please contact our channel partner or visit our websites listed below:**

**Oakton Instruments**

625 E Bunker Court  
Vernon Hills, IL 60061  
USA

Tel: (1) 888-462-5866  
Fax: (1) 847-247-2984

[info@4oakton.com](mailto:info@4oakton.com)  
[www.4oakton.com](http://www.4oakton.com)

**Eutech Instruments Pte Ltd**

Blk 55, Ayer Rajah Crescent,  
#04-16/24  
Singapore 139949

Tel: (65) 6778 6876  
Fax: (65) 6773 0836

[eutech@thermofisher.com](mailto:eutech@thermofisher.com)  
[www.eutechinst.com](http://www.eutechinst.com)

**Distributed by:**

*Part of Thermo Fisher Scientific*