



# Heavy Duty Orbital Shakers



## *Eight Orbital Shakers Offering a Variety of Capacities and Flexibility to Maximize Sample Processing*

OHAUS Heavy Duty Shakers are designed to handle a wide range of applications no matter how difficult the task. Powerful, convenient shakers provide consistent orbital shaking action. Digital models offer accurate speed control for applications that demand repeatable results. Non-digital models are an economical alternative. Maximize throughput and efficiency in your laboratory - eight models with load capacities ranging from 16 to 68 kg.

### *Standard Features:*

- Ready for your lab - all models include a tray and rubber mat and can be customized with over 70 accessory options.
- Rely on the digital shakers' exclusive Accu-Drive shaking system for exceptional speed control, accuracy and durability. All models feature a maintenance-free motor for long-term use.
- Protect your samples. Optimal speed ramping feature slowly increases speed to setpoint to avoid splashing. The load sensor detects unbalanced conditions and automatically reduces to a safe speed.

# Specifications Heavy Duty Orbital Shakers

Model	SHHD1619AL	SHHD1619DG	SHHD2325AL	SHHD2325DG	SHHD4525DG	SHHD4550DG	SHHD6825DG	SHHD6850DG
Control	Analog	Digital	Analog	Digital				
Motion	Orbital, 19 mm		Orbital, 25 mm			Orbital, 51 mm	Orbital, 25 mm	Orbital, 51 mm
Speed Range	25 to 500 rpm	15 to 500 rpm	25 to 500 rpm	20 to 500 rpm	15 to 500 rpm	15 to 300 rpm	15 to 500 rpm	15 to 300 rpm
Speed Accuracy	N/A	above 100 rpm ± 1% of set speed, below 100 rpm ± 1 rpm	N/A	above 100 rpm ± 1% of set speed, below 100 rpm ± 1 rpm				
Timer	1 minute to 120 minutes	1 second to 160 hours	1 minute to 120 minutes	1 second to 160 hours				
Max. Weight Capacity	16 kg		22.7 kg		45.4 kg		68 kg	
Audible Alarm	—	•	—	•	•	•	•	•
Load Sensor	—	•	—	•	•	•	•	•
Overload Protection	—	•	—	•	•	•	•	•
User Calibration (Speed)	—	•	—	•	•	•	•	•
RS232 Interface	—	•	—	•	•	•	•	•
Working Environment	0 °C – 40 °C, 80% RH*, non-condensing	-10 °C – 60 °C, 80% RH, non-condensing	0 °C – 40 °C, 80% RH, non-condensing	-10 °C – 60 °C, 80% RH, non-condensing				
Drive System	Brushless DC Motor; Triple Eccentric							
Included Tray (L × W)	279 × 330 mm		457 × 610 mm		610 × 610 mm		610 × 910 mm	
Overall Dimensions (L × W × H)	413 × 355 × 149 mm		610 × 678 × 149 mm		729 × 678 × 170 mm		744 × 914 × 170 mm	
Net Weight	21.8 kg		49 kg		90.3 kg		103.9 kg	
Power	230V, 2.5A, 50/60Hz							
Power Consumption	75 W				80 W			

\*Relative Humidity

## Other Standard Features and Equipment

Built-in tray with a non-slip rubber mat (included)

## Compliance

- **Product Safety:** EN 61010-1, EN 61010-2-051
- **Electromagnetic Compatibility:** EN 61326-1 Class A, Industrial Environments
- **Compliance Marks:** CE; RCM; TÜV SÜD

## Applications

Cell cultures, solubility studies, extractions, bacteria and yeast cultures and suspensions, staining/destaining, immunoassays, protein studies, blotting techniques

# Accessory Platforms Heavy Duty Orbital Shakers

Platforms for Heavy Duty Shakers										
Item No.	Description	Stackable*	SHHD1619AL	SHHD1619DG	SHHD2325AL	SHHD2325DG	SHHD4525DG	SHHD4550DG	SHHD6825DG	SHHD6850DG
30400052	Universal Platform, 28 × 33 cm	Not Stackable	•	•						
30400053	Universal Platform, 33 × 33 cm	Not Stackable	•	•						
30400054	Universal Platform, 46 × 46 cm	Stackable	•	•						
30400056	Universal Platform, 61 × 46 cm	Stackable**	•	•	•	•				
30400057	Universal Platform, 61 × 61 cm	Not Stackable					•	•		
30400058	Universal Platform, 76 × 46 cm	Stackable			•	•				
30400059	Universal Platform, 91 × 61 cm	Not Stackable							•	•
30400066	Culture Platform with Mat, 46 × 46 cm	Stackable	•	•						
30400067	Culture Platform with Mat, 46 × 61 cm	Stackable**	•	•	•	•				
30400068	Adjustable Platform, 46 × 46 cm	Not Stackable	•	•						
30400069	Adjustable Platform, 61 × 46 cm	Not Stackable			•	•				
30400070	Large Vessel Carrier, 76 × 46 cm	Not Stackable			•	•				
30400071	Large Vessel Carrier, 61 × 61 cm	Not Stackable					•	•		
30400072	Large Vessel Carrier, 91 × 61 cm	Not Stackable							•	•
30400075	Dedicated Platform, 33 × 33 cm, 125 mL	Not Stackable	•	•						
30400076	Dedicated Platform, 33 × 33 cm, 250 mL	Not Stackable	•	•						
30400077	Dedicated Platform, 33 × 33 cm, 500 mL	Not Stackable	•	•						
30400078	Dedicated Platform, 33 × 33 cm, 1000 mL	Not Stackable	•	•						
30400079	Dedicated Platform, 46 × 46 cm, 125 mL	Stackable	•	•						
30400080	Dedicated Platform, 46 × 46 cm, 250 mL	Stackable	•	•						
30400081	Dedicated Platform, 46 × 46 cm, 500 mL	Stackable	•	•						
30400082	Dedicated Platform, 46 × 46 cm, 1000 mL	Stackable	•	•						
30400083	Separatory Funnel Platform 46 × 46 cm	Not Stackable	•	•						

\*To stack platforms select (2) stackable platforms of the same size and (1) tier brace kit (Item No. 30400051)

\*\*61 × 46 platforms can be used on both 16 kg and 23 kg shakers but can only be stacked on 16 kg shakers



30400052  
Universal Platform, 28 × 33 cm



30400067  
Culture Platform with Mat, 46 × 61 cm



30400068  
Adjustable Platform, 46 × 46 cm



30400079  
Dedicated Platform, 46 × 46 cm, 125 mL

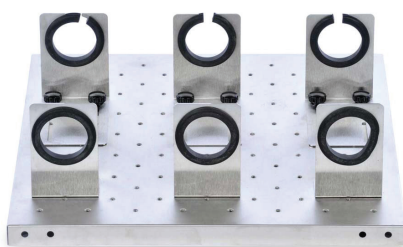

30400083  
Separatory Funnel Platform, 46 × 46 cm

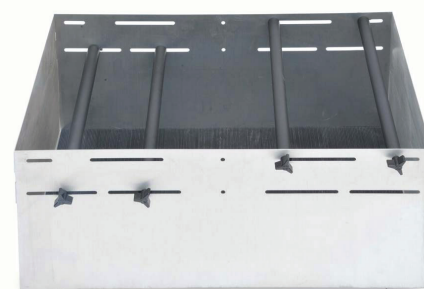

30400072  
Large Vessel Carrier, 91 × 61 cm

# Accessories Heavy Duty Orbital Shakers

Accessories for Universal Platform, 28 × 33 cm, S/S (Item No. 30400052)	Description	Max per Platform
30400084	Flask Clamp, 10 mL	60
30400085	Flask Clamp, 25 mL	25
30400086	Flask Clamp, 50 mL	13
30400087	Flask Clamp, 125 mL	10
30400088	Flask Clamp, 250 mL	9
30400089	Flask Clamp, 500 mL	7
30400090	1 Liter Erlenmeyer Flask Clamp	4
30400097	500 mL Media Bottle Clamp	5
30400098	1000 mL Media Bottle Clamp	2
30400099	Flask Clamp PVC 125 mL	10
30400100	Flask Clamp PVC 250 mL	8
30400101	Flask Clamp PVC 500 mL	5
30400102	Flask Clamp PVC 1000 mL	2
30400105	Test Tube Rack 13 mm Pivoting	1
30400106	Test Tube Rack 16 mm Pivoting	1
30400107	Test Tube Rack 20 mm Pivoting	1
30400108	Test Tube Rack 25 mm Pivoting	1
30400109	Test Tube Rack 30 mm Pivoting	1
30400114	Micro Tube Rack	2
30400115	Test Tube Rack 10-13 mm Diameter	2
30400116	Test Tube Rack 14-16 mm Diameter	2
30400117	Test Tube Rack 18-20 mm Diameter	2
30400118	Test Tube Rack 22-25 mm Diameter	2
30400119	Test Tube Rack For 15 mL Tubes	2
30400120	Test Tube Rack For 50 mL Tubes	2
30400104	Clamp Microplate Stainless Steel	4
30400060	Rubber Mat, 28 × 33 cm	1



30400052  
Universal Platform, 28 × 33 cm



30400085  
Flask Clamp, 25 mL



30400060  
Rubber Mat, 28 × 33 cm

# Accessories Heavy Duty Orbital Shakers

Accessories for Universal Platform, 33 × 33 cm, S/S (Item No. 30400053)	Description	Max per Platform
30400084	Flask Clamp, 10 mL	60
30400085	Flask Clamp, 25 mL	30
30400086	Flask Clamp, 50 mL	15
30400087	Flask Clamp, 125 mL	12
30400088	Flask Clamp, 250 mL	12
30400089	Flask Clamp, 500 mL	8
30400090	1 Liter Erlenmeyer Flask Clamp	4
30400091	2 Liter Erlenmeyer Flask Clamp	3
30400092	2.8 Liter Erlenmeyer Flask Clamp	1
30400093	3 Liter Erlenmeyer Flask Clamp	1
30400094	4 Liter Erlenmeyer Flask Clamp	1
30400095	5 Liter Erlenmeyer Flask Clamp	1
30400096	6 Liter Erlenmeyer Flask Clamp	1
30400097	500 mL Media Bottle Clamp	6
30400098	1000 mL Media Bottle Clamp	5
30400099	Flask Clamp PVC 125 mL	12
30400100	Flask Clamp PVC 250 mL	10
30400101	Flask Clamp PVC 500 mL	6
30400102	Flask Clamp PVC 1000 mL	4
30400103	Flask Clamp PVC 2000 mL	3
30400105	Test Tube Rack 13 mm Pivoting	2
30400106	Test Tube Rack 16 mm Pivoting	2
30400107	Test Tube Rack 20 mm Pivoting	2
30400108	Test Tube Rack 25 mm Pivoting	2
30400109	Test Tube Rack 30 mm Pivoting	2
30400114	Micro Tube Rack	2
30400115	Test Tube Rack 10-13 mm Diameter	2
30400116	Test Tube Rack 14-16 mm Diameter	2
30400117	Test Tube Rack 18-20 mm Diameter	2
30400118	Test Tube Rack 22-25 mm Diameter	2
30400119	Test Tube Rack For 15 mL Tubes	2
30400120	Test Tube Rack For 50 mL Tubes	2
30400104	Clamp Microplate Stainless Steel	6
30400061	Rubber Mat, 33 × 33 cm	1



30400053  
Universal Platform, 33 × 33 cm



30400099  
Flask Clamp PVC 125 mL



30400097  
500 mL Media Bottle Clamp

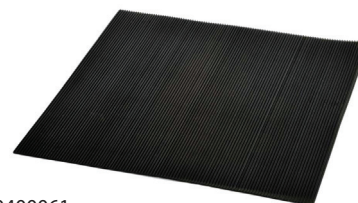

30400061  
Rubber Mat, 33 × 33 cm



# Accessories Heavy Duty Orbital Shakers

Accessories for Universal Platform, 46 × 46 cm, S/S (Item No. 30400054)	Description	Max per Platform
30400051	Double Tier Braces, Set of 4	1
30400084	Flask Clamp, 10 mL	113
30400085	Flask Clamp, 25 mL	64
30400086	Flask Clamp, 50 mL	32
30400087	Flask Clamp, 125 mL	20
30400088	Flask Clamp, 250 mL	20
30400089	Flask Clamp, 500 mL	13
30400090	1 Liter Erlenmeyer Flask Clamp	8
30400091	2 Liter Erlenmeyer Flask Clamp	5
30400092	2.8 Liter Erlenmeyer Flask Clamp	2
30400093	3 Liter Erlenmeyer Flask Clamp	2
30400094	4 Liter Erlenmeyer Flask Clamp	4
30400095	5 Liter Erlenmeyer Flask Clamp	4
30400096	6 Liter Erlenmeyer Flask Clamp	2
30400097	500 mL Media Bottle Clamp	16
30400098	1000 mL Media Bottle Clamp	10
30400099	Flask Clamp PVC 125 mL	20
30400100	Flask Clamp PVC 250 mL	18
30400101	Flask Clamp PVC 500 mL	12
30400102	Flask Clamp PVC 1000 mL	8
30400103	Flask Clamp PVC 2000 mL	4
30400105	Test Tube Rack 13 mm Pivoting	2
30400106	Test Tube Rack 16 mm Pivoting	2
30400107	Test Tube Rack 20 mm Pivoting	2
30400108	Test Tube Rack 25 mm Pivoting	2
30400109	Test Tube Rack 30 mm Pivoting	2
30400110	Test Tube Rack 10-14 mm Stationary	3
30400111	Test Tube Rack 16-20 mm Stationary	3
30400112	Test Tube Rack 21-25 mm Stationary	3
30400113	Test Tube Rack 50 mL Tubes Stationary	3
30400114	Micro Tube Rack	4
30400115	Test Tube Rack 10-13 mm Diameter	4
30400116	Test Tube Rack 14-16 mm Diameter	4
30400117	Test Tube Rack 18-20 mm Diameter	4
30400118	Test Tube Rack 22-25 mm Diameter	4
30400119	Test Tube Rack For 15 mL Tubes	4
30400120	Test Tube Rack For 50 mL Tubes	4
30400104	Clamp Microplate Stainless Steel	12
30400062	Rubber Mat, 46 × 46 cm	1



30400054  
Universal Platform, 46 × 46 cm



30400051  
Double Tier Braces, Set of 4



30400088  
Flask Clamp, 250 mL



30400096  
6 Liter Erlenmeyer Flask Clamp

# Accessories Heavy Duty Orbital Shakers

Accessories for Universal Platform, 61 × 46 cm, S/S (Item No. 30400056)	Description	Max per Platform
30400051	Double Tier Braces, Set of 4	1
30400084	Flask Clamp, 10 mL	158
30400085	Flask Clamp, 25 mL	88
30400086	Flask Clamp, 50 mL	44
30400087	Flask Clamp, 125 mL	28
30400088	Flask Clamp, 250 mL	28
30400089	Flask Clamp, 500 mL	20
30400090	1 Liter Erlenmeyer Flask Clamp	12
30400091	2 Liter Erlenmeyer Flask Clamp	6
30400092	2.8 Liter Erlenmeyer Flask Clamp	3
30400093	3 Liter Erlenmeyer Flask Clamp	3
30400094	4 Liter Erlenmeyer Flask Clamp	4
30400095	5 Liter Erlenmeyer Flask Clamp	4
30400096	6 Liter Erlenmeyer Flask Clamp	3
30400097	500 mL Media Bottle Clamp	20
30400098	1000 mL Media Bottle Clamp	13
30400099	Flask Clamp PVC 125 mL	28
30400100	Flask Clamp PVC 250 mL	25
30400101	Flask Clamp PVC 500 mL	16
30400102	Flask Clamp PVC 1000 mL	10
30400103	Flask Clamp PVC 2000 mL	6
30400105	Test Tube Rack 13 mm Pivoting	3
30400106	Test Tube Rack 16 mm Pivoting	3
30400107	Test Tube Rack 20 mm Pivoting	3
30400108	Test Tube Rack 25 mm Pivoting	3
30400109	Test Tube Rack 30 mm Pivoting	3
30400110	Test Tube Rack 10-14 mm Stationary	5
30400111	Test Tube Rack 16-20 mm Stationary	5
30400112	Test Tube Rack 21-25 mm Stationary	5
30400113	Test Tube Rack 50 mL Tubes Stationary	5
30400114	Micro Tube Rack	6
30400115	Test Tube Rack 10-13 mm Diameter	6
30400116	Test Tube Rack 14-16 mm Diameter	6
30400117	Test Tube Rack 18-20 mm Diameter	6
30400118	Test Tube Rack 22-25 mm Diameter	6
30400119	Test Tube Rack For 15 mL Tubes	6
30400120	Test Tube Rack For 50 mL Tubes	6
30400104	Clamp Microplate Stainless Steel	18
30400063	Rubber Mat, 46 × 61 cm	1



30400056  
Universal Platform, 61 × 46 cm



30400095  
5 Liter Erlenmeyer Flask Clamp



30400102  
Flask Clamp PVC 1000 mL



30400103  
Flask Clamp PVC 2000 mL

# Accessories Heavy Duty Orbital Shakers

Accessories for Universal Platform, 61 × 61 cm, S/S (Item No. 30400057)	Description	Max per Platform
30400084	Flask Clamp, 10 mL	221
30400085	Flask Clamp, 25 mL	121
30400086	Flask Clamp, 50 mL	61
30400087	Flask Clamp, 125 mL	41
30400088	Flask Clamp, 250 mL	41
30400089	Flask Clamp, 500 mL	25
30400090	1 Liter Erlenmeyer Flask Clamp	16
30400091	2 Liter Erlenmeyer Flask Clamp	9
30400092	2.8 Liter Erlenmeyer Flask Clamp	5
30400093	3 Liter Erlenmeyer Flask Clamp	5
30400094	4 Liter Erlenmeyer Flask Clamp	5
30400095	5 Liter Erlenmeyer Flask Clamp	5
30400096	6 Liter Erlenmeyer Flask Clamp	5
30400097	500 mL Media Bottle Clamp	25
30400098	1000 mL Media Bottle Clamp	18
30400099	Flask Clamp PVC 125 mL	41
30400100	Flask Clamp PVC 250 mL	35
30400101	Flask Clamp PVC 500 mL	24
30400102	Flask Clamp PVC 1000 mL	13
30400103	Flask Clamp PVC 2000 mL	9
30400105	Test Tube Rack 13 mm Pivoting	4
30400106	Test Tube Rack 16 mm Pivoting	4
30400107	Test Tube Rack 20 mm Pivoting	4
30400108	Test Tube Rack 25 mm Pivoting	4
30400109	Test Tube Rack 30 mm Pivoting	4
30400110	Test Tube Rack 10-14 mm Stationary	7
30400111	Test Tube Rack 16-20 mm Stationary	7
30400112	Test Tube Rack 21-25 mm Stationary	7
30400113	Test Tube Rack 50 mL Tubes Stationary	7
30400114	Micro Tube Rack	8
30400115	Test Tube Rack 10-13 mm Diameter	8
30400116	Test Tube Rack 14-16 mm Diameter	8
30400117	Test Tube Rack 18-20 mm Diameter	8
30400118	Test Tube Rack 22-25 mm Diameter	8
30400119	Test Tube Rack For 15 mL Tubes	8
30400120	Test Tube Rack For 50 mL Tubes	8
30400104	Clamp Microplate Stainless Steel	24
30400064	Rubber Mat, 61 × 61 cm	1



30400057  
Universal Platform, 61 × 61 cm



30400114  
Micro Tube Rack



30400117  
Test Tube Rack 18-20 mm Diameter



30400064  
Rubber Mat, 61 × 61 cm



# Accessories Heavy Duty Orbital Shakers

Accessories for Universal Platform, 76 × 46 cm, S/S (Item No. 30400058)	Description	Max per Platform
30400051	Double Tier Braces, Set of 4	1
30400084	Flask Clamp, 10 mL	203
30400085	Flask Clamp, 25 mL	112
30400086	Flask Clamp, 50 mL	56
30400087	Flask Clamp, 125 mL	36
30400088	Flask Clamp, 250 mL	36
30400089	Flask Clamp, 500 mL	26
30400090	1 Liter Erlenmeyer Flask Clamp	15
30400091	2 Liter Erlenmeyer Flask Clamp	8
30400092	2.8 Liter Erlenmeyer Flask Clamp	3
30400093	3 Liter Erlenmeyer Flask Clamp	4
30400094	4 Liter Erlenmeyer Flask Clamp	6
30400095	5 Liter Erlenmeyer Flask Clamp	6
30400096	6 Liter Erlenmeyer Flask Clamp	4
30400097	500 mL Media Bottle Clamp	28
30400098	1000 mL Media Bottle Clamp	18
30400099	Flask Clamp PVC 125 mL	36
30400100	Flask Clamp PVC 250 mL	33
30400101	Flask Clamp PVC 500 mL	20
30400102	Flask Clamp PVC 1000 mL	14
30400103	Flask Clamp PVC 2000 mL	8
30400105	Test Tube Rack 13 mm Pivoting	4
30400106	Test Tube Rack 16 mm Pivoting	4
30400107	Test Tube Rack 20 mm Pivoting	4
30400108	Test Tube Rack 25 mm Pivoting	4
30400109	Test Tube Rack 30 mm Pivoting	4
30400110	Test Tube Rack 10-14 mm Stationary	6
30400111	Test Tube Rack 16-20 mm Stationary	6
30400112	Test Tube Rack 21-25 mm Stationary	6
30400113	Test Tube Rack 50 mL Tubes Stationary	6
30400114	Micro Tube Rack	8
30400115	Test Tube Rack 10-13 mm Diameter	8
30400116	Test Tube Rack 14-16 mm Diameter	8
30400117	Test Tube Rack 18-20 mm Diameter	8
30400118	Test Tube Rack 22-25 mm Diameter	8
30400119	Test Tube Rack For 15 mL Tubes	8
30400120	Test Tube Rack For 50 mL Tubes	8
30400104	Clamp Microplate Stainless Steel	21



30400058  
Universal Platform, 76× 46 cm



30400088  
Flask Clamp, 250 mL



30400097  
500 mL Media Bottle Clamp

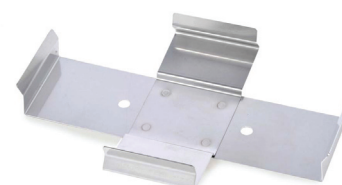

30400104  
Clamp Microplate Stainless Steel

# Accessories Heavy Duty Orbital Shakers

Accessories for Universal Platform, 91 × 61 cm, S/S (Item No. 30400059)	Description	Max per Platform
30400084	Flask Clamp, 10 mL	336
30400085	Flask Clamp, 25 mL	160
30400086	Flask Clamp, 50 mL	94
30400087	Flask Clamp, 125 mL	61
30400088	Flask Clamp, 250 mL	64
30400089	Flask Clamp, 500 mL	40
30400090	1 Liter Erlenmeyer Flask Clamp	24
30400091	2 Liter Erlenmeyer Flask Clamp	14
30400092	2.8 Liter Erlenmeyer Flask Clamp	7
30400093	3 Liter Erlenmeyer Flask Clamp	7
30400094	4 Liter Erlenmeyer Flask Clamp	9
30400095	5 Liter Erlenmeyer Flask Clamp	7
30400096	6 Liter Erlenmeyer Flask Clamp	7
30400097	500 mL Media Bottle Clamp	40
30400098	1000 mL Media Bottle Clamp	30
30400099	Flask Clamp PVC 125 mL	61
30400100	Flask Clamp PVC 250 mL	55
30400101	Flask Clamp PVC 500 mL	38
30400102	Flask Clamp PVC 1000 mL	22
30400103	Flask Clamp PVC 2000 mL	13
30400105	Test Tube Rack 13 mm Pivoting	6
30400106	Test Tube Rack 16 mm Pivoting	6
30400107	Test Tube Rack 20 mm Pivoting	6
30400108	Test Tube Rack 25 mm Pivoting	6
30400109	Test Tube Rack 30 mm Pivoting	6
30400110	Test Tube Rack 10-14 mm Stationary	5
30400111	Test Tube Rack 16-20 mm Stationary	5
30400112	Test Tube Rack 21-25 mm Stationary	5
30400113	Test Tube Rack 50 mL Tubes Stationary	5
30400114	Micro Tube Rack	7
30400115	Test Tube Rack 10-13 mm Diameter	7
30400116	Test Tube Rack 14-16 mm Diameter	7
30400117	Test Tube Rack 18-20 mm Diameter	7
30400118	Test Tube Rack 22-25 mm Diameter	7
30400119	Test Tube Rack For 15 mL Tubes	7
30400120	Test Tube Rack For 50 mL Tubes	7
30400104	Clamp Microplate Stainless Steel	36
30400065	Rubber Mat, 61 × 91 cm	1



30400059  
Universal Platform, 91 × 61 cm

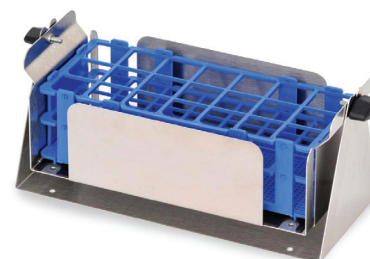

30400109  
Test Tube Rack 30 mm Pivoting



30400120  
Test Tube Rack For 50 mL Tubes

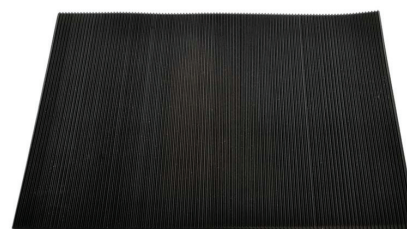

30400065  
Rubber Mat, 61 × 91 cm

# Accessories Heavy Duty Orbital Shakers

Accessories for Large Vessel Carrier Platforms	Description	Compatible Platforms
30400073	Adjustment Bar, 46 cm	30400070
30400074	Adjustment Bar, 61 cm	30400071 & 30400072



30400073  
Adjustment Bar, 46 cm

Accessories for Large Vessel Carrier Platforms	Description	Compatible Platforms
30400073	Adjustment Bar, 46 cm	30400070
30400074	Adjustment Bar, 61 cm	30400071 & 30400072



30400074  
Adjustment Bar, 61 cm

# Heavy Duty Orbital Shakers

## Dimensions

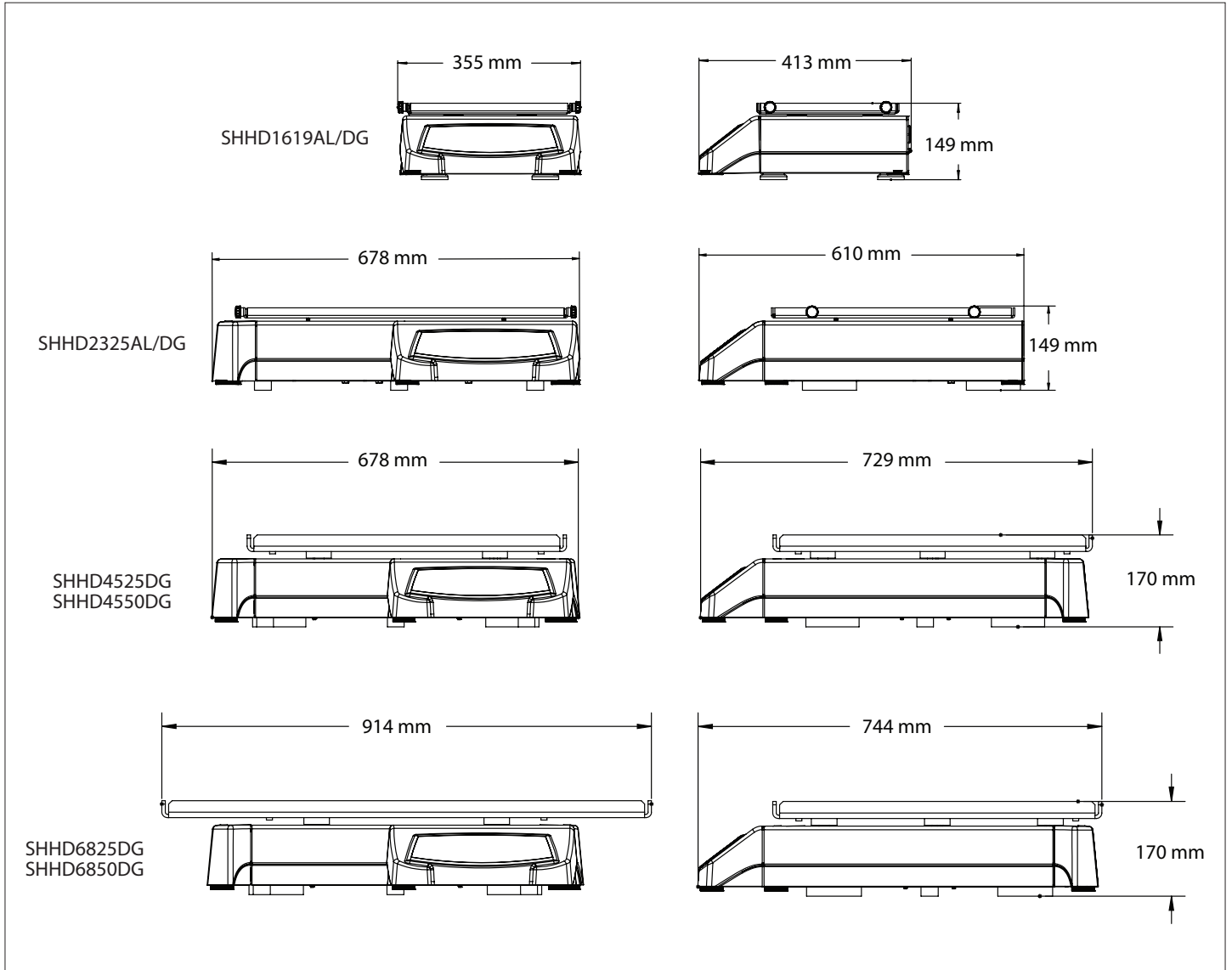

### OHAUS Asia/Pacific Headquarters

7F, Block 33, 680 Guiping Road  
Shanghai 200233  
China

e-mail: [APmarketing@ohaus.com](mailto:APmarketing@ohaus.com)  
Tel: +86 21 64855408

[www.ohaus.com](http://www.ohaus.com)

*The management system  
governing the manufacture  
of this product is  
ISO 9001:2015 certified.*

SAP Literature #

