

UNPACKING

Carefully remove your Scout balance and each of its components from the package. Store the packaging material to ensure safe storage and future transport.





Included Components:

- Balance
- Quick Start Guide
- Warranty Card
- AC Adapter & Plug
- Pan
- Stacking & Storage Cover (not applicable for 1mg models)
- Calibration Mass (only for models up to 620g capacity)

SELECTING THE LOCATION

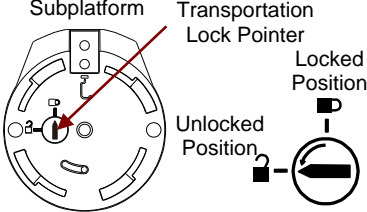
Place on a firm, steady surface with sufficient space. Avoid excessive air current, vibrations, heat sources, or rapid temperature changes.

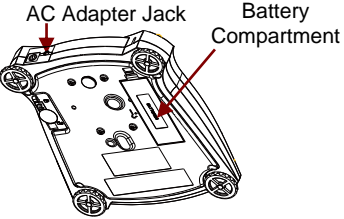
PREPARATION FOR USE

<p>Step-1</p>	<p>Release the red Transportation Lock on the subplatform of the balance</p> <p>Turn the pointer 90° counter-clockwise.</p>	 <p>Subplatform Transportation Lock Pointer</p> <p>Locked Position</p> <p>Unlocked Position</p>
<p>Step-2</p>	<p>Install the Pan</p> <p><i>Rectangular pan:</i> Place diagonally on sub-platform and rotate counter-clockwise until it locks.</p> <p><i>Round pan:</i> Set straight down on subplatform.</p>	
<p>Step-3</p>	<p>Connect Power</p> <p>Connect the AC Adapter to the balance input jack.</p> <p><i>Battery Installation</i></p> <p>Install the Four "AA" (LR6) batteries (not included) with polarity as shown in the battery compartment.</p>	 <p>AC Adapter Jack Battery Compartment</p>
<p>Step-4</p>	<p>Level the balance</p> <p>Level the balance before using by adjusting the feet until level bubble is center</p>	

SAFETY PRECAUTIONS



CAUTION: Read all safety warnings before installing, making connections, or servicing this equipment. Failure to comply with these warnings could result in personal injury and/or property damage. Retain all instructions for future reference.

- Verify that the local AC power supply voltage is within the input voltage range printed on the AC adapter's ratings label.
- Only connect the AC adapter to a compatible grounded socket.
- Position the instrument such that the AC adapter can be easily disconnected from the socket.
- Position the power cord so that it does not pose a potential obstacle or tripping hazard.
- Operate the equipment only under ambient conditions specified in the user instructions.
- Do not operate the equipment in hazardous or explosive environments.
- Disconnect the equipment from mains power before cleaning or servicing.
- Service should only be performed by authorized personnel.



CONTROLS

- **Button Functions**

	<p>Zero ①</p> <p><u>Short Press:</u> Turns the balance on If balance is On, sets Zero</p> <p><u>Long Press:</u> Turns the balance Off</p>
<p>Tare</p>	<p>Tare</p>

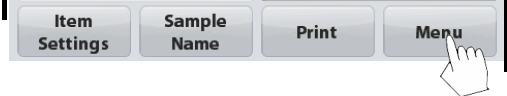

- **Main Application Screen**

This balance utilizes a touch-sensitive display. *Touch* areas and Buttons to control the balance functions.

Application		Capacity and readability
Stability (*), Net (NET), Gross (G) and/or center of zero (>0<) indicators		Result Field: Information varies by application Touch g to change unit
Reference Fields		
		Application Buttons: Functions vary by application

CALIBRATION

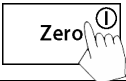
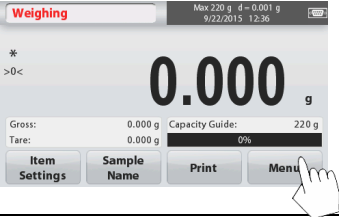
With balance turned off:

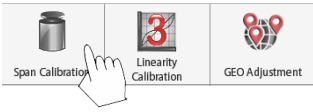
Step-1	Clear Pan.	
Step-2	Turn On balance	
Step-3	Press Menu	
Step-4	Press Calibration	
Step-5	Choose preferred calibration method.	
Step-6	Follow the screen instructions.	

OPERATION & APPLICATIONS

The balance can be configured to operate in various Application modes. Touch the top left button in the Application area to choose the mode.

The Scout STX Balance incorporates the following Applications:

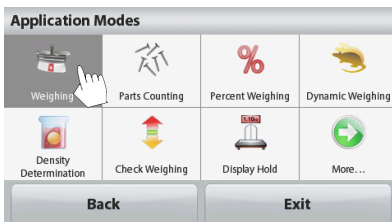
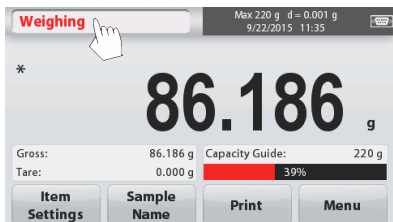

Weighing

1. Select **Weighing** (this application is the default).
2. Press **Tare** or **Zero** if necessary to begin.
3. Place objects on the pan to display the weight. When stable, the * appears. The resulting value is displayed in the main Weighing Line in the active unit of measure.

MENU & SCREEN NAVIGATION

All menu navigation is performed by touching the display. To enter the Menu, touch **Menu** from any Application Home screen. The Main menu appears, with buttons for **Back** and **Exit**. Continue touching the appropriate list item to navigate to the Menu items or touch a button to change location.

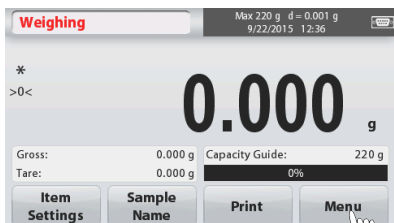

Calibration:

Touch to view calibration options.



Balance Setup:

Touch to view balance settings.



Weighing Units:

Touch to view weighing units.



Data Maintenance:

Touch to view data maintenance options.



Communication:

Touch to view COM Device Settings and Print Settings.



GLP and GMP Data:

Insert user data for traceability.



Factory Reset:

Touch to do a Factory reset.



Lockout:

Touch to access the Lockout menu list.

ADDITIONAL FEATURES

● **Connecting the Interface**

Use an optional interface connectivity kit to connect the balance either to a computer, printer or OHAUS auxiliary display.

Interface connection on the rear of the balance:

Below Interface kit accessories are available:
RS232, USB Host, USB Device, Ethernet,
Bluetooth*.

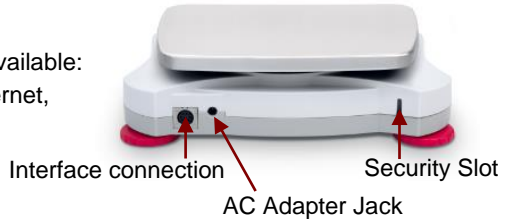

* Interface kits may vary according to local regulations



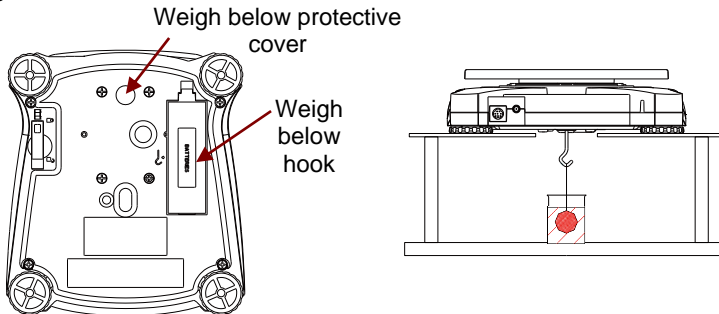

● **Weigh Below Hook**

The weigh below hook is located at the reverse side of the battery cover as shown. To use this feature, remove the red protective cover underneath for the weigh below opening.



COMPLIANCE

Compliance to the following standards is indicated by the corresponding mark on the product.

Mark	Standard
	This product complies with the EU Directives 2014/30/EU (EMC), 2014/35/EU (LVD) and 2014/31/EU (NAWI). The EU Declaration of Conformity is available online at www.ohaus.com/ce .
	This product complies with the EU Directive 2002/96/EC (WEEE). Please dispose of this product in accordance with local regulations at the collecting point specified for electrical and electronic equipment. For disposal instructions in Europe, refer to www.ohaus.com/weee .
	AS/NZS 61000.6.1, AS/NZS 61000.6.3
	CAN/CSA-C22.2 No. 61010-1 UL Std. No. 61010-1

INSTRUCTION MANUAL

For more detailed information about the balance, please refer to the product instruction manual. The instruction manual can be obtained either by scanning the QR code or by going to the product page and from there download it.

Go to www.ohaus.com to register your product's warranty.

Product Page:

<http://www.ohaus.com/>

QR Code:



DESEMBALAJE





Retire cuidadosamente del embalaje la balanza Scout y cada uno de sus componentes. Guarde el material de embalaje en un lugar seguro para transportar la balanza posteriormente.

- Balanza
- Guía de inicio rápido
- Tarjeta de garantía
- Adaptador de CA y enchufe
- Plato
- Masa de calibración (solo para modelos de hasta 620 g de capacidad)
- Cubierta para apilado y almacenamiento (no aplicable a los modelos de 1 mg)

SELECCIÓN DEL LUGAR DE INSTALACIÓN

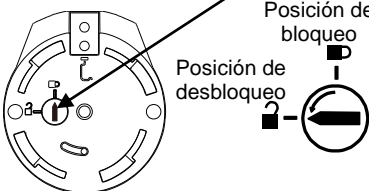
Coloque la balanza sobre una superficie firme y con suficiente espacio. Evite el exceso de corrientes de aire, vibraciones, fuentes de calor o cambios bruscos de temperatura.

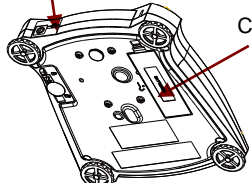
PREPARACIÓN PARA EL USO

<p>Paso 1</p>	<p>Libere el bloqueo de transporte de color rojo ubicado en la sub-plataforma de la balanza</p> <p>Gire el puntero 90° en sentido antihorario.</p>	<p>Puntero de bloqueo de transporte</p>  <p>Posición de bloqueo</p> <p>Posición de desbloqueo</p>
<p>Paso 2</p>	<p>Instale el plato</p> <p><i>Plato rectangular:</i> Coloque el plato diagonalmente sobre la sub-plataforma y gire en sentido antihorario hasta que encaje.</p> <p><i>Plato redondo:</i> Colóquelo derecho hacia abajo sobre la sub-plataforma.</p>	
<p>Paso 3</p>	<p>Conecte la alimentación</p> <p>Conecte el adaptador de CA al conector de entrada de la balanza.</p> <p><i>Instalación de las baterías</i></p> <p>Instale las cuatro baterías "AA" (LR6, no incluidas) con la polaridad que se indica en el compartimento de baterías.</p>	<p>Conector de entrada de adaptador de CA</p>  <p>Compartimento de baterías</p>
<p>Paso 4</p>	<p>Nivele la balanza</p> <p>Nivele la balanza antes del uso ajustando las patas hasta que la burbuja de aire esté centrada</p>	

PRECAUCIONES DE SEGURIDAD





PRECAUCIÓN: Lea todas las advertencias de seguridad antes de instalar, hacer conexiones o efectuar reparaciones en este equipo. El incumplimiento de estas advertencias puede causar lesiones personales y/o daños a la propiedad. Conserve todas las instrucciones para referencia futura.

- Compruebe que el voltaje de la alimentación de CA local esté dentro del rango de entrada impreso en la etiqueta de especificaciones del adaptador de CA.
- Solo conecte el adaptador de CA a una toma compatible con conexión de tierra.
- Posicione el instrumento de tal forma que el adaptador de CA se pueda desconectar fácilmente de la toma de alimentación.
- Posicione el cable de alimentación de manera que no obstaculice el tránsito de las personas o cree un peligro de tropiezos.
- Utilice el equipo solo bajo las condiciones ambientales especificadas en las instrucciones del usuario.
- No opere el equipo en entornos peligrosos o explosivos.
- Desconecte el equipo de la red eléctrica antes de realizar una limpieza o un mantenimiento.
- La reparación del equipo solo debe ser realizada por personal autorizado.

CONTROLES

Funciones de los botones



	<p>Pulsación breve: Enciende la balanza; Si la balanza está encendida, ajusta el cero</p> <p>Pulsación larga: Apaga la balanza</p>
	<p>Tara</p>

• Pantalla de aplicación principal

Esta balanza utiliza una pantalla táctil, áreas *táctiles* y *botones* para control las funciones de la balanza.

Aplicación

Stability (*), Net (NET), Gross (G) y/o indicadores de centro de cero (>0<)

Campos de referencia

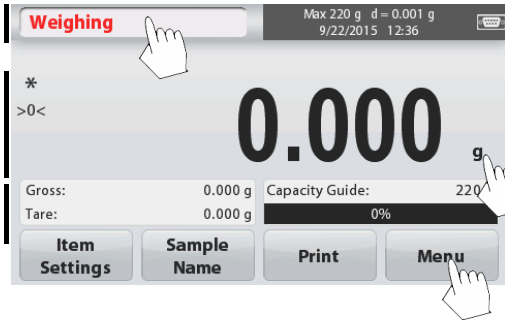

Capacidad y legibilidad



Campo de resultado: La información varía según la aplicación

Toque **g** para cambiar la unidad

Botones de aplicación: Las funciones varían según la aplicación

CALIBRACIÓN

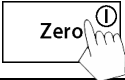
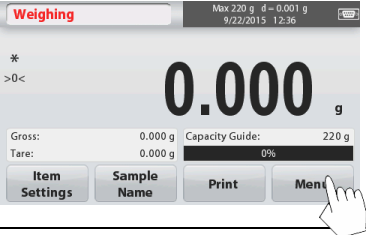
Con la balanza apagada:

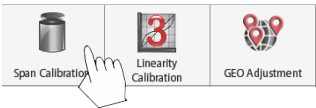
Paso 1	Despeje el plato.	
Paso 2	Encienda la balanza	
Paso 3	Presione Menu	
Paso 4	Presione Calibration	
Paso 5	Seleccione el método de calibración preferido.	
Paso 6	Siga las instrucciones en la pantalla.	

OPERACIÓN Y APLICACIONES

La balanza puede configurarse para operar en diversos modos de aplicación. Toque el botón superior izquierdo en el área de aplicación para seleccionar el modo.

La balanza Scout STX incorpora las siguientes aplicaciones:

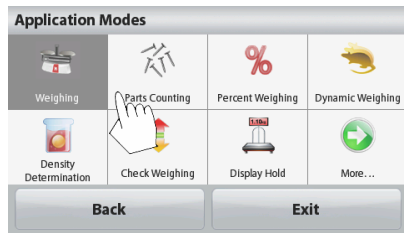
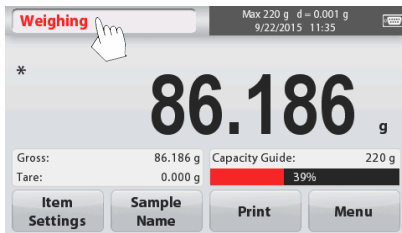
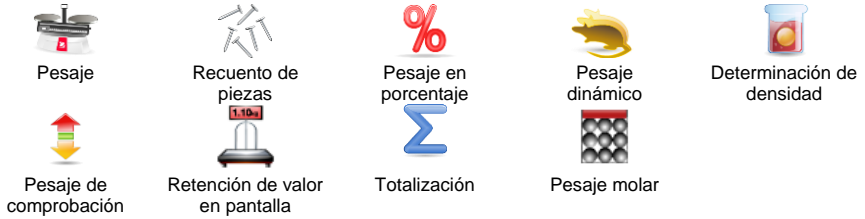

NAVEGACIÓN EN MENÚ Y PANTALLA

Toda la navegación en el menú se realiza tocando la pantalla. Para acceder al menú, toque **Menu** en cualquier pantalla de inicio de aplicación. Aparece el menú principal, con botones para **Volver atrás (Back)** y **Salir (Exit)**. Continúe tocando el elemento apropiado en la lista para desplazarse a través de los elementos de menú o pulse un botón para cambiar de ubicación.

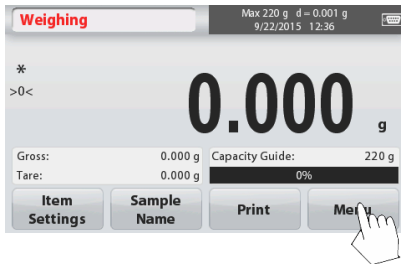

Calibración:

Toque para ver las opciones de calibración.



Configuración de la balanza:

Toque para ver la configuración de la balanza.



Unidades de peso:

Toque para ver las unidades de peso.



Mantenimiento de datos:

Toque para ver las opciones de mantenimiento de datos.



Comunicación:

Toque para ver la configuración del dispositivo COM y la configuración de impresión.



Datos GLP y GMP:

Introduzca los datos de usuario para la trazabilidad.



Restablecer valores de fábrica:

Toque para restablecer los valores de fábrica.



Bloqueo:

Toque para acceder a la lista del menú de bloqueo.

OPCIONES ADICIONALES

● **Conexión de la interfaz**

Utilice un kit de conectividad de interfaz opcional para conectar la balanza, ya sea a una computadora, a una impresora o a una OHAUS pantalla auxiliar.

Conexión de interfaz en la parte trasera de la balanza:

A continuación se indican los accesorios de kit de interfaz que están disponibles: RS232, Host USB, Dispositivo USB, Ethernet, Bluetooth*.



* Los kits de interfaz pueden variar de acuerdo a las regulaciones locales



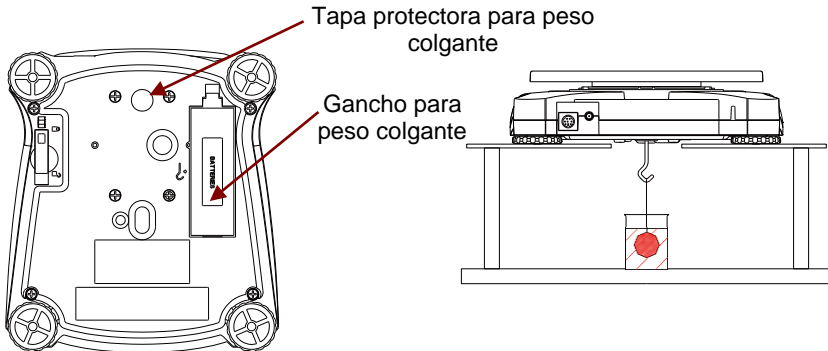

● **Gancho para peso colgante**

El gancho para peso colgante está situado en el reverso de la tapa de la batería como se muestra a continuación. Para utilizar esta función, quite la tapa protectora de color rojo debajo para acceder a la abertura del peso colgante.



CUMPLIMIENTO

El cumplimiento de las siguientes normas se indica mediante el marcado correspondiente en el producto.

Marca	Estándar
	Este producto cumple las directivas de la UE 2014/30/EU (EMC), 2014/35/EU (LVD) y 2014/31/UE (NAWI). La Declaración de Conformidad de la UE está disponible en línea en www.ohaus.com/ce .
	Este producto cumple la directiva de la UE 2002/96/EC (WEEE). Deseche este producto de acuerdo con las normativas locales en el punto de recogida indicado para los equipos eléctricos y electrónicos. Para ver las instrucciones para su desecho en Europa, consulte www.ohaus.com/wEEE .
	AS/NZS 61000.6.1, AS/NZS 61000.6.3
	CAN/CSA-C22.2 No. 61010-1 UL Std. No. 61010-1

MANUAL DE INSTRUCCIONES

Para obtener información más detallada sobre la balanza, consulte el manual de instrucciones del producto. El manual de instrucciones puede obtenerse escaneando el código QR o descargando el manual desde la página de producto de la balanza Scout STX.

Vaya a www.ohaus.com para registrar la garantía de su producto.

Página del producto:

<http://www.ohaus.com/>

Código QR:



DÉBALLAGE





Retirer avec soin la balance Scout et chacun des éléments de l'emballage. Remiser l'emballage afin de garantir un entreposage en sécurité et un transport ultérieur.

- Balance
- Masse d'étalonnage (uniquement pour les modèles jusqu'à 620 g de capacité)
- Guide de démarrage rapide
- Couverture de gerbage et d'entreposage (pas applicable pour les modèles 1 mg)
- Carte de garantie
- Adaptateur pour courant alternatif et prise de courant
- Plateau

CHOIX DE L'EMPLACEMENT

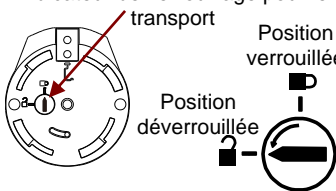
Disposer sur une surface stable avec un espace suffisant. Éviter les courants d'air excessifs, les vibrations, les sources de chaleur ou des changements rapides de température.

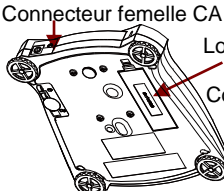
PRÉPARATION POUR L'UTILISATION

<p>Étape-1</p>	<p>Déverrouiller le verrou de transport rouge sur le socle de la balance</p> <p>Tourner l'indicateur de 90° dans le sens antihoraire.</p>	<p>Indicateur de verrouillage pour le transport</p> <p>Position verrouillée</p> <p>Position déverrouillée</p> 
<p>Étape-2</p>	<p>Installer le plateau</p> <p><i>Plateau rectangulaire</i> : Placer diagonalement sur le socle et faire pivoter dans le sens antihoraire jusqu'au verrouillage.</p> <p><i>Plateau circulaire</i> : Placer directement sur le socle.</p>	
<p>Étape-3</p>	<p>Raccorder l'alimentation électrique</p> <p>Raccorder l'adaptateur CA au connecteur femelle de la balance.</p> <p><i>Installation des piles</i></p> <p>Installer les quatre piles « AA » (LR6) (non incluses) en respectant la polarité comme indiqué dans le logement des piles.</p>	<p>Connecteur femelle CA</p> <p>Logement des piles</p> <p>Compartment</p> 
<p>Étape-4</p>	<p>Vérifier le niveau de la balance</p> <p>Vérifier le niveau de la balance avant utilisation par réglage des pieds jusqu'à centrer la bulle d'air.</p>	

MESURES DE SÉCURITÉ





ATTENTION : Lire tous les avertissements de sécurité avant d'installer, de raccorder ou d'entretenir cet équipement. Ne pas se conformer à ces avertissements peut entraîner des blessures corporelles et/ou des dommages matériels. Conserver toutes les instructions pour consultation future.

- Vérifier que la tension de l'alimentation électrique CA locale correspond à la plage d'alimentation imprimée sur l'étiquette de l'adaptateur CA.
- Uniquement raccorder l'adaptateur CA à une prise avec mise à la terre.
- Positionner l'équipement de façon à ce que l'adaptateur CA puisse facilement être débranché de la prise.
- Positionner le cordon d'alimentation de façon à ce qu'il ne représente pas un obstacle potentiel ou un risque de coupure.
- Ne faire uniquement fonctionner l'équipement que dans les conditions ambiantes décrites dans les instructions d'utilisation.
- Ne pas faire fonctionner l'équipement dans des environnements dangereux ou explosibles.
- Débrancher l'équipement de l'alimentation électrique avant nettoyage ou entretien.
- Il est nécessaire que l'entretien ne soit réalisé que par du personnel autorisé.

COMMANDES

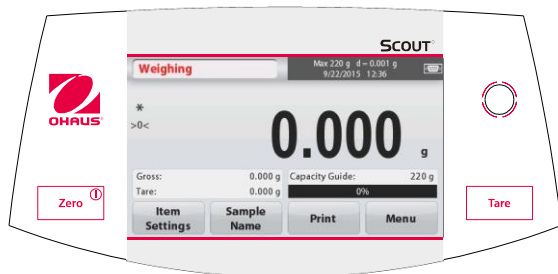
Fonctions des boutons



	<p>Zero/On <i>Pression brève :</i> Mise en service de la balance; Si la balance est sur On, remise à zéro <i>Pression longue :</i> Mise à l'arrêt de la balance</p>
	<p>Tare Tare</p>

• Écran de l'application principale

Cette balance est pourvue d'un écran tactile. De zones *tactiles* et de boutons pour commander les fonctions de la balance.

Application

Indicateurs de stabilité (*), net (NET), brut (G) et/ou de valeur zéro (>0<)

Champs de référence

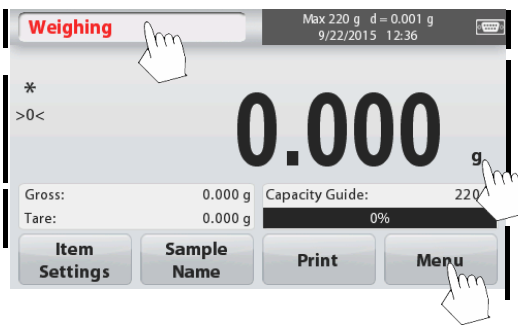



Capacité et précision de lecture

Champ de résultat:
 L'information varie selon l'application
 Toucher g de changer l'unité

Boutons d'application:
 Fonctions varient selon l'application

ÉTALONNAGE

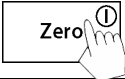
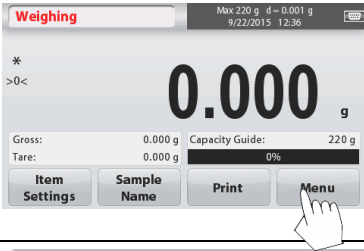
Avec la balance éteinte:

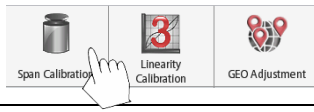
Étape-1	Nettoyer le plateau.	
Étape-2	Mettre la balance en marche	
Étape-3	Appuyer sur menu	
Étape-4	Appuyer sur étalonnage	
Étape-5	Choisir la méthode d'étalonnage préféré.	
Étape-6	Suivre les instructions à l'écran.	

FONCTIONNEMENT ET APPLICATIONS

On peut configurer la balance pour fonctionner suivant différents types d'application. Appuyer sur le bouton en haut à gauche dans la zone d'application pour choisir le mode.

La balance Scout STX comprend les applications suivantes:



Pesée



Comptage de
pièces



Pesée en
pourcentage



Pesée
dynamique



Détermination de
la densité



Pesage de
contrôle



Maintien de
l'affichage



Récapitulation



Pesée
moléculaire

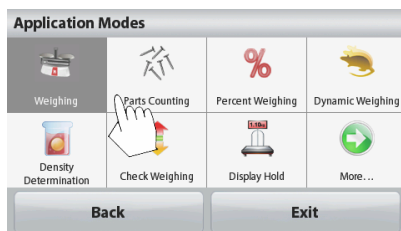

Pesée [LWE IGH]

1. Appuyer sur le bouton **Zéro/Marche** pour mettre la balance en marche.
2. Sélectionner Pesée (application par défaut) en appuyant et maintenant la touche **Mode**.
3. Appuyer **Tare** ou **Zéro** le cas échéant pour commencer.
4. Disposer les objets sur le plateau pour afficher le poids. Une fois stabilisé, le symbole * est affiché à l'écran. L'écran indique ensuite le poids de l'échantillon.

MENU ET ÉCRAN DE NAVIGATION

Toute la navigation du menu est effectuée en touchant l'écran. Pour entrer dans le menu, appuyer sur **Menu** à partir de l'écran principal d'une application. Le menu principal est affiché, avec des boutons pour **Retour** et **Sortie**. Continuer à appuyer sur l'élément approprié de la liste pour accéder aux éléments du menu ou toucher un bouton pour changer d'emplacement.

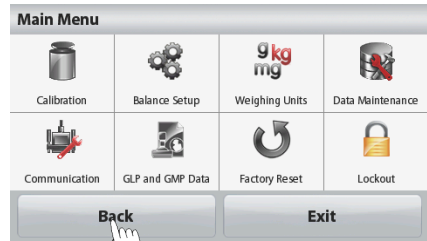

Étalonnage



Toucher pour afficher les options de calibrage.



Configuration de la balance:

Toucher pour afficher les réglages de balance.



Unités de mesure:

Toucher pour afficher les unités de mesure.



Stockage des données

Toucher pour afficher les options de maintenance de données.



Communication

Toucher pour afficher les paramètres du périphérique de communication et les paramètres d'impression.



Données GLP et GMP:

Saisir les données utilisateur pour la traçabilité.



Retour aux paramètres d'usine:

Toucher pour revenir aux paramètres d'usine.



Verrouillage:

Toucher pour accéder à la liste du menu de verrouillage.

ACCESSOIRES SUPPLÉMENTAIRES

● Interface de connexion

Utiliser une interface de connexion en option pour connecter la balance soit à un ordinateur, une imprimante ou un OHAUS écran.

Interface de connexion à l'arrière de la balance:

Ci-dessous les accessoires de l'interface de connexion disponibles :

RS232, USB Host, Clef USB, Ethernet, Bluetooth*.

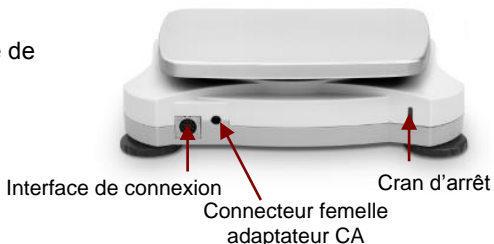

* L'interface de connexion peut varier selon les réglementations locales



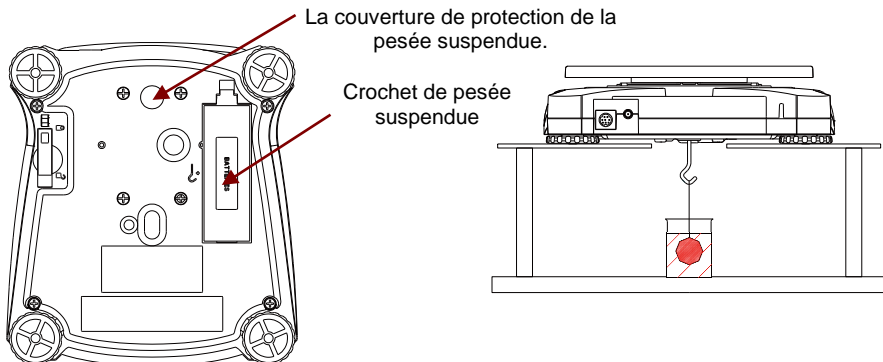

● Pesée sous crochet

La pesée sous crochet se situe sur la face opposée du capot du logement des piles comme indiqué ci-dessous. Pour utiliser cet accessoire, ôter la couverture de protection rouge pour l'ouverture de la pesée suspendue.



CONFORMITÉ

La conformité en vertu des normes suivantes est indiquée par les logos apposés sur le produit

Logo	Norme
	Le présent produit est conforme aux Directives 2014/30/UE (EMC), 2014/35/UE (LVD) et 2014/31/UE (NAWI). La déclaration de conformité UE est disponible en ligne sur le site www.ohaus.com/ce .
	Le présent produit est conforme à la Directive 2002/96/CE (WEEE). Éliminer ce produit conformément aux réglementations locales au point de collecte spécifié pour les équipements électriques et électroniques. Pour les instructions relatives à l'élimination de ce produit en Europe, se reporter au site www.ohaus.com/weee .
	AS/NZS 61000.6.1, AS/NZS 61000.6.3
	CAN/CSA-C22.2 No. 61010-1 UL Std. No. 61010-1

MANUEL D'INSTRUCTIONS

Pour de plus amples informations sur la balance, se reporter au manuel d'instructions. On peut obtenir le manuel d'instructions soit par balayage du code QR code ou en se rendant sur la page produit Scout STX pour le télécharger.

Se rendre sur www.ohaus.com pour enregistrer la garantie du produit.

Page produit:

<http://www.ohaus.com/>

QR Code:



P/N 30269067 D