

Other Lectern Sound and Non-Sound from Oklahoma Sound



Model 6010



Model #612



Model 600



MODEL # 950/901/910



MODEL #111 PLS



NON-SOUND MODEL

Model #111 or #112

Medium Qty. or

10 Qty. only

#SCL

#SCL



#SCL

For these and other OSC accessories, please contact your dealer, or:

OKLAHOMA SOUND

149 Entin Road, Clifton, NJ 07014

Tel 973-594-9000 • Fax 973-594-9339

www.oklahomasound.com • email: info@oklahomasound.com

The Vision

PRODUCT HANDBOOK









MODEL # 611

INTRODUCTION

Congratulations!!! On your purchase of the Model 611 Lectern. The perfect lectern that provides a sleek modern look along with a commanding presence. This beautifully handcrafted lectern is built with a 3/4-inch stain and scratch resistant wood grain thermofused melamine laminate on MDF. The unit is equipped with two shelves for ample storage and moves easily with four concealed casters, two locking and two non-locking.

Hardware included:

- 4 Casters (2 Locking– 2 Non-locking) 
- 10 Cam Locks 
- 10 Cam Bolts 
- 6 L Brackets 
- 40 Black #8 Screws (24 for the “L” bracket) 
(16 for the casters)
- 4 Shelf supports for the adjustable shelf 

Tools Needed:

- Phillip Screwdriver 

Dimensions

Overall.....46H” X 24”W X 21”D
 Interior shelf.....14.5”D X 23”W
 Screen.....15inch
 Weight.....97LBS

Hardware Assembly:

1. Begin by laying out all the panels on a clean soft surface with the pre-drilled holes facing up. Insert all cam locks and cam bolts. Be sure to insert the cam locks with the small arrow facing toward the opening on the side of the panel for the cam bolt to be inserted easily. (See diagram 1)

Diagram 1

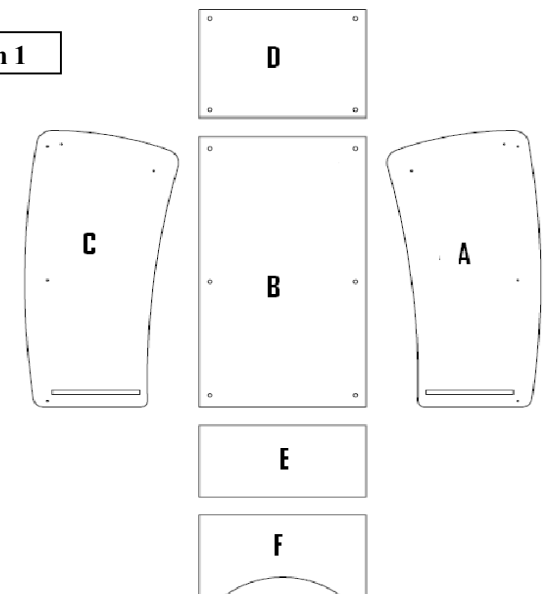

2. On the “BOTTOM PANEL (F)” screw in the four casters. The locking casters should be screwed into the predrilled holes closest to the shaped finished edge, The second pair of non-locking casters should be screwed into the predrilled holes closest to the unfinished edge.

3. Screw the 6 L braces to the bottom panel F into the pre-drilled holes. There should be two on each side and two on the back.

Assembly of Lectern:

1. The first step is to align the holes on the edge of the panel B with the three cam bolts on the side panel A. Insert the front panel gently until the panel is completely flush with panel A and tighten the cam locks. (See diagram 2)

Diagram 2

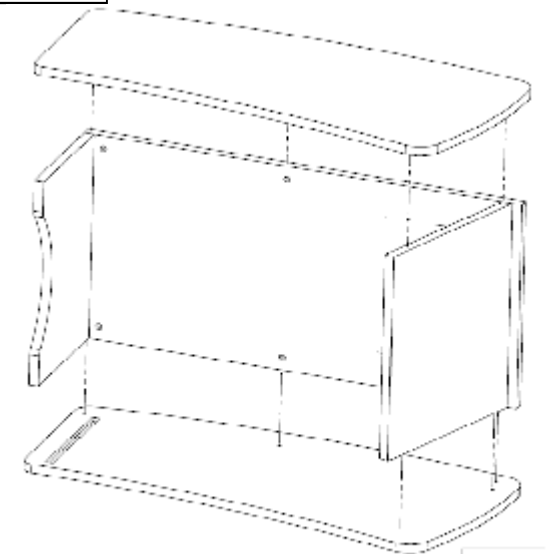

2. Continue by repeating the above procedure with Panel D.

3. Take Panel F (with the wheels towards the bottom of the unit) and insert snugly into the groove on the bottom of side panel A.

4. Proceed by aligning all the cam bolts on the left panel C with holes on the edge of panel B and D and gently insert all of the bolt into the holes and tighten the cam locks.

5. Screw the 6 L brackets on the bottom of panel F to panels A, B and C.

Go over all the cam locks and double check that they are all as tight as possible to ensure that the lectern is as stable as can be.

Congratulations you have successfully assembled your lectern!!

Caution: When rolling your lectern from room to room always do so with care by holding the unit firmly with both hands to avoid the lectern from tipping over. The unit should never be moved by a child under 12 years old.