

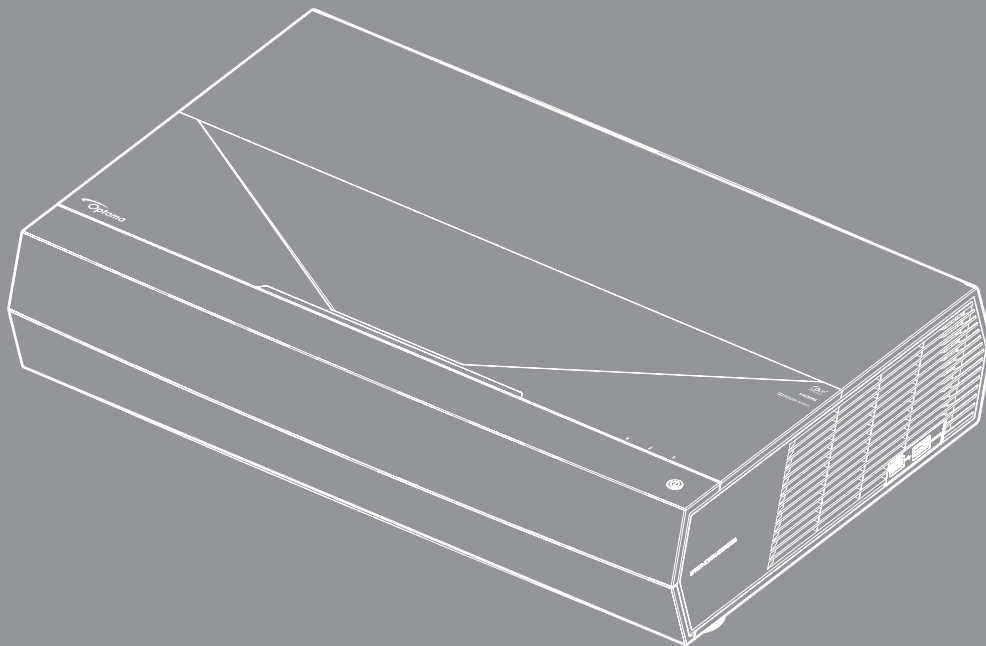

DLP® Projector



User manual

 DOLBY AUDIO

 4K ULTRA HD™

 HDMI™
HIGH-DEFINITION MULTIMEDIA INTERFACE

 DLP™
TEXAS INSTRUMENTS

 4K
UHD

 HDR
COMPATIBLE



TABLE OF CONTENTS

SAFETY	4
<i>Important Safety Instruction.....</i>	<i>4</i>
<i>Cleaning the Lens.....</i>	<i>5</i>
<i>Laser Safety Information</i>	<i>5</i>
<i>3D Safety Information.....</i>	<i>6</i>
<i>Copyright.....</i>	<i>7</i>
<i>Disclaimer.....</i>	<i>7</i>
<i>Trademark Recognition</i>	<i>7</i>
<i>FCC.....</i>	<i>7</i>
<i>Declaration of Conformity for EU countries</i>	<i>8</i>
<i>WEEE.....</i>	<i>8</i>
INTRODUCTION.....	9
<i>Package Overview.....</i>	<i>9</i>
<i>Standard accessories.....</i>	<i>9</i>
<i>Product Overview</i>	<i>10</i>
<i>Connections.....</i>	<i>11</i>
<i>Keypad and LED indicators.....</i>	<i>11</i>
<i>Remote control.....</i>	<i>12</i>
<i>Pairing your Bluetooth remote control with the projector.....</i>	<i>13</i>
SETUP AND INSTALLATION.....	14
<i>Installing the projector</i>	<i>14</i>
<i>Connecting sources to the projector.....</i>	<i>15</i>
<i>Adjusting the projector image.....</i>	<i>16</i>
<i>Remote setup</i>	<i>17</i>
USING THE PROJECTOR.....	18
<i>Powering on / off the projector.....</i>	<i>18</i>
<i>Using the projector as wireless speaker.....</i>	<i>22</i>
<i>Home screen overview.....</i>	<i>23</i>
<i>System date and time.....</i>	<i>23</i>
<i>Projector settings menu (OSD).....</i>	<i>24</i>
<i>System settings menu</i>	<i>35</i>
<i>Selecting an input source</i>	<i>45</i>
<i>Selecting an app.....</i>	<i>47</i>
<i>Supported multimedia formats.....</i>	<i>48</i>
<i>Viewing the status bar</i>	<i>53</i>
<i>About the Quick menu.....</i>	<i>53</i>

ADDITIONAL INFORMATION 54

<i>Compatible resolutions</i>	54
<i>Image size and projection distance</i>	55
<i>Remote control</i>	56
<i>Troubleshooting</i>	59
<i>LED lightning messages</i>	61
<i>Specifications</i>	63
<i>Optoma global offices</i>	64

SAFETY

	The lightning flash with arrow head within an equilateral triangle is intended to alert the user to the presence of uninsulated "dangerous voltage" within the product's enclosure that may be of sufficient magnitude to constitute a risk of electric shock to persons.
	The exclamation point within an equilateral triangle is intended to alert the user to the presence of important operating and maintenance (servicing) instructions in the literature accompanying the appliance.

Please follow all warnings, precautions and maintenance as recommended in this user's guide.

Important Safety Instruction



- Do not stare into the beam, RG2.
As with any bright source, do not stare into the direct beam, RG2 IEC 62471-5:2015.
- Do not block any ventilation openings. To ensure reliable operation of the projector and to protect from over heating, it is recommended to install the projector in a location that does not block ventilation. As an example, do not place the projector on a crowded coffee table, sofa, bed, etc. Do not put the projector in an enclosure such as a book case or a cabinet that restricts air flow.
- To reduce the risk of fire and/or electric shock, do not expose the projector to rain or moisture. Do not install near heat sources such as radiators, heaters, stoves or any other apparatus such as amplifiers that emits heat.
- Do not let objects or liquids enter the projector. They may touch dangerous voltage points and short out parts that could result in fire or electric shock.
- Do not use under the following conditions:
 - In extremely hot, cold or humid environments.
 - (i) Ensure that the ambient room temperature is within 5°C ~ 40°C (41°F ~ 104°F)
 - (ii) Relative humidity is 10% ~ 85%
 - In areas susceptible to excessive dust and dirt.
 - Near any appliance generating a strong magnetic field.
 - In direct sunlight.
- Do not use the unit if it has been physically damaged or abused. Physical damage/abuse would be (but not limited to):
 - Unit has been dropped.
 - Power supply cord or plug has been damaged.
 - Liquid has been spilled on to the projector.
 - Projector has been exposed to rain or moisture.
 - Something has fallen in the projector or something is loose inside.
- Do not place the projector on an unstable surface. The projector may fall over resulting in injury or the projector may become damaged.
- Do not block the light coming out of the projector lens when in operation. The light will heat the object and could melt, cause burns or start a fire.
- Please do not open or disassemble the projector as this may cause electric shock.
- Do not attempt to service the unit yourself. Opening or removing covers may expose you to dangerous voltages or other hazards. Please call Optoma before you send the unit for repair.
- See projector enclosure for safety related markings.
- The unit should only be repaired by appropriate service personnel.

- Only use attachments/accessories specified by the manufacturer.
- Do not look straight into the projector lens during operation. The bright light may harm your eyes.
- When switching the projector off, please ensure the cooling cycle has been completed before disconnecting power. Allow 90 seconds for the projector to cool down.
- Turn off and unplug the power plug from the AC outlet before cleaning the product.
- Use a soft dry cloth with mild detergent to clean the display housing. Do not use abrasive cleaners, waxes or solvents to clean the unit.
- Disconnect the power plug from AC outlet if the product is not being used for a long period of time.
- Do not setup the projector in places where it might be subjected to vibration or shock.
- Do not touch the lens with bare hands.
- Remove battery/batteries from remote control before storage. If the battery/batteries are left in the remote for long periods, they may leak.
- Do not use or store the projector in places where smoke from oil or cigarettes may be present, as it can adversely affect the quality of the projector performance.
- Please follow the correct projector orientation installation as non standard installation may affect the projector performance.
- Use a power strip and or surge protector. As power outages and brown-outs can KILL devices.

Cleaning the Lens

- Before cleaning the lens, be sure to turn off the projector and unplug the power cord to allow it to completely cool down.
- Use a compressed air tank to remove the dust.
- Use a special cloth for cleaning lens and gently wipe the lens. Do not touch the lens with your fingers.
- Do not use alkaline/acid detergents or volatile solvents such as alcohol for cleaning lens. If the lens is damaged due to the cleaning process, it is not covered by the warranty.

Warning

- Do not use a spray containing flammable gases to remove dust or dirt from the lens. This may cause a fire due to excessive heat inside the projector.
- Do not clean the lens if the projector is warming up as this may cause the lens' surface film to peel off.
- Do not wipe or tap the lens with a hard object.

Laser Safety Information

- This product is classified as Class 2 of IEC 60825-1 : 2007 and also complies with 21 CFR 1040.10 and 1040.11 except for deviations pursuant to Laser Notice No. 50, dated June 24, 2007.
- IEC 60825-1:2014: CLASS 1 LASER PRODUCT - RISK GROUP 2, as with any bright source, do not stare into the direct beam, RG2 IEC 62471-5:2015.
- Explanatory label is shown all information of laser power:



- This projector has built-in Class 4 laser module. Disassembly or modification is very dangerous and should never be attempted.
- Any operation or adjustment not specifically instructed by the user's guide creates the risk of hazardous laser radiation exposure.
- Do not open or disassemble the projector as this may cause damage by the exposure of laser radiation.
- Do not stare into beam when the projector is on. The bright light may result in permanent eye damage.
- When turning on the projector, make sure no one within projection range is looking at the lens.
- Without following the control, adjustment or operation procedure may cause damage by the exposure of laser radiation.
- Adequate instructions for assembly, operation, and maintenance, including clear warnings concerning precautions to avoid possible exposure to laser and collateral radiation in excess of the accessible emission limits in Class 2.

3D Safety Information

Please follow all warnings and precautions as recommended before you or your child use the 3D function.

Warning

Children and teenagers may be more susceptible to health issues associated with viewing in 3D and should be closely supervised when viewing these images.

Photosensitive Seizure Warning and Other Health Risks

- Some viewers may experience an epileptic seizure or stroke when exposed to certain flashing images or lights contained in certain Projector pictures or video games. If you suffer from, or have a family history of epilepsy or strokes, please consult with a medical specialist before using the 3D function.
- Even those without a personal or family history of epilepsy or stroke may have an undiagnosed condition that can cause photosensitive epileptic seizures.
- Pregnant women, the elderly, sufferers of serious medical conditions, those who are sleep deprived or under the influence of alcohol should avoid utilizing the unit's 3D functionality.
- If you experience any of the following symptoms, stop viewing 3D pictures immediately and consult a medical specialist: (1) altered vision; (2) light-headedness; (3) dizziness; (4) involuntary movements such as eye or muscle twitching; (5) confusion; (6) nausea; (7) loss of awareness; (8) convulsions; (9) cramps; and/ or (10) disorientation. Children and teenagers may be more likely than adults to experience these symptoms. Parents should monitor their children and ask whether they are experiencing these symptoms.
- Watching 3D projection may also cause motion sickness, perceptual after effects, disorientation, eye strain and decreased postural stability. It is recommended that users take frequent breaks to lessen the potential of these effects. If your eyes show signs of fatigue or dryness or if you have any of the above symptoms, immediately discontinue use of this device and do not resume using it for at least thirty minutes after the symptoms have subsided.

- Watching 3D projection while sitting too close to the screen for an extended period of time may damage your eyesight. The ideal viewing distance should be at least three times the screen height. It is recommended that the viewer's eyes are level with the screen.
- Watching 3D projection while wearing 3D glasses for an extended period of time may cause a headache or fatigue. If you experience a headache, fatigue or dizziness, stop viewing the 3D projection and rest.
- Do not use the 3D glasses for any other purpose than for watching 3D projection.
- Wearing the 3D glasses for any other purpose (as general spectacles, sunglasses, protective goggles, etc.) may be physically harmful to you and may weaken your eyesight.
- Viewing in 3D projection may cause disorientation for some viewers. Accordingly, DO NOT place your 3D PROJECTOR near open stairwells, cables, balconies, or other objects that can be tripped over, run into, knocked down, broken or fallen over.

Copyright

This publication, including all photographs, illustrations and software, is protected under international copyright laws, with all rights reserved. Neither this manual, nor any of the material contained herein, may be reproduced without written consent of the author.

© Copyright 2019

Disclaimer

The information in this document is subject to change without notice. The manufacturer makes no representations or warranties with respect to the contents hereof and specifically disclaims any implied warranties of merchantability or fitness for any particular purpose. The manufacturer reserves the right to revise this publication and to make changes from time to time in the content hereof without obligation of the manufacturer to notify any person of such revision or changes.

Trademark Recognition

Kensington is a U.S. registered trademark of ACCO Brand Corporation with issued registrations and pending applications in other countries throughout the world.

HDMI, the HDMI Logo, and High-Definition Multimedia Interface are trademarks or registered trademarks of HDMI Licensing LLC in the United States and other countries.

DLP®, DLP Link and the DLP logo are registered trademarks of Texas Instruments and BrilliantColor™ is a trademark of Texas Instruments.



Manufactured under license from Dolby Laboratories.

Dolby, Dolby Audio and the double-D symbol are trademarks of Dolby Laboratories.

Amazon, Alexa and all related logos are trademarks of Amazon.com, Inc. or its affiliates.

All other product names used in this manual are the properties of their respective owners and are Acknowledged.

FCC

This device has been tested and found to comply with the limits for a Class B digital device pursuant to Part 15 of the FCC rules. These limits are designed to provide reasonable protection against harmful interference in a residential installation. This device generates, uses and can radiate radio frequency energy and, if not installed and used in accordance with the instructions, may cause harmful interference to radio communications.

However, there is no guarantee that interference will not occur in a particular installation. If this device does cause harmful interference to radio or television reception, which can be determined by turning the device off and on is encouraged to try to correct the interference by one or more of the following measures:

- Reorient or relocate the receiving antenna.
- Increase the separation between the device and receiver.
- Connect the device into an outlet on a circuit different from that to which the receiver is connected.
- Consult the dealer or an experienced radio/television technician for help.

Notice: Shielded cables

All connections to other computing devices must be made using shielded cables to maintain compliance with FCC regulations.

Caution

Changes or modifications not expressly approved by the manufacturer could void the user's authority, which is granted by the Federal Communications Commission, to operate this projector.

Operation Conditions

This device complies with Part 15 of the FCC Rules. Operation is subject to the following two conditions:

1. This device may not cause harmful interference and
2. This device must accept any interference received, including interference that may cause undesired operation.

Notice: Canadian users

This Class B digital apparatus complies with Canadian ICES-003.

Remarque à l'intention des utilisateurs canadiens

Cet appareil numérique de la classe B est conforme à la norme NMB-003 du Canada.

Declaration of Conformity for EU countries

- EMC Directive 2014/30/EC (including amendments)
- Low Voltage Directive 2014/35/EC
- R & TTE Directive 1999/5/EC (if product has RF function)

WEEE



Disposal instructions

Do not throw this electronic device into the trash when discarding. To minimize pollution and ensure utmost protection of the global environment, please recycle it.

INTRODUCTION

Package Overview

Carefully unpack and verify that you have the items listed below under standard accessories. Some of the items under optional accessories may not be available depending on the model, specification and your region of purchase. Please check with your place of purchase. Some accessories may vary from region to region.

The warranty card is only supplied in some specific regions. Please consult your dealer for detailed information.

Standard accessories

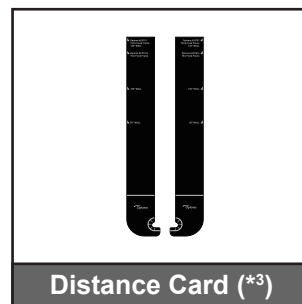
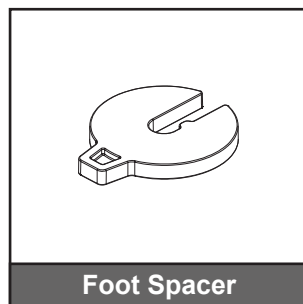
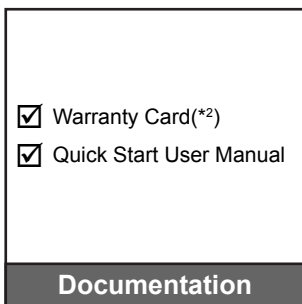
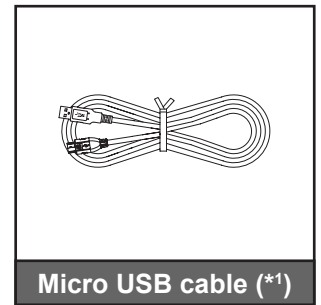
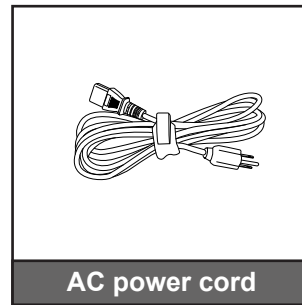
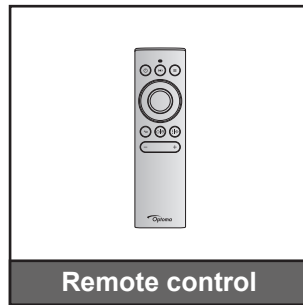
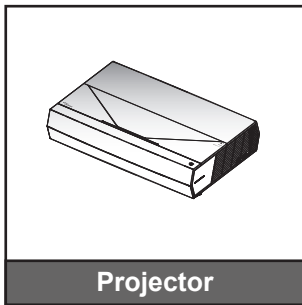

Note:

- The actual remote control may vary depending on the region.
- (*1) For remote control power charging.
- (*2) For European warranty Information, please visit www.optoma.com.
- (*3) Use the supplied Distance Cards to determine the proper distance of the projector from the projection surface. For more details, see the SmartFIT Installation Guide.



Please scan the QR code or visit the following URL: <https://www.optoma.com/support/download>

INTRODUCTION

Product Overview

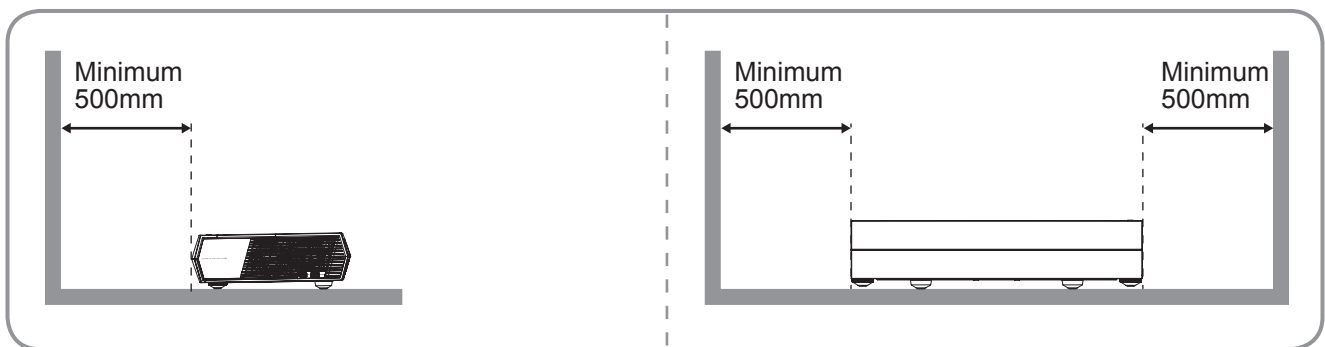
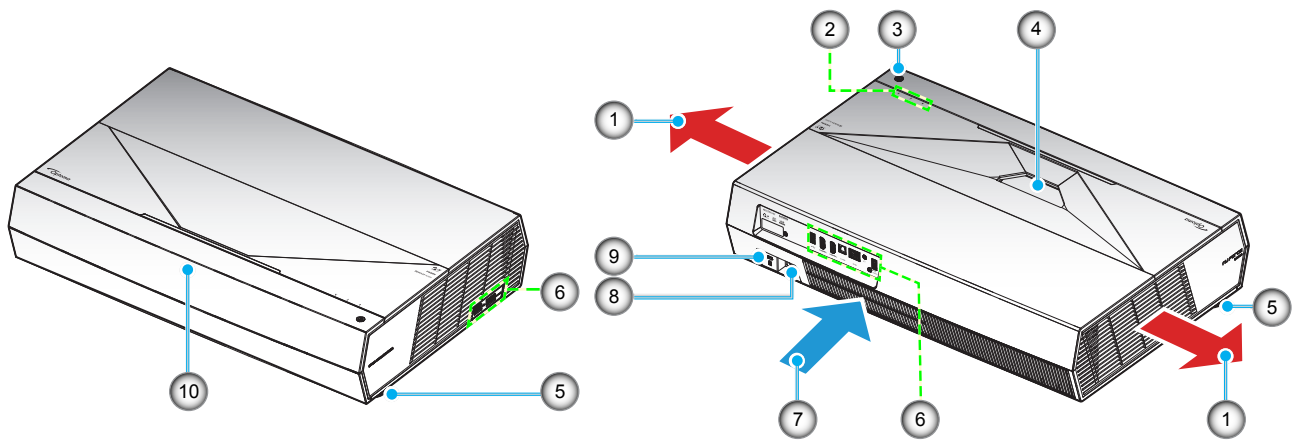

Note:

- Do not block projector intake and exhaust vents.
- When operating the projector in an enclosed space, allow at least 50cm (19") clearance around the intake and exhaust vents.

No	Item	No	Item
1.	Ventilation (outlet)	6.	Input / Output
2.	LED Indicators	7.	Ventilation (inlet)
3.	Power Button	8.	Power Socket
4.	Lens	9.	Kensington™ Lock Port
5.	Tilt-Adjustment Foot	10.	IR Receiver

INTRODUCTION

Connections

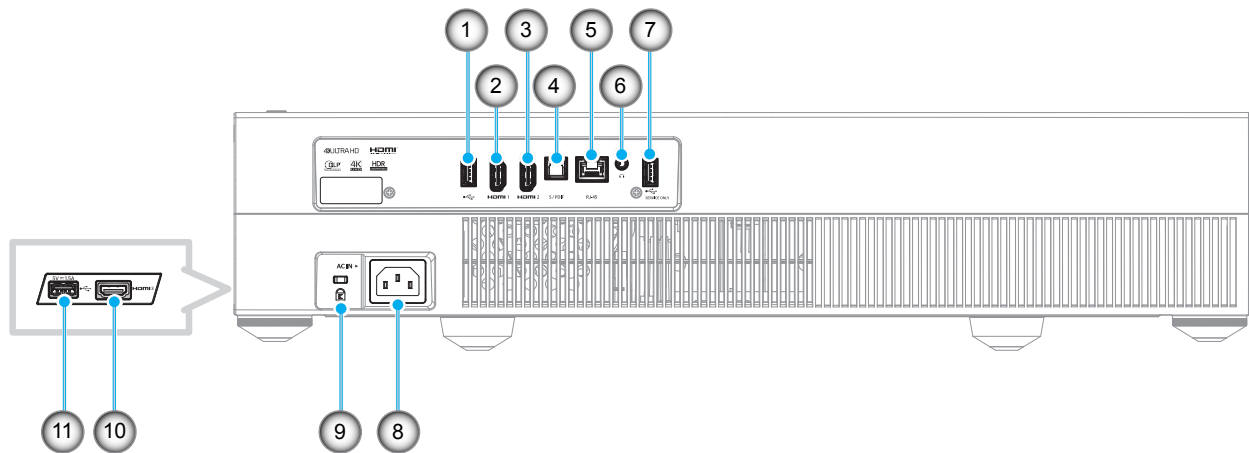

No	Item	No	Item
1.	USB 2.0 Port / USB Media Player	7.	USB2.0 Port (Service Only)
2.	HDMI 1 Port (HDMI v2.0 (ARC))	8.	Power Socket
3.	HDMI 2 Port (HDMI v2.0)	9.	Kensington™ Lock Port
4.	S/PDIF Port (Digital Output)	10.	HDMI 3 Port (HDMI v2.0)
5.	RJ-45 Port	11.	USB2.0 Port (Power 5V---1.5A)(*)
6.	Audio Out Port		

Note: (*) Not recommended for charging a cell phone.

Keypad and LED indicators

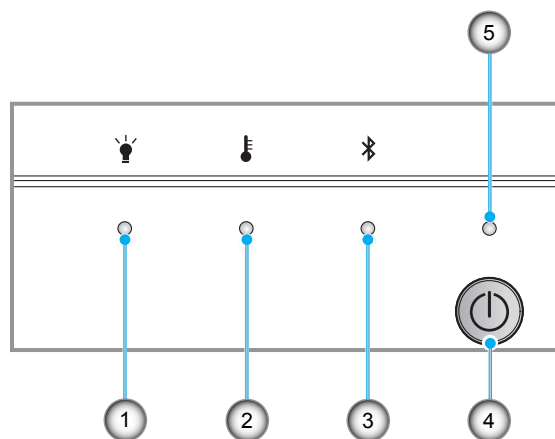

No	Item	No	Item
1.	Lamp LED	4.	Power Button
2.	Temp LED	5.	Power LED
3.	Bluetooth LED		

INTRODUCTION

Remote control

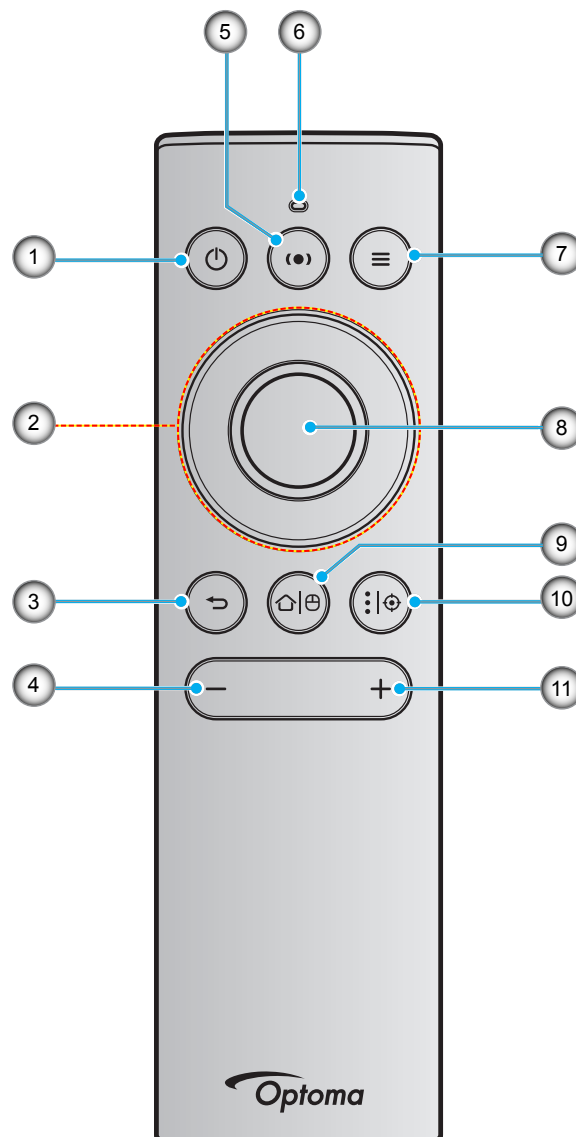

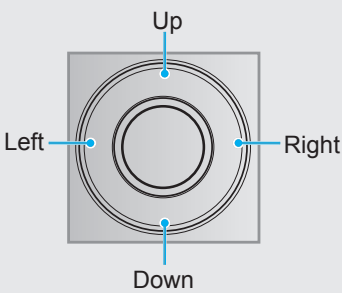

No	Item	No	Item
1.	Power On / Standby	3.	Return
2.	Four Directional Select Buttons: 	4.	Volume -
		5.	Speaker mode On
		6.	LED Indicator
		7.	Projector Menu / Quick Menu
		8.	OK
		9.	Home / Air Mouse Enable / Disable
		10.	Android App Settings / Focus
		11.	Volume +

Note: The remote control supports both infrared (IR) and Bluetooth transmissions. It can also operate as an air mouse.

INTRODUCTION

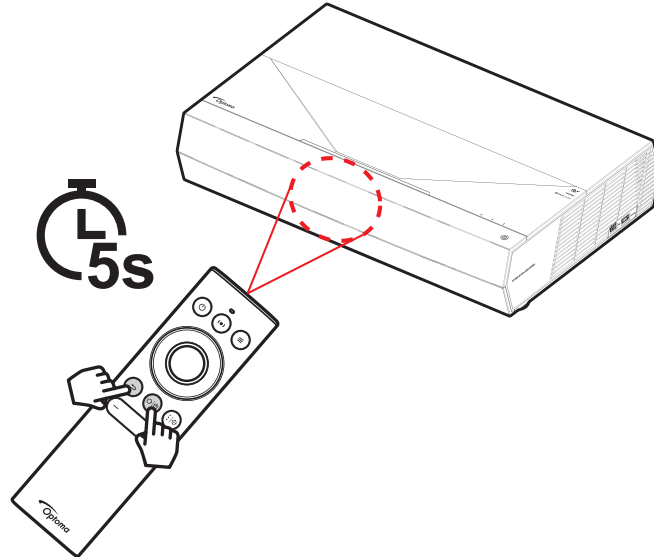
Pairing your Bluetooth remote control with the projector

Long-press the “|The diagram shows a hand holding a remote control and pressing two buttons simultaneously. A clock icon with '5s' indicates a 5-second long-press. A red dashed circle highlights the status LED on the projector, which is shown to be flashing blue.

The pairing process will take approximately 20 seconds. If the pairing is successful, the status LED on the Bluetooth remote control will turn solid blue when a button is pressed. Otherwise, the status LED on the Bluetooth remote control will turn green when a button is pressed.

If the Bluetooth remote control is left idle for 10 minutes, it will automatically enter sleep mode and the Bluetooth is disconnected.

Note:

- *The actual remote control may vary depending on the region.*
- *Some buttons may have no function for models that do not support these features.*

SETUP AND INSTALLATION

Installing the projector

Your projector is designed to be installed in one of two possible positions.

Your room layout or personal preference will dictate which installation location you select. Take into consideration the size and position of your screen, the location of a suitable power outlet, as well as the location and distance between the projector and the rest of your equipment.

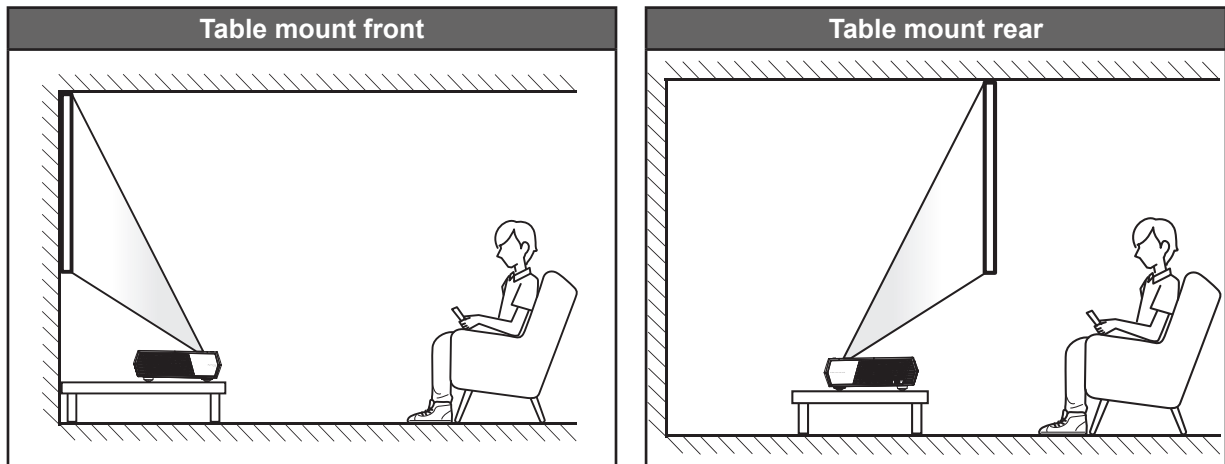

- How to determine projector location for a given screen size, please refer to distance table on page 55.
- How to determine screen size for a given distance, please refer to distance table on page 55.

Note:

- *The further away the projector is placed from the screen the projected image size increases and vertical offset also increases proportionally.*
- *The vertical offset may vary between projectors, due to the limitations of optical manufacturing. Additional adjustments may occur when switching projectors.*

IMPORTANT!

Do not operate the projector in any orientation other than table top. The projector should be horizontal and not tilted either forwards/backwards or left/right. Any other orientation will invalidate the warranty and may shorten the lifetime of the projector itself. For none standard installation advise please contact Optoma.

SETUP AND INSTALLATION

Connecting sources to the projector

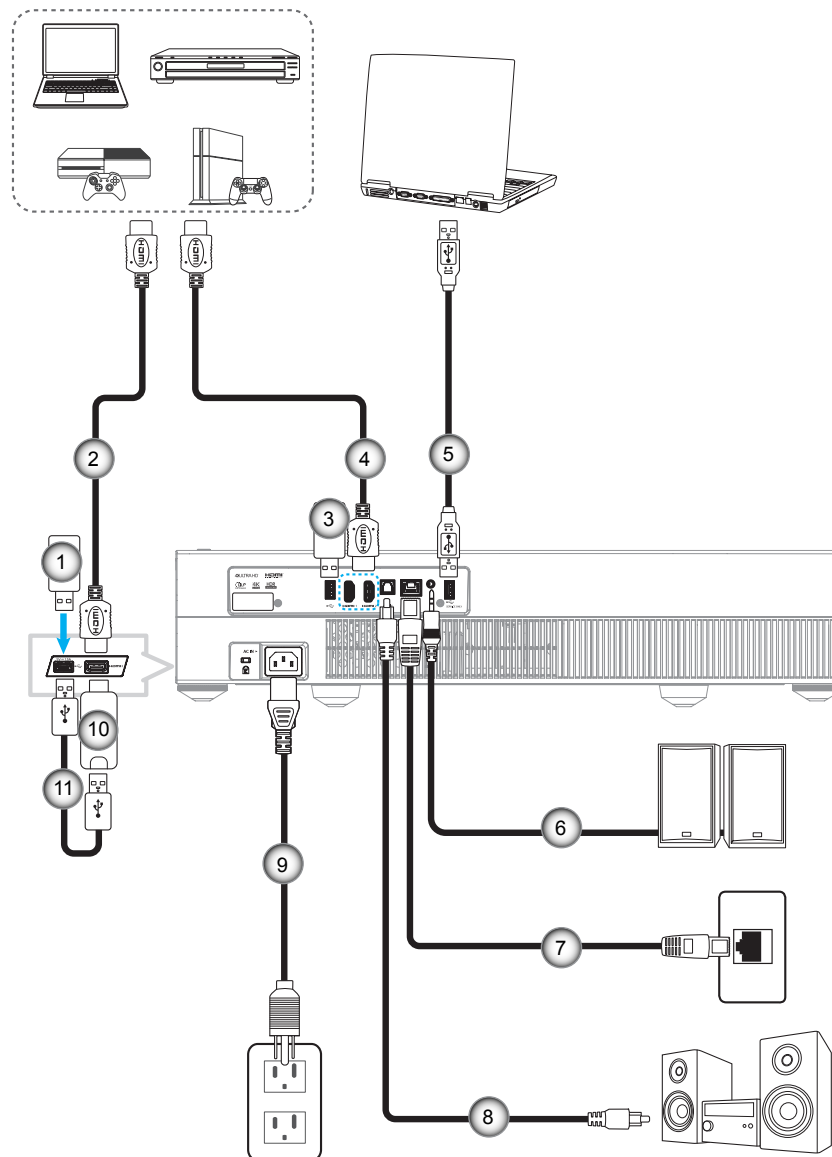

No	Item
1.	USB Flash Drive
2.	HDMI Cable
3.	USB Flash Drive
4.	HDMI Cable

No	Item
5.	USB Cable (Service only / DDP FW upgrade)
6.	Audio Out Cable
7.	RJ-45 Cable (for Internet)
8.	S/PDIF Out Cable

No	Item
9.	Power Cord
10.	HDMI Dongle
11.	USB Power Cable

Note: You can connect a USB mouse or keyboard to the USB port.

SETUP AND INSTALLATION

Adjusting the projector image

Image height

The projector is equipped with elevator feet for adjusting the image height.

1. Locate the adjustable foot you wish to adjust on the underside of the projector.
2. Rotate the adjustable foot clockwise or counterclockwise to raise or lower the projector.

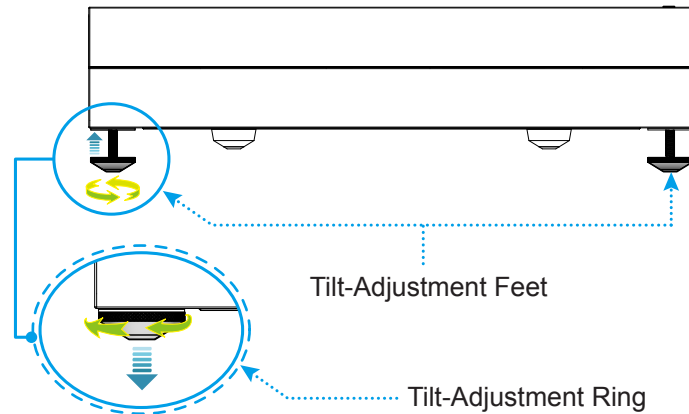

Note: If you want to level the projector, rotate the adjustable feet and attach a foot spacer to both feet. Then tighten the feet.

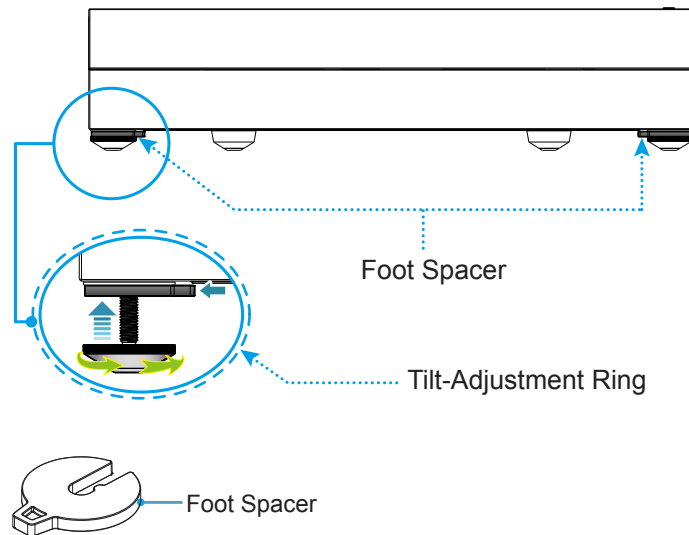

SETUP AND INSTALLATION

Remote setup

Charging the remote control

To charge the remote control, connect one end of the micro USB cable to the USB port on the bottom of the remote control and the other end to a USB port of a device that supports charging. For example, to the USB 2.0 port on the side of the projector.

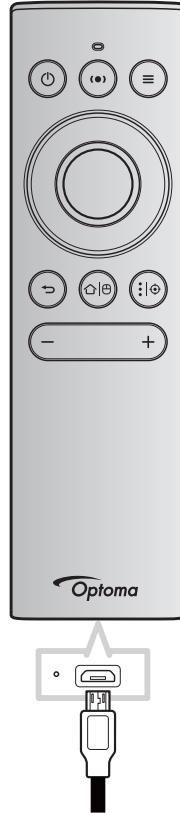

CAUTION:

To ensure safe operation, please observe the following precautions:

- Avoid contact with water or liquid.
- Do not expose the remote control to moisture or heat.
- Do not drop the remote control.

Note:

- We recommend not to use the remote control while it is being charged.
- The remote control will automatically enter sleep mode after 10 minutes of inactivity.
- To wake the remote control, press on any of its buttons. Pressing the button only wakes the remote control but does not perform the associated function. To perform the associated function, press the button again.

About the air mouse

- To enable or disable air mouse, long press “**Home**”.

Note: The air mouse function is automatically disabled when the projector is in sleep mode or when you press the “**Up**”, “**Down**”, “**Left**”, or “**Right**” button.

- Charge the remote control when the battery power drops below 20% and the LED indicator starts flashing red.
- While charging, the LED indicator will show a solid red light. When charging is completed, the LED indicator will show a solid green light.

Note: The battery is fully charged in about 1.5h. The capacity of the battery is 250mAh (0.925Wh).

USING THE PROJECTOR

Powering on / off the projector

Powering on

1. Connect one end of the AC power cord to the power socket on the projector and the other end to the electrical outlet. When connected, the power LED will turn red.
2. Turn on the projector by pressing the “⏻” either on top of the projector or on the remote control.

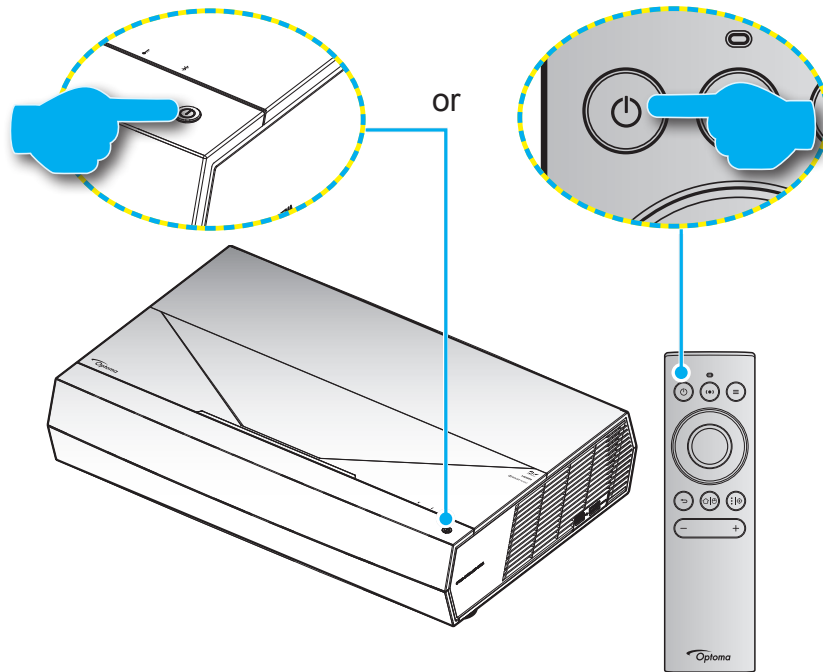

During startup the power LED is flashing white and during normal operation, the power LED is solid white.

Note: If the Power Mode (Standby) is set to “Eco” then the projector is powered on using the infrared signal from the remote control. If the Power Mode (Standby) is set to “SmartHome” then the projector is powered on using the Bluetooth signal from the remote control.

USING THE PROJECTOR

Effective range

Infra-Red (IR) remote control sensor is located on the front of the projector. Ensure to hold the remote control at an angle within $\pm 15^\circ$ perpendicular to the projector's IR remote control sensor to function correctly. The distance between the remote control and the sensor should not be longer than 7 meters (~22 feet).

You can also operate the remote control by pointing it to the projected image.

Note: When pointing the remote control directly (0 degrees angle) on the IR sensor, the distance between the remote control and the sensor should not be longer than 10 meters (~32 feet).

- Make sure that there are no obstacles between the remote control and the IR sensor on the projector that might obstruct the infra-red beam.
- Make sure the IR transmitter of the remote control is not being shined by sunlight or fluorescent lamps directly.
- Please keep the remote controller away from fluorescent lamps for over 2 meters or the remote controller might become malfunction.
- If the remote control is close to Inverter-Type fluorescent lamps, it might become ineffective from time to time.
- If the remote control and the projector are within a very short distance, the remote control might become ineffective.
- For Bluetooth pairing, after powering on the projector, make sure to aim the remote control to the area marked with a red circle on the image below.
- If the standby Power Mode is set to "Eco", after powering on the projector, make sure to aim the remote control to the IR receiver directly.

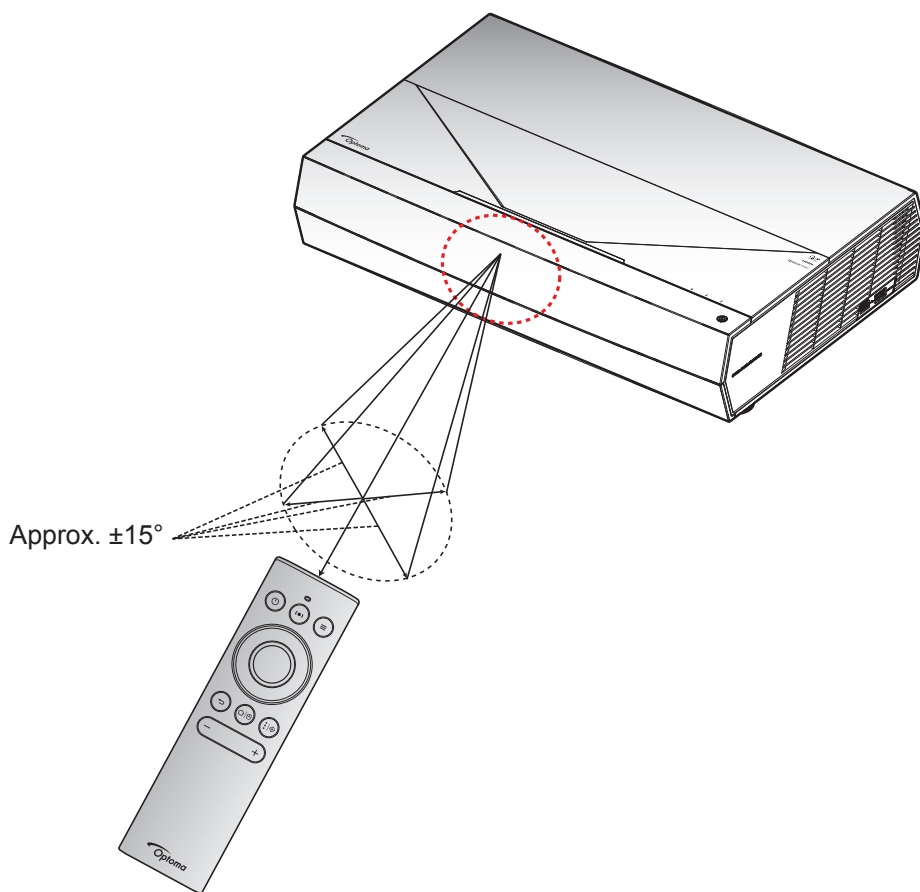

USING THE PROJECTOR

The first time the projector is turned on, you will be prompted to do the initial setup including selecting the projection orientation, preferred language, configuring network settings, and more. Once the **Setup Complete!** screen appears, it indicates the projector is ready to use.

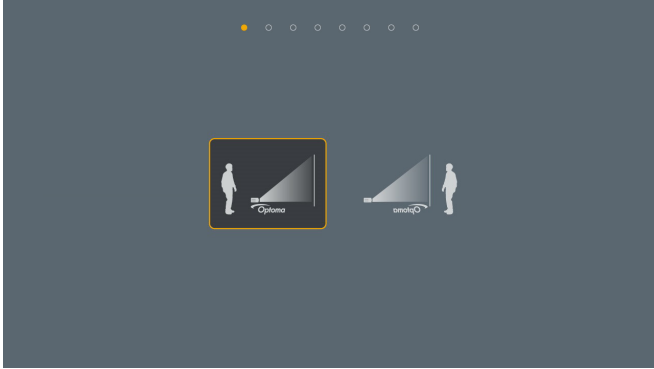

[Projection screen]



[Language screen]

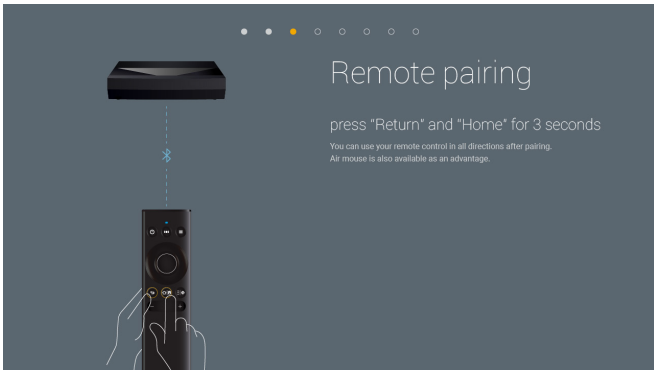

[Remote pairing screen]

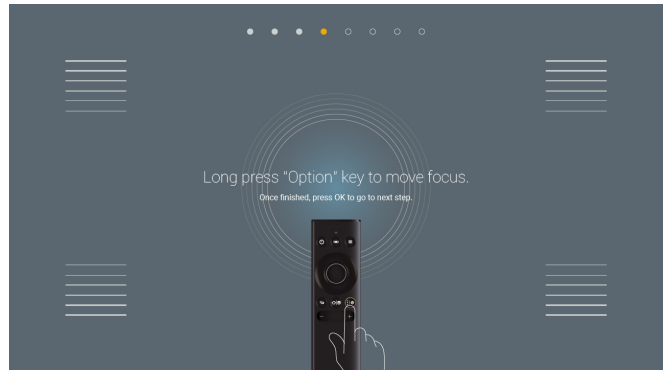

[Remote pairing screen (continued)]

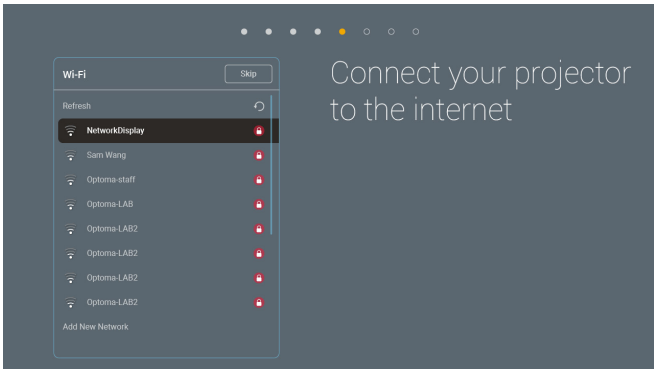

[Network screen]

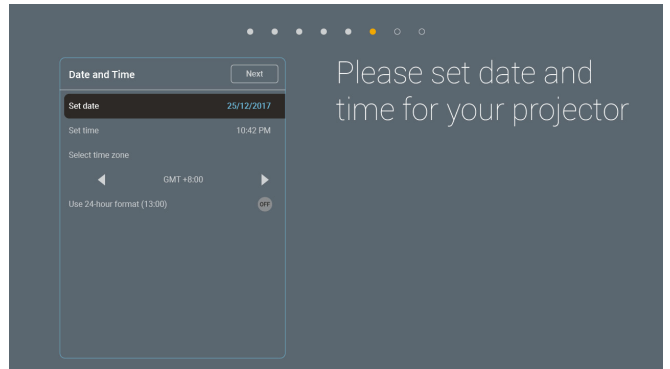

[Date and time screen]

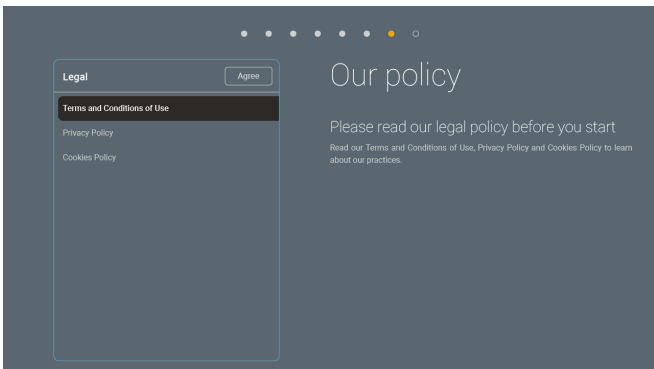

[Regulation screen]

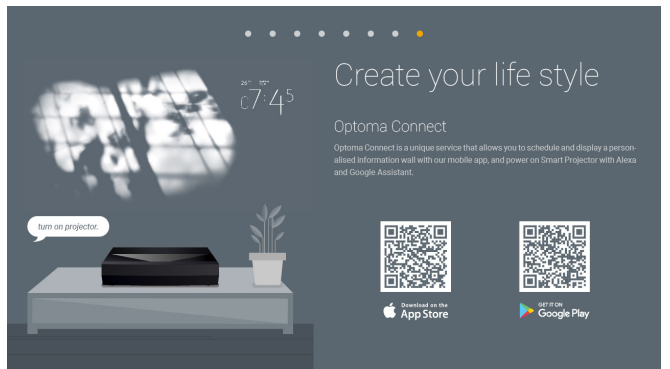

[Optoma Connect screen]

USING THE PROJECTOR

Powering off

1. Turn off the projector by pressing the “⏻” button either on top of the projector or on the remote control. The following message will be displayed:

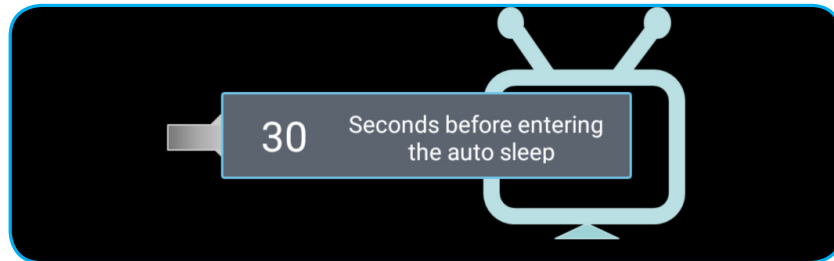

2. The cooling fans will continue to operate for about 10 seconds for the cooling cycle and the power LED is flashing white. When the power LED turns red, this indicates the projector has entered standby mode. If you wish to turn the projector back on, you must wait until the cooling cycle has finished and the projector has entered standby mode. When the projector is in standby mode, simply press the “⏻” button either on top of the projector or on the remote control again to turn on the projector.
3. Disconnect the power cord from the electrical outlet and the projector.

Note:

- *It is not recommended that the projector is turned on immediately, right after a power off procedure.*
- *By default, the projector turns off automatically after 20 minutes of inactivity. You can modify the idle time length in “Auto Power off (min.)” menu in “System Settings → Power”. If you want the projector to enter sleep mode instead, disable auto power off and set the sleep time interval in “System Settings → Power → Sleep Timer (min.)”.*
- *To turn off the projector immediately, press the “⏻” button twice either on top of the projector or on the remote control.*

USING THE PROJECTOR

Using the projector as wireless speaker

With the built-in Bluetooth module, you can listen to your music wirelessly from your phone, tablet PC, or other Bluetooth-enabled device.

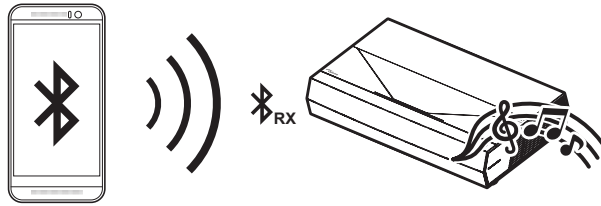

Note: The projector and Bluetooth device only need to be paired once. After pairing, the projector will automatically connect the Bluetooth device upon each power on cycle. If the Bluetooth device is not powered on, the projector will not connect to the device.

Pairing your Bluetooth device with the projector

1. Set the projector standby power mode to “Smart Home” in “System Settings → Power menu → Power Mode (Standby)”.
2. Short press the “(●)” button on the remote control to toggle the projector into Speaker mode.



3. While pairing your Bluetooth device with the projector, the Bluetooth LED indicator on the projector is flashing white.
4. On your Bluetooth device, tap **Settings** and enable the Bluetooth function. Then search for the projector.

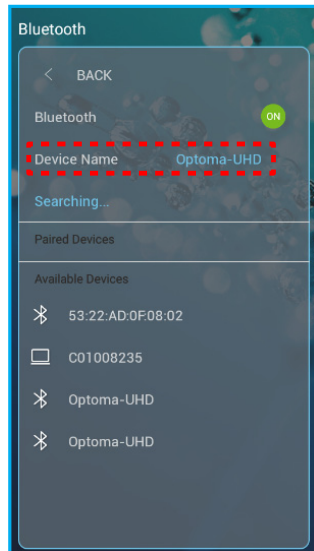

5. Tap on the projector name and start pairing.
6. After successful pairing, the projector will show a solid white light.
7. On your Bluetooth device, browse and select the song to play. You can use the “—” and “+” button on the remote control to adjust the volume level.

Note:

- The projector can store pairing information of up to 10 devices. However, only one Bluetooth device can be connected at a time.
- Make sure the distance between your Bluetooth device and the projector is less than 10 meters.

USING THE PROJECTOR

Home screen overview

The Home screen is displayed every time you start the projector. It contains system date and time, system status, icons to access OSD menu, projector settings menu, apps, input sources, and more.

To navigate the Home screen, simply use the buttons on the remote control.

You can return to the Home screen at any time by pressing “|” on the remote control, regardless of your position in the user interface.

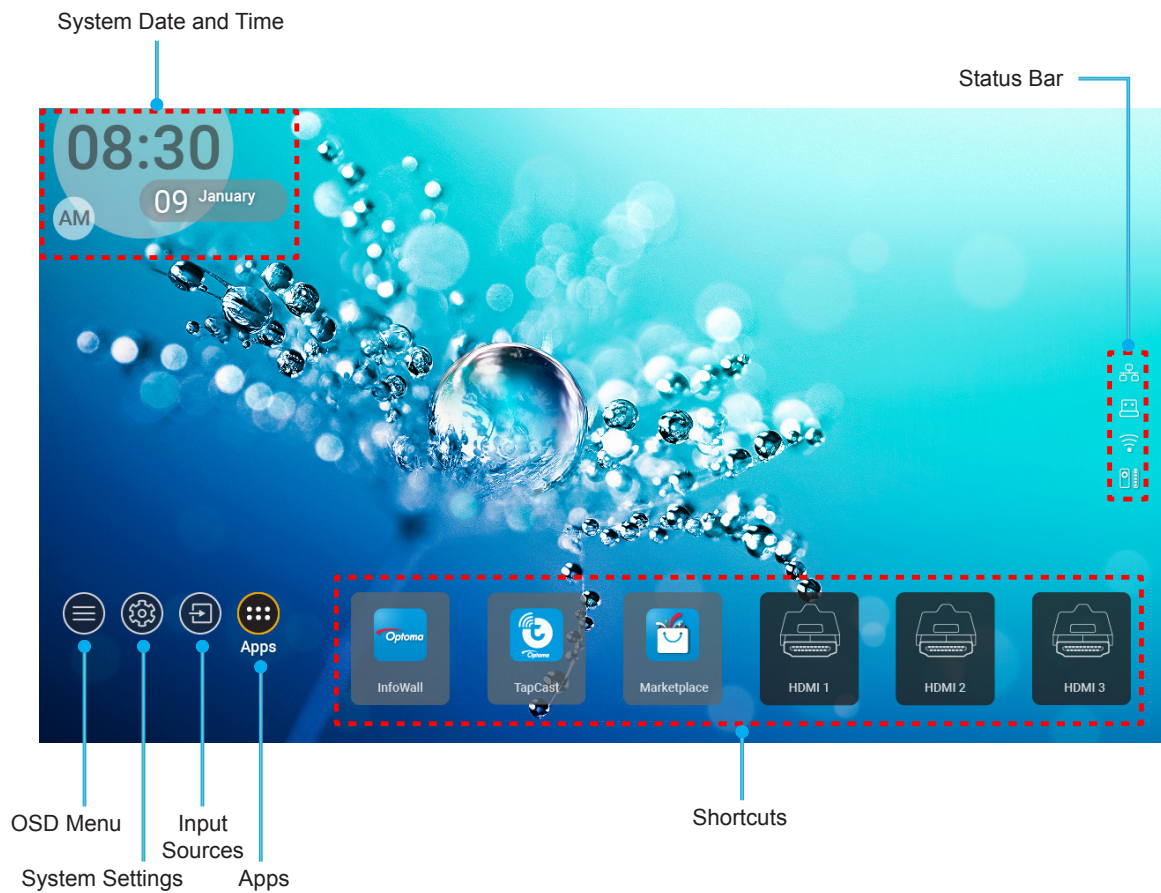

Note: The selected menu or item is highlighted in orange color, for example “Apps” on the image above.

System date and time

Date and time is displayed on the Home screen if the projector is connected to the network. The default setting is 10:00am, 2019/01/01. AM/PM will appear only if the 24-hour format is off.

To modify date and time parameters, select the respective field on the screen. The Date and Time settings page opens automatically. Then perform the modifications.

USING THE PROJECTOR

Projector settings menu (OSD)

Press “≡” on the remote control or on the Home screen, select the OSD menu “⊞” to review projector information or manage various settings related to the image, display, 3D, audio, and setup.

General menu navigation

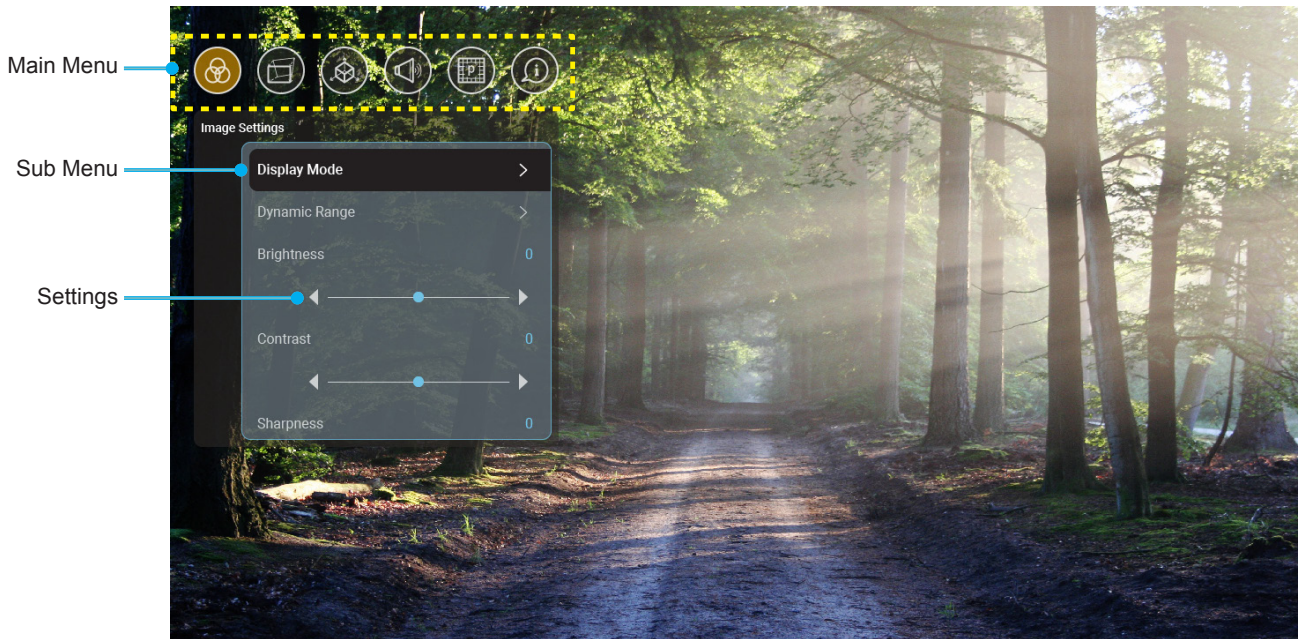

1. When OSD is displayed, use the up and down navigation buttons to select any item in the main menu. While making a selection on a particular page, press “OK” to enter submenu.
2. Press the “Left” and “Right” button to select the desired menu item. Then press “OK” to open its sub menu.
3. Press the “Up” and “Down” button to select the desired item in the sub menu.
4. Press the “OK” button to enable or disable a setting or press the “Left” and “Right” button to adjust a value.
5. Select the next item to be adjusted in the sub menu and modify as described above.
6. To exit, press “←” (repeatedly if necessary). The OSD menu will close and the projector will automatically save the new settings.

USING THE PROJECTOR

OSD Menu tree

Note: The OSD menu appears in the same language as the system. If needed, change the language in the System Settings menu.

Level 1	Level 2	Level 3	Level 4	Value	
Image Settings	Display Mode			Cinema	
				HDR	
				HLG	
				HDR SIM.	
				Game	
				Reference	
				Bright	
				User	
				3D	
				ISF Day	
				ISF Night	
				ISF HDR	
				ISF HLG	
			ISF 3D		
	Dynamic Range	HDR/HLG			Auto [Default]
					Off
		HDR Picture Mode			Bright
					Standard
					Film
			Detail		
	Brightness				-50 ~ +50
	Contrast				-50 ~ +50
	Sharpness				1 ~ 15
	Color				-50 ~ +50
	Tint				-50 ~ +50
	Gamma		Film		
			Video		
			Graphics		
			Standard(2.2)		
			1.8		
			2.0		
			2.4		
	Color Settings		BrilliantColor™		1 ~ 10
			Color Temperature		Warm
					Standard
					Cool
				Cold	



USING THE PROJECTOR

Level 1	Level 2	Level 3	Level 4	Value
Image Settings	Color Settings	Color Matching	Color	R [Default]
				G
				B
				C
				Y
				M
				W
		Hue	-50 ~ +50 [Default:0]	
		Saturation	-50 ~ +50 [Default:0]	
		Gain	-50 ~ +50 [Default:0]	
		Reset	Cancel [Default]	
			Yes	
		Exit		
		RGB Gain/Bias	Red Gain	-50 ~ +50
	Green Gain		-50 ~ +50	
	Blue Gain		-50 ~ +50	
	Red Bias		-50 ~ +50	
	Green Bias		-50 ~ +50	
	Blue Bias		-50 ~ +50	
	Reset		Cancel [Default]	
			Yes	
	Exit			
	Brightness Mode			DynamicBlack 1
				DynamicBlack 2
				DynamicBlack 3
				Power (Power = 100%/ 95%/ 90%/ 85%/ 80%/ 75%/ 70%/ 65%/ 60%/ 55%/ 50%)
PureMotion			Off	
			1	
			2	
		3		
Reset		Cancel		
		Reset		
Display	Geometric Correction	Warp Control	Off [Default]	
			On	
		Warp Calibration	Press “Up” / “Down” / “Left” / “Right” to focus the point and press “OK” to select the point. Then press “Up” / “Down” / “Left” / “Right” to shift the selected point location. [Default: Top- Left].	

USING THE PROJECTOR

Level 1	Level 2	Level 3	Level 4	Value	
Display	Geometric Correction	Move Increment		0.5	
				1	
				4 [Default]	
				16	
				32	
				64	
		Options	Warp Sharpness		0~9 [Default: 9]
				Warp Number	2x2
					3x3 [Default]
					5x5
			9x9		
			Warp Inner		Off [Default]
					On
			Cursor Color		Green [Default]
					Magenta
					Red
					Cyan
			Grid Color		Green [Default]
					Magenta
					Red
		Cyan			
		Reset			
	Aspect Ratio			4:3	
				16:9	
				Auto	
	EDID Reminder			On [Default]	
				Off	
	HDMI 1 EDID			1.4	
				2.0 [Default]	
	HDMI 2 EDID			1.4	
				2.0 [Default]	
	HDMI 3 EDID			1.4	
				2.0 [Default]	
	Menu Settings	Menu Location		Top left [Default]	
				Top right	
				Center	
				Bottom left	
				Bottom right	
		Menu Timer		Off	
				5sec	
			10sec		

USING THE PROJECTOR

Level 1	Level 2	Level 3	Level 4	Value
3D	3D Tech.			DLP-Link [Default]
				3D-Sync
	3D Format			Auto [Default]
				SBS
				Top and Bottom
				Frame Sequential
	3D Sync Invert			Frame Packing
				On
	Reset			Off [Default]
				Cancel
Audio	Internal Speaker			Reset
				Off
	Mute			On [Default]
				Off [Default]
	Volume			On
				0 ~ 100 [Default: 25]
	Digital Output			Bitstream
				PCM
				Auto [Default]
	Sound Effect			Movie
			Music	
			Sport	
			Game	
Internal Speaker Delay (ms)			Night	
			-50 ~ +50 (10ms increment) [Default:0]	
Digital Output Delay (ms)			-50 ~ +50 (10ms increment) [Default:0]	
Setup	Projection Mode			Front  [Default]
				Rear 
	Test Pattern			Green Grid
				Magenta Grid
				White Grid
				White
				Yellow Border
	High Altitude			Off [Default]
				On
	Focus			Press "Left" or "Right"

USING THE PROJECTOR

Level 1	Level 2	Level 3	Level 4	Value		
Information	Display	Display Mode				
		Brightness Mode				
	Hardware	Power Mode (Standby)				
		High Altitude			on	
						off
	Projection Hours					
	Input Source	Source				
		Resolution			00x00	
		Refresh Rate			0.00Hz	
		Color Depth				
		Color Format				
	About	Regulatory				
		Serial Number				
		FW Version	System			
			MCU			
	DDP					

Note: Functions vary depending on model definition.

USING THE PROJECTOR

Image settings menu

Display mode

There are many factory presets optimized for various types of images.

- **Cinema:** Provides the best colors for watching movies.
- **HDR:** Decodes and displays High Dynamic Range (HDR) content for the deepest blacks, brightest whites, and vivid cinematic color using REC.2020 color gamut. This mode will be automatically enabled if HDR is set to ON (and HDR Content is sent to projector – 4K UHD Blu-ray, 1080p/4K UHD HDR Games, 4K UHD Streaming Video). While HDR mode is active, other display modes (Cinema, Reference, etc.) cannot be selected as HDR delivers color that is highly accurate, exceeding the color performance of the other display modes.
- **HLG:** For HDR movies with Hybrid Log content.
- **HDR SIM.:** Enhances non-HDR content with simulated High Dynamic Range (HDR). Choose this mode to enhance gamma, contrast, and color saturation for non-HDR content (720p and 1080p Broadcast/Cable TV, 1080p Blu-ray, non-HDR Games, etc). This mode can ONLY be used with non-HDR content.
- **Game:** Select this mode to increase the brightness and response time level for enjoying video games.
- **Reference:** This mode is intended to reproduce as close as possible the image the way the movie director intended. Color, color temperature, brightness, contrast and gamma settings are all configured to standard reference levels. Select this mode to watch a video.
- **Bright:** Maximum brightness from PC input.
- **User:** Memorize user's settings.
- **3D:** To experience the 3D effect, you need to have 3D glasses. Make sure a Blu-ray 3D DVD player is installed.
- **ISF Day:** Optimize the image with the ISF Day mode to be perfectly calibrated and high picture quality.
- **ISF Night:** Optimize the image with the ISF Night mode to be perfectly calibrated and high picture quality.
- **ISF HDR:** Optimize the image with the ISF HDR mode to be perfectly calibrated and high picture quality.
- **ISF HLG:** Optimize the image with the ISF HLG mode to be perfectly calibrated and high picture quality.
- **ISF 3D:** Optimize the image with the ISF 3D mode to be perfectly calibrated and high picture quality.

Note: For access and calibration of ISF viewing modes, please contact your local dealer.

Dynamic Range

Configure the High Dynamic Range (HDR) setting and its effect when displaying video from 4K HDR Blu-ray players, 1080p HDR and 4K HDR Game Consoles, 4K HDR Steaming Set-top boxes and 4K HDR streaming services.

➤ **HDR (High Dynamic Range)/HLG (Hybrid Log-Gamma)**

- **Auto:** Auto detect HDR/HLG signal.
- **Off:** Turn off HDR/HLG processing. When set to Off, the projector will NOT decode HDR/HLG content.

➤ **HDR Picture Mode**

- **Bright:** Choose this mode for brighter more saturated colors.
- **Standard:** Choose this mode for natural looking colors with a balance of warm and cool tones.
- **Film:** Choose this mode for improved detail and image sharpness.
- **Detail:** Choose this mode for improved detail and image sharpness in dark scenes.

USING THE PROJECTOR

Brightness

Adjust the brightness of the image.

Contrast

The contrast controls the degree of difference between the lightest and darkest parts of the picture.

Sharpness

Adjust the sharpness of the image.

Color

Adjust a video image from black and white to fully saturated color.

Tint

Adjust the color balance of red and green.

Gamma

Set up gamma curve type. After the initial setup and fine tuning is completed, utilize the Gamma Adjustment steps to optimize your image output.

- **Film:** For home theater.
- **Video:** For video or TV source.
- **Graphics:** For PC / Photo source.
- **Standard(2.2):** For standardized setting.
- **1.8 / 2.0 / 2.4:** For specific PC / Photo source.

Color Settings

Configure the color settings.

- **BrilliantColor™:** This adjustable item utilizes a new color-processing algorithm and enhancements to enable higher brightness while providing true, more vibrant colors in picture.
- **Color Temperature:** Select a color temperature from Warm, Standard, Cool, or Cold.
- **Color Matching:** Adjust hue, saturation, and gain for the R (red), G (green), B (blue), C (cyan), Y (yellow), M (magenta), or (W) white color.
Note: Select "Reset" to reset the Color Matching settings and/or select "Exit" to exit the Color Matching menu.
- **RGB Gain/Bias:** This settings allows to configure the brightness (gain) and contrast (bias) of an image.
Note: Select "Reset" to reset the RGB Gain/Bias settings and/or select "Exit" to exit the RGB Gain/Bias menu.

Brightness Mode

Select the brightness mode setting.

PureMotion

Select the PureMotion setting to make video filmed in 24fps to be more smooth and to compensate for motion blur. To disable PureMotion, select "Off".

Reset

Return the factory default settings for image settings.

USING THE PROJECTOR

Display menu

Aspect ratio

Select the aspect ratio of the displayed image.

- **4:3:** This format is for 4:3 input sources.
- **16:9:** This format is for 16:9 input sources, like HDTV and DVD enhanced for Wide screen TV.
- **Auto:** Automatically selects the appropriate display format.

4K UHD scaling table:

16 : 9 screen	480i/p	576i/p	720p	1080i/p	2160p
4x3	Scale to 2880 x 2160.				
16x9	Scale to 3840 x 2160.				
Auto	-If source is 4:3, the screen type will be scaled to 2880 x 2160. -If source is 16:9, the screen type will be scaled to 3840 x 2160. -If source is 15:9, the screen type will be scaled to 3600 x 2160. -If source is 16:10, the screen type will be scaled to 3456 x 2160.				

Auto mapping rule:

	Input resolution		Auto/Scale	
	H-resolution	V-resolution	3840	2160
4:3	640	480	2880	2160
	800	600	2880	2160
	1024	768	2880	2160
	1280	1024	2880	2160
	1400	1050	2880	2160
	1600	1200	2880	2160
Wide Laptop	1280	720	3840	2160
	1280	768	3600	2160
	1280	800	3456	2160
	Input resolution		Auto/Scale	
	H-resolution	V-resolution	3840	2160
SDTV	720	576	2700	2160
	720	480	3240	2160
HDTV	1280	720	3840	2160
	1920	1080	3840	2160

USING THE PROJECTOR

Geometric Correction

Adjust the image's projection to match a specific projection surface or shape.

- **Warp Control:** Set to "On" to use warp settings to customize the projection image or set to "Off" to project native projection image.
- **Warp Calibration:** Press "Up", "Down", "Left" or "Right" to focus the point. Press "OK" to select the point. Then press "Up", "Down", "Left" or "Right" to shift the selected point location. Press "↶" to return to the previous page.
- **Move Increment:** Set the move increment for warping.
- **Options:** Configure more warping settings, such as "Warp Number", "Warp Inner" and set a color for cursor and for grid.
- **Reset:** Reset all settings for Geometric Correction menu to the factory defaults.

EDID Reminder

Enable to display a reminder message when the input source is changed to the HDMI source.

HDMI 1 EDID / HDMI 2 EDID / HDMI3 EDID

Select the HDMI EDID type from 2.0 or 1.4.

- Select HDMI 1.4 EDID when using 1080p sources (Xbox 360, Cable Box, Satellite Box, etc.).
- Select HDMI 2.0 EDID for 1080p HDR sources (such as Xbox One S or PS4) and 4K HDR sources (4K HDR Blu-ray Player, Roku Ultra 4K, SHIELD TV, Xbox One X and PS4 Pro, etc.).

Note: *Using HDMI 2.0 EDID with a HDMI 1.4 source may result in abnormal color and or color banding. If this occurs, change the EDID to 2.0 for the port the source is attached to.*

Menu Settings

Set the menu location on the screen and configure menu timer settings.

- **Menu Location:** Select the menu location on the display screen.
- **Menu Timer:** Set the duration where the OSD menu stays visible on the screen.

3D menu

3D Tech.

Set the 3D tech. parameter to "DLP-Link" or "Standard".

3D Format

Use this option to select the appropriate 3D format content.

- **Auto:** When a 3D identification signal is detected, the 3D format is selected automatically.
- **SBS:** Display 3D signal in "Side-by-Side" format.
- **Top and Bottom:** Display 3D signal in "Top and Bottom" format.
- **Frame Sequential:** Display 3D signal in "Frame Sequential" format. Frame Sequential encoding method is commonly used on PC content.
- **Frame Packing:** Display 3D signal in "Frame Packing" format. Frame Packing encoding method is primarily used with 1080p Blu-ray.

3D Sync Invert

Use this option to enable/disable the 3D sync invert function.

Reset

Return the factory default settings for 3D settings.

Note: *3D function is unavailable in the following situations: 4K, HDR, HLG, No video signal.*

USING THE PROJECTOR

Audio menu

Internal Speaker

Choose “On” or “Off” to turn on or off the internal speaker.

Mute

Use this option to temporarily turn off the sound.

- **On:** Choose “On” to turn mute on.
- **Off:** Choose “Off” to turn mute off.

Note: “Mute” function affects both internal and external speaker volume.

Volume

Adjust the audio volume level.

Note: Volume cannot not be adjusted if the audio output is via HDMI ARC or S/PDIF.

Digital Output

Select the digital audio output format between “Bitstream”, “PCM”, and “Auto”.

Sound Effect

Select the sound effect between “Movie”, “Music”, “Sport”, “Game”, and “Night”.

Internal Speaker Delay (ms)

Set the internal speaker delay in milliseconds.

Digital Output Delay (ms)

Set the digital output delay in milliseconds.

Setup menu

Projection Mode

Select the preferred projection between “Front” and “Rear”. Refer to page 14.

Test Pattern

Select the test pattern from “Green Grid”, “Magenta Grid”, “White Grid”, “White”, and “Yellow Border”.

Press “↵” to exit the Test Pattern menu.

High Altitude

When “On” is selected, the fans will spin faster. This feature is useful in high altitude areas where the air is thin.

Focus

Press the “Left” or “Right” button on the remote control to focus the projected image.

Information menu

View the projector information as listed below:

- Display
- Hardware
- Input Source
- About

USING THE PROJECTOR

System settings menu

On the Home screen, select the system settings menu “” to configure various system settings.

General menu navigation

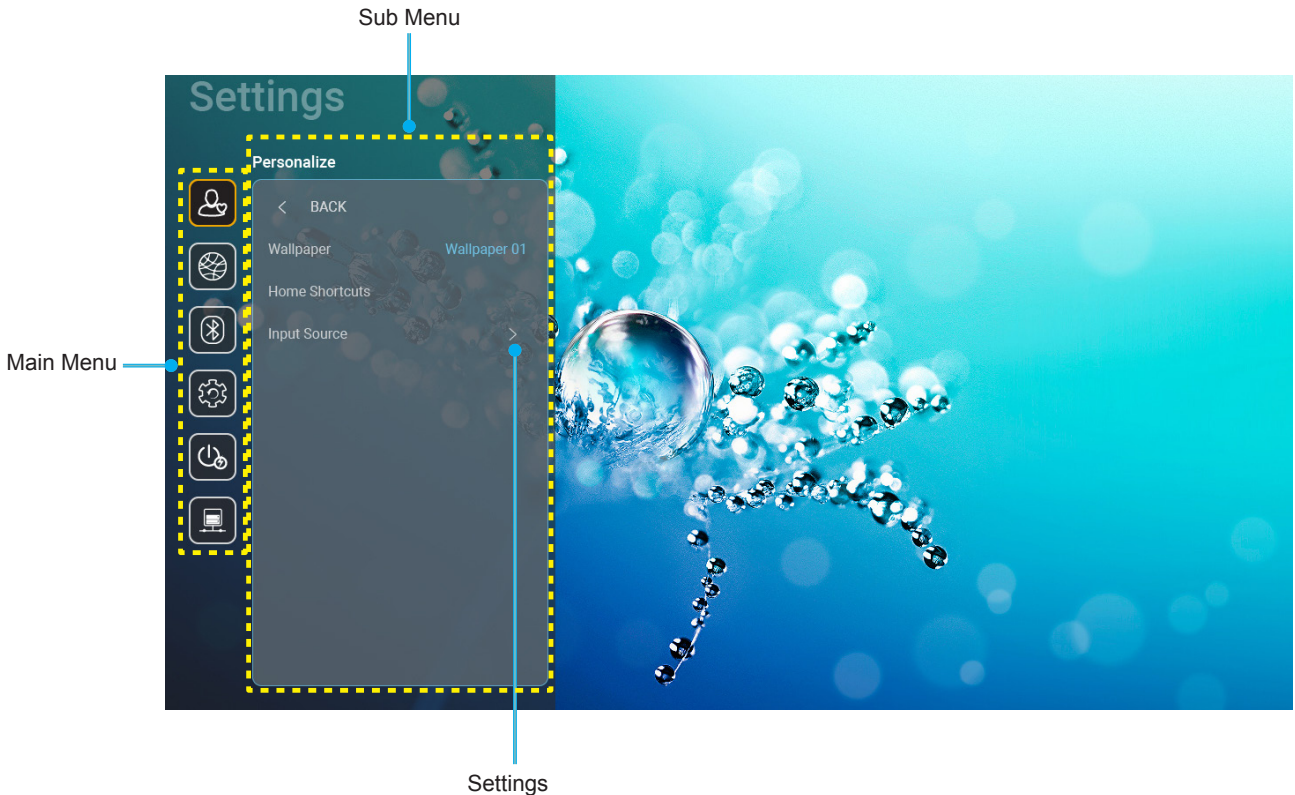

1. When system settings menu is displayed, use the up and down navigation buttons to select any item in the main menu. While making a selection on a particular page, press the “**OK**” or the “**Right**” button on the remote control to enter the submenu.
2. Press the “**Left**” and “**Right**” button to select the desired menu item. Then press “**OK**” to open its sub menu.
3. Press the “**Up**” and “**Down**” button to select the desired item in the sub menu.
4. Press the “**OK**” or “**Right**” button to access the selected sub menu item settings.
5. Press the “**Up**”, “**Down**”, “**Left**”, or “**Right**” button to select the setting or press the “**Left**” and “**Right**” button to adjust the value (if necessary).
6. Press “**OK**” to confirm the setting.
7. Select the next item to be adjusted in the sub menu and modify as described above.
8. To exit, press “**↶**” (repeatedly if necessary). The settings menu will close and the projector will automatically save the new settings.

USING THE PROJECTOR

System settings menu tree

Level 1	Level 2	Level 3	Level 4	Value				
Personalize	Wallpaper	Optoma style...						
	Home Shortcut		Short cut 1		APP/ Input Source			
			Short cut 2		APP/ Input Source			
			Short cut 3		APP/ Input Source			
			Short cut 4		APP/ Input Source			
			Short cut 5		APP/ Input Source			
			Short cut 6		APP/ Input Source			
	Input Source	HDMI/USB Disk			Notification			
					Source Auto-change [Default]			
					None			
		Input Name	HDMI1					
HDMI2								
HDMI3								
Network	Wireless	Wi-Fi		Off				
				On [Default]				
		Available Networks SSID (When WiFi On)		Enter password for [Wi-Fi name] (When entering password)		[Pop up dialog] - Title: Enter password for [Wi-Fi name] - Subtitle: Password - Input: (Input text) - Checkbox: Show password - Button: "Cancel"/ "OK"		
				Internet Connection				
				IP Address				
				MAC Address				
				Signal Strength				
				Proxy Settings				None
								Manual [Pop up dialog] Title: Enter a valid hostname. Subtitle: Proxy hostname Input hint: proxy.example@com Button: "Cancel"/ "OK"
								DHCP
				IP Settings				Static [Pop up dialog] Title: Enter a valid IP address. Subtitle: IP address Input hint: 192.168.1.128 Button: "Cancel"/ "OK"
						Cancel		
		Forget				[Pop up dialog] Hint: [Wi-Fi name] Title: Forget network Content: Your device will no longer join this Wi-Fi network. Button: "Cancel"/ "OK"		

USING THE PROJECTOR

Level 1	Level 2	Level 3	Level 4	Value	
Network	Wireless	Other Options	Connect via WPS		
			Connect via WPS (Enter PIN)		
			Add New Network	[Pop up dialog] Title: Enter the name for Wi-Fi network Input: (Input text) Button: "Cancel"/"OK"	
				[Pop up dialog] Content: Type of security Button: None, WEP, WPA/WPA2 PSK, 802.1xEAP	
			Portable Hotspot	Portable Wi-Fi Hotspot	Off
					On
				Network name	[Pop up dialog] Title: Rename network name Input: (Input text) Button: "Cancel"/"OK"
				Security	[Pop up dialog] Title: Type of security Button: None, WPA2 PSK
				Password	[Pop up dialog] Title: Change password Input: (Input text) Description: The password must have at least 8 characters. Checkbox: Show password Button: "Cancel"/"OK"
			Ethernet (Android)	Network Status	
	MAC Address			(read only)	
	Proxy Settings	None			
		Manual		Proxy hostname	
				Port	
		bypass proxy domains			
	IP Settings	DHCP			
		Static		IP address	
			Gateway		
			Network Prefix Length		
	DNS1				
	DNS2				
Network Diagnosis					
Reset					
Bluetooth	Bluetooth		On [Default]		
			Off		
	Device Name (When BT On)	Rename Device		[Pop up dialog] Title: Rename device Input: (Input text) Button: "Cancel"/"OK" [Default: Optoma-UHD]	

USING THE PROJECTOR

Level 1	Level 2	Level 3	Level 4	Value
Bluetooth	Scan again (When BT On)			
	Paired Devices (When BT On)	Device Name		[Pop up dialog] Title: Rename paired device Input: (Input text) Button: "Cancel"/"OK"
		(Customized settings)		
		Cancel		
		Forget		[Pop up dialog] Hint: [Bluetooth name] Title: Forget device Button: "Cancel"/"OK"
	(When device is not connected)		[Pop up dialog] Content: Device is not available right now. Button: "Cancel"/"OK"/"Forget"	
Available Devices (When BT On)				
System	Language			English [Default]
				Deutsch
				Français
				Italiano
				Español
				Português
				Polski
				Nederlands
				Svenska
				Norsk/Dansk
				Suomi
				ελληνικά
				繁體中文
				简体中文
				日本語
				한국어
				Русский
				Magyar
				Čeština
				عربي
			ไทย	
		Türkçe		
		فارسی		
		Tiếng Việt		
		Bahasa Indonesia		
		Română		
		Slovenčina		
	Keyboard			

USING THE PROJECTOR

Level 1	Level 2	Level 3	Level 4	Value
System	Date and Time	Select time zone		-12:00, -11:00, -10:00, -09:30, -09:00, -08:00, -07:00, -06:00, -05:00, -04:00, -03:30, -03:00, -02:00, -01:00, 00:00, +01:00, +02:00, +03:00, +03:30, +04:00, +04:30, +05:00, +05:30, +05:45, +06:00, +06:30, +07:00, +08:00, +08:30, +8:45, +09:00, +09:30, +10:00, +10:30, +11:00, +12:00, +12:45, +13:00, +14:00
		Daylight Saving Time		On
		Use 24-hour format		Off [Default]
	System Update			On
	Internal Storage			Off [Default]
	Reset			[Pop up dialog] Content: Would you like to reset all settings or reset to default? All the settings/data will be erased. Button: "Cancel" / "Reset all settings" / "Reset to Default"
	Legal	Terms and Conditions of Use		
		Privacy Policy		
		Cookies Policy		
	Power	Direct Power On		
				On
Auto Power Off (min.)				0 ~ 180 (5 min increments) [Default: 20]
Sleep Timer (min.)				Off ~ 990 (30 min increments) [Default: Off]
Power Mode (Standby)				Smart Home
				Eco [Default]
Control	LAN Control	IoT		Off
				On [Default]
	HDMI Link Settings	Power On Link		Off
				On [Default]
Power Off Link		Off		
		On [Default]		

Note: Functions vary depending on model definition.

USING THE PROJECTOR

Personalize menu

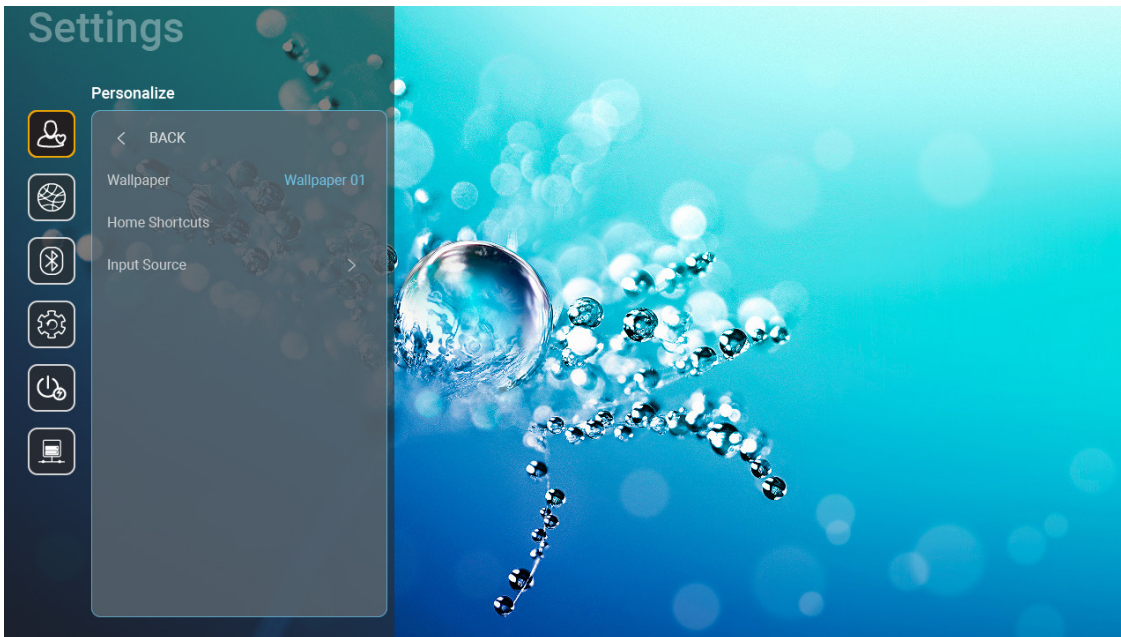

Home Shortcut

Review Home screen shortcuts of all opened apps in each input source. The items cannot repeat except for “Automatic” option which means the system will remember up to six latest apps that have been opened and then will replace app shortcuts so that the latest app will be the first app in the apps list while other apps in the list are shifted by one position.

HDMI/USB Disk

Define how the system will react when one of the input sources (HDMI/USB flash drive) is connected to the projector.

- **Notification:** Choose “Notification” to display the input switching confirmation message when an input source is detected.
- **Source Auto Change:** Choose “Source Auto Change” to automatically switch to the currently detected input source.
- **None:** Choose “None” to manually switch the input source.

Note: *HDMI ARC is also considered as an input source. If you want to disable source auto changing, set the HDMI/USB Disk option to “None”.*

Input Name

Rename the input source if necessary.

USING THE PROJECTOR

Network menu

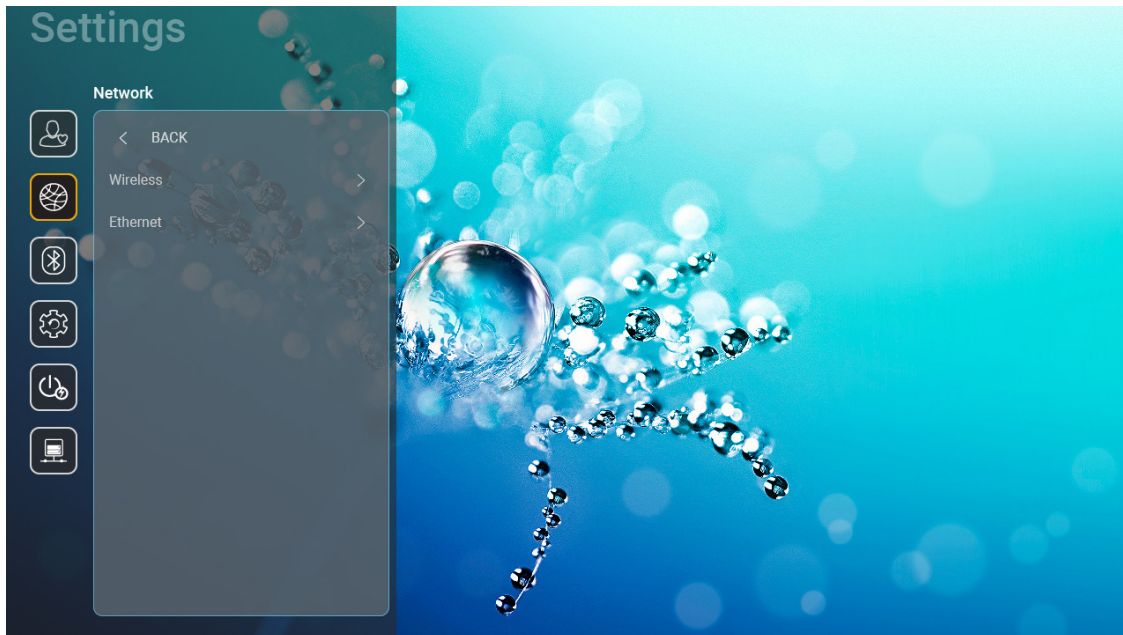

Wireless

Configure wireless network settings.

- **Wi-Fi:** Set the Wi-Fi option to “On” to enable wireless network feature.
- **Available Network SSID:** Select your desired wireless access point and enter or configure the necessary connection parameters (if required), for example password, proxy settings, and IP address. For information, you can review the signal strength.

Choose “Cancel” to return to the Network menu without saving settings. Choose “Forget” to delete the wireless network profile.

Note: *Whenever you need to input symbols, the system will automatically pop-up an onscreen keyboard.*

- **Other Options:** Configure advanced wireless network settings, such as “Connect via WPS”, “Connect via WPS (Enter PIN)”, “Add New Network” (manually enter network name), and “Portable Hotspot” (configure the projector to behave as a wireless access point for other devices).

USING THE PROJECTOR

Ethernet (Android)

Configure wired network settings.

Note: Make sure you have connected the projector to local area network (LAN). Please refer to page 15.

- **Network Status:** Display the network connection status (read-only).
- **MAC Address:** Display the MAC address (read-only).
- **Proxy Settings:** Provide proxy hostname, connection port and bypass proxy domains information manually if requested.
- **IP Settings:** Enable DHCP if you want the projector to obtain IP address and other connection parameters automatically from your network. Disable DHCP if you want to assign IP address, gateway, network prefix length, and DNS parameters manually.
- **Reset:** Return the factory default settings for network settings.

Bluetooth menu

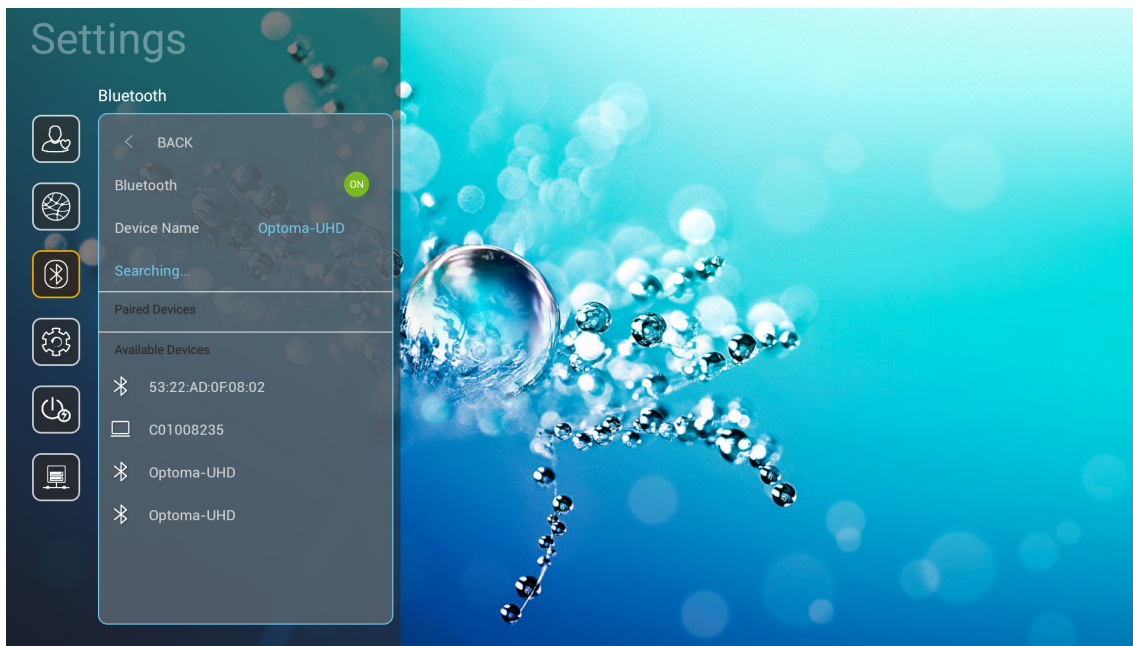

Bluetooth

Set the Bluetooth option to “On” to enable Bluetooth feature.

Device Name

Review or modify the projector name.

Note: Whenever you need to input symbols, the system will automatically pop-up an onscreen keyboard.

Scan Again

Search for available Bluetooth devices.

Paired Devices

Review and manage paired devices.

Available Devices

Review all available Bluetooth devices.

USING THE PROJECTOR

System menu

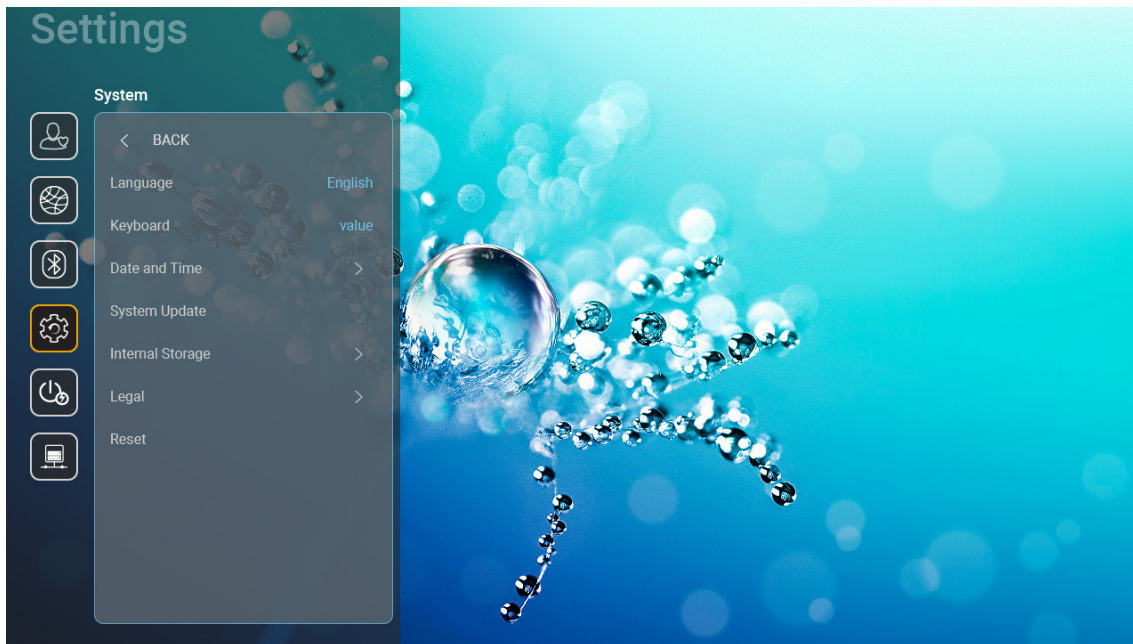

Language

Select your preferred system language between English, German, French, Italian, Spanish, Portuguese, Russian, Traditional Chinese, Simplified Chinese, Japanese, and Korean.

Keyboard

Select the keyboard language.

Date and Time

Configure date and time settings.

- **Select time zone:** Select the time zone in your location.
- **Use 24-hour format:** Set to “On” to display time in 24-hour format. Set to “Off” to display time in 12-hour format (AM/PM).
- **Choose date format:** Choose your preferred date format.

System Update

System will look for updates automatically every time the projector is connected to the Internet (OTA).

Internal Storage

View the internal storage usage.

USING THE PROJECTOR

Legal

Review legal documents including “Terms and Conditions of Use”, “Privacy Policy”, and “Cookies Policy”.

Note: You can review legal documents online as well. Please refer to the following web addresses:

- Terms and Conditions of Use: <https://www.optoma.com/terms-conditions/> .
- Cookies Policy: <https://www.optoma.com/cookies-policy/> .
- Privacy Policy: <https://www.optoma.com/software-privacy-policy/> .

Reset

Reset all settings including data (“Reset all settings”) or reset settings to the factory defaults only (“Reset to Default”). Select “Cancel” to exit the menu and keep the current configuration.

Note: After you select “Reset to Default”, the projector will automatically turn off. To start the recovery procedure, turn on the projector.

Power menu

Direct Power On

Choose “On” to activate Direct Power mode. The projector will automatically power on when AC power is supplied, without pressing the “Power” button on the projector keypad or on the remote control.

Auto Power Off (min.)

Set the countdown timer interval. The countdown timer will start, when there is no signal being sent to the projector. The projector will automatically power off when the countdown has finished (in minutes).

Sleep Timer (min.)

Set the countdown timer interval. The countdown timer will start, with or without a signal being sent to the projector. The projector will automatically power off when the countdown has finished (in minutes).

Power Mode (Standby)

Configure power mode settings in standby.

- **Smart Home:** Choose “Smart Home” to return to normal standby (LAN on, Wi-Fi on).
- **Eco:** Choose “Eco.” to save power dissipation further < 0.5W.

Power Mode	Eco (<0.5W)	Smart Home (<8W)
IoT turn on projector (Alexa, Google Assistant, IFTTT)	N/A	Yes
Switch to Bluetooth Speaker mode	N/A	Yes
Power On via controller Bluetooth Mode	Power on via IR	Yes
InfoWall scheduling to turn on projector	N/A	Yes

USING THE PROJECTOR

Control menu

LAN Control

- **IoT:** Set to “Off” to turn off all control via “IoT”, including “InfoWall”.

HDMI Link Settings

Configure HDMI link settings.

- **Power On Link:** Enable this function to let both HDMI Link and projector to be automatically turned on simultaneously.
- **Power Off Link:** Enable this function to let both HDMI Link and projector to be automatically turned off at the same time.

Note:

- *The HDMI link function is supported only if the source is connected to the HDMI1 or HDMI2 port.*
- *The projector can be controlled by other devices but cannot be used to control other devices.*
- *If your downstream audio device (AVR, Soundbar) supports HDMI ARC, you can use HDMI ARC port to output digital audio.*

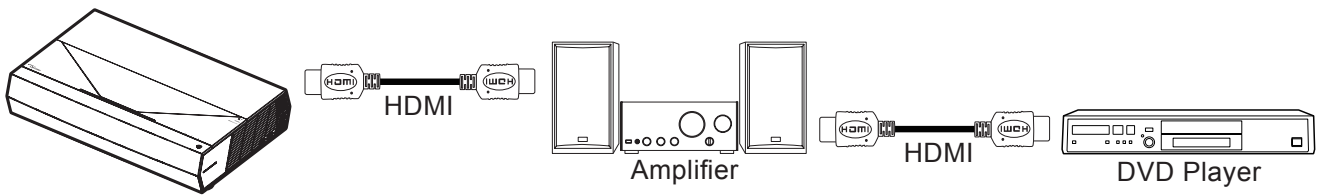

Selecting an input source

You can select any input source directly on the Home screen using an input shortcut.

Note: You can personalize shortcut settings in “System Settings menu → Personalize → Home Shortcut”. You can also modify the shortcut order on the Home screen.



USING THE PROJECTOR

If the desired input source is not visible on the Home screen, select “” to view all input options. Then select your input source or select “HOME” to return to the Home screen.

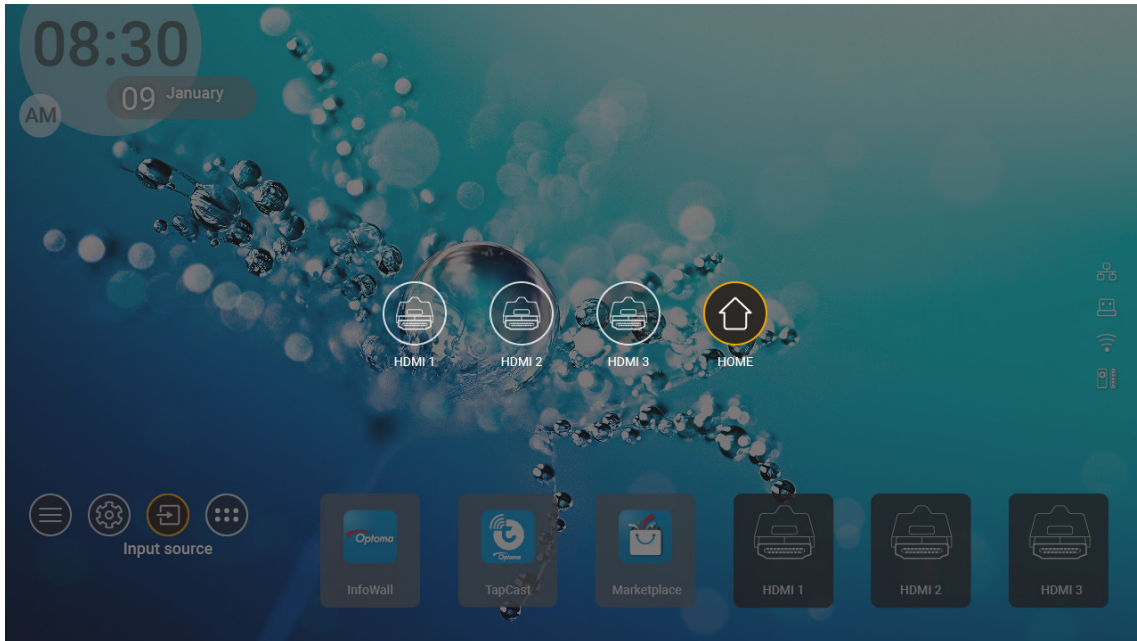

Note: The projector can be set to notify the input switching confirmation message when an input source is detected and automatically or manually switch to the currently detected input source. Refer to page 40.

USING THE PROJECTOR

Selecting an app

You can select any app directly on the Home screen using an app shortcut.

Note: You can personalize shortcut settings in “System Settings menu → Personalize → Home Shortcut”.

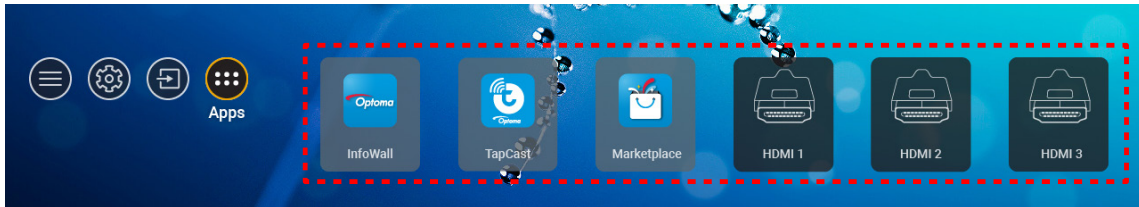

If the desired app is not visible on the Home screen, select “” to view all installed apps. Then select your desired app.

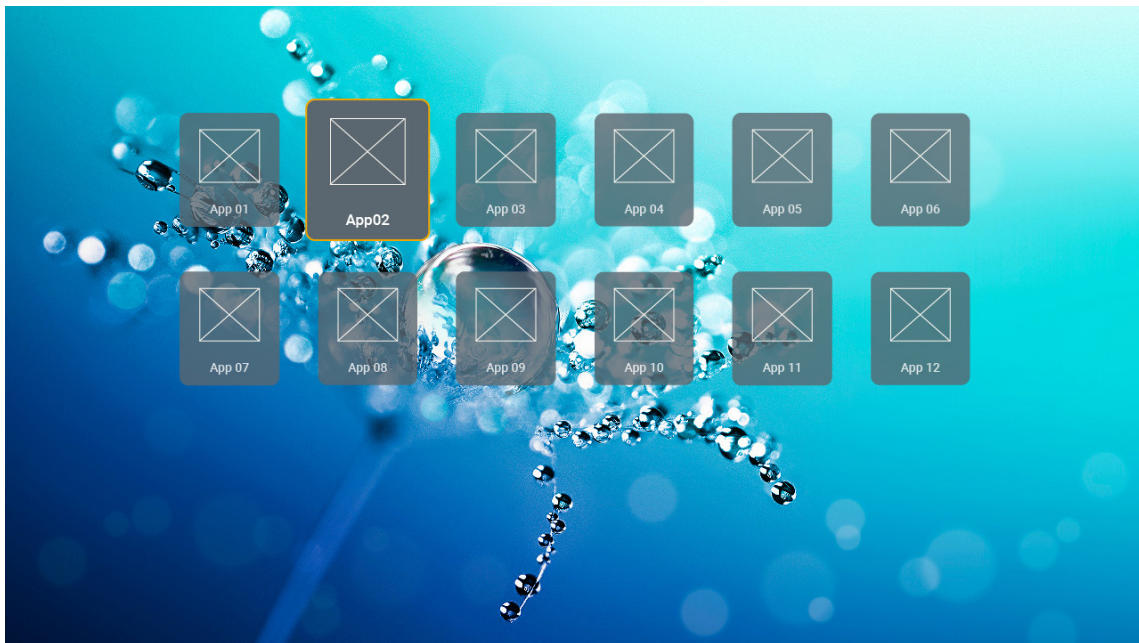

USING THE PROJECTOR

Supported multimedia formats

If you want to play multimedia files, connect a USB storage with multimedia content to the projector. Then open the multimedia player app and select the desired files to play.

The projector supports the following multimedia formats:

Media Category	Decoder	Supported File Formats
Video	H.263	FLV
		MP4
		MOV
		3GPP
		3GP
		AVI
		MKV
	H.264	FLV
		MP4
		MOV
		3GPP
		3GP
		MPEG transport stream (.ts / .trp / .tp)
		ASF
		WMV
		AVI
		MKV
		HEVC/H.265
	MOV	
	3GPP	
	3GP	
	MPEG transport stream (.ts / .trp / .tp)	
	MKV	
	MPEG1/2	MPEG program stream (.DAT / .VOB / .MPG / .MPEG)
		MPEG transport stream (.ts / .trp / .tp)
		MP4
		3GP
		AVI
		MKV
	MPEG4	MP4
		MOV
		3GP
AVI		
MKV		

USING THE PROJECTOR

Media Category	Decoder	Supported File Formats
Video	DivX 3.11, DivX 4.12, DivX 5.x, DivX 5, XviD	DivX
		MP4
		AVI
		MKV
		MOV
	Motion JPEG	AVI
		MP4
		MOV
	AVS	3GPP
		3GP
		MP4
		MOV
		MPEG transport stream (.ts / .trp / .tp)
	AVS+	3GPP
		3GP
		MP4
		MOV
		MPEG transport stream (.ts / .trp / .tp)
	VC1	MPEG transport stream (.ts / .trp / .tp)
		WMV
MKV		
Audio	MPEG1/2 Layer1	MP3
		AVI
		MP4
		MOV
		M4A
		MPEG transport stream (.ts / .trp / .tp)
		MPEG program stream (.DAT / .VOB / .MPG / .MPEG)
	MPEG1/2 Layer2	MP3
		AVI
		Matroska (MKV, MKA)
		MP4
		MOV
		M4A
		MPEG transport stream (.ts / .trp / .tp)
	MPEG program stream (.DAT / .VOB / .MPG / .MPEG)	
	MPEG1/2/2.5 Layer3	MP3
		Matroska (MKV, MKA)
		MP4
	MPEG1/2/2.5 Layer3	MOV
		M4A
		MPEG transport stream (.ts / .trp / .tp)
		MPEG program stream (.DAT / .VOB / .MPG / .MPEG)

USING THE PROJECTOR

Media Category	Decoder	Supported File Formats
Audio	AC3	AC3
		Matroska (MKV, MKA)
		MOV
		MPEG transport stream (.ts / .trp / .tp)
		MPEG program stream (.DAT / .VOB / .MPG / .MPEG)
	EAC3	EAC3
		MP4
	AAC, HEAAC	AAC
		MP4
		MOV
		M4A
		MPEG transport stream (.ts / .trp / .tp)
		MPEG program stream (.DAT / .VOB / .MPG / .MPEG)
	WMA	WMV
		ASF
		AVI
		Matroska (MKV, MKA)
	LPCM	WAV
		AVI
		Matroska (MKV, MKA)
		MP4
		MOV
		M4A
		MPEG transport stream (.ts / .trp / .tp)
		MPEG program stream (.DAT / .VOB / .MPG / .MPEG)
	IMA-ADPCM MS-ADPM	WAV
AVI		
Matroska (MKV, MKA)		
MP4		
MOV		
M4A		
FLAC	Matroska (MKV, MKA)	
Photo	BMP	15360 X 8640 (The limitaion of max resolution depends on DRAM size)

Note:

- All multimedia files can be played using a media player app.
- The HDMI 1 (ARC) port on the rear of the projector supports Dolby ATMOS passthrough.

Picture

Image Type (Ext name)	Sub Type	Maximum Pixels
Jpeg / Jpg	Baseline	8000 x 8000
	Progressive	6000 x 4000
PNG	Non-interlace	6000 x 4000
	Interlace	6000 x 4000
BMP		6000 x 4000

USING THE PROJECTOR

Doc

Document Format	Support Version and Format	Pages/Lines Limitation	Size Limitation
PDF	PDF 1.0 ~ 1.7 and above	Up to 1500 pages (One File)	Up to 100MB
Word	Kingsoft Writer Document (*.wps)	Since WPS Projector does not load the MS/Word files all at one time, there is no obvious limitation on the number of pages and rows of files.	Up to 150MB
	Kingsoft Writer Template (*.wpt)		
	Microsoft Word 97/2000/XP/2003 Document (*.doc)		
	Microsoft Word 97/2000/XP/2003 Template (*.dot)		
	RTF Files (*.rtf)		
	Text Files (*.txt, *.log, *.lrc, *.c, *.cpp, *.h, *.asm, *.s, *.java, *.asp, *.prg, *.bat, *.bas, *.cmd)		
	Web Page Files (*.html, *.htm)		
	Single Web Page Files (*.mht, *.mhtml)		
	Microsoft Word 2007/2010 Document (*.docx)		
	Microsoft Word 2007/2010 Template (*.dotx)		
	Microsoft Word 2007/2010 Macro-Enabled Document (*.docm)		
	Microsoft Word 2007/2010 Macro-Enabled Template (*.dotm)		
	XML Files (*.xml)		
	OpenDocument Text		
Works 6-9 Document (*.wtf)			
Works 6.0&7.0 (*.wps)			
Excel	Kingsoft Spreadsheets Files (*.et)	Row Limit: up to 65,535 Column Limit: up to 256 Sheet: up to 200	Up to 30MB
	Kingsoft Spreadsheets Template (*.ett)		
	Microsoft Excel 97/2000/XP/2003 Workbook (*.xls)		
	Microsoft Excel 97/2000/XP/2003 Template (*.xlt)		
	Text Files (*.csv)		
	Web Pages (*.htm, *.html)		
	XML Files (*.xml)		
	Microsoft Excel 2007/2010 Files (*.xlsx, *.xlsm)		
	Microsoft Excel 2007/2010 Template (*.xltx)		
Microsoft Excel 2007/2010 Binary Workbook (*.xlsb)			
PowerPoint	Kingsoft Presentation Files (*.dps)	Up to 1500 pages (One File)	Up to 30MB
	Kingsoft Presentation Templates (*.dpt)		
	Microsoft PowerPoint 97/2000/XP/2003 Presentations (*.ppt, *.pps)		
	Microsoft PowerPoint 97/2000/XP/2003 Presentation Templates (*.pot)		
	Microsoft PowerPoint 2007/2010 Presentations (*.pptx, *.ppsx)		
	Microsoft PowerPoint 2007/2010 Presentations Template (*.potx)		

Note:

- Decoding may take a while for large files with complex contents.
- Objects embedded in files cannot be activated or viewed.

USING THE PROJECTOR

- *For Microsoft Word*
 - *No support for advanced settings, such as drawing plug-in or table background settings.*
 - *Contents outside the defined borders in Microsoft Word will not be displayed.*
 - *Not support Bold Text in Simplified Chinese font.*
- *For Microsoft PowerPoint*
 - *Slide effects not supported.*
 - *Password-protected sheets are not protected.*
 - *Powerpoint animation is not supported.*
- *For Microsoft Excel*
 - *Worksheets are displayed individually and sequentially when the workbook has multiple worksheets.*
 - *Page layout and numbering may be changed during decoding.*

USING THE PROJECTOR

Viewing the status bar

By default, the Status Bar on the Home screen contains icons indicating connection status regarding wired network, USB, and wireless network and remaining battery status of the remote control (if applicable). You can select any of the icons to open the associated menu, except for the remote battery. Selecting wired or wireless status icon results in opening the network configuration menu, while selecting the USB status icon results in opening the browser and displaying the content of the connected USB device.

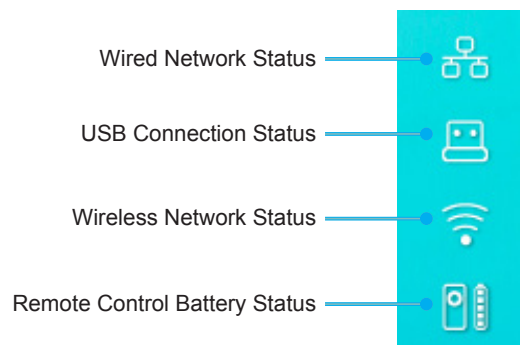

About the Quick menu

In Quick menu, you can find shortcuts to the OSD menu items.



To access the Quick menu, long press the “☰” button on the remote control.

ADDITIONAL INFORMATION

Compatible resolutions

Digital (HDMI 1.4)

Established Timing	Standard Timing	Descriptor Timing	Supported Video Mode	Detail Timing
720 x 400 @ 70Hz	1280 x 720 @ 60Hz	1920 x 1080 @ 60Hz (default)	720 x 480i @ 60Hz 16:9	1920 x 1080p @ 60Hz
640 x 480 @ 60Hz	1280 x 800 @ 60Hz		720 x 480p @ 60Hz 4:3	
640 x 480 @ 67Hz	1280 x 1024 @ 60Hz		720 x 480p @ 60Hz 16:9	
640 x 480 @ 72Hz	1920 x 1200 @ 60Hz (reduced)		720 x 576i @ 50Hz 16:9	
640 x 480 @ 75Hz	1366 x 768 @ 60Hz		720 x 576p @ 50Hz 4:3	
800 x 600 @ 56Hz			720 x 576p @ 50Hz 16:9	
800 x 600 @ 60Hz			1280 x 720p @ 60Hz 16:9	
800 x 600 @ 72Hz			1280 x 720p @ 50Hz 16:9	
800 x 600 @ 75Hz			1920 x 1080i @ 60Hz 16:9	
832 x 624 @ 75Hz			1920 x 1080i @ 50Hz 16:9	
1024 x 768 @ 60Hz			1920 x 1080p @ 60Hz 16:9	
1024 x 768 @ 70Hz			1920 x 1080p @ 50Hz 16:9	
1024 x 768 @ 75Hz			1920 x 1080p @ 24Hz 16:9	
1280 x 1024 @ 75Hz			3840 x 2160 @ 24Hz	
1152 x 870 @ 75Hz			3840 x 2160 @ 25Hz	
			3840 x 2160 @ 30Hz	
			4096 x 2160 @ 24Hz	

Digital (HDMI 2.0)

B0 / Established Timing	B0 / Standard Timing	B1 / Video Mode	B1 / Detail Timing
720 x 400 @ 70Hz	1280 x 720 @ 60Hz	720 x 480i @ 60Hz 16:9	1920 x 1080p @ 60Hz
640 x 480 @ 60Hz	1280 x 800 @ 60Hz	720 x 480p @ 60Hz 4:3	
640 x 480 @ 67Hz	1280 x 1024 @ 60Hz	720 x 480p @ 60Hz 16:9	
640 x 480 @ 72Hz	1920 x 1200 @ 60Hz (reduced)	720 x 576i @ 50Hz 16:9	
640 x 480 @ 75Hz	1366 x 768 @ 60Hz	720 x 576p @ 50Hz 4:3	
800 x 600 @ 56Hz		720 x 576p @ 50Hz 16:9	
800 x 600 @ 60Hz		1280 x 720p @ 60Hz 16:9	
800 x 600 @ 72Hz		1280 x 720p @ 50Hz 16:9	
800 x 600 @ 75Hz		1920 x 1080i @ 60Hz 16:9	
832 x 624 @ 75Hz		1920 x 1080i @ 50Hz 16:9	
1024 x 768 @ 60Hz		1920 x 1080p @ 60Hz 16:9	
1024 x 768 @ 70Hz		1920 x 1080p @ 50Hz 16:9	
1024 x 768 @ 75Hz		1920 x 1080p @ 24Hz 16:9	
1280 x 1024 @ 75Hz		3840 x 2160 @ 24Hz	
1152 x 870 @ 75Hz		3840 x 2160 @ 25Hz	
		3840 x 2160 @ 30Hz	
		3840 x 2160 @ 50Hz	
		3840 x 2160 @ 60Hz	
		4096 x 2160 @ 24Hz	
		4096 x 2160 @ 25Hz	
		4096 x 2160 @ 30Hz	

ADDITIONAL INFORMATION

B0 / Established Timing	B0 / Standard Timing	B1 / Video Mode	B1 / Detail Timing
		4096 x 2160 @ 50Hz	
		4096 x 2160 @ 60Hz	

Note: Support 1920 x 1080 @ 50Hz.

Image size and projection distance

	Image Width (mm)	Image Height (mm)	Image Size (inch)	L0 (mm)	A Offset (mm) (121.5%)	A Offset (mm) (default = 124%)	A Offset (mm) (130%)
Optoma 16:9 TR = 0.254 Default Offset 124%	1771.0	996.3	80	143.7	297.1	322.0	381.8
	1881.7	1058.5	85	171.9	310.5	336.9	400.5
	1992.4	1120.8	90	200.0	323.9	351.9	419.1
	2103.1	1183.1	95	228.1	337.3	366.8	437.8
	2213.9	1245.4	100	256.2	350.7	381.8	456.5
	2324.5	1307.6	105	284.3	364.0	396.7	475.2
	2656.5	1494.4	120	368.7	404.2	441.6	531.2

	Reflector to Screen (mm)	Offset 121.5% Image Height (mm)	Offset 124% Image Height (mm)	Offset 130% Image Height (mm)
Optoma 16:9 TR = 0.254 Default Offset 124%	449.8	1210.5	1235.4	1295.1
	478.0	1286.1	1312.6	1376.1
	506.1	1361.8	1389.8	1457.0
	534.2	1437.4	1467.0	1538.0
	562.3	1513.2	1544.3	1619.0
	590.4	1588.7	1621.4	1699.9
	674.8	1815.7	1853.0	1942.7

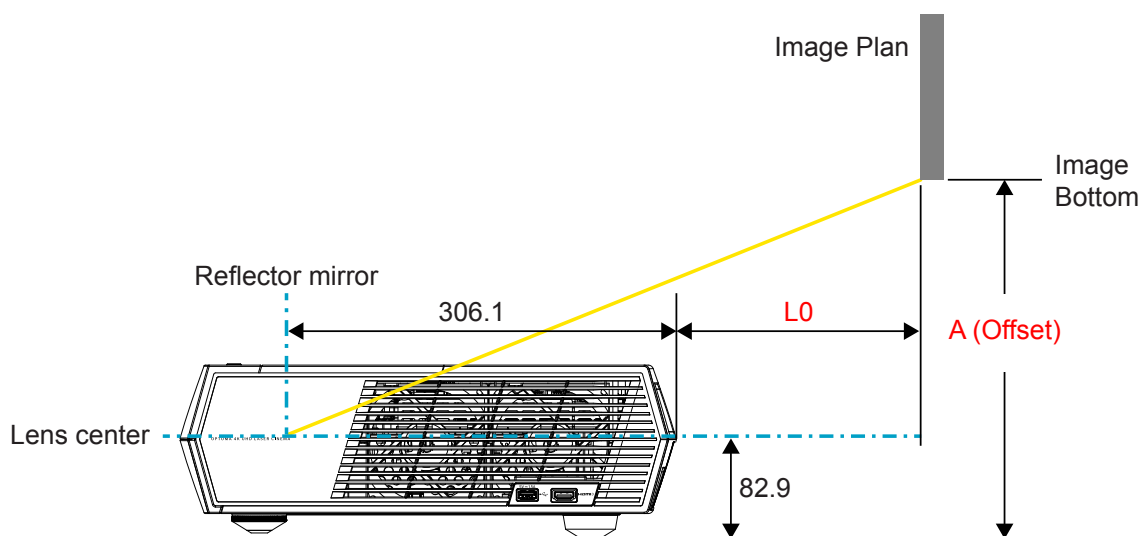

Note:

- The vertical offset may vary between projectors, due to the limitations of optical manufacturing. Additional adjustments may occur when switching projectors.
- Offset tolerance is 124% +6%/-2.5%.





ADDITIONAL INFORMATION

Remote control



Note:









- The functions described in the following table are executed after short pressing the specific button on the remote control unless indicated differently.
- If the remote control is paired successfully, the default name of the remote control in Bluetooth devices menu is "OptomaRemote".

Function	Bluetooth Signal		Description			
	Usage Page	Usage ID	Standby	Projection Mode	Speaker Mode	
	HID Code	HID Code				
Power on/ Standby		0x07	0x66	Press "  " to turn on projector in Projection mode. Refer to the "Powering on / off the projector" section on pages 18-21.	Press "  " to pop up a selection menu to toggle between Bluetooth Speaker mode and Standby mode. Press the "  " button twice to exit Standby mode.	Press "  " to enter Standby mode.

ADDITIONAL INFORMATION

Function		Bluetooth Signal		Description		
		Usage Page	Usage ID	Standby	Projection Mode	Speaker Mode
		HID Code	HID Code			
Speaker mode on	●	0x0C	0x49	Press “●” to turn the Bluetooth speaker on. It takes up to 3 minutes to automatically pair with the Bluetooth device. If pairing is not successful, the projector enters Standby mode. Note: <ul style="list-style-type: none"> Only supports on Power Standby: SmartHome mode. The projector memorizes up to 10 Bluetooth devices. When the Bluetooth device is paired, you will hear an audible tone. 	Press “●” to pop up switch to Speaker mode confirmation message.	N/A
Projector OSD/ Quick menu	≡	0x07	0x76	N/A	Press “≡” to launch the on-screen display (OSD) menu. Note: Long press “≡” to open the Quick menu.	N/A
Note: For Quick menu, the Usage Page HID Code is 0x0C, and Usage ID HID Code is 0x76.						
Up		0x07	0x52	N/A	Press the four directional select buttons to select items or make adjustments to your selection.	N/A
Left		0x07	0x50			
Right		0x07	0x4F			
Down		0x07	0x51			
OK		0x07	0x58	N/A	Press the “OK” button to confirm your item selection.	N/A
Return	↶	0x0C	0x224	N/A	Press the “↶” button to return to the previous screen.	N/A
Home	⏠ ⊕	0x0C	0x223	N/A	Press the “⏠ ⊕” button to return to the Home screen. Note: Long press “⏠ ⊕” to enable/disable Air Mouse.	N/A
Note: Air Mouse cursor Enable / Disable is switched by the remote control, 0x0c 0x51 and 0x0C 0x53 only status ack to projector.						N/A

ADDITIONAL INFORMATION

Function		Bluetooth Signal		Description		
		Usage Page	Usage ID	Standby	Projection Mode	Speaker Mode
		HID Code	HID Code			
Android options/ Focus		0x07	0x73	Press the “  ” button to open a 3 rd party app > app options or select an app icon in order to uninstall/install the app. Note: Long press “  ” to adjust focus.	N/A	N/A
Note: For Focus adjustment, the Usage Page HID Code is 0x0C and Usage ID HID Code is 0x52.						N/A
Volume -		0x0C	0xEA	Press the “  ” button to decrease the volume. Note: Press “  ” repeatedly if necessary.	N/A	N/A
Volume +		0x0C	0xE9	Press the “  ” button to increase the volume. Note: Press “  ” repeatedly if necessary.	N/A	N/A

ADDITIONAL INFORMATION

Troubleshooting

If you experience a problem with your projector, please refer to the following information. If a problem persists, please contact your local reseller or service center.

Image problems

- ❓ *No image appears on-screen*
 - Ensure all the cables and power connections are correctly and securely connected as described on page 15.
 - Ensure the pins of connectors are not crooked or broken.

- ❓ *Image is out of focus*
 - Make sure the projection screen is between the required distance from the projector. Refer to page 55).
 - Use the remote control to adjust focus. Refer to page 34.

- ❓ *The image is stretched when displaying 16:9 DVD title*
 - When you play anamorphic DVD or 16:9 DVD, the projector will show the best image in 16: 9 format on projector side.
 - If you play 4:3 format DVD title, please change the format as 4:3 in projector OSD.
 - Please setup the display format as 16:9 (wide) aspect ratio type on your DVD player.

- ❓ *Image is too small or too large*
 - Move the projector closer to or further from the screen.
 - Press "≡" on the remote control, go to "OSD menu → Display → Aspect Ratio". Try the different settings.
 - Press "≡" on the remote control, go to "OSD menu → Display → Geometric Correction → Warp Calibration". Try the different settings.

- ❓ *Image has slanted sides:*
 - If possible, reposition the projector so that it is centered on the screen and below the bottom of the screen.

- ❓ *Image is reversed*
 - Select "OSD menu → Setup → Projection Mode" and adjust the projection direction.

- ❓ *No sound*
 - Please refer to the supported audio file format on page 48.
 - Ensure that the "Mute" feature is not turned on.
 - Ensure that the "Internal Speaker" feature is turned on. Refer to page 34.
 - Ensure that the sound is not set to Bluetooth output.

ADDITIONAL INFORMATION

- ❓ *No sound from HDMI ARC source*
 - Select “OSD menu → Audio → Digital Output → Bitstream/ PCM/ Auto”. Try the different settings.
- ❓ *Abnormal HDMI image*
 - Select “OSD menu → Display → HDMI 1 EDID/ HDMI 2 EDID/ HDMI 3 EDID” to “1.4” or “2.2”.
- ❓ *Blurry double image*
 - Make sure “OSD menu → 3D → 3D Mode” is not on to avoid normal 2D image appear blurry double image.
- ❓ *Two images, side-by-side format*
 - Set the “OSD menu → 3D → “3D Format” to “SBS”.

Other problems

- ❓ *The projector stops responding to all controls*
 - If possible, turn off the projector, then unplug the power cord and wait at least 20 seconds before reconnecting power.

Remote control problems

- ❓ *If the remote control does not work*
 - Check the operating angle of the remote control is pointed within $\pm 15^\circ$ to the IR receiver on the projector.
 - Make sure there are not any obstructions between the remote control and the projector.
 - Make sure to operate the remote control only in front of the projector.
 - Try to operate the remote control by pointing it to the projected image.
 - Charge battery if it is exhausted.
 - Make sure the remote control is paired successfully with the projector. Upon successful connection, when a button is press, the LED indicator on the remote control lights solid blue.

ADDITIONAL INFORMATION

LED lightning messages

Message	Power LED		Bluetooth LED	Temp LED	Lamp LED
	(Red)	(White)	(White)	(Red)	(Red)
Standby (Eco), Bluetooth is not paired	Steady light	N/A	N/A	N/A	N/A
Standby (Smart Home), Bluetooth is not paired	Flashing (0.5 sec off / 2 sec on)	N/A	N/A	N/A	N/A
Power on (Warming)	N/A	Flashing (0.5 sec off / 0.5 sec on)	N/A	N/A	N/A
Power on (Standard Operation)	N/A	Steady light	N/A	N/A	N/A
Power off (Cooling)	N/A	Flashing (0.5 sec off / 0.5 sec on). Back to Red steady light when cooling fan turns off	N/A	N/A	N/A
Bluetooth Pairing (Bluetooth Speaker mode)	N/A	N/A	Flashing (0.5 sec off / 0.5 sec on). Back to Standby mode when not paired within 3 mins.	N/A	N/A
Bluetooth Paired (Bluetooth Speaker Mode)	N/A	N/A	Steady light	N/A	N/A
Error (Lamp Failed)	Flashing	N/A	N/A	N/A	Steady
Error (Fan Failed)	Flashing	N/A	N/A	Flashing	N/A
Error (Over Temp)	Flashing	N/A	N/A	Steady light	N/A
Standby State (Burn in mode)	N/A	Flashing	N/A	N/A	N/A
Burn-in (Warming)	N/A	Flashing	N/A	N/A	N/A
Burn-in (Cooling)	N/A	Flashing	N/A	N/A	N/A
Burn-in (Lamp Lightning)	N/A	Flashing (3 sec on / 1 sec off)	N/A	N/A	N/A
Burn-in (Lamp Off)	N/A	Flashing (1 sec on / 3 sec off)	N/A	N/A	N/A

ADDITIONAL INFORMATION

- Power off:

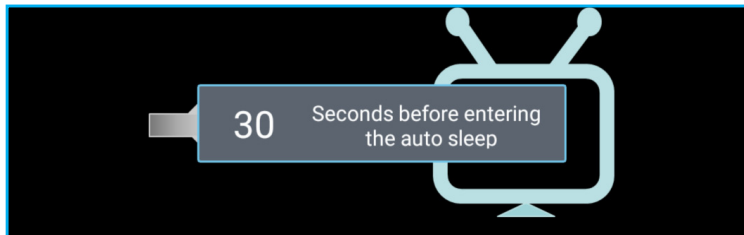

- Fan failed:

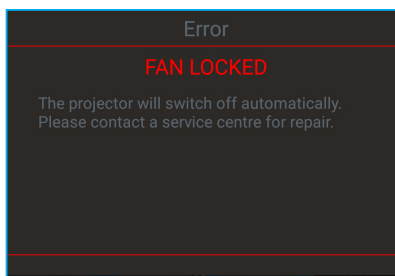

- Temperature warning:

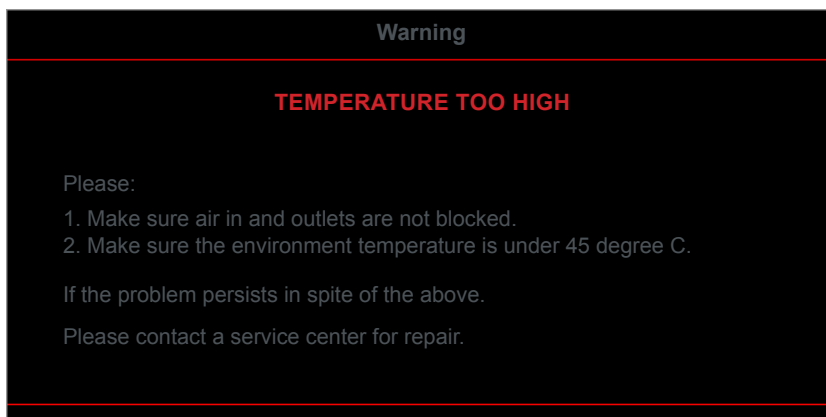

ADDITIONAL INFORMATION

Specifications

Optical	Description
Maximum resolution	- Graphic up to 2160p@60Hz - Maximum Resolution: HDMI1 (2.0b): 2160p@60Hz HDMI2 (2.0b): 2160p@60Hz HDMI3 (2.0b): 2160p@60Hz
Lens	Fixed Lens
Image size (diagonal)	85" ~ 105"
Projection distance	- 0.17m at 85" - 0.28m at 105"

Electrical	Description
Inputs	- HDMI V2.0 x3 Note: HDMI 1 (ARC) port supports 2 channels PCM, Dolby Digital, Dolby Digital Plus, Dolby Digital Plus With Atmos. - USB2.0 on the rear side - USB2.0 on the rear side (for service only) - USB2.0 on the right side (power support 5V---1.5A) - RJ-45 (IoT, Internet support and OTA functions)
Outputs	- Line out (3.5mm) - SPDIF Out (2 channels PCM, Dolby Digital)
Memory	- eMMC: 16GB (1x128Gb) - DDR: Supports up to 2GB memory, 1GB DDR848 is pre-installed
Color reproduction	1073.4 Million color
Scan rate	- Horizontal scan rate: 31 ~ 135KHz - Vertical scan rate: 24 ~ 120Hz
Built-in speaker	2x 19W speakers
Power requirement	100 - 240V ±10%, AC 50/60Hz
Power consumption	- Standby mode: < 0.5W - Network standby mode (excluding Ethernet port): < 2.0W - Network standby mode (WLAN): < 8.0W - Smart Home Mode: (>0.5W; <8W)
Input current	4A

Mechanical	Description
Installation orientation	Front and Rear
Dimensions (W x D x H)	- 576 x 383 x 114.7mm (without feet) - 576 x 383 x 129.7mm (with feet)
Weight	11 kg
Environmental conditions	Operating in 5 ~ 40°C , 10% to 85% humidity (non-condensing)

Note: All specifications are subject to change without notice.



ADDITIONAL INFORMATION

Optoma global offices

For service or support, please contact your local office.



USA

47697 Westinghouse Drive,
Fremont, CA 94539, USA
www.optomausa.com

 888-289-6786
 510-897-8601
 services@optoma.com



Canada

47697 Westinghouse Drive,
Fremont, CA 94539, USA
www.optomausa.com

 888-289-6786
 510-897-8601
 services@optoma.com

Latin America

47697 Westinghouse Drive,
Fremont, CA 94539, USA
www.optomausa.com

 888-289-6786
 510-897-8601
 services@optoma.com



Europe

Unit 1, Network 41, Bourne End Mills,
Hemel Hempstead, Herts,
HP1 2UJ, United Kingdom
www.optoma.eu
Service Tel : +44 (0)1923 691865

 +44 (0) 1923 691 800
 +44 (0) 1923 691 888
 service@tsc-europe.com



Benelux BV

Randstad 22-123
1316 BW Almere
The Netherlands
www.optoma.nl

 +31 (0) 36 820 0252
 +31 (0) 36 548 9052

France

Bâtiment E
81-83 avenue Edouard Vaillant
92100 Boulogne Billancourt, France

 +33 1 41 46 12 20
 +33 1 41 46 94 35
 savoptoma@optoma.fr



Spain

C/ José Hierro,36 Of. 1C
28522 Rivas VaciaMadrid,
Spain

 +34 91 499 06 06
 +34 91 670 08 32



Deutschland

Wiesenstrasse 21 W
D40549 Düsseldorf,
Germany

 +49 (0) 211 506 6670
 +49 (0) 211 506 66799
 info@optoma.de

Scandinavia



Lerpeveien 25
3040 Drammen
Norway

 +47 32 98 89 90
 +47 32 98 89 99
 info@optoma.no

PO.BOX 9515
3038 Drammen
Norway

Korea

WOOMI TECH.CO.,LTD.
4F, Minu Bldg.33-14, Kangnam-Ku,
Seoul,135-815, KOREA
korea.optoma.com

 +82+2+34430004
 +82+2+34430005



Japan

東京都足立区綾瀬3-25-18
株式会社オーエス
コンタクトセンター:0120-380-495

 info@os-worldwide.com
www.os-worldwide.com



Taiwan

12F., No.213, Sec. 3, Beixin Rd.,
Xindian Dist., New Taipei City 231,
Taiwan, R.O.C.
www.optoma.com.tw

 +886-2-8911-8600
 +886-2-8911-6550
 services@optoma.com.tw
asia.optoma.com



Hong Kong

Unit A, 27/F Dragon Centre,
79 Wing Hong Street,
Cheung Sha Wan,
Kowloon, Hong Kong

 +852-2396-8968
 +852-2370-1222
www.optoma.com.hk

China

5F, No. 1205, Kaixuan Rd.,
Changning District
Shanghai, 200052, China

 +86-21-62947376
 +86-21-62947375
www.optoma.com.cn

