

Full HD VideoWireless Kit

WHD200



WHD200 Transmitter



WHD200 Receiver

Please read the user manual and the quick installation guide so you can enjoy the product to the full extent.

Table of Contents

TABLE OF CONTENTS	1
1. IMPORTANT INFORMATION	2
SAFETY PRECAUTIONS	2
DANGER: BE CAREFUL WITH ELECTRICITY.....	2
2. INTRODUCTION	8
2.1 PACKING CONTENT.....	8
2.2 OVERVIEW	8
2.2 OVERVIEW	8
2.2.1 WHD200T (TX): PC TO TV TRANSMITTER.....	10
2.2.2 WHD200R (RX): PC TO TV RECEIVER	10
2.2.2 WHD200R (RX): PC TO TV RECEIVER	11
2.2.3 REMOTE CONTROLLER UNIT (RCU) INSTRUCTION	12
3. INSTALLATION	13
STEP1: SETUP THE WHD200T TRANSMITTER.....	13
STEP2: SETUP THE WHD200R RECEIVER	14
STEP3: SETUP THE IR BLASTER EXTENDER CABLE AND IR SENSOR EXTENDER CABLE	15
STEP 4: BOOT UP THE TRANSMITTER AND RECEIVER	16
STEP 5: MOUNTING THE WHD200 TO THE WALL	21
4. TROUBLESHOOTING	21
5. SUPPORTED RESOLUTION	24
6. AUDIO BIT RATE SUPPORT.....	26
7. PRODUCT SPECIFICATION	27



1. Important Information

Please take the time to read this user manual before using the WHD200T and WHD200R. It contains important information about operating your Full HD video wireless kit.

Our limited warranty applies when the product is handled properly for intended use, in accordance with its operating instruction. However, the warranty may be void in the following cases:

- Repair, product modification or alteration have been performed by unauthorized service personnel
- Damages caused by accidents, including but not limited to, lightning, water, fire, or moisture
- Use of an AC adapter not compatible with the product and its voltage rating
- The model number on the product has been altered, deleted, removed or made illegible.

Safety Precautions

	WARNING! RISK OF ELECTRICAL SHOCK DO NOT OPEN	
WARNING: TO REDUCE THE RISK OF ELECTRICAL SHOCK DO NOT REMOVE THE COVER NO USER-SERVICEABLE PARTS ARE INSIDE REFER SERVICING TO QUALIFIED PERSONNEL		



Danger: Be careful with electricity.

- Power to the units must be switched off before any work is undertaken, such as any AV device connection or TV connection.
- **Power outlet:** To prevent electric shock,

make sure to use the appropriate AC adapters as power supply to the transmitter and the receiver.

- **Power cord:** Be sure the power cord is routed so that it will not be stepped on or pinched by heavy items.
- **Power overloading:** Avoid overloading electrical outlets or extension cords which otherwise could result in electric shock or fire.
- **Lightning:** Disconnect the product from the power source if it is left unattended for a long period of time, and to protect the product from lightning.
- Always disconnect the power cord from the power outlet when you are not using your Full HD Video wireless kit. This reduces the risk of electric shocks or fire.



Warning

- This product should not be exposed to dripping or splashing. No object filled with liquids, such as vases, should be placed on the product.
- **Object Entry:** To avoid electric shock, never stick anything in the slots on the case or remove the cover.
- Place receiver/transmitter on a flat, hard and stable surface
- **Ventilation:** Do not block the ventilation slots on the receiver/transmitter or place any heavy object on the top cover. Blocking the air flow could damage the receiver. Arrange components so that air can flow freely around the receiver. Ensure that there is adequate ventilation if the receiver is placed in a stand. Put the receiver/transmitter in a property ventilated area, away from direct sunlight or any source of heat.
- **Water Exposure:** To reduce the risk of fire or electric shock, do not expose the receiver/transmitter to rain or moisture.
- **This is indoor solution.**
- **Our company has the right to modify this document without any notice.**

DECLARATION OF CONFORMITY

This device complies with Part 15 of the FCC Rules. Operation is subject to the following two conditions:

- (1) This device may not cause harmful interference, and
- (2) This device must accept any interference received, including interference that may cause undesired operation.

EMI (Electro Magnetic Interference) tested.

EN 55022 Information technology equipment----

Radio disturbance characteristics--- Limits and methods of measurement

EN 61000-3-2 Electromagnetic compatibility (EMC)---

Part 3-2: Limits---Limits for harmonic current emissions (equipment input current up to and including 16 A per phase)

EN 61000-3-3 Electromagnetic compatibility (EMC)---

Part 3: Limits---Section 3: Limitation of voltage changes, voltage fluctuations and flicker in public low-voltage supply systems, for equipment with rated current ≤ 16 A per phase and not subject to conditional connection

EN 55024 Information technology equipment----

Equipment---Immunity characteristics---Limits and methods of measurement

EN 301 489-1

Electromagnetic compatibility and Radio spectrum Matters (ERM); Electro Magnetic Compatibility (EMC) standard for radio equipment and services;

Part 1: Common technical requirements

EN 301 489-17

Electromagnetic compatibility and Radio spectrum Matters (ERM); Electro magnetic Compatibility (EMC) standard for radio equipment;

Part 17: Specific conditions for 2,4 GHz wideband transmission systems, 5GHz high performance RLAN equipment and 5,8 GHz Broadband Transmitting Systems

EN 60065 Audio › video and similar electronic apparatus—Safety requirements

TRADEMARK INFORMATION

- HDMI, the HDMI Logo and High-Definition Multimedia Interface are trademarks of HDMI Licensing LLC.

Special Notice

- Never use this product nearby an aircraft or medical facility. It can cause interference or undesirable effect on the operation result.
- Use of this product in the following locations may result in abnormal video and audio output (noise, blocked image... etc.).
 - Product installed in the walls made of concrete.
 - Product is situated near the refrigerator or metal fitment.
 - A cluttered room where the wireless signals may be blocked
- This product has been tested and manufactured to comply with each country's safety rules. However, there is no guarantee that interference will not occur in some installation scenario. If the interference happens, increase the distance between the transmitter and receiver.
- WHD200 may interfere 5GHz wireless devices, such as routers or other wireless devices. Therefore, if you have an 802.11n router, configure it to the 2.4 GHz band rather than the 5GHz band.
- Optimal range between WHD200 transmitter and receiver is between 2 and 20 meters within line of sight.



CAUTION of RF module on US region

- Any changes or modifications not expressly approved by the grantee of this device could void the user's authority to operate the equipment.
- This equipment must be installed and operated in accordance with provided instructions and the antenna(s) used for this transmitter must be installed to provide a separation distance of at least 20 cm from all persons and must not be co-located or operating in conjunction with any other antenna or transmitter. End-users and installers must be provided with antenna installation instructions and transmitter operating conditions for satisfying RF exposure compliance.
- Outdoor operations in the 5150 ~ 5250MHz, 5600~5650MHz band are prohibited.
- This device has no Ad-hoc capability for 5250~5350MHz and 5470~5725MHz.
- Outdoor operations in the 5470~5725MHz band are prohibited. This device could not be used in the 5600~5650MHz.
- The Device not operation in 5600~5650MHz.
- Industry Canada regulatory information Operation is subject to the following two conditions: (1) this device may not cause interference, and (2) this device must accept any interference, including interference that may cause undesired operation of the device.
- The user is cautioned that this device should be used only as specified within this manual to meet RF exposure requirements. Use of this device in a manner inconsistent with this manual could lead to excessive RF exposure conditions.
- The following statement must be included with all versions of this document supplied to an OEM or integrator, but should not be distributed to the end user.
 - This device is intended for OEM integrators only.
 - Please See the full Grant of Equipment document for other restrictions.
 - This device must be operated and used with a locally approved access point.

- The following regulatory and Safety notices must be published in documentation supplied to the end user of the product or system incorporating an adapter in compliance with local regulations, Host system must be labeled with "Contains FCC ID: XXX-XXXX", FCC ID displayed on label.

System Warning

FEDERAL COMMUNICATIONS COMMISSION INTERFERENCE STATEMENT

This equipment has been tested and found to comply with the limits for a Class B digital device, pursuant to Part 15 of the FCC Rules. These limits are designed to provide reasonable protection against harmful interference in a residential installation. This equipment generates, uses and can radiate radio frequency energy and, if not installed and used in accordance with the instructions, may cause harmful interference to radio communications. However, there is no guarantee that interference will not occur in a particular installation. If this equipment does cause harmful interference to radio or television reception, which can be determined by turning the equipment off and on, the user is encouraged to try to correct the interference by one or more of the following measures:

- Reorient or relocate the receiving antenna.
- Increase the separation between the equipment and receiver.
- Connect the equipment into an outlet on a circuit different from that to which the receiver is connected.
- Consult the dealer or an experienced radio/TV technician for help.



CAUTION: Using the System in the US

- Any changes or modifications not expressly approved by the grantee of this device could void the user's authority to operate the equipment.
- This equipment must be installed and operated in accordance with provided instructions and the antenna(s) used for this transmitter must be installed to provide a separation distance of at least 20 cm from all persons and must not be co-located or operating in conjunction with any other antenna or transmitter. End-users and installers must be provided with antenna installation instructions and transmitter operating conditions for satisfying RF exposure compliance.
- Outdoor operations in the 5150~5250MHz, 5600~5650MHz band are prohibited.
- This device has no Ad-hoc capability for 5250~5350MHz and 5470~5725MHz.
- Outdoor operations in the 5470~5725MHz band are prohibited. This device could not be used in the 5600~5650MHz.
- The device not operation in 5600~5650MHz.



CAUTION: Using this System in Canada

- Industry Canada regulatory information Operation is subject to the following two conditions:
 1. This device may not cause interference,
 2. This device must accept any interference, including interference that may cause undesired operation of the device.

The user is cautioned that this device should be used only as specified within this manual to meet RF exposure requirements. Use of this device in a manner inconsistent with this manual could lead to excessive RF exposure conditions.



Europe – EU Declaration of Conformity

This device complies with the essential requirements of the R&TTE Directive 1999/5/EC. The following test methods have been applied in order to prove presumption of conformity with the essential requirements of the R&TTE Directive 1999/5/EC:

- EN 60065: 2002+A1: 2006+A11: 2008+A2 2010
- Safety of Information Technology Equipment
- EN50371 : 2002
Generic standard to demonstrate the compliance of low power electronic and electrical apparatus with the basic restrictions related to human exposure to electromagnetic fields (10 MHz - 300 GHz) -- General public
- EN 301 893 V1.5.1: 2008
Broadband Radio Access Networks (BRAN); 5 GHz high performance RLAN; Harmonized EN covering essential requirements of article 3.2 of the R&TTE Directive
- EN 301 489-1 V1.8.1: 2008
Electromagnetic compatibility and Radio Spectrum Matters (ERM); ElectroMagnetic Compatibility (EMC) standard for radio equipment and services; Part 1: Common technical requirements
- EN 301 489-17 V2.1.1 2009
Electromagnetic compatibility and Radio spectrum Matters (ERM); ElectroMagnetic Compatibility (EMC) standard for radio equipment and services; Part 17: Specific conditions for 2,4 GHz wideband transmission systems and 5 GHz high performance RLAN equipment

Hereby, Zinwell declares that this Full HD Video wireless kit is in compliance with the essential requirements and other relevant provisions of Directive 1995/5/EC.



Industry Canada Statement

This device complies with RSS-210 of the Industry Canada Rules. Operation is subject to the following two conditions: (1) This device may not cause harmful interference, and (2) this device must accept any interference received, including interference that may cause undesired operation.

IMPORTANT NOTE: (IC: 9078A-ZRF31200)

Radiation Exposure Statement:

This equipment complies with IC radiation exposure limits set forth for an uncontrolled environment. This equipment should be installed and operated with minimum distance 20cm between the radiator & your body.

Caution:

- (i) the device for operation in the band 5150-5250 MHz is only for indoor use to reduce the potential for harmful interference to co-channel mobile satellite systems;
- (ii) high-power radars are allocated as primary users (i.e. priority users) of the bands 5250-5350 MHz and 5650-5850 MHz and that these radars could cause interference and/or damage to LE-LAN devices.

IMPORTANT NOTE:

In the event that these conditions can not be

met (for example certain laptop configurations or co-location with another transmitter), then the Canada authorization is no longer considered valid and the IC ID can not be used on the final product. In these circumstances, the OEM integrator will be responsible for re-evaluating the end product (including the transmitter) and obtaining a separate Canada authorization.

French translation:

Ce dispositif est conforme à la norme CNR-210 d'Industrie Canada applicable aux appareils radio exempts de licence. Son fonctionnement est sujet aux deux conditions suivantes: (1) le dispositif ne doit pas produire de brouillage préjudiciable, et (2) ce dispositif doit accepter tout brouillage reçu, y compris un brouillage susceptible de provoquer un fonctionnement indésirable.

NOTE IMPORTANTE: (IC: 9078A-ZRF31200)

Déclaration d'exposition aux radiations:

Cet équipement est conforme aux limites d'exposition aux rayonnements IC établies pour un environnement non contrôlé. Cet équipement doit être installé et utilisé avec un minimum de 20 cm de distance entre la source de rayonnement et votre corps.

- (i) les dispositifs fonctionnant dans la bande 5 150-5 250 MHz sont réservés uniquement pour une utilisation à l'intérieur afin de réduire les risques de brouillage préjudiciable aux

systèmes de satellites mobiles utilisant les mêmes canaux;

- (ii) De plus, les utilisateurs devraient aussi être avisés que les utilisateurs de radars de haute puissance sont désignés utilisateurs principaux (c.-à-d., qu'ils ont la priorité) pour les bandes 5 250-5 350 MHz et 5 650-5 850 MHz et que ces radars pourraient causer du brouillage et/ou des dommages aux dispositifs LAN-EL.

NOTE IMPORTANTE:

Dans le cas où ces conditions ne peuvent être satisfaites (par exemple pour certaines configurations d'ordinateur portable ou de certaines co-localisation avec un autre émetteur), l'autorisation du Canada n'est plus considéré comme valide et l'ID IC ne peut pas être utilisé sur le produit final. Dans ces circonstances, l'intégrateur OEM sera chargé de réévaluer le produit final (y compris l'émetteur) et l'obtention d'une autorisation distincte au Canada.

2. Introduction

WHD200 is a Full HD wireless transmission device.

This solution delivers uncompressed 1080p full HD video and audio content to your existing HDTV set wirelessly. It operates the transmission in 4.9 GHz~ 5.9 GHz frequencies and it can adjust its communication frequency automatically in case of interference from another RF system. With built-in Omni-directional antennas, it can transmit uncompressed video content to 20 meters (66 feet) LOS (Line of sight) with no latency.

Both IR Sensor Extender Cable and IR Blaster Extender Cable are included in the package so users can point their remote control of the AV source at the receiver directly for device operation.

2.1 Packing Content

Please check whether the following items are present in the package. If any items missed or damaged, please call your dealer.

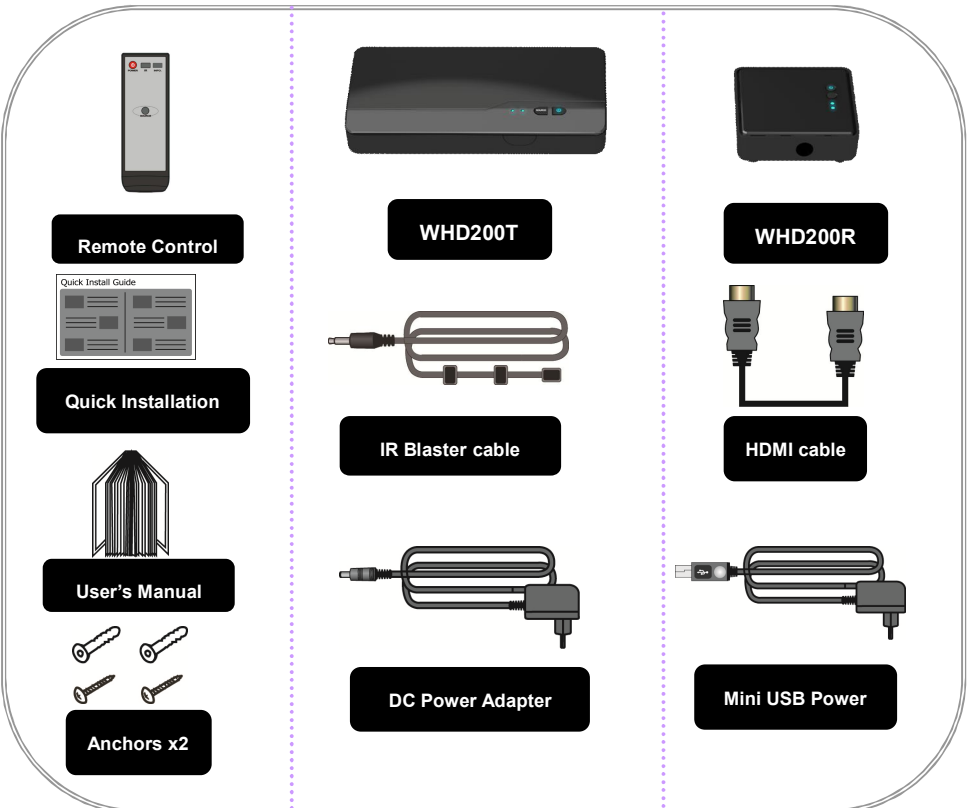

2.2 Overview

2.2.1 WHD200T (TX): PC to TV Transmitter

■ Front Panel Buttons and LEDs

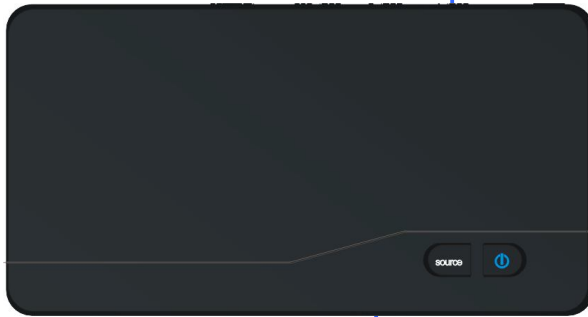

② Source Selection Button
Press to switch Source inputs of the transmitter.

① Power Button with LED Indicator
Press to turn the transmitter on and off. The indicator in the power button is lit in solid blue when the power is on, and turns red in standby mode.

③ Source LEDs
These two LED indicators are lit in solid blue to show current input you switch.

■ Main Unit Back Panel



③ IR OUT Blaster Extender Jack
Plug the IR Blaster Extender Cable into the IR OUT jack of ...

④ HDMI OUT
Connect Transmitter to High-definition audio/video devices that have an HDMI port using a provided HDMI cable.

② HDMI OUT
Connect to HDTV set via an HDMI cable.

① DC IN
For connecting the SWW1810T power adapter.

2.2.2 WHD200R (RX): PC to TV Receiver

■ Front Panel Buttons and LEDs



❶ Power Button with LED indicator

Press to turn the receiver on and off. The indicator in the power button lights up in blue when the power is on, and turns red in standby mode.

❸ Source LEDs

For HDMI1 and HDMI2 selected indication.

❷ Source Button

Press this button for Source input selection.

■ Main Unit Back Panel

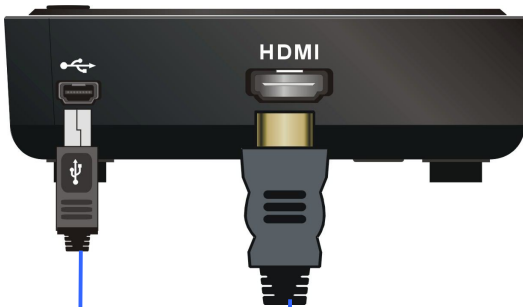

❷ DC IN

Connect to receiver's power adapter.

❶ HDMI OUT

Connect to HDTV set via an HDMI cable.

2.2.3 Remote Controller Unit (RCU) Instruction

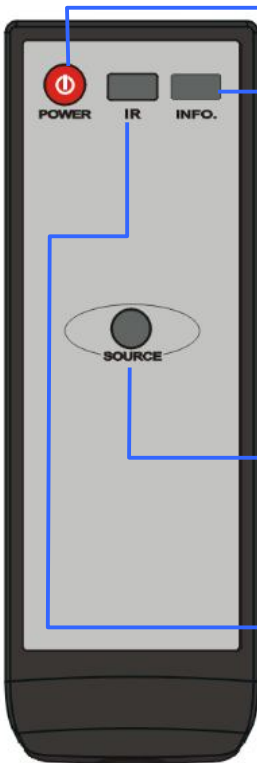

① POWER Button

Press to turn the Transmitter & Receiver on/off.

When both of TX & RX Power LEDs are red, press Power button either TX OR RX, it can wake up each other automatically.

② INFO. Button

Press this button to display OSD for system related information on HDTV connected on receiver.

③ SOURCE Button

Press to switch the audio/video sources input connected to transmitter directly.

④ IR Button

Press to switch the IR Blaster frequency to meet Source device's requirement. It can switch IR Blaster frequency 47K to 56K to 36K recurring.

3. Installation

Step1: Setup the WHD200T transmitter

Connect Two High-Definition Audio/Video Sources to the transmitter:

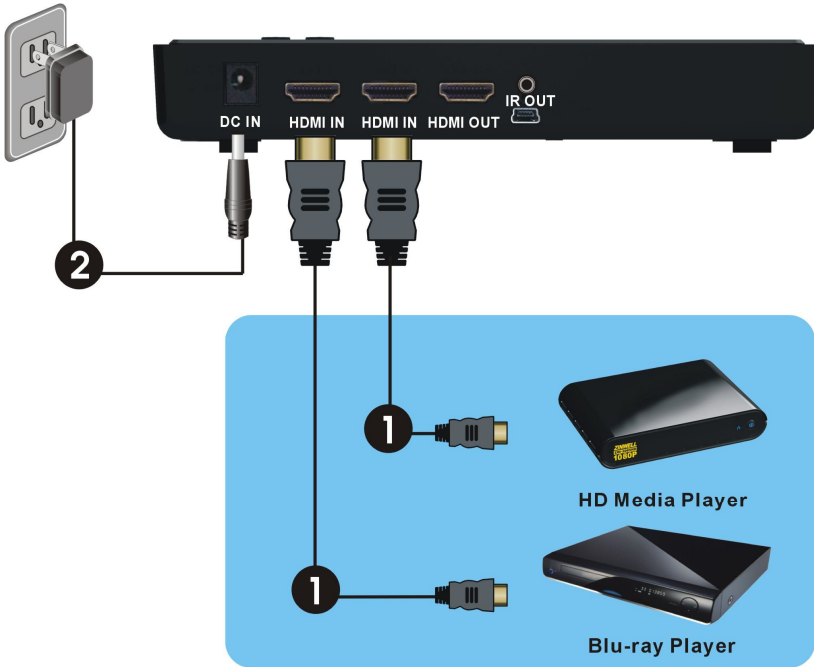

- (1) Connect the transmitter's "HDMI IN" to the High-Definition AV sources' "HDMI OUT" through by HDMI cable. The transmitter has two HDMI inputs for the High-Definition source device, like PS3, Blu-ray Player.
- (2) Connect the transmitter's "HDMI OUT" to the HDTV set's "HDMI IN" port with an HDMI cable for the loop-through connection.
- (3) Connect the supplied power adapter to the DC IN jack of the transmitter and a wall socket. The LED indicator in the POWER button lights up in blue when the WHD200T is connected to the power mains.

Step2: Setup the WHD200R receiver

HDTV set Connection with WHD200R:

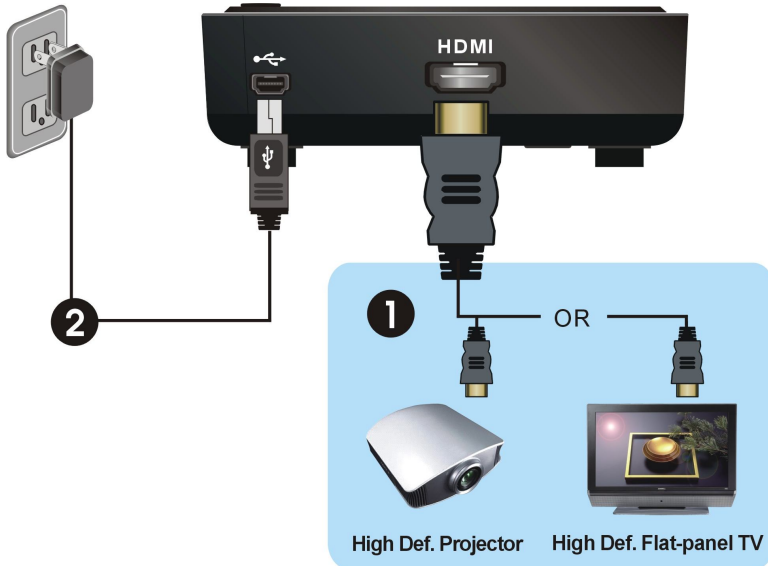

- (1) Connect the HDMI cable to the HDMI OUT jack of the receiver and to your HDTV set (or an HD projector). Press the **Source / Input** button of your TV's remote to select the appropriate "HDMI" video input.
- (2) Connect the supplied power adapter to the DC IN jack of the receiver and a wall socket. The POWER LED indicator lights up in blue when the receiver is connected to the power mains.

Touchboards

205 Westwood Ave, Long Branch, NJ 07740
Phone: 866-94 BOARDS (26273) / (732)-222-1511
Fax: (732)-222-7088 | E-mail: sales@touchboards.com

Step3: Setup the IR blaster extender cable and IR sensor extender cable

If necessary, connect the Infrared (IR) blaster (or sensor) Extender cable. Users can point hand-held remote control of your High Definition AV equipment at the receiver or the HDTV set to operate the source devices, not exceeding the distance of 66 feet at Line-of-sight.

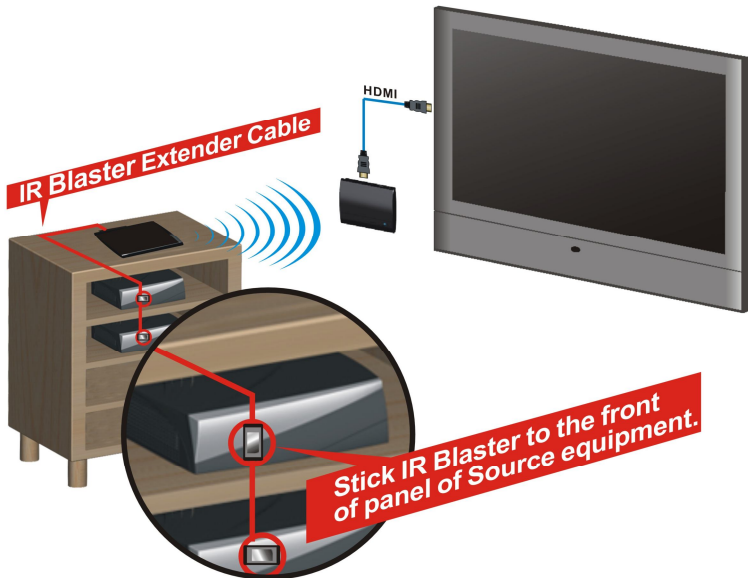

- (1) Plug the IR blaster cable into the IR OUT jack of the transmitter.
- (2) Please try to manually move the IR blaster in the front of the front panel of your HD device and then press the key of remote control to search a good position of IR response. Paste the IR blaster head near the front of IR sensor of your High-Definition audio/video devices.
- (3) When the IR blaster cable is connected, it relays infrared command from your remote control to the device. Users can control their AV devices by pointing their remote control to the receiver instead of to their AV equipment.
- (4) If the receiver will be out of the direct line of sight of your remote controls, plug the IR Sensor Extender cable into the IR IN jack of the receiver and place the IR sensor on the front of TV for operation.

Note:

- (1) The IR sensor supports 36KHz ~ 56KHz (NEC, RC5, RC6) remote's signal protocol. Therefore, it is possible that some devices may not be supported.
- (2) The IR blaster supports 47KHz remote' signal protocol.

Step 4: Boot up the Transmitter and Receiver

- (1) Place the two AAA batteries into the remote control.

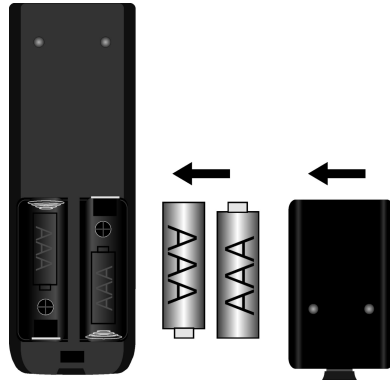

- (2) After the power cord is plugged into the electrical outlet, the WHD200 will be turned on automatically.



- (3) If it is in Standby mode (Both POWER LED of transmitter and receiver are lit in red), press the POWER button either transmitter or receiver to turn on the transmitter and the receiver. Same condition for remote control operation.



- (4) If transmitter's HDMI out display is on (Transmitter POWER LED is lit in purple) and receiver stay in Standby mode (Receiver POWER LED is lit in red), press the POWER button of receiver or transmitter to wake up system and will make wireless connection automatically between transmitter and the receiver.

- (5) During the warm-up, the POWER LED will blink in blue until the signal link between the WHD200T and the WHD200R is established. It will take 15 ~ 20 seconds for system boot up successfully.

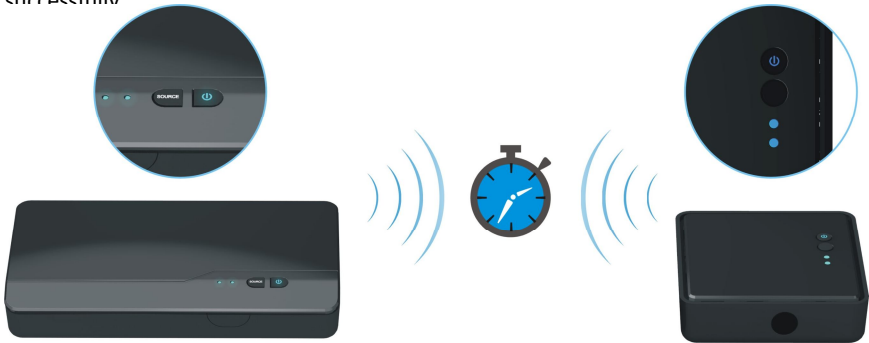



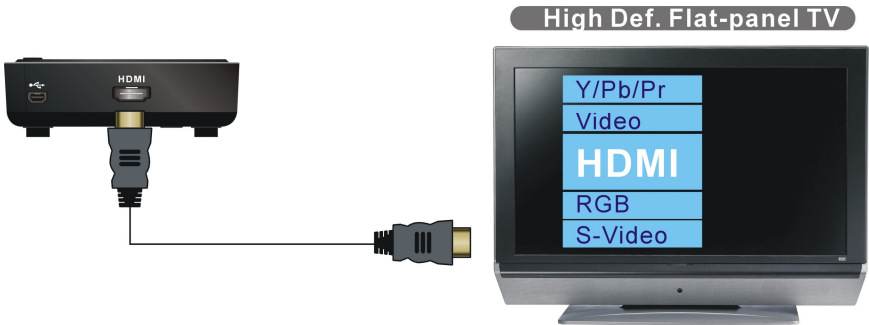

- (6) Ensure your TV set or projector is in "HDMI input" mode, and is already powered on.

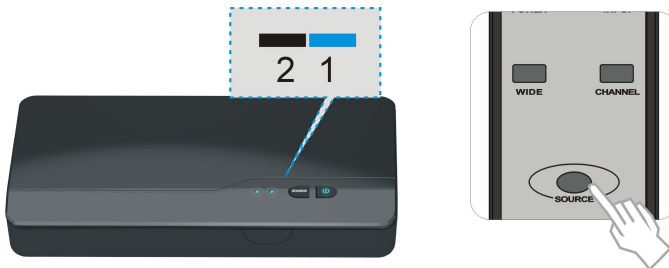

- (7) Press the Source button on the RCU or on the top of receiver / transmitter for Source input switch until you see the video being broadcasted from your device.



- (8) If all operation is normal, the POWER LED and INFO./CHANNEL LED will glow in solid blue. Please refer to the below form containing detailed LED indicator and OSD description of transmitter / receiver:

Item / Mode	Status Description	Power LED (on RX)	Status LED (on RX)	OSD Display (on RX)
Standby	For power saving mode.	Static Red	off	
Initial Boot up / Warm up	It will spend 15 ~ 20 seconds for system boot up.	Blinking Blue	Blinking	 4 level, looping.
Searching available channels	Continuing search available channels if system can't establish link over 80s after initialization. (Note A & D)	Blinking Blue	Blinking	 Looping display these two OSD
Wireless linked Mode	No input from selected source (Note B)	Static Blue	Blinking (Quickly)	
	Video format not recognized (Note C)	Static Blue	Blinking (Slowly)	
	Video format is recognized	Static Blue	Static Blue	-

Note:

- A. If the RF connection over 80sec and still not established, it might link lost or the transmitter is most likely out of range. You may have to verify the range and adjust or shorten the distance between your HDTV set with the transmitter and the receiver. The maximum video transmission range for 1080p content is up to 66 feet in line of sight (LOS). < The minimum range is 6.5 feet. >
- B. Please make sure the computer have been power on and switched the signal output to HDMI out; also try to re-plug the HDMI cable to make sure the HDMI connector had settled well.
- C. If there is no video displayed and OSD displayed “Not Supported Format”, this is an indication that the video frame rate from the computer is not supported, please refer chapter 5 to switch a supported video timing.
- D. If you have more than one pair of WHD200, each transmitter and receiver should be at least 6.5 feet away from one another. If both the transmitter and the receiver exist in the same room, the suggested the distance between the two is 6.5 feet minimum.

(9) On Screen Display (OSD) vs. RCU Instruction

❶ On Active mode, **Press the POWER button on the top of Receiver or press RCU Power button point to receiver, receiver enter Standby mode and transmitter’s HDMI out is on.**

OSD Displayed: (Display 3secs and then enter Standby mode.)



❷ On Active mode, **Press the POWER button on the top of Transmitter or press RCU Power button point to transmitter, both transmitter and receiver will enter Standby mode.**

OSD Displayed: (Display 3secs and then enter Standby mode.)



❸ **Press the INFO button on the RCU, and Signal Quality, Source, Channel and resolution will be displayed for user reference.**

OSD Displayed: (Press again for exit.)

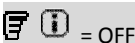

③ Press the SOURCE button on the RCU or on the top of transmitter (or receiver) for audio/video source input selection.

OSD Displayed:



The OSD display shows a speaker icon with a mute symbol, a signal strength indicator, and the text "HDMI1 CH10 1280x1024".

or



The OSD display shows a speaker icon with a mute symbol, a signal strength indicator, and the text "HDMI2 CH10 1280x1024".

④ Press the IR button of RCU for change IR Blaster frequency, enable to switch IR Blaster frequency 47K to 56K to 36K recurring. (Note : IR blaster frequency default setting is 47KHz)

Press once for current IR frequency status display. The OSD shows:



The OSD display shows a speaker icon with a mute symbol, a signal strength indicator, and the text "HDMI1 CH10 1280x1024".

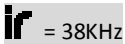

The IR frequency status display shows the text "ir = 38KHz".

Press IR key again to switch IR blaster frequency. The OSD shows:



The OSD display shows a speaker icon with a mute symbol, a signal strength indicator, and the text "HDMI1 CH10 1280x1024".

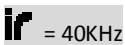

The IR frequency status display shows the text "ir = 40KHz".

NOTE: Only the status of the WHD200R (receiver) connected to the HDTV can be displayed on the OSD. The status of the WHD200T (transmitter) HDMI out cannot be displayed.

Step 5: Mounting the WHD200 to the Wall

- (1) Refer the drawing of the bottom page that have relative position of the main holes and attach this paper on wall.

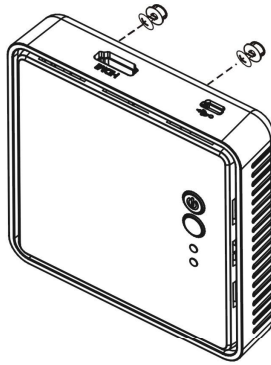
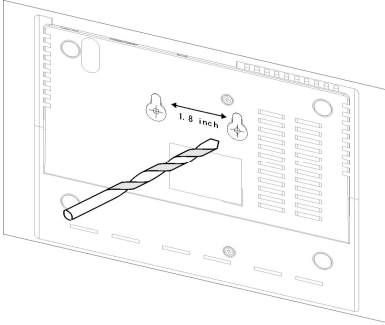

- (2) Drill pilot holes.
- (3) Insert the supplied two Anchors into the wall.

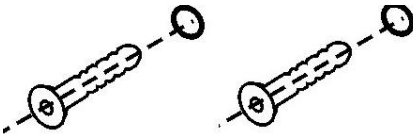



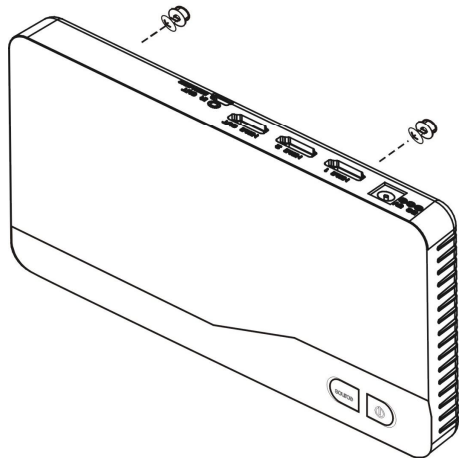
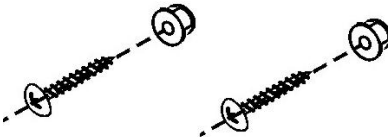



- (4) Insert two screws into the anchors. Leave 1/8" length for mounting the Transmitter or receiver
- (5)





- (6) Place WHD200 main holes over the protruding screws and slide down into position.

4. Troubleshooting

Problem	Solution
The WHD200 power indicator LED doesn't light up.	<ul style="list-style-type: none"> • Check if the power plugs of WHD200T/WHD200R are properly inserted into a functioning power outlet.
No video is displayed on your TV screen.	<ul style="list-style-type: none"> • Verify that the proper cables have been selected and installed between the WHD200T (transmitter) input and your High-Definition device output. • On your TV side (connected to the WHD200R), select the HDMI as input source. • Verify the POWER LED and SOURCE LED indicator of WHD200. <p>Power LED Flashing in Blue</p> <p>OSD displayed:  (4 levels looping)</p> <ul style="list-style-type: none"> * Ensure the transmission range between the transmitter and the receiver is NOT over 66 feet (LOS-line of sight) transmission distance. * Try to move the transmitter closer to the receiver. <p>POWER LED in Solid Blue + Slow and Flashing SOURCE LED</p> <p>OSD displayed :  </p> <ul style="list-style-type: none"> * Ensure your video resolution and frame rate is recognized/ supported and within the transmission range. *Connect the source device to your TV to check and modify the video format compatibility. *Check if your video resolution with HDMI input from your device is set among 1080p, 1080i, 720p, 576p, or 480p. Please refer Chapter 5 for the detail supported Resolution. <p>POWER LED in Solid Blue STATUS LED Flash Quickly</p> <p>OSD displayed :  </p> <ul style="list-style-type: none"> * Ensure the proper cables are connected between the transmitter and

	<p>your AV source devices.</p> <ul style="list-style-type: none"> * Ensure your source devices connected to the WHD200 transmitter are powered on. * Ensure the proper cables are connected between the receiver and your 2nd HDTV near the receiver.
Poor picture quality or intermittent video.	<ul style="list-style-type: none"> • Check if your video resolution with HDMI input from your device is either 1080p, 1080i, 720p, 576p, or 480p. Please refer to the "Supported Resolution" chapter where the video frame rate from your HD AV device WHD200 can support is defined. • Ensure the transmission distance is less than 66 feet (LOS).
No audio.	<ul style="list-style-type: none"> • Check your TV's volume is properly set and not set in "MUTE" mode. • Check if your source player's audio volume has been turned up.. • Ensure the bit rate of audio from the source device can be supported by WHD200. Please refer to the details in Chapter 6, Audio Bit Rate Support.
IR Blaster can't control Source device.	<ul style="list-style-type: none"> • Check where is IR sensor of Source device. Make sure IR Blaster sensor is close and straight to Source device's IR sensor. Please refer Chapter 3, step 3 for reference setup. Change IR Blaster frequency to meet Source device's requirement. See the page 20 for the IR blaster frequency switch.
No 3D video output	<p>OSD displayed : TX  or/and RX </p> <ul style="list-style-type: none"> * Check both of TVs (include Tx and Rx side) should support 3D video format. Either one of TV only support 2D format, then 3D output might not supported. * If user wants to display 3D video on HDTV which supported 3D video, please turn off 2D HDTV and RE-power on 3D HDTV. Then set the source player to 3D video format output for the 3D display. * Check the video output setting of Source player (ex. Blu-ray Disc, PS3..etc.). If the video output setting of Source player is 3D video format, It might be abnormal display on HDTV which not supports 3D format. * 3D video format do not support on current equipments status. If user wants to display 3D video on HDTV which supported 3D video, please turn off 2D HDTV and RE-power on 3D HDTV. Then set the source player to 3D video format output for the 3D display.

5. Supported Resolution

If the SOURCE LED continues to blink in blue (slower than “no signal” mode); OSD display:  , and there is no video displayed or the video quality suffers, it indicates that the video frame rate from your A/V source device is not supported. Ensure that the consumer timing of your HD device is compliant with the standard listed below:

 Video Format Timings	Resolution	Support
Primary CEA Video Timing		
640x480p @ 59.94 / 60Hz	480p	YES
720x480p @ 59.94Hz		YES
720x480p @ 60Hz		YES
720x576p @ 50Hz	576p	YES
1280x720p @ 50Hz	720p	YES
1280x720p @ 59.94 / 60Hz		YES
1920x1080i @ 50Hz	1080i	YES
1920x1080i @ 59.94 / 60Hz		YES
1920x1080p @ 50Hz	1080p / 60	YES
1920x1080p @ 59.94 / 60Hz		YES
Secondary CEA Video Timing		
1920x1080p @ 23.98 / 24Hz	1080p / 24	YES
1920x1080p @ 25Hz		YES
1920x1080p @ 29.97 / 30Hz		YES
VESA Timing (DVI only)		
640x480 @ 59.94 / 72.809Hz	VGA	YES
800x600 @ 60.317 / 72.188Hz	SVGA	YES
1024x768 @ 60 / 70.069Hz	XGA	YES
1280x768 @ 60 Hz	WXGA	YES
1280x1024 @ 60 Hz	SXGA	YES
1600x1200 @ 60Hz	UXGA	YES

Mandatory CEA 3D Video Format Timings	Support
1280x720p @ 50Hz Top-and-Bottom	YES
1280x720p @ 50Hz Frame packing	YES
1280x720p @ 59.94 / 60Hz Top-and-Bottom	YES
1280x720p @ 59.94 / 60Hz Frame packing	YES
1920x1080i @ 50Hz Side-by-Side (Half)	YES
1920x1080i @ 59.94 / 60Hz Side-by-Side (Half)	YES
1920x1080p @ 23.98 / 24Hz Top-and-Bottom	YES
1920x1080p @ 23.98 / 24Hz Frame packing	YES

6. Audio Bit Rate Support

- Digital Audio from HDMI inputs: Up to 6Mbit/s bit-rate support.
- Support AC3 and DTS.
- 2-channel PCM: 16~24 bits audio sample with 32~96KHz sampling rate as below:

2channel PCM	32KHz	44.1KHz	48KHz	96KHz
16 bits	YES	YES	YES	YES
24 bits	YES	YES	YES	YES

7. Product Specification

General Specifications			
Supported Video Resolutions	HDMI Input	1080p, 1080i, 720p, 576p, 480p	
Supported Audio Formats	Digital Audio	Up to 6 Mbps AC3 and DTS	
Transmission Distance		The maximum video transmission range is 20 meters (66 feet) (The minimum range is 2 meters) Line of sight (LOS) scenarios	
System Latency		No latency (<1ms)	
Antenna		High Performance Internal Antennas	
Operating Frequencies		4.9~ 5.9GHz (Include non-DFS and DFS Frequency Bands)	
Power Supply		100~ 240V AC in, 5V 2A DC out Power Adaptor	
Operating Temperature		0~40°C	
Interfaces		WHD200T	WHD200R
A/V Interfaces	HDMI Input	TWO (Type A)	-
	HDMI Output	One (Type A)	One (Type A)
Control Signal Interfaces	IR Sensor	YES	YES
	IR Blaster Extender	2.5mm Jack	-
	IR Sensor Extender	-	YES
Power Interface	Power Input	5V DC Jack	5V mini USB
Switches	Front Power Switch	YES (One Tack Switch)	YES (One Tack Switch)
	Front Source Switch	YES (One Tack Switch)	YES (One Tack Switch)
LEDs	Power LED	1 x LED (Two Tone: Blue/Red)	1 x LED (Two Tone: Blue/Red)
	Source LED	2 x Blue LED	2 x Blue LED
	Signal Quality Status	-	OSD Displayed
Dimensions (mm ³)		182(W) x 96.5(L) x 31.5(H)	95(W) x 95(L) x 31.5(H) mm



Touchboards

205 Westwood Ave, Long Branch, NJ 07740
Phone: 866-94 BOARDS (26273) / (732)-222-1511
Fax: (732)-222-7088 | E-mail: sales@touchboards.com