

# DLP® Projector

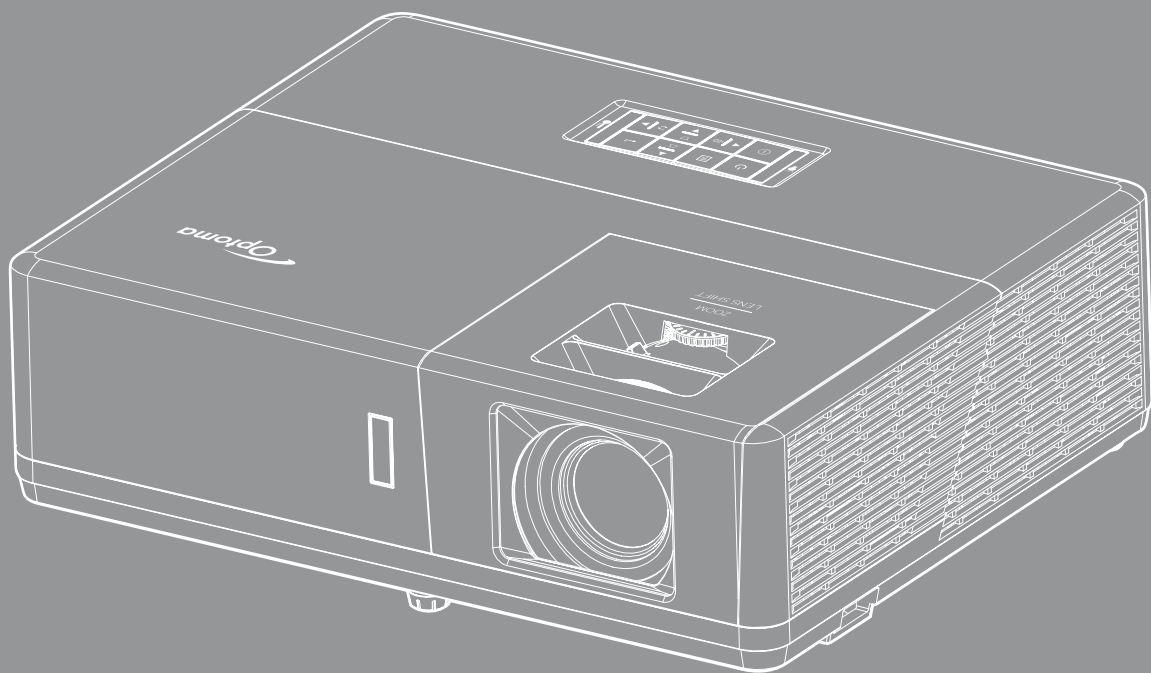

# TABLE OF CONTENTS

<b>SAFETY .....</b>	<b>4</b>
<i>Important Safety Instruction.....</i>	<i>4</i>
<i>Laser Radiation Safety Information .....</i>	<i>5</i>
<i>Copyright .....</i>	<i>6</i>
<i>Disclaimer.....</i>	<i>6</i>
<i>Trademark Recognition .....</i>	<i>6</i>
<i>FCC .....</i>	<i>6</i>
<i>Declaration of Conformity for EU countries .....</i>	<i>7</i>
<i>WEEE .....</i>	<i>7</i>
<b>INTRODUCTION .....</b>	<b>8</b>
<i>Package Overview.....</i>	<i>8</i>
<i>Standard accessories .....</i>	<i>8</i>
<i>Optional accessories .....</i>	<i>8</i>
<i>Product Overview .....</i>	<i>9</i>
<i>Connections.....</i>	<i>10</i>
<i>Keypad .....</i>	<i>12</i>
<i>Remote control.....</i>	<i>13</i>
<b>SETUP AND INSTALLATION .....</b>	<b>14</b>
<i>Installing the projector .....</i>	<i>14</i>
<i>Connecting sources to the projector.....</i>	<i>16</i>
<i>Adjusting the projector image .....</i>	<i>19</i>
<i>Remote setup .....</i>	<i>20</i>
<b>USING THE PROJECTOR.....</b>	<b>22</b>
<i>Powering on / off the projector.....</i>	<i>22</i>
<i>Selecting an input source .....</i>	<i>23</i>
<i>Menu navigation and features .....</i>	<i>24</i>
<i>OSD Menu tree.....</i>	<i>25</i>
<i>Display image settings menu.....</i>	<i>33</i>
<i>Display 3D menu .....</i>	<i>36</i>
<i>Display aspect ratio menu .....</i>	<i>37</i>
<i>Display edge mask menu .....</i>	<i>40</i>
<i>Display zoom menu .....</i>	<i>40</i>
<i>Display image shift menu .....</i>	<i>40</i>
<i>Display geometric correction menu .....</i>	<i>40</i>
<i>Audio mute menu .....</i>	<i>41</i>
<i>Audio volume menu.....</i>	<i>41</i>
<i>Audio mic volume menu .....</i>	<i>41</i>
<i>Audio audio input menu.....</i>	<i>41</i>
<i>Setup projection menu.....</i>	<i>42</i>
<i>Setup screen type menu.....</i>	<i>42</i>

<i>Setup power settings menu</i> .....	42
<i>Setup security menu</i> .....	43
<i>Setup HDMI link settings menu</i> .....	43
<i>Setup test pattern menu</i> .....	44
<i>Setup remote settings menu</i> .....	44
<i>Setup projector ID menu</i> .....	44
<i>Setup options menu</i> .....	44
<i>Setup reset OSD menu</i> .....	45
<i>Network LAN menu</i> .....	46
<i>Network control menu</i> .....	47
<i>Setup network control settings menu</i> .....	48
<i>Info menu</i> .....	53



## **MAINTENANCE ..... 54**

<i>Installing and cleaning the dust filter</i> .....	54
------------------------------------------------------	----

## **ADDITIONAL INFORMATION ..... 55**

<i>Compatible resolutions</i> .....	55
<i>Image size and projection distance</i> .....	58
<i>Projector dimensions and ceiling mount installation</i> .....	61
<i>IR remote codes</i> .....	62
<i>Troubleshooting</i> .....	64
<i>Warning indicators</i> .....	66
<i>Specifications</i> .....	67
<i>Optoma global offices</i> .....	68

# SAFETY

	The lightning flash with arrow head within an equilateral triangle is intended to alert the user to the presence of uninsulated "dangerous voltage" within the product's enclosure that may be of sufficient magnitude to constitute a risk of electric shock to persons.
	The exclamation point within an equilateral triangle is intended to alert the user to the presence of important operating and maintenance (servicing) instructions in the literature accompanying the appliance.

Please follow all warnings, precautions and maintenance as recommended in this user's guide.

## Important Safety Instruction



- Do not stare into the beam, RG2.  
As with any bright source, do not stare into the direct beam, RG2 IEC 62471-5:2015.
- Do not block any ventilation openings. To ensure reliable operation of the projector and to protect from over heating, it is recommended to install the projector in a location that does not block ventilation. As an example, do not place the projector on a crowded coffee table, sofa, bed, etc. Do not put the projector in an enclosure such as a book case or a cabinet that restricts air flow.
- To reduce the risk of fire and/or electric shock, do not expose the projector to rain or moisture. Do not install near heat sources such as radiators, heaters, stoves or any other apparatus such as amplifiers that emits heat.
- Do not let objects or liquids enter the projector. They may touch dangerous voltage points and short out parts that could result in fire or electric shock.
- Do not use under the following conditions:
  - In extremely hot, cold or humid environments.
    - (i) Ensure that the ambient room temperature is within 5°C ~ 40°C
    - (ii) Relative humidity is 10% ~ 85%
  - In areas susceptible to excessive dust and dirt.
  - Near any appliance generating a strong magnetic field.
  - In direct sunlight.
- Do not use the unit if it has been physically damaged or abused. Physical damage/abuse would be (but not limited to):
  - Unit has been dropped.
  - Power supply cord or plug has been damaged.
  - Liquid has been spilled on to the projector.
  - Projector has been exposed to rain or moisture.
  - Something has fallen in the projector or something is loose inside.
- Do not place the projector on an unstable surface. The projector may fall over resulting in injury or the projector may become damaged.
- Do not block the light coming out of the projector lens when in operation. The light will heat the object and may melt, cause burns or start a fire.
- Please do not open or disassemble the projector as this may cause electric shock.
- Do not attempt to service the unit yourself. Opening or removing covers may expose you to dangerous voltages or other hazards. Please call Optoma before you send the unit for repair.
- See projector enclosure for safety related markings.

- The unit should only be repaired by authorized service personnel.
- Only use attachments/accessories specified by the manufacturer.
- Do not look into straight into the projector lens during operation. The bright light may harm your eyes.
- This projector will detect the life of the light source itself.
- When switching the projector off, please ensure the cooling cycle has been completed before disconnecting power. Allow 90 seconds for the projector to cool down.
- Turn off and unplug the power plug from the AC outlet before cleaning the product.
- Use a soft dry cloth with mild detergent to clean the display housing. Do not use abrasive cleaners, waxes or solvents to clean the unit.
- Disconnect the power plug from AC outlet if the product is not being used for a long period of time.
- Do not setup the projector in places where it might be subjected to vibration or shock.
- Do not touch the lens with bare hands.
- Remove battery/batteries from remote control before storage. If the battery/batteries are left in the remote for long periods, they may leak.
- Do not use or store the projector in places where smoke from oil or cigarettes may be present, as it can adversely affect the quality of the projector performance.
- Please follow the correct projector orientation installation as non standard installation may affect the projector performance.
- Use a power strip and or surge protector. As power outages and brown-outs can KILL devices.

## Laser Radiation Safety Information

- This product is classified as CLASS 1 LASER PRODUCT - RISK GROUP 2 of IEC60825-1 : 2014 and also complies with 21 CFR 1040.10 and 1040.11 as a Risk Group 2, LIP (Laser Illuminated Projector) as defined in IEC 62471:2006 except for deviations pursuant to Laser Notice No. 50, dated June 24, 2007.

 <p>Complies with 21 CFR 1040.10 and 1040.11 as a Risk Group 2, LIP (Laser Illuminated Projector) as defined in IEC 62471:2006 except for deviations pursuant to Laser Notice No. 50, dated June 24, 2007</p>				
<p>IEC 60825-1:2014 CLASS 1 LASER PRODUCT RISK GROUP 2</p>	<p>IEC 60825-1:2014 PRODUIT LASER DE CLASSE 1 GROUPE DE RISQUE 2</p>	<p>IEC 60825-1:2014 1类激光产品 危险组2</p>	<p>IEC 60825-1:2014 1등급 레이저 제품 위험 그룹 2</p>	<p>IEC 60825-1:2014 クラス1レーザー製品 リスクグループ 2</p>
<p>CAUTION Possibly hazardous optical radiation emitted from this product. Do not stare at beam. May be harmful to the eye.</p>	<p>AVERTISSEMENT Radiation optique à danger potentiel émise par ce produit. Ne regardez pas directement le faisceau laser. Ceci pourrait être nocif pour votre oeil.</p>	<p>注意 此产品可能会产生危险激光辐射。请勿直视操作光束，以免对眼睛损害。</p>	<p>주의 이 제품으로부터 인체에 위험한 광선이 방사될 수 있음. 광원을 정면으로 바라보지 마시오. 눈에 심각한 손상을 입을 수 있음.</p>	<p>注意 本製品より危険となりうる光放射あり。ビームをのぞき込まないこと。眼に有害となる可能性あり。</p>



### Failure to comply with the following could result in death or serious injury.

- This projector has built-in Class 4 laser module. Disassembly or modification is very dangerous and should never be attempted.
- Any operation or adjustment not specifically instructed by the user's guide creates the risk of hazardous laser radiation exposure.
- Do not open or disassemble the projector as this may cause damage by the exposure of laser radiation.
- Do not stare into beam when the projector is on. The bright light may result in permanent eye damage.
- When turning on the projector, make sure no one within projection range is looking at the lens.
- Without following the control, adjustment or operation procedure may cause damage by the exposure of laser radiation.
- Adequate instructions for assembly, operation, and maintenance, including clear warnings concerning precautions to avoid possible exposure to laser.

## Copyright

This publication, including all photographs, illustrations and software, is protected under international copyright laws, with all rights reserved. Neither this manual, nor any of the material contained herein, may be reproduced without written consent of the author.

© Copyright 2018

## Disclaimer

The information in this document is subject to change without notice. The manufacturer makes no representations or warranties with respect to the contents hereof and specifically disclaims any implied warranties of merchantability or fitness for any particular purpose. The manufacturer reserves the right to revise this publication and to make changes from time to time in the content hereof without obligation of the manufacturer to notify any person of such revision or changes.

## Trademark Recognition

Kensington is a U.S. registered trademark of ACCO Brand Corporation with issued registrations and pending applications in other countries throughout the world.

HDMI, the HDMI Logo, and High-Definition Multimedia Interface are trademarks or registered trademarks of HDMI Licensing LLC in the United States and other countries.

DLP®, DLP Link and the DLP logo are registered trademarks of Texas Instruments and BrilliantColor™ is a trademark of Texas Instruments.

MHL, Mobile High-Definition Link and the MHL Logo are trademarks or registered trademarks of MHL Licensing, LLC.

All other product names used in this manual are the properties of their respective owners and are Acknowledged.

## FCC

This device has been tested and found to comply with the limits for a Class B digital device pursuant to Part 15 of the FCC rules. These limits are designed to provide reasonable protection against harmful interference in a residential installation. This device generates, uses and can radiate radio frequency energy and, if not installed and used in accordance with the instructions, may cause harmful interference to radio communications.

However, there is no guarantee that interference will not occur in a particular installation. If this device does cause harmful interference to radio or television reception, which can be determined by turning the device off and on is encouraged to try to correct the interference by one or more of the following measures:

- Reorient or relocate the receiving antenna.
- Increase the separation between the device and receiver.
- Connect the device into an outlet on a circuit different from that to which the receiver is connected.
- Consult the dealer or an experienced radio/television technician for help.

### **Notice: Shielded cables**

All connections to other computing devices must be made using shielded cables to maintain compliance with FCC regulations.

### **Caution**

Changes or modifications not expressly approved by the manufacturer could void the user's authority, which is granted by the Federal Communications Commission, to operate this projector.

## Operation Conditions

This device complies with Part 15 of the FCC Rules. Operation is subject to the following two conditions:

1. This device may not cause harmful interference and
2. This device must accept any interference received, including interference that may cause undesired operation.

## Notice: Canadian users

This Class B digital apparatus complies with Canadian ICES-003.

Remarque à l'intention des utilisateurs canadiens

Cet appareil numérique de la classe B est conforme à la norme NMB-003 du Canada.

## Declaration of Conformity for EU countries

- EMC Directive 2014/30/EU (including amendments)
- Low Voltage Directive 2014/35/EU
- RED 2014/53/EU (if product has RF function)

## WEEE



### Disposal instructions

Do not throw this electronic device into the trash when discarding. To minimize pollution and ensure utmost protection of the global environment, please recycle it.

# INTRODUCTION

## Package Overview

Carefully unpack and verify that you have the items listed below under standard accessories. Some of the items under optional accessories may not be available depending on the model, specification and your region of purchase. Please check with your place of purchase. Some accessories may vary from region to region.

The warranty card is only supplied in some specific regions. Please consult your dealer for detailed information.

## Standard accessories

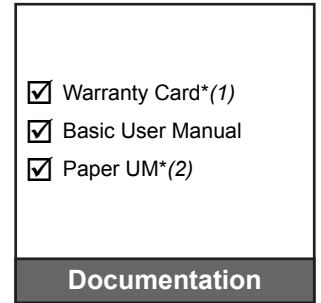
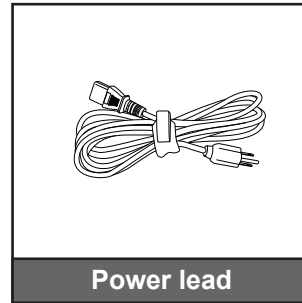
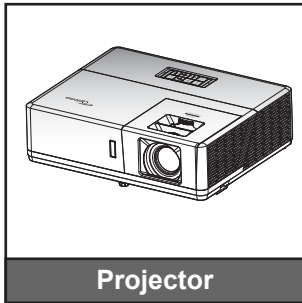

### Note:

- *The remote control is shipped with the battery.*
- *\*(1) For European warranty Information, please visit [www.optoma.com](http://www.optoma.com).*
- *\*(2) Available only for Asian region.*

## Optional accessories

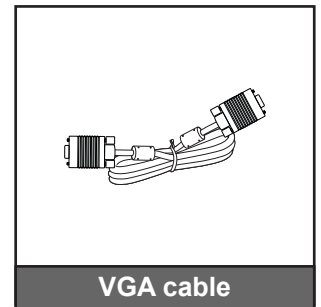
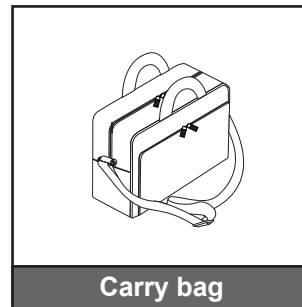
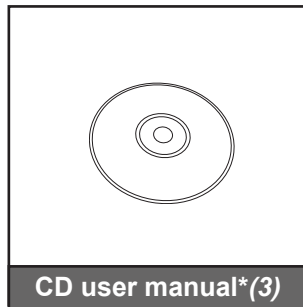
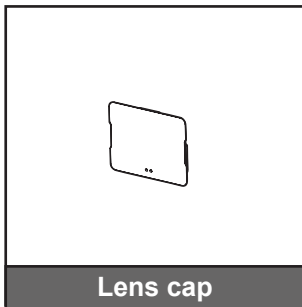

### Note:

- *Optional accessories vary depending on model, specification and region.*
- *\*(3) Available only for USA and Asian regions.*



# INTRODUCTION

## Product Overview

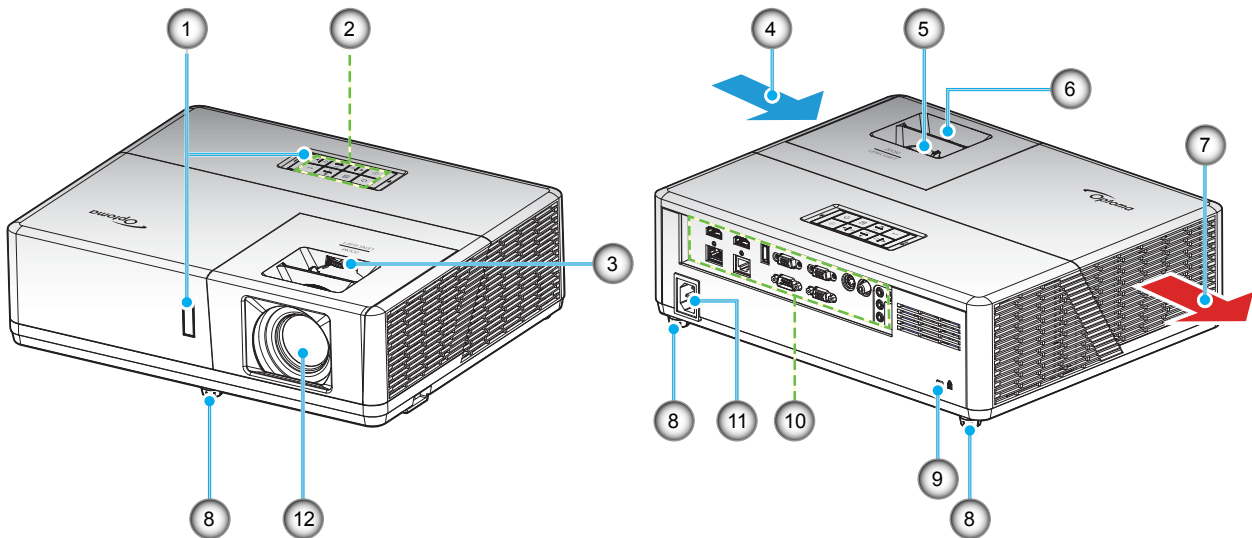

### Note:

- Do not block projector intake and exhaust vents.
- When operating the projector in an enclosed space, allow at least 30 cm clearance around the intake and exhaust vents.

No	Item	No	Item
1.	IR Receivers	7.	Ventilation (outlet)
2.	Keypad	8.	Tilt-Adjustment Feet
3.	Lens Shift Dial	9.	Kensington™ Lock Port
4.	Ventilation (inlet)	10.	Input / Output
5.	Zoom Lever	11.	Power Socket
6.	Focus Ring	12.	Lens

# INTRODUCTION

## Connections

### Type 1 (11 IO)

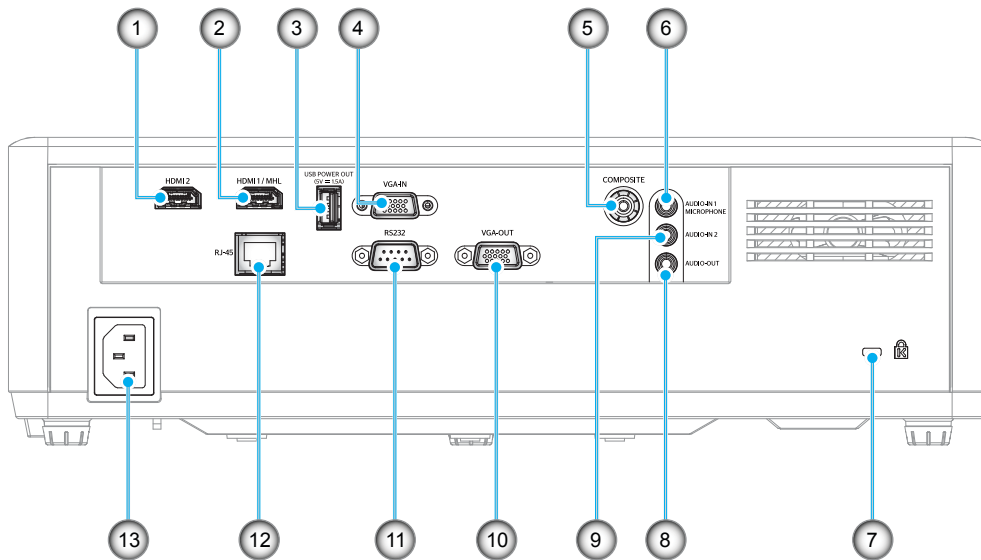

### Type 2 (15 IO)

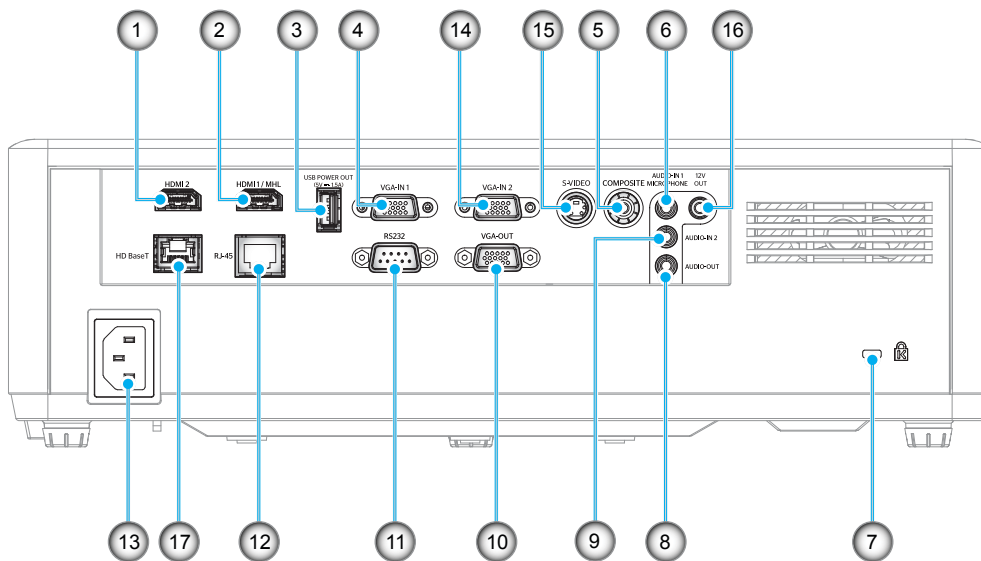

# INTRODUCTION

No	Item	Type 1 (11 IO)	Type 2 (15 IO)
1.	HDMI 2 Connector	√	√
2.	HDMI 1 / MHL Connector	√	√
3.	USB Power Out (5V $\overline{---}$ 1.5A) Connector	√	√
4.	VGA In / VGA In 1 Connector	√	√
5.	Composite Connector	√	√
6.	Audio In 1 / Microphone Connector	√	√
7.	Kensington™ Lock Port	√	√
8.	Audio Out Connector	√	√
9.	Audio In 2 Connector	√	√
10.	VGA Out Connector	√	√
11.	RS232 Connector	√	√
12.	RJ-45 Connector	√	√
13.	Power Socket	√	√
14.	VGA In 2 Connector	N/A	√
15.	S-Video Connector	N/A	√
16.	12V Out Connector	N/A	√
17.	HDBaseT Connector	N/A	√

**Note:** “√” means the item is supported, “N/A” means the item is not available.

**Note:**

- *USB Type A supports mouse / service capability.*
- *Remote mouse requires special remote control.*

# INTRODUCTION

## Keypad

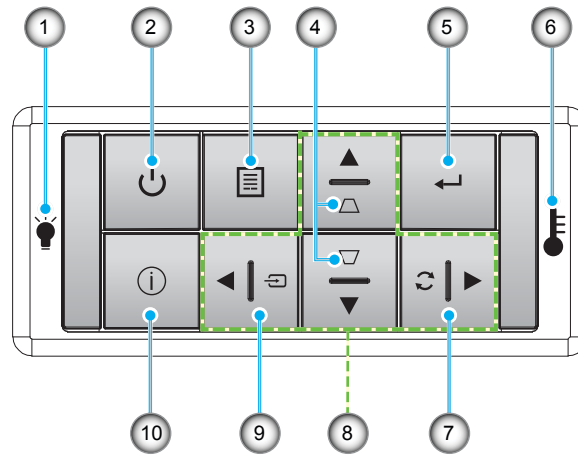

No	Item	No	Item
1.	Lamp LED	6.	Temp LED
2.	Power and Power LED	7.	Re-Sync
3.	Menu	8.	Four Directional Select Keys
4.	Keystone Correction	9.	Source
5.	Enter	10.	Information

# INTRODUCTION

## Remote control

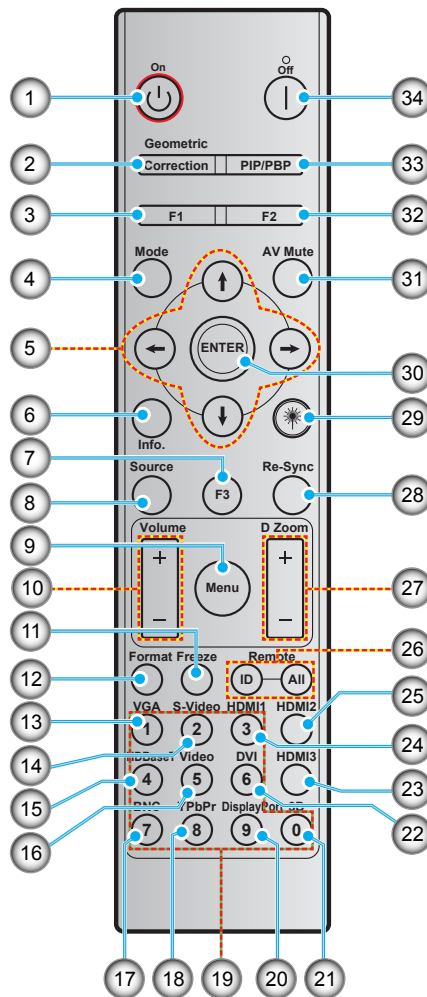

No	Item	No	Item
1.	Power on	18.	YPbPr (not supported)
2.	Geometric Correction	19.	Numeric keypad (0-9)
3.	Function button (F1) (Assignable)	20.	Display port (not supported)
4.	Mode	21.	3D
5.	Four directional select keys	22.	DVI (not supported)
6.	Information	23.	HDMI3 (not supported)
7.	Function button (F3) (Assignable)	24.	HDMI1
8.	Source	25.	HDMI2
9.	Menu	26.	Remote ID / Remote all
10.	Volume - / +	27.	Digital Zoom - / +
11.	Freeze	28.	Re-sync
12.	Format (Aspect Ratio)	29.	Laser (not supported)
13.	VGA	30.	Enter
14.	S-Video	31.	AV Mute
15.	HDBase-T	32.	Function button (F2) (Assignable)
16.	Video	33.	PIP/PBP (not supported)
17.	BNC (not supported)	34.	Power off

**Note:** Some keys may have no function for models that do not support these features.

# SETUP AND INSTALLATION

## Installing the projector

Your projector is designed to be installed in one of four possible positions.

Your room layout or personal preference will dictate which installation location you select. Take into consideration the size and position of your screen, the location of a suitable power outlet, as well as the location and distance between the projector and the rest of your equipment.

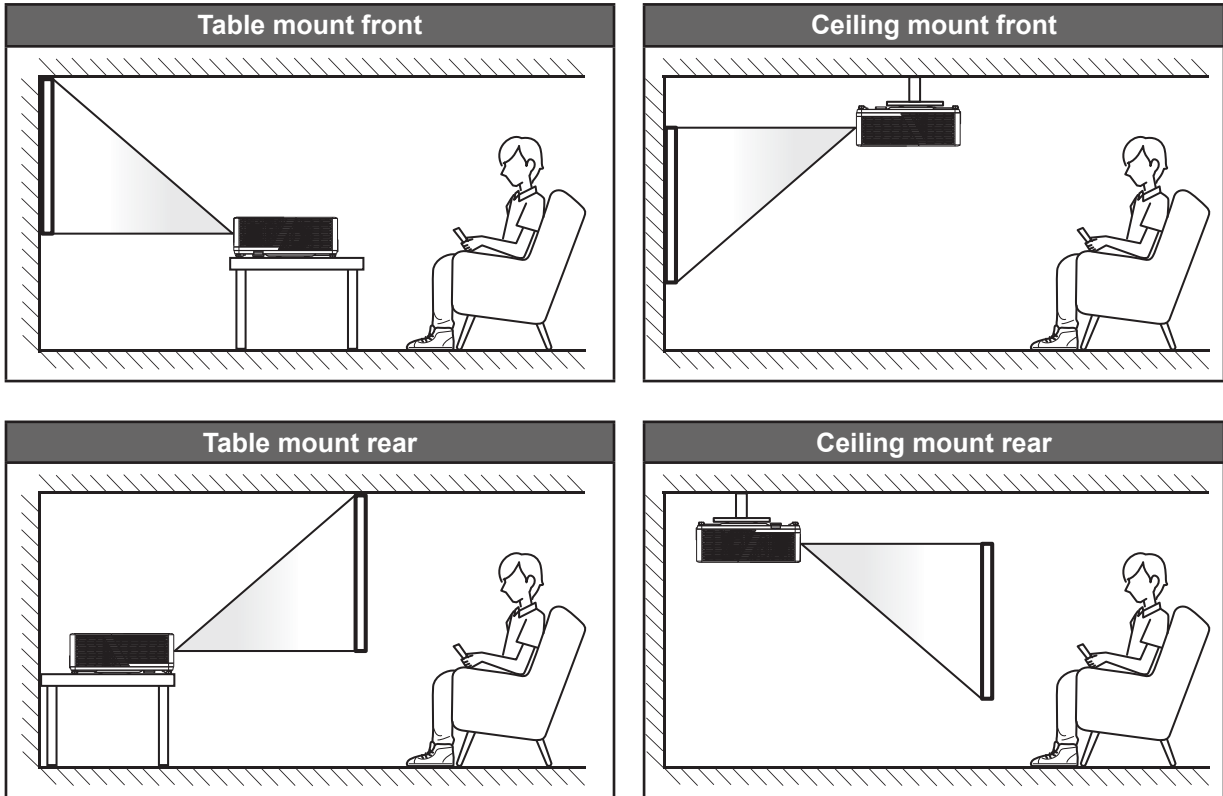

Projector should be placed flat on a surface and 90 degrees / perpendicular to the screen.

- How to determine projector location for a given screen size, please refer to distance table on pages 58-60.
- How to determine screen size for a given distance, please refer to distance table on pages 58-60.

**Note:** *The further away the projector is placed from the screen the projected image size increases and vertical offset also increases proportionally.*

### **IMPORTANT!**

*Do not operate the projector in any orientation other than table top or ceiling mount. The projector should be horizontal and not tilted either forwards/backwards or left/right. Any other orientation will invalidate the warranty and may shorten the lifetime of the projector light source or the projector itself. For non standard installation advise please contact Optoma.*

# SETUP AND INSTALLATION

## Projector installation notice

- Place the projector in a horizontal position.  
**The tilt angle of the projector should not exceed 15 degrees**, nor should the projector be installed in any way other than the desktop and ceiling mount, otherwise lamp life could decrease dramatically, and may lead to other **unpredictable damages**.



- Allow at least 30 cm clearance around the exhaust vent.

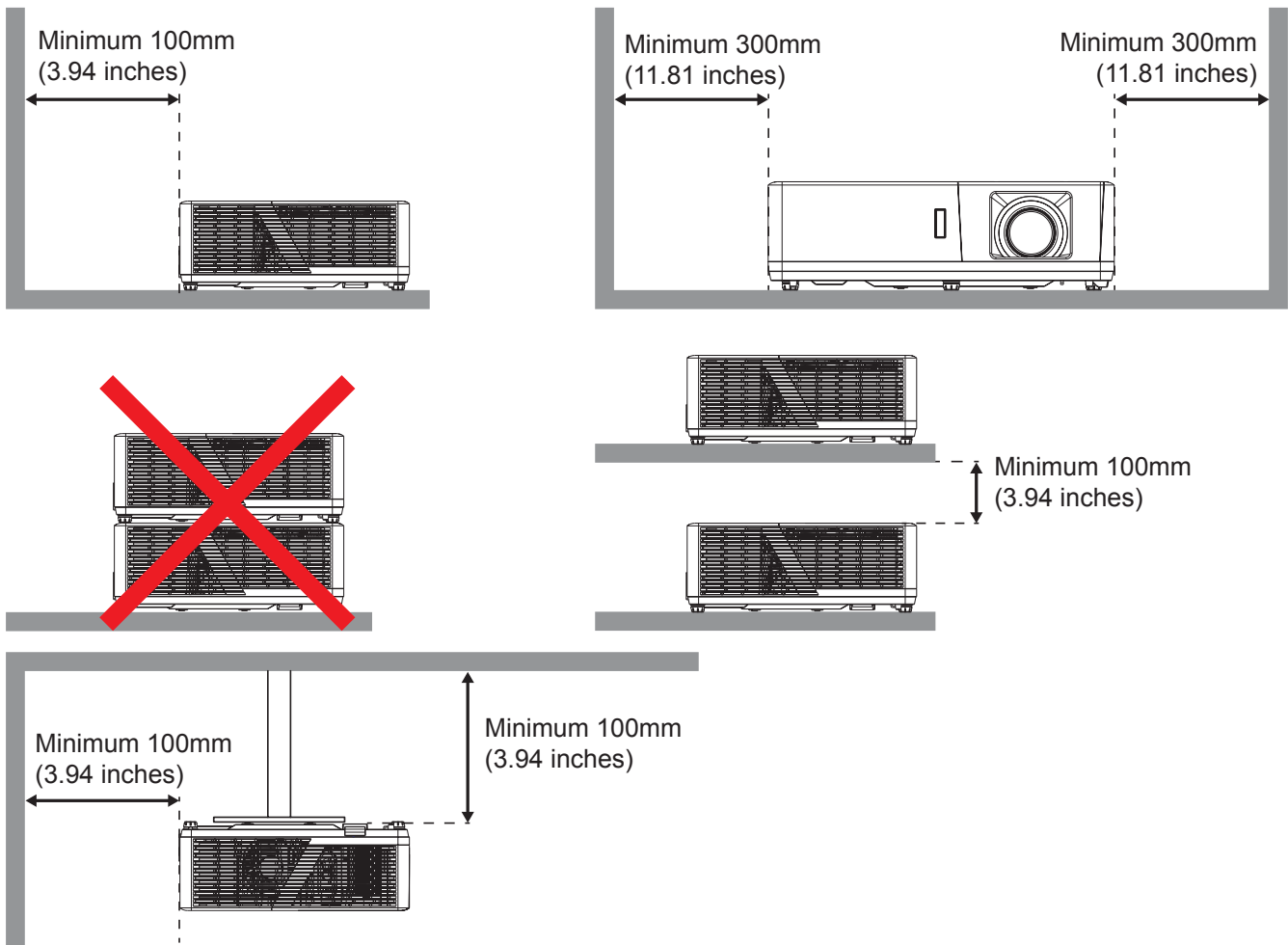

- Ensure that the intake vents do not recycle hot air from the exhaust vent.
- When operating the projector in an enclosed space, ensure that the surrounding air temperature within the enclosure does not exceed operation temperature while the projector is running, and the air intake and exhaust vents are unobstructed.
- All enclosures should pass a certified thermal evaluation to ensure that the projector does not recycle exhaust air, as this may cause the device to shutdown even if the enclosure temperature is within the acceptable operation temperature range.

# SETUP AND INSTALLATION

## Connecting sources to the projector

Type 1 (11 IO)

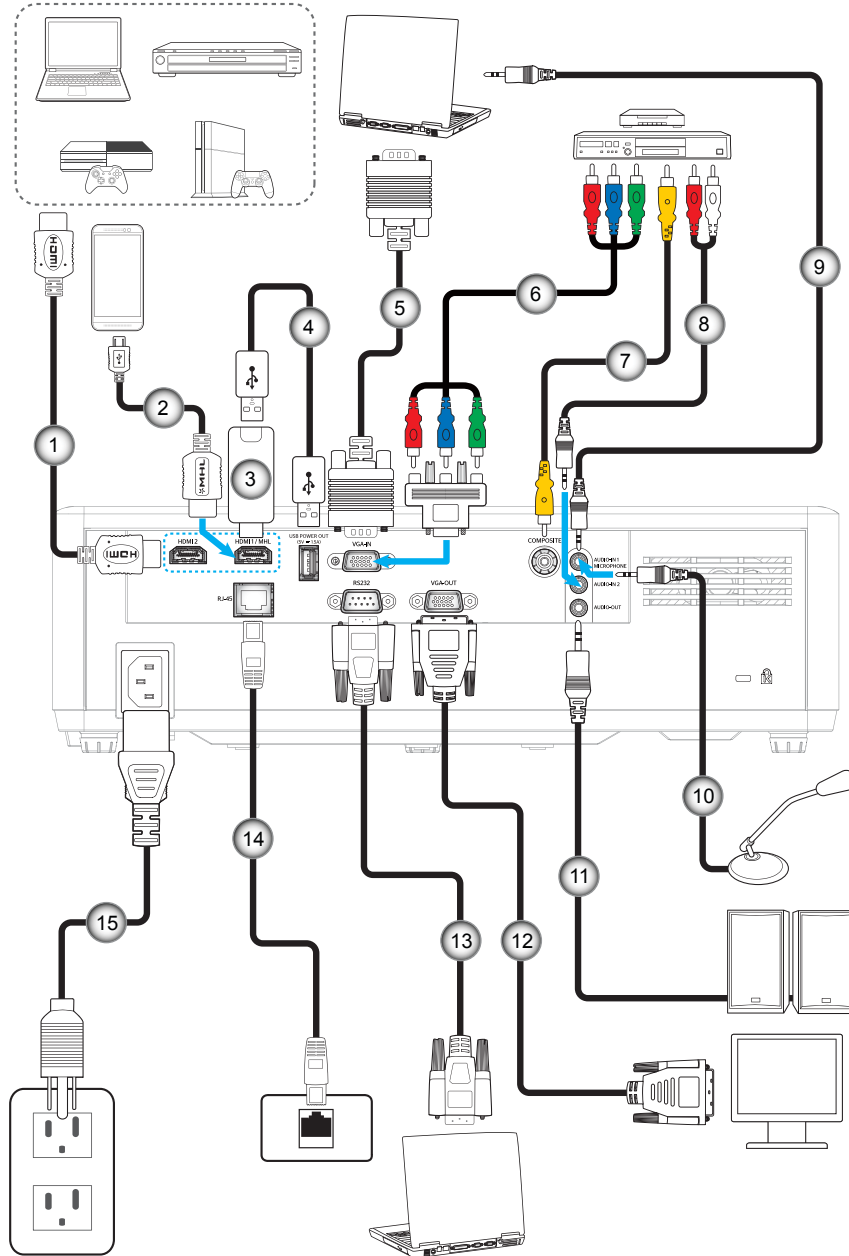





# SETUP AND INSTALLATION

No	Item	Type 1 (11 IO)	Type 2 (15 IO)
1.	HDMI Cable	√	√
2.	MHL Cable	√	√
3.	HDMI Dongle	√	√
4.	USB Power Cable	√	√
5.	VGA In Cable	√	√
6.	RCA Component Cable	√	√
7.	Video Cable	√	√
8.	Audio In Cable	√	√
9.	Audio In Cable	√	√
10.	Microphone Cable	√	√
11.	Audio Out Cable	√	√
12.	VGA Out Cable	√	√
13.	RS232 Cable	√	√
14.	RJ-45 Cable	√	√
15.	Power Cord	√	√
16.	S-Video Cable	N/A	√
17.	12V DC Jack	N/A	√
18.	RJ-45 Cable (Cat5 Cable)	N/A	√

**Note:** “√” means the item is supported, “N/A” means the item is not available.

# SETUP AND INSTALLATION

## Adjusting the projector image

### Image height

The projector is equipped with elevator feet for adjusting the image height.

1. Locate the adjustable foot you wish to adjust on the underside of the projector.
2. Rotate the adjustable foot clockwise or counterclockwise to raise or lower the projector.

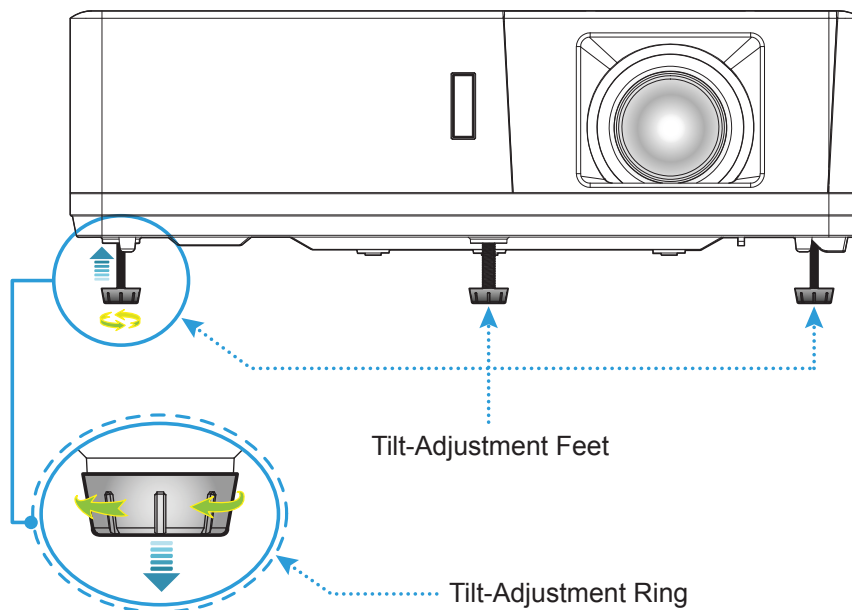

### Zoom, lens shift, and focus

- To adjust the image size, turn the zoom lever clockwise or counterclockwise to increase or decrease the projected image size.
- To adjust the image position, turn the lens shift dial clockwise or counterclockwise to adjust the position of the projected image vertically.
- To adjust the focus, turn the focus ring clockwise or counterclockwise until the image is sharp and legible.

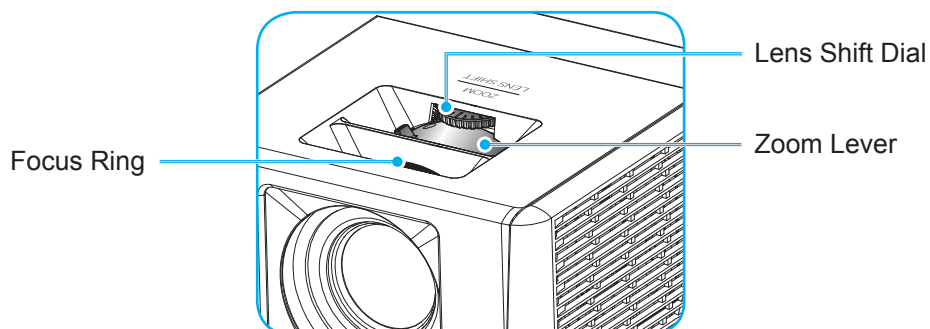

**Note:** The projector will focus at a distance of 1.3m to 9.4m.

# SETUP AND INSTALLATION

## Remote setup

### Installing / replacing the batteries

Two AAA size batteries are supplied for the remote control.

1. Remove the battery cover on the back of the remote control.
2. Insert AAA batteries in the battery compartment as illustrated.
3. Replace back cover on remote control.

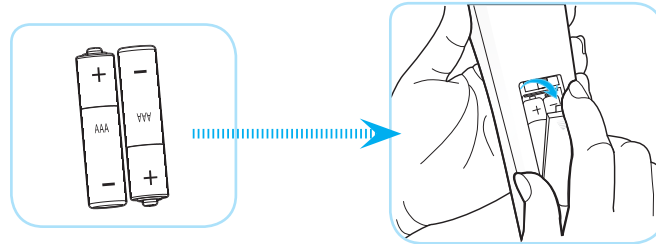

**Note:** Replace only with the same or equivalent type batteries.

### CAUTION

Improper use of batteries can result in chemical leakage or explosion. Be sure to follow the instructions below.

- Do not mix batteries of different types. Different types of batteries have different characteristics.
- Do not mix old and new batteries. Mixing old and new batteries can shorten the life of new batteries or cause chemical leakage in old batteries.
- Remove batteries as soon as they are depleted. Chemicals that leak from batteries that come in contact with skin can cause a rash. If you find any chemical leakage, wipe thoroughly with a cloth.
- The batteries supplied with this product may have a shorter life expectancy due to storage conditions.
- If you will not be using the remote control for an extended period of time, remove the batteries.
- When you dispose of the batteries, you must obey the law in the relative area or country.

# SETUP AND INSTALLATION

## Effective range

Infra-Red (IR) remote control sensor is located on the top and front sides of the projector. Ensure to hold the remote control at an angle within 60 degrees perpendicular to the projector's IR remote control sensor to function correctly. The distance between the remote control and the sensor should not be longer than 12 meters (39.4 feet).

- Make sure that there are no obstacles between the remote control and the IR sensor on the projector that might obstruct the infra-red beam.
- Make sure the IR transmitter of the remote control is not being shined by sunlight or fluorescent lamps directly.
- Please keep the remote controller away from fluorescent lamps for over 2 m or the remote controller might become malfunction.
- If the remote control is close to Inverter-Type fluorescent lamps, it might become ineffective from time to time.
- If the remote control and the projector are within a very short distance, the remote control might become ineffective.
- When you aim at the screen, the effective distance is less than 5 m from the remote control to the screen and reflecting the IR beams back to the projector. However, the effective range might change according to screens.

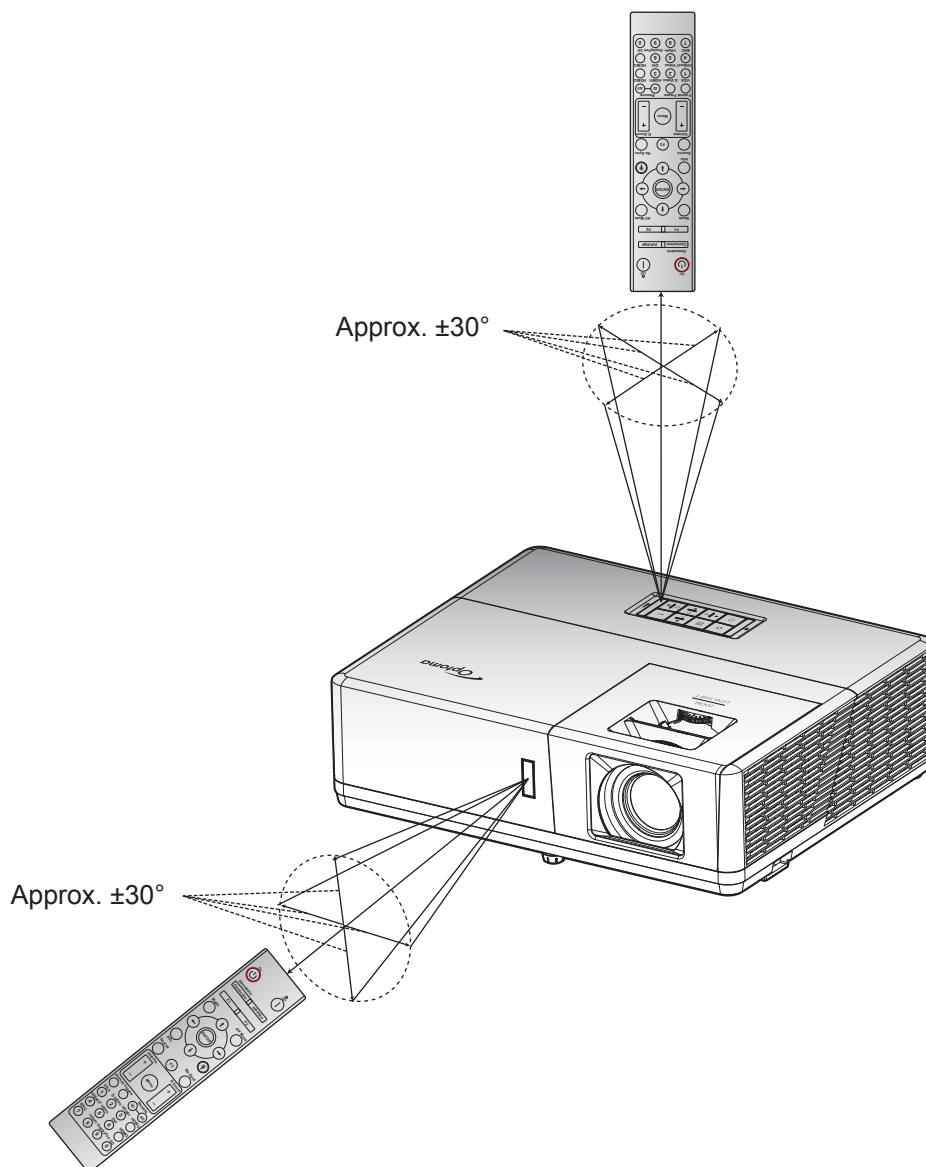

# USING THE PROJECTOR

## Powering on / off the projector

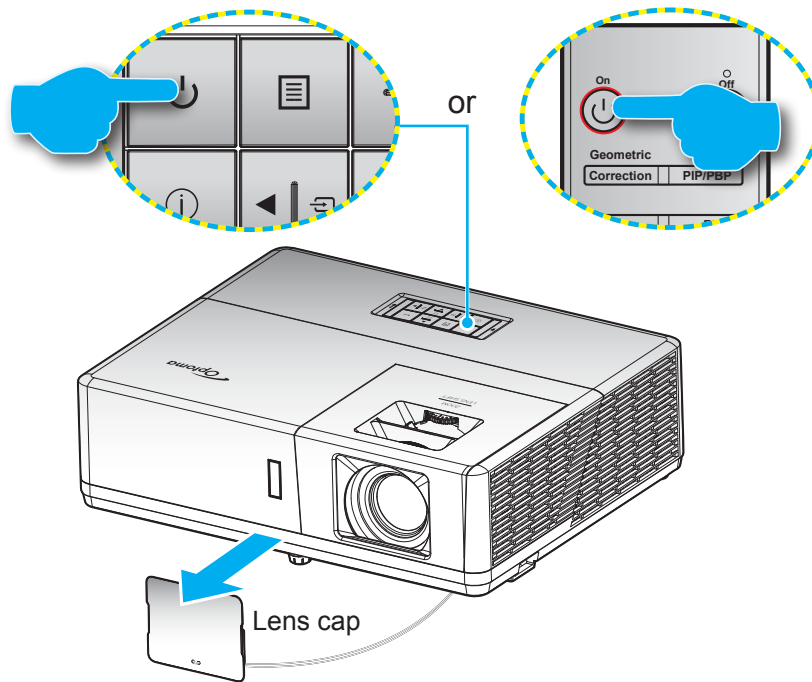



### Powering on





1. Remove the lens cap.
2. Securely connect the power lead and signal/source cable. When connected, the Power LED will turn red.
3. Turn on the projector by pressing the  button on the projector keypad or remote control.
4. A start up screen will display in approximately 10 seconds and the Power LED will be flashing blue.

**Note:** The first time the projector is turned on, you will be prompted to select the preferred language, projection orientation, and other settings.

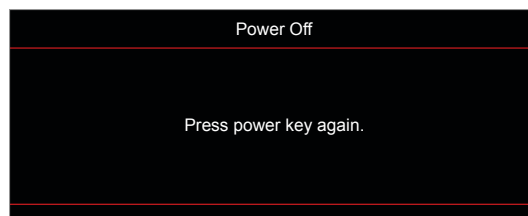
### Powering off

1. Turn off the projector by pressing the  button on the projector keypad or the  button on the remote control.
2. The following message will be displayed:



3. Press the  or  button again to confirm, otherwise the message will disappear after 15 seconds. When you press the  or  button for the second time, the projector will shut down.
4. The cooling fans will continue to operate for about 10 seconds for the cooling cycle and the Power LED will flash blue. When the Power turns solid red, this indicates the projector has entered standby mode. If you wish to turn the projector back on, you must wait until the cooling cycle has finished and the projector has entered standby mode. When the projector is in standby mode, simply press the  button again to turn on the projector.
5. Disconnect the power lead from the electrical outlet and the projector.

**Note:** It is not recommended that the projector is turned on immediately, right after a power off procedure.

# USING THE PROJECTOR

## Selecting an input source

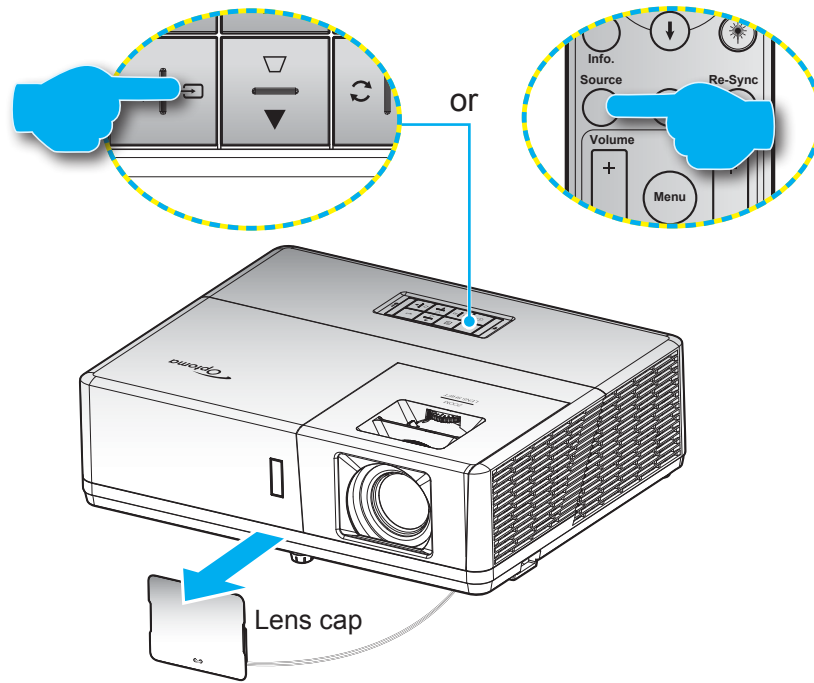

Turn on the connected source that you want to display on the screen, such as computer, notebook, video player, etc. The projector will automatically detect the source. If multiple sources are connected, press the  button on the projector keypad or the **Source** button on the remote control to select the desired input.



# USING THE PROJECTOR

## Menu navigation and features

The projector has multilingual on-screen display menus that allow you to make image adjustments and change a variety of settings. The projector will automatically detect the source.

1. To open the OSD menu, press the  button on the projector keypad or the **Menu** button on the remote control.
2. When OSD is displayed, use **▲▼** keys to select any item in the main menu. While making a selection on a particular page, press the **←** button on the projector keypad or the **Enter** button on the remote control to enter sub menu.
3. Use **◀▶** keys to select the desired item in the sub menu and then press the **←** or **Enter** button to view further settings. Adjust the settings by using **◀▶** keys.
4. Select the next item to be adjusted in the sub menu and adjust as described above.
5. Press press the **←** or **Enter** button to confirm, and the screen will return to the main menu.
6. To exit, press the  or **Menu** button again. The OSD menu will close and the projector will automatically save the new settings.

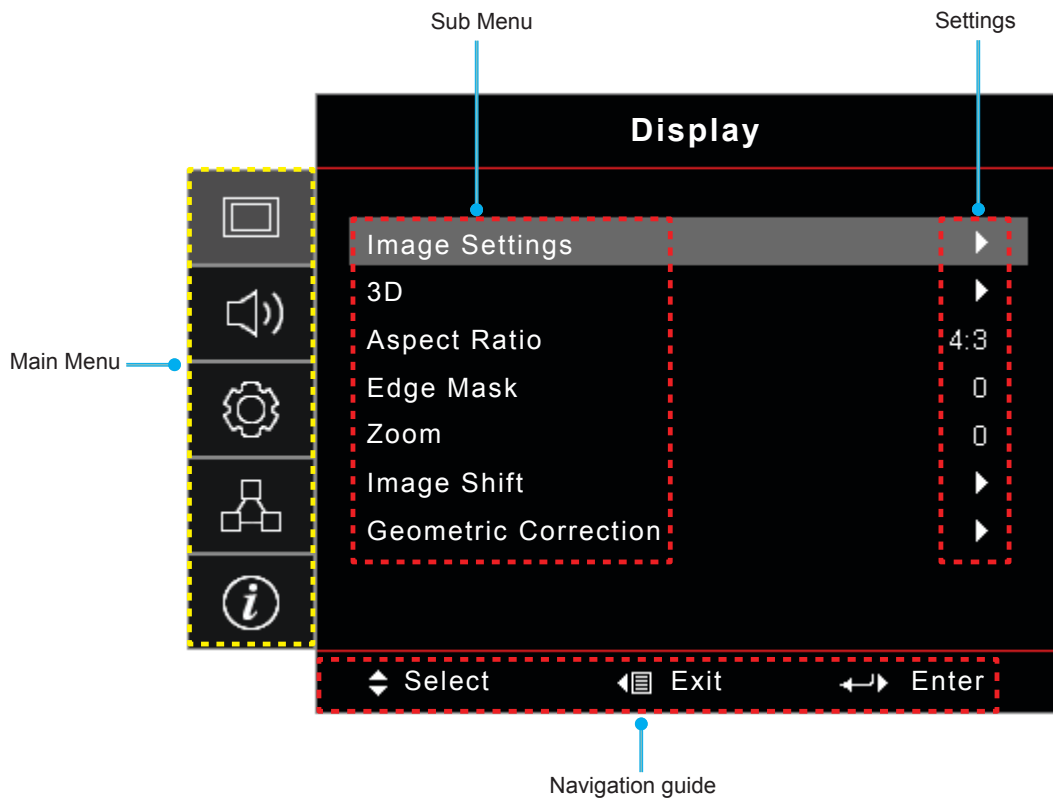



# USING THE PROJECTOR



## OSD Menu tree

Main Menu	Sub Menu	Sub Menu 2	Sub Menu 3	Sub Menu 4	Values	
Display	Image Settings	Display Mode			Presentation	
					Bright	
					HDR SIM.	
					Cinema	
					Game	
					sRGB	
					DICOM SIM.	
					User	
				3D		
			Wall Color			Off [Default]
						Blackboard
						Light Yellow
						Light Green
						Light Blue
						Pink
			Dynamic Range	HDR		Off
						Auto [Default]
				HDR Picture Mode		Bright
						Standard [Default]
						Film
						Detail
				HDR Demo Mode		SMPTE 2084
						Off [Default]
			Brightness			On
			Contrast			-50 ~ 50
			Sharpness			-50 ~ 50
			Color			1 ~ 15
			Tint			-50 ~ 50
			Gamma	Film		
				Video		
				Graphics		
				Standard(2.2)		
				1.8		
				2.0		
				2.4		
				2.6		
				3D		
				Blackboard		
			DICOM SIM.			
			Color Settings	BrilliantColor™		1 ~ 10

# USING THE PROJECTOR

Main Menu	Sub Menu	Sub Menu 2	Sub Menu 3	Sub Menu 4	Values
Display	Image Settings	Color Settings	Color Temperature		Warm
					Standard
					Cool
					Cold
			Color Matching	Color	Red [Default]
					Green
					Blue
					Cyan
					Yellow
					Magenta
					White(*)
				Hue / R(*)	-50 ~ 50 [Default: 0]
				Saturation / G(*)	-50 ~ 50 [Default: 0]
				Gain / B(*)	-50 ~ 50 [Default: 0]
				Reset	Cancel [Default]
					Yes
				Exit	
			RGB Gain/Bias	Red Gain	-50 ~ 50
				Green Gain	-50 ~ 50
				Blue Gain	-50 ~ 50
				Red Bias	-50 ~ 50
				Green Bias	-50 ~ 50
				Blue Bias	-50 ~ 50
				Reset	Cancel [Default]
					Yes
			Exit		
			Color Space [Not HDMI Input]		Auto [Default]
					RGB
					YUV
			Color Space [HDMI Input]		Auto [Default]
					RGB(0~255)
					RGB(16~235)
					YUV
			White Level	-50 ~ 50 (depends on signal)	
			Black Level	-50 ~ 50 (depends on signal)	
			Saturation	-50 ~ 50	
			Hue	-50 ~ 50	
			IRE		0
					7.5
			Signal	Automatic	Off
					On [Default]
				Frequency	-50 ~ 50 (depends on signal) [Default: 0]
			Phase	0~31 (depends on signal) [Default: 0]	

# USING THE PROJECTOR

Main Menu	Sub Menu	Sub Menu 2	Sub Menu 3	Sub Menu 4	Values	
Display	Image Settings	Signal	H. Position		-50 ~ 50 (depends on signal) [Default: 0]	
			V. Position		-50 ~ 50 (depends on signal) [Default: 0]	
		Brightness Mode			DynamicBlack	
					Power (Power = 100%/ 95%/ 90%/ 85%/ 80%/ 75%/ 70%/ 65%/ 60%/ 55%/ 50%)	
		Reset				
	3D	3D Mode				Off [Default]
						DLP-Link
						IR
		3D → 2D				3D [Default]
						L
						R
		3D Format				Auto [Default]
						SBS
						Top and Bottom
						Frame Sequential
	3D Sync Invert				Frame Packing	
					On	
	Aspect Ratio					Off [Default]
						4:3
						16:9
						16:10
						LBX
						Native
	Edge Mask					Auto
	Zoom					0 ~ 10 [Default: 0]
	Image Shift					-5 ~ 25
		H 				-100 ~ 100 [Default: 0]
		V 				-100 ~ 100 [Default: 0]
	Geometric Correction		Four Corners			
			H Keystone			-40 ~ 40 [Default: 0]
V Keystone					-40 ~ 40 [Default: 0]	
Auto Keystone					Off	
Reset					On [Default]	
Audio	Mute				Off [Default]	
					On	
	Volume					0 ~ 10 [Default: 5]
Mic Volume					0 ~ 10 [Default: 5]	

# USING THE PROJECTOR

Main Menu	Sub Menu	Sub Menu 2	Sub Menu 3	Sub Menu 4	Values	
Audio	Audio Input	HDMI1/MHL			Audio 1	
					Audio 2	
					Default [Default]	
		HDMI2			Audio 1	
					Audio 2	
					Default [Default]	
		VGA			Audio 1	
					Audio 2	
		Component			Audio 1	
					Audio 2	
		Video			Audio 1	
					Audio 2	
Setup	Projection				Front  [Default]	
					Rear 	
					Ceiling-top 	
					Rear-top 	
	Screen Type				16:9	
					16:10 [Default]	
	Power Settings	Direct Power On			Off [Default]	
					On	
		Signal Power On			Off [Default]	
					On	
		Auto Power Off (min.)			0 ~ 180 (5 min increments) [Default: 0]	
		Sleep Timer (min.)			0 ~ 990 (30 min increments) [Default: 0]	
			Always On			No [Default]
				Yes		
	Power Mode (Standby)				Active	
					Eco [Default]	
	USB Power (Standby)				Off [Default]	
					On	
	Security	Security			Off	
					On	
		Security Timer	Month			
			Day			
			Hour			
Change Password				[Default: 1234]		
HDMI Link Settings	HDMI Link			Off [Default]		
				On		
	Inclusive of TV				No [Default]	
				Yes		

# USING THE PROJECTOR

Main Menu	Sub Menu	Sub Menu 2	Sub Menu 3	Sub Menu 4	Values	
Setup	HDMI Link Settings	Power On Link			Mutual [Default]	
					PJ → Device	
					Device → PJ	
		Power Off Link			Off [Default]	
					On	
					Green Grid	
	Test Pattern				Magenta Grid	
					White Grid	
					White	
					Off	
					On [Default]	
	Remote Settings [depends on remote]	IR Function				Off
						00~99
		F1				Test Pattern
						Brightness
						Contrast
						Sleep Timer [Default]
						Color Matching
						Color Temp
						Gamma
						Projection
		F2				Test Pattern
						Brightness
						Contrast
						Sleep Timer
						Color Matching [Default]
						Color Temp
						Gamma
						Projection
		F3				Test Pattern [Default]
						Brightness
						Contrast
						Sleep Timer
					Color Matching	
					Color Temp	
					Gamma	
					Projection	
Projector ID					00 ~ 99	
Options		Language				English [Default]
						Deutsch
						Français
					Italiano	
					Español	
					Português	

# USING THE PROJECTOR

Main Menu	Sub Menu	Sub Menu 2	Sub Menu 3	Sub Menu 4	Values	
Setup	Options	Language			Polski	
					Nederlands	
					Svenska	
					Norsk/Dansk	
					Suomi	
					ελληνικά	
					繁體中文	
					簡體中文	
					日本語	
					한국어	
					Русский	
					Magyar	
					Čeština	
					عربي	
					ไทย	
					Türkçe	
					فارسی	
				Tiếng Việt		
				Bahasa Indonesia		
				Română		
				Slovenčina		
			Closed Captioning			CC1
						CC2
						Off [Default]
			Menu Settings	Menu Location		Top left 
						Top right 
						Center  [Default]
						Bottom left 
						Bottom right 
					Menu Timer	Off
					5sec	
					10sec [Default]	
	Auto Source			Off [Default]		
				On		
	Input Source			HDMI1/MHL		
				HDMI2		
				VGA		
				Component		
				Video		

# USING THE PROJECTOR

Main Menu	Sub Menu	Sub Menu 2	Sub Menu 3	Sub Menu 4	Values
Setup	Options	Input Name	HDMI1/MHL		Default [Default]
					Custom
			HDMI2		Default [Default]
					Custom
			VGA		Default [Default]
					Custom
		Component		Default [Default]	
				Custom	
		Video		Default [Default]	
				Custom	
		VGA Out			Auto [Default]
					VGA1
					VGA2
		High Altitude			Off [Default]
					On
		Display Mode Lock			Off [Default]
					On
		Keypad Lock			Off [Default]
					On
		Information Hide			Off [Default]
					On
		Logo			Default [Default]
					Neutral
					User
	Background Color			None	
				Blue [Default]	
				Red	
				Green	
				Gray	
				Logo	
Reset	Reset OSD			Cancel [Default]	
				Yes	
Reset to Default			Cancel [Default]		
			Yes		
Network	LAN	Network Status			(read only)
		MAC Address			(read only)
		DHCP			Off [Default]
					On
		IP Address			192.168.0.100 [Default]
		Subnet Mask			255.255.255.0 [Default]
		Gateway			192.168.0.254 [Default]
		DNS			192.168.0.51 [Default]
Reset					

# USING THE PROJECTOR

Main Menu	Sub Menu	Sub Menu 2	Sub Menu 3	Sub Menu 4	Values
Network	Control	Crestron			Off
					On [Default] <b>Note:</b> Port 41794
		Extron			Off
					On [Default] <b>Note:</b> Port 2023
		PJ Link			Off
					On [Default] <b>Note:</b> Port 4352
		AMX Device Discovery			Off
					On [Default] <b>Note:</b> Port 9131
Telnet			Off		
			On [Default] <b>Note:</b> Port 23		
HTTP			Off		
			On [Default] <b>Note:</b> Port 80		
Info	Regulatory				
	Serial Number				
	Source				
	Resolution				00x00
	Refresh Rate				0.00Hz
	Display Mode				
	Color Depth				
	Color Format				
	Power Mode (Standby)				
	Light Source Hours				0 hr
	Remote Code				00 ~ 99
	Remote Code(Active)				00 ~ 99
	Network Status				
	IP Address				
	Projector ID				00 ~ 99
	Brightness Mode				
	FW Version	System			
LAN					
MCU					



# USING THE PROJECTOR

## Display menu

### Display image settings menu

#### Display Mode

There are many factory presets optimized for various types of images.

- **Presentation:** This mode is suitable for showing in front of public in connection to the PC.
- **Bright:** Maximum brightness from PC input.
- **HDR SIM.:** Enhances non-HDR content with simulated High Dynamic Range (HDR). Choose this mode to enhance gamma, contrast, and color saturation for non-HDR content (720p and 1080p Broadcast/Cable TV, 1080p Blu-ray, non-HDR Games, etc). This mode can ONLY be used with non-HDR content.
- **Cinema:** Provides the best colors for watching movies.
- **Game:** Select this mode to increase the brightness and response time level for enjoying video games.
- **sRGB:** Standardized accurate color.
- **DICOM SIM.:** This mode can project a monochrome medical image such as an X ray radiography, MRI, etc.
- **User:** Memorize user's settings.
- **3D:** To experience the 3D effect, you need to have 3D glasses, make sure your PC/portable device has a 120 Hz signal output quad buffered graphics card and have a 3D Player installed.

#### Wall Color

Use this function to obtain an optimized screen image according to the wall color. Select between off, blackboard, light yellow, light green, light blue, pink, and gray.

#### Dynamic Range

Configure the High Dynamic Range (HDR) setting and its effect when displaying video from 4K Blu-ray players and streaming devices.

**Note:** *HDMI1 and VGA do not support Dynamic Range.*

##### ➤ HDR

- **Off:** Turn off HDR Processing. When set to Off, the projector will NOT decode HDR content.
- **Auto:** Auto detect HDR signal.

##### ➤ HDR Picture Mode

- **Bright:** Choose this mode for brighter more saturated colors.
- **Standard:** Choose this mode for natural looking colors with a balance of warm and cool tones.
- **Film:** Choose this mode for improved detail and image sharpness.
- **Details:** The signal comes from OETF conversion to achieve the best color matching.
- **SMPTE 2084:** HDR ETOF follows SMPTE 2084 specification.

##### ➤ HDR Demo Mode

- This feature enables you to see the difference in the image quality between the raw unprocessed image and the image processed as processed by the HDR.

#### Brightness

Adjust the brightness of the image.

#### Contrast

The contrast controls the degree of difference between the lightest and darkest parts of the picture.

# USING THE PROJECTOR

## Sharpness

Adjust the sharpness of the image.

## Color

Adjust a video image from black and white to fully saturated color.

## Tint

Adjust the color balance of red and green.

## Gamma

Set up gamma curve type. After the initial setup and fine tuning is completed, utilize the Gamma Adjustment steps to optimize your image output.

- **Film:** For home theater.
- **Video:** For video or TV source.
- **Graphics:** For PC / Photo source.
- **Standard(2.2):** For standardized setting.
- **1.8 / 2.0 / 2.4 / 2.6:** For specific PC / Photo source.

### **Note:**

- *These options are only available if the 3D mode function is disabled, the **Wall Color** setting is not set to **Blackboard**, and the **Display Mode** setting is not set to **DICOM SIM.***
- *In 3D mode, user can only select **3D** for **Gamma** setting.*
- *If the **Wall Color** setting is set to **Blackboard**, user can only select **Blackboard** for **Gamma** setting.*
- *If the **Display Mode** setting is set to **DICOM SIM.**, user can only select **DICOM SIM.** for **Gamma** setting.*

## Color Settings

Configure the color settings.

- **BrilliantColor™:** This adjustable item utilizes a new color-processing algorithm and enhancements to enable higher brightness while providing true, more vibrant colors in picture.
- **Color Temperature:** Select a color temperature from Warm, Standard, Cool, or Cold.
- **Color Matching:** Select the following options:
  - **Color:** Adjust the red, green, black, cyan, yellow, magenta, and white level of the image.
  - **Hue / R(red)\*:** Adjust the color balance of red and green.  
**Note:** *\*If the **Color** setting is set to **White**, you can adjust the red color setting.*
  - **Saturation / G(green)\*:** Adjust a video image from black and white to fully saturated color.  
**Note:** *\*If the **Color** setting is set to **White**, you can adjust the green color setting.*
  - **Gain / B(blue)\*:** Adjust the image brightness.  
**Note:** *\*If the **Color** setting is set to **White**, you can adjust the blue color setting.*
  - **Reset:** Return the factory default settings for color matching.
  - **Exit:** Exit the “Color Matching” menu.
- **RGB Gain/Bias:** This settings allows to configure the brightness (gain) and contrast (bias) of an image.
  - **Reset:** Return the factory default settings for RGB gain/bias.
  - **Exit:** Exit the “RGB Gain/Bias” menu.

# USING THE PROJECTOR

- **Color Space (non-HDMI input only):** Select an appropriate color matrix type from the following: AUTO, RGB, or YUV.
- **Color Space (HDMI input only):** select an appropriate color matrix type from the following: Auto, RGB(0-255), RGB(16-235), and YUV.
- **White Level:** Allow user to adjust White Level when inputting Video signals.  
**Note:** *White level can only be adjusted for Video/S-Video input sources.*
- **Black Level:** Allow user to adjust Black Level when inputting Video signals.  
**Note:** *Black level can only be adjusted for Video/S-Video input sources.*
- **Saturation:** Adjust a video image from black and white to fully saturated color.  
**Note:** *Saturation is only supported for VGA source (480i/480p 576i/675p 720P 1080i/1080p).*
- **Hue:** Adjust the color balance of red and green.  
**Note:** *Hue is only supported for VGA source (480i/480p 576i/675p 720P 1080i/1080p).*
- **IRE:** Allow user to adjust IRE value when inputting Video signals.  
**Note:**
  - *IRE is only available with NTSC video format.*
  - *IRE can only be adjusted for Video/S-Video input sources.*

## **Signal**

Adjust the signal options.

- **Automatic:** Configure automatically the signal (the frequency and phase items are grayed out). If automatic is disabled, the frequency and phase items will appear for tuning and saving the settings.
- **Frequency:** Change the display data frequency to match the frequency of your computer's graphic card. Use this function only if the image appears to flicker vertically.
- **Phase:** Synchronize the signal timing of the display with the graphic card. If the image appears to be unstable or flickers, use this function to correct it.
- **H. Position:** Adjust the horizontal positioning of the image.
- **V. Position:** Adjust the vertical positioning of the image.

**Note:** *This menu is only available if the input source is RGB/Component.*

## **Brightness Mode**

Adjust the brightness mode settings.

- **DynamicBlack:** Use to automatically adjust the picture brightness in order to give optimum contrast performance.
- **Power:** Choose the power percentage for brightness mode.

## **Reset**

Return the factory default settings for color settings.

# USING THE PROJECTOR

## Display 3D menu

### Note:

- *This projector is a 3D ready projector with DLP-Link 3D solution.*
- *Please make sure your 3D glasses are use for DLP-Link 3D before enjoy your video.*
- *This projector supports frame sequential (page-flip) 3D via HDMI1/HDMI2/VGA ports.*
- *To enable 3D mode, the input frame rate should be set to 60Hz only, lower or higher frame rate is not supported.*
- *To reach the best performance, resolution 1920x1080 is recommended, please be noted that 4K (3840x2160) resolution is not supported in 3D mode.*

### **3D Mode**

Use this option to disable the 3D function or select the appropriate the 3D function.

- **Off:** Select “Off” to turn off 3D mode.
- **DLP-Link:** Select to use optimized settings for DLP 3D Glasses.
- **IR:** Select “IR” to use optimized setting for IR 3D Glasses.

**Note:** *If the 2D and 3D sources enter PJ at the same time, if the ghosting image appears in the 2D source, make sure to manually turn off the 3D function.*

### **3D → 2D**

Use this option to specify how the 3D content should appear on the screen.

- **3D:** Display 3D signal.
- **L (Left):** Display the left frame of 3D content.
- **R (Right):** Display the right frame of 3D content.

### **3D Format**

Use this option to select the appropriate 3D format content.

- **Auto:** When a 3D identification signal is detected, the 3D format is selected automatically.
- **SBS:** Display 3D signal in “Side-by-Side” format.
- **Top and Bottom:** Display 3D signal in “Top and Bottom” format.
- **Frame Sequential:** Display 3D signal in “Frame Sequential” format.
- **Frame Packing:** Display 3D signal in “Frame Packing” format.

### **3D Sync Invert**

Use this option to enable/disable the 3D sync invert function.

# USING THE PROJECTOR

## Display aspect ratio menu

### Aspect Ratio

Select the aspect ratio of the displayed image between the following options:

- **4:3:** This format is for 4:3 input sources.
- **16:9:** This format is for 16:9 input sources, like HDTV and DVD enhanced for Wide screen TV.
- **16:10** (for WUXGA model only): This format is for 16:10 input sources, like widescreen laptops.
- **LBX:** This format is for non-16x9, letterbox source and if you use external 16x9 lens to display 2.35:1 aspect ratio in full resolution.
- **Native:** This format displays the original image without any scaling.
- **Auto:** Automatically selects the appropriate display format.

### Note:

- *Detailed informations about LBX mode:*
  - *Some Letter-Box Format DVDs are not enhanced for 16x9 TVs. In this situation, the image will not look right when displaying image in 16:9 mode. In this situation, please try to use the 4:3 mode to view the DVD. If the content is not 4:3, there will be black bars around the image in 16:9 display. For this type of content, you can use LBX mode to fill the image on the 16:9 display.*
  - *If you use an external anamorphic lens, this LBX mode also allows you to watch a 2.35:1 content (include Anamorphic DVD and HDTV film source) that supports anamorphic wide is enhanced for 16x9 Display in a wide 2.35:1 image. In this case, there are no black bars. Light source power and vertical resolution are fully utilized.*
- *To use the superwide format, do the following:*
  - a) *Set the screen aspect ratio to 2.0:1.*
  - b) *Select “Superwide” format.*
  - c) *Align the projector image correctly on the screen.*

### 1080p scaling table:

16:9 screen	480i/p	576i/p	1080i/p	720p	PC
4x3	Scale to 1440x1080.				
16x9	Scale to 1920x1080.				
LBX	Scale to 1920x1440, then get the central 1920x1080 image to display.				
Native mode	- 1:1 mapping centered. - No scaling will be made; the image is displayed with the resolution based on input source.				
Auto	- If auto format is selected, the screen type will automatically become 16:9 (1920x1080). - If source is 4:3, the screen type will be scaled to 1440 x1080. - If source is 16:9, the screen type will be scaled to 1920x1080. - If source is 16:10, the screen type will be scaled to 1920x1200 and cut 1920x1080 area to display.				

# USING THE PROJECTOR

## 1080p auto mapping rule:

Auto	Input resolution		Auto/Scale	
	H-resolution	V-resolution	1920	1080
4:3	640	480	1440	1080
	800	600	1440	1080
	1024	768	1440	1080
	1280	1024	1440	1080
	1400	1050	1440	1080
	1600	1200	1440	1080
Wide Laptop	1280	720	1920	1080
	1280	768	1800	1080
	1280	800	1728	1080
SDTV	720	576	1350	1080
	720	480	1620	1080
HDTV	1280	720	1920	1080
	1920	1080	1920	1080

## WUXGA scaling table for 1920 x 1200 DMD (screen type 16:10):

### Note:

- Supported screen type 16:10 (1920 x 1200), 16:9 (1920x1080).
- When screen type is 16:9, the 16x10 format becomes unavailable.
- When screen type is 16:10, the 16x9 format becomes unavailable.
- If you select auto option then the display mode will be also automatically changed.

16 : 10 screen	480i/p	576i/p	1080i/p	720p	PC
4x3	Scale to 1600x1200.				
16x9	Scale to 1920x1080.				
16x10	Scale to 1920x1200.				
LBX	Scale to 1920x1440, then get the central 1920x1200 image to display.				
Native mode	- 1:1 mapping centered. - No scaling will be made; the image is displayed with the resolution based on input source.				
Auto	- If this format is selected, the screen type will automatically become 16:10 (1920x1200). - If source is 4:3, the screen type will be scaled to 1600x1200. - If source is 16:9, the screen type will be scaled to 1920x1080. - If source is 16:10, the screen type will be scaled to 1920x1200.				

# USING THE PROJECTOR

## WUXGA auto mapping rule (screen type 16:10):

Auto	Input resolution		Auto/Scale	
	H-resolution	V-resolution	1920	1200
4:3	640	480	1600	1200
	800	600	1600	1200
	1024	768	1600	1200
	1280	1024	1600	1200
	1400	1050	1600	1200
	1600	1200	1600	1200
Wide Laptop	1280	720	1920	1080
	1280	768	1920	1152
	1280	800	1920	1200
SDTV	720	576	1350	1080
	720	480	1620	1080
HDTV	1280	720	1920	1080
	1920	1080	1920	1080

## WUXGA scaling table (screen type 16:9):

16 : 9 screen	480i/p	576i/p	1080i/p	720p	PC
4x3	Scale to 1440x1080.				
16x9	Scale to 1920x1080.				
LBX	Scale to 1920x1440, then get the central 1920x1080 image to display.				
Native mode	<ul style="list-style-type: none"> <li>- 1:1 mapping centered.</li> <li>- No scaling will be made; the image is displayed with the resolution based on input source.</li> </ul>				
Auto	<ul style="list-style-type: none"> <li>- If this format is selected, the screen type will automatically become 16:9 (1920x1080).</li> <li>- If source is 4:3, the screen type will be scaled to 1440x1080.</li> <li>- If source is 16:9, the screen type will be scaled to 1920x1080.</li> <li>- If source is 16:10, the screen type will be scaled to 1920x1200 and cut 1920x1080 area to display.</li> </ul>				

# USING THE PROJECTOR

WUXGA auto mapping rule (screen type 16:9):

Auto	Input resolution		Auto/Scale	
	H-resolution	V-resolution	1920	1080
4:3	640	480	1440	1080
	800	600	1440	1080
	1024	768	1440	1080
	1280	1024	1440	1080
	1400	1050	1440	1080
	1600	1200	1440	1080
Wide Laptop	1280	720	1920	1080
	1280	768	1800	1080
	1280	800	1728	1080
SDTV	720	576	1350	1080
	720	480	1620	1080
HDTV	1280	720	1920	1080
	1920	1080	1920	1080

## Display edge mask menu

### Edge Mask

Use this function to remove the video encoding noise on the edge of video source.

## Display zoom menu

### Zoom

Use to reduce or magnify an image on the projection screen.

## Display image shift menu

### Image Shift

Adjust the projected image position horizontally (H) or vertically (V).

## Display geometric correction menu

### Four Corners

Allow the image to be squeezed to fit an area defined by moving each of the four corners' x and y position.

### H Keystone

Adjust image distortion horizontally and make a squarer image. Horizontal keystone is used to correct a keystone image shape in which the left and right borders of the image are unequal in length. This is intended for use with horizontally on-axis applications.

### V Keystone

Adjust image distortion vertically and make a squarer image. Vertical keystone is used to correct a keystone image shape in which the top and bottom are slanted to one of the sides. This is intended when for use with vertically on-axis applications.



# USING THE PROJECTOR

## Auto Keystone

Correct keystone digitally to fit the projected image on the area on which you are projecting.

### **Note:**

- *The image size will reduce slightly when adjusting the horizontal and vertical keystone.*
- *When the Auto Keystone is used, the Four Corner Adjustment function will be disabled.*

## Reset

Resets the lamp hour counter after replacing the lamp.

## **Audio menu**

### **Audio mute menu**

#### Mute

Use this option to temporarily turn off the sound.

- **On:** Choose "On" to turn mute on.
- **Off:** Choose "Off" to turn mute off.

**Note:** "Mute" function affects both internal and external speaker volume.

### **Audio volume menu**

#### Volume

Adjust the volume level.

### **Audio mic volume menu**

#### Mic Volume

Adjust the microphone volume level.

### **Audio audio input menu**

#### Audio Input

Select the audio input port for the video sources as follows:

- **HDMI1/MHL:** Audio 1, Audio 2, or Default.
- **HDMI2:** Audio 1, Audio 2, or Default.
- **VGA:** Audio 1 and Audio 2.
- **Component:** Audio 1 and Audio 2.
- **Video:** Audio 1 and Audio 2.

# USING THE PROJECTOR

## *Setup menu*

### Setup projection menu

#### Projection

Select the preferred projection between front, rear, ceiling-top, and rear-top.

### Setup screen type menu

#### Screen Type (for WUXGA model only)

Choose the screen type from 16:9 and 16:10.

### Setup power settings menu

#### Direct Power On

Choose “On” to activate Direct Power mode. The projector will automatically power on when AC power is supplied, without pressing the “Power” key on the projector keypad or on the remote control.

#### Signal Power On

Choose “On” to activate Signal Power mode. The projector will automatically power on when a signal is detected, without pressing the “Power” key on the projector Keypad or on the remote control.

**Note:** *If the “Signal Power On” option is turned “On”, the power consumption of the projector in standby mode will be over 3W.*

#### Auto Power Off (min.)

Sets the countdown timer interval. The countdown timer will start, when there is no signal being sent to the projector. The projector will automatically power off when the countdown has finished (in minutes).

#### Sleep Timer (min.)

Configure the sleep timer.

- **Sleep Timer (min.):** Sets the countdown timer interval. The countdown timer will start, with or without a signal being sent to the projector. The projector will automatically power off when the countdown has finished (in minutes).

**Note:** *The Sleep Timer is reset every time when the projector is powered off.*

- **Always On:** Check to set the sleep timer always on.

#### Power Mode (Standby)

Set the power mode setting.

- **Active:** Choose “Active” to return to normal standby.
- **Eco:** Choose “Eco.” to save power dissipation further < 0.5W.

#### USB Power (Standby)

Enable or disable the USB power function when the projector is in standby mode.

# USING THE PROJECTOR

## Setup security menu

### Security

Enable this function to prompt for a password before using the projector.

- **On:** Choose “On” to use security verification when the turning on the projector.
- **Off:** Choose “Off” to be able to switch on the projector without password verification.

### Security Timer

Can be select the time (Month/Day/Hour) function to set the number of hours the projector can be used. Once this time has elapsed you will be requested to enter your password again.

### Change Password

Use to set or modify the password that is prompted when turning the projector on.

## Setup HDMI link settings menu

### **Note:**

- *When you connect HDMI CEC-compatible devices to the projector with HDMI cables, you can control them on the same power on or power off status using the HDMI Link control feature in the projector’s OSD. This lets one device or multiple devices in a group power on or power off via HDMI Link Feature in a typical configuration, your DVD player may be connected to the projector through an amplifier or home theater system.*

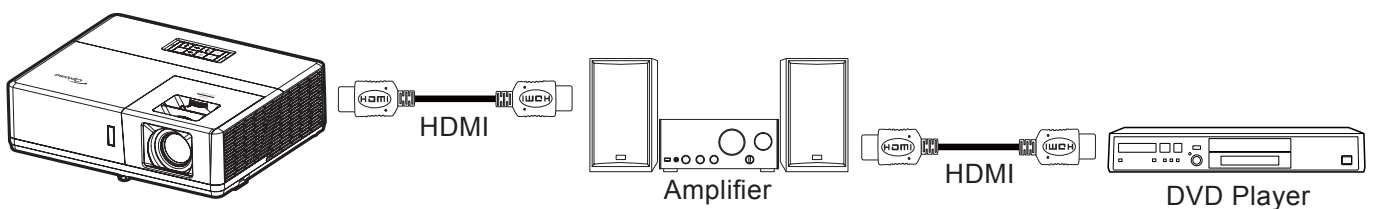

### HDMI Link

Enable/disable the HDMI Link function. The inclusive TV, power on link, and power off link options will only available if the setting is set to “On”.

### Inclusive of TV

Set to “Yes” if you prefer both TV and projector to be automatically turned off at the same time. To prevent both devices to be turned off at the same time, set the setting to “No”.

### Power On Link

CEC power on command.

- **Mutual:** Both projector and CEC device will be turned on simultaneously.
- **PJ → Device:** The CEC device will be turned on only after the projector is switched on.
- **Device → PJ:** The projector will be switched on only after the CEC device is turned on.

### Power Off Link

Enable this function to let both HDMI Link and projector to be automatically turned off at the same time.

# USING THE PROJECTOR

## Setup test pattern menu

### Test Pattern

Select the test pattern from green grid, magenta grid, white grid, white, or disable this function (off).

## Setup remote settings menu

### IR Function

Set the IR function setting.

- **On:** Choose “On”, the projector can be operated by the remote control from the top and front IR receivers.
- **Off:** Choose “Off”, the projector can't be operated by the remote control. By selecting “Off”, you will be able to use the Keypad keys.

### Remote Code

Set the remote custom code by pressing the remote ID button for 3 seconds and you will notice the remote indicator (above the Off button) starts blinking. Then, input a number between 00-99 using the keyboard numbered keys. After inserting the number, the remote indicator blinks twice quickly indicating that the remote code has changed.

### F1/F2/F3

Assign the default function for F1, F2, or F3 between Test Pattern, Brightness, Contrast, Sleep Timer, Color Matching, Color Temp, Gamma, or Projection.

## Setup projector ID menu

### Projector ID

ID definition can be set up by menu (range 0-99), and allow user control an individual projector by using RS232 command.

## Setup options menu

### Language

Select the multilingual OSD menu between English, German, French, Italian, Spanish, Portuguese, Polish, Dutch, Swedish, Norwegian/Danish, Finnish, Greek, traditional Chinese, simplified Chinese, Japanese, Korean, Russian, Hungarian, Czechoslovak, Arabic, Thai, Turkish, Farsi, Vietnamese, Indonesian, Romanian, and Slovakian.

### Closed Captioning

Closed Captioning is a text version of the program sound or other information displayed on the screen. If the input signal contains closed captions, you can turn on the feature and watch the channels. The available options include “Off”, “CC1”, and “CC2”.

### Menu Settings

Set the menu location on the screen and configure menu timer settings.

- **Menu Location:** Select the menu location on the display screen.
- **Menu Timer:** Set the duration where the OSD menu stays visible on the screen.

### Auto Source

Choose this option to let the projector automatically find an available input source.

# USING THE PROJECTOR

## **Input Source**

Select the input source between HDMI1/MHL, HDMI2, VGA, Component, and Video.

## **Input Name**

Use to rename the input function for easier identification. The available options include HDMI1/MHL, HDMI2, VGA, Component, and Video.

## **VGA Out**

Specify which the VGA Out connector to be used to connect the projector with the external display device.

## **High Altitude**

When "On" is selected, the fans will spin faster. This feature is useful in high altitude areas where the air is thin.

## **Display Mode Lock**

Choose "On" or "Off" to lock or unlock adjusting display mode settings.

## **Keypad Lock**

When the keypad lock function is "On", the Keypad will be locked. However, the projector can be operated by the remote control. By selecting "Off", you will be able to reuse the Keypad.

## **Information Hide**

Enable this function to hide the information message.

- **Off:** Choose "Off" to show the "searching" message.
- **On:** Choose "On" to hide the info message.

## **Logo**

Use this function to set the desired startup screen. If changes are made, they will take effect the next time the projector is powered on.

- **Default:** The default startup screen.
- **Neutral:** Logo is not displayed on startup screen.
- **User:** Use the stored picture as the startup screen.

## **Background Color**

Use this function to display a blue, red, green, gray color, none, or logo screen when no signal is available.

**Note:** *If the background color is set to "None", then the background color is black.*

## **Setup reset OSD menu**

### **Reset OSD**

Return the factory default settings for OSD menu settings.

### **Reset to Default**

Return the factory default settings for all settings.

# USING THE PROJECTOR

## *Network menu*

### **Network LAN menu**

#### **Network Status**

Display the network connection status (read-only).

#### **MAC Address**

Display the MAC address (read-only).

#### **DHCP**

Use this option to enable or disable the DHCP function.

- **Off:** To assign IP, subnet mask, gateway, and DNS configuration manually.
- **On:** Projector will obtain an IP address automatically from your network.

**Note:** *Exiting OSD will automatically apply the entered values.*

#### **IP Address**

Display the IP address.

#### **Subnet Mask**

Display subnet mask number.

#### **Gateway**

Display the default gateway of the network connected to the projector.

#### **DNS**

Display the DNS number.

### **How to use web browser to control your projector**

1. Turn "On" the DHCP option on projector to allow a DHCP server to automatically assign an IP address.
2. Open the web browser in your PC and type in the projector's IP address ("Network > LAN > IP Address").
3. Enter the user name and password, and click "Login".  
The projector's configuration web interface opens.

**Note:**

- *The default user name and password is "admin".*
- *The steps in this section is based on Windows 7 operating system.*

# USING THE PROJECTOR

## Making a direct connection from your computer to the projector\*

1. Turn “Off” the DHCP option on the projector.
2. Configure the IP address, Subnet Mask, Gateway, and DNS on projector (“Network > LAN”).
3. Open **Network and Sharing Center** page on your PC, and assign the identical network parameters to your PC as set on projector. Click “OK” to save the parameters.

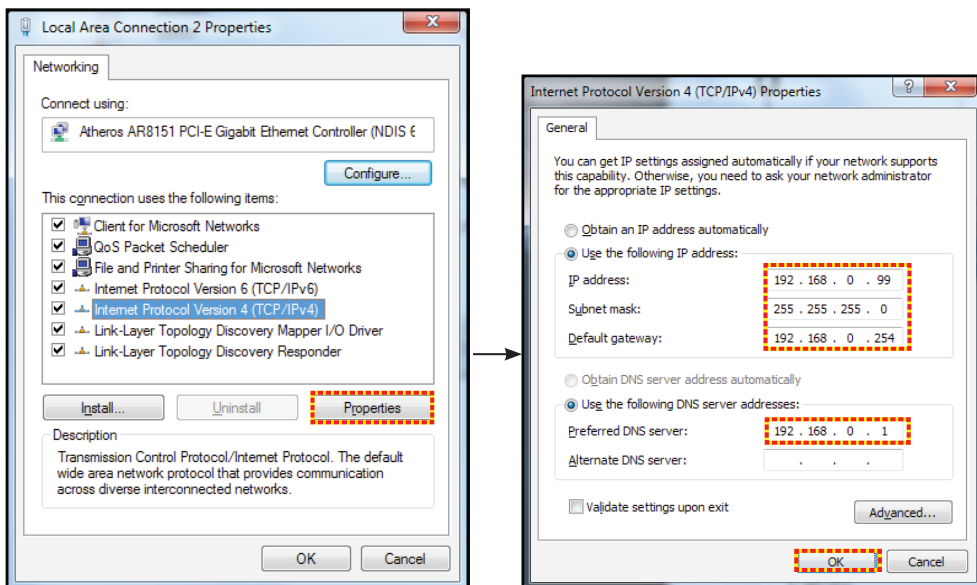

4. Open the web browser on your PC and type in to the URL field the IP address, assigned in step 3. Then press “Enter” key.

### Reset

Reset all values for LAN parameters.

## Network control menu

### Crestron

Use this function to select the network function (port: 41794).

For more information, please visit <http://www.crestron.com> and [www.crestron.com/getroomview](http://www.crestron.com/getroomview).

### Extron

Use this function to select the network function (port: 2023).

### PJ Link

Use this function to select the network function (port: 4352).

### AMX Device Discovery

Use this function to select the network function (port: 9131).

### Telnet

Use this function to select the network function (port: 23).

### HTTP

Use this function to select the network function (port: 80).

# USING THE PROJECTOR

## Setup network control settings menu

### LAN\_RJ45 function

For simplicity and ease of operation, the projector provides diverse networking and remote management features. The LAN / RJ45 function of the projector through a network, such as remotely manage: Power On / Off, brightness, and contrast settings. Also, you can view the projector status information, such as: Video- Source, Sound-Mute, etc.

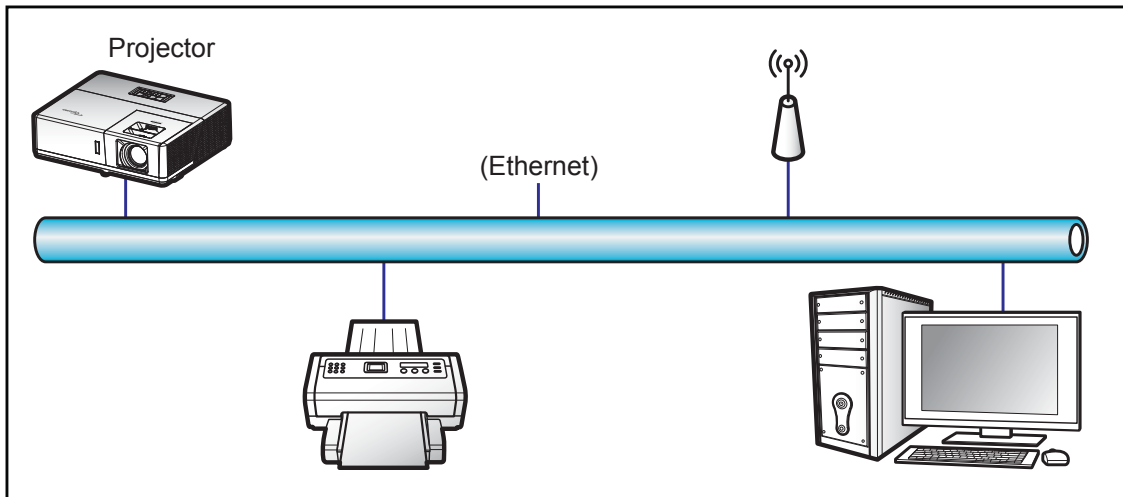

### Wired LAN terminal functionalities

This projector can be controlled by using a PC (laptop) or other external device via LAN / RJ45 port and compatible with Crestron / Extron / AMX (Device -Discovery) / PJLink.

- Crestron is a registered trademark of Crestron Electronics, Inc. of the United States.
- Extron is a registered trademark of Extron Electronics, Inc. of the United States.
- AMX is a registered trademark of AMX LLC of the United States.
- PJLink applied for trademark and logo registration in Japan, the United States of America, and other countries by JBMIA.

The projector is supported by the specified commands of the Crestron Electronics controller and related software, for example RoomView®.

<http://www.crestron.com/>

This projector is compliant to support Extron device(s) for reference.

<http://www.extron.com/>

This projector is supported by AMX ( Device Discovery ).

<http://www.amx.com/>

This projector supports all commands of PJLink Class1 (Version 1.00).

<http://pjlink.jbmia.or.jp/english/>

For more detailed information about the various types of external devices which can be connected to the LAN / RJ45 port and remote control the projector, as well as the supported commands for these external devices, please contact the Support-Service directly.



# USING THE PROJECTOR

## LAN RJ45

1. Connect an RJ45 cable to RJ45 ports on the projector and the PC (laptop).

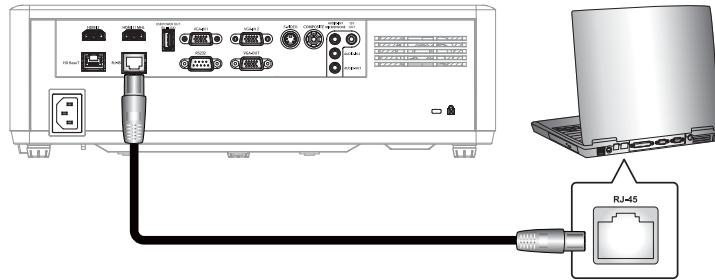

2. On the PC (Laptop), select **Start > Control Panel > Network Connections**.

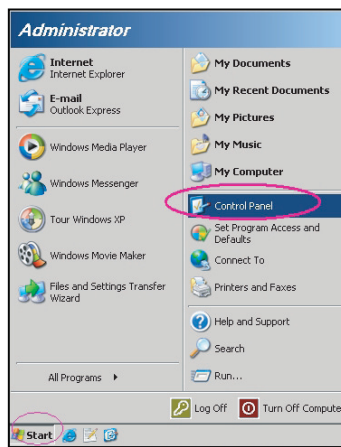

3. Right-click on the **Local Area Connection**, and select **Property**.

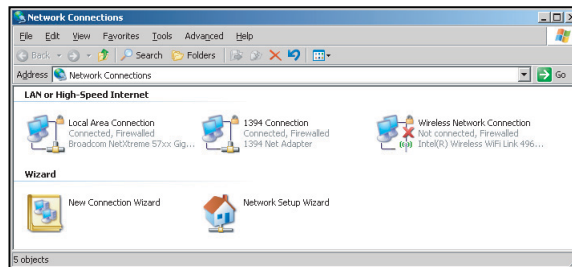

4. In the **Properties** window, select the **General tab**, and select **Internet Protocol (TCP / IP)**.

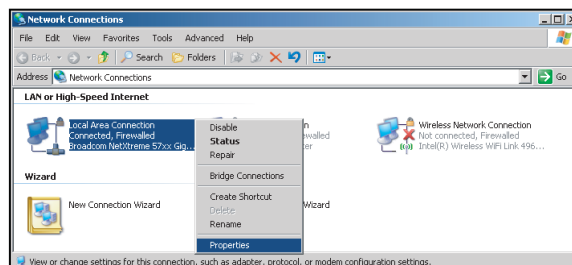

# USING THE PROJECTOR

5. Click “Properties”.

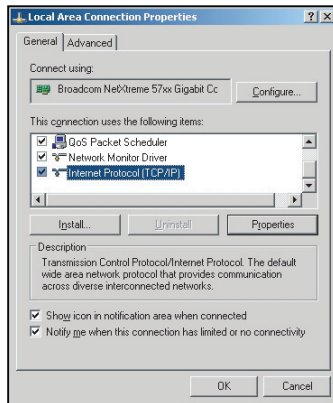

6. Type in the IP address and Subnet mask, then press “OK”.

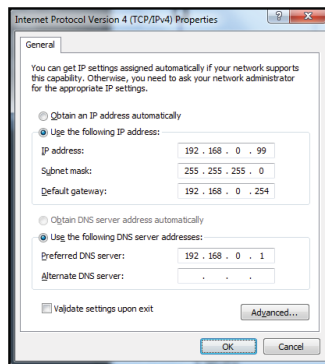

7. Press the “Menu” button on the projector.
8. Open on projector **Network > LAN**.
9. Enter the following connection parameters:
  - DHCP: Off
  - IP Address: 192.168.0.100
  - Subnet Mask: 255.255.255.0
  - Gateway: 192.168.0.254
  - DNS: 192.168.0.51
10. Press “Enter” to confirm settings.
11. Open a web browser, for example Microsoft Internet Explorer with Adobe Flash Player 9.0 or higher installed.
12. In the Address bar, input the projector’s IP address: 192.168.0.100.



13. Press “Enter”.

# USING THE PROJECTOR

The projector is setup for remote management. The LAN / RJ45 function displays as follows:

Information page

Main page

Tool page

Contact IT helpdesk

# USING THE PROJECTOR

## RS232 by Telnet Function

There is alternative RS232 command control way, in projector so called “RS232 by TELNET” for LAN / RJ45 interface.

### Quick Start-Guide for “RS232 by Telnet”

- Check and get the IP address on OSD of the projector.
- Make sure that the PC / laptop can access the web-page of the projector.
- Make sure that “Windows Firewall” setting is set disabled in case of “TELNET” function filtering out by PC / laptop.

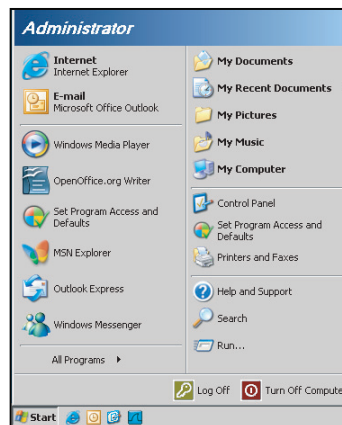

1. Select **Start > All Programs.> Accessories > Command Prompt.**

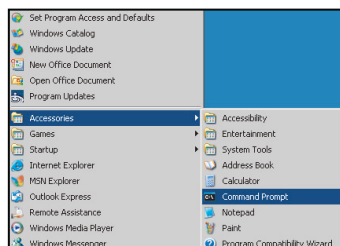

2. Input the command format as follows:
  - telnet ttt.xxx.yyy.zzz 23 (“Enter” key pressed)
  - (ttt.xxx.yyy.zzz: IP-Address of the projector)
3. If Telnet-Connection ready, and user can have RS232 command input, then “Enter” key pressed, the RS232 command will be workable.

### Specification for “RS232 by TELNET”:

1. Telnet: TCP.
2. Telnet port: 23 (for more detail, kindly please get contact with the service agent or team).
3. Telnet utility: Windows “TELNET.exe” (console mode).
4. Disconnection for RS232-by-Telnet control normally: Close
5. Windows Telnet utility directly after TELNET connection ready.
  - Limitation 1 for Telnet-Control: there is less than 50 bytes for successive network payload for Telnet-Control application.
  - Limitation 2 for Telnet-Control: there is less than 26 bytes for one complete RS232 command for Telnet-Control.
  - Limitation 3 for Telnet-Control: Minimum delay for next RS232 command must be more than 200 (ms).

# USING THE PROJECTOR

## *Info menu*

### **Info menu**

View the projector information as listed below:

- Regulatory
- Serial Number
- Source
- Resolution
- Refresh Rate
- Display Mode
- Color Depth
- Color Format
- Power Mode (Standby)
- Light Source Hours
- Remote Code
- Remote Code(Active)
- Network Status
- IP Address
- Projector ID
- Brightness Mode
- FW Version

# MAINTENANCE

## Installing and cleaning the dust filter

### Installing the dust filter

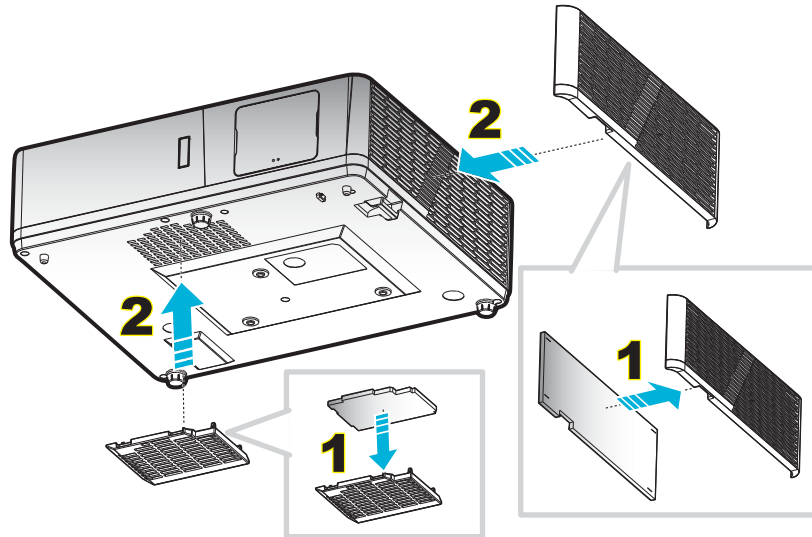

**Note:** Dust filters are only required/supplied in the selected regions with excessive dust.

### Cleaning the dust filter

We recommend you to clean the dust filter every three months. Clean it more often if the projector is used in a dusty environment.

Procedure:

1. Switch off the power to the projector by pressing the "⏻" button on the projector keypad or the "ⓘ" button on the remote control.
2. Disconnect the power cord.
3. Pull the dust filter compartment downwards to remove it out from the bottom of the projector. **1**
4. Carefully remove the air filter. Then clean or replace the dust filter. **2**
5. To install the dust filter, reverse the previous steps.

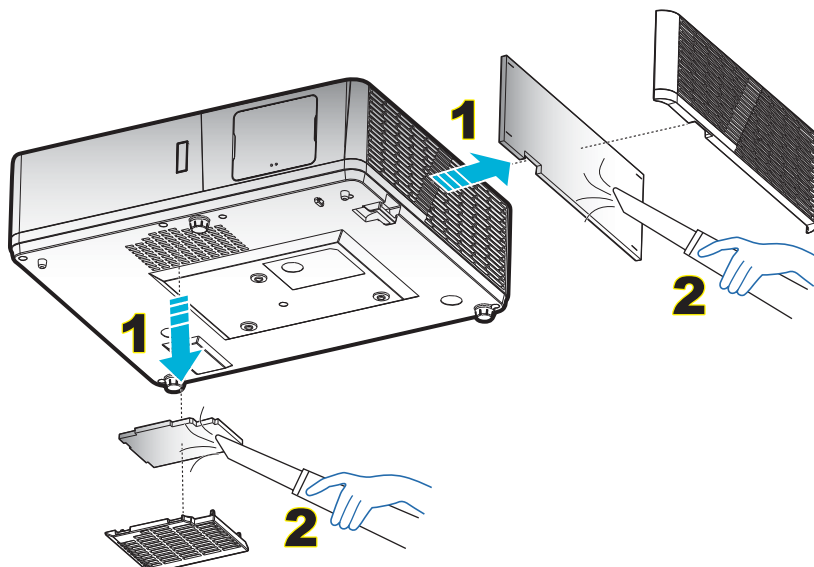

# ADDITIONAL INFORMATION

## Compatible resolutions

### Digital compatibility

B0 / Established Timing	B0 / Standard Timing	B0 / Detail Timing	B1 / Video Mode	B1 / Detail Timing
720 x 400 @ 70Hz	SVGA:	Native timing:	640 x 480p @ 60Hz	720 x 480p @ 60Hz
640 x 480 @ 60Hz	800 x 600 @120Hz	XGA:	720 x 480p @ 60Hz	1280 x 720p @ 60Hz
640 x 480 @ 67Hz	1024 x 768 @120Hz	1024 x 768 @60Hz	1280 x 720p @ 60Hz	1366 x 768 @ 60Hz
640 x 480 @ 72Hz	1280 x 800 @60Hz	WXGA:	1920 x 1080i @ 60Hz	1920 x 1080i @ 50Hz
640 x 480 @ 75Hz	1280 x 1024 @60Hz	1280 x 800 @60Hz	720(1440) x 480i @ 60Hz	1920 x 1080p @ 60Hz
800 x 600 @ 56Hz	1680 x 1050 @60Hz	1280 x 720 @60Hz	1920 x 1080p @ 60Hz	
800 x 600 @ 60Hz	1280 x 720 @60Hz	1080p:	720 x 576p @ 50Hz	
800 x 600 @ 72Hz	1280 x 720 @120Hz	1920 x 1080 @60Hz	1280 x 720p @ 50Hz	
800 x 600 @ 75Hz	1600 x 1200 @60Hz	WUXGA:	1920 x 1080i @ 50Hz	
832 x 624 @ 75Hz	XGA/WXGA:	1920x1200 @60Hz	720(1440) x 576i @ 50Hz	
1024 x 768 @ 60Hz	800 x 600 @120Hz		1920 x 1080p @ 50Hz	
1024 x 768 @ 70Hz	1440 x 900 @60Hz		1920 x 1080p @ 24Hz	
1024 x 768 @ 75Hz	1024 x 768 @120Hz		1920 x 1080p @ 30Hz	
1280 x 1024 @ 75Hz	1280 x 800 @60Hz			
1152 x 870 @ 75Hz	1280 x 1024 @60Hz			
	1680 x 1050 @60Hz			
	1280 x 720 @60Hz			
	1280 x 720 @120Hz			
	1600 x 1200 @60Hz			
	1080p/WUXGA:			
	1280 x 720 @ 60Hz			
	1280 x 800 @ 60Hz			
	1280 x1024 @ 60Hz			
	1400 x 1050 @ 60Hz			
	1600 x 1200 @ 60Hz			
	1280 X 768 @ 60Hz			
	1440 x 900 @60Hz			
	1280 x 720 @ 120Hz			
	1024 x 768 @ 120Hz			

# ADDITIONAL INFORMATION

## Analog compatibility

B0 / Established Timing	B0 / Standard Timing	B0 / Detail Timing	B1 / Detail Timing
720 x 400 @ 70Hz	SVGA:	Native timing:	1366 x 768 @ 60Hz
640 x 480 @ 60Hz	800 x 600 @120Hz	XGA:	
640 x 480 @ 67Hz	1024 x 768 @120Hz	1024 x 768 @60Hz	
640 x 480 @ 72Hz	1280 x 800 @60Hz	WXGA:	
640 x 480 @ 75Hz	1280 x 1024 @60Hz	1280 x 800 @60Hz;	
800 x 600 @ 56Hz	1680 x 1050 @60Hz	1280 x 720 @60Hz	
800 x 600 @ 60Hz	1280 x 720 @60Hz	1080p:	
800 x 600 @ 72Hz	1280 x 720 @120Hz	1920 x 1080 @60Hz	
800 x 600 @ 75Hz	1600 x 1200 @60Hz	WUXGA:	
832 x 624 @ 75Hz	XGA/WXGA:	1920x1200 @60Hz	
1024 x 768 @ 60Hz	800 x 600 @120Hz		
1024 x 768 @ 70Hz	1440 x 900 @60Hz		
1024 x 768 @ 75Hz	1024 x 768 @120Hz		
1280 x 1024 @ 75Hz	1280 x 800 @60Hz		
1152 x 870 @ 75Hz	1280 x 1024 @60Hz		
	1680 x 1050 @60Hz		
	1280 x 720 @60Hz		
	1280 x 720 @120Hz		
	1600 x 1200 @60Hz		
	1080p/WUXGA:		
	1280 x 720 @ 60Hz		
	1280 x 800 @ 60Hz		
	1280 x1024 @ 60Hz		
	1400 x 1050 @ 60Hz		
	1600 x 1200 @ 60Hz		
	1280 X 768 @ 60Hz		
	1440 x 900 @60Hz		
	1280 x 720 @ 120Hz		
	1024 x 768 @ 120Hz		



# ADDITIONAL INFORMATION

## True 3D video compatibility

		Input timing		
		Resolution	3D Format	Notes
<b>Input resolutions</b>	HDMI 1.4a 3D Input	1280 x 720P @ 50Hz	Top-and-Bottom	
		1280 x 720P @ 60Hz	Top-and-Bottom	
		1280 x 720P @ 50Hz	Frame packing	
		1280 x 720P @ 60Hz	Frame packing	
		1920 x 1080i @ 50Hz	Side-by-Side(Half)	
		1920 x 1080i @ 60Hz	Side-by-Side(Half)	
		1920 x 1080P @ 24Hz	Top-and-Bottom	
		1920 x 1080P @ 24Hz	Frame packing	
		HDMI 1.3	1920 x 1080i @ 50Hz	Side-by-Side(Half)
	1920 x 1080i @ 60Hz			
	1280 x 720P @ 50Hz			
	1280 x 720P @60Hz			
	800 x 600 @ 60Hz			
	1024 x 768 @ 60Hz			
	1280 x 800 @ 60Hz			
	1920 x 1080i @ 50Hz		Top-and-Bottom	TAB mode is on
	1920 x 1080i @ 60Hz			
	1280 x 720P @ 50Hz			
	1280 x 720P @60Hz			
	800 x 600 @ 60Hz			
1024 x 768 @ 60Hz	HQFS	3D format is Frame sequential		
1280 x 800 @ 60Hz				
480i				

### Note:

- If 3D input is 1080p@24Hz, the DMD should replay with integral multiple with 3D mode.
- Support NVIDIA 3DTV Play if there is no patent fee from Optoma.
- 1080i@25Hz and 720p@50Hz will run in 100Hz; 1080p@24Hz will run in 144Hz; other 3D timing will run in 120Hz.

# ADDITIONAL INFORMATION

## Image size and projection distance

1080P

Desired Image Size						Projection Distance (C)			
Diagonal		Width		Height		Wide		Tele	
m	inch	m	inch	m	inch	m	feet	m	feet
0.91	36	0.80	31.38	0.45	17.65	1.1	3.66	1.8	5.86
1.02	40	0.89	34.86	0.50	19.61	1.2	4.07	2.0	6.51
1.27	50	1.11	43.58	0.62	24.51	1.5	5.08	2.5	8.13
1.52	60	1.33	52.29	0.75	29.42	1.9	6.10	3.0	9.76
1.78	70	1.55	61.01	0.87	34.32	2.2	7.12	3.5	11.39
2.03	80	1.77	69.73	1.00	39.22	2.5	8.13	4.0	13.02
2.29	90	1.99	78.44	1.12	44.12	2.8	9.15	4.5	14.64
2.54	100	2.21	87.16	1.25	49.03	3.1	10.17	5.0	16.27
3.05	120	2.66	104.59	1.49	58.83	3.7	12.20	6.0	19.52
3.81	150	3.32	130.74	1.87	73.54	4.6	15.25	7.4	24.40
4.57	180	3.98	156.88	2.24	88.25	5.6	18.30	8.9	29.28
5.08	200	4.43	174.32	2.49	98.05	6.2	20.34	9.9	32.54
6.35	250	5.53	217.89	3.11	122.57	7.7	25.42	/	/
7.62	300	6.64	261.47	3.74	147.08	9.3	30.51	/	/

Lens Shift Range					
PJ lens Center to top of image				Image Shift Range	
Vertical + (Max) (A)	Vertical - (Min) (B)	Vertical Shift Range	Vertical range at any Horizontal position	Horizontal +	Horizontal -
cm	cm			(Right)	(Left)
cm	cm	cm	cm	cm	cm
53.2	46.4	6.7	N/A	0	0
59.1	51.6	7.5	N/A	0	0
73.8	64.5	9.3	N/A	0	0
88.6	77.4	11.2	N/A	0	0
103.4	90.3	13.1	N/A	0	0
118.2	103.2	14.9	N/A	0	0
132.9	116.1	16.8	N/A	0	0
147.7	129.0	18.7	N/A	0	0
177.2	154.8	22.4	N/A	0	0
221.5	193.5	28.0	N/A	0	0
265.8	232.2	33.6	N/A	0	0
295.4	258.0	37.4	N/A	0	0
369.2	322.5	46.7	N/A	0	0
443.1	387.0	56.0	N/A	0	0

# ADDITIONAL INFORMATION

## WUXGA

Desired Image Size						Projection Distance (C)			
Diagonal		Width		Height		Wide		Tele	
m	inch	m	inch	m	inch	m	feet	m	feet
0.91	36	0.78	30.53	0.48	19.08	1.1	3.56	1.7	5.70
1.02	40	0.86	33.92	0.54	21.20	1.2	3.96	1.9	6.33
1.27	50	1.08	42.40	0.67	26.50	1.5	4.95	2.4	7.91
1.52	60	1.29	50.88	0.81	31.80	1.8	5.94	2.9	9.50
1.78	70	1.51	59.36	0.94	37.10	2.1	6.93	3.4	11.08
2.03	80	1.72	67.84	1.08	42.40	2.4	7.91	3.9	12.66
2.29	90	1.94	76.32	1.21	47.70	2.7	8.90	4.3	14.25
2.54	100	2.15	84.80	1.35	53.00	3.0	9.89	4.8	15.83
3.05	120	2.58	101.76	1.62	63.60	3.6	11.87	5.8	19.00
3.81	150	3.23	127.20	2.02	79.50	4.5	14.84	7.2	23.74
4.57	180	3.88	152.64	2.42	95.40	5.4	17.81	8.7	28.49
5.08	200	4.31	169.60	2.69	106.00	6.0	19.79	9.6	31.66
6.35	250	5.38	212.00	3.37	132.50	7.5	24.73	/	/
7.62	300	6.46	254.40	4.04	159.00	9.0	29.68	/	/

Lens Shift Range					
PJ lens Center to top of image				Image Shift Range	
Vertical + (Max) (A)	Vertical - (Min) (B)	Vertical Shift Range	Vertical range at any Horizontal position	Horizontal +	Horizontal -
cm	cm			(Right)	(Left)
cm	cm	cm	cm	cm	cm
51.9	47.5	4.4	N/A	0	0
57.6	52.8	4.8	N/A	0	0
72.0	66.0	6.1	N/A	0	0
86.4	79.2	7.3	N/A	0	0
100.8	92.3	8.5	N/A	0	0
115.2	105.5	9.7	N/A	0	0
129.6	118.7	10.9	N/A	0	0
144.0	131.9	12.1	N/A	0	0
172.9	158.3	14.5	N/A	0	0
216.1	197.9	18.2	N/A	0	0
259.3	237.5	21.8	N/A	0	0
288.1	263.9	24.2	N/A	0	0
360.1	329.8	30.3	N/A	0	0
432.1	395.8	36.3	N/A	0	0

# ADDITIONAL INFORMATION

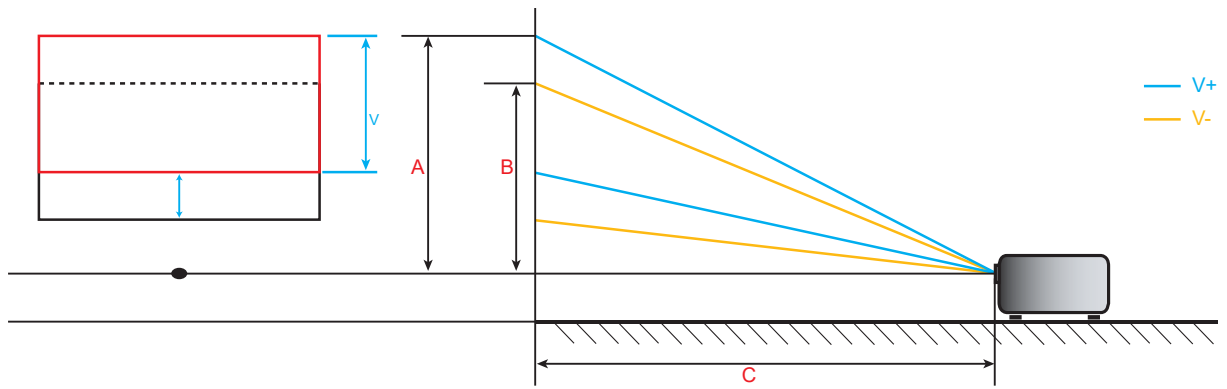

# ADDITIONAL INFORMATION

## Projector dimensions and ceiling mount installation

1. To prevent damage to your projector, please use the Optoma ceiling mount.
2. If you wish to use a third party ceiling mount kit, please ensure the screws used to attach a mount to the projector meet the following specifications:
  - Screw type: M6\*10
  - Minimum screw length: 10mm

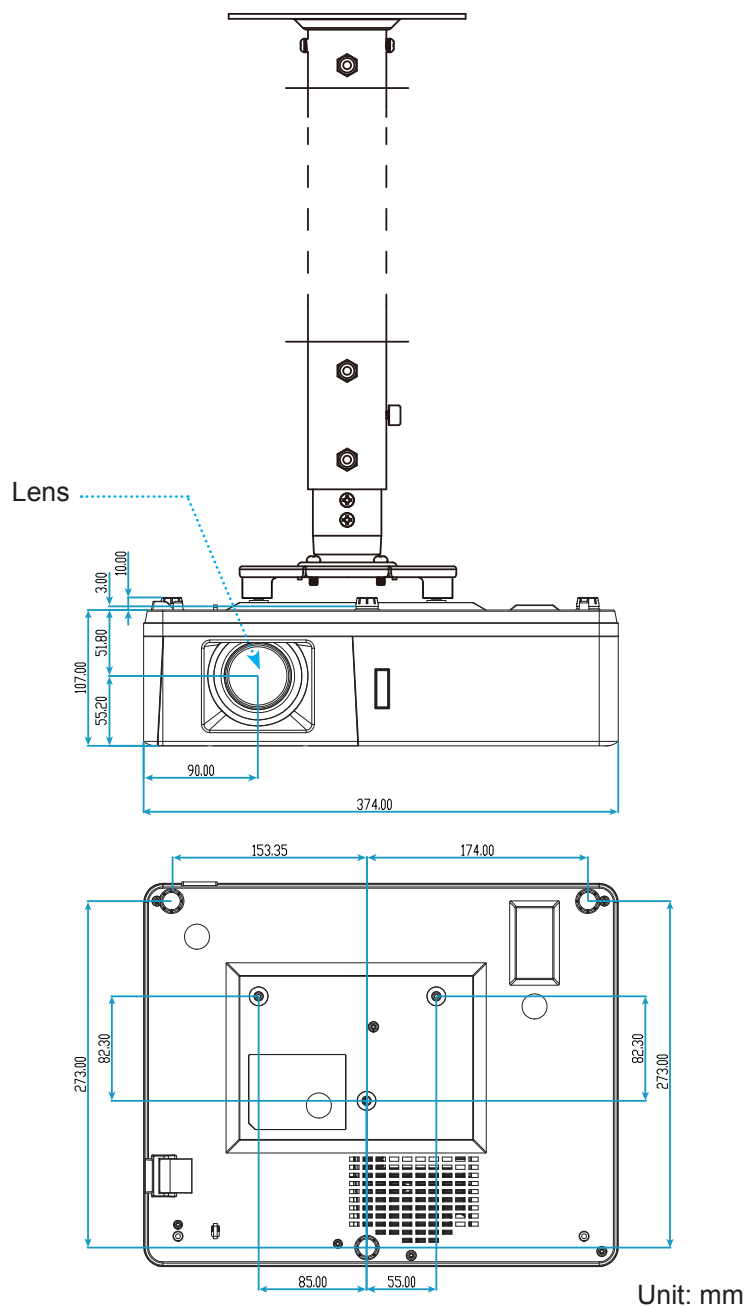

**Note:** Please note that damage resulting from incorrect installation will void the warranty.



Warning:

- If you buy a ceiling mount from another company, please be sure to use the correct screw size. Screw size will vary depending on the thickness of the mounting plate.
- Be sure to keep at least 10 cm gap between the ceiling and the bottom of the projector.
- Avoid installing the projector near a heat source.

# ADDITIONAL INFORMATION

## IR remote codes

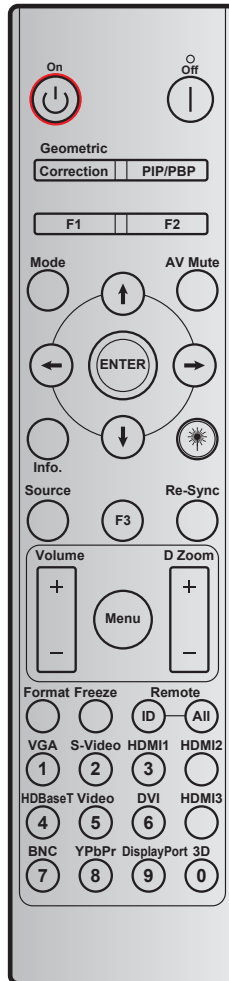

Key	Printing-key definition	Key code				Repeat
		BYTE1	BYTE2	BYTE3	BYTE4	
		customer 0	customer 1	data 0	data 1	
Power On	On	32	CD	02	#BYTE3	F2
Power Off	Off	32	CD	2E	#BYTE3	F2
Geometric Correction	Geometric Correction	32	CD	96	#BYTE3	F2
PIP/PBP	PIP/PBP	32	CD	78	#BYTE3	F2
F1	F1	32	CD	26	#BYTE3	F2
F2	F2	32	CD	27	#BYTE3	F2
Mode	Mode	32	CD	95	#BYTE3	F2
Four directional select keys (	Up arrow	32	CD	C6	#BYTE3	F2
	Down arrow	32	CD	C7	#BYTE3	F2
	Left arrow	32	CD	C8	#BYTE3	F2
	Right arrow	32	CD	C9	#BYTE3	F2
Enter	Enter	32	CD	C5	#BYTE3	F2
AV Mute	AV Mute	32	CD	03	#BYTE3	F2
Information	Info.	32	CD	25	#BYTE3	F2

# ADDITIONAL INFORMATION







Key	Printing-key definition	Key code				Repeat
		BYTE1	BYTE2	BYTE3	BYTE4	
		customer 0	customer 1	data 0	data 1	
Laser ✱	Laser	N/A	N/A	N/A	N/A	N/A
Source	Source	32	CD	18	#BYTE3	F2
F3	F3	32	CD	66	#BYTE3	F2
Re-Sync	Re-Sync	32	CD	04	#BYTE3	F2
Volume	Volume +	32	CD	09	#BYTE3	F2
	Volume -	32	CD	0C	#BYTE3	F2
D Zoom	D Zoom +	32	CD	08	#BYTE3	F2
	D Zoom -	32	CD	0B	#BYTE3	F2
Menu	Menu	32	CD	88	#BYTE3	F2
Format	Format	32	CD	15	#BYTE3	F2
Freeze	Freeze	32	CD	06	#BYTE3	F2
Remote	Remote ID	3201~ 3299		N/A		
	Remote All	32CD		N/A		
VGA / 1	1/VGA	32	CD	8E	#BYTE3	F2
S-Video / 2	2/S-Video	32	CD	1D	#BYTE3	F2
HDMI1 / 3	3/HDMI1	32	CD	16	#BYTE3	F2
HDMI2	HDMI2	32	CD	9B	#BYTE3	F2
HDBaseT / 4	4/HDBaseT	32	CD	70	#BYTE3	F2
Video / 5	5/Video	32	CD	1C	#BYTE3	F2
DVI / 6	6/DVI	32	CD	19	#BYTE3	F2
HDMI3	HDMI3	32	CD	98	#BYTE3	F2
BNC / 7	7/BNC	32	CD	1A	#BYTE3	F2
YPbPr / 8	8/YPbPr	32	CD	17	#BYTE3	F2
Display Port / 9	9/DisplayPort	32	CD	9F	#BYTE3	F2
3D / 0	0/3D	32	CD	89	#BYTE3	F2

# ADDITIONAL INFORMATION

## Troubleshooting

If you experience a problem with your projector, please refer to the following information. If a problem persists, please contact your local reseller or service center.

### Image problems

-  *No image appears on-screen*
  - Ensure all the cables and power connections are correctly and securely connected as described in the "Installation" section.
  - Ensure the pins of connectors are not crooked or broken.
  - Ensure that the "Mute" feature is not turned on.
  
-  *Image is out of focus*
  - Turn the focus ring clockwise or counterclockwise until the image is sharp and legible. (Please see page 19).
  - Make sure the projection screen is between the required distance from the projector. (Please refer to pages 58-60).
  
-  *The image is stretched when displaying 16:9 DVD title*
  - When you play anamorphic DVD or 16:9 DVD, the projector will show the best image in 16: 9 format on projector side.
  - If you play the LBX format DVD title, please change the format as LBX in projector OSD.
  - If you play 4:3 format DVD title, please change the format as 4:3 in projector OSD.
  - Please setup the display format as 16:9 (wide) aspect ratio type on your DVD player.
  
-  *Image is too small or too large*
  - Turn the zoom lever clockwise or counterclockwise to increase or decrease the projected image size. (Please see page 19).
  - Move the projector closer to or further from the screen.
  - Press "Menu" on the projector panel, go to "Display → Aspect Ratio". Try the different settings.
  
-  *Image has slanted sides:*
  - If possible, reposition the projector so that it is centered on the screen and below the bottom of the screen.
  
-  *Image is reversed*
  - Select "Setup → Projection" from the OSD and adjust the projection direction.



# ADDITIONAL INFORMATION

## Other problems



*The projector stops responding to all controls*

- If possible, turn off the projector, then unplug the power cord and wait at least 20 seconds before reconnecting power.

## Remote control problems



*If the remote control does not work*

- Check the operating angle of the remote control is pointed within  $\pm 30^\circ$  to the IR receiver on the projector.
- Make sure there are not any obstructions between the remote control and the projector. Move to within 12 m (39.4 ft) of the projector.
- Make sure batteries are inserted correctly.
- Replace batteries if they are exhausted.

# ADDITIONAL INFORMATION

## Warning indicators

When the warning indicators (see below) light up or flash, the projector will automatically shutdown:

- “Lamp” LED indicator is lit red and if “Power” indicator flashes red.
- “Temp” LED indicator is lit red and if “Power” indicator flashes red. This indicates the projector has overheated. Under normal conditions, the project can be switched back on.
- “Temp” LED indicator flashes red and if “Power” indicator flashes red.

Unplug the power cord from the projector, wait for 30 seconds and try again. If the warning indicator light up or flash, please contact your nearest service center for assistance.

## LED lightning messages

Message	Power LED		Temp LED	Lamp LED
	(Red)	(Blue)	(Red)	(Red)
Standby state (Input power cord)	Steady light			
Power on (Warming)		Flashing (0.5 sec off / 0.5 sec on)		
Power on and Lamp lighting		Steady light		
Power off (Cooling)		Flashing (0.5 sec off / 0.5 sec on). Back to red steady light when cooling fan turns off.		
Quick Resume(100 secs)		Flashing (0.25 sec off / 0.25 sec on)		
Error (Lamp failure)	Flashing			Steady light
Error (Fan failure)	Flashing		Flashing	
Error (Over temp.)	Flashing		Steady light	

- Power off:

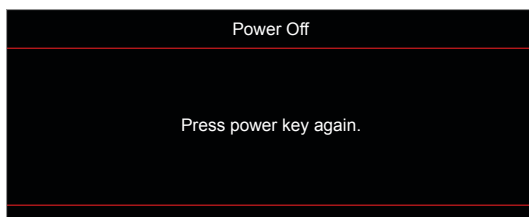

- Temperature warning:

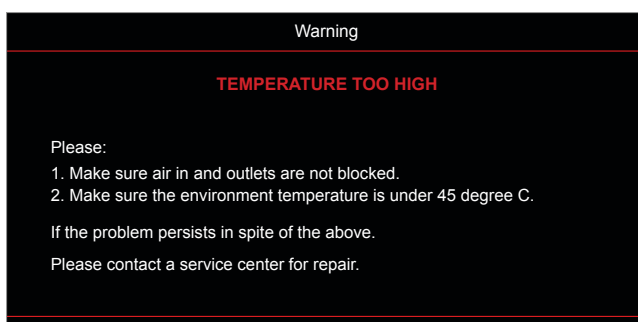

# ADDITIONAL INFORMATION

## Specifications

Optical	Description
Maximum resolution	1920x1200@60Hz(RB)
Native resolution	<ul style="list-style-type: none"><li>1080p</li><li>WUXGA</li></ul>
Lens	Manual zoom and manual focus
Image size (diagonal)	<ul style="list-style-type: none"><li>1080p: 26.2"~301.1"</li><li>WUXGA: 27"~309"</li></ul>
Projection distance	1.3m~9.4m (focus range with optimized@1.873m)

Electrical	Description
Inputs	<ul style="list-style-type: none"><li>HDMI 1.4a</li><li>HDMI 2.0b / MHL 2.2</li><li>VGA In (VGA In 2 connector, for 15 IO type only)</li><li>Composite (RCA connector (Y))</li><li>Audio In 3.5mm</li><li>Audio In 3.5mm, with Microphone</li><li>USB Type-A for power USB 5V/1.5A</li><li>S-Video (for 15 IO type only)</li></ul>
Outputs	<ul style="list-style-type: none"><li>VGA Out</li><li>Audio Out 3.5mm</li><li>12V Trigger (for 15 IO type only)</li></ul>
Control	<ul style="list-style-type: none"><li>USB Type A for mouse</li><li>RS232</li><li>RJ-45 (support web control)</li><li>RJ-45 for HDBaseT (for 15 IO type only)</li></ul>
Color reproduction	1073.4 Million color
Scan rate	<ul style="list-style-type: none"><li>Horizontal scan rate: 15.375~91.146 KHz</li><li>Vertical scan rate: 50~ 85 Hz (120Hz for 3D feature projector)</li></ul>
Built-in speaker	Yes, 10W
Power requirement	100 - 240V ±10%, AC 50/60Hz
Input current	3.8A

Mechanical	Description
Installation orientation	Front, Rear, Ceiling-top, Rear-top
Dimensions	<ul style="list-style-type: none"><li>374.0mm (W) x 302mm (D) x 107mm (H) (without feet)</li><li>374.0mm (W) x 302mm (D) x 117mm (H) (with feet)</li></ul>
Weight	5.5 ±0.5kg
Environmental conditions	Operating in 5 ~ 40°C , 10% to 85% humidity (non-condensing)

**Note:** All specifications are subject to change without notice.



# ADDITIONAL INFORMATION

## Optoma global offices

For service or support, please contact your local office.



### USA

47697 Westinghouse Drive,  
Fremont, CA 94539, USA  
www.optomausa.com

 888-289-6786  
 510-897-8601  
 [services@optoma.com](mailto:services@optoma.com)



### Canada

47697 Westinghouse Drive,  
Fremont, CA 94539, USA  
www.optomausa.com

 888-289-6786  
 510-897-8601  
 [services@optoma.com](mailto:services@optoma.com)



### Latin America

47697 Westinghouse Drive,  
Fremont, CA 94539, USA  
www.optomausa.com

 888-289-6786  
 510-897-8601  
 [services@optoma.com](mailto:services@optoma.com)



### Europe

Unit 1, Network 41, Bourne End Mills  
Hemel Hempstead, Herts,  
HP1 2UJ, United Kingdom  
www.optoma.eu  
Service Tel : +44 (0)1923 691865

 +44 (0) 1923 691 800  
 +44 (0) 1923 691 888  
 [service@tsc-europe.com](mailto:service@tsc-europe.com)



### Benelux BV

Randstad 22-123  
1316 BW Almere  
The Netherlands  
www.optoma.nl

 +31 (0) 36 820 0252  
 +31 (0) 36 548 9052



### France

Bâtiment E  
81-83 avenue Edouard Vaillant  
92100 Boulogne Billancourt, France

 +33 1 41 46 12 20  
 +33 1 41 46 94 35  
 [savoptoma@optoma.fr](mailto:savoptoma@optoma.fr)



### Spain

C/ José Hierro,36 Of. 1C  
28522 Rivas VaciaMadrid,  
Spain

 +34 91 499 06 06  
 +34 91 670 08 32



### Deutschland

Wiesenstrasse 21 W  
D40549 Düsseldorf,  
Germany

 +49 (0) 211 506 6670  
 +49 (0) 211 506 66799  
 [info@optoma.de](mailto:info@optoma.de)

### Scandinavia



Lerpeveien 25  
3040 Drammen  
Norway

 +47 32 98 89 90  
 +47 32 98 89 99  
 [info@optoma.no](mailto:info@optoma.no)

PO.BOX 9515  
3038 Drammen  
Norway

### Korea

WOOMI TECH.CO.,LTD.  
4F, Minu Bldg.33-14, Kangnam-Ku,  
Seoul,135-815, KOREA  
korea.optoma.com

 +82+2+34430004  
 +82+2+34430005



### Japan

東京都足立区綾瀬3-25-18  
株式会社オーエス  
コンタクトセンター:0120-380-495

 [info@os-worldwide.com](mailto:info@os-worldwide.com)  
[www.os-worldwide.com](http://www.os-worldwide.com)



### Taiwan

12F., No.213, Sec. 3, Beixin Rd.,  
Xindian Dist., New Taipei City 231,  
Taiwan, R.O.C.  
www.optoma.com.tw

 +886-2-8911-8600  
 +886-2-8911-6550  
 [services@optoma.com.tw](mailto:services@optoma.com.tw)  
[asia.optoma.com](http://asia.optoma.com)



### Hong Kong

Unit A, 27/F Dragon Centre,  
79 Wing Hong Street,  
Cheung Sha Wan,  
Kowloon, Hong Kong

 +852-2396-8968  
 +852-2370-1222  
[www.optoma.com.hk](http://www.optoma.com.hk)

### China

5F, No. 1205, Kaixuan Rd.,  
Changning District  
Shanghai, 200052, China

 +86-21-62947376  
 +86-21-62947375  
[www.optoma.com.cn](http://www.optoma.com.cn)



P/N:36.7D901G001-A