

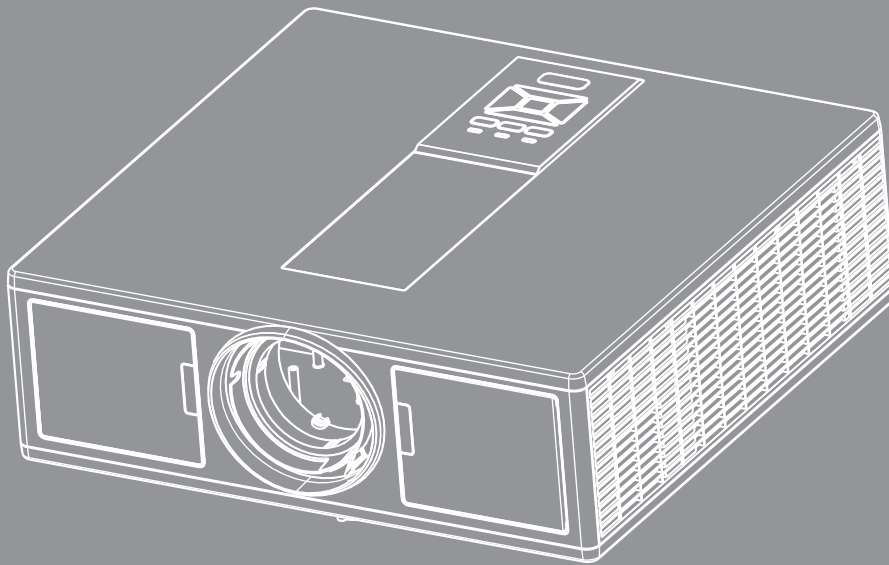

DLP® Projector





User's Manual



TABLE OF CONTENTS

| | |
|---|-----------|
| SAFETY | 3 |
| <i>Regulation & Safety Notices.....</i> | <i>5</i> |
| INTRODUCTION | 8 |
| <i>Package Overview</i> | <i>8</i> |
| <i>Product Overview</i> | <i>9</i> |
| <i>Main Unit</i> | <i>9</i> |
| <i>Control Panel.....</i> | <i>10</i> |
| <i>Connections</i> | <i>11</i> |
| <i>Remote Control</i> | <i>12</i> |
| SETUP AND INSTALLATION | 14 |
| <i>Connecting Source to the Projector</i> | <i>14</i> |
| <i>Powering the Projector On/Off</i> | <i>16</i> |
| <i>Warning Indicator</i> | <i>17</i> |
| <i>Adjusting the Projected Image</i> | <i>18</i> |
| USER CONTROLS | 21 |
| <i>Using the Control Panel</i> | <i>21</i> |
| <i>On-screen Display Menus</i> | <i>22</i> |
| <i>How to operate</i> | <i>22</i> |
| <i>Structure</i> | <i>23</i> |
| <i>Picture</i> | <i>27</i> |
| <i>Screen</i> | <i>29</i> |
| <i>Settings</i> | <i>31</i> |
| <i>Volume</i> | <i>32</i> |
| <i>Options</i> | <i>33</i> |
| <i>3D</i> | <i>36</i> |
| <i>LAN</i> | <i>37</i> |
| APPENDICES | 38 |
| <i>Projector Problems.....</i> | <i>38</i> |
| <i>How to use web browser to control your projector</i> | <i>40</i> |
| <i>Crestron RoomView Control Tool</i> | <i>41</i> |
| <i>Installing and Cleaning the Optional Dust Filter</i> | <i>43</i> |
| <i>Compatibility Modes</i> | <i>44</i> |
| <i>Ceiling Mount Installation</i> | <i>47</i> |
| <i>Optoma global offices.....</i> | <i>48</i> |

SAFETY

| | |
|---|---|
|  | The lightning flash with arrow head within an equilateral triangle is intended to alert the user to the presence of uninsulated “dangerous voltage” within the product’s enclosure that may be of sufficient magnitude to constitute a risk of electric shock to persons. |
|  | The exclamation point within an equilateral triangle is intended to alert the user to the presence of important operating and maintenance (servicing) instructions in the literature accompanying the appliance. |

WARNING: TO REDUCE THE RISK OF FIRE OR ELECTRIC SHOCK, DO NOT EXPOSE THIS APPLIANCE TO RAIN OR MOISTURE. DANGEROUS HIGH VOLTAGES ARE PRESENT INSIDE THE ENCLOSURE. DO NOT OPEN THE CABINET. REFER SERVICING TO QUALIFIED PERSONNEL ONLY.

Class B emissions limits

This Class B digital apparatus meets all requirements of the Canadian Interference-Causing Equipment Regulations.

Important Safety Instruction

1. Do not block any ventilation openings. To ensure reliable operation of the projector and to protect from over heating, it is recommended to install the projector in a location that does not block ventilation. As an example, do not place the projector on a crowded coffee table, sofa, bed, etc. Do not put the projector in an enclosure such as a book case or a cabinet that restricts air flow.
2. Do not use the projector near water or moisture. To reduce the risk of fire and/or electric shock, do not expose the projector to rain or moisture.
3. Do not install near heat sources such as radiators, heaters, stoves or any other apparatus such as amplifiers that emits heat.
4. Clean only with dry cloth.
5. Only use attachments/accessories specified by the manufacturer.
6. Do not use the unit if it has been physically damaged or abused.
Physical damage/abuse would be (but not limited to):
 - Unit has been dropped.
 - Power supply cord or plug has been damaged.
 - Liquid has been spilled on to the projector.
 - Projector has been exposed to rain or moisture.
 - Something has fallen in the projector or something is loose inside.Do not attempt to service the unit yourself. Opening or removing covers may expose you to dangerous voltages or other hazards.
7. Do not let objects or liquids enter the projector. They may touch dangerous voltage points and short out parts that could result in fire or electric shock.
8. See projector enclosure for safety related markings.
9. The unit should only be repaired by appropriate service personnel.

Precautions



Please follow all warnings, precautions and maintenance as recommended in this user's guide.

- Warning- Do not look into the projector's lens when the light source is on. The bright light may hurt and damage your eyes.
- Warning- To reduce the risk of fire or electric shock, do not expose this projector to rain or moisture.
- Warning- Please do not open or disassemble the projector as this may cause electric shock.
- Warning- Please do not open or disassemble the projector as this may cause electric shock.

Do:

- Turn off and unplug the power plug from the AC outlet before cleaning the product.
- Use a soft dry cloth with mild detergent to clean the display housing.
- Disconnect the power plug from AC outlet if the product is not being used for a long period of time.

Do not:

- Block the slots and openings on the unit provided for ventilation.
- Use abrasive cleaners, waxes or solvents to clean the unit.
- Use under the following conditions:
 - In extremely hot, cold or humid environments.
 - ▶ Sea level to 6000 feet
Extremely hot: > 35°C
Extremely cool: < 5°C
 - ▶ 6000 feet above
Extremely hot: > 30°C
Extremely cool: < 5°C
 - ▶ Extremely humid: > 70% R.H. (Relative Humidity)
 - In areas susceptible to excessive dust and dirt.
 - Near any appliance generating a strong magnetic field.
 - In direct sunlight.

3D Safety Information

Please follow all warnings and precautions as recommended before you or your child use the 3D function.

Warning

Children and teenagers may be more susceptible to health issues associated with viewing in 3D and should be closely supervised when viewing these images.

Photosensitive Seizure Warning and Other Health Risks

- Some viewers may experience an epileptic seizure or stroke when exposed to certain flashing images or lights contained in certain Projector pictures or video games. If you suffer from, or have a family history of epilepsy or strokes, please consult with a medical specialist before using the 3D function.
- Even those without a personal or family history of epilepsy or stroke may have an undiagnosed condition that can cause photosensitive epileptic seizures.
- Pregnant women, the elderly, sufferers of serious medical conditions, those who are sleep deprived or under the influence of alcohol should avoid utilizing the unit's 3D functionality.
- If you experience any of the following symptoms, stop viewing 3D pictures immediately and consult a medical specialist: (1) altered vision; (2) light-headedness; (3) dizziness; (4) involuntary movements such as eye or muscle twitching; (5) confusion; (6) nausea; (7) loss of awareness; (8) convulsions; (9) cramps; and/ or (10) disorientation. Children and teenagers may be more likely than adults to experience these symptoms. Parents should monitor their children and ask whether they are experiencing these symptoms.

- Watching 3D projection may also cause motion sickness, perceptual after effects, disorientation, eye strain and decreased postural stability. It is recommended that users take frequent breaks to lessen the potential of these effects. If your eyes show signs of fatigue or dryness or if you have any of the above symptoms, immediately discontinue use of this device and do not resume using it for at least thirty minutes after the symptoms have subsided.
- Watching 3D projection while sitting too close to the screen for an extended period of time may damage your eyesight. The ideal viewing distance should be at least three times the screen height. It is recommended that the viewer's eyes are level with the screen.
- Watching 3D projection while wearing 3D glasses for an extended period of time may cause a headache or fatigue. If you experience a headache, fatigue or dizziness, stop viewing the 3D projection and rest.
- Do not use the 3D glasses for any other purpose than for watching 3D projection.
- Wearing the 3D glasses for any other purpose (as general spectacles, sunglasses, protective goggles, etc.) may be physically harmful to you and may weaken your eyesight.
- Viewing in 3D projection may cause disorientation for some viewers. Accordingly, DO NOT place your 3D PROJECTOR near open stairwells, cables, balconies, or other objects that can be tripped over, run into, knocked down, broken or fallen over.

Copyright

This publication, including all photographs, illustrations and software, is protected under international copyright laws, with all rights reserved. Neither this manual, nor any of the material contained herein, may be reproduced without written consent of the author.

© Copyright 2015

Disclaimer

The information in this document is subject to change without notice. The manufacturer makes no representations or warranties with respect to the contents hereof and specifically disclaims any implied warranties of merchantability or fitness for any particular purpose. The manufacturer reserves the right to revise this publication and to make changes from time to time in the content hereof without obligation of the manufacturer to notify any person of such revision or changes.

Trademark Recognition

Kensington is a U.S. registered trademark of ACCO Brand Corporation with issued registrations and pending applications in other countries throughout the world.

HDMI, the HDMI Logo, and High-Definition Multimedia Interface are trademarks or registered trademarks of HDMI Licensing LLC in the United States and other countries.

IBM is a trademark or registered trademark of International Business Machines, Inc. Microsoft, PowerPoint, and Windows are trademarks or registered trademarks of Microsoft Corporation.

Adobe and Acrobat are trademarks or registered trademarks of Adobe Systems Incorporated.

DLP, DLP Link and the DLP logo are registered trademarks of Texas Instruments and BrilliantColor™ is a trademark of Texas Instruments.

All other product names used in this manual are the properties of their respective owners and are Acknowledged.

Regulation & Safety Notices

This appendix lists the general notices of your projector.

FCC notice

This device has been tested and found to comply with the limits for a Class B digital device pursuant to Part 15 of the FCC rules. These limits are designed to provide reasonable protection against harmful interference in a residential installation. This device generates, uses and can radiate radio frequency energy and, if not installed and used in accordance with the instructions, may cause harmful interference to radio communications.

However, there is no guarantee that interference will not occur in a particular installation. If this device does cause harmful interference to radio or television reception, which can be determined by turning the device off and on, the user is encouraged to try to correct the interference by one or more of the following measures:

- Reorient or relocate the receiving antenna.
- Increase the separation between the device and receiver.
- Connect the device into an outlet on a circuit different from that to which the receiver is connected.
- Consult the dealer or an experienced radio/television technician for help.

Notice: Shielded cables

All connections to other computing devices must be made using shielded cables to maintain compliance with FCC regulations.

Caution

Changes or modifications not expressly approved by the manufacturer could void the user's authority, which is granted by the Federal Communications Commission, to operate this projector.

Operation conditions

This device complies with Part 15 of the FCC Rules. Operation is subject to the following two conditions:

1. This device may not cause harmful interference and
2. This device must accept any interference received, including interference that may cause undesired operation.

Notice: Canadian users

This Class B digital apparatus complies with Canadian ICES-003.

Remarque à l'intention des utilisateurs canadiens

Cet appareil numérique de la classe B est conforme à la norme NMB-003 du Canada.

Declaration of Conformity for EU countries

- EMC Directive 2004/108/EC (including amendments)
- Low Voltage Directive 2006/95/EC
- R & TTE Directive 1999/5/EC (if product has RF function)

Disposal instructions



Do not throw this electronic device into the trash when discarding. To minimize pollution and ensure utmost protection of the global environment, please recycle it.

Safety notice

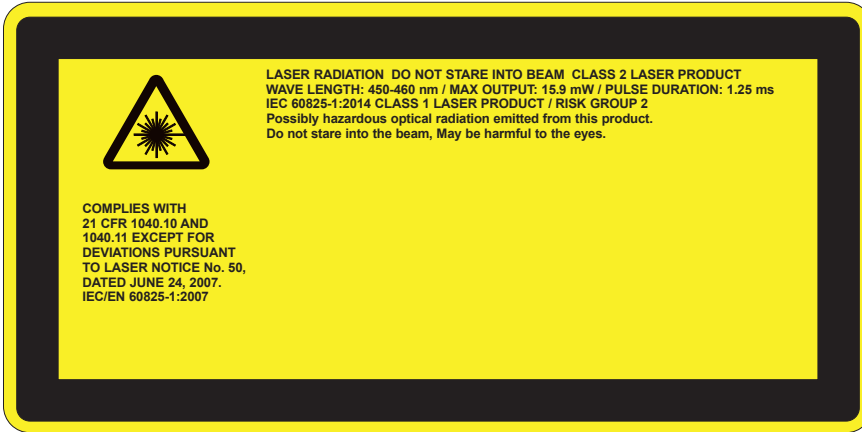

WARNING

- This product is classified as Class 2 of IEC 60825-1 : 2007 and also complies with 21 CFR 1040.10 and 1040.11 except for deviations pursuant to Laser Notice No. 50, dated June 24, 2007. IEC 60825-1:2014: CLASS 1 LASER PRODUCT - RISK GROUP 2
- Explanatory label is shown all information of laser power.
- This projector has built-in Class 4 laser module. Disassembly or modification is very dangerous and should never be attempted.
- Any operation or adjustment not specifically instructed by the user's guide creates the risk of hazardous laser radiation exposure.
- Do not open or disassemble the projector as this may cause damage by the exposure of laser radiation.
- Do not stare into beam when the projector is on. The bright light may result in permanent eye damage.
- When turning on the projector, make sure no one within projection range is looking at the lens.
- Without following the control, adjustment or operation procedure may cause damage by the exposure of laser radiation.
- Adequate instructions for assembly, operation, and maintenance, including clear warnings concerning precautions to avoid possible exposure to laser and collateral radiation in excess of the accessible emission limits in Class 2.
- This projector is a Class 2 laser device that conforms with IEC 60825-1:2007 and CFR 1040.10 and 1040.11.
- Class 2 laser product, Do Not Stare Into Beam.
- This projector has built-in Class 4 laser module. Disassembly or modification is very dangerous and should never be attempted.
- Any operation or adjustment not specifically instructed by the user's guide creates the risk of hazardous laser radiation exposure.
- Do not open or disassemble the projector as this may cause damage by the exposure of laser radiation.
- Do not stare into beam when the projector is on. The bright light may result in permanent eye damage.
- Without following the control, adjustment or operation procedure may cause damage by the exposure of laser radiation.
- Adequate instructions for assembly, operation, and maintenance, including clear warnings concerning precautions to avoid possible exposure to laser and collateral radiation in excess of the accessible emission limits in Class 2.

INTRODUCTION

Package Overview

Unpack and inspect the box contents to ensure all parts listed below are in the box. If something is missing, please contact your nearest customer service center.

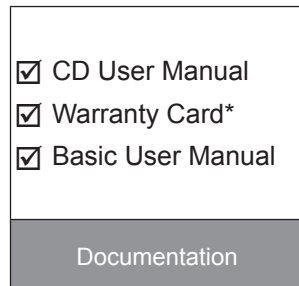
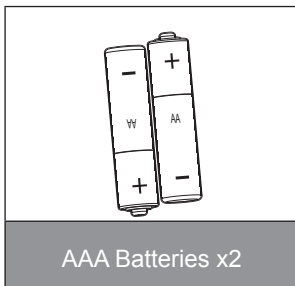
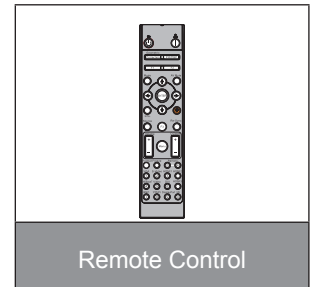
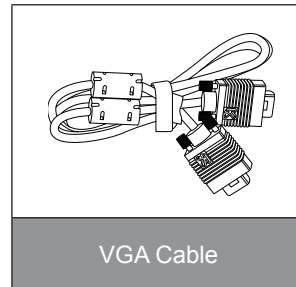
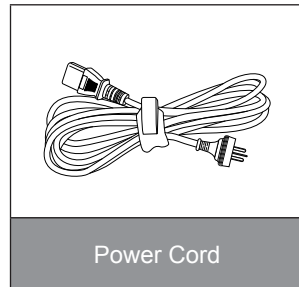
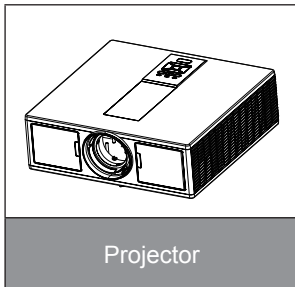

Note: * For European warranty Information, please visit www.optomaeurope.com
Due to different applications in each country, some regions may have edifferent accessories.

INTRODUCTION

Product Overview

Main Unit

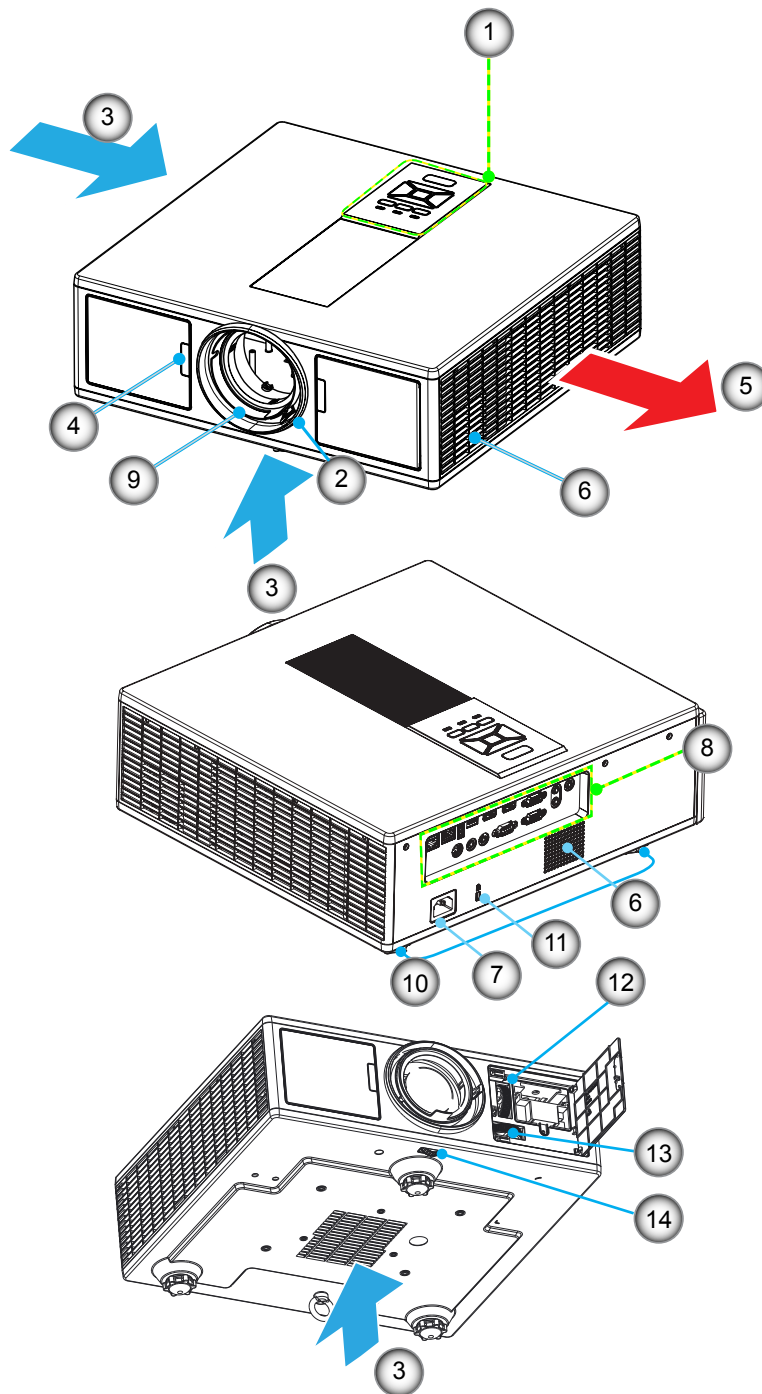

Note: Do not block projector inlet or outlet air vents.

| No | Item |
|----|----------------------|
| 1. | Keypad |
| 2. | Focus Ring |
| 3. | Ventilation (inlet) |
| 4. | IR Receiver |
| 5. | Ventilation (outlet) |
| 6. | Speakers |
| 7. | Power Socket |

| No | Item |
|-----|----------------------------|
| 8. | Input / Output Connections |
| 9. | Lens |
| 10. | Tilt-Adjustment Foot |
| 11. | Kensington Lock |
| 12. | Lens Shift (vertical) |
| 13. | Lens Shift (Horizontal) |
| 14. | Lens lock |

INTRODUCTION

Control Panel

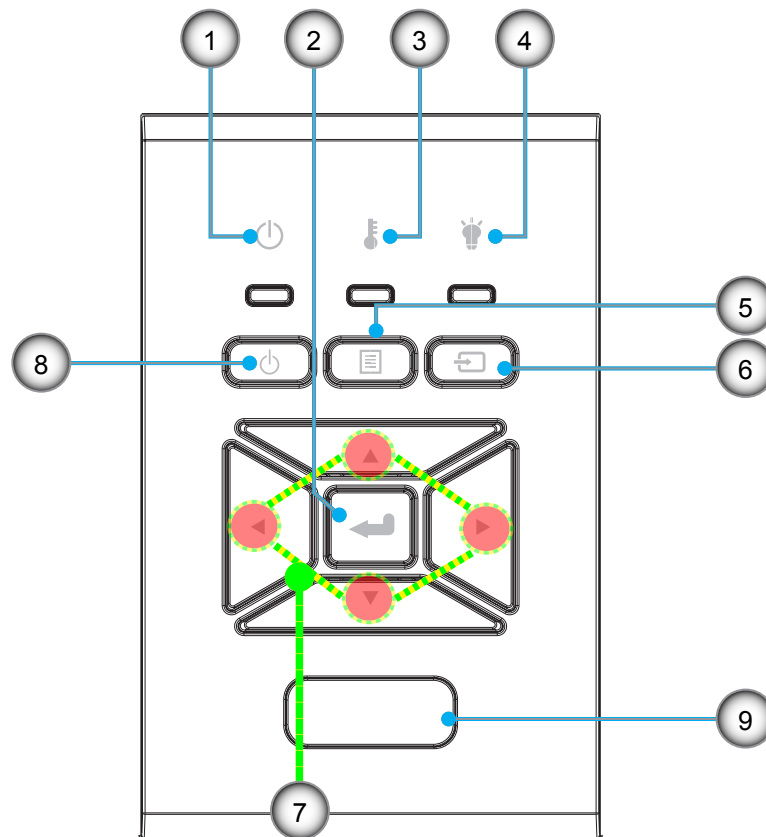

| No | Item |
|----|----------------|
| 1. | On/Standby LED |
| 2. | Enter |
| 3. | Temp LED |
| 4. | Lamp LED |
| 5. | Menu |

| No | Item |
|----|------------------------------|
| 6. | Source |
| 7. | Four Directional Select Keys |
| 8. | Power/Standby button |
| 9. | IR Receiver |

INTRODUCTION

Connections

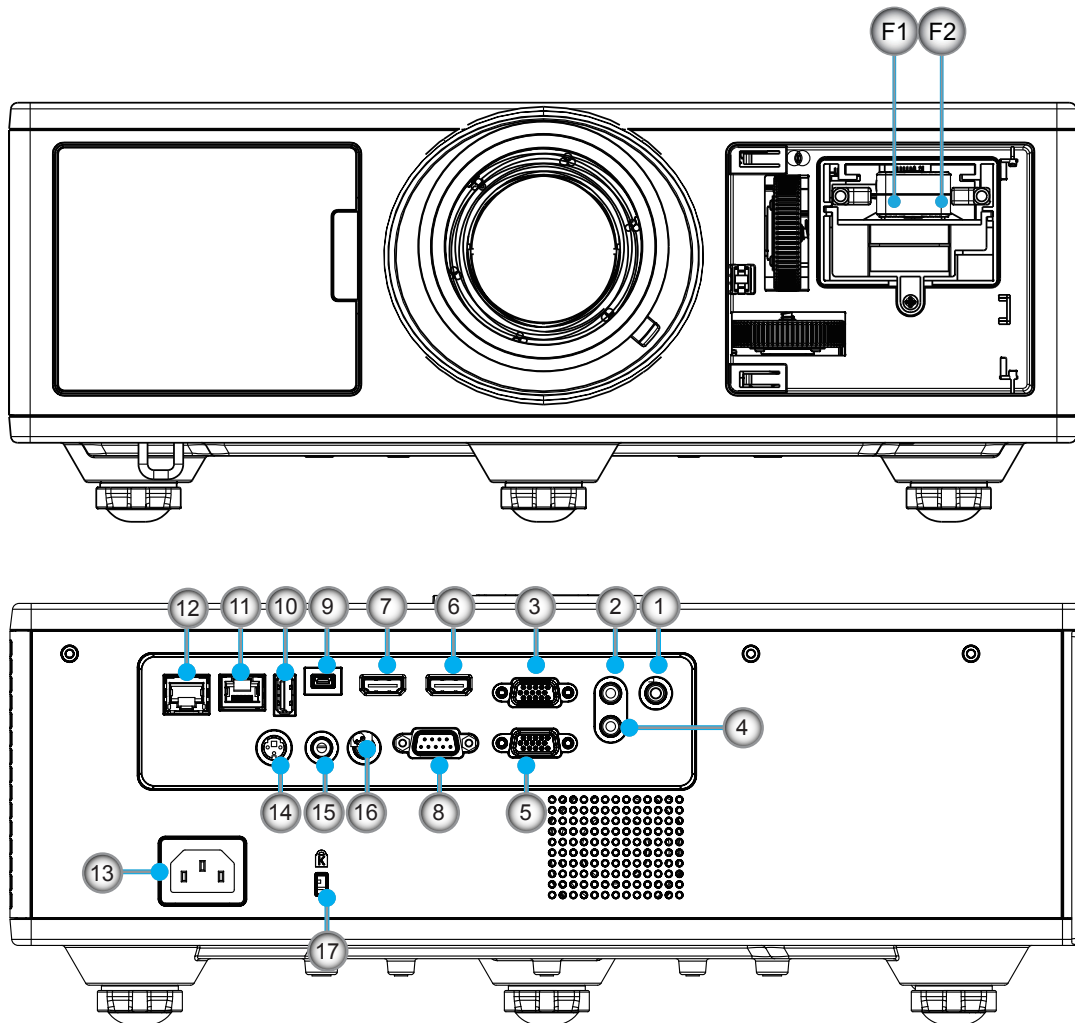

| No | Item |
|-----|--------------------------------------|
| 1. | Microphone connector |
| 2. | Audio In connector |
| 3. | VGA In/ YPbPr connector |
| 4. | Audio Out connector |
| 5. | VGA Out connector |
| 6. | HDMI 1connector |
| 7. | HDMI 2/MHL connector |
| 8. | RS232C connector |
| 9. | USB-B mini connector |
| 10. | USB Power Out (5V ---1.5A) Connector |

| No | Item |
|-----|--|
| 11. | HDBaseT connector (Depending on Model) |
| 12. | RJ45 |
| 13. | Power Socket |
| 14. | 3D Sync Out (5V) connector |
| 15. | Wired Remote connector |
| 16. | 12V Trigger connector |
| 17. | Kensington Lock |
| F1 | HDMI3/MHL Connector |
| F2 | USB Power |

INTRODUCTION

Remote Control

| No | Item |
|-----|--|
| 1. | Power On Power on the projector. |
| 2. | Geometric Correction Launch the Geometric Correction menu. |
| 3. | F1:Test pattern Display a test pattern. |
| 4. | Display Mode Select the display mode. |
| 5. | Four directional select keys To select items or make adjustments. |
| 6. | Information Display the projector information. |
| 7. | F3:Color Matching Launch the Color Matching setting menu. |
| 8. | Input source selection Select an input signal. |
| 9. | Menu Launch the OSD menu. To exit OSD, Press "Menu" again. |
| 10. | Volume Control -/+ Increase/decrease the volume. |
| 11. | Freeze Freeze the projected image. |
| 12. | Format Choose the projector format. |
| 13. | VGA Switch to VGA source. |
| 14. | HDMI1 Switch to HDMI1 source. |
| 15. | HDBaseT (Depending on Model) Switch to HDBaseT source. |
| 16. | 3D Switch to 3D source. |
| 17. | Power Off Power off the projector. |
| 18. | PIP/PBP Menu Launch the PIP/PBP menu. |
| 19. | F2:LAN Settings Launch the LAN Setting Menu. |

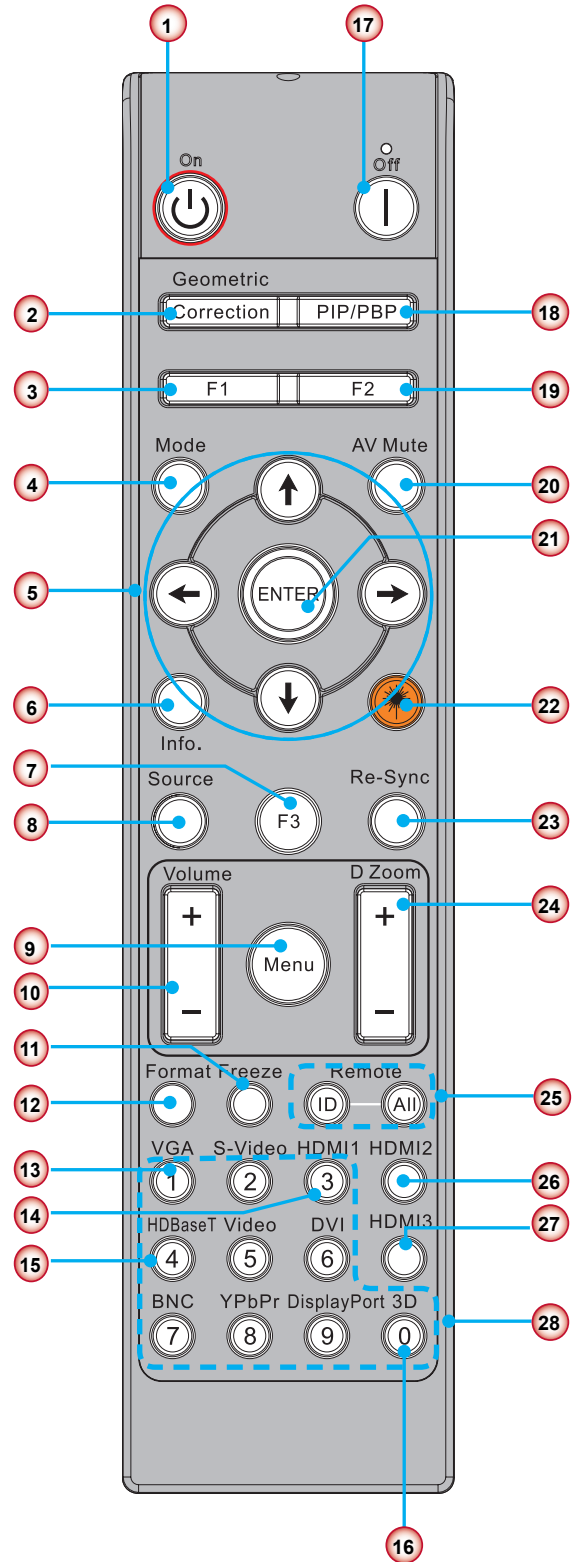

Note: Some keys may have no function for models that do not support these features. I/O availability will vary depending upon model and or SKU purchased.

INTRODUCTION

| No | Item |
|-----|---|
| 20. | AV Mute Momentarily turns off/on the audio and video. |
| 21. | Enter Confirm your item selection. |
| 22. | Laser Use as laser pointer. |
| 23. | Re-Sync Automatically synchronize the projector to the input source. |
| 24. | Digital Room +/- Zoom in/out the projected image. |
| 25. | Remote ID / Remote all Set the remote control ID. |
| 26. | HDMI2 Switch to HDMI2 source. |
| 27. | HDMI3 (Dongle) Switch to HDMI3(Dongle) source. |
| 28. | Number Keypad (0~9) Use as numeric keypad number "0~9". |

SETUP AND INSTALLATION

Connecting Source to the Projector Connect to Computer/Notebook

Note:

Due to the difference in applications for each country, some regions may have different accessories.
(*) Optional accessory

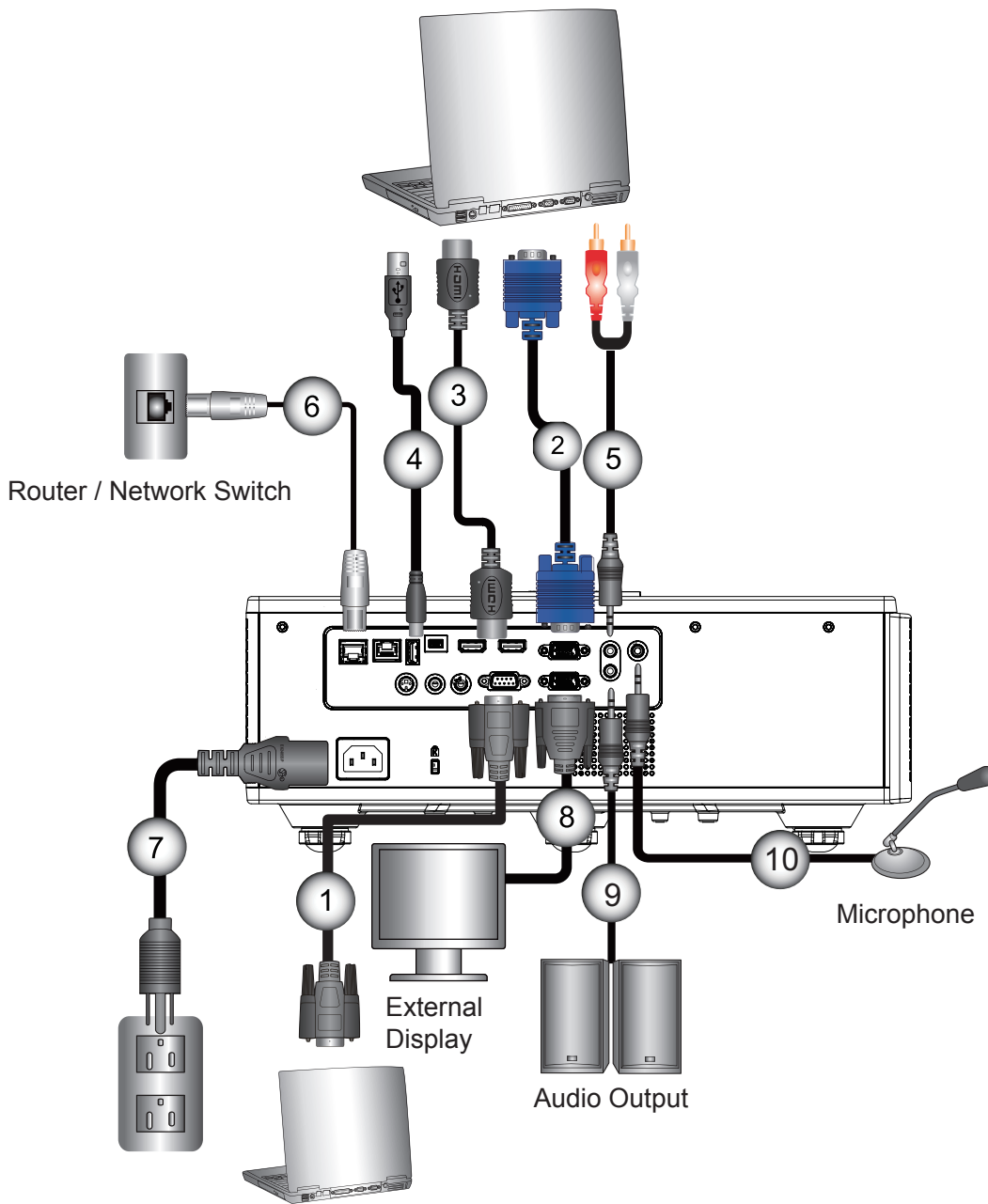

| No | Item |
|----|----------------|
| 1. | RS232 Cable |
| 2. | VGA Cable |
| 3. | HDMI Cable |
| 4. | USB Cable |
| 5. | Audio In Cable |

| No | Item |
|-----|------------------|
| 6. | RJ45 Cable |
| 7. | Power Code |
| 8. | VGA Out Cable |
| 9. | Audio Out Cable |
| 10. | Microphone cable |

SETUP AND INSTALLATION

Connect to Video Sources

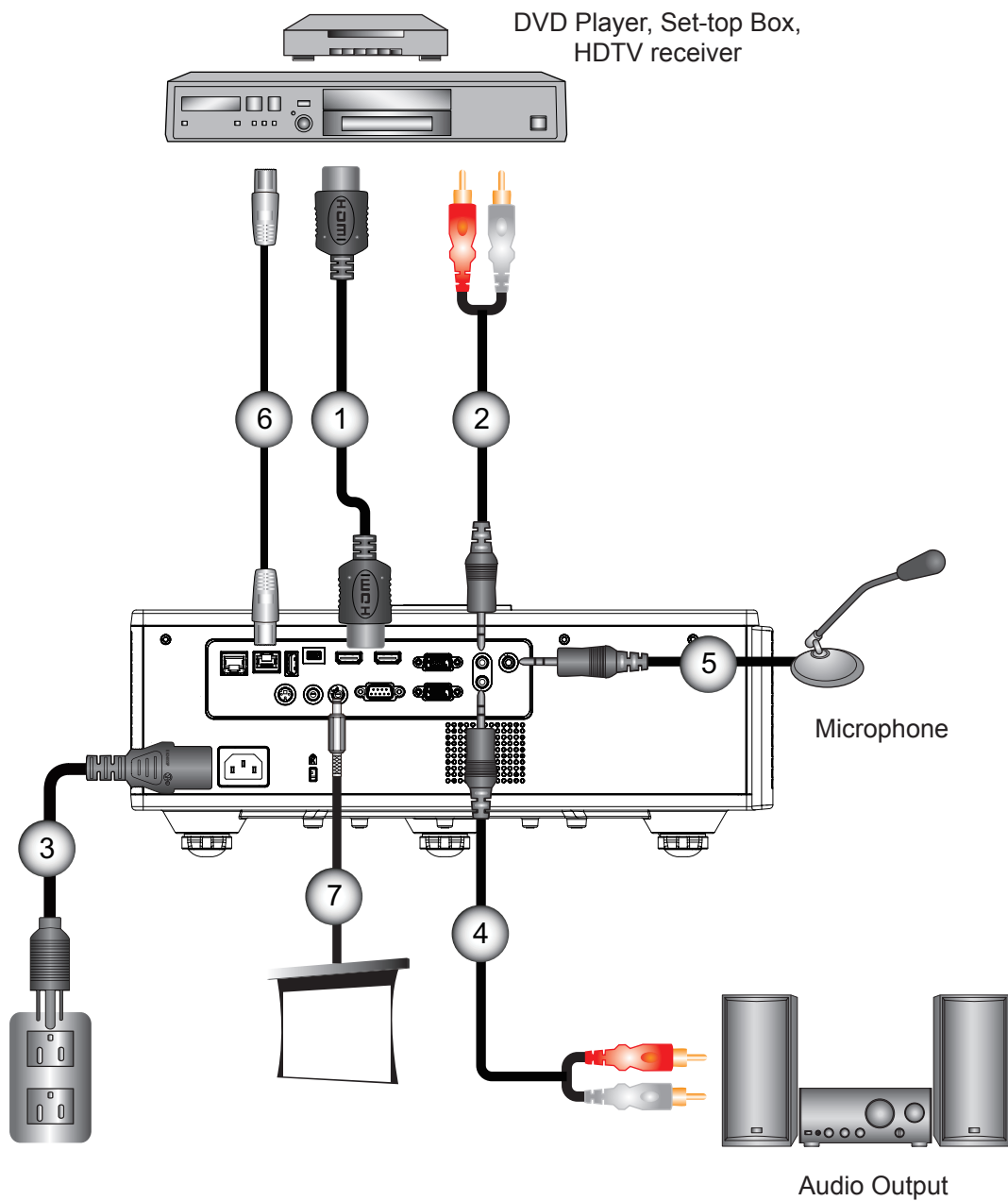

| No | Item |
|----|-----------------|
| 1. | HDMI Cable |
| 2. | Audio In Cable |
| 3. | Power Code |
| 4. | Audio Out Cable |

| No | Item |
|----|--------------------------|
| 5. | Microphone cable |
| 6. | RJ-45 cable (Cat5 cable) |
| 7. | 12V DC Jack |
| 8. | HDMI3/MHL cable |

Note:

Due to the difference in applications for each country, some regions may have different accessories.
(*) Optional accessory

SETUP AND INSTALLATION

Powering the Projector On/Off

Powering On the Projector

1. Securely connect the power cord and signal cable. When connected, the POWER/STANDBY LED will turn Red.
2. Turn on the lamp by pressing the “⏻” button either on the projector or on the remote. At this moment, the POWER/STANDBY LED will now turn Blue. ①

The startup screen will display in approximately 6 seconds.

3. Turn on and connect the source that you want to display on the screen (computer, notebook, video player, etc). The projector will detect the source automatically.
 - ▶ If you connect multiple sources at the same time, press the “INPUT” button on the control panel to switch between inputs.

Note: When the power mode is in standby mode (power consumption < 0.5W), the VGA output/Wire remote/LAN will be deactivated when the projector is in standby. Audio out loop-through is always active in standby mode. HDBaseT control is always deactivated in standby mode.

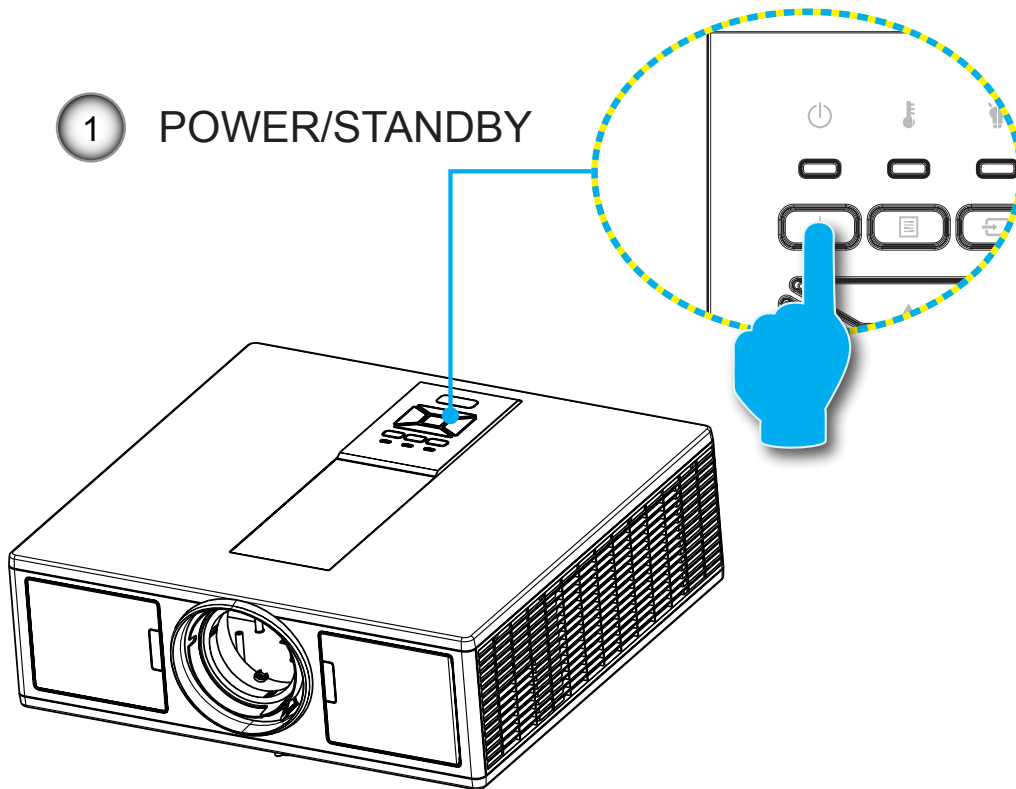

Note: Turn on the projector first and then select the signal sources.

SETUP AND INSTALLATION

Powering Off the Projector

1. Press the “⏻” button on the remote control or on the control panel to turn off the projector. The following message will be displayed on the screen.

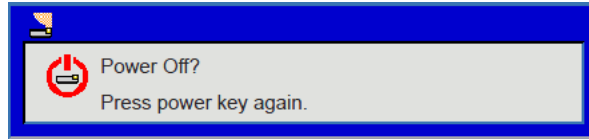

Press the “⏻” button again to confirm otherwise the message will disappear after 10 seconds. When you press the “⏻” button for the second time, the fan will start cooling the system and will shut down.

2. The cooling fans continue to operate for about 4 seconds for cooling cycle and the POWER/STANDBY LED will flash Red. When the POWER/STANDBY LED lights solid Red, the projector has entered standby mode. If you wish to turn the projector back on, you must wait until the projector has completed the cooling cycle and has entered standby mode. Once in standby mode, simply press “⏻” button to restart the projector.
3. Disconnect the power cord from the electrical outlet and the projector.

Warning Indicator

LED lightning messages

When the warning indicators (see below) come on, the projector will automatically shutdown:

- ❖ “LAMP” LED indicator is lit red and/or if “TEMP” LED indicator is lit red.
- ❖ “TEMP” LED indicator is lit red, this indicates the projector has overheated. Under normal conditions, the projector can be switched back on.
- ❖ “TEMP” LED indicator flashes red.

Unplug the power cord from the projector, wait for 30 seconds and try again. If the warning indicator light up again, please contact your nearest service center for assistance.

| Message | ⏻ Power LED | | 🔑 Temp LED | 💡 Lamp LED |
|-------------------------|----------------|------|---------------|---------------|
| | Red | Blue | Red | Red |
| Standby State (LAN Off) | On | | | |
| Standby State (LAN On) | On | On | | |
| Power On | | On | | |
| Warning Up | Flashing | | | |
| Error(PowerGood NG) | | | On | On |
| Error (Fan fail) | | | Flashing | |
| Error (Over Temp) | | | On | |
| Error (LD fail) | | | | On |

SETUP AND INSTALLATION

Adjusting the Projected Image

Adjusting the Projector's Height

The projector is equipped with elevator feet for adjusting the image height.

1. Locate the adjustable foot you wish to modify on the underside of the projector.
2. Rotate the adjustable ring clockwise to raise the projector or counter clockwise to lower it. Repeat with the remaining feet as needed.

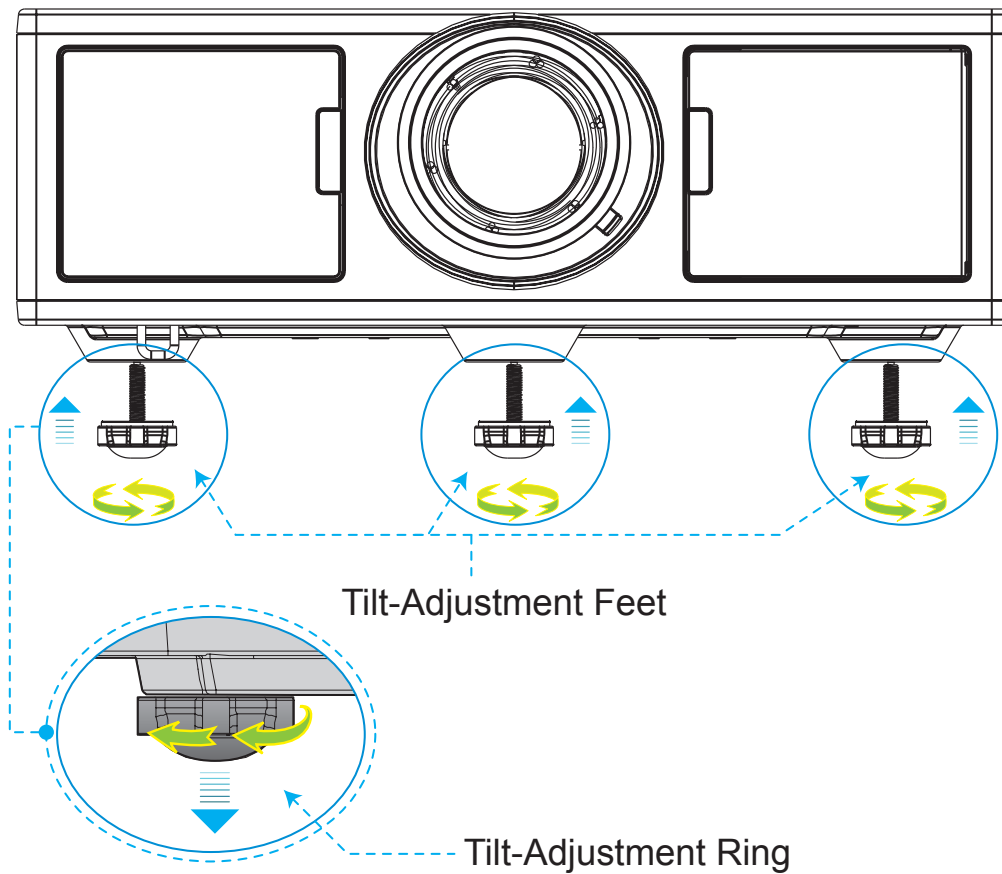

SETUP AND INSTALLATION

Adjusting Projector Focus and Zoom

1. To adjust the image size, turn the zoom ring clockwise or anticlockwise to increase or decrease the projected image size.
2. To adjust the focus, turn the focus ring clockwise or anticlockwise until the image is sharp and legible. The projector will focus at distances (lens to wall) from 4.27 ~ 25.59 feet (1.3-7.8 meters).

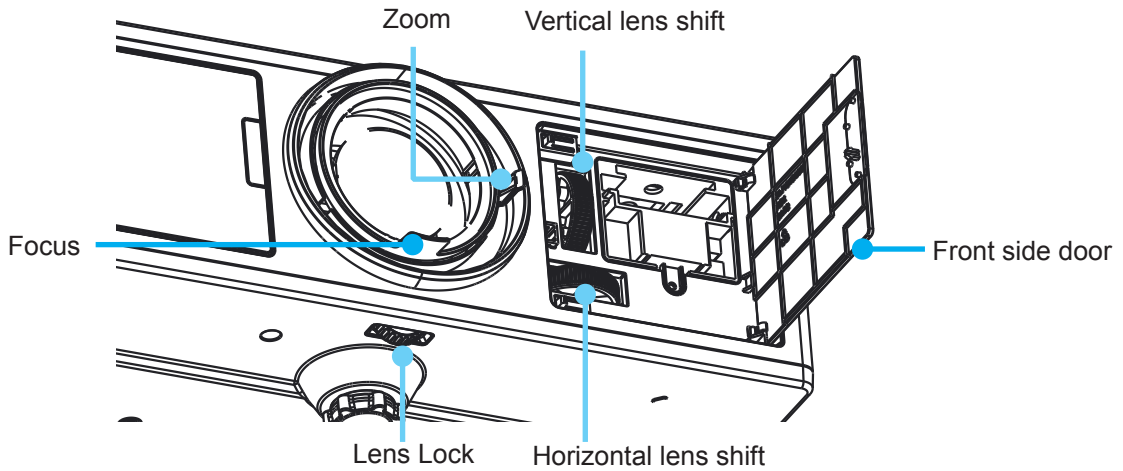

Adjusting Projection Image Size (Diagonal)

Projection Image Size from 36" to 300" (1.09~9.09 meters).

1. Open the front side door of the projector.
2. Unlock the lens lock, before adjust the lens shift.
3. Turn the vertical/horizontal lens shift knob to shift the lens
4. Turn the lens lock clockwise to lock the lens in place (Lens shift knob still can be rotated.)
5. Close the front side door of the projector.

Note: The stroke for lens shift is designed to be regular triangle, when lens are adjusted to central position horizontally, lens can be vertically shifted to the highest point

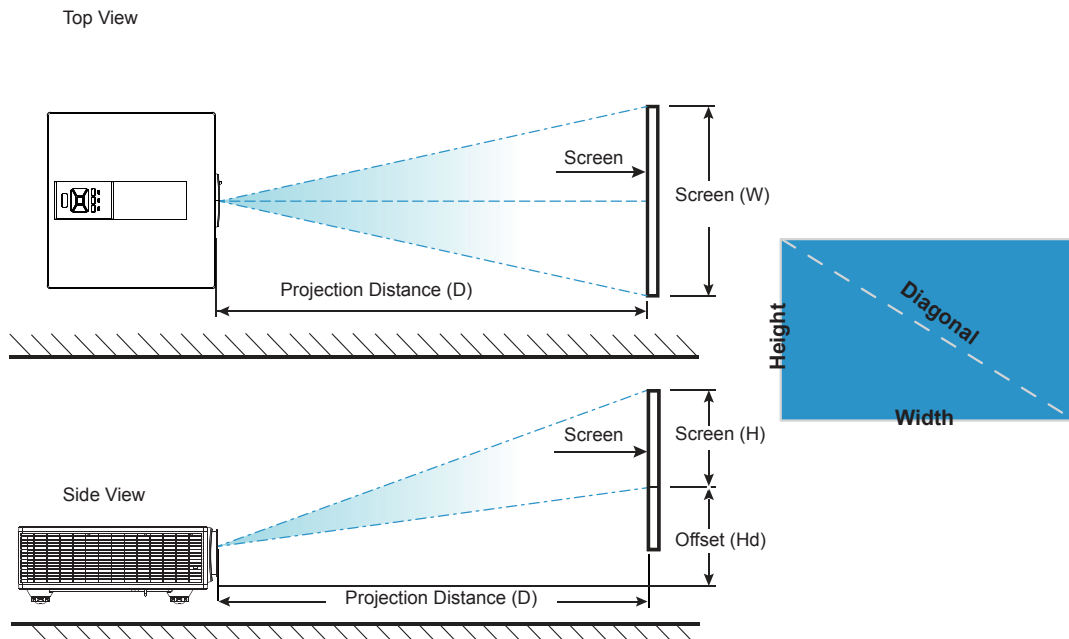

SETUP AND INSTALLATION

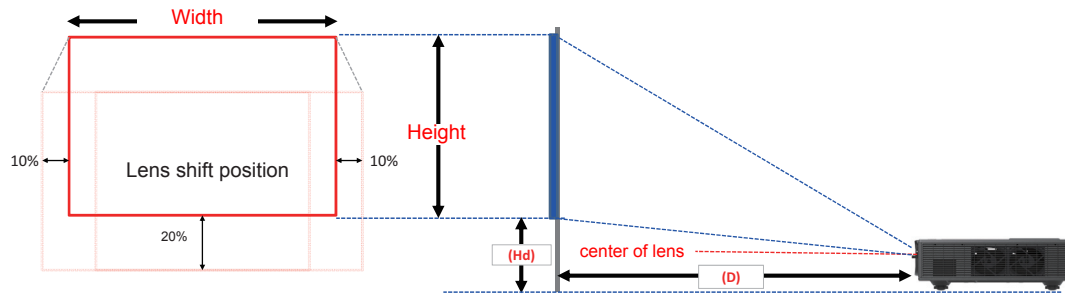









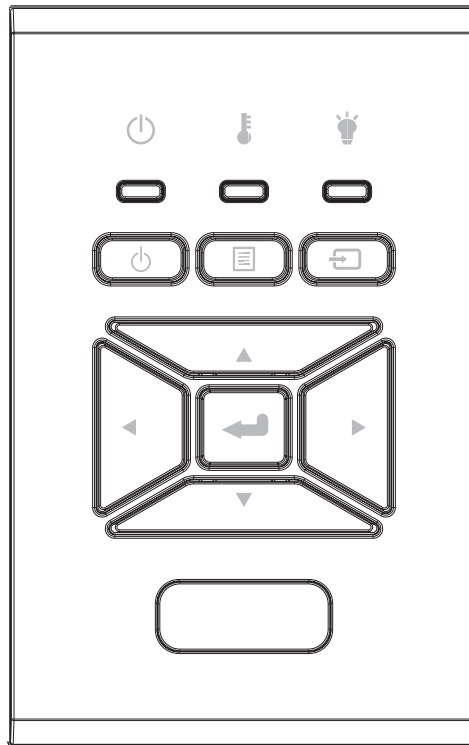



| Image Offset | | | | | | | | | | | | | |
|--------------------|------------|-----------------|--------|-------|--------|-------------------------|-------|-------|-------|-------------|------|------|------|
| | image size | Screen Size WxH | | | | Projection Distance (D) | | | | Offset (Hd) | | | |
| | inch | cm | | inch | | cm | | inch | | cm | | inch | |
| | Diagonal | Width | Height | Width | Height | Wide | Tele | Wide | Tele | Wide | Tele | Wide | Tele |
| WUXGA 16:10 | 36" | 78.0 | 49.0 | 30.7 | 19.3 | NA | 170.0 | NA | 66.9 | 20.1 | 20.1 | 7.9 | 7.9 |
| | 100" | 215.0 | 135.0 | 84.6 | 53.1 | 260.0 | 460.0 | 102.4 | 181.1 | 37.4 | 37.4 | 14.7 | 14.7 |
| | 150" | 323.0 | 202.0 | 127.2 | 79.5 | 390.0 | 690.0 | 153.5 | 271.7 | 50.8 | 50.8 | 20.0 | 20.0 |
| | 200" | 431.0 | 269.0 | 169.7 | 105.9 | 520.0 | 920.0 | 204.7 | 362.2 | 64.3 | 64.3 | 25.3 | 25.3 |
| | 250" | 539.0 | 337.0 | 212.2 | 132.7 | 640.0 | NA | 252.0 | NA | 77.8 | 77.8 | 30.6 | 30.6 |
| | 300" | 646.0 | 404.0 | 254.3 | 159.1 | 770.0 | NA | 303.1 | NA | 91.2 | 91.2 | 35.9 | 35.9 |

❖ This table is for user's reference only.

USER CONTROLS

Using the Control Panel



| Name | Description |
|--|--|
| POWER  | Refer to the “Power On/Off the Projector” section on pages 16-17. |
| Enter  | Confirm a selected item. |
| INPUT  | Select an input signal |
| MENU  | Launch the on-screen display (OSD) menu. To exit OSD, press “MENU” again. |
| Four Directional Select Keys | Use     to select items or make adjustments to your selection. |
| LAMP LED  | Refer to the LED indicator of the projector light source status. |
| TEMP LED  | Refer to the LED indicator of the projector temperature status. |
| ON/STANDBY LED  | Refer to the LED indicator of the projector power status. |

USER CONTROLS

On-screen Display Menus

The Projector has multilingual On-screen Display menus that allow you to make image adjustments and change a variety of settings.

How to operate

1. To open the OSD menu, press “Menu” on the Remote Control or Projector Keypad.
2. When OSD is displayed, use ▲▼ keys to select any item in the main menu. While making a selection on a particular page, press the ► or “Enter” key to enter sub menu.
3. Use the ▲▼ keys to select the desired item and adjust the settings using the ◀▶ key.
4. Select the next item to be adjusted in the sub menu and adjust as described above.
5. Press “Enter” to confirm.
6. To exit, press “Menu” again. The OSD menu will close and the projector will automatically save the new settings.

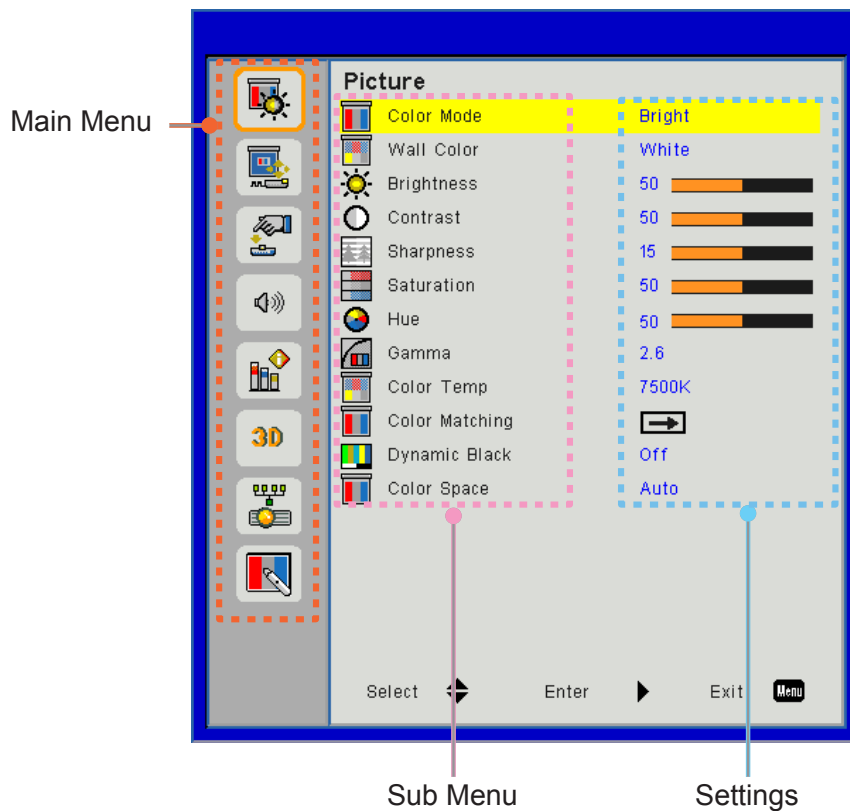

USER CONTROLS

Structure

Note: Please note that the on-screen display (OSD) menus vary according to the signal type selected and the projector model you are using.

| Main Menu | Sub Menu | Setting | |
|-----------|----------------------|--|---|
| Picture | Color Mode | Bright/Presentation/Movie/sRGB/Blending/DICOM SIM./User (Change Color Mode to User Mode if customer changes the settings) | |
| | Wall Color | White/ Light Yellow/ Light Blue/ Pink/ Dark Green | |
| | Brightness | | |
| | Contrast | | |
| | Sharpness | | |
| | Saturation | (For VGA component signal only) | |
| | Hue | (VGA component signal only) | |
| | Gamma | Film/Graphics/1.8/2.0/2.2/2.6/Blackboard/DICOM SIM | |
| | Color Temp | 5500K/6500K/7500K/8500K/9500K | |
| | Color Matching | White/Red/ Green/Blue/Cyan/ Magenta/Yellow Hue/ Saturation /Gain | |
| | Dynamic Black | On / Off | |
| | Color Space | Not HDMI Input: Auto/RGB/YUV HDMI Input: Auto/RGB(0~255)/RGB(16~235)/YUV | |
| Screen | Aspect Ratio | Auto/4:3/16:9/16:10 | |
| | Phase | | |
| | Clock | | |
| | H.Position | | |
| | V.Position | | |
| | Digital Zoom | | |
| | Projection | Front/Front Ceiling/Rear/Rear Ceiling | |
| | Geometric Correction | V. Keystone | |
| | | H. Keystone | |
| | | 4 Corners | On/Off |
| | | Grid Color | Purple/Green |
| | | Reset | Yes/No |
| | PIP-PBP Settings | Function | PBP/PIP/ Off |
| | | Main Source | VGA/HDMI-1/HDMI-2/Dongle/HDBaseT |
| | | Sub Source | VGA/HDMI-1/HDMI-2/Dongle/HDBaseT |
| | | Location | Top Left/Top Right/Bottom Left/Bottom Right |
| | | Size | Small/Medium/Large |
| Swap | | | |

USER CONTROLS

| Main Menu | Sub Menu | Setting |
|-----------|-------------------|--|
| Settings | Language | English/German/French/Italian/Spanish/Polish/Swedish/Dutch/Portugese/Japanese/Traditional Chinese/ Simplified Chinese /Korean/Russian/Arabic/Norsk/Turkish/Danish/Finnish/Greek/Hungarian/Czech/Romania/Thai/Farsi/Vietnam /Indonesian/Slovakian |
| | Menu Location | Left Top, Right Top, Center, Left Bottom, Right Bottom |
| | VGA OUT (Standby) | Off/On |
| | LAN (Standby) | Off/On |
| | Test Pattern | None / Grid / White |
| | Direct Power On | On/Off |
| | Reset to Default | Yes/No |
| Volume | Speaker | On/Off |
| | Audio Out | On/Off |
| | Microphone | On/Off |
| | Mute | On/Off |
| | Volume | |
| | Microphone Volume | |
| | EQ | |

USER CONTROLS

| Main Menu | Sub Menu | Setting | | |
|-----------|--------------------------|---------------------------|--------------------------------------|-----------------------------------|
| Options | Logo | | Default/User | |
| | Logo Capture | | | |
| | Auto Source | | On/Off | |
| | Input | | VGA, HDMI-1, HDMI-2, Dongle, HDBaseT | |
| | Auto Power Off (Min.) | | | |
| | Sleep Timer (Min.) | | | |
| | SSI Settings | | | SSI Hours Used (Normal) |
| | | | | SSI Hours Used (ECO) |
| | | SSI Power Mode | | Normal,ECO |
| | High Altitude | On/Off | | [Default Off] |
| | Optional Filter Settings | Optional Filter Installed | | Yes/No |
| | | Filter Usage Hours | | Read-Only |
| | | Filter Reminder | | |
| | | Cleaning Up Reminder | | Yes/No |
| | Security | Security | | On / Off |
| | | Security Timer | | Month / Day / Hour |
| | | Change Password | | |
| | Remote Settings | IR Function | | On / Off |
| | | Remote Code | | 00 ~ 99 |
| | HDBaseT Control | Auto | | |
| | | HDBaseT | | |
| | PIP-PBP Module | | | Version |
| | | | | HDMI EQ |
| | | | | Reset |
| | | | | USB Upgrade |
| | Information Hide | On / Off | | |
| | Information | | | Model Name |
| | | | | SNID |
| | | | | Source (Main Source / Sub Source) |
| | | | | Main Source Resolution |
| | | | | Sub Source Resolution |
| | | | | SW Version (DDP/MCU/LAN) |
| | | | Aspect Ratio | |
| | | | SSI Hours (Normal/Eco) | |
| | | | IP Address | |
| | | | Network Status | |
| | | | Remote Code | |
| | | | Remote Code (Active) | |

USER CONTROLS

| Main Menu | Sub Menu | Setting | | |
|------------|----------------|---------|------------------|---------------------|
| 3D | 3D | | Auto/On | |
| | 3D Invert | | On/Off | |
| | 3D Format | | | Frame Packing |
| | | | | Side-by-Side (Half) |
| | | | | Top and Bottom |
| | | | | Frame Sequential |
| | | | Field Sequential | |
| 1080p @ 24 | | | 96Hz/144Hz | |
| Network | Status | | | |
| | DHCP Client | | On/Off | |
| | IP Address | | | |
| | Subnet Mask | | | |
| | Gateway | | | |
| | DNS | | | |
| | Store | | | |
| | MAC Address | | | |
| | Group Name | | | |
| | Projector Name | | | |
| | Location | | | |
| | Contact | | | |

USER CONTROLS

Picture

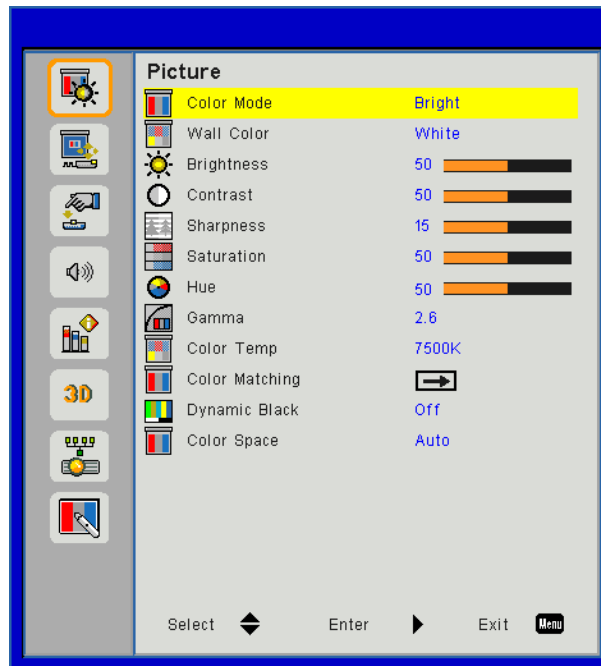

Color Mode

There are many factory presets optimized for various types of images. Use the ◀ or ▶ button to select the item.

- Bright: For brightness optimization.
- Presentation: For meeting presentation.
- Movie: For playing video content.
- sRGB: For game content.
- Blending: For blending application.
- DICOM Sim:
- User: Memorize user's settings.

Wall Color

Use this function to obtain an optimized screen image according to the wall color. You can select from "White", "Light Yellow", "Light Blue", "Pink", and "Dark Green".

Brightness

Adjust the brightness of the image.

- Press the ◀ button to darken image.
- Press the ▶ button to brighten image.

Contrast

The Contrast controls the difference between the lightest and darkest parts of the picture. Adjusting the contrast changes the amount of black and white in the image.

- Press the ◀ button to decrease the contrast.
- Press the ▶ button to increase the contrast.

Sharpness

Adjust the sharpness of the image.

- Press the ◀ button to decrease the sharpness.
- Press the ▶ button to increase the sharpness.

Note: "Sharpness", "Sat-uration" and "Hue" functions are only supported under video mode.

USER CONTROLS

Saturation

Adjust a video image from black and white to fully saturated color.

- Press the ◀ button to decrease the amount of saturation in the image.
- Press the ▶ button to increase the amount of saturation in the image.

Hue

Adjust the color balance of red and green.

- Press the ◀ button to increase the amount of green in the image.
- Press the ▶ button to increase the amount of red in the image.

Gamma

This allows you to adjust the gamma value to obtain the better image contrast for the input.

Color Temp

This allows you to adjust the color temperature. At higher temperature, the screen looks colder; at lower temperature, the screen looks warmer.

Color Maching

Use these settings for advanced adjustment of the individual Red, Green, Blue, Cyan, Magenta and Yellow and White Colors.

Dynamic Black

Use this function to increase the contrast ratio.

Color Space

Select an appropriate color matrix type from AUTO, RGB, RGB(0-255), RGB(16-235) or YUV.

Note: "RGB (0-255)" and "RGB (16-235)" are only supported for HDMI source.

USER CONTROLS

Screen

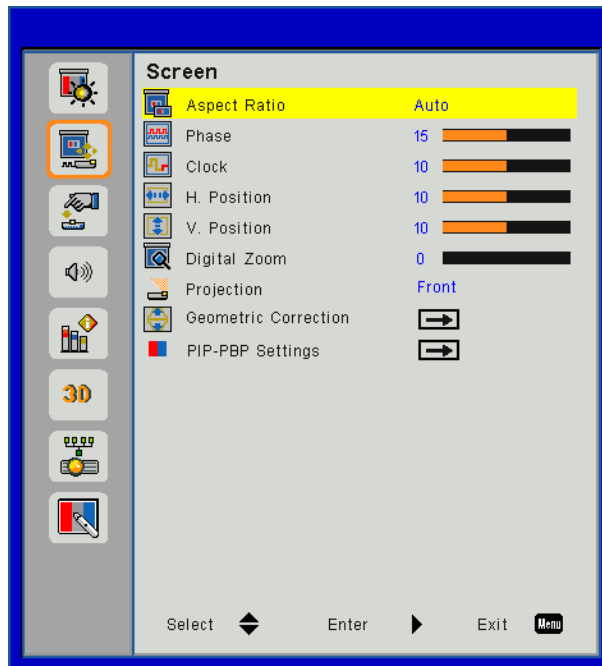

Aspect Ratio

- Auto: Keep the image with original width-height ratio and maximize the image to fit native horizontal or vertical pixels.
- 4:3: The image will be scaled to fit the screen and displayed using a 4:3 ratio.
- 16:9: The image will be scaled to fit the width of the screen and the height adjusted to display the image using a 16:9 ratio.
- 16:10: The image will be scaled to fit the width of the screen and the height adjusted to display the image using a 16:10 ratio.

Phase

Synchronize the signal timing of the display with the graphic card. If the image appears to be unstable or flickers, use this function to correct it.

Note: *Phase, Clock, H. Position, V. Position adjustment only support VGA Graphic.*

Clock

Adjust to achieve an optimal image when there is a vertical flicker in the image.

H. Position

- Press the ◀ button to move the image left.
- Press the ▶ button to move the image right.

V. Position

- Press the ◀ button to move the image down.
- Press the ▶ button to move the image up.

Digital Zoom

- Press the ◀ button to reduce the size of an image.
- Press the ▶ button to magnify an image on the projection screen.

USER CONTROLS

Projection

- Front: The image is projected straight on the screen.
- Front Ceiling: This is the default selection. When selected, the image will turn upside down.
- Rear: When selected, the image will appear reversed.
- Rear Ceiling: When selected, the image will appear reversed in upside down position.

Geometric Correction

- H Keystone
Press the ◀ or ▶ button to adjust image distortion horizontal. If the image looks trapezoidal, this option can help make the image rectangular.
- V Keystone
Press the ◀ or ▶ button to adjust image distortion vertically. If the image looks trapezoidal, this option can help make the image rectangular.
- 4 Corners
Adjust the image 4 corners pixel by pixel to make the image rectangular.
- Grid Color
Set 4 corners correction function grid color.
- Reset
Set H/V Keystone, 4 corners parameters to default values.

PIP-PBP Settings

- Function: To enable/disable PIP/PBP function.
- Main Source: To set PIP/PBP main source.
- Sub Source: To set PIP/PBP sub source.
- Location: To set PIP sub source location.
- Size: To set PIP sub source size.
- Swap: To swap PIP/PBP main/sub source.

Some source/signal combinations may not be compatible with PIP/PBP function. Please refer to the table below:

| Matrix | HDMI-1 | HDMI-2 | Dongle | HDBaseT | VGA |
|---------|--------|--------|--------|---------|-----|
| HDMI-1 | - | V | V | - | V |
| HDMI-2 | V | - | - | V | V |
| Dongle | V | - | - | V | V |
| HDBaseT | - | V | V | - | V |
| VGA | V | V | V | V | - |

1. Flashing lines may occur if the bandwidth of both inputs are too high, please try to reduce the resolution.
2. Frame tearing may occur due to a difference in frame rate between the Main and the Sub picture, please try to match the frame rate for each input.

USER CONTROLS

Settings

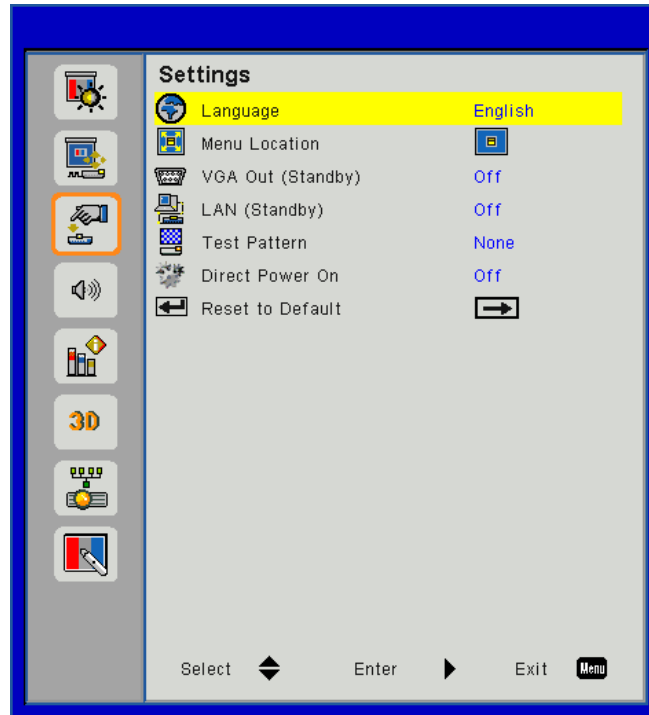

Language

Choose the multilingual OSD menu. Press the ◀ or ▶ button into the sub menu and then use the ▲ or ▼ button to select your preferred language. Press ▶ on the remote control to finalize the selection.



Menu Location

Choose the menu location on the display screen.

VGA Output (Standby)

Choose “On” to enable VGA OUT connection.

LAN (Standby)

Choose “On” to enable LAN connection. Choose “Off” to disable LAN connection.

Test Pattern

Display a test pattern.

Direct Power On

Choose “On” to activate Direct Power mode. The projector will automatically power on when AC power is supplied, without pressing the ⏻ key on the projector control panel or on the remote control.

Reset

Choose “Yes” to return the parameters on all menus to the factory default settings.

USER CONTROLS

Volume

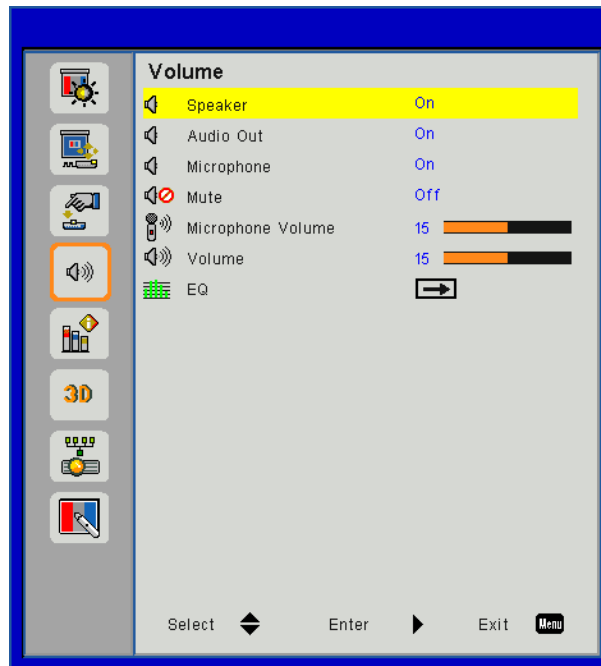

Speaker

- Choose “On” to enable the speaker.
- Choose “Off” to disable the speaker.

Line Out

- Choose “On” to enable the line out function.
- Choose “Off” to disable the line out function.

Microphone

- Choose “On” to enable the microphone.
- Choose “Off” to disable the microphone.

Mute

- Choose “On” to turn mute on.
- Choose “Off” to turn mute off.

Volume

- Press the ◀ button to decrease the volume.
- Press the ▶ button to increase the volume.

Microphone Volume

- Press the ◀ button to decrease the microphone volume.
- Press the ▶ button to increase the microphone volume.

EQ

Set audio EQ values.

USER CONTROLS

Options

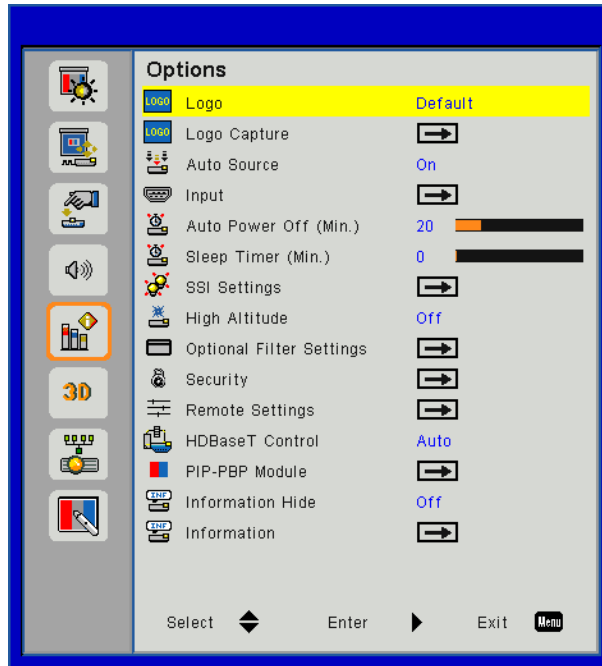

Logo

Use this function to set the desired startup screen. If changes are made they will take effect the next time the projector is powered on.

- Default: The default startup screen.
- User: Use stored picture from “Logo Capture” function.

Logo Capture

Press ► button to capture an image of the picture currently displayed on screen.

Note:

For successful logo capture, please ensure that the on-screen image does not exceed the projector’s native resolution.

“Logo Capture” is not available when 3D is enabled.

Before active this function, it is recommended that “Aspect Ratio” is set to the “Auto”.

Auto Source

- On: The projector will search for other signals if the current input signal is lost.
- Off: The projector will only search current input connection.

Input

Press ► button to enable/disable input sources. The projector will not search for inputs that are not selected.

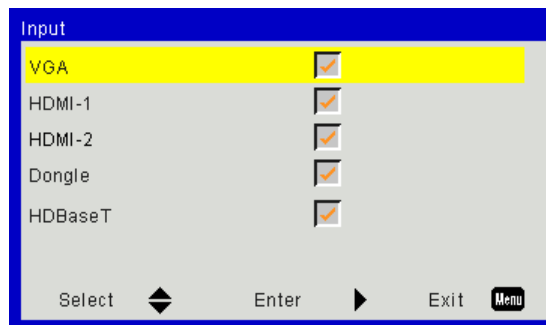

Auto Power Off (Min)

Sets the countdown timer interval. The countdown timer will start, when there is no signal being sent to the projector. The projector will automatically power off when the countdown has finished (in minutes).

USER CONTROLS

Sleep Timer

Sets the countdown timer. The countdown timer will start, with or without a signal being sent to the projector. The projector will automatically power off when the countdown has finished (in minutes).

SSI Settings

- SSI Hours Used (Normal)
Display the projection time of normal mode.
- SSI Hours Used (ECO)
Display the projection time of ECO mode.
- SSI Power Mode
Normal: Normal mode.
ECO: Use this function to dim the projector SSI which will lower power consumption and extend the SSI life.

High Altitude

- On: The built-in fans run at high speed. Select this option when using the projector at altitudes above 2500 feet/762 meters or higher.
- Off: The built-in fans automatically run at a variable speed according to the internal temperature.

Optional Filters Remind (Hour)

- Optional Filter Installed: Filter is installed or not.
- Filter Usage Hours: Hours of filter had been used.
- Filters Remind (Hour): Set the filter reminder time.
- Cleaning Up Remind: Select "Yes" to reset the dust filter hour counter after replacing or cleaning the dust filter.

Security

- Security: Choose "On" to use security verification when turning on projector. Choose "Off" to be able to switch on the projector without password verification.
- Security Timer
Use this function to set the how long (Month/Day/Hour) the projector can be used. Once this time has elapsed you will be requested to enter your password again.
- Change Password
First time:
 1. Press "←" to set the password.
 2. The password has to be 6 digits.
 3. Use number button on the remote to enter your new password and then press "←" key to confirm your password.Change Password:
 1. Press "←" to input old password.
 2. Use number button to enter current password and then press "←" to confirm.
 3. Enter new password (6 digits in length) using the number buttons on the remote, then press "←" to confirm.
 4. Enter new password again and press "←" to confirm.
- If the incorrect password is entered 3 times, the projector will automatically shut down.
- If you have forgotten your password, please contact the dealer for support.

USER CONTROLS

Note:

Password default value is "000000" (first time).

Always keep the password in your files. If the password is forgotten or lost, please contact your local authorized service center.

Remote Setting

- IR function: When this function is "Off", the projector cannot be operated by the remote control.
- Remote code: 00~99, default code (common code): 00

HDBaseT Control

- The projector will automatically detect the signal from HDBaseT transmitter supplied. Choose "HDBaseT" to activate Direct Power mode.
- When HDBaseT control is ON, 12v trigger output signal will always be ON, even if the projector is on Standby mode.

PIP-PBP Module

- Version: Show PIP-PBP module software version.
- Reset: Reset the PIP-PBP module.
- USB Upgrade: Upgrade the PIP-PBP module software.
- HDMI EQ: Set PIP-PBP module HDMI port EQ value.

Information Hide

- On: Choose "On" to hide the info message.
- Off: Choose "Off" to show the "info" message.

Information

Display the projector information for model name, SNID, source, resolution, software version, aspect ratio, SSI Hours, IP Address and Network Status on the screen.

Signal Power On & HDBaseT Standby

To access Signal Power On and HDBaseT Standby menu -- with projector on press the following buttons (in order): Power > Up >Down> Menu.

Signal Power On

- On: Choose "On" to enable Signal Power On.
- Off: Choose "Off" to disable Signal Power On.

HDBaseT Standby

- On: Choose "On" to enable HDBaseT Standby.
- Off: Choose "Off" to disable HDBaseT Standby.

USER CONTROLS

3D

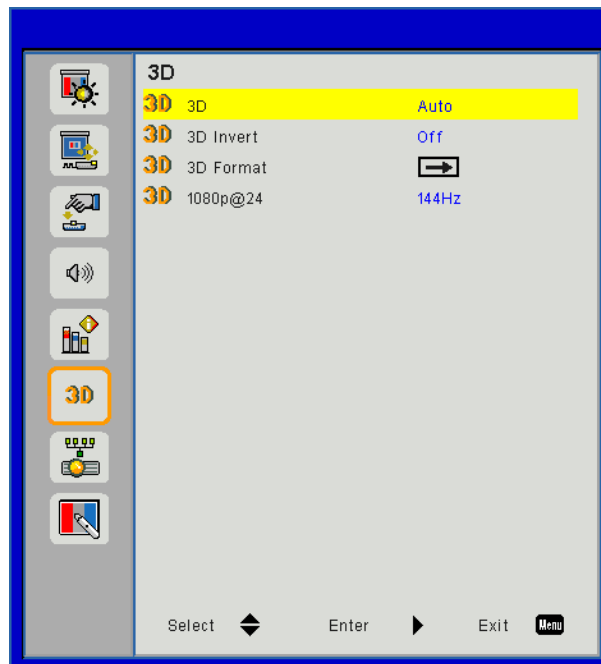

3D

Auto: When a HDMI 1.4a 3D timing identification signal is detected, the 3D image is selected automatically.

- Choose “On” to enable 3D function.
- Choose “Auto” to detected 3D signal automatically.

3D Invert

If you see a discrete or overlapping image while wearing DLP 3D glasses, you may need to execute “Invert” to get best match of left/right image sequence to get the correct image.

3D Format

Use this feature to select the 3D format. Options are: “Frame Packing”, “Side-by-Side (Half)”, “Top and Bottom”, “Frame Sequential”.

1080p@24

Use this feature to select 96 or 144Hz refresh rate as using 3D glasses in the 1080p @ 24 frame packing.

USER CONTROLS

LAN



Status

Display the network connection status.

DHCP

Configure the DHCP settings.

- On: Choose “On” to let the projector to obtain an IP address automatically from your network.
- Off: Choose “Off” to assign IP, Subnet Mask, Gateway, and DNS configuration manually.

IP Address

Display an IP address.

Subnet Mask

Display the subnet mask number.

Gateway

Display the default gateway of the network connected to the projector.

DNS

Display the DNS number.

MAC Address

Display the MAC address.

Group Name

Display the group name.

Projector Name

Display the projector name.

Location

Display the projector location.

Contact

Display the contact information.

APPENDICES

Projector Problems

? The projector stops responding to all controls

- ▶ If possible, turn off the projector, then unplug the power cord and wait at least 60 seconds before reconnecting power.
- ▶ Check that “Keypad Lock” is not activated by trying to control the projector with the remote control.

? If the remote control does not work

- ▶ Check if the operating angle of the remote control is within $\pm 30^\circ$ both horizontally and vertically on one of the IR receivers on the projector.
- ▶ Make sure there is no obstruction between the remote control and the projector. Move to within 12 m ($\pm 0^\circ$) of the projector.
- ▶ Make sure the batteries are inserted correctly.
- ▶ Replace batteries if they are exhausted.
- ▶ Ensure that you have set your remote to the correct IR code setting.

? When making a direct connection from your computer to the projector

- ▶ If you have network connection problem from your computer to the projector, please refer to the computer setting as below or contact with web administrator.

Step 1: Find an IP Address (192.168.0.100) from LAN function of projector.



Step 2: Select “Apply” and push the “Enter” button. Once the setting is saved, exit the OSD by pushing “Menu” button.

Step 3: To open Network Connections, click **Start**, click **Control Panel**, click **Network and Internet Connections**, and then click **Network Connections**. Click the connection you want to configure, and then, under **Network Tasks** , click **Change settings of this connection**.

Step 4: On the **General** tab, under **This connection use the following items**, click Internet Protocol(TCP/IP), and then click “**Properties**”.

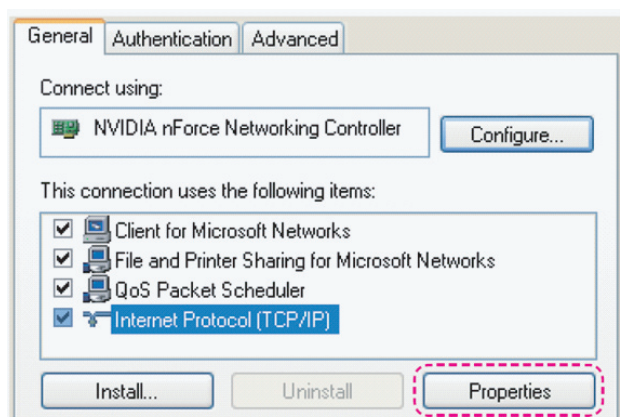

APPENDICES

Step 5: Click **Use the following IP address**, and type in as below:

- 1) IP address: 192.168.0.101
- 2) Subnet mask: 255.255.255.0
- 3) Default gateway: 192.168.0.254

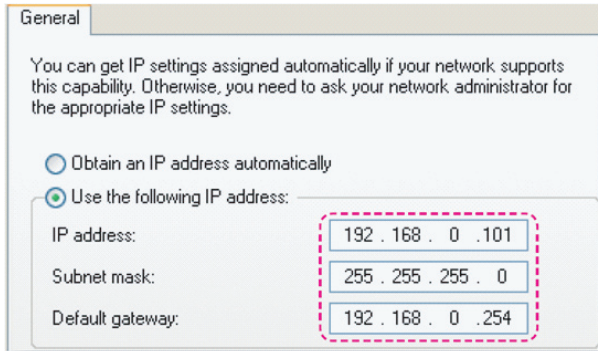

Step 6: To open Internet Options, click IE web browser, click Internet Options, click the **Connections** tab and click **“LAN Setting...”**.

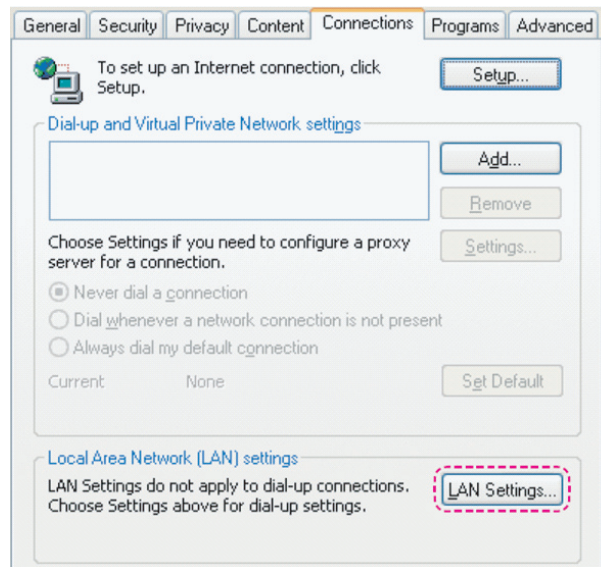

Step 7: All items in the **Local Area Network (LAN) Setting** window must unchecked. Then click **“OK”** button twice.

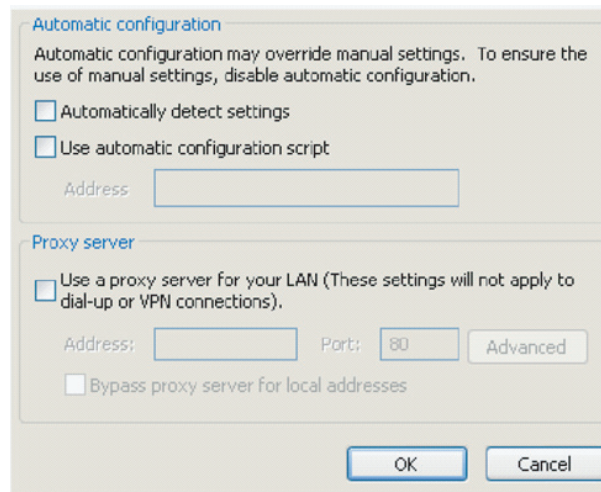

Step 8: Open your IE and type in the IP address of 192.168.0.100 in the URL then press **“Enter”** key.

APPENDICES

How to use web browser to control your projector

1. Turn on DHCP to allow a DHCP server to automatically assign an IP, or manually enter the required network information.

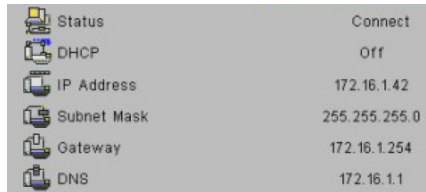

2. Then choose apply and press **OK** button to complete the configuration process.
3. Open your web browser and type in IP Address from the OSD LAN screen then the web page will display as below:



Note: When you used the projector IP address, you will can not link to your service server.

4. Based on network web-page for the input-string in [tools] tab, the limitation for Input-Length is in the below list (“space” and the other punctuation key included):

| Category | Item | Input-Length (characters) |
|-----------------------|-----------------|---------------------------|
| Crestron Control | IP Address | 15 |
| | IP ID | 2 |
| | Port | 5 |
| Projector | Projector Name | 10 |
| | Location | 9 |
| | Assigned To | 9 |
| Network Configuration | DHCP (Enabled) | (N/A) |
| | IP Address | 15 |
| | Subnet Mask | 15 |
| | Default Gateway | 15 |
| | DNS Server | 15 |
| User Password | Enabled | (N/A) |
| | New Password | 15 |
| | Confirm | 15 |
| Admin Password | Enabled | (N/A) |
| | New Password | 15 |
| | Confirm | 15 |

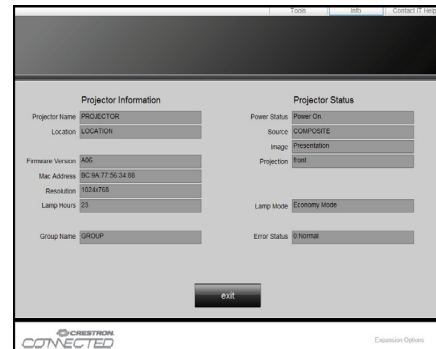

APPENDICES

Crestron RoomView Control Tool

Crestron RoomView™ provides a central monitoring station for 250+ control systems on a single Ethernet network (more are possible, the number depends on the combination of IP ID and IP address). Crestron RoomView monitors each projector, including projector's online status, system power, lamp life, network setting and hardware faults, plus any custom attribute as defined by the Administrator.

The Administrator can add, delete, or edit room information, contact information and events, which are logged automatically by the software for all users. (Operation UI as following image)

Note: Crestron RoomView function support is dependent on models.

When using RS232 or LAN control commands to power on the projector, there will be a feedback delay of 6 to 10 seconds.

1. Main Screen

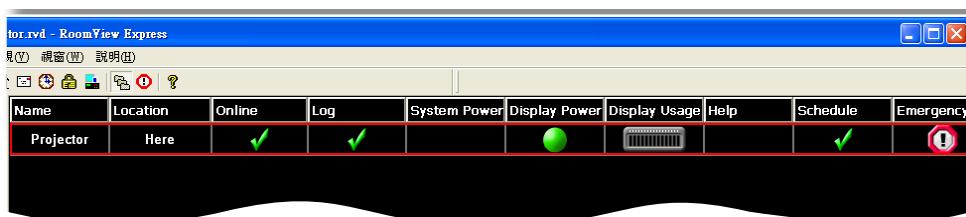

2. Edit Room

On the “Edit Room” page, enter the IP Address (or hostname) as shown on the projector's on-screen display (OSD) menu, and “02” for IPID, “41794” for the reserved Crestron control port.

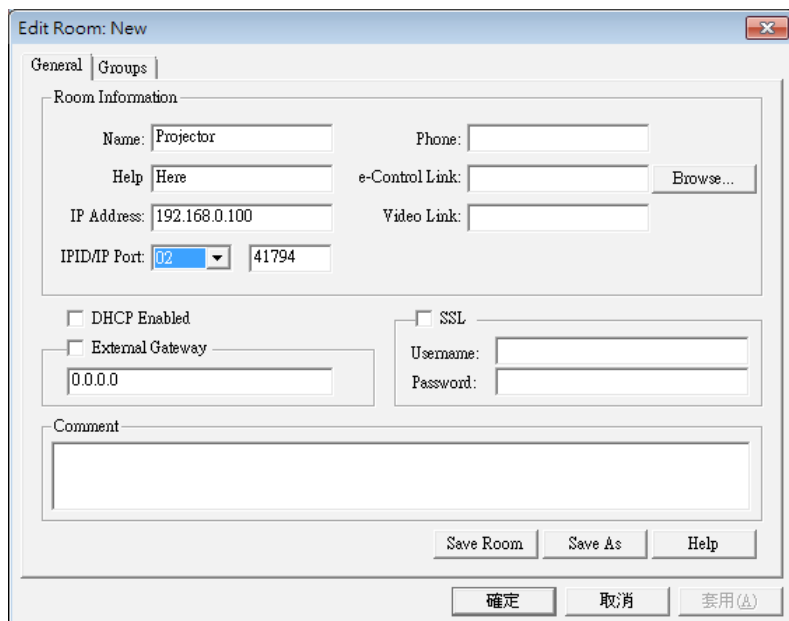

About Crestron RoomView™ setting and command method, please access below website to get RoomView™ User Guide and more information:
<http://www.crestron.com>

APPENDICES

3. Edit Attribute

Edit Attribute: New

General | Alert | Groups | Rooms | Contacts

Attribute Properties

Signal Name: Graphic: Off On

Device:

Signal Type:

Join Number: Default Max. Value:

Options

Apply attribute to all rooms Display on main view
 Apply attribute to all contacts Show on context menu
 Record attribute changes to log

4. Edit Event

Edit Event: Display Off

General | Rooms

Event Properties

Name: Enable this event
Type: Repeat event
Join:

Schedule

Start Date: Weekdays Weekends
End Date: Monday Saturday
Time: Tuesday Sunday
 Wednesday
 Thursday
 Friday

For more information, please visit
<http://www.crestron.com> & www.crestron.com/getroomview.

Network supports Crestron (Room View), AMX (Device Discovery) , PJLink and RS232 control.

APPENDICES

Installing and Cleaning the Optional Dust Filter

We recommend you clean the dust filter every 500 hours of operation, or more often if you are using the projector in a dusty environment.

When the warning message appears on the screen, do the following to clean the air filter:



Note:

The optional dust filter should be used in dusty environments.

If the dust filter is installed, a proper maintenance will prevent overheating and projector malfunction.

The dust filter is optional.

The specific interfaces are selected in terms of the specifications of types.

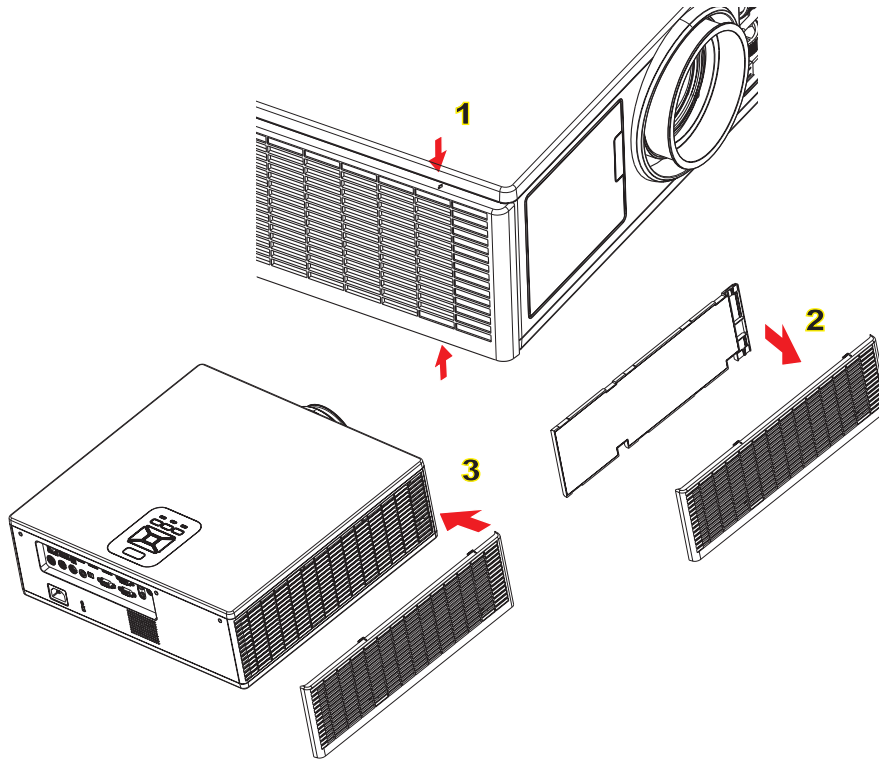

Air Filter Cleaning Procedure:

1. Switch off the power to the projector by pressing the "O" button.
2. Disconnect the power cord.
3. Pull out the dust filter, as shown in the illustration. ①
4. Carefully remove the dust filter. Then clean or change the filter. ②

To install the filter, reverse the previous steps.

5. Turn on the projector and reset the filter usage counter after the dust filter is replaced.

APPENDICES

Compatibility Modes

| A. VGA Analog | | | | | |
|--------------------------|-----------------------|------------------|-------------------|-----------------|--|
| (1) PC Signal | | | | | |
| Modes | Resolution | V.Frequency [Hz] | H.Frequency [KHz] | Pixel CLK [MHz] | EDID Description |
| VGA | 640x480 | 60 | 31.5 | 25.2 | Established Timings 1 |
| | 640x480 | 67 | 35.0 | 26.8 | Established Timings 1 |
| | 640x480 | 72 | 37.9 | 31.5 | Established Timings 1 |
| | 640x480 | 75 | 37.5 | 31.5 | Established Timings 1 |
| | 640x480 | 85 | 43.3 | 36.0 | |
| IBM | 720x400 | 70 | 31.5 | 28.3 | Established Timings 1 |
| SVGA | 800x600 | 56 | 35.1 | 36.0 | Established Timings 1 |
| | 800x600 | 60 | 37.9 | 40.0 | Established Timings 1 |
| | 800x600 | 72 | 48.1 | 50.0 | Established Timings 2 |
| | 800x600 | 75 | 46.9 | 49.5 | Established Timings 2 |
| | 800x600 | 85 | 53.7 | 56.3 | |
| Apple, Mac II | 832x624 | 75 | 49.1 | 57.3 | Established Timings 2 |
| XGA | 1024x768 | 60 | 48.4 | 65.0 | WXGA: Established Timings 2 XGA: Established Timings 2 and (Native)Detailed Timing / Descriptor Block 1 |
| | 1024x768 | 70 | 56.5 | 75.0 | Established Timings 2 |
| | 1024x768 | 75 | 60.0 | 78.8 | Established Timings 2 |
| | 1024x768 | 85 | 68.7 | 94.5 | |
| | 1024x768 | 120 | 99.0 | 137.8 | Standard Timing Identification |
| Apple, Mac II | 1152x870 | 75 | 68.7 | 100.0 | Manufacturer's Reserved Timing |
| SXGA | 1280x1024 | 60 | 64.0 | 108.0 | |
| | 1280x1024 | 72 | 77.0 | 133.0 | |
| | 1280x1024 | 75 | 80.0 | 135.0 | Established Timings 2 |
| QuadVGA | 1280x960 | 60 | 60.0 | 101.3 | Standard Timing Identification |
| | 1280x960 | 75 | 75.2 | 130.0 | |
| SXGA+ | 1400x1050 | 60 | 65.3 | 121.8 | |
| UXGA | 1600x1200 | 60 | 75.0 | 161.0 | Standard Timing Identification |
| Full HD | 1920x1080 | 60 | 67.5 | 148.5 | |
| WUXGA | 1920x1200 | 60 | 74 | 154 | Reduced Blanking |
| (2) Extended Wide timing | | | | | |
| WXGA | 1280x720 | 60 | 44.8 | 74.2 | Standard Timing Identification |
| | 1280x800 | 60 | 49.6 | 83.5 | WXGA: (Native)Detailed Timing / Descriptor Block 1 XGA: Standard Timing Identification |
| | 1366x768 | 60 | 47.7 | 84.8 | |
| | 1440x900 | 60 | 59.9 | 106.5 | Standard Timing Identification |
| WSXGA+ | 1680x1050 | 60 | 65.3 | 146.3 | WXGA: Standard Timing Identification XGA: N/A |
| | 1920x720 | 60 | 44.35 | 92.25 | |
| (3) Component Signal | | | | | |
| 480i | 720x480 (1440x480) | 59.94(29.97) | 15.7 | 13.5 | |

APPENDICES

| 576i | 720x576 (1440x576) | 50(25) | 15.6 | 13.5 | |
|---------------------------------|-----------------------|-----------------------------|------------------------------|----------------------------|---|
| 480p | 720x480 | 59.94 | 31.5 | 27.0 | |
| 576p | 720x576 | 50 | 31.3 | 27.0 | |
| 720p | 1280x720 | 60 | 45.0 | 74.25 | |
| 720p | 1280x720 | 50 | 37.5 | 74.25 | |
| 1080i | 1920x1080 | 60(30) | 33.8 | 74.25 | |
| 1080i | 1920x1080 | 50(25) | 28.1 | 74.25 | |
| 1080p | 1920x1080 | 23.98/24 | 27.0 | 74.25 | |
| 1080p | 1920x1080 | 60 | 67.5 | 148.5 | |
| 1080p | 1920x1080 | 50 | 56.3 | 148.5 | |
| | | | | | |
| | | | | | |
| B. HDMI Digital | | | | | |
| (1) PC Signal | | | | | |
| Modes | Resolution | V.Frequency [Hz] | H.Frequency [KHz] | Pixel CLK [MHz] | EDID Description |
| VGA | 640x480 | 60 | 31.5 | 25.2 | Established Timings 1 |
| | 640x480 | 67 | 35.0 | 26.8 | Established Timings 1 |
| | 640x480 | 72 | 37.9 | 31.5 | Established Timings 1 |
| | 640x480 | 75 | 37.5 | 31.5 | Established Timings 1 |
| | 640x480 | 85 | 43.3 | 36.0 | |
| IBM | 720x400 | 70 | 31.5 | 28.3 | Established Timings 1 |
| SVGA | 800x600 | 56 | 35.1 | 36.0 | Established Timings 1 |
| | 800x600 | 60 | 37.9 | 40.0 | Established Timings 1 |
| | 800x600 | 72 | 48.1 | 50.0 | Established Timings 2 |
| | 800x600 | 75 | 46.9 | 49.5 | Established Timings 2 |
| | 800x600 | 85 | 53.7 | 56.3 | |
| Apple, Mac II | 832x624 | 75 | 49.1 | 57.3 | Established Timings 2 |
| XGA | 1024x768 | 60 | 48.4 | 65.0 | WXGA: Established Timings 2 XGA: Established Timings 2 and (Native)Detailed Timing / Descriptor Block 1 |
| | 1024x768 | 70 | 56.5 | 75.0 | Established Timings 2 |
| | 1024x768 | 75 | 60.0 | 78.8 | Established Timings 2 |
| | 1024x768 | 85 | 68.7 | 94.5 | |
| | 1024x768 | 120 | 99.0 | 137.8 | Standard Timing Identification |
| Apple, Mac II | 1152x870 | 75 | 68.7 | 100.0 | Manufacturer's Reserved Timing |
| SXGA | 1280x1024 | 60 | 64.0 | 108.0 | |
| | 1280x1024 | 72 | 77.0 | 133.0 | |
| | 1280x1024 | 75 | 80.0 | 135.0 | Established Timings 2 |
| QuadVGA | 1280x960 | 60 | 60.0 | 101.3 | Standard Timing Identification |
| | 1280x960 | 75 | 75.2 | 130.0 | |
| SXGA+ | 1400x1050 | 60 | 65.3 | 121.8 | |
| UXGA | 1600x1200 | 60 | 75.0 | 161.0 | Standard Timing Identification |
| Full HD | 1920x1080 | 60 | 67.5 | 148.5 | |
| WUXGA | 1920x1200 | 60 | 74 | 154 | Reduced Blanking |
| (2) Extended Wide timing | | | | | |

APPENDICES

| | | | | | |
|---|-----------------------|--------------|-------|-------|---|
| WXGA | 1280x720 | 60 | 44.8 | 74.2 | Standard Timing Identification |
| | 1280x800 | 60 | 49.6 | 83.5 | WXGA: (Native)Detailed Timing / Descriptor Block 1 XGA: Standard Timing Identification |
| | 1366x768 | 60 | 47.7 | 84.8 | |
| | 1440x900 | 60 | 59.9 | 106.5 | Standard Timing Identification |
| WSXGA+ | 1680x1050 | 60 | 65.3 | 146.3 | WXGA: Standard Timing Identification XGA: N/A |
| | 1920x720 | 60 | 44.35 | 92.25 | |
| (3) HDMI - Video Signal | | | | | |
| 640x480p | 640x480 | 59.94/60 | 31.5 | 25.2 | Short Video Descriptor of CEA EDID Timing |
| 480i | 720x480 (1440x480) | 59.94(29.97) | 15.7 | 13.5 | Short Video Descriptor of CEA EDID Timing |
| 576i | 720x576 (1440x576) | 50(25) | 15.6 | 13.5 | Short Video Descriptor of CEA EDID Timing |
| 480p | 720x480 | 59.94 | 31.5 | 27.0 | Short Video Descriptor of CEA EDID Timing |
| 576p | 720x576 | 50 | 31.3 | 27.0 | Short Video Descriptor of CEA EDID Timing |
| 720p | 1280x720 | 60 | 45.0 | 74.25 | (Native)Short Video Descriptor of CEA EDID Timing |
| 720p | 1280x720 | 50 | 37.5 | 74.25 | (Native)Short Video Descriptor of CEA EDID Timing |
| 1080i | 1920x1080 | 60(30) | 33.8 | 74.25 | Short Video Descriptor of CEA EDID Timing |
| 1080i | 1920x1080 | 50(25) | 28.1 | 74.25 | Short Video Descriptor of CEA EDID Timing |
| 1080p | 1920x1080 | 23.98/24 | 27.0 | 74.25 | Short Video Descriptor of CEA EDID Timing |
| 1080p | 1920x1080 | 60 | 67.5 | 148.5 | Short Video Descriptor of CEA EDID Timing |
| 1080p | 1920x1080 | 50 | 56.3 | 148.5 | Short Video Descriptor of CEA EDID Timing |
| (4) HDMI 1.4a mandatory 3D timing- Video Signal | | | | | |
| Frame Packing | 720p | 50 | 75 | 148.5 | Short Video Descriptor of CEA EDID Timing |
| | 720p | 59.94/60 | 90 | 148.5 | Short Video Descriptor of CEA EDID Timing |
| | 1080p | 23.98/24 | 54 | 148.5 | Short Video Descriptor of CEA EDID Timing |
| Top-and-Bottom | 720p | 50 | 37.5 | 74.25 | Short Video Descriptor of CEA EDID Timing |
| | 720p | 59.94/60 | 45.0 | 74.25 | Short Video Descriptor of CEA EDID Timing |
| | 1080p | 23.98/24 | 27.0 | 74.25 | Short Video Descriptor of CEA EDID Timing |
| (5) Input signal frequency range Analog: fh=15kHz~100kHz, fv=24Hz~120Hz, Max. pixel rate: 162.5MHz Digital (HDMI): fh=15kHz~100kHz, fv=24Hz~120Hz, Max. pixel rate: 200MHz | | | | | |

APPENDICES

Ceiling Mount Installation

1. To prevent damage to your projector, please use the Optoma ceiling mount.
2. If you wish to use a third party ceiling mount kit, please ensure the screws used to attach a mount to the projector meet the following specifications:
 - Screw type: M4*4
 - Minimum screw length: 14mm

Note: Please note that damage resulting from incorrect installation will void the warranty.

Warning:

1. If you buy a ceiling mount from another company, please be sure to use the correct screw size. Screw size will vary depending on the thickness of the mounting plate.
2. Be sure to keep at least 10 cm gap between the ceiling and the bottom of the projector.
3. Avoid installing the projector near a heat source.

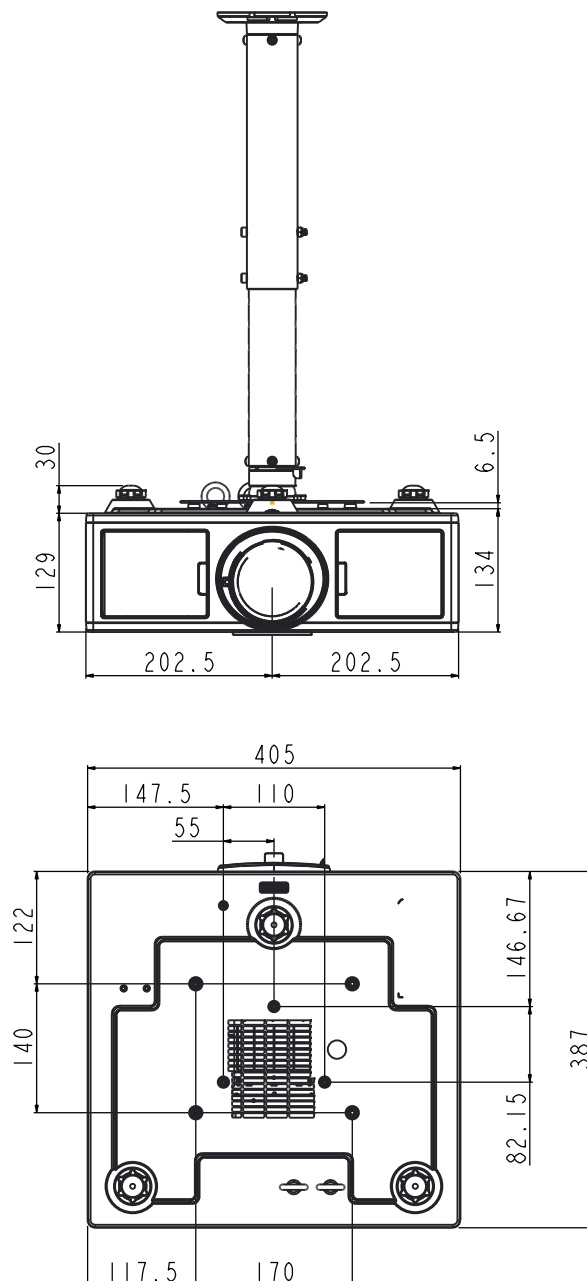

APPENDICES

Optoma global offices

For service or support, please contact your local office.

USA

3178 Laurelview Ct.
Fremont, CA 94538, USA
www.optomausa.com

☎ 888-289-6786
📠 510-897-8601
✉ services@optoma.com

Canada

3178 Laurelview Ct.
Fremont, CA 94538, USA
www.optomausa.com

☎ 888-289-6786
📠 510-897-8601
✉ services@optoma.com

Latin America

3178 Laurelview Ct.
Fremont, CA 94538, USA
www.optomausa.com

☎ 888-289-6786
📠 510-897-8601
✉ services@optoma.com

Europe

42 Caxton Way, The Watford Business Park
Watford, Hertfordshire,
WD18 8QZ, UK
www.optoma.eu
Service Tel : +44 (0)1923 691865

☎ +44 (0) 1923 691 800
📠 +44 (0) 1923 691 888
✉ service@tsc-europe.com

Benelux BV

Randstad 22-123
1316 BW Almere
The Netherlands
www.optoma.nl

☎ +31 (0) 36 820 0252
📠 +31 (0) 36 548 9052

France

Bâtiment E
81-83 avenue Edouard Vaillant
92100 Boulogne Billancourt,
France

☎ +33 1 41 46 12 20
📠 +33 1 41 46 94 35
✉ savoptoma@optoma.fr

Spain

C/ José Hierro,36 Of. 1C
28522 Rivas VaciaMadrid,
Spain

☎ +34 91 499 06 06
📠 +34 91 670 08 32

Deutschland

Wiesenstrasse 21 W
D40549 Düsseldorf,
Germany

☎ +49 (0) 211 506 6670
📠 +49 (0) 211 506 66799
✉ info@optoma.de

Scandinavia

Lerpeveien 25
3040 Drammen
Norway

☎ +47 32 98 89 90
📠 +47 32 98 89 99
✉ info@optoma.no

PO.BOX 9515
3038 Drammen
Norway

Korea

WOOMI TECH.CO.,LTD.
4F,Minu Bldg.33-14, Kangnam-Ku,
seoul,135-815, KOREA

☎ +82+2+34430004
📠 +82+2+34430005

Japan

東京都足立区綾瀬3-25-18
株式会社オーエス
コンタクトセンター:0120-380-495

✉ info@os-worldwide.com
www.os-worldwide.com

Taiwan

12F., No. 213,Sec. 3, Beixin Rd.,
Xindian Dist., New Taipei City 231,
Taiwan, R.O.C.
www.optoma.com.tw

☎ +886-2-8911-8600
📠 +886-2-8911-6550
✉ services@optoma.com.tw
asia.optoma.com

Hong Kong

Unit A, 27/F Dragon Centre,
79 Wing Hong Street,
Cheung Sha Wan,
Kowloon, Hong Kong

☎ +852-2396-8968
📠 +852-2370-1222
www.optoma.com.hk

China

5F, No. 1205, Kaixuan Rd.,
Changning District
Shanghai, 200052, China

☎ +86-21-62947376
📠 +86-21-62947375
www.optoma.com.cn

