

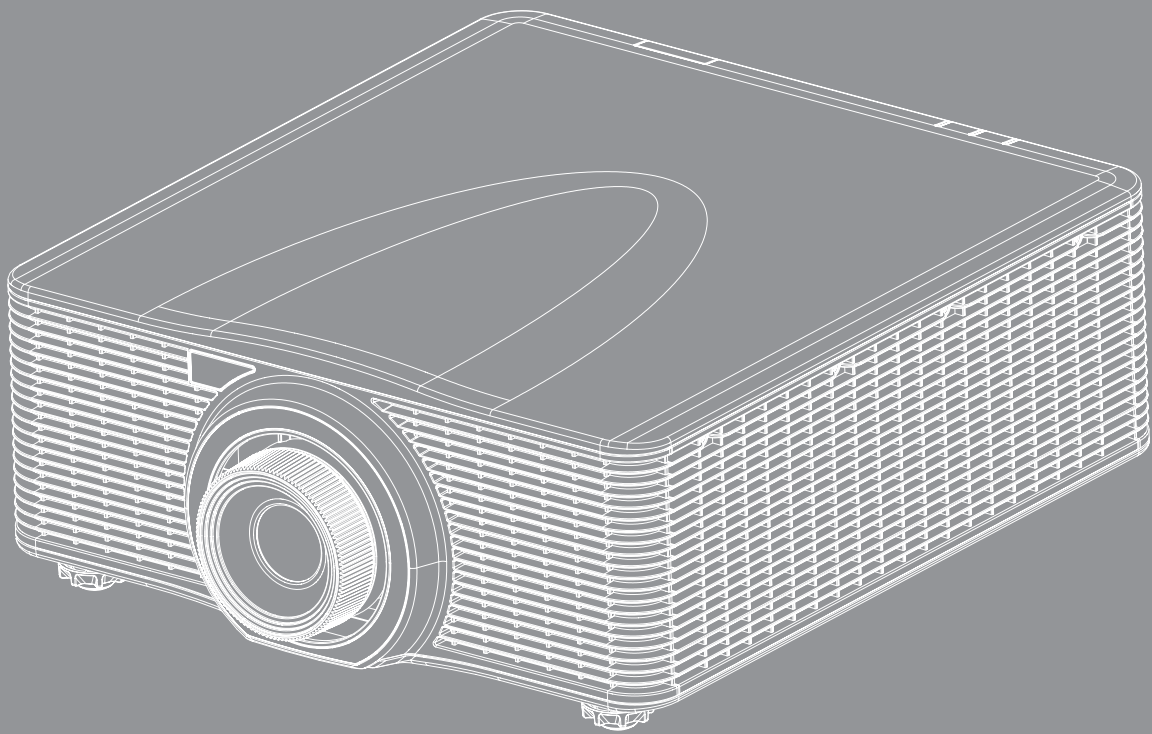

# DLP® Projector



# TABLE OF CONTENTS

<b>SAFETY .....</b>	<b>4</b>
<i>Important Safety Instruction.....</i>	<i>4</i>
<i>Laser Radiation Safety Information .....</i>	<i>5</i>
<i>Copyright .....</i>	<i>6</i>
<i>Disclaimer.....</i>	<i>6</i>
<i>Trademark Recognition .....</i>	<i>6</i>
<i>FCC .....</i>	<i>6</i>
<i>Declaration of Conformity for EU countries .....</i>	<i>7</i>
<i>WEEE .....</i>	<i>7</i>
<b>INTRODUCTION .....</b>	<b>8</b>
<i>Package Overview.....</i>	<i>8</i>
<i>Standard accessories .....</i>	<i>8</i>
<i>Optional accessories .....</i>	<i>8</i>
<i>Product Overview .....</i>	<i>9</i>
<i>Connections.....</i>	<i>10</i>
<i>Keypad .....</i>	<i>11</i>
<i>Remote control.....</i>	<i>12</i>
<b>SETUP AND INSTALLATION .....</b>	<b>13</b>
<i>Installing the projection lens .....</i>	<i>13</i>
<i>Adjusting the projector position .....</i>	<i>15</i>
<i>Connecting sources to the projector.....</i>	<i>16</i>
<i>Adjusting the projector image .....</i>	<i>17</i>
<i>Remote setup .....</i>	<i>18</i>
<b>USING THE PROJECTOR.....</b>	<b>20</b>
<i>Powering on / off the projector.....</i>	<i>20</i>
<i>Selecting an input source .....</i>	<i>21</i>
<i>Menu navigation and features .....</i>	<i>22</i>
<i>OSD Menu tree.....</i>	<i>23</i>
<i>PICTURE menu.....</i>	<i>29</i>
<i>OUTPUT menu.....</i>	<i>34</i>
<i>SETUP menu.....</i>	<i>38</i>
<i>Setup network control settings menu .....</i>	<i>43</i>
<i>OPTION menu.....</i>	<i>48</i>

<b>ADDITIONAL INFORMATION .....</b>	<b>52</b>
<i>Compatible resolutions .....</i>	<i>52</i>
<i>Image size and projection distance .....</i>	<i>54</i>
<i>Projector dimensions and ceiling mount installation.....</i>	<i>55</i>
<i>IR remote codes .....</i>	<i>56</i>
<i>Troubleshooting .....</i>	<i>59</i>
<i>Warning indicators.....</i>	<i>61</i>
<i>Specifications .....</i>	<i>63</i>
<i>Optoma global offices.....</i>	<i>64</i>

# SAFETY

	The lightning flash with arrow head within an equilateral triangle is intended to alert the user to the presence of uninsulated "dangerous voltage" within the product's enclosure that may be of sufficient magnitude to constitute a risk of electric shock to persons.
	The exclamation point within an equilateral triangle is intended to alert the user to the presence of important operating and maintenance (servicing) instructions in the literature accompanying the appliance.

Please follow all warnings, precautions and maintenance as recommended in this user's guide.

## Important Safety Instruction

- Do not block any ventilation openings. To ensure reliable operation of the projector and to protect from over heating, it is recommended to install the projector in a location that does not block ventilation. As an example, do not place the projector on a crowded coffee table, sofa, bed, etc. Do not put the projector in an enclosure such as a book case or a cabinet that restricts air flow.
- To reduce the risk of fire and/or electric shock, do not expose the projector to rain or moisture. Do not install near heat sources such as radiators, heaters, stoves or any other apparatus such as amplifiers that emits heat.
- Do not let objects or liquids enter the projector. They may touch dangerous voltage points and short out parts that could result in fire or electric shock.
- Do not use under the following conditions:
  - In extremely hot, cold or humid environments.
    - (i) Ensure that the ambient room temperature is within 5°C ~ 40°C
    - (ii) Relative humidity is 10% ~ 85%
  - In areas susceptible to excessive dust and dirt.
  - Near any appliance generating a strong magnetic field.
  - In direct sunlight.
- Do not use the projector in places where flammable gases or explosives gases may be present in the atmosphere. The lamp inside the projector becomes very hot during operation and the gases may ignite and result in a fire.
- Do not use the unit if it has been physically damaged or abused. Physical damage/abuse would be (but not limited to):
  - Unit has been dropped.
  - Power supply cord or plug has been damaged.
  - Liquid has been spilled on to the projector.
  - Projector has been exposed to rain or moisture.
  - Something has fallen in the projector or something is loose inside.
- Do not place the projector on an unstable surface. The projector may fall over resulting in injury or the projector may become damaged.
- Do not block the light coming out of the projector lens when in operation. The light will heat the object and may melt, cause burns or start a fire.
- Please do not open or disassemble the projector as this may cause electric shock.
- Do not attempt to service the unit yourself. Opening or removing covers may expose you to dangerous voltages or other hazards. Please call Optoma before you send the unit for repair.
- See projector enclosure for safety related markings.
- The unit should only be repaired by authorized service personnel.

- Only use attachments/accessories specified by the manufacturer.
- Do not look into straight into the projector lens during operation. The bright light may harm your eyes.
- This projector will detect the life of the lamp itself.
- When switching the projector off, please ensure the cooling cycle has been completed before disconnecting power. Allow 90 seconds for the projector to cool down.
- Turn off and unplug the power plug from the AC outlet before cleaning the product.
- Use a soft dry cloth with mild detergent to clean the display housing. Do not use abrasive cleaners, waxes or solvents to clean the unit.
- Disconnect the power plug from AC outlet if the product is not being used for a long period of time.
- Do not setup the projector in places where it might be subjected to vibration or shock.
- Do not touch the lens with bare hands.
- Remove battery/batteries from remote control before storage. If the battery/batteries are left in the remote for long periods, they may leak.
- Do not use or store the projector in places where smoke from oil or cigarettes may be present, as it can adversely affect the quality of the projector performance.
- Please follow the correct projector orientation installation as non standard installation may affect the projector performance.
- Use a power strip and or surge protector. As power outages and brown-outs can KILL devices.

## Laser Radiation Safety Information

- This product is classified as Class 3R of IEC60825-1 : 2007 and also complies with 21 CFR 1040.10 and 1040.11 except for deviations pursuant to Laser Notice No. 50, dated June 24, 2007.  
IEC 60825-1:2014: CLASS 1 LASER PRODUCT - RISK GROUP 2
- Explanatory label is shown all information of laser power.



- CLASS 3R LASER PRODUCT-AVOID DIRECT EYE EXPOSURE.
- Laser aperture is from projection lens, DO NOT LOOK INTO THE LENS.

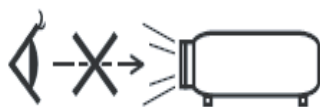

- This projector has built-in Class 4 laser module. Disassembly or modification is very dangerous and should never be attempted.
- Any operation or adjustment not specifically instructed by the user manual creates the risk of hazardous laser radiation exposure.
- Do not open or disassemble the projector as this may cause damage by the exposure of laser radiation.
- Do not stare into beam when the projector is on. The bright light may result in permanent eye damage.
- When turning on the projector, make sure no one within projection range is looking at the lens.
- Without following the control, adjustment or operation procedure may cause damage by the exposure of laser radiation.

- Adequate instructions for assembly, operation, and maintenance, including clear warnings concerning precautions to avoid possible exposure to laser and collateral radiation in excess of the accessible emission limits in Class 3R.

## Copyright

This publication, including all photographs, illustrations and software, is protected under international copyright laws, with all rights reserved. Neither this manual, nor any of the material contained herein, may be reproduced without written consent of the author.

© Copyright 2015

## Disclaimer

The information in this document is subject to change without notice. The manufacturer makes no representations or warranties with respect to the contents hereof and specifically disclaims any implied warranties of merchantability or fitness for any particular purpose. The manufacturer reserves the right to revise this publication and to make changes from time to time in the content hereof without obligation of the manufacturer to notify any person of such revision or changes.

## Trademark Recognition

Kensington is a U.S. registered trademark of ACCO Brand Corporation with issued registrations and pending applications in other countries throughout the world.

HDMI, the HDMI Logo, and High-Definition Multimedia Interface are trademarks or registered trademarks of HDMI Licensing LLC in the United States and other countries.

DLP®, DLP Link and the DLP logo are registered trademarks of Texas Instruments and BrilliantColor™ is a trademark of Texas Instruments.

All other product names used in this manual are the properties of their respective owners and are Acknowledged.

## FCC

This device has been tested and found to comply with the limits for a Class A digital device pursuant to Part 15 of the FCC rules. These limits are designed to provide reasonable protection against harmful interference in a residential installation. This device generates, uses and can radiate radio frequency energy and, if not installed and used in accordance with the instructions, may cause harmful interference to radio communications.

However, there is no guarantee that interference will not occur in a particular installation. If this device does cause harmful interference to radio or television reception, which can be determined by turning the device off and on is encouraged to try to correct the interference by one or more of the following measures:

- Reorient or relocate the receiving antenna.
- Increase the separation between the device and receiver.
- Connect the device into an outlet on a circuit different from that to which the receiver is connected.
- Consult the dealer or an experienced radio/television technician for help.

### Notice: Shielded cables

All connections to other computing devices must be made using shielded cables to maintain compliance with FCC regulations.

### Caution

Changes or modifications not expressly approved by the manufacturer could void the user's authority, which is granted by the Federal Communications Commission, to operate this projector.

## Operation Conditions

This device complies with Part 15 of the FCC Rules. Operation is subject to the following two conditions:

1. This device may not cause harmful interference and
2. This device must accept any interference received, including interference that may cause undesired operation.

## Notice: Canadian users

This Class A digital apparatus complies with Canadian ICES-003.

Remarque à l'intention des utilisateurs canadiens

Cet appareil numérique de la classe A est conforme à la norme NMB-003 du Canada.

## Declaration of Conformity for EU countries

- EMC Directive 2004/108/EC (including amendments)
- Low Voltage Directive 2006/95/EC
- R & TTE Directive 1999/5/EC (if product has RF function)

## WEEE



### Disposal instructions

Do not throw this electronic device into the trash when discarding. To minimize pollution and ensure utmost protection of the global environment, please recycle it.



# INTRODUCTION

## Package Overview



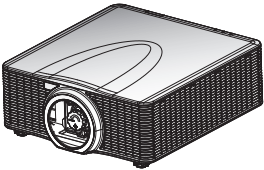

Carefully unpack and verify that you have the items listed below under standard accessories. Some of the items under optional accessories may not be available depending on the model, specification and your region of purchase. Please check with your place of purchase. Some accessories may vary from region to region.

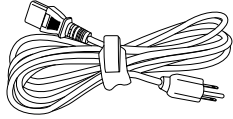
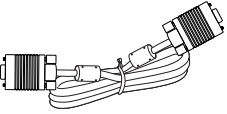
The warranty card is only supplied in some specific regions. Please consult your dealer for detailed information.

## Standard accessories

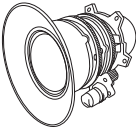
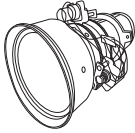
 <b>Projector</b>	 <b>Remote control</b>	 <b>2x AAA batteries</b>	 <b>Power lead</b>
 <b>VGA cable</b>	<ul style="list-style-type: none"><li><input checked="" type="checkbox"/> CD User Manual</li><li><input checked="" type="checkbox"/> Warranty Card</li><li><input checked="" type="checkbox"/> Basic User Manual</li></ul> <b>Documentation</b>		

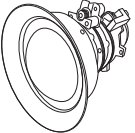
## Optional accessories

 <b>Optional lens A01</b> (1.00-1.28)	 <b>Optional lens A02</b> (1.28-1.61)	 <b>Optional lens A03</b> (1.60-3.07)	 <b>Optional lens A13</b> (3.04-5.78)
 <b>Optional lens A15</b> (0.79-1)	 <b>Wireless dongle</b> (WUSB Pro)		

**Note:** Optional accessories vary depending on model, specification and region.



# INTRODUCTION

## Product Overview

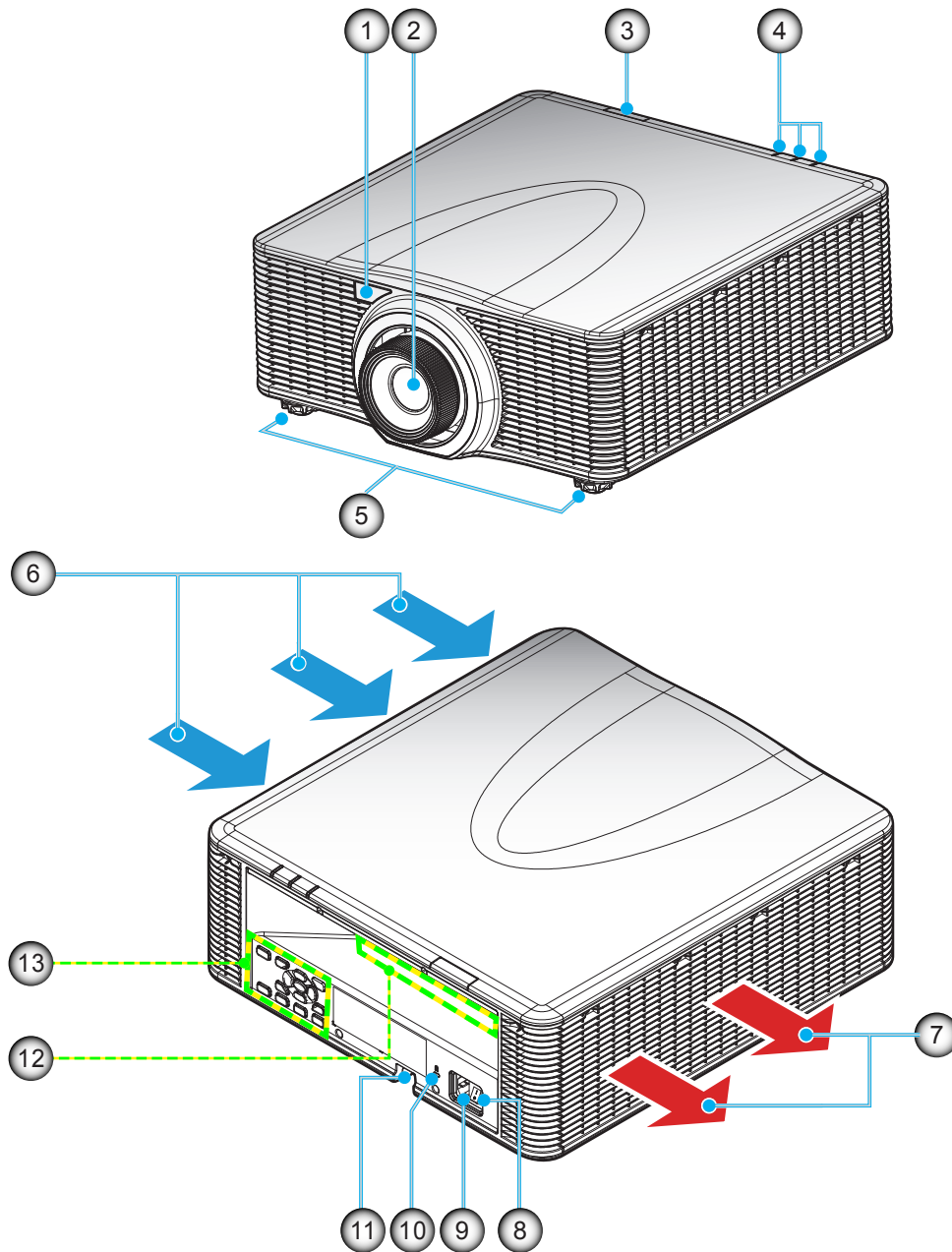

**Note:** Do not block projector inlet or outlet air vents.

(\*) optional accessory varies depending on model, specification, and region.

No	Item	No	Item
1.	Front IR Receiver	8.	Power Switch
2.	Lens	9.	Power Socket
3.	Top IR Receiver	10.	Kensington™ Lock Port
4.	LED Status Indicators	11.	Security Bar
5.	Tilt-Adjustment Feet	12.	Input / Output
6.	Ventilation (inlet)	13.	Keypad
7.	Ventilation (outlet)		

# INTRODUCTION

## Connections

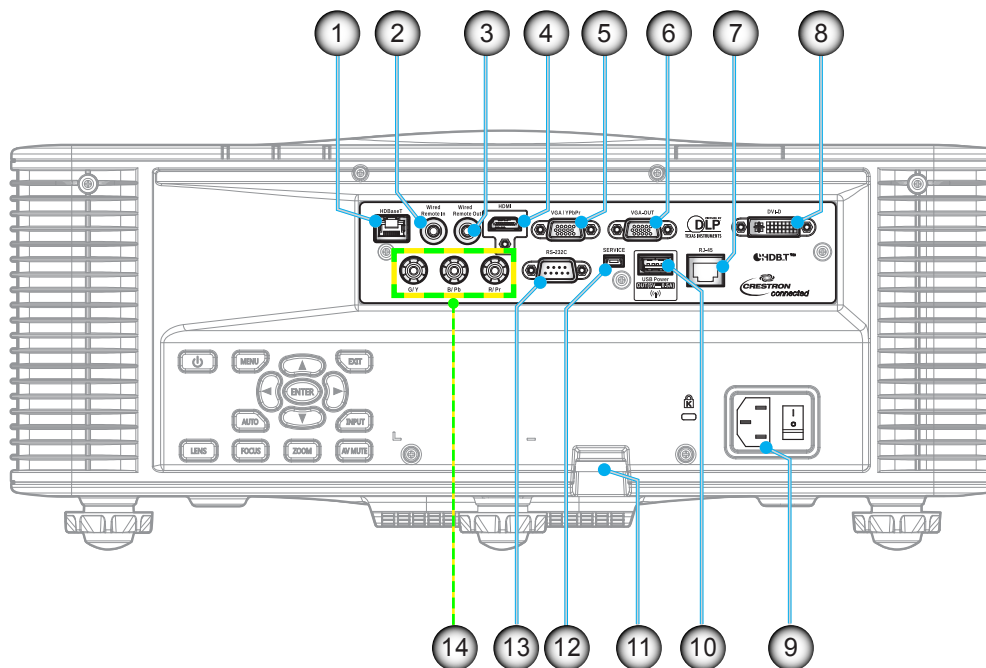

No	Item	No	Item
1.	HDBaseT Connector	8.	DVI-D Connector
2.	Remote IN Connector	9.	Power Socket
3.	Remote OUT Connector	10.	USB Connector (support 5V, 0.5A) for wireless dongle
4.	HDMI Connector	11.	Security Bar
5.	VGA IN / YPbPr Connector	12.	SERVICE Connector
6.	VGA OUT Connector	13.	RS-232C Connector
7.	RJ-45 Connector	14.	Component IN Connector

# INTRODUCTION

## Keypad

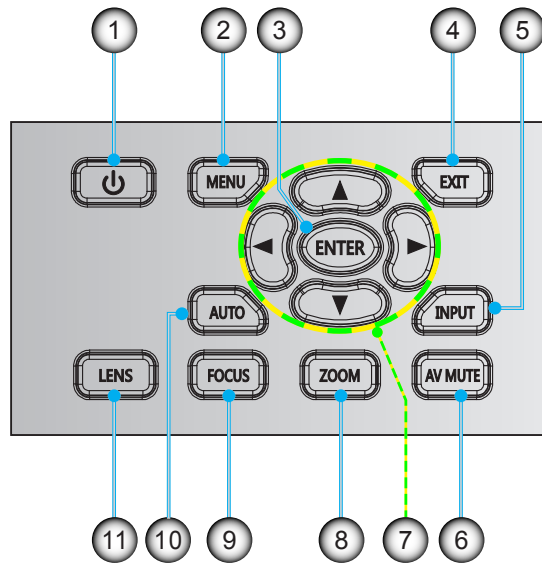

No	Item	No	Item
1.	Power	7.	Four Directional Select Keys
2.	Menu	8.	Zoom
3.	Enter	9.	Focus
4.	Exit	10.	Auto
5.	Input	11.	Lens
6.	AV Mute		

# INTRODUCTION

## Remote control

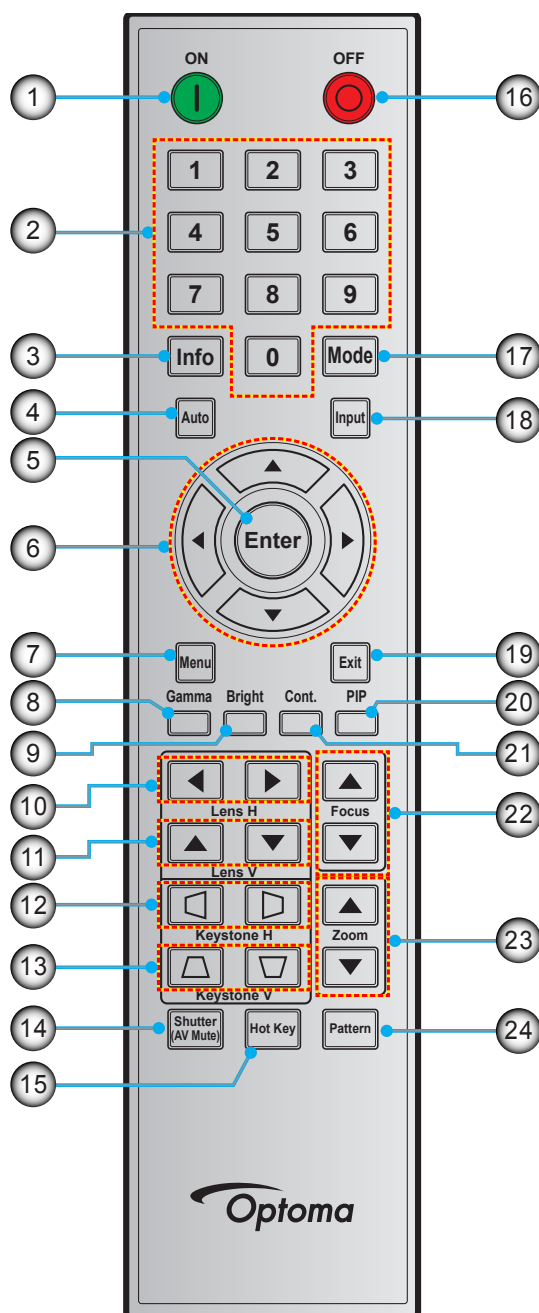

No	Item	No	Item	No	Item
1.	Power On	9.	Bright	17.	Mode
2.	Number Keys	10.	Lens H	18.	Input
3.	Info	11.	Lens V	19.	Exit
4.	Auto	12.	Keystone H	20.	PIP
5.	Enter	13.	Keystone V	21.	Cont.
6.	Four Directional Select Keys	14.	Shutter (AV Mute)	22.	Focus
7.	Menu	15.	Hot Key	23.	Zoom
8.	Gamma	16.	Power Off	24.	Pattern

# SETUP AND INSTALLATION

## Installing the projection lens

Before setting up the projector, install the projection lens on the projector.

在安装或替换镜头前，关掉投影机的电源。

在镜头安装联接过程中，避免使用遥控器或投影机按键板的按钮调节侧平移镜头或缩放/聚焦。

Before install or replacing the lens, switch off the power to the projector.

Avoid using the remote control or projector keypad button to adjust the lens shift or zoom/focus while the lens attachment process is carried out.

### IMPORTANT!

- *Make sure the projector is properly turned off before installing the lens.*
- *During lens installation, do not adjust the lens shift, zoom, or focus either using the remote control or the projector keypad.*

Procedure:

1. Rotate the lens cap counterclockwise.

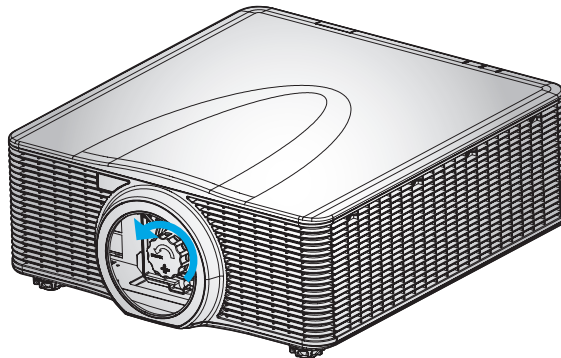

2. Remove the lens cap.

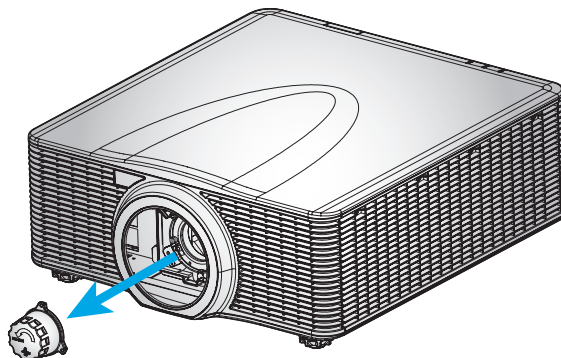

# SETUP AND INSTALLATION

3. Install the lens onto the projector.

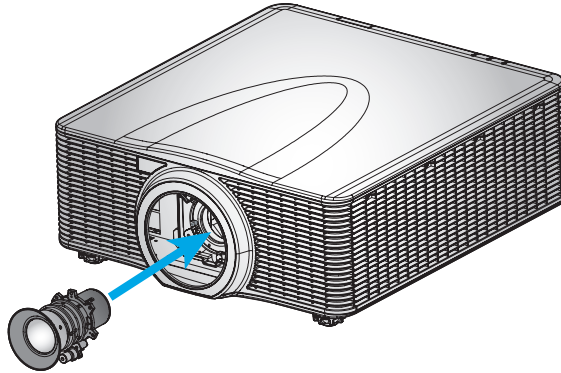

4. Rotate the lens clockwise to lock the lens in place.

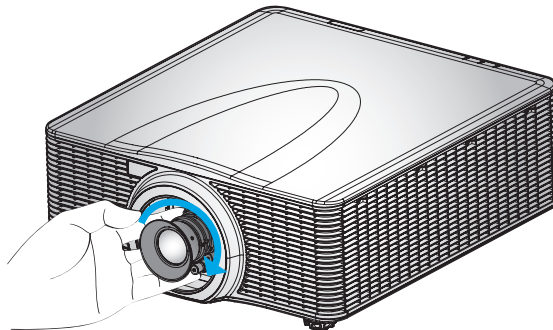

5. Firmly install the lens ring onto the lens.

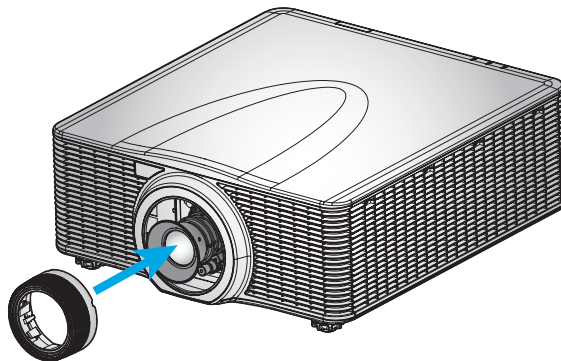

**Note:** The lens ring is compatible with the following lens modules: A01 (1.00-1.28), A02 (1.28-1.61), A03 (1.60-3.07), and A13 (3.04-5.78).

# SETUP AND INSTALLATION

## Adjusting the projector position

When you select a position for the projector, consider the size and shape of your screen, the location of your power outlets, and the distance between the projector and the rest of your equipment. Follow these general guidelines:

- Position the projector on a flat surface at a right angle to the screen. The projector (with the standard lens) must be at least 3 feet (0.9m) from the projection screen.
- Position the projector to the desired distance from the screen. The distance from the lens of the projector to the screen, the zoom setting, and the video format determine the size of the projected image.
- For the fixed short lens, the image exits at a default angle. However, the lens shift feature makes the image offset variable.
- 360 degree free orientation operation

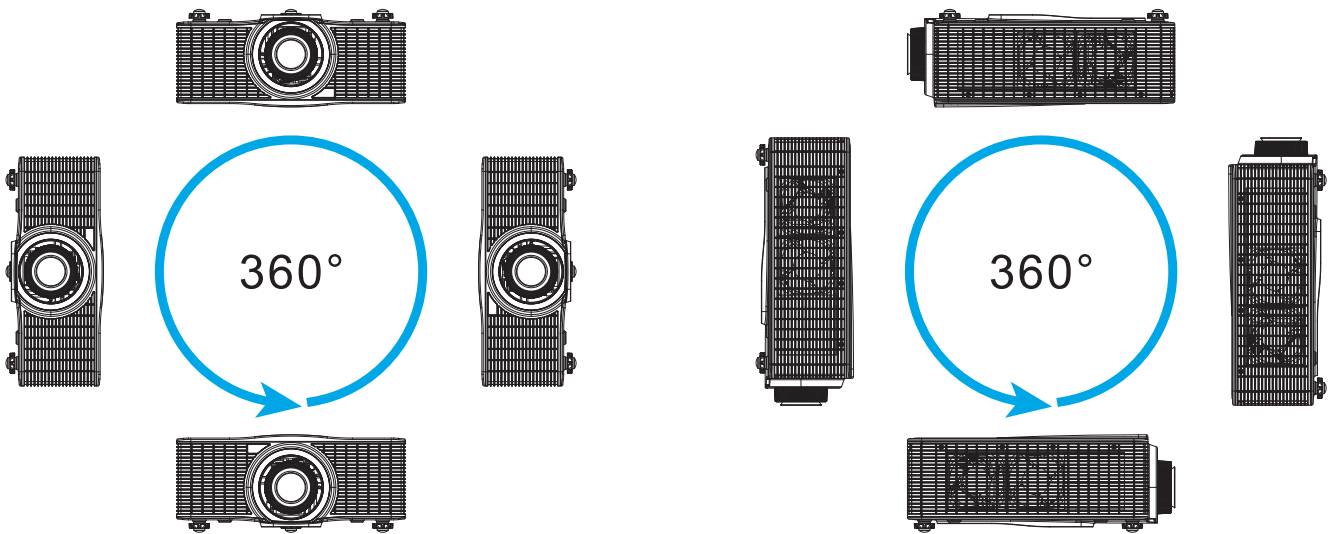

# SETUP AND INSTALLATION

## Connecting sources to the projector

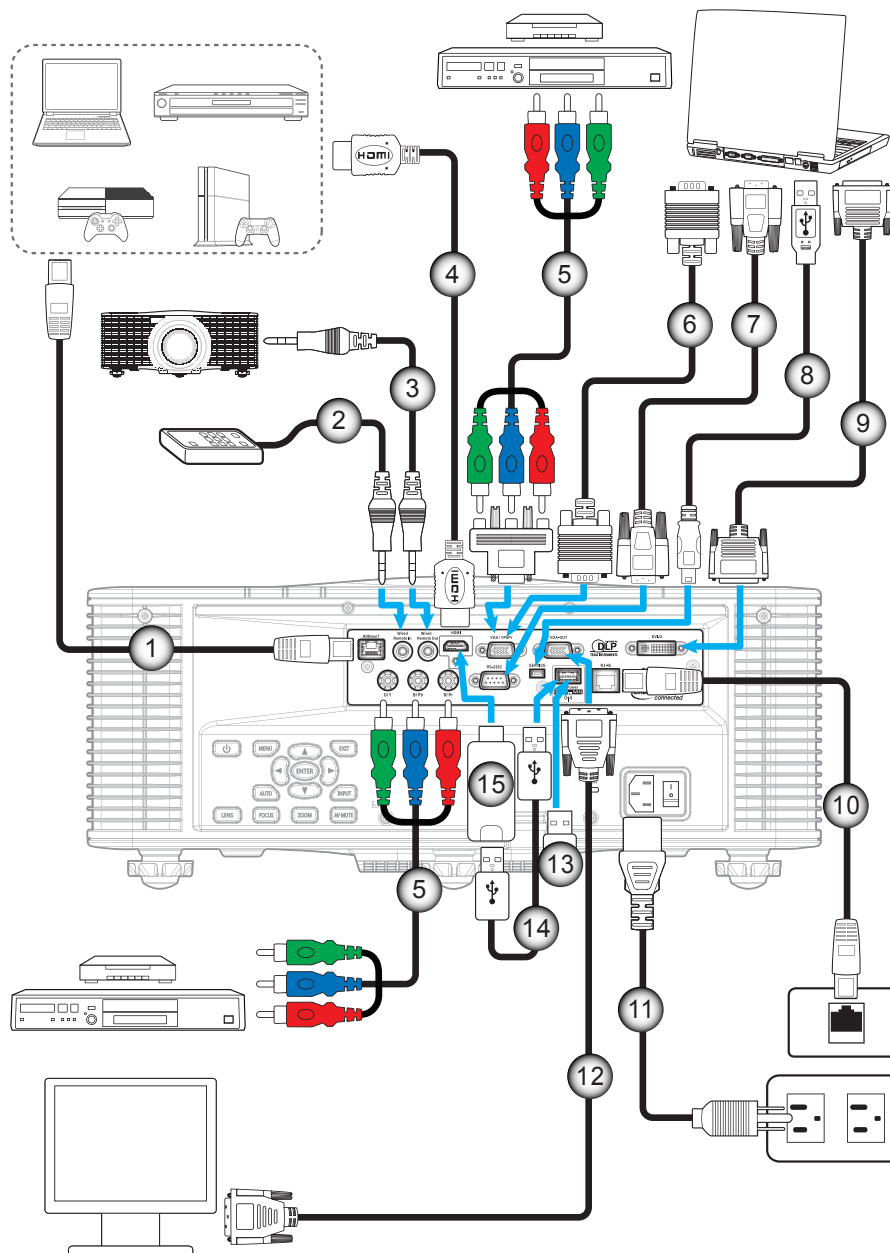

No	Item	No	Item
1.	CAT5e/6/6A Cable	9.	DVI-D Cable
2.	Wired Remote-In Cable	10.	RJ-45 Cable
3.	Wired Remote-Out Cable	11.	Power Cord
4.	HDMI Cable	12.	VGA-Out Cable
5.	RCA Component Cable	13.	Wireless (Wi-Fi) Dongle
6.	VGA-In Cable	14.	USB Power Cable
7.	RS-232C Cable	15.	HDMI Dongle
8.	USB Cable (mouse control)		



# SETUP AND INSTALLATION

## Adjusting the projector image

### Image height

The projector is equipped with elevator feet for adjusting the image height.

1. Locate the adjustable foot you wish to adjust on the underside of the projector.
2. Rotate the adjustable foot clockwise or counterclockwise to raise or lower the projector.

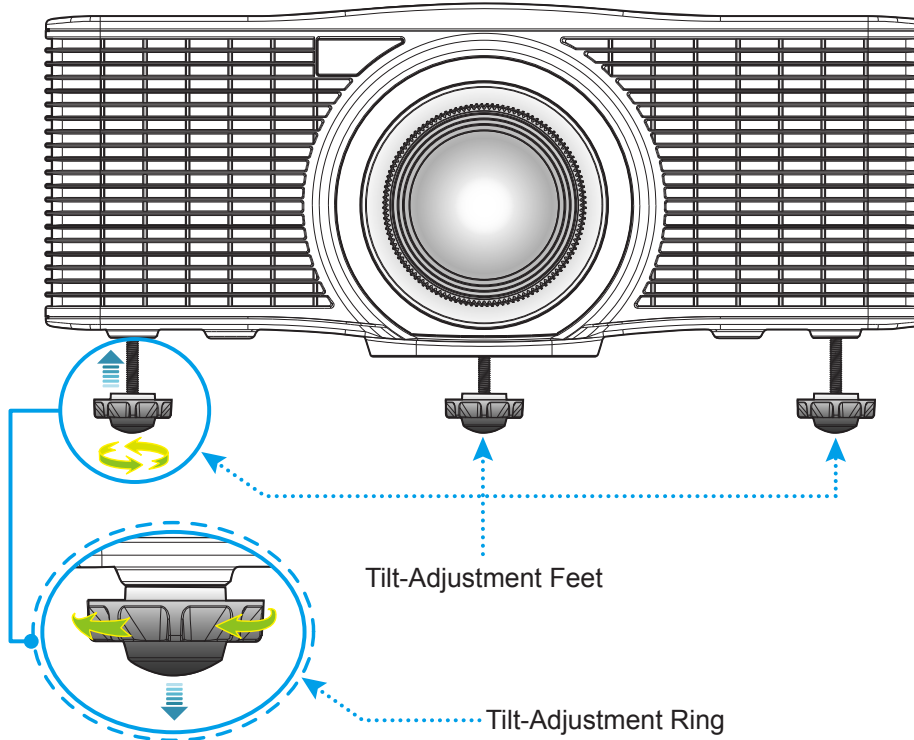

Warning:

- The feet of projector are not removable. Please do not screw out the feet of projector. The adjustable height of the elevator feet could be raised up to 45mm.

### Zoom and focus

- To adjust the image size, press the **Zoom** button (A) to increase or decrease the projected image size.
- To adjust the focus, press the **Focus** button (B) until the image is sharp and legible.

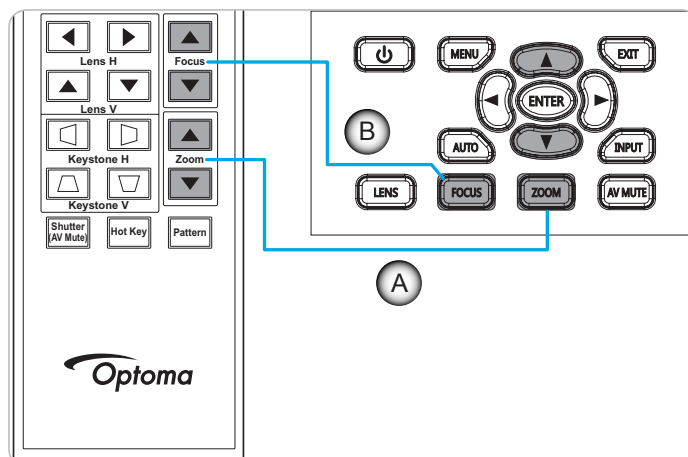

# SETUP AND INSTALLATION

## Remote setup

### Installing / replacing the batteries

Two AAA size batteries are supplied for the remote control.

1. Remove the battery cover on the back of the remote control.
2. Insert AAA batteries in the battery compartment as illustrated.
3. Replace back cover on remote control.

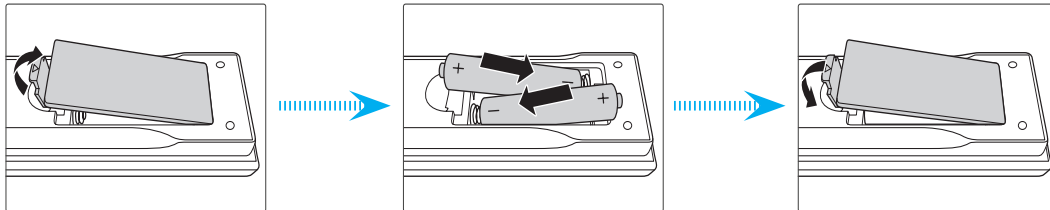

**Note:** Replace only with the same or equivalent type batteries.

### CAUTION

Improper use of batteries can result in chemical leakage or explosion. Be sure to follow the instructions below.

- Do not mix batteries of different types. Different types of batteries have different characteristics.
- Do not mix old and new batteries. Mixing old and new batteries can shorten the life of new batteries or cause chemical leakage in old batteries.
- Remove batteries as soon as they are depleted. Chemicals that leak from batteries that come in contact with skin can cause a rash. If you find any chemical leakage, wipe thoroughly with a cloth.
- The batteries supplied with this product may have a shorter life expectancy due to storage conditions.
- If you will not be using the remote control for an extended period of time, remove the batteries.
- When you dispose of the batteries, you must obey the law in the relative area or country.

### Effective range

Infra-Red (IR) remote control sensors are located on the front and top sides of the projector. Ensure to hold the remote control at an angle within  $\pm 30^\circ$  (horizontally or vertically) to the projector's IR remote control sensor to function correctly. The distance between the remote control and the sensor should not be longer than 10 meters (32.8 feet).

- Make sure that there are no obstacles between the remote control and the IR sensor on the projector that might obstruct the infra-red beam.
- Make sure the IR transmitter of the remote control is not being shined by sunlight or fluorescent lamps directly.
- Please keep the remote controller away from fluorescent lamps for over 2 m or the remote controller might become malfunction.
- If the remote control is closed to Inverter-Type fluorescent lamps, it might become ineffective from time to time.
- If the remote control and the projector are within a very short distance, the remote control might become ineffective.
- When you aim at the screen, the effective distance is less than 5 m from the remote control to the screen and reflecting the IR beams back to the projector. However, the effective range might change according to screens.

# SETUP AND INSTALLATION

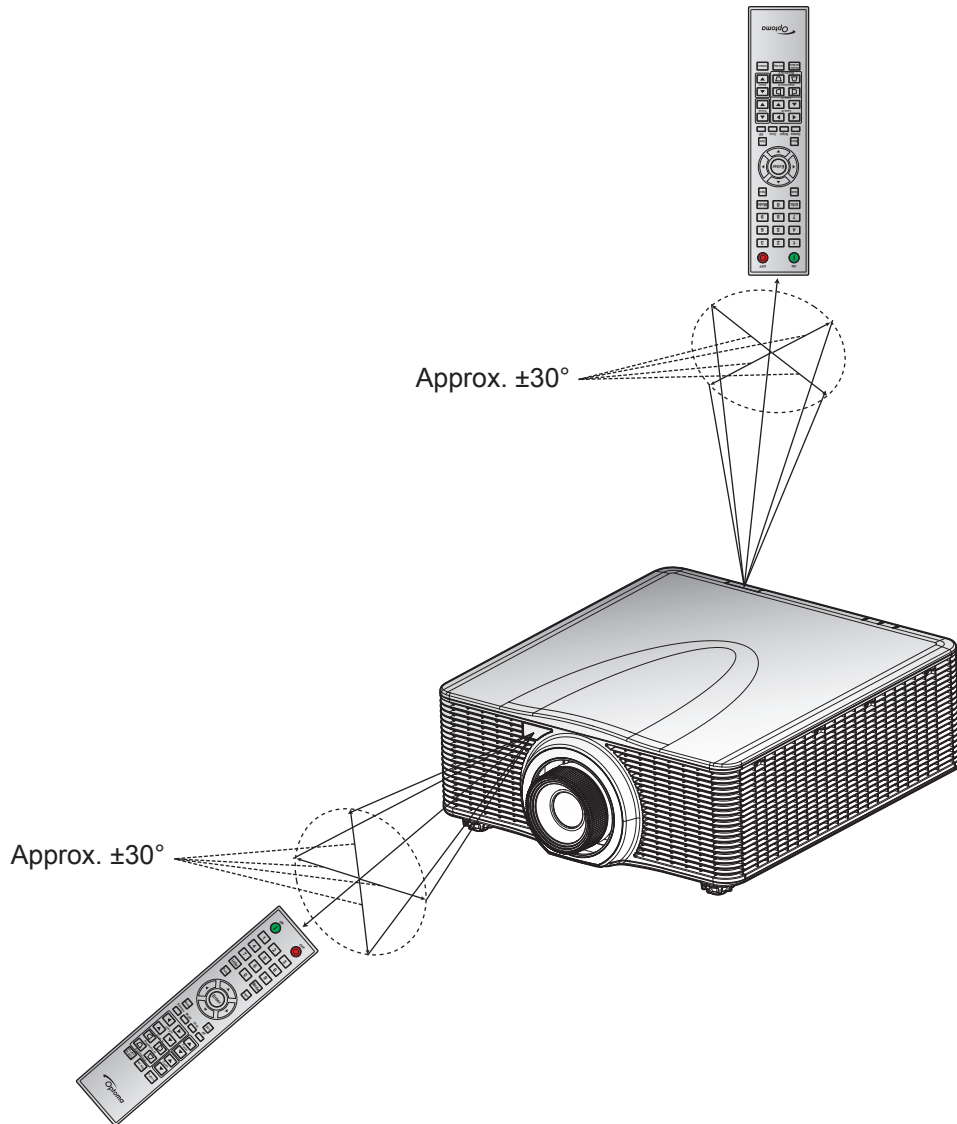

# USING THE PROJECTOR

## Powering on / off the projector

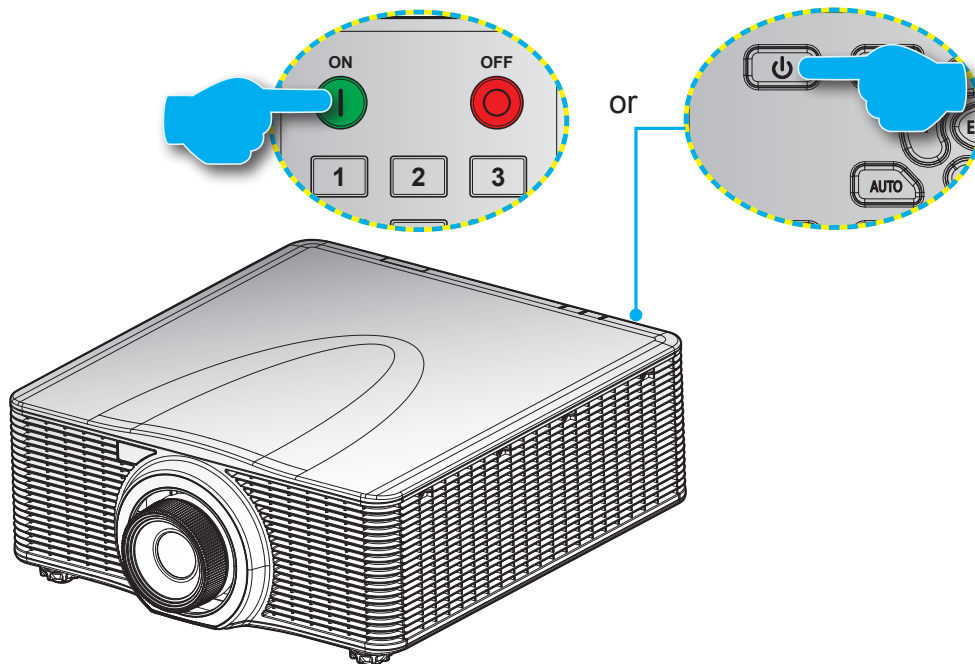



### Powering on





1. Securely connect the power lead and signal/source cable.
2. Set the **Power** switch to the “ON” position.
3. Turn on the projector by pressing “1” on the remote control or pressing “” on the projector keypad. The Status LED is Orange with a long blink.

**Note:** The first time the projector is turned on, you will be prompted to select the preferred language, projection orientation, and other settings.

### Powering off

1. Turn off the projector by pressing “” on the projector keypad or pressing “” on the remote control. A warning message will appear on the displayed image.

Powering Off...  
Press OFF key to Confirm

2. Press “” on the projector keypad or press “” on the remote control again to confirm, otherwise the warning message will disappear after 10 seconds. When you press “” on the projector keypad or press “” on the remote control for the second time, the projector will shut down.
3. Set the **Power** switch to the “OFF” position.
4. Disconnect the power lead from the electrical outlet and the projector.

**Note:** It is not recommended that the projector is turned on immediately, right after a power off procedure.

# USING THE PROJECTOR

## Selecting an input source

Turn on the connected source that you want to display on the screen, such as computer, notebook, video player, etc. The projector will automatically detect the source. If multiple sources are connected, press the **Input** button on the projector keypad or the remote control to select the desired input.

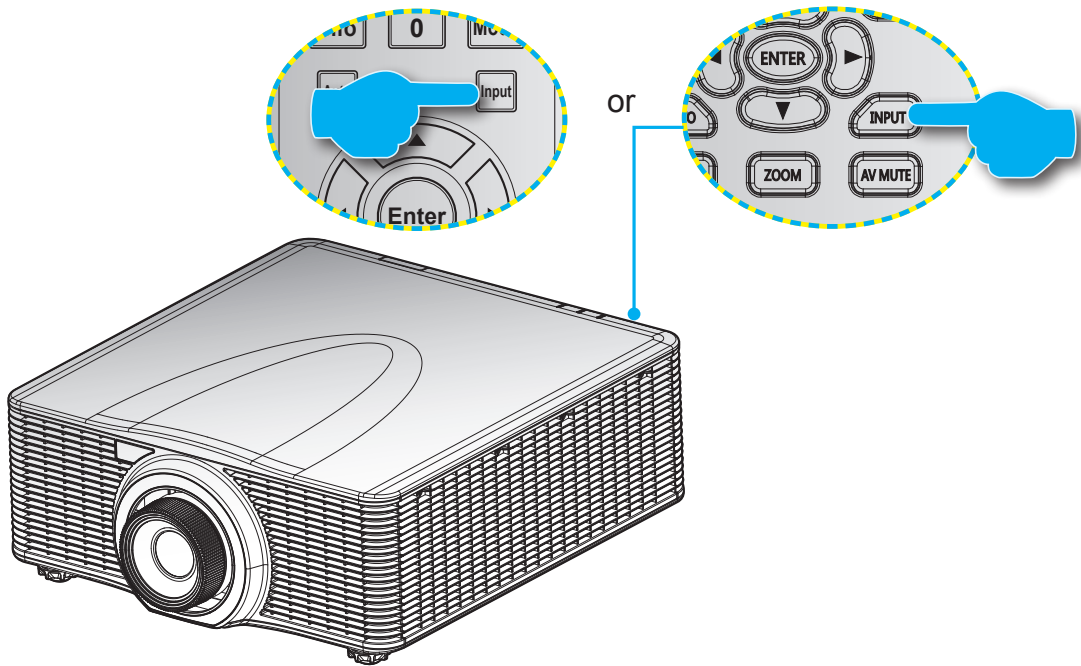

# USING THE PROJECTOR

## Menu navigation and features

The projector has multilingual on-screen display menus that allow you to make image adjustments and change a variety of settings. The projector will automatically detect the source.

1. To open the OSD menu, press "Menu" on the remote control or the projector keypad.
2. When OSD is displayed, use ▲▼◀▶ to navigate within the menu and adjust a setting up or down.
3. Press "Enter" to enter the submenu or confirm the selection/setting.
4. Press "Exit" to return to the previous menu or exit menus if at top level.

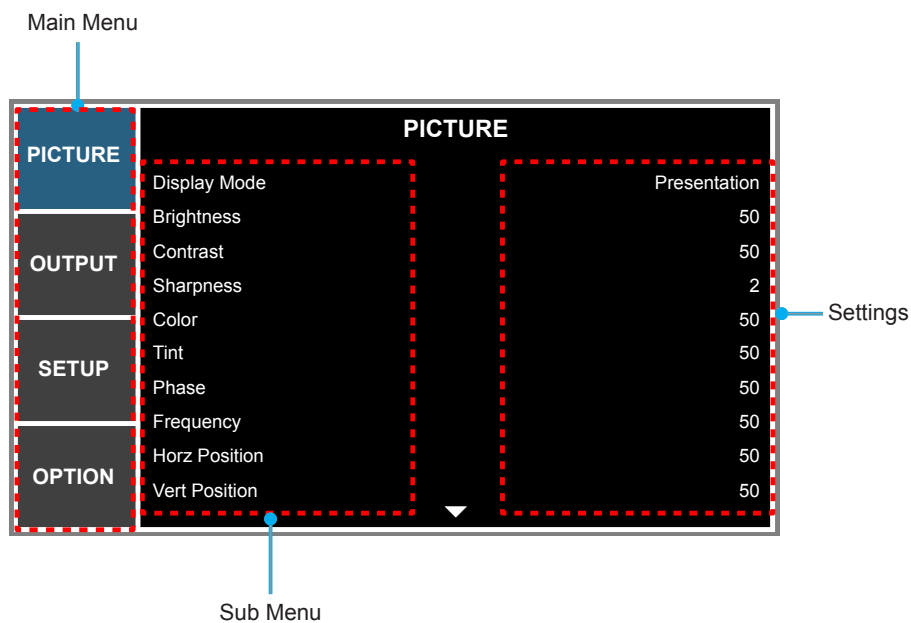

# USING THE PROJECTOR

## OSD Menu tree

Main Menu	Sub Menu	Sub Menu 2	Sub Menu 3	Sub Menu 4	Values	
PICTURE	Display Mode	Presentation			By source set	
		Video				
		Bright				
		DICOM SIM				
		Blending				
		User				
		Save to User				
	Brightness	0 ~ 100			50	
	Contrast	0 ~ 100			50	
	Sharpness	0 ~ 4			2	
	Color	0 ~ 100			50	
	Tint	0 ~ 100			50	
	Phase	0 ~ 100			50	
	Frequency	0 ~ 100			50	
	Horz Position	0 ~ 100			50	
	Vert Position	0 ~ 100			50	
	Auto Image					
	Color Matching	Enable	Off			Off
			On			
		Auto Test Pattern	Off			On
			On			
		Red Part of Red	0 - 1000			1000
		Green Part of Red	0 - 1000			0
		Blue Part of Red	0 - 1000			0
		Green Part of Green	0 - 1000			1000
		Red Part of Green	0 - 1000			0
		Blue Part of Green	0 - 1000			0
		Blue Part of Blue	0 - 1000			1000
		Red Part of Blue	0 - 1000			0
		Green Part of Blue	0 - 1000			0
		Red Part of White	0 - 1000			1000
		Green Part of White	0 - 1000			1000
		Blue Part of White	0 - 1000			1000
Reset to Default		Yes				
	No					
Advanced	White Peaking	0 - 100			By source set	
	Gamma	Video			By source set	
		Film				
		Bright				
		CRT				
		DICOM				
		Gamma 2.2				

# USING THE PROJECTOR

Main Menu	Sub Menu	Sub Menu 2	Sub Menu 3	Sub Menu 4	Values
PICTURE	Advanced	Color Temperature	Warmest		By source set
			Warm		
			Cool		
			Bright		
		Color Space	RGB		Auto
			REC709		
			REC601		
			RGB Video		
			Auto		
		Color Settings	Red Gain	0 ~ 100	50
			Green Gain	0 ~ 100	50
			Blue Gain	0 ~ 100	50
			Red Offset	0 ~ 100	50
			Green Offset	0 ~ 100	50
			Blue Offset	0 ~ 100	50
			Reset RGB Gain/Offset		
Color Enhancement	0 ~ 2		1		
Film Mode	Off				
	On				
Extreme Black	Off		On		
	On				
OUTPUT	Aspect Ratio	Auto		Auto	
		4:3			
		16:10			
		Native			
	Overscan	Off		By source set	
		On			
	H Digital Zoom	50% ~ 400%		100	
	V Digital Zoom	50% ~ 400%		100	
	H Digital Shift	0 ~ 100		50	
	V Digital Shift	0 ~ 100		50	
	Image Warping	H Keystone	0 ~ 40	20	
		V Keystone	0 ~ 40	20	
		H Pincushion	0 ~ 100	50	
		V Pincushion	0 ~ 100	50	
	PIP/PBP	PIP/PBP Enable	Off		Off
			On		
Main Source		VGA		VGA	
		HDMI			
		Component			
		HDBaseT			
	DVI-D				



# USING THE PROJECTOR

Main Menu	Sub Menu	Sub Menu 2	Sub Menu 3	Sub Menu 4	Values	
OUTPUT	PIP/PBP	Sub Source	VGA			
			HDMI			
			Component			
			HDBaseT			
			DVI-D			
		Swap				
		Size	Small			Large
			Medium			
			Large			
		Layout	PBP, Main Left			
			PBP, Main Top			
			PBP, Main Right			
			PBP, Main Bottom			
			PIP-Bottom Right			
PIP-Bottom Left						
PIP-Top Left						
PIP-Top Right						
SETUP	Language	English			English	
		French				
		Spanish				
		German				
		Italian				
		Russian				
		Chinese Simplified				
		Japanese				
		Korean				
	Ceiling Mount	Off			Auto	
		On				
		Auto				
	Rear Projection	Off			Off	
		On				
	Lens Function	Focus				
		Zoom				
		Lens Shift				
		Lens Calibration	Yes/No (Dialog box)			
		Lens Lock	No			
	Yes					
	Menu Preferences	Menu Transparency	0 ~ 9		0	
		Show Messages	Off			On
	On					
	Keypad LED Settings	Off			On	
		On				

# USING THE PROJECTOR

Main Menu	Sub Menu	Sub Menu 2	Sub Menu 3	Sub Menu 4	Values	
SETUP	Pin	Pin Protect	Off		Off	
			On		PIN default : 12345	
		Change PIN				
	Communications	LAN		DHCP		by set
				IP Address		by set
				Subnet Mask		by set
				Default Gateway		by set
				MAC Address		
				Apply		by set
		WLAN		Enable		by set
				Start IP		by set
				End IP		by set
				Subnet Mask		by set
				Default Gateway		by set
				MAC Address		by set
		Network		Projector Name		by set
				Restart Network		
				Network Factory Reset		
		Serial Port Baud Rate		9600		19200
				14400		
				19200		
				38400		
				57600		
Serial Port Path		RS232		RS232		
		HDBaseT				
Projector Address		0 - 9		0		
OPTION	Auto Source		Off		On	
			On			
	High Altitude		Off		Off	
			On			
	Test Pattern		Off		Off	
			Grid			
			Red			
			Green			
			Blue			
			Yellow			
			Magenta			
			Cyan			
			White			
	Black					

# USING THE PROJECTOR

Main Menu	Sub Menu	Sub Menu 2	Sub Menu 3	Sub Menu 4	Values
OPTION	Background Color	Logo			Logo
		Blue			
		Black			
		White			
	Hot-Key settings	Blank Screen			Blank Screen
		Aspect Ratio			
		Freeze Screen			
		Overscan			
	Power Settings	Standby Power Mode	0.5W mode		0.5W mode
			Communication mode		
		Direct Power On	Off		Off
			On		
		Auto Power Off	No		No
			5 Mins		
			10 Mins		
			15 Mins		
			20 Mins		
			30 Mins		
		Sleep Timer	No		No
			2 Hours		
			4 Hours		
			6 Hours		
	Light Source Settings	Light Source Mode	Constant Power		Constant Power
			Constant Luminance		
			Eco Mode		
		Constant Power Settings	0 - 10		10
		Constant Luminance Settings	0 - 10		7
	Light Sensor	Total Projector Hours			
		Light Sensor Calibration			
	Information	Calibrated?	(Display Yes/No)		
		Model Name			
		Serial Number			
Native Resolution					
Firmware					
Main Source					
- Resolution					
- Signal Format					
- Pixel Clock					
- Horz Refresh					

# USING THE PROJECTOR

Main Menu	Sub Menu	Sub Menu 2	Sub Menu 3	Sub Menu 4	Values
OPTION	Information	- Vert Refresh			
		Sub Source			
		- Resolution			
		- Signal Format			
		- Pixel Clock			
		- Horz Refresh			
		- Vert Refresh			
		Light Source Mode			
		Total Projector Hours			
		Standby Power Mode			
		IP Address			
		DHCP			
		System Temperature			
	Factory Reset	Yes/No (Dialog box)			
	Service				

# USING THE PROJECTOR

## PICTURE menu

PICTURE	
PICTURE	Display Mode Presentation
OUTPUT	Brightness 50
	Contrast 50
	Sharpness 2
SETUP	Color 50
	Tint 50
	Phase 50
OPTION	Frequency 50
	Horz Position 50
	Vert Position 50

PICTURE (1/2)

PICTURE	
PICTURE	Auto Image ▲
OUTPUT	Color Matching
	Advanced
SETUP	
OPTION	

PICTURE (2/2)

### Display Mode

There are many factory presets optimized for various types of images.

- **Presentation:** This mode is suitable for showing PowerPoint presentations when the projector is connected to the PC.
- **Video:** This mode is suitable for watching video.
- **Bright:** Maximum brightness from PC input.
- **DICOM SIM:** This mode can project a monochrome medical image such as an X ray radiography, MRI, etc.
- **Blending:** When using multiple projectors, this mode can eliminate the visible banding and create a single bright, high resolution image across the screen.
- **User:** Memorize user's settings.
- **Save to User:** Save the display mode settings in user profile.

### Brightness

Adjust the brightness of the image.

### Contrast

The contrast controls the degree of difference between the lightest and darkest parts of the picture.

# USING THE PROJECTOR

## **Sharpness**

Adjust the sharpness of the image.

## **Color**

Adjust a video image from black and white to fully saturated color.

## **Tint**

Adjust the color balance of red and green.

## **Phase**

Synchronize the signal timing of the display with the graphic card. If the image appears to be unstable or flickers, use this function to correct it.

## **Frequency**

Change the display data frequency to match the frequency of your computer's graphic card. Use this function only if the image appears flickering vertical lines.

## **Horz Position**

Move the image right or left within the area of available pixels.

## **Vert Position**

Move the image up or down within the area of available pixels.

## **Auto Image**

Force the projector to reacquire and lock to the input signal. This is useful when signal quality is marginal.

## **Color Matching**

Configure the color matching settings. Refer to "Color Matching menu" on page 31.

## **Advanced**

Configure the advanced image settings. Refer to "Advanced menu" on page 32.

# USING THE PROJECTOR

## Color Matching menu

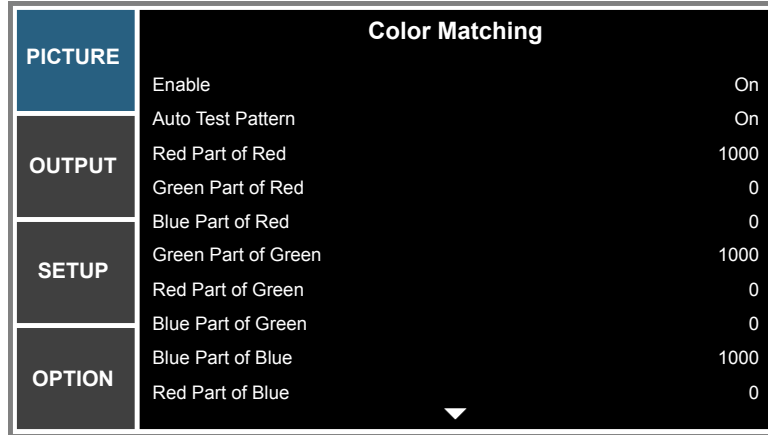

Color Matching		
PICTURE	Enable	On
	Auto Test Pattern	On
OUTPUT	Red Part of Red	1000
	Green Part of Red	0
	Blue Part of Red	0
SETUP	Green Part of Green	1000
	Red Part of Green	0
	Blue Part of Green	0
OPTION	Blue Part of Blue	1000
	Red Part of Blue	0

### **Enable**

You may require a unique color gamut (range) for a single projector or application, or you may need to precisely match colors across multiple adjacent displays. Enable this feature to allow color matching.

### **Auto Test Pattern**

Set to “On” to enable displaying an internal solid colored test pattern or set to “Off” to disable the auto test pattern.

### **Red Part of Red**

Adjust the intensity of the red color component in red color. This will also affect the hue of the color.

### **Green Part of Red**

Adjust the intensity of the green color component in red color. This will also affect the hue of the color.

### **Blue Part of Red**

Adjust the intensity of the blue color component in red color. This will also affect the hue of the color.

### **Green Part of Green**

Adjust the intensity of the green color component in green color. This will also affect the hue of the color.

### **Red Part of Green**

Adjust the intensity of the red color component in green color. This will also affect the hue of the color.

### **Blue Part of Green**

Adjust the intensity of the blue color component in green color. This will also affect the hue of the color.

### **Blue Part of Blue**

Adjust the intensity of the blue color component in blue color. This will also affect the hue of the color.

### **Red Part of Blue**

Adjust the intensity of the red color component in blue color. This will also affect the hue of the color.

### **Green Part of Blue**

Adjust the intensity of the green color component in blue color. This will also affect the hue of the color.

### **Red Part of White**

Adjust the intensity of the red color component in white color. This will also affect the hue of the color.

### **Green Part of White**

Adjust the intensity of the green color component in white color. This will also affect the hue of the color.

### **Blue Part of White**

Adjust the intensity of the blue color component in white color. This will also affect the hue of the color.

# USING THE PROJECTOR

## Reset to Default

Select “Yes” to reset all the color matching adjustments to the factory defaults or select “No” to keep the current values.

## Advanced menu

Advanced	
PICTURE	White Peaking 100
OUTPUT	Gamma Video
	Color Temperature Bright
SETUP	Color Space Auto
	Color Settings
OPTION	Color Enhancement 0
	Film Mode On
	Extreme Black On

## White Peaking

(Video source only) Increase the brightness of whites that are near 100%.

## Gamma

This allows you to set up gamma curve type. After the initial setup and fine tuning is completed, utilize the Gamma adjustment steps to optimize your image output.

- **Video:** for video or TV source.
- **Film:** for home theater.
- **Bright:** for emphasizing brightness.
- **CRT:** for CRT monitor.
- **DICOM:** for simulated DICOM.
- **Gamma 2.2:** for specific PC / photo source.

## Color Temperature

Select a color temperature from Warmest, Warm, Cool, or Bright.

## Color Space

Select an appropriate color matrix type from RGB, REC709, REC601, RGB Video, or Auto.

## Color Settings

Configure the brightness (gain) and contrast (offset) of an image.

- **Red Gain/Green Gain/Blue Gain/Red Offset/Green Offset/Blue Offset:** Adjust the gain of the red, green, or blue channel of the image. Adjust the offset of the red, green, or blue channel of the image. It will affect the black and white.
- **Reset RGB Gain/Offset:** Reset the gain and offset adjustments to the factory defaults.

## Color Enhancement

Apply the color enhancement process.



# USING THE PROJECTOR

## **Film Mode**

Control film mode detection and determine whether the original source of the input video was film or video.

**Note:** *This function is available for interlaced video signals.*

## **Extreme Black**

Contrast can be increased by a dark content. Select “On” to let the projector will automatically improvement contrast or select “Off” to disable this function.

# USING THE PROJECTOR

## OUTPUT menu

OUTPUT	
PICTURE	Aspect Ratio Auto
	Overscan Off
OUTPUT	H Digital Zoom 100
	V Digital Zoom 100
SETUP	H Digital Shift 50
	V Digital Shift 50
	Image Warping
	PIP/PBP
OPTION	

### Aspect Ratio

Choose your desired aspect ratio.

- **Auto:** Automatically selects the appropriate display format.
- **4:3:** This format is for 4:3 input sources.
- **16:10:** This format is for 16:10 aspect input sources, like HDTV and DVD enhanced for Wide screen TV.
- **Native:** This format displays the original image without any scaling.

### Overscan

Remove noise around the image.

### H Digital Zoom

Change the size of projector's display area horizontally. If the display area has been resized by this setting, it can be moved by changing the H Digital Shift and V Digital Shift settings.

### V Digital Zoom

Change the size of projector's display area vertically. If the display area has been resized by this setting, it can be moved by changing the H Digital Shift and V Digital Shift settings.

### H Digital Shift

Shift the display area horizontally if its size has been changed by the Digital Zoom setting.

### V Digital Shift

Shift the display area vertically if its size has been changed by the Digital Zoom setting.

### Image Warping

Configure the image warping settings. Refer to "Image Warping menu" on page 35.

### PIP/PBP

Configure the PIP/PBP settings. Refer to "PIP/PBP menu" on page 36.

# USING THE PROJECTOR

## Image Warping menu

Image Warping	
PICTURE	H Keystone 20 V Keystone 20
OUTPUT	H Pincushion 50 V Pincushion 50
SETUP	
OPTION	

### H Keystone

Adjust image distortion horizontally and make a squarer image. Horizontal keystone is used to correct a keystoneed image shape in which the left and right borders of the image are unequal in length. This is intended for use with horizontally on-axis applications.



### V Keystone

Adjust image distortion vertically and make a squarer image. Vertical keystone is used to correct a keystoneed image shape in which the top and bottom are slanted to one of the sides. This is intended when for use with vertically on-axis applications.

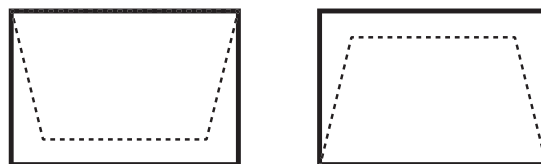

### H Pincushion

Adjust the pincushion horizontally and make a more square image.

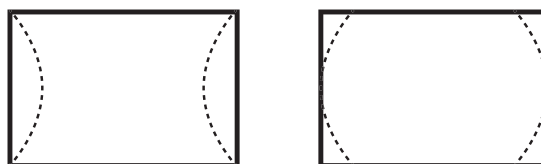

### V Pincushion

Adjust the pincushion vertically and make a more square image.

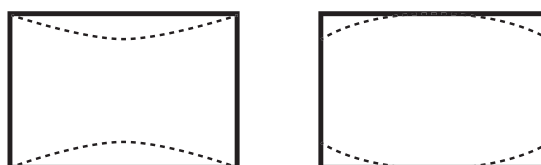

# USING THE PROJECTOR

## PIP/PBP menu

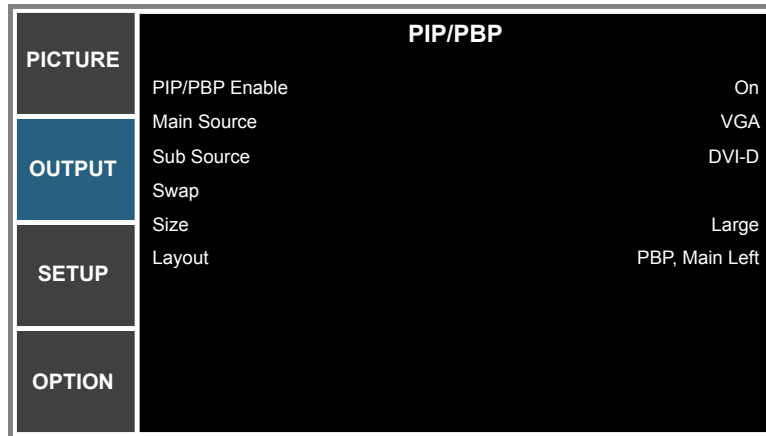

### PIP/PBP Enable

Toggle between displaying two sources at once (Main and PIP/PBP images) or one source only.

### Main Source

From the list of active inputs, select one to be used as the main image.

### Sub Source

From the list of active inputs, select one to be used as the sub image.

### Swap

Swap the sources of main window and PIP/PBP window.

### Size

Select the PIP/PBP size.

### Layout

Set the location of the PIP/PBP image on the screen.

## PIP/PBP Matrix

PIP/PBP compatibility table as described below:

PIP/PBP Matrix	HDMI	VGA	Component	HDBaseT	DVI-D
HDMI	—	—	—	—	V
VGA	—	—	—	—	V
Component	—	—	—	—	V
HDBaseT	—	—	—	—	V
DVI-D	V	V	V	V	—

### Note:

1. Flashing lines may occur if the bandwidth of both inputs are too high, please try to reduce the resolution.
2. Frame tearing may occur due to a difference in frame rate between the Main and the Sub picture, please try to match the frame rate for each input.

# USING THE PROJECTOR

PIP/PBP layout and size table as described below:

PIP/PBP Layout	PIP/PBP Size		
	Small	Medium	Large
PBP, Main Left			
PBP, Main Top			
PBP, Main Right			
PBP, Main Bottom			
PIP-Bottom Right			
PIP-Bottom Left			
PIP-Top Left			
PIP-Top Right			

# USING THE PROJECTOR

## SETUP menu

SETUP	
PICTURE	Language English
	Ceiling Mount Auto
OUTPUT	Rear Projection Off
	Lens Function
	Menu Preferences
SETUP	Keypad LED Settings On
	Pin
OPTION	Communications

### **Language**

Choose the multilingual OSD menu.

### **Ceiling Mount**

Turn the image upside down for ceiling-mounted projection.

### **Rear Projection**

Reverse the image so you can project from behind a translucent screen.

### **Lens Function**

Configure the lens function settings. Refer to “Lens Function menu” on page 39.

### **Menu Preferences**

Configure the menu preferences settings. Refer to “Menu Preferences menu” on page 40.

### **Keypad LED Settings**

Turn the backlight of keypad on or off.

### **Pin**

Configure the pin settings. Refer to “Pin menu” on page 40.

### **Communications**

Configure the communications settings. Refer to “Communications menu” on page 41.

# USING THE PROJECTOR

## Lens Function menu

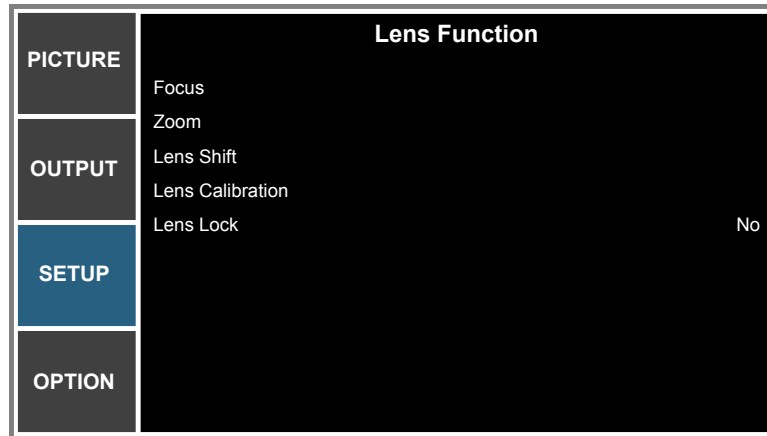

### **Focus**

Adjust focus function on the projected image.

### **Zoom**

Adjust zoom function on the projected image.

### **Lens Shift**

Shift the projected image.

### **Lens Calibration**

Perform calibration and return lens to the center position.

### **Lens Lock**

Select this function to prevent all lens motors from moving.

- **No:** Lens shift can be used by user.
- **Yes:** Lens shift will be locked.

# USING THE PROJECTOR

## Menu Preferences menu

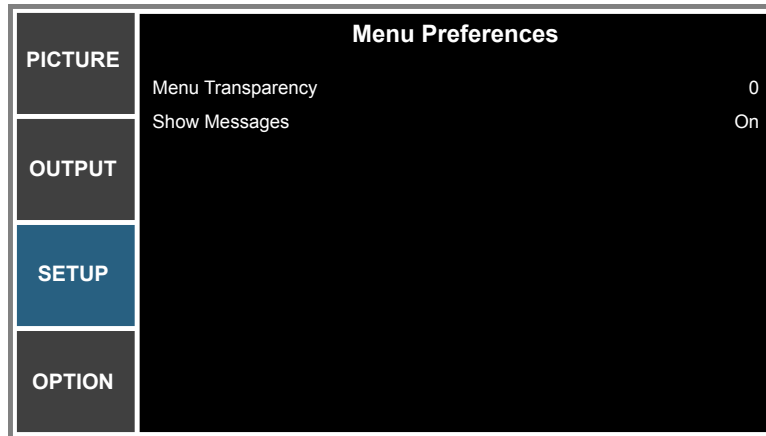

### Menu Transparency

Change OSD menu background to be transparent.

### Show Messages

Display status messages on the screen.

## Pin menu

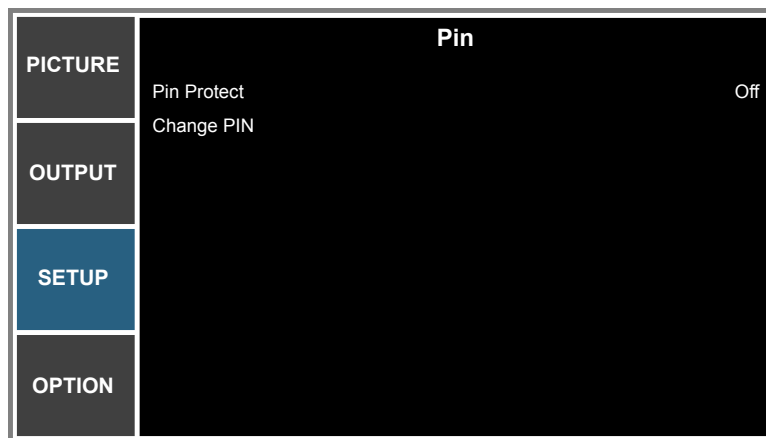

### Pin Protect

The PIN (personal identification number) feature allows you to password protect your projector. Once you enable the PIN feature, you must enter the PIN before you can project an image.

**Note:** The PIN default value is "12345".

### Change PIN

Change the PIN.



# USING THE PROJECTOR

## Communications menu

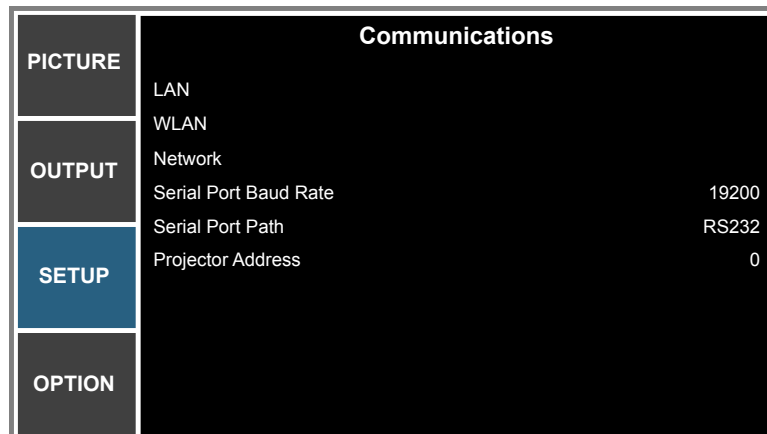

### LAN

Configure the local area network (LAN) settings.

- **DHCP:** Turn the DHCP ON/OFF.
- **IP Address:** Select an IP address.
- **Subnet Mask:** Select subnet mask number.
- **Default Gateway:** Select the default gateway of the network connected to the projector.
- **MAC Address:** Display the network MAC Address value.
- **Apply:** Apply Network settings.

### WLAN

Configure the wireless local area network (WLAN) settings.

- **Enable:** Enable/Disable WLAN.
- **Start IP:** Start of IP Address.
- **End IP:** End of IP Address.
- **Subnet Mask:** Assign Network Subnet Mask.
- **Default Gateway:** Assign Network Default Gateway.
- **MAC Address:** Display network MAC Address value.
- **SSID:** Assign Network Service Set Identifier.

### Network

Configure the general network settings.

- **Projector Name:** Display the projector hostname for Network.
- **Restart Network:** Restart the network.
- **Network Factory Reset:** Perform factory reset on the network settings. The Projector Name, LAN IP, WLAN IP, and SNMP settings will be reset

### Serial Port Baud Rate

Select the serial port and baud rate.

### Serial Port Path

Select the serial port path from either RS232 or HDBaseT.

# USING THE PROJECTOR

## Projector Address

Set the projector address. The projector will respond to IR remotes set either at the same address as the projector or to IR remotes set to address 0.

## How to use web browser to control your projector

1. Turn “On” the DHCP option on projector to allow a DHCP server to automatically assign an IP address.
2. Open the web browser in your PC and type in the projector’s IP address (“SETUP: Communications > LAN > IP Address”).

**Note:** The steps in this section is based on Windows 7 operating system.

## Making a direct connection from your computer to the projector\* (For Windows 7 or higher)

1. Turn “Off” the DHCP option on the projector.
2. Configure the IP address, Subnet Mask, and Gateway on projector. Refer to “Communications menu” on page 41.
3. Open **Network and Sharing Center** page on your PC, and assign the identical network parameters to your PC as set on projector. Click “OK” to save the parameters.

**Note:** The last group (ex: 100) of the IP address should be different from the projector. Make sure the network parameters (i.e. other groups of the IP address and the Subnet mask) are similar to those shown in the OSD menu.

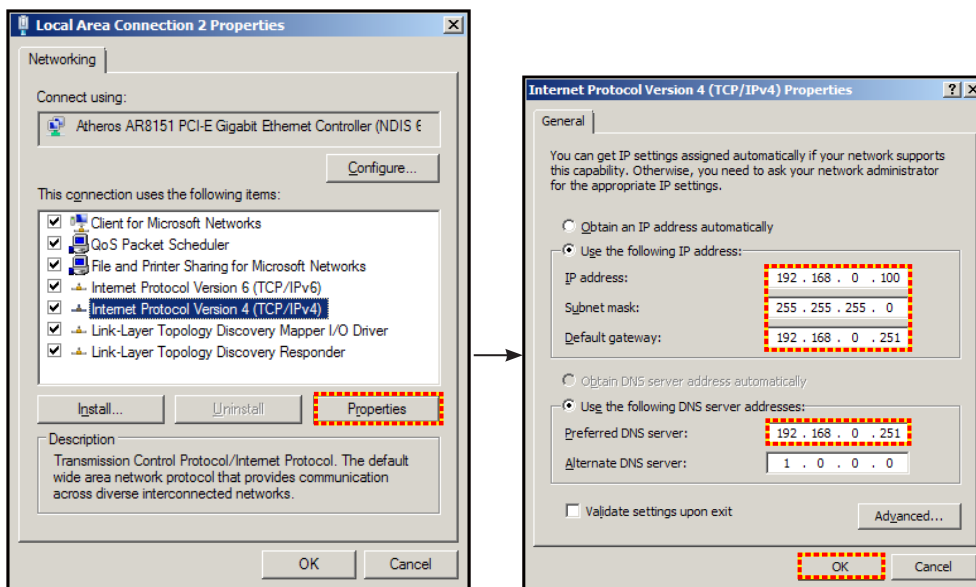

4. Open the web browser on your computer and type the projector IP address into the URL field, then press “Enter”.

# USING THE PROJECTOR

## Setup network control settings menu

### LAN\_RJ45 function

For simplicity and ease of operation, the projector provides diverse networking and remote management features. The LAN / RJ45 function of the projector through a network, such as remotely manage: Power On / Off, Brightness and Contrast settings. Also you can view the projector status information, such as: Video- Source, etc.

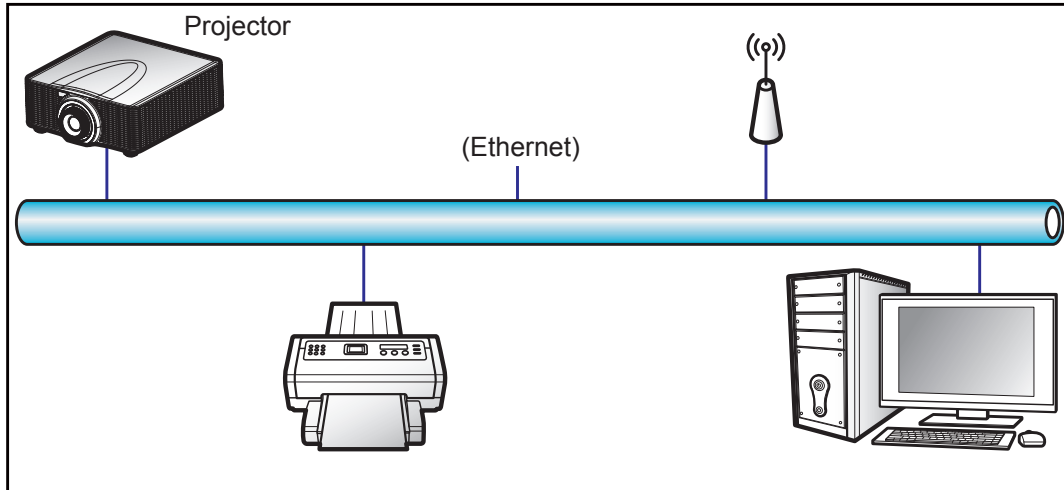

### Wired LAN terminal functionalities

This projector can be controlled by using a PC (laptop) or other external device via RJ-45 connector and compatible with Crestron / Extron / AMX (Device Discovery) / PJLink.

- Crestron is a registered trademark of Crestron Electronics, Inc. of the United States.
- Extron is a registered trademark of Extron Electronics, Inc. of the United States.
- AMX is a registered trademark of AMX LLC of the United States.
- PJLink applied for trademark and logo registration in Japan, the United States of America, and other countries by JBMIA.

The projector is supported by the specified commands of the Crestron Electronics controller and related software, for example RoomView®.

<http://www.crestron.com/>

This projector is compliant to support Extron device(s) for reference.

<http://www.extron.com/>

This projector is supported by AMX (Device Discovery).

<http://www.amx.com/>

This projector supports all commands of PJLink Class1 (Version 1.00).

<http://pjlink.jbmia.or.jp/english/>

For more detailed information about the various types of external devices which can be connected to the LAN / RJ45 port and remote control the projector, as well as the supported commands for these external devices, please contact the Support-Service directly.

# USING THE PROJECTOR

## LAN RJ45 (For Windows XP)

1. Connect an RJ45 cable to RJ-45 connector on the projector and the PC (laptop).

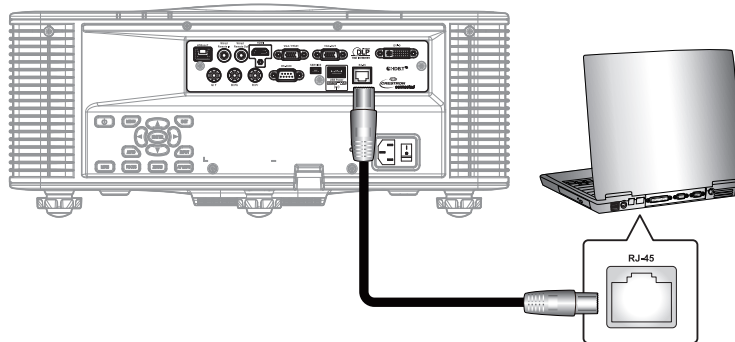

2. On the PC (Laptop), select **Start > Control Panel > Network Connections**.

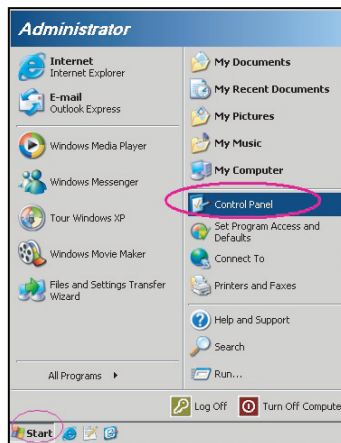

3. Right-click on the **Local Area Connection**, and select **Property**.

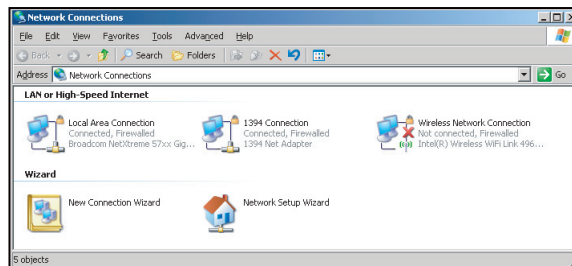

4. In the **Properties** window, select the **General tab**, and select **Internet Protocol (TCP / IP)**.

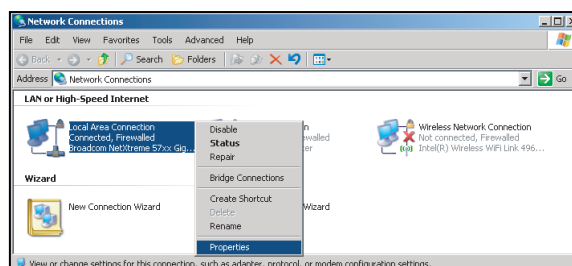

# USING THE PROJECTOR

5. Click “Properties”.

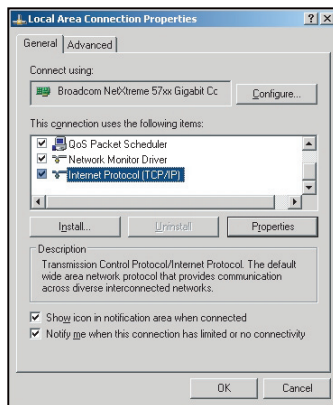

6. Type in the IP address and Subnet mask, then press “OK”.

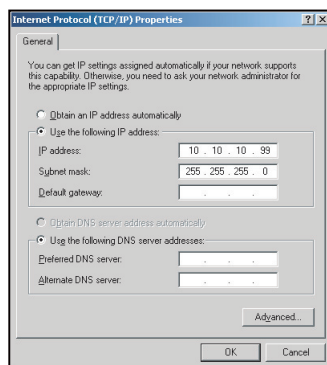

7. Press the “Menu” button on the projector.
8. Select **SETUP > Communications > LAN**.
9. Enter the following connection parameters:
  - DHCP: Off
  - IP Address: 10.10.10.10
  - Subnet Mask: 255.255.255.0
  - Default Gateway: 0.0.0.0
10. Press “Enter” to confirm settings.
11. Open a web browser, for example Microsoft Internet Explorer with Adobe Flash Player 9.0 or higher installed.
12. In the Address bar, input the projector’s IP address: 10.10.10.10.

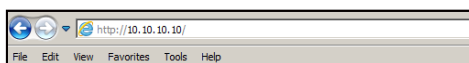

# USING THE PROJECTOR

- 13. Press "Enter".  
The projector is setup for remote management. The LAN / RJ45 function displays as follows:

Main page



Information page

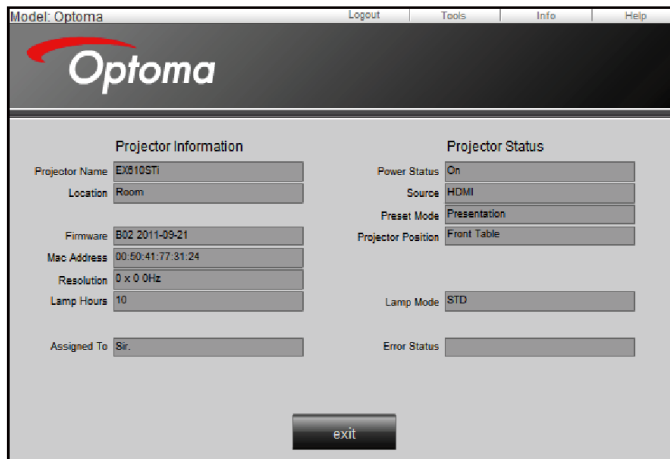

Tool page

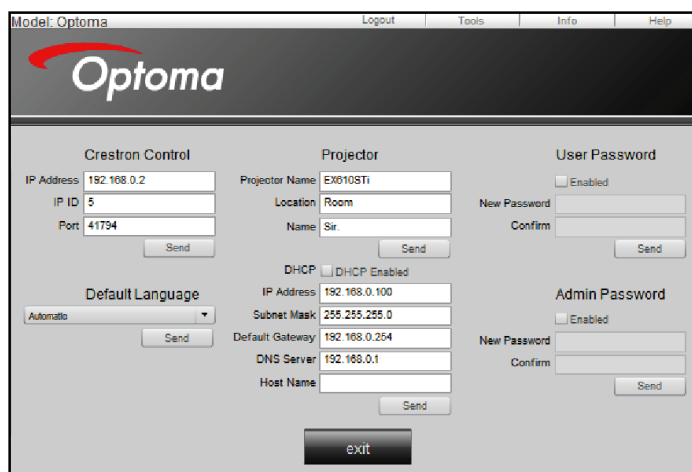

Contact IT helpdesk



# USING THE PROJECTOR

## RS232 by Telnet Function

There is alternative RS232 command control way, in projector so called “RS232 by TELNET” for LAN / RJ45 interface.

### Quick Start-Guide for “RS232 by Telnet”

- Check and get the IP address on OSD of the projector.
- Make sure that the PC / laptop can access the web-page of the projector.
- Make sure that “Windows Firewall” setting is set disabled in case of “TELNET” function filtering out by PC / laptop.

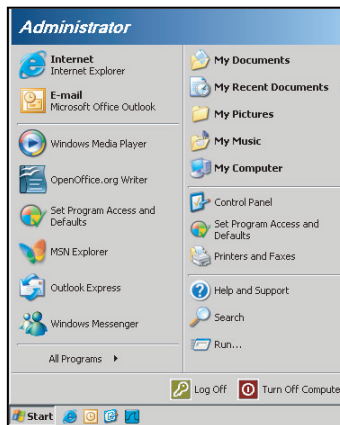

1. Select **Start > All Programs.> Accessories > Command Prompt.**

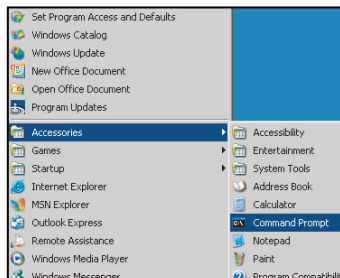

2. Input the command format as follows:
  - telnet ttt.xxx.yyy.zzz 3023 (“Enter” key pressed)
  - (ttt.xxx.yyy.zzz: IP-Address of the projector)
3. If Telnet-Connection ready, and user can have RS232 command input, then “Enter” key pressed, the RS232 command will be workable.

### Specification for “RS232 by TELNET”:

1. Telnet: TCP.
2. Telnet port: 3023 (for more detail, kindly please get contact with the service agent or team).
3. Telnet utility: Windows “TELNET.exe” (console mode).
4. Disconnection for RS232-by-Telnet control normally: Close
5. Windows Telnet utility directly after TELNET connection ready.
  - Limitation 1 for Telnet-Control: there is less than 50 bytes for successive network payload for Telnet-Control application.
  - Limitation 2 for Telnet-Control: there is less than 26 bytes for one complete RS232 command for Telnet-Control.
  - Limitation 3 for Telnet-Control: Minimum delay for next RS232 command must be more than 200 (ms).

# USING THE PROJECTOR

## OPTION menu

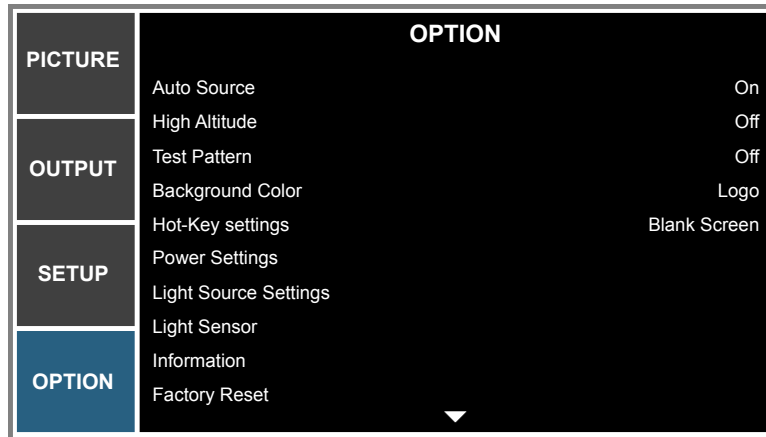

OPTION (1/2)

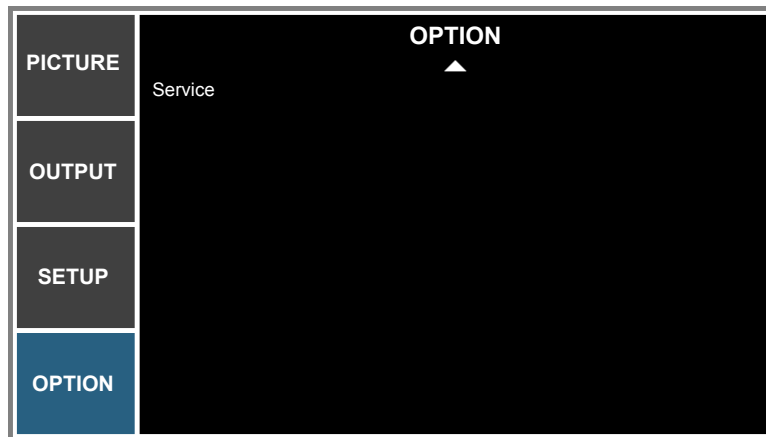

OPTION (2/2)

### **Auto Source**

Use this option to enable/disable input sources.

- **On:** The projector will search for other signals if the current input signal is lost.
- **Off:** The projector will only search current input connection.

### **High Altitude**

When “On” is selected, the fans will spin faster. This feature is useful in high altitude areas where the air is thin.

### **Test Pattern**

Display a test pattern or select “Off” to turn off a test pattern.

### **Background Color**

Use this feature to display a “Logo”, “Blue”, “Black”, or “White” screen when no signal is available.

### **Hot-Key settings**

Assign a different function to the hot-key on the remote control by highlighting the function in the list and pressing “Enter”. Choose a function that does not already have a dedicated button, and assign the hot-key to that function, allowing you to quickly and easily use the chosen function.

### **Power Settings**

Configure the power settings. Refer to “Power Settings menu” on page 50.



# USING THE PROJECTOR

## Light Source Settings

Configure the light source settings. Refer to “Light Source Settings menu” on page 51.

## Light Sensor

- **Light Sensor Calibration:** Calibrate the Light Sensor for use with the Constant Luminance mode, which allows the projector to be set for constant brightness. If the Light Sensor has not been calibrated, Constant Luminance mode will be disabled.
- **Calibrated:**
  - **Yes:** Light Sensor has been calibrated.
  - **No:** Light Sensor has not been calibrated.

## Information

Display the projector information for source, resolution, and software version on the screen.

## Factory Reset

Restore all settings to their default value. It will not reset network.

## Service

Service only.

# USING THE PROJECTOR

## Power Settings menu

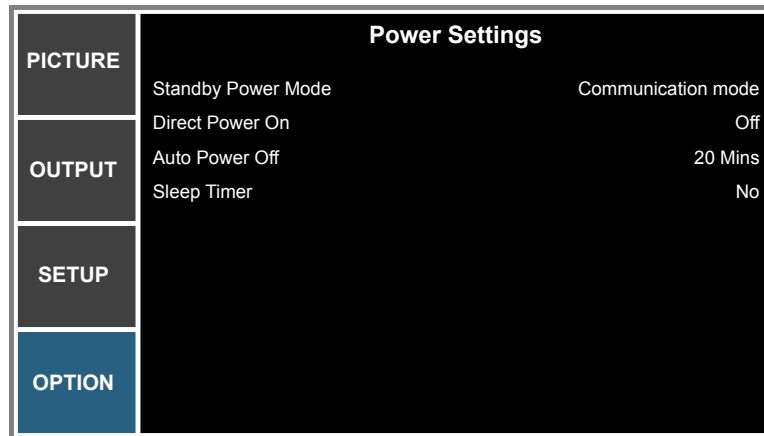



### Standby Power Mode

Set the standby power mode setting.

- **0.5W mode:** The projector is in standby mode when connected to AC power. (<0.5W)
- **Communication mode:** The projector could be controlled via the LAN terminal during power standby.

### Direct Power On

Choose “On” to activate Direct Power mode. The projector will automatically power on when AC power is supplied, without pressing “” on the remote control or press “” on the projector keypad.

### Auto Power Off

Set the countdown timer interval. The countdown timer will start, when there is no signal being sent to the projector. The projector will automatically power off when the countdown has finished (in minutes). The default setting is 20 minutes.

### Sleep Timer

Sets the countdown timer interval. The countdown timer will start, with or without a signal being sent to the projector. The projector will automatically power off when the countdown has finished.

**Note:** The value of sleep timer will be reset to zero after the projector is powered off.

# USING THE PROJECTOR

## Light Source Settings menu

Light Source Settings	
PICTURE	Light Source Mode Constant Power
OUTPUT	Constant Power Settings 0
	Constant Luminance Settings 0
SETUP	Total Projector Hours 11
OPTION	

### Light Source Mode

Set the light source mode setting. When “Eco Mode” is selected, the projector will adjust to the lowest fan speed and switch the laser diode power to the minimum setting.

### Constant Power Settings

Set the value of the laser diode power (in Watts).

### Constant Luminance Settings

Set the value for the Constant Luminance Settings to maintain constant brightness. The light sensor will monitor the light level and will apply more power as the laser brightness decays naturally over time. When the laser setting reaches maximum power, it will remain at this setting.

**Note:** *The light sensor needs to be calibrated for Constant Luminance mode to work properly.*

### Total Projector Hours

Display the projection time.

# ADDITIONAL INFORMATION

## Compatible resolutions

Timing Table

Signal Type	Resolution	Frame rate (Hz)	HDMI	HDBaseT	DVI	VGA	Component
PC	800x600	60	V	V	V	V	—
	800x600	72	V	V	V	V	—
	800x600	75	V	V	V	V	—
	832x624	75	V	V	V	V	—
	1024x768	60	V	V	V	V	—
	1024x768	75	V	V	V	V	—
	1152x870	75	V	V	V	V	—
	1280x800	75	V	V	V	V	—
	1280x1024	60	V	V	V	V	—
	1280x1024	75	V	V	V	V	—
	1400x1050	60	V	V	V	V	—
	1440x900	60	V	V	V	V	—
	1440x900	75	V	V	V	—	—
	1600x1200	60	V	V	V	V	—
	1680x1050	60	V	V	V	V	—
	1920X1080	50	V	V	V	—	—
	1920X1080	60	V	V	V	V	—
1920X1200RB	60	V	V	V	V	—	
SDTV	480i	60	V	V	V	V	V
	576i	50	V	V	V	V	V
EDTV	480p	60	V	V	V	V	V
	576p	50	V	V	V	V	V
HDTV	1080i	30	V	V	V	V	V
	720p	50	V	V	V	V	V
	720p	60	V	V	V	V	V
	1080p	24	V	V	V	V	V
	1080p	50	V	V	V	V	V
	1080p	60	V	V	V	V	V

**Note:** "RB" means "reduced blanking".

# ADDITIONAL INFORMATION

## EDID Table

OPTOMA	WUXGA	EDID Table
<b>Digital</b>		
Established Timing:	Standard Timing:	Detail Timing:
720 x 400 @ 70 Hz	1440 x 900 @ 75Hz	1920 x 1200 @ 60Hz
720 x 400 @ 88 Hz	1280 x 800 @ 75Hz	1920 X 1080 @ 60Hz
640 x 480 @ 60 Hz	1280 x 1024 @ 60Hz	1280 x720P @ 60Hz
640 x 480 @ 67 Hz	1360 x 765 @ 60Hz	1920 x 1080i @ 60Hz
640 x 480 @ 72 Hz	1440 x 900 @ 60Hz	1920 x 1080i @ 50Hz
640 x 480 @ 75 Hz	1400 x 1050 @ 60Hz	720 x 480p @ 60Hz
800 x 600 @ 56 Hz	1600 x 1200@ 60Hz	720 x 576p @ 50Hz
800 x 600 @ 60 Hz	1680 x 1050@ 60Hz	
800 x 600 @ 72 Hz		
800 x 600 @ 75 Hz		
832 x 624 @ 75 Hz		
1024 x 768 @ 60 Hz		
1024 x 768 @ 70 Hz		
1024 x 768 @ 75 Hz		
1280 x 1024 @ 75 Hz		
1152 x 870 @ 75 Hz		
<b>Analog</b>		
Established Timing:	Standard Timing:	Detail Timing:
720 x 400 @ 70 Hz	1440 x 900 @ 75Hz	1920 x 1200 @ 60Hz
720 x 400 @ 88 Hz	1280 x 800 @ 75Hz	1920 X 1080 @ 60Hz
640 x 480 @ 60 Hz	1280 x 1024 @ 60Hz	
640 x 480 @ 67 Hz	1360 x 765 @ 60Hz	
640 x 480 @ 72 Hz	1440 x 900 @ 60Hz	
640 x 480 @ 75 Hz	1400 x 1050 @ 60Hz	
800 x 600 @ 56 Hz	1600 x 1200@ 60Hz	
800 x 600 @ 60 Hz	1680 x 1050@ 60Hz	
800 x 600 @ 72 Hz		
800 x 600 @ 75 Hz		
832 x 624 @ 75 Hz		
1024 x 768 @ 60 Hz		
1024 x 768 @ 70 Hz		
1024 x 768 @ 75 Hz		
1280 x 1024 @ 75 Hz		
1152 x 870 @ 75 Hz		

# ADDITIONAL INFORMATION

## Image size and projection distance

Platform			WUXGA (16:10)									
DMD			0.67"									
Projection Lens			A01		A02		A03		A13		A15	
			Wide Zoom		Standard		Long Zoom		Ultra-Long Zoom		Short Throw	
Throw Ratio			0.95-1.22		1.22-1.53		1.53-2.92		2.90-5.50		0.75-0.95	
Zoom Ratio			1.28X		1.25X		1.9X		1.9X		1.26X	
Throw Distance			1.03~7.88m		1.32~9.88m		1.65~18.86m		3.13~35.53m		0.81-6.14m	
Projection screen size			Projection distance (m)									
Throw Ratio			0.95	1.22	1.22	1.53	1.53	2.92	2.9	5.5	0.75	0.95
Diagonal (inch)	Height (m)	Width (m)	Min (m)	Max (m)	Min (m)	Max (m)	Min (m)	Max (m)	Min (m)	Max (m)	Min (m)	Max (m)
50	0.67	1.08	1.03	1.32	1.32	1.65	1.65	3.15	3.13	5.94	0.81	1.03
60	0.81	1.29	1.23	1.57	1.57	1.97	1.97	3.77	3.74	7.10	0.97	1.23
70	0.94	1.51	1.43	1.84	1.84	2.31	2.31	4.41	4.38	8.31	1.13	1.43
80	1.08	1.72	1.63	2.10	2.10	2.63	2.63	5.02	4.99	9.46	1.29	1.63
90	1.21	1.94	1.84	2.37	2.37	2.97	2.97	5.66	5.63	10.67	1.46	1.84
100	1.35	2.15	2.04	2.62	2.62	3.29	3.29	6.28	6.24	11.83	1.61	2.04
110	1.48	2.37	2.25	2.89	2.89	3.63	3.63	6.92	6.87	13.04	1.78	2.25
120	1.62	2.58	2.45	3.15	3.15	3.95	3.95	7.53	7.48	14.19	1.94	2.45
130	1.75	2.8	2.66	3.42	3.42	4.28	4.28	8.18	8.12	15.40	2.10	2.66
140	1.88	3.02	2.87	3.68	3.68	4.62	4.62	8.82	8.76	16.61	2.27	2.87
150	2.02	3.23	3.07	3.94	3.94	4.94	4.94	9.43	9.37	17.77	2.42	3.07
160	2.15	3.45	3.28	4.21	4.21	5.28	5.28	10.07	10.01	18.98	2.59	3.28
170	2.29	3.66	3.48	4.47	4.47	5.60	5.60	10.69	10.61	20.13	2.75	3.48
180	2.42	3.88	3.69	4.73	4.73	5.94	5.94	11.33	11.25	21.34	2.91	3.69
190	2.56	4.09	3.89	4.99	4.99	6.26	6.26	11.94	11.86	22.50	3.07	3.89
200	2.69	4.31	4.09	5.26	5.26	6.59	6.59	12.59	12.50	23.71	3.23	4.09
250	3.37	5.38	5.11	6.56	6.56	8.23	8.23	15.71	15.60	29.59	4.04	5.11
300	4.04	6.46	6.14	7.88	7.88	9.88	9.88	18.86	18.73	35.53	4.85	6.14

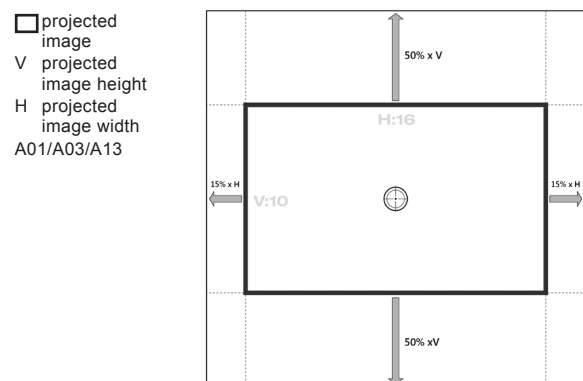
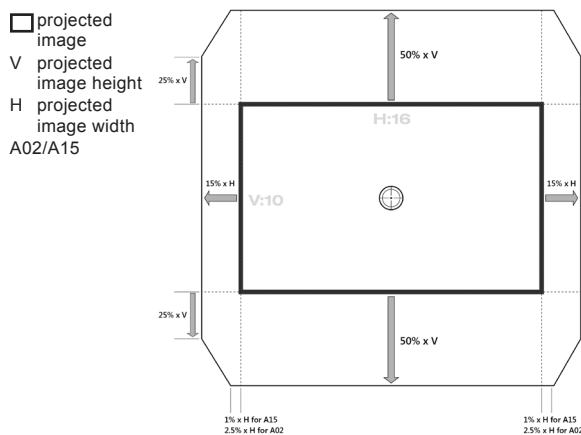

# ADDITIONAL INFORMATION

## Projector dimensions and ceiling mount installation

1. To prevent damage to your projector, please use the Optoma ceiling mount.
2. If you wish to use a third party ceiling mount kit, please ensure the screws used to attach a mount to the projector meet the following specifications:
  - Screw type: M6 x 4
  - Minimum screw length: 20mm

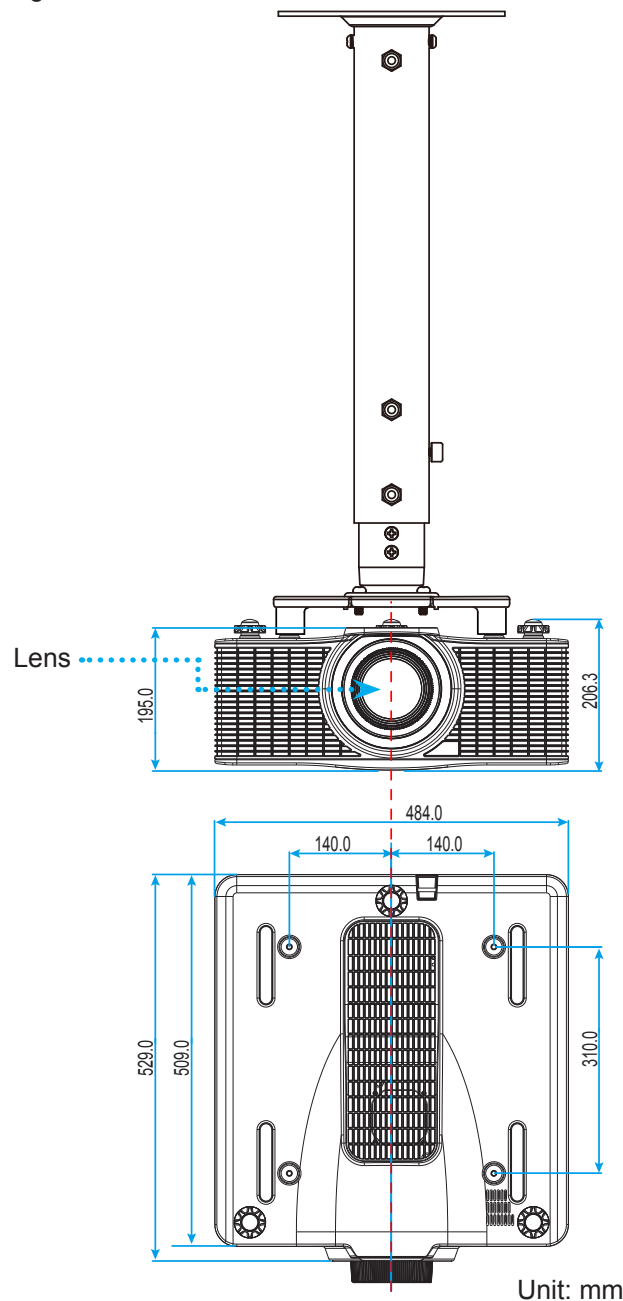

**Note:** Please note that damage resulting from incorrect installation will void the warranty.



Warning:

- If you buy a ceiling mount from another company, please be sure to use the correct screw size. Screw size will vary depending on the thickness of the mounting plate.
- Be sure to keep at least 30mm (3cm) gap between the ceiling and the bottom of the projector.
- Avoid installing the projector near a heat source.

# ADDITIONAL INFORMATION

## IR remote codes



Key Legend	Key Position	Repeat Format	Address		Data		Description
			Byte 1	Byte 2	Byte 3	Byte 4	
ON (🟢)	1	F1	32	CD	02	FD	Press to turn on the projector.
OFF (🔴)	2	F1	32	CD	2E	D1	Press to turn off the projector.
1	3	F1	32	CD	72	8D	Use as numeric keypad number "1".
2	4	F1	32	CD	73	8C	Use as numeric keypad number "2".
3	5	F1	32	CD	74	8B	Use as numeric keypad number "3".
4	6	F1	32	CD	75	8A	Use as numeric keypad number "4".
5	7	F1	32	CD	77	88	Use as numeric keypad number "5".



# ADDITIONAL INFORMATION

Key Legend	Key Position	Repeat Format	Address		Data		Description
			Byte 1	Byte 2	Byte 3	Byte 4	
6	8	F1	32	CD	78	87	Use as numeric keypad number "6".
7	9	F1	32	CD	79	86	Use as numeric keypad number "7".
8	10	F1	32	CD	80	7F	Use as numeric keypad number "8".
9	11	F1	32	CD	81	7E	Use as numeric keypad number "9".
Info	12	F1	32	CD	82	7D	Press to display source image information.
0	13	F1	32	CD	25	DA	Use as numeric keypad number "0".
Mode	14	F1	32	CD	05	FA	Press to select the preset display mode.
Auto	15	F1	32	CD	04	FB	Press to automatically synchronize the projector to the input source.
Input	16	F1	32	CD	18	E7	Press to select an input signal.
UP (▲)	17	F1	32	CD	0F	F0	Press to select items or make adjustments to our selection.
LEFT (◀)	18	F1	32	CD	11	EE	Press to select items or make adjustments to our selection.
Enter	19	F1	32	CD	14	EB	Press to confirm your item selection.
RIGHT (▶)	20	F1	32	CD	10	EF	Press to select items or make adjustments to our selection.
DOWN (▼)	21	F1	32	CD	12	ED	Press to select items or make adjustments to our selection.
Menu	22	F1	32	CD	0E	F1	Press to display the on-screen display menus for projector.
Exit	23	F1	32	CD	2A	D5	Press to return to previous level or exit menus if at top level.
Gamma	24	F1	32	CD	2B	D4	Press to adjust mid-range levels..
Bright	25	F1	32	CD	28	D7	Press to adjust amount of light in the image.
Cont.	26	F1	32	CD	29	D6	Press to adjust difference between dark and light.
PIP	27	F1	32	CD	43	BC	Press to turn on/off the PIP/PBP function.
Lens H ◀	28	F1	32	CD	41	BE	Press to adjust the position of the image horizontally.
Lens H ▶	29	F1	32	CD	42	BD	
Focus ▲	30	F1	32	CD	86	79	Press to adjust focus to improve image clarity as desired.
Lens V ▲	31	F1	32	CD	34	CB	Press to adjust the position of the image vertically.
Lens V ▼	32	F1	32	CD	32	CD	Press to adjust the position of the image vertically.
Focus ▼	33	F1	32	CD	26	D9	Press to adjust focus to improve image clarity as desired.
Keystone ▽	34	F1	32	CD	87	78	Press to adjust the vertical keystone.
Keystone ▽	35	F1	32	CD	51	AE	Press to adjust the vertical keystone.
Zoom ▲	36	F1	32	CD	52	AD	Press to adjust zoom to achieve a desired image size.

# ADDITIONAL INFORMATION







Key Legend	Key Position	Repeat Format	Address		Data		Description
			Byte 1	Byte 2	Byte 3	Byte 4	
Keystone ◻	37	F1	32	CD	53	AC	Press to adjust the horizontal keystone.
Keystone ◻	38	F1	32	CD	54	AB	Press to adjust the horizontal keystone.
Zoom ▼	39	F1	32	CD	55	AA	Press to adjust zoom to achieve a desired image size.
Shutter (AV Mute)	40	F1	32	CD	56	A9	Press to hide/unhide the screen picture.
Hot Key	41	F1	32	CD	57	A8	Press to select your preset keys quickly.
Pattern	42	F1	32	CD	58	A7	Press to display a test pattern.

# ADDITIONAL INFORMATION

## Troubleshooting

If you experience a problem with your projector, please refer to the following information. If a problem persists, please contact your local reseller or service center.

### Image problems

-  *No image appears on-screen*
- Ensure all the cables and power connections are correctly and securely connected as described in the "Installation" section.
  - Ensure the pins of connectors are not crooked or broken.
  - Ensure that the "Shutter (AV Mute)" feature is not turned on.
-  *Image is out of focus*
- Press the **Focus ▲** or **Focus ▼** button on the remote control to adjust the focus until the image is sharp and legible.
  - Make sure the projection screen is between the required distance from the projector. (Please refer to page 54).
-  *The image is stretched when displaying 16:10 DVD title*
- When you play anamorphic DVD or 16:10 DVD, the projector will show the best image in 16:10 format on projector side.
  - If you play 4:3 format DVD title, please change the format as 4:3 in projector OSD.
  - Please setup the display format as 16:10 (wide) aspect ratio type on your DVD player.
-  *Image is too small or too large*
- Press the **Zoom ▲** or **Zoom ▼** button on the remote control to increase or decrease the projected image size.
  - Move the projector closer to or further from the screen.
  - Press "Menu" on the projector panel, go to "OUTPUT-->Aspect Ratio". Try the different settings.
-  *Image has slanted sides:*
- If possible, reposition the projector so that it is centered on the screen and below the bottom of the screen.
  - Use "OUTPUT-->Image Warping-->V Keystone" from the OSD to make an adjustment.
-  *Image is reversed*
- Select "SETUP-->Rear Projection-->On" from the OSD to reverse the image so you can project from behind a translucent screen.

# ADDITIONAL INFORMATION

## Other problems



*The projector stops responding to all controls*

- If possible, turn off the projector, then unplug the power cord and wait at least 20 seconds before reconnecting power.

## Remote control problems



*If the remote control does not work*

- Check the operating angle of the remote control is pointed within  $\pm 30^\circ$  (horizontally or vertically) to the IR receivers on the projector.
- Make sure there are not any obstructions between the remote control and the projector. Move to within 10 m (32.8 ft) of the projector.
- Make sure batteries are inserted correctly.
- Replace batteries if they are exhausted.

# ADDITIONAL INFORMATION

## Warning indicators

### LED status indicators

The LED status indicators are located on the rear of the projector. Each LED is defined below.

LED Type	LED Status	Projector State
Light LED	Off	Laser diode is off
	Solid Orange	Laser diode time has expired
	Solid Green	Laser diode is on and operating correctly
	Flashing Red	When projector has lost over 60% initial luminance
Status LED	Off	AC power is off (without AC plug in)
	Off	AC has been applied, projector is in standby mode <b>Note:</b> Status LED cannot be flashing red, as this is reserved for an error condition. Status LED is off but keypad LED will indicate Standby Mode.
	Solid Green	Projector is powered up and operating normally
	Flashing Green	Projector communications
	Flashing Orange	Projector is in cool down mode or startup mode
	Flashing (alternating) Green/Orange	Projector is in flash update state
	Solid Red	Over temperature and projector will automatically shut down
	Flashing Red	Fan failure and projector will automatically shut down
AV Mute	Solid Green	Light is on - image is displayed
	Solid Orange	Light is on - image is blank

- Power off:

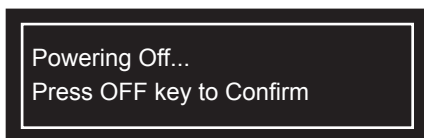

- Light power impact due to high ambient temperature:

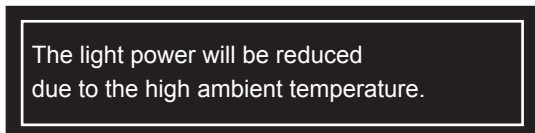

- DMD life time impact due to high ambient temperature:

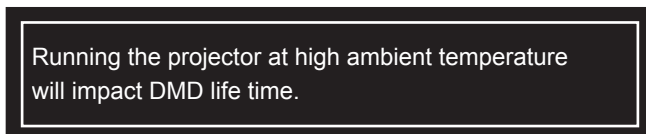

# ADDITIONAL INFORMATION

LAN Control Setting:

LAN Control	Port
AMX	9131
Crestron	41794
PJ-Link	4352
Telnet	23
Http	80

# ADDITIONAL INFORMATION

## Specifications

Optical	Description
Resolution	WUXGA (1920x1200)
Lens	Power Zoom/Focus
Laser Diode	400W Laser Diode @ Normal operation 240W Laser Diode @ ECO operation
Image size (diagonal)	50~300"
Projection distance	Please refer to "Image size and projection distance" table on page 54

Electrical	Description
Inputs	1 x HDMI (version1.4) (with locking screw) 1 x DVI-D (only support digital signal) 1 x VGA (D-Sub 15pin) (Computer In) 1 x HDBaseT 1 x Component(Y/Pb/Pr)
Outputs	1 x VGA Out (Support VGA loops through to monitor) (Monitor Out)
Control port	1 x RS232 (D-sub 9 pin) (PC Control) 1 x Wired in (3.5mm phone jack) (Remote In) 1 x Wired out (3.5mm phone jack) (Remote Out) 1 x USB type A (for WiFi dongle purpose) 1 x Mini USB (for LAN FW upgrade only) (Service) 1 x RJ45 (LAN)
Power requirement	AC 100V - 240V, 50/60Hz
Input current	6.5A - 2.5A

Mechanical	Description
Installation orientation	Table Top, Ceiling Mount, Portrait
Dimensions	484 (W) x 509 (D) x 185 (H) mm (without lens, w/o elevators)
Weight	18.5 kg
Environmental conditions	Operating: 5~40°C (>35°C, auto dim to 75% normal mode), 10~85%RH, non-condensing

**Note:** All specifications are subject to change without notice.



# ADDITIONAL INFORMATION

## Optoma global offices

For service or support, please contact your local office.



### USA

3178 Laurelview Ct.  
Fremont, CA 94538, USA  
www.optomausa.com

 888-289-6786  
 510-897-8601  
 [services@optoma.com](mailto:services@optoma.com)



### Canada

3178 Laurelview Ct.  
Fremont, CA 94538, USA  
www.optomausa.com

 888-289-6786  
 510-897-8601  
 [services@optoma.com](mailto:services@optoma.com)

### Latin America

3178 Laurelview Ct.  
Fremont, CA 94538, USA  
www.optomausa.com

 888-289-6786  
 510-897-8601  
 [services@optoma.com](mailto:services@optoma.com)



### Europe

42 Caxton Way, The Watford Business Park  
Watford, Hertfordshire,  
WD18 8QZ, UK  
www.optoma.eu  
Service Tel : +44 (0)1923 691865

 +44 (0) 1923 691 800  
 +44 (0) 1923 691 888  
 [service@tsc-europe.com](mailto:service@tsc-europe.com)



### Benelux BV

Randstad 22-123  
1316 BW Almere  
The Netherlands  
www.optoma.nl

 +31 (0) 36 820 0252  
 +31 (0) 36 548 9052



### France

Bâtiment E  
81-83 avenue Edouard Vaillant  
92100 Boulogne Billancourt, France

 +33 1 41 46 12 20  
 +33 1 41 46 94 35  
 [savoptoma@optoma.fr](mailto:savoptoma@optoma.fr)



### Spain

C/ José Hierro,36 Of. 1C  
28522 Rivas VaciaMadrid,  
Spain

 +34 91 499 06 06  
 +34 91 670 08 32



### Deutschland

Wiesenstrasse 21 W  
D40549 Düsseldorf,  
Germany

 +49 (0) 211 506 6670  
 +49 (0) 211 506 66799  
 [info@optoma.de](mailto:info@optoma.de)

### Scandinavia



Lerpeveien 25  
3040 Drammen  
Norway

 +47 32 98 89 90  
 +47 32 98 89 99  
 [info@optoma.no](mailto:info@optoma.no)

PO.BOX 9515  
3038 Drammen  
Norway

### Korea

WOOMI TECH.CO.,LTD.  
4F, Minu Bldg.33-14, Kangnam-Ku,  
Seoul,135-815, KOREA  
korea.optoma.com

 +82+2+34430004  
 +82+2+34430005



### Japan

東京都足立区綾瀬3-25-18  
株式会社オーエス  
コンタクトセンター:0120-380-495

 [info@os-worldwide.com](mailto:info@os-worldwide.com)  
[www.os-worldwide.com](http://www.os-worldwide.com)



### Taiwan

12F., No.213, Sec. 3, Beixin Rd.,  
Xindian Dist., New Taipei City 231,  
Taiwan, R.O.C.  
www.optoma.com.tw

 +886-2-8911-8600  
 +886-2-8911-6550  
 [services@optoma.com.tw](mailto:services@optoma.com.tw)  
[asia.optoma.com](http://asia.optoma.com)



### Hong Kong

Unit A, 27/F Dragon Centre,  
79 Wing Hong Street,  
Cheung Sha Wan,  
Kowloon, Hong Kong

 +852-2396-8968  
 +852-2370-1222  
[www.optoma.com.hk](http://www.optoma.com.hk)

### China

5F, No. 1205, Kaixuan Rd.,  
Changning District  
Shanghai, 200052, China

 +86-21-62947376  
 +86-21-62947375  
[www.optoma.com.cn](http://www.optoma.com.cn)



