



DLP® Projector

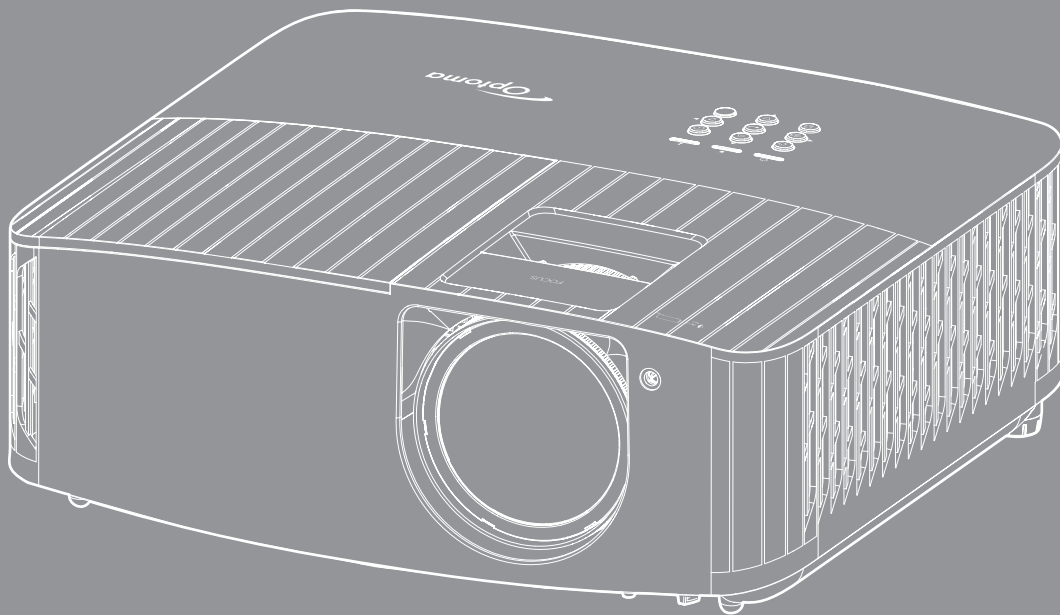

TABLE OF CONTENTS

SAFETY	4
<i>Important Safety Instruction</i>	4
<i>Cleaning the Lens</i>	5
<i>3D Safety Information</i>	6
<i>Copyright</i>	6
<i>Disclaimer</i>	7
<i>Trademark Recognition</i>	7
<i>FCC</i>	7
<i>Declaration of Conformity for EU countries</i>	8
<i>WEEE</i>	8
INTRODUCTION	9
<i>Package Overview</i>	9
<i>Standard accessories</i>	9
<i>Optional accessories</i>	9
<i>Product Overview</i>	10
<i>Connections</i>	11
<i>Keypad</i>	12
<i>Remote control</i>	13
SETUP AND INSTALLATION	14
<i>Installing the projector</i>	14
<i>Connecting sources to the projector</i>	15
<i>Adjusting the projector image</i>	16
<i>Remote setup</i>	17
USING THE PROJECTOR	19
<i>Powering on / off the projector</i>	19
<i>Selecting an input source</i>	21
<i>Menu navigation and features</i>	22
<i>OSD Menu tree</i>	23
<i>Display menu</i>	30
<i>Audio menu</i>	35
<i>Setup menu</i>	36
<i>Info menu</i>	39

ADDITIONAL INFORMATION..... 40

<i>Compatible resolutions</i>	40
<i>Image size and projection distance</i>	44
<i>Projector dimensions and ceiling mount installation</i>	45
<i>IR remote codes</i>	46
<i>Troubleshooting</i>	48
<i>Warning indicators</i>	49
<i>Specifications</i>	52
<i>Optoma global offices</i>	53

SAFETY

	The lightning flash with arrow head within an equilateral triangle is intended to alert the user to the presence of uninsulated "dangerous voltage" within the product's enclosure that may be of sufficient magnitude to constitute a risk of electric shock to persons.
	The exclamation point within an equilateral triangle is intended to alert the user to the presence of important operating and maintenance (servicing) instructions in the literature accompanying the appliance.

Please follow all warnings, precautions and maintenance as recommended in this user's guide.



To avoid electric shock, the unit and its peripherals must be properly grounded (earthed).

Important Safety Instruction

- To prolong the effective life of the lamp, make sure to keep the lamp on for at least 60 seconds and avoid performing force shutdown.



- Do not stare into the beam, RG2.
As with any bright source, do not stare into the direct beam, RG2 IEC 62471-5:2015.
- Do not block any ventilation openings. To ensure reliable operation of the projector and to protect from over heating, it is recommended to install the projector in a location that does not block ventilation. As an example, do not place the projector on a crowded coffee table, sofa, bed, etc. Do not put the projector in an enclosure such as a book case or a cabinet that restricts air flow.
- To reduce the risk of fire and/or electric shock, do not expose the projector to rain or moisture. Do not install near heat sources such as radiators, heaters, stoves or any other apparatus such as amplifiers that emits heat.
- Do not let objects or liquids enter the projector. They may touch dangerous voltage points and short out parts that could result in fire or electric shock.
- Do not use under the following conditions:
 - In extremely hot, cold or humid environments.
 - (i) Ensure that the ambient room temperature is within 5°C ~ 40°C
 - (ii) Relative humidity is 10% ~ 85%
 - In areas susceptible to excessive dust and dirt.
 - Near any appliance generating a strong magnetic field.
 - In direct sunlight.
- Do not use the projector in places where flammable gases or explosives gases may be present in the atmosphere. The lamp inside the projector becomes very hot during operation and the gases may ignite and result in a fire.
- Do not use the unit if it has been physically damaged or abused. Physical damage/abuse would be (but not limited to):
 - Unit has been dropped.
 - Power supply cord or plug has been damaged.

- Liquid has been spilled on to the projector.
- Projector has been exposed to rain or moisture.
- Something has fallen in the projector or something is loose inside.
- Do not place the projector on an unstable surface. The projector may fall over resulting in injury or the projector may become damaged.
- Do not block the light coming out of the projector lens when in operation. The light will heat the object and could melt, cause burns or start a fire.
- Please do not open or disassemble the projector as this may cause electric shock.
- Do not attempt to service the unit yourself. Opening or removing covers may expose you to dangerous voltages or other hazards. Please call Optoma before you send the unit for repair.
- See projector enclosure for safety related markings.
- The unit should only be repaired by appropriate service personnel.
- Only use attachments/accessories specified by the manufacturer.
- Do not look into straight into the projector lens during operation. The bright light may harm your eyes.
- This projector will detect the life of the lamp itself. Please be sure to change the lamp when it shows warning messages.
- Reset the "Lamp Reset" function from the on-screen display "Lamp Settings" menu after replacing the lamp module.
- When switching the projector off, please ensure the cooling cycle has been completed before disconnecting power. Allow 90 seconds for the projector to cool down.
- When the lamp is approaching to the end of its life time, the message "Lamp life exceeded." will show on the screen. Please contact your local reseller or service center to change the lamp as soon as possible.
- Turn off and unplug the power plug from the AC outlet before cleaning the product.
- Use a soft dry cloth with mild detergent to clean the display housing. Do not use abrasive cleaners, waxes or solvents to clean the unit.
- Disconnect the power plug from AC outlet if the product is not being used for a long period of time.
- *Do not setup the projector in places where it might be subjected to vibration or shock.*
- *Do not touch the lens with bare hands.*
- *Remove battery/batteries from remote control before storage. If the battery/batteries are left in the remote for long periods, they may leak.*
- *Do not use or store the projector in places where smoke from oil or cigarettes may be present, as it can adversely affect the quality of the projector performance.*
- *Please follow the correct projector orientation installation as non standard installation may affect the projector performance.*
- *Use a power strip and or surge protector. As power outages and brown-outs can KILL devices.*

Cleaning the Lens

- Before cleaning the lens, be sure to turn off the projector and unplug the power cord to allow it to completely cool down.
- Use a compressed air tank to remove the dust.
- Use a special cloth for cleaning lens and gently wipe the lens. Do not touch the lens with your fingers.
- Do not use alkaline/acid detergents or volatile solvents such as alcohol for cleaning lens. If the lens is damaged due to the cleaning process, it is not covered by the warranty.



Warning: Do not use a spray containing flammable gases to remove dust or dirt from the lens. This may cause a fire due to excessive heat inside the projector.



Warning: Do not clean the lens if the projector is warming up as this may cause the lens' surface film to peel off.



Warning: Do not wipe or tap the lens with a hard object.

3D Safety Information

Please follow all warnings and precautions as recommended before you or your child use the 3D function.

Warning

Children and teenagers may be more susceptible to health issues associated with viewing in 3D and should be closely supervised when viewing these images.

Photosensitive Seizure Warning and Other Health Risks

- Some viewers may experience an epileptic seizure or stroke when exposed to certain flashing images or lights contained in certain Projector pictures or video games. If you suffer from, or have a family history of epilepsy or strokes, please consult with a medical specialist before using the 3D function.
- Even those without a personal or family history of epilepsy or stroke may have an undiagnosed condition that can cause photosensitive epileptic seizures.
- Pregnant women, the elderly, sufferers of serious medical conditions, those who are sleep deprived or under the influence of alcohol should avoid utilizing the unit's 3D functionality.
- If you experience any of the following symptoms, stop viewing 3D pictures immediately and consult a medical specialist: (1) altered vision; (2) light-headedness; (3) dizziness; (4) involuntary movements such as eye or muscle twitching; (5) confusion; (6) nausea; (7) loss of awareness; (8) convulsions; (9) cramps; and/ or (10) disorientation. Children and teenagers may be more likely than adults to experience these symptoms. Parents should monitor their children and ask whether they are experiencing these symptoms.
- Watching 3D projection may also cause motion sickness, perceptual after effects, disorientation, eye strain and decreased postural stability. It is recommended that users take frequent breaks to lessen the potential of these effects. If your eyes show signs of fatigue or dryness or if you have any of the above symptoms, immediately discontinue use of this device and do not resume using it for at least thirty minutes after the symptoms have subsided.
- Watching 3D projection while sitting too close to the screen for an extended period of time may damage your eyesight. The ideal viewing distance should be at least three times the screen height. It is recommended that the viewer's eyes are level with the screen.
- Watching 3D projection while wearing 3D glasses for an extended period of time may cause a headache or fatigue. If you experience a headache, fatigue or dizziness, stop viewing the 3D projection and rest.
- Do not use the 3D glasses for any other purpose than for watching 3D projection.
- Wearing the 3D glasses for any other purpose (as general spectacles, sunglasses, protective goggles, etc.) may be physically harmful to you and may weaken your eyesight.
- Viewing in 3D projection may cause disorientation for some viewers. Accordingly, DO NOT place your 3D PROJECTOR near open stairwells, cables, balconies, or other objects that can be tripped over, run into, knocked down, broken or fallen over.

Copyright

This publication, including all photographs, illustrations and software, is protected under international copyright laws, with all rights reserved. Neither this manual, nor any of the material contained herein, may be reproduced without written consent of the author.

© Copyright 2022

Disclaimer

The information in this document is subject to change without notice. The manufacturer makes no representations or warranties with respect to the contents hereof and specifically disclaims any implied warranties of merchantability or fitness for any particular purpose. The manufacturer reserves the right to revise this publication and to make changes from time to time in the content hereof without obligation of the manufacturer to notify any person of such revision or changes.

Trademark Recognition

Kensington is a U.S. registered trademark of ACCO Brand Corporation with issued registrations and pending applications in other countries throughout the world.

HDMI, the HDMI Logo, and High-Definition Multimedia Interface are trademarks or registered trademarks of HDMI Licensing LLC in the United States and other countries.

DLP®, DLP Link and the DLP logo are registered trademarks of Texas Instruments and BrilliantColor™ is a trademark of Texas Instruments.

MHL, Mobile High-Definition Link and the MHL Logo are trademarks or registered trademarks of MHL Licensing, LLC.

All other product names used in this manual are the properties of their respective owners and are Acknowledged.

FCC

This device has been tested and found to comply with the limits for a Class B digital device pursuant to Part 15 of the FCC rules. These limits are designed to provide reasonable protection against harmful interference in a residential installation. This device generates, uses and can radiate radio frequency energy and, if not installed and used in accordance with the instructions, may cause harmful interference to radio communications.

However, there is no guarantee that interference will not occur in a particular installation. If this device does cause harmful interference to radio or television reception, which can be determined by turning the device off and on is encouraged to try to correct the interference by one or more of the following measures:

- Reorient or relocate the receiving antenna.
- Increase the separation between the device and receiver.
- Connect the device into an outlet on a circuit different from that to which the receiver is connected.
- Consult the dealer or an experienced radio/television technician for help.

Notice: Shielded cables

All connections to other computing devices must be made using shielded cables to maintain compliance with FCC regulations.

Caution

Changes or modifications not expressly approved by the manufacturer could void the user's authority, which is granted by the Federal Communications Commission, to operate this projector.

Operation Conditions

This device complies with Part 15 of the FCC Rules. Operation is subject to the following two conditions:

1. This device may not cause harmful interference and
2. This device must accept any interference received, including interference that may cause undesired operation.

Notice: Canadian users

This Class B digital apparatus complies with Canadian ICES-003.

Remarque à l'intention des utilisateurs canadiens

Cet appareil numérique de la classe B est conforme à la norme NMB-003 du Canada.

Declaration of Conformity for EU countries

- EMC Directive 2014/30/EC (including amendments)
- Low Voltage Directive 2014/35/EC
- RED 2014/53/EU (if product has RF function)

WEEE



Disposal instructions

Do not throw this electronic device into the trash when discarding. To minimize pollution and ensure utmost protection of the global environment, please recycle it.

INTRODUCTION

Package Overview

Carefully unpack and verify that you have the items listed below under standard accessories. Some of the items under optional accessories may not be available depending on the model, specification and your region of purchase. Please check with your place of purchase. Some accessories may vary from region to region.

The warranty card is only supplied in some specific regions. Please consult your dealer for detailed information.

Standard accessories

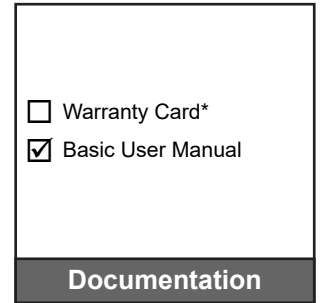
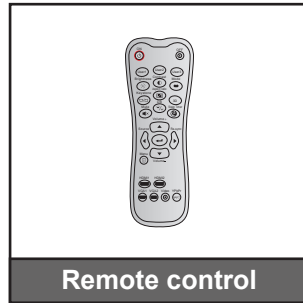
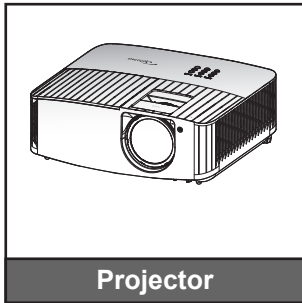

Note:

- *The actual remote control may vary depending on the region.*
- *The remote control is shipped with the batteries.*
- ** For warranty Information, please visit <https://www.optoma.com/support/download>.*

Optional accessories

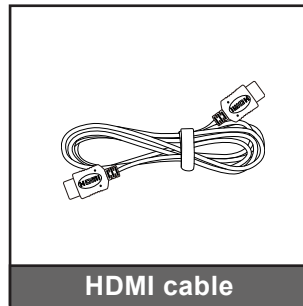
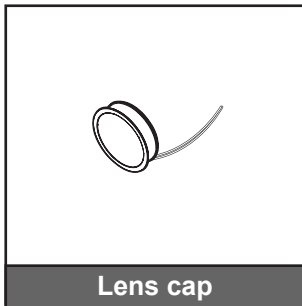

Note: *Optional accessories vary depending on model, specification and region.*

INTRODUCTION

Product Overview

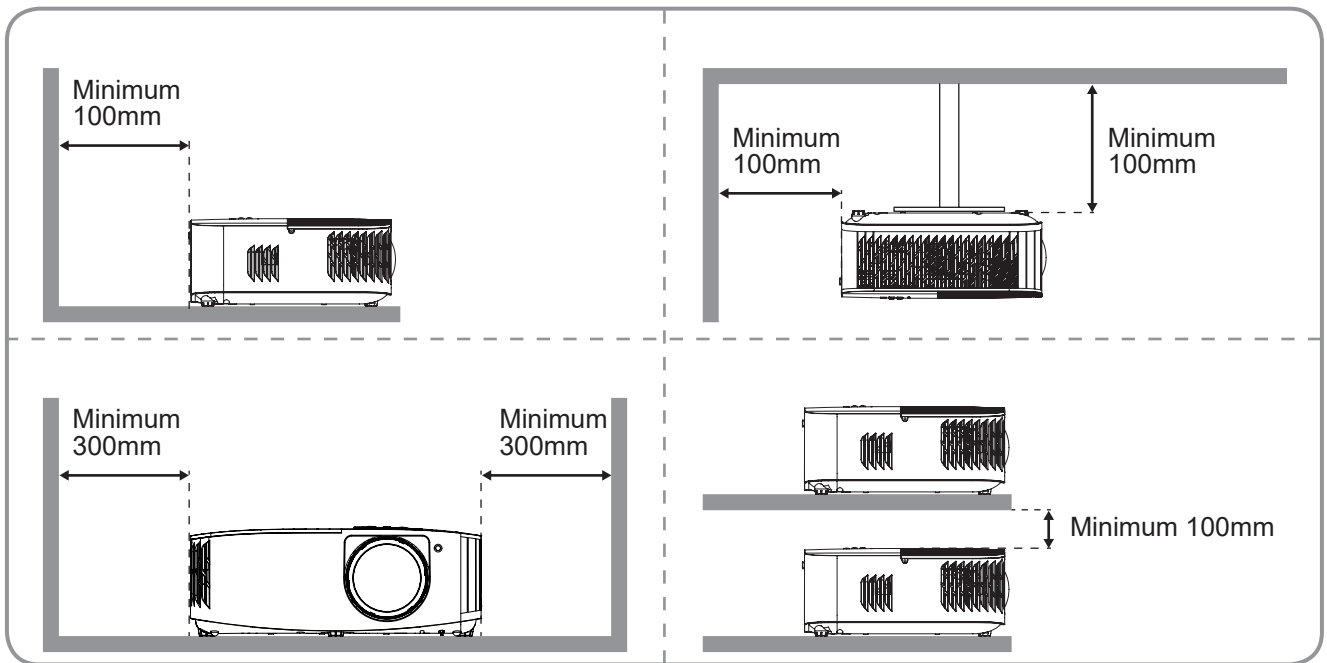
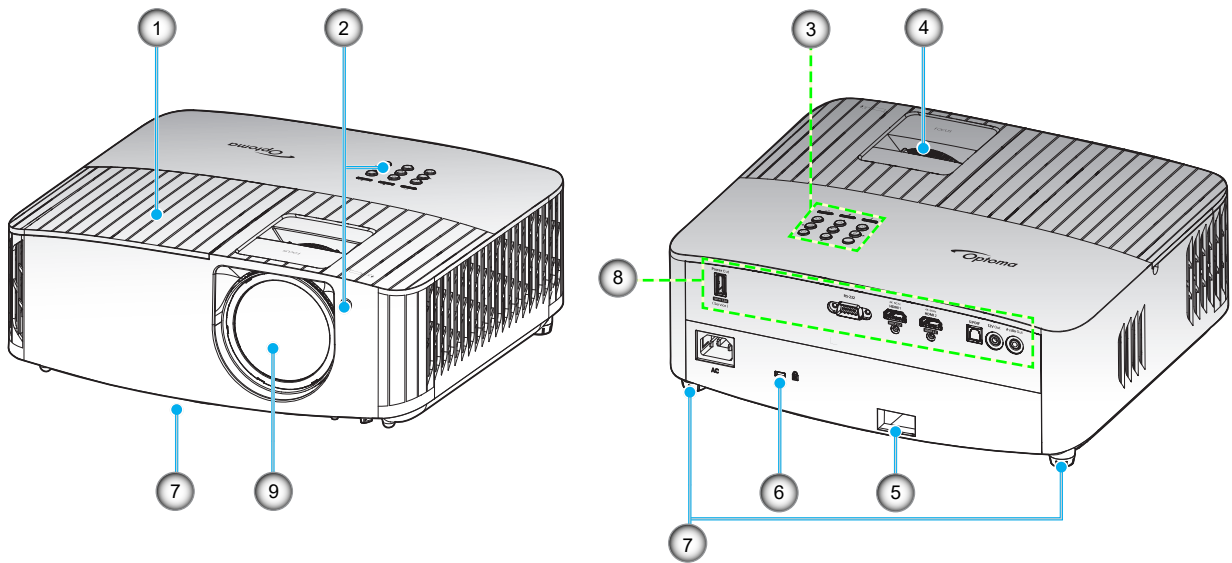

Note:

- Do not block projector intake and exhaust vents.
- When operating the projector in an enclosed space, allow at least 30 cm clearance around the intake and exhaust vents.

No	Item	No	Item
1.	Lamp Cover	6.	Kensington™ Lock Port
2.	IR Receiver (front and top)	7.	Tilt-Adjustment Feet
3.	Keypad	8.	Inputs/outputs
4.	Focus Ring	9.	Lens
5.	Security Bar		

INTRODUCTION

Connections

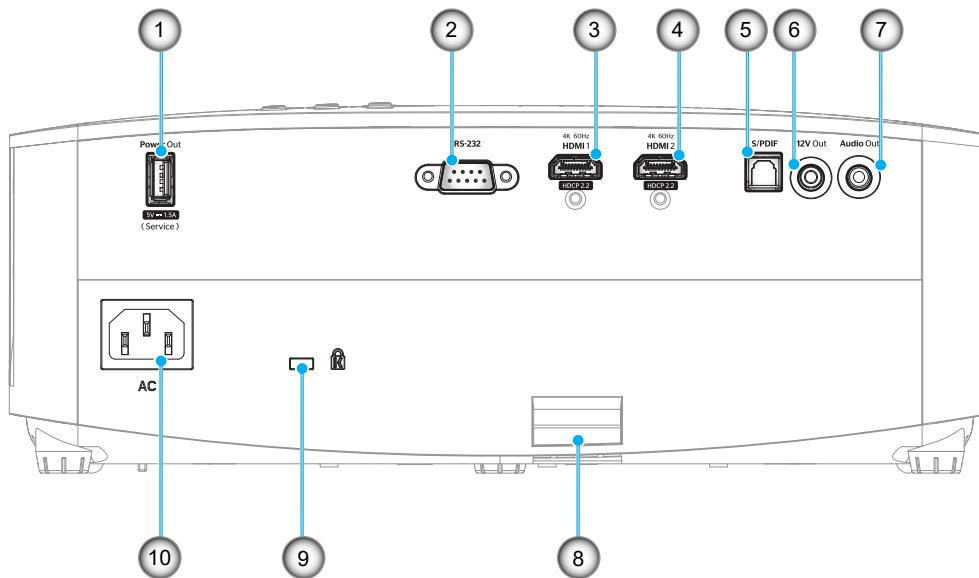

No	Item	No	Item
1.	USB Power OUT (5V $\overline{\text{---}}$ 1.5A) Connector	6.	12V Out Connector
2.	RS-232 Connector	7.	Audio Out Connector
3.	HDMI 1 Connector (4K 60Hz)	8.	Security Bar
4.	HDMI 2 Connector (4K 60Hz)	9.	Kensington™ Lock Port
5.	S/PDIF Connector	10.	Power Socket

INTRODUCTION

Keypad

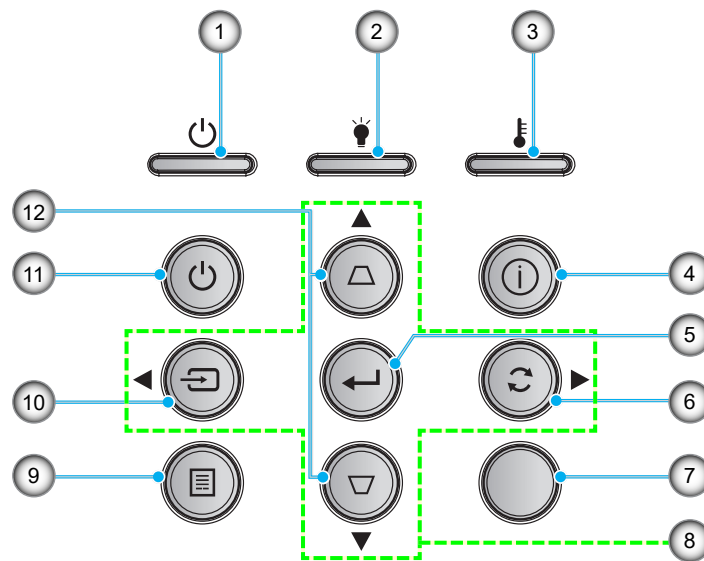

No	Item	No	Item
1.	On/Standby LED	7.	IR Receiver
2.	Lamp LED	8.	Directional selection keys
3.	Temp LED	9.	Menu
4.	Information	10.	Source
5.	Enter	11.	Power
6.	Re-Sync	12.	Keystone Correction

INTRODUCTION

Remote control

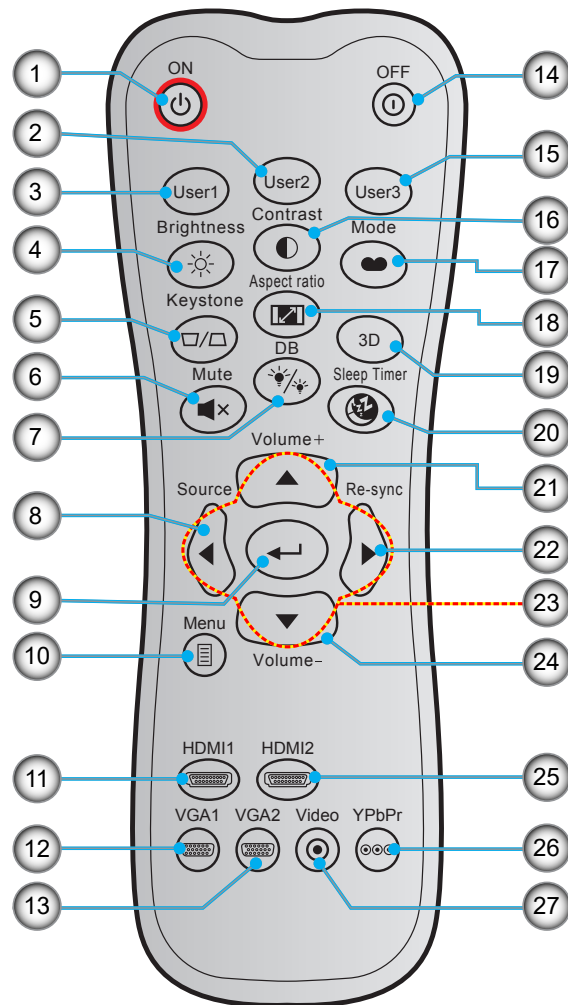

No	Item	No	Item
1.	Power On	15.	User 3
2.	User 2	16.	Contrast
3.	User 1	17.	Display Mode
4.	Brightness	18.	Aspect Ratio
5.	Keystone	19.	3D Mode
6.	Mute	20.	Sleep Timer
7.	DB (Dynamic Black)	21.	Volume +
8.	Source	22.	Re-Sync
9.	Enter	23.	Directional selection keys
10.	Menu	24.	Volume -
11.	HDMI1	25.	HDMI2
12.	VGA1 (not supported)	26.	YPbPr (not supported)
13.	VGA2 (not supported)	27.	Video (not supported)
14.	Power Off		

Note: Some keys may have no function for models that do not support these features.

SETUP AND INSTALLATION

Installing the projector

Your projector is designed to be installed in one of four possible positions.

Your room layout or personal preference will dictate which installation location you select. Take into consideration the size and position of your screen, the location of a suitable power outlet, as well as the location and distance between the projector and the rest of your equipment.

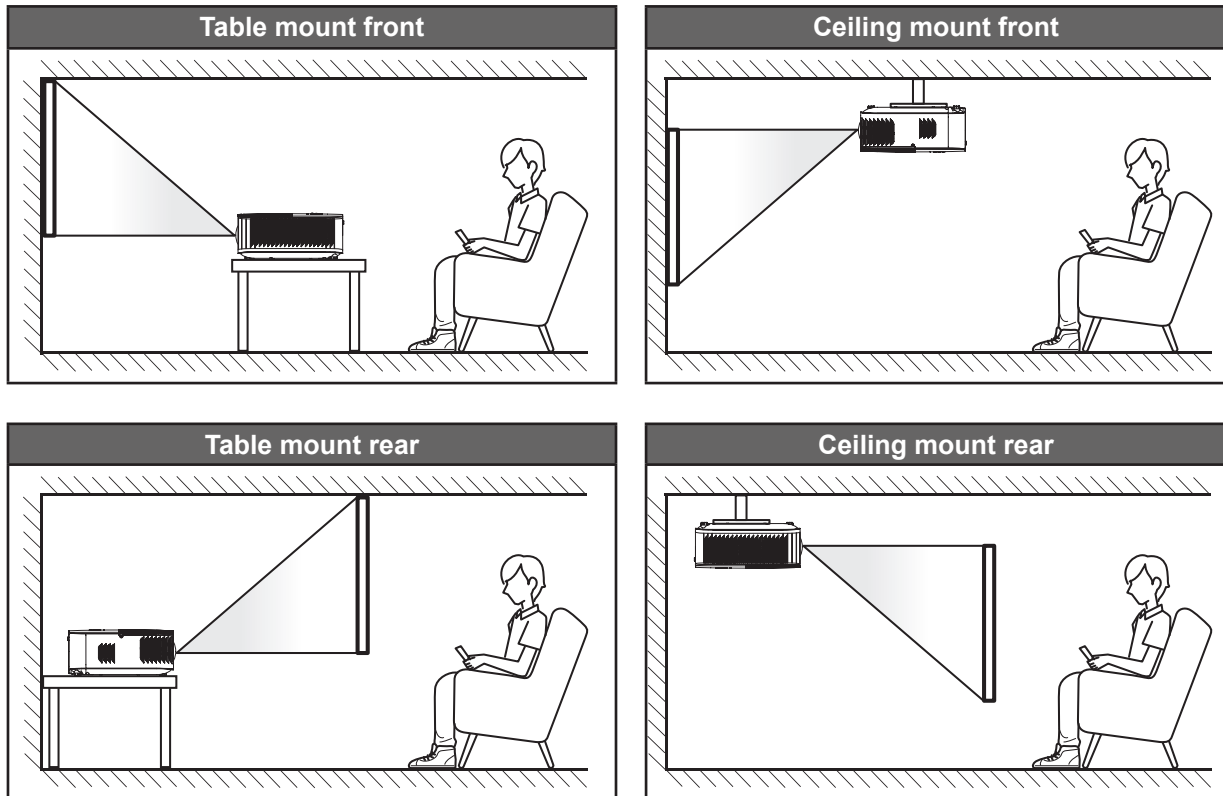

Projector should be placed flat on a surface and 90 degrees / perpendicular to the screen.

- How to determine projector location for a given screen size, please refer to distance table on page 44.
- How to determine screen size for a given distance, please refer to distance table on page 44.

Note: *The further away the projector is placed from the screen the projected image size increases and vertical offset also increases proportionally.*

IMPORTANT!

Do not operate the projector in any orientation other than table top or ceiling mount. The projector should be horizontal and not tilted either forwards/backwards or left/right. Any other orientation will invalidate the warranty and may shorten the lifetime of the projector lamp or the projector itself. For non-standard installation advice please contact Optoma.

SETUP AND INSTALLATION

Connecting sources to the projector

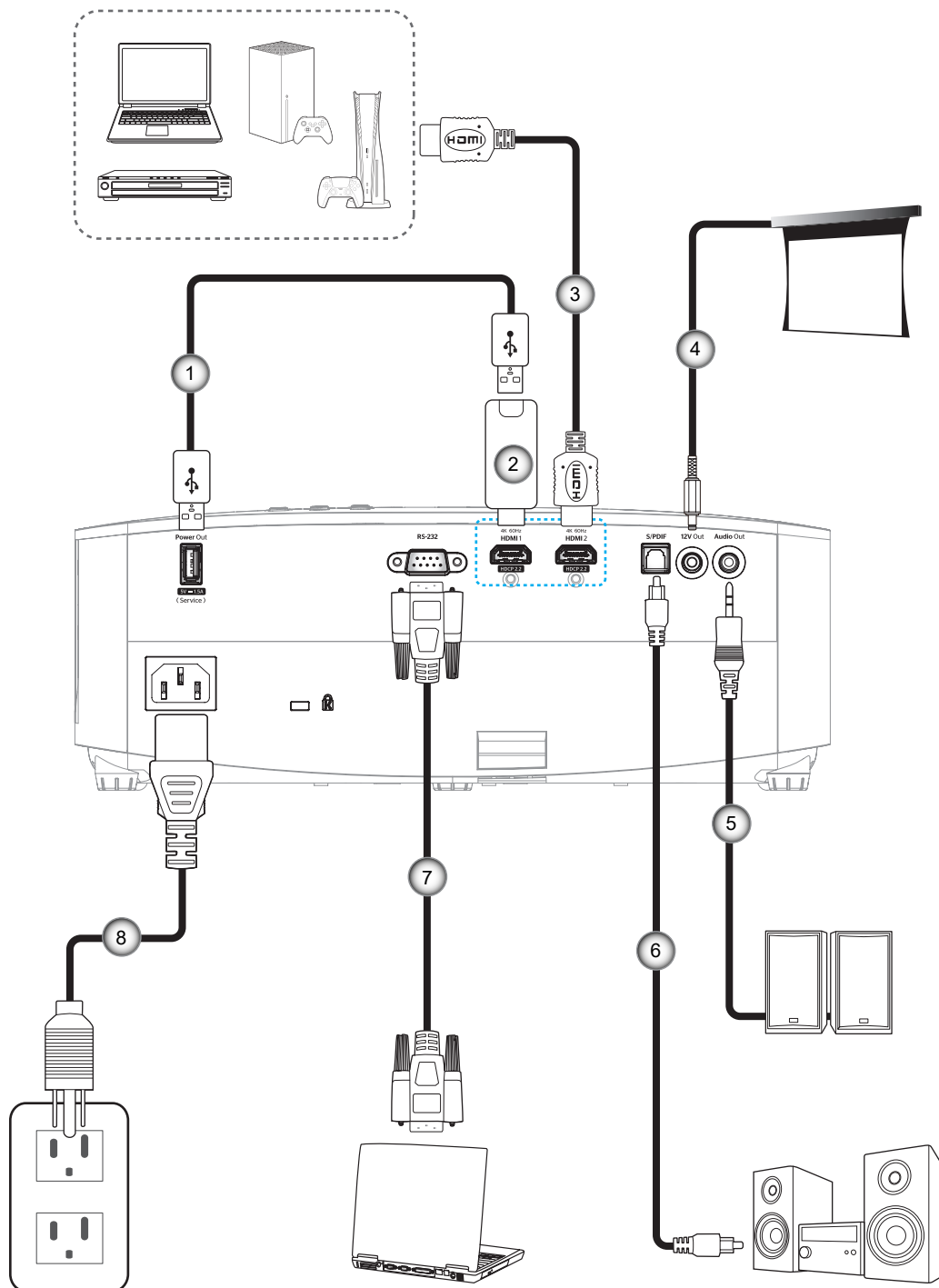

No	Item
1.	USB Power Cable
2.	HDMI Dongle
3.	HDMI Cable
4.	12V DC Jack

No	Item
5.	Audio Out Cable
6.	S/PDIF Out Cable
7.	RS-232 Cable
8.	Power Cord

Note: To ensure the best image quality and avoid connection errors, we recommend the use of High Speed or Premium Certified HDMI cables up to 5 meters.

SETUP AND INSTALLATION

Adjusting the projector image

Image height

The projector is equipped with elevator feet for adjusting the image height.

1. Locate the adjustable foot you wish to adjust on the underside of the projector.
2. Rotate the adjustable foot clockwise or counterclockwise to raise or lower the projector.

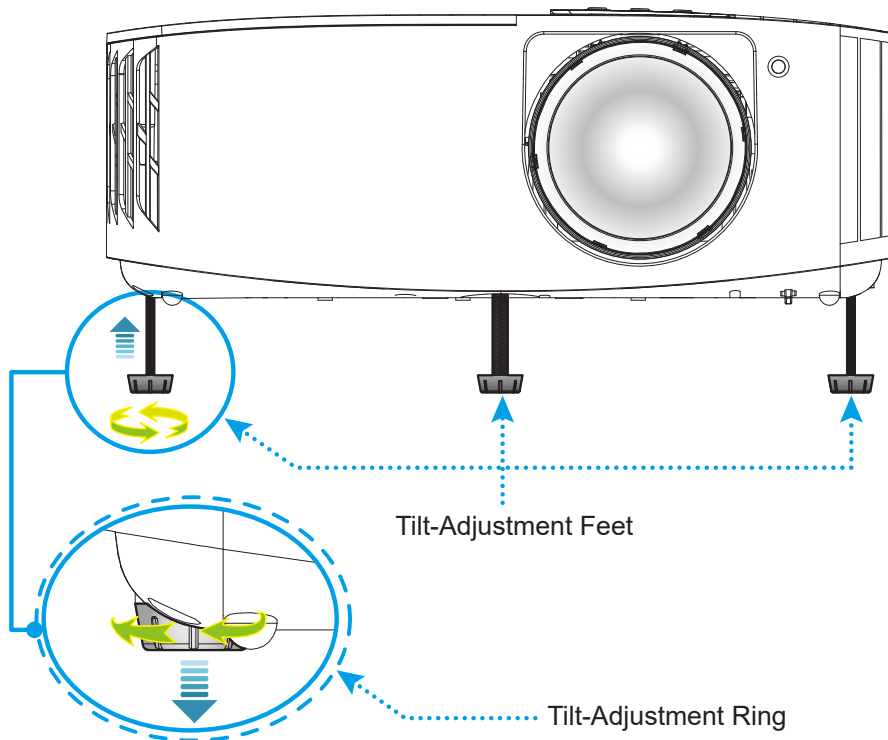

Focus

To adjust the focus, turn the focus ring clockwise or counterclockwise until the image is sharp and legible.

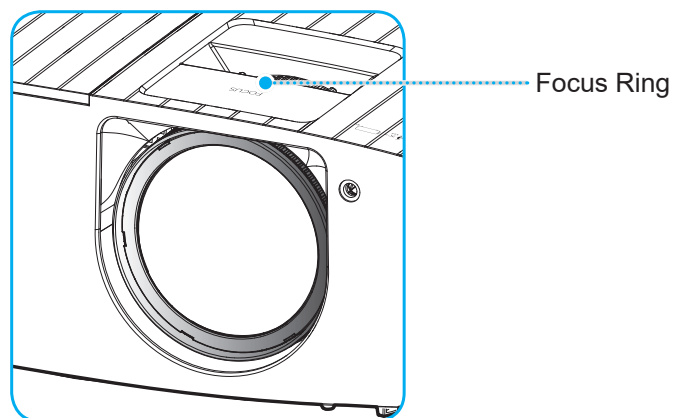

Note: The projector will focus at a distance of 0.4m to 3.3m.

SETUP AND INSTALLATION

Remote setup

Installing / replacing the batteries

Two AAA size batteries are supplied for the remote control.

1. Remove the battery cover on the back of the remote control.
2. Insert AAA batteries in the battery compartment as illustrated.
3. Replace back cover on remote control.

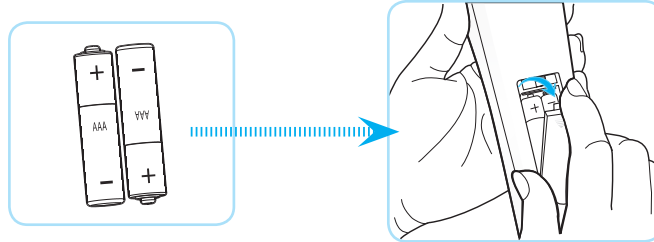

Note: Replace only with the same or equivalent type batteries.

CAUTION

Improper use of batteries can result in chemical leakage or explosion. Be sure to follow the instructions below.

- Do not mix batteries of different types. Different types of batteries have different characteristics.
- Do not mix old and new batteries. Mixing old and new batteries can shorten the life of new batteries or cause chemical leakage in old batteries.
- Remove batteries as soon as they are depleted. Chemicals that leak from batteries that come in contact with skin can cause a rash. If you find any chemical leakage, wipe thoroughly with a cloth.
- The batteries supplied with this product may have a shorter life expectancy due to storage conditions.
- If you will not be using the remote control for an extended period of time, remove the batteries.
- When you dispose of the batteries, you must obey the law in the relative area or country.

SETUP AND INSTALLATION

Effective range

Infra-Red (IR) remote control sensor is located on top of the projector. Ensure to hold the remote control at an angle within 30° perpendicular to the projector's IR remote control sensors to function correctly. The distance between the remote control and the sensor should not be longer than 6 meters (~19 feet).

Note: When pointing the remote control directly (0 degrees angle) on the IR sensor, the distance between the remote control and the sensor should not be longer than 8 meters (~26 feet).

- Make sure that there are no obstacles between the remote control and the IR sensor on the projector that might obstruct the infra-red beam.
- Make sure the IR transmitter of the remote control is not being shined by sunlight or fluorescent lamps directly.
- Please keep the remote controller away from fluorescent lamps for over 2 meters or the remote controller might become malfunction.
- If the remote control is close to Inverter-Type fluorescent lamps, it might become ineffective from time to time.
- If the remote control and the projector are within a very short distance, the remote control might become ineffective.
- When you aim at the screen, the effective distance is less than 7 meters from the remote control to the screen and reflecting the IR beams back to the projector. However, the effective range might change according to screens.

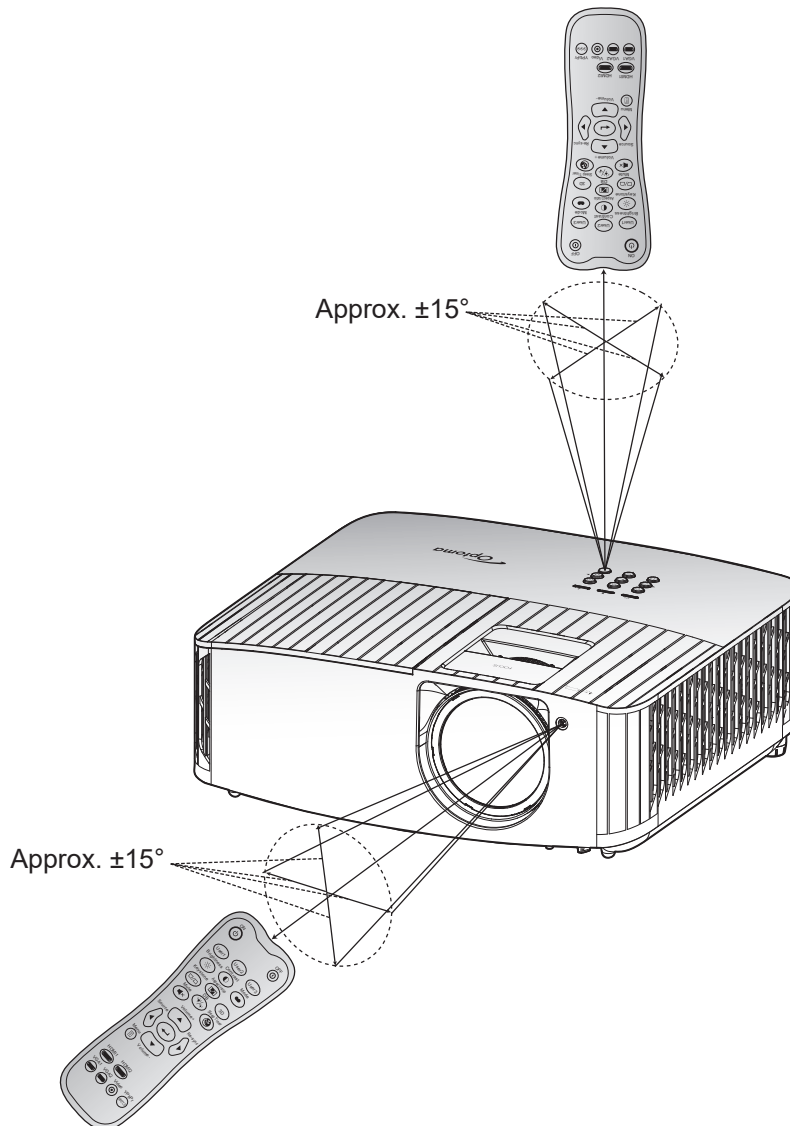

USING THE PROJECTOR

Powering on / off the projector

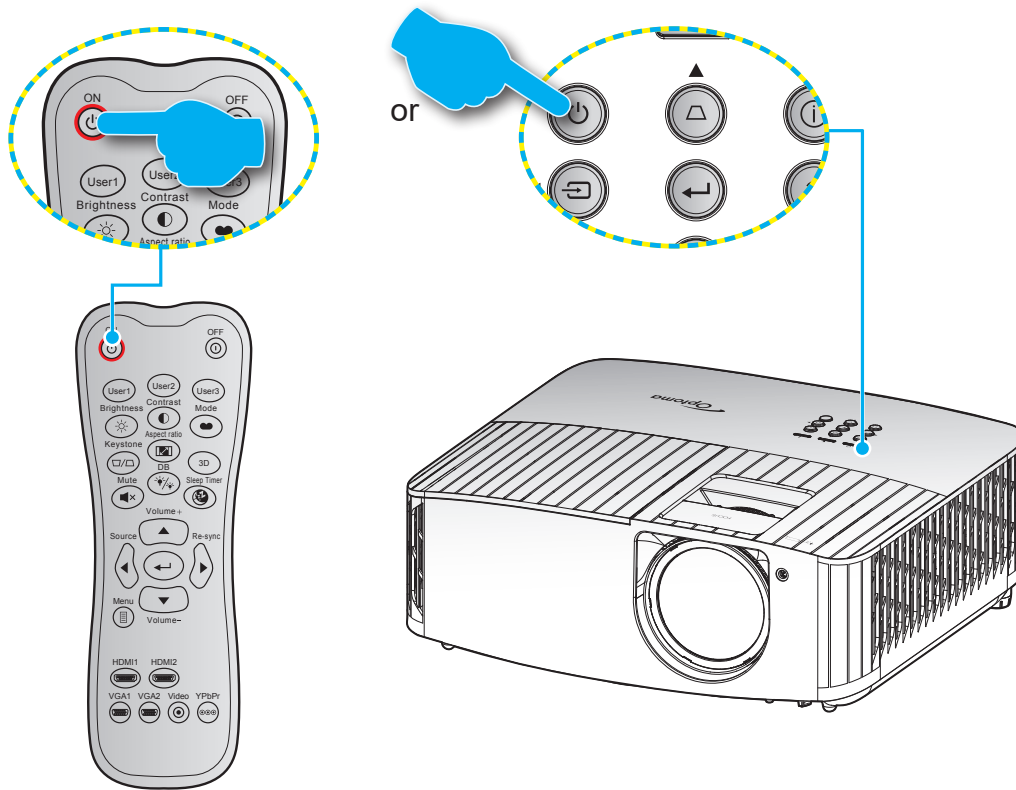

Powering on

1. Securely connect the power lead and signal/source cable. When connected, the On/Standby LED will turn red.
2. Turn on the projector by pressing the “⏻” button on the projector keypad or the remote control.
3. A start up screen will display in approximately 10 seconds and the On/Standby LED will be flashing blue.

Note: The first time the projector is turned on, you will be prompted to select the preferred language, projection orientation, and other settings.

USING THE PROJECTOR

Powering off

1. Turn off the projector by pressing the “⏻” button on the projector keypad or the “ⓘ” button on the remote control.
2. The following message will be displayed:

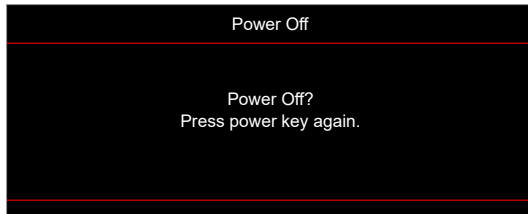

3. Press the “⏻”/“ⓘ” button again to confirm, otherwise the message will disappear after 15 seconds. When you press the “⏻”/“ⓘ” button for the second time, the projector will shut down.
4. The cooling fans will continue to operate for about 10 seconds for the cooling cycle and the On/Standby LED will flash blue. When the On/Standby LED turns solid red, this indicates the projector has entered standby mode. If you wish to turn the projector back on, you must wait until the cooling cycle has finished and the projector has entered standby mode. When the projector is in standby mode, simply press the “⏻” button again to turn on the projector.
5. Disconnect the power lead from the electrical outlet and the projector.

Note: *It is not recommended that the projector is turned on immediately, right after a power off procedure.*

USING THE PROJECTOR

Selecting an input source



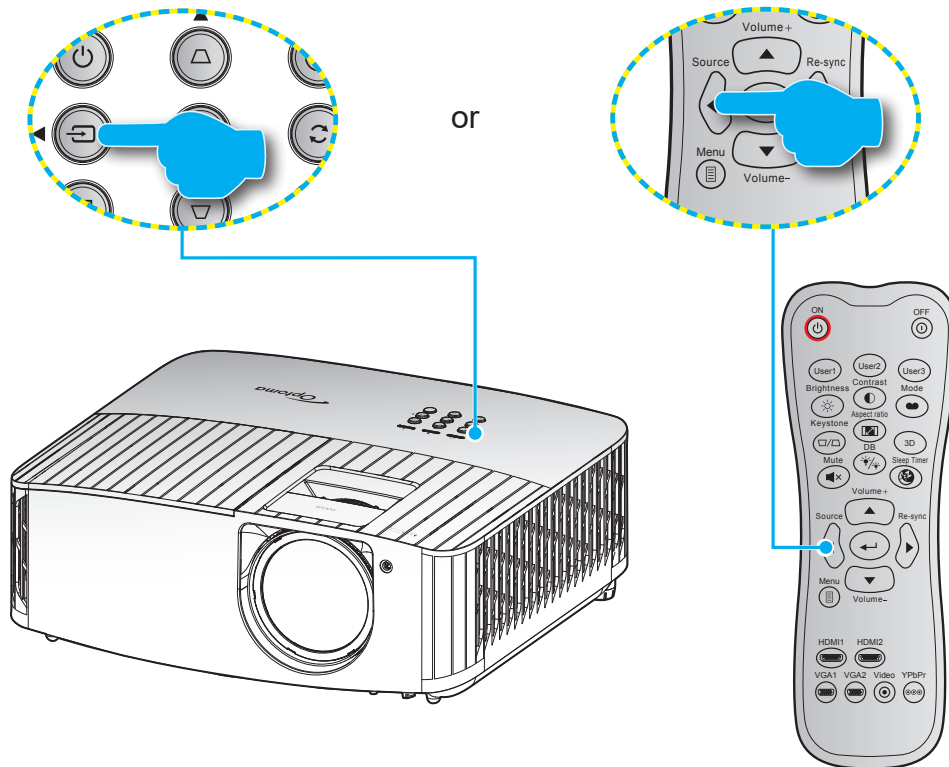







Turn on the connected source that you want to display on the screen, such as computer, notebook, video player, etc. The projector will automatically detect the source. If multiple sources are connected, press the “” button on the projector keypad or the **Source** button on the remote control to select the desired input.



USING THE PROJECTOR

Menu navigation and features

The projector has multilingual on-screen display menus that allow you to make image adjustments and change a variety of settings. The projector will automatically detect the source.

1. To open the OSD menu, press  on the remote control or the projector keypad.
2. When OSD is displayed, use   keys to select any item in the main menu. While making a selection on a particular page, press  on the remote control or the projector keypad to enter sub menu.
3. Use   keys to select the desired item in the sub menu and then press  to view further settings. Adjust the settings by using   keys.
4. Select the next item to be adjusted in the sub menu and adjust as described above.
5. Press  to confirm, and the screen will return to the main menu.
6. To exit, press  again. The OSD menu will close and the projector will automatically save the new settings.

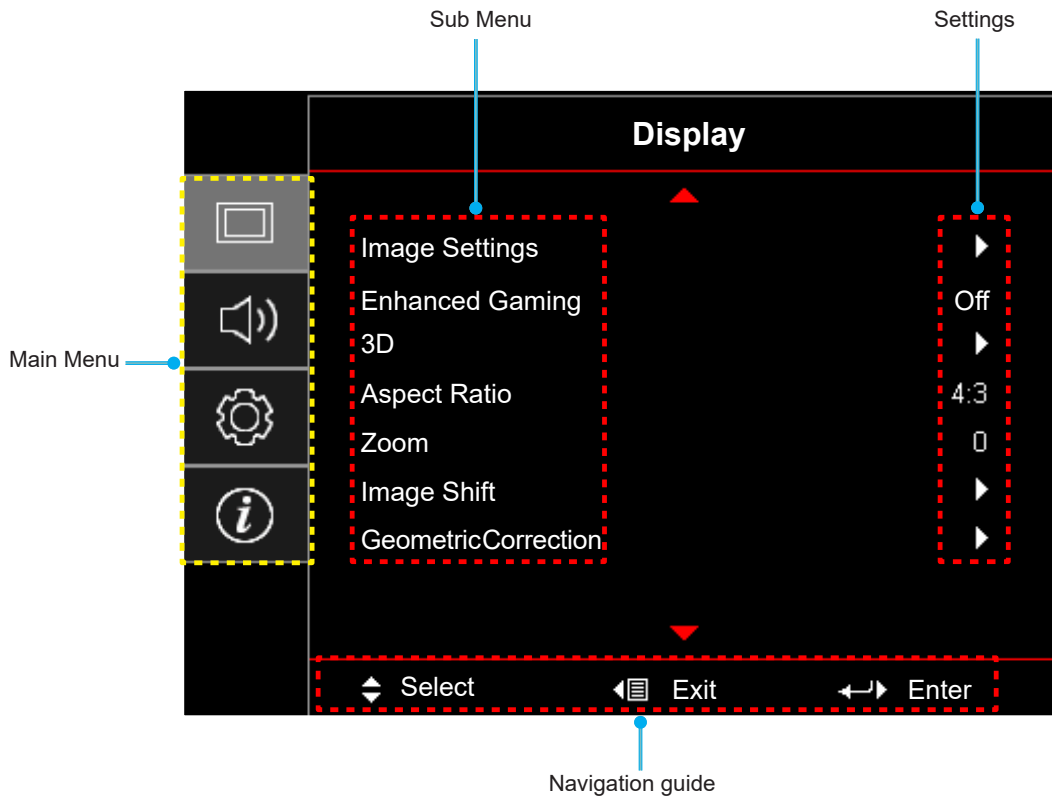

USING THE PROJECTOR

OSD Menu tree

Note:

- The design function depends on model and region.
- The functions are subject to the actual product, the changes will not be notified.

Main Menu	Sub Menu	Sub Menu 2	Sub Menu 3	Sub Menu 4	Values			
Display	Image Settings	Display Mode			Cinema			
					HDR			
					HLG			
					HDR SIM.			
					Game			
					Reference			
					Bright			
					User			
					3D			
					ISF Day			
					ISF Night			
					ISF 3D			
			Wall Color			Off [Default]		
						Blackboard		
						Light Yellow		
						Light Green		
						Light Blue		
						Pink		
			Dynamic Range	HDR/HLG			Off	
							Auto [Default]	
				HDR Picture Mode			Bright	
							Standard [Default]	
							Film	
				HLG Picture Mode			Detail	
							Bright	
							Standard [Default]	
					HDR Strength			Film
								Detail
							0 ~ 10	
				Brightness			-50 ~ 50	
				Contrast			-50 ~ 50	
				Sharpness			1 ~ 15	
				Color			-50 ~ 50	
				Tint			-50 ~ 50	

USING THE PROJECTOR

Main Menu	Sub Menu	Sub Menu 2	Sub Menu 3	Sub Menu 4	Values		
Display	Image Settings	Gamma			Film		
					Video		
					Graphics		
					Standard(2.2)		
					1.8		
					2.0		
					2.4		
					3D		
			Color Settings	BrilliantColor™			1 ~ 10
		Color Temperature					D55
							D65
							D75
							D83
							D93
						Native	
		Color Matching		Color			R [Default]
							G
							B
							C
							Y
							M
							W
					Hue		-50 ~ 50 [Default: 0]
					Saturation		-50 ~ 50 [Default: 0]
					Gain		-50 ~ 50 [Default: 0]
				Reset			Cancel [Default]
							Yes
				RGB Gain/Bias	Red Gain		-50 ~ 50
					Green Gain		-50 ~ 50
					Blue Gain		-50 ~ 50
					Red Bias		-50 ~ 50
					Green Bias		-50 ~ 50
					Blue Bias		-50 ~ 50
					Reset		
							Yes
				Exit			
			Color Space [Not HDMI Input]			Auto [Default]	
						RGB	
						YUV	
			Color Space [HDMI Input]			Auto [Default]	
						RGB(0~255)	
						RGB(16~235)	
						YUV	

USING THE PROJECTOR

Main Menu	Sub Menu	Sub Menu 2	Sub Menu 3	Sub Menu 4	Values	
Display	Image Settings	Brightness Mode			Bright [Default]	
					Eco.	
					Dynamic	
					Eco+	
		Reset				
	Enhanced Gaming	Off [Default]				
		On				
	3D	3D Mode				Off [Default]
						On
		3D Sync Invert				Off [Default]
						On
		3D Format				Auto [Default]
						SBS
					Top and Bottom	
					Frame Sequential	
	Aspect Ratio					4:3
						16:9
						21:9
						32:9
						LBX
						Auto [Default]
	Zoom					-5 ~ 25 [Default: 0]
	Image Shift	H 				-100 ~ 100 [Default: 0]
V 					-100 ~ 100 [Default: 0]	
Geometric Correction	Four Corners					
	H Keystone				-20 ~ 20 [Default: 0]	
	V Keystone				-20 ~ 20 [Default: 0]	
	3x3 Warp					
	Reset					
Audio	Internal Speaker				Off	
					On [Default]	
	Mute				Off [Default]	
					On	
Volume					0 ~ 10 [Default: 5]	
Setup	Projection				Front  [Default]	
					Rear 	
					Ceiling-top 	
					Rear-top 	
	Lamp Settings	Lamp Reminder				Off
						On [Default]
		Lamp Reset				Cancel [Default]
					Yes	





USING THE PROJECTOR

Main Menu	Sub Menu	Sub Menu 2	Sub Menu 3	Sub Menu 4	Values	
Setup	Filter Settings	Filter Usage Hours			(read only)	
		Optional Filter Installed			Yes	
					No	
		Filter Reminder				Off
						300hr
						500hr [Default]
						800hr
						1000hr
	Filter Reset				Cancel [Default]	
					Yes	
	Power Settings	Direct Power On				Off [Default]
						On
		Auto Power Off (min.)				0 ~ 180 (5 min increments) [Default: 20]
		Sleep Timer (min.)				0 ~ 990 (30 min increments) [Default: 0]
			Always On			No [Default]
					Yes	
	Security	Security				Off [Default]
						On
		Security Timer	Month			
			Day			
			Hour			
	Change Password					
	HDMI Link Settings	HDMI Link				Off [Default]
						On
		Power On Link				Mutual [Default]
						PJ --> Device
		Power Off Link				Device --> PJ
						Off [Default]
	Test Pattern					On
						Green Grid
					Magenta Grid	
					White Grid	
					White	
					Off	

USING THE PROJECTOR

Main Menu	Sub Menu	Sub Menu 2	Sub Menu 3	Sub Menu 4	Values	
Setup	Remote Settings [depends on remote]	IR Function			On [Default]	
					Off	
		User1			Test Pattern	
					Brightness	
					Contrast	
					Sleep Timer [Default]	
					Color Matching	
					Color Temp	
					Gamma	
					Projection	
					Lamp Settings	
		User2			Test Pattern	
					Brightness	
					Contrast	
					Sleep Timer	
					Color Matching [Default]	
					Color Temp	
					Gamma	
					Projection	
					Lamp Settings	
		User3			Test Pattern	
					Brightness	
					Contrast	
					Sleep Timer	
					Color Matching	
					Color Temp	
					Gamma [Default]	
					Projection	
					Lamp Settings	
			Projector ID			00 ~ 99
			12V Trigger	12V Trigger		On
						Off [Default]
			Options	Language		English [Default]
					Deutsch	
					Français	
					Italiano	
					Español	
					Português	
					簡体中文	
					繁體中文	
					日本語	
			한국어			
			Русский			

USING THE PROJECTOR

Main Menu	Sub Menu	Sub Menu 2	Sub Menu 3	Sub Menu 4	Values
Setup	Options	Menu Settings	Menu Location		Top Left 
					Top Right 
					Center  [Default]
					Bottom Left 
					Bottom Right 
			Menu Timer		Off
				5sec	
				10sec [Default]	
		Auto Source		Off [Default]	
		Input Source		On	
				HDMI 1	
				HDMI 2	
		High Altitude		Off [Default]	
				On	
		Display Mode Lock		Off [Default]	
				On	
		Keypad Lock		Off [Default]	
				On	
		Information Hide		Off [Default]	
				On	
		Logo		Default [Default]	
				Neutral	
		Background Color		None [Default]	
				Blue	
			Red		
			Green		
			Gray		
	Reset	Reset OSD		Cancel [Default]	
				Yes	
		Reset to Default		Cancel [Default]	
			Yes		

USING THE PROJECTOR

Main Menu	Sub Menu	Sub Menu 2	Sub Menu 3	Sub Menu 4	Values	
Info	Regulatory					
	Serial Number					
	Source					
	Resolution				00x00	
	Refresh Rate				0.00Hz	
	Display Mode					
	Lamp Hours	Bright				
		Eco.				
		Dynamic				
		Eco+				
		Total				
	Projector ID				00 ~ 99	
	Brightness Mode					
	FW Version	System				
MCU						

USING THE PROJECTOR

Display menu

Image settings menu

Display Mode

There are many factory presets optimized for various types of images.

- **Cinema:** Provides the best colors for watching movies.
- **HDR:** Decodes and displays High Dynamic Range (HDR) content for the deepest blacks, brightest whites, and vivid cinematic color using REC.2020 color gamut. This mode will be automatically enabled if HDR is set to ON (and HDR Content is sent to projector – 4K UHD Blu-ray, 1080p/4K UHD HDR Games, 4K UHD Streaming Video). While HDR mode is active, other display modes (Cinema, Reference, etc.) cannot be selected as HDR delivers color that is highly accurate, exceeding the color performance of the other display modes.
- **HLG:** For HDR movies with Hybrid Log content.
- **HDR SIM.:** Enhances non-HDR content with simulated High Dynamic Range (HDR). Choose this mode to enhance gamma, contrast, and color saturation for non-HDR content (720p and 1080p Broadcast/Cable TV, 1080p Blu-ray, non-HDR Games, etc). This mode can ONLY be used with non-HDR content.
- **Game:** Select this mode to increase the brightness and response time level for enjoying video games.
- **Reference:** This mode is intended to reproduce as close as possible the image the way the movie director intended. Color, color temperature, brightness, contrast and gamma settings are all configured to standard reference levels. Select this mode to watch a video.
- **Bright:** Maximum brightness from PC input.
- **User:** Memorize user's settings.
- **3D:** To experience the 3D effect, you need to have 3D glasses. Make sure your PC/portable device has a 120 Hz signal output quad buffered graphics card and a 3D Player installed.
- **ISF Day:** Optimize the image with the ISF Day mode to be perfectly calibrated and high picture quality.
- **ISF Night:** Optimize the image with the ISF Night mode to be perfectly calibrated and high picture quality.
- **ISF 3D:** Optimize the image with the ISF 3D mode to be perfectly calibrated and high picture quality.

Note: For access and calibration of ISF daytime and night viewing modes, please contact your local dealer.

Wall Color

Use this function to obtain an optimized screen image according to the wall color. Select between off, blackboard, light yellow, light green, light blue, pink, and gray.

Dynamic Range

Configure the High Dynamic Range (HDR) setting and its effect when displaying video from 4K Blu-ray players and streaming devices.

➤ HDR/HLG

- **Off:** Turn off HDR or HLG processing. When set to Off, the projector will NOT decode HDR or HLG content.
- **Auto:** Auto detect HDR signal.

➤ HDR Picture Mode

- **Bright:** Choose this mode for brighter more saturated colors.
- **Standard:** Choose this mode for natural looking colors with a balance of warm and cool tones.
- **Film:** Choose this mode for improved detail and image sharpness.
- **Detail:** The signal comes from OETF conversion to achieve the best color matching.

USING THE PROJECTOR

► HLG Picture Mode

- **Bright:** Choose this mode for brighter more saturated colors.
- **Standard:** Choose this mode for natural looking colors with a balance of warm and cool tones.
- **Film:** Choose this mode for improved detail and image sharpness.
- **Detail:** The signal comes from OETF conversion to achieve the best color matching.

► HDR Strength

- Select the HDR level.

Brightness

Adjust the brightness of the image.

Contrast

The contrast controls the degree of difference between the lightest and darkest parts of the picture.

Sharpness

Adjust the sharpness of the image.

Color

Adjust a video image from black and white to fully saturated color.

Tint

Adjust the color balance of red and green.

Gamma

Set up gamma curve type. After the initial setup and fine tuning is completed, utilize the Gamma Adjustment steps to optimize your image output.

- **Film:** For home theater.
- **Video:** For video or TV source.
- **Graphics:** For PC / Photo source.
- **Standard(2.2):** For standardized setting.
- **1.8 / 2.0 / 2.4:** For specific PC / Photo source.
- **3D:** To experience the 3D effect, you need to have 3D glasses. Make sure your PC/portable device has a 120 Hz signal output quad buffered graphics card and a 3D Player installed.

Note: *These options are only available if the 3D mode function is disabled. In 3D mode, user can only select "3D" for Gamma setting.*

Color Settings

Configure the color settings.

- **BrilliantColor™:** This adjustable item utilizes a new color-processing algorithm and enhancements to enable higher brightness while providing true, more vibrant colors in picture.
- **Color Temperature:** Select a color temperature from D55, D65, D75, D83, D93, or Native.
- **Color Matching:** Select the following options:
 - Color: Adjust the red (R), green (G), blue (B), cyan (C), yellow (Y), magenta (M), and white (W) level of the image.
 - Hue: Adjust the color balance of red and green.
 - Saturation: Adjust a video image from black and white to fully saturated color.
 - Gain: Adjust the image brightness.

USING THE PROJECTOR

- Reset: Return the factory default settings for color matching.
- Exit: Exit the “Color Matching” menu.
- **RGB Gain/Bias:** This settings allows to configure the brightness (gain) and contrast (bias) of an image.
 - Reset: Return the factory default settings for RGB gain/bias.
 - Exit: Exit the “RGB Gain/Bias” menu.
- **Color Space (non-HDMI input only):** Select an appropriate color matrix type from the following: AUTO, RGB, or YUV.
- **Color Space (HDMI input only):** Select an appropriate color matrix type from the following: Auto, RGB(0-255), RGB(16-235), and YUV.

Brightness Mode

Adjust the brightness mode settings.

- **Bright:** Choose “Bright” to increase the brightness.
- **Eco:** Choose “Eco” to dim the projector lamp which will lower power consumption and extend the lamp life.
- **Dynamic:** Choose “Dynamic” to dim the lamp power which will be based on brightness level of the content and adjust lamp power consumption between 100% and 30% dynamically. The lamp life will be extended.
- **Eco+:** When “Eco+” mode is activated, the brightness level of the content is automatically detected to significantly reduced lamp power consumption (up to 70%) during periods of inactivity.

Reset

Return the factory default settings for color settings.

Enhanced Gaming menu

Enable this feature to reduce response times (input latency) during gaming to 4.0ms*.

Note:

- **Only for 1080p 240Hz signals.*
- *The input lag by signals is described in the following table:*
- *The values in the table can vary slightly.*

Source Timing	Enhanced Gaming	Output Resolution	Input Lag
1080p60	On	1080p	17ms
1080p120	On	1080p	8.6ms
1080p240	On	1080p	4ms
4K60	On	4K	16.7ms
1080p60	Off	1080p	33.8ms
1080p120	Off	1080p	17ms
1080p240	Off	1080p	8.6ms
4K60	Off	4K	33.7ms

- *Please note that if “Enhanced Gaming” mode is enabled, the 3D, Aspect Ratio, Zoom, Image Shift, and Geometric Correction functions are disabled automatically. These functions will be enabled again if you disable “Enhanced Gaming” mode.*

USING THE PROJECTOR

3D menu

3D Mode

Use this option to enable/disable the 3D mode function.

3D Sync Invert

Use this option to enable/disable the 3D sync invert function.

3D Format

Use this option to select the appropriate 3D format content.

- **Auto:** When a 3D identification signal is detected, the 3D format is selected automatically.
- **SBS:** Display 3D signal in “Side-by-Side” format.
- **Top and Bottom:** Display 3D signal in “Top and Bottom” format.
- **Frame Sequential:** Display 3D signal in “Frame Sequential” format.

Aspect Ratio menu

Select the aspect ratio of the displayed image between the following options:

- **4:3:** This format is for 4:3 input sources.
- **16:9/21:9/32:9:** These formats are for 16:9/21:9/32:9 input sources, like HDTV and DVD enhanced for Wide screen TV.
- **LBX:** This format is for non-16x9, letterbox source and if you use external 16x9 lens to display 2.35:1 aspect ratio in full resolution.
- **Auto:** Automatically selects the appropriate display format.

Note:

- *Detailed informations about LBX mode:*
 - *Some Letter-Box Format DVDs are not enhanced for 16x9 TVs. In this situation, the image will not look right when displaying image in 16:9 mode. In this situation, please try to use the 4:3 mode to view the DVD. If the content is not 4:3, there will be black bars around the image in 16:9 display. For this type of content, you can use LBX mode to fill the image on the 16:9 display.*
 - *If you use an external anamorphic lens, this LBX mode also allows you to watch a 2.35:1 content (include Anamorphic DVD and HDTV film source) that supports anamorphic wide is enhanced for 16x9 Display in a wide 2.35:1 image. In this case, there are no black bars. Lamp power and vertical resolution are fully utilized.*

USING THE PROJECTOR

4K UHD scaling table:

16 : 9 screen	480i/p	576i/p	720p	1080i/p	2160p
4x3	Scale to 2880 x 2160.				
16x9	Scale to 3840 x 2160.				
LBX	Get the central 3840 x 1620 image, and then scale to 3840 x 2160 for display.				
Native mode	1:1 mapping centered. No scaling will be made; the displayed resolution depends on the input source.				
Auto	-If source is 4:3, the screen type will be scaled to 2880 x 2160. -If source is 16:9, the screen type will be scaled to 3840 x 2160. -If source is 15:9, the screen type will be scaled to 3600 x 2160. -If source is 16:10, the screen type will be scaled to 3456 x 2160.				

Auto mapping rule:

	Input resolution		Auto/Scale	
	H-resolution	V-resolution	3840	2160
4:3	800	600	2880	2160
	1024	768	2880	2160
	1280	1024	2880	2160
	1400	1050	2880	2160
	1600	1200	2880	2160
Wide Laptop	1280	720	3840	2160
	1280	768	3600	2160
	1280	800	3456	2160
SDTV	720	576	2700	2160
	720	480	3240	2160
HDTV	1280	720	3840	2160
	1920	1080	3840	2160

USING THE PROJECTOR

Zoom menu

Use to reduce or magnify an image on the projection screen.

Image Shift menu

Adjust the projected image position horizontally (H) or vertically (V).

Note: *The image size will reduce slightly when adjusting the horizontal and vertical keystone.*

Geometric Correction menu

- **Four Corners:** Allow the image to be squeezed to fit an area defined by moving each of the four corners' x and y position.
Note: *While adjusting the Four Corners, the Zoom, Aspect Ratio, and Image Shift menus are disabled. To enable Zoom, Aspect Ratio, and Image Shift, reset the Four Corners settings to the factory defaults.*
- **H Keystone:** Adjust image distortion horizontally and make a squarer image. Horizontal keystone is used to correct a keystone image shape in which the left and right borders of the image are unequal in length. This is intended for use with horizontally on-axis applications.
- **V Keystone:** Adjust image distortion vertically and make a squarer image. Vertical keystone is used to correct a keystone image shape in which the top and bottom are slanted to one of the sides. This is intended when for use with vertically on-axis applications.
- **3x3 Warp:** Adjust the image distortion by 9 points correction.

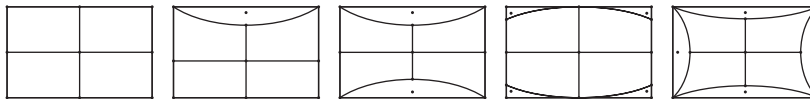

Note: *When using the Enhanced Gaming mode, Four Corners, H Keystone, V Keystone, and 3x3 Warping will be disabled as the settings impact input lag. If you plan to use the Enhanced Gaming mode for low input lag, we strongly recommend setting up the projector without the use of Four Corners, H Keystone, V Keystone, and 3x3 Warping.*

- **Reset:** Return the factory default settings for geometric connection.

Audio menu

Internal Speaker

Use this option to turn on or off the internal speaker.

- **Off:** Choose “Off” to turn off the internal speaker.
- **On:** Choose “On” to turn on the internal speaker even if an external speaker is connected to the projector.

Mute

Use this option to temporarily turn off the sound.

- **Off:** Choose “Off” to turn mute off.
- **On:** Choose “On” to turn mute on.

Note: *“Mute” function affects both internal and external speaker volume.*

Volume

Adjust the volume level.

USING THE PROJECTOR

Setup menu

Projection

Select the preferred projection between front, rear, ceiling-top, and rear-top.

Lamp Settings menu

Lamp Reminder

Choose this function to show or to hide the warning message when the changing lamp message is displayed. The message will appear 30 hours before suggested replacement of lamp.

Lamp Reset

Resets the lamp hour counter after replacing the lamp.

Filter Settings menu

Filter Usage Hours

Display the filter time.

Optional Filter Installed

Set the warning message setting.

- **Yes:** Display warning message after 500 hours of use.
Note: *“Filter Usage Hours / Filter Reminder / Filter Reset” will only appear when “Optional Filter Installed” is “Yes”.*
- **No:** Turn off warning message.

Filter Reminder

Choose this function to show or hide the warning message when the changing filter message is displayed. The available options include 300hr, 500hr, 800hr, and 1000hr.

Filter Reset

Reset the dust filter counter after replacing or cleaning the dust filter.

Power Settings menu

Direct Power On

Choose “On” to activate Direct Power mode. The projector will automatically power on when AC power is supplied, without pressing the “Power” key on the projector keypad or on the remote control.

Auto Power Off (min.)

Sets the countdown timer interval. The countdown timer will start, when there is no signal being sent to the projector. The projector will automatically power off when the countdown has finished (in minutes).

Sleep Timer (min.)

Configure the sleep timer.

- **Sleep Timer (min.):** Sets the countdown timer interval. The countdown timer will start, with or without a signal being sent to the projector. The projector will automatically power off when the countdown has finished (in minutes).
Note: *The Sleep Timer is reset every time when the projector is powered off.*
- **Always On:** Check to set the sleep timer always on.

USING THE PROJECTOR

Security menu

Security

Enable this function to prompt for a password before using the projector.

- **Off:** Choose “Off” to be able to switch on the projector without password verification.
- **On:** Choose “On” to use security verification when the turning on the projector.

Security Timer

Can be select the time (Month/Day/Hour) function to set the number of hours the projector can be used. Once this time has elapsed you will be requested to enter your password again.

Change Password

Use to set or modify the password that is prompted when turning the projector on.

Setup HDMI link settings menu

Note:

- *When you connect HDMI CEC-compatible devices to the projector with HDMI cables, you can control them on the same power on or power off status using the HDMI Link control feature in the projector’s OSD. This lets one device or multiple devices in a group power on or power off via HDMI Link Feature in a typical configuration, your DVD player may be connected to the projector through an amplifier or home theater system.*

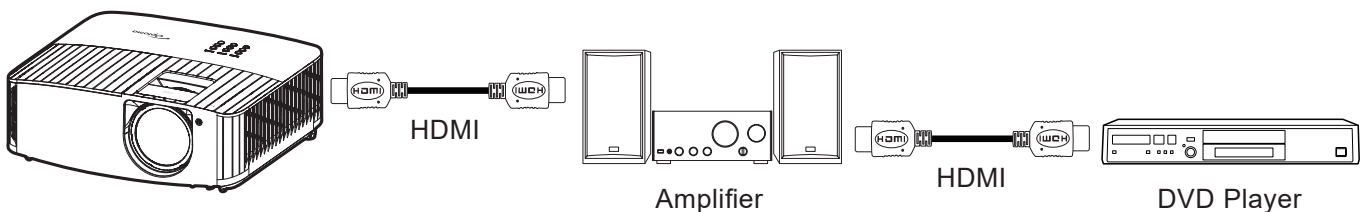

HDMI Link

Enable/disable the HDMI Link function. The inclusive TV, power on link, and power off link options will only available if the setting is set to “On”.

Power On Link

CEC power on command.

- **Mutual:** Both projector and CEC device will be turned on simultaneously.
- **PJ → Device:** The CEC device will be turned on only after the projector is switched on.
- **Device → PJ:** The projector will be switched on only after the CEC device is turned on.

Power Off Link

Enable this function to let both HDMI Link and projector to be automatically turned off at the same time.

Test Pattern menu

Select the test pattern from green grid, magenta grid, white grid, white, or disable this function (off).

Remote Settings menu

IR Function

Set the IR function setting.

- **On:** Choose “On”, the projector can be operated by the remote control from top and front IR receivers.
- **Off:** Choose “Off”, the projector can’t be operated by the remote control. By selecting “Off”, you will be able to use the Keypad keys.

USING THE PROJECTOR

User1/ User2/ User3

Assign the default function for User1, User2, or User3 between Test Pattern, Brightness, Contrast, Sleep Timer, Color Matching, Color Temp, Gamma, Projection, or Lamp Settings.

Projector ID menu

ID definition can be set up by menu (range 0-99), and allow user control an individual projector by using RS232 command.

12V Trigger menu

Use this function to enable or disable the trigger.

Note: 3.5mm mini jack that outputs 12V 500mA (max.) for relay system control.

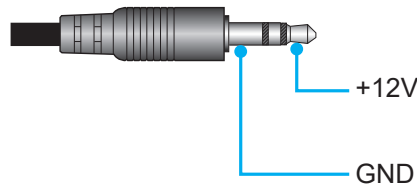

- **On:** Choose “On” to enable the trigger.
- **Off:** Choose “Off” to disable the trigger.

Options menu

Language

Select the multilingual OSD menu between English, German, French, Italian, Spanish, Portuguese, Simplified Chinese, Traditional Chinese, Japanese, Korean, and Russian.

Menu Settings

Set the menu location on the screen and configure menu timer settings.

- **Menu Location:** Select the menu location on the display screen.
- **Menu Timer:** Set the duration where the OSD menu stays visible on the screen.

Auto Source

Choose this option to let the projector automatically find an available input source.

Input Source

Select the input source between HDMI 1 and HDMI 2.

High Altitude

When “On” is selected, the fans will spin faster. This feature is useful in high altitude areas where the air is thin.

Display Mode Lock

Choose “On” or “Off” to lock or unlock adjusting display mode settings.

Keypad Lock

When the keypad lock function is “On”, the Keypad will be locked. However, the projector can be operated by the remote control. By selecting “Off”, you will be able to reuse the Keypad.

Information Hide

Enable this function to hide the information message.

- **Off:** Choose “Off” to show the “searching” message.
- **On:** Choose “On” to hide the info message.

USING THE PROJECTOR

Logo

Use this function to set the desired startup screen. If changes are made, they will take effect the next time the projector is powered on.

- **Default:** The default startup screen.
- **Neutral:** Logo is not displayed on startup screen.

Background Color

Use this function to display a blue, red, green, gray color, or none when no signal is available.

Reset menu

Reset OSD

Return the factory default settings for OSD menu settings.

Reset to Default

Return the factory default settings for all settings.

Info menu

View the projector information as listed below:

- Regulatory
- Serial Number
- Source
- Resolution
- Refresh Rate
- Display Mode
- Lamp Hours
- Projector ID
- Brightness Mode
- FW Version

ADDITIONAL INFORMATION

Compatible resolutions

Video compatibility

Signal	Resolution
SDTV	480i/p, 576i/p
HDTV	720p(50/60Hz), 1080i(50/60Hz), 1080p(24/50/60Hz)
UHD	2160p(24/50/60Hz)

Video timing in details:

Signal	Resolution	Refresh Rate (Hz)	Notes
SDTV(480I)	640 x 480	60	For Component
SDTV(480P)	640 x 480	60	
SDTV(576I)	720 x 576	50	
SDTV(576P)	720 x 576	50	
HDTV(720p)	1280 x 720	50/60	
HDTV(1080I)	1920 x 1080	50/60	
HDTV(1080p)	1920 x 1080	24/50/60	
UHD(2160p)	3840 x 2160	24/50/60	For 4K UHD

Note: Searching time for each I/O port is less than 5 seconds, except for the HDMI port.

Computer compatibility

Timing table for PC:

Signal	Resolution	Frequency H	Refresh Rate			Note
		(KHz)	(Hz)	Video	Digital	
SVGA	800 x 600	35.2	56.3	N/A	√	56Hz
SVGA	800 x 600	37.9	60.3	N/A	√	60Hz
SVGA	800 x 600	46.9	75	N/A	√	N/A
SVGA	800 x 600	48.1	72.2	N/A	√	72Hz
SVGA	800 x 600	53.7	85.1	N/A	√	85Hz
SVGA	832 x 624	N/A	75	N/A	√	N/A
XGA	1024 x 768	48.4	60	N/A	√	N/A
XGA	1024 x 768	56.5	70.1	N/A	√	70Hz
XGA	1024 x 768	60	75	N/A	√	N/A
XGA	1024 x 768	68.7	85	N/A	√	N/A
XGA	1024 x 768	N/A	120	N/A	N/A	N/A
XGA	1152 x 864	N/A	75	N/A	√	N/A
HD720	1280 x 720	N/A	50	N/A	√	N/A
HD720	1280 x 720	N/A	60	N/A	√	N/A
HD720	1280 x 720	92.62	120	N/A	N/A	N/A
WXGA	1280 x 768	47.4	60	N/A	√	N/A
WXGA	1280 x 768	N/A	75	N/A	√	N/A
WXGA	1280 x 768	N/A	85	N/A	√	N/A
WXGA-800	1280 x 800	N/A	60	N/A	√	N/A
SXGA	1280 x 1024	64	60	N/A	√	N/A
SXGA	1280 x 1024	80	75	N/A	√	N/A
SXGA	1280 x 1024	91.1	85	N/A	√	N/A

ADDITIONAL INFORMATION

Signal	Resolution	Frequency H	Refresh Rate			Note
		(KHz)	(Hz)	Video	Digital	
SXGA+	1400 x 1050	N/A	60	N/A	N/A	N/A
UXGA	1600 x 1200	75	60	N/A	√	N/A
HD1080	1920 x 1080	N/A	24	N/A	√	N/A
HD1080	1920 x 1080	N/A	50	N/A	√	N/A
HD1080	1920 x 1080	N/A	60	N/A	√	N/A
WUXGA	1920 x 1200	N/A	60	N/A	√	N/A
HDTV	1920 x 1080i	N/A	50	N/A	√	N/A
HDTV	1920 x 1080i	N/A	60	N/A	√	N/A
HDTV	1920 x 1080p	N/A	24	N/A	√	N/A
HDTV	1920 x 1080p	N/A	50	N/A	√	N/A
HDTV	1920 x 1080p	N/A	60	N/A	√	N/A
HDTV	1280 x 720	45	60	√	N/A	N/A
HDTV	1280 x 720p	N/A	50	N/A	√	N/A
HDTV	1280 x 720p	N/A	60	N/A	√	N/A
SDTV	720 x 576	31.3	50	√	N/A	N/A
SDTV	720 x 576i	N/A	50	N/A	√	N/A
SDTV	720 x 576p	N/A	50	N/A	√	N/A
SDTV	720 x 480	31.5	60	√	N/A	N/A
SDTV	720 x 480i	N/A	60	N/A	√	N/A
SDTV	720 x 480p	N/A	60	N/A	√	N/A

Note: “√” means the resolution is supported, “N/A” means the resolution is not supported.

Computer Compatibility for MAC:

Resolution	Hz	Analog
800 x 600	60	√
800 x 600	72	√
800 x 600	75	√
800 x 600	85	√
1024 x 768	60	√
1024 x 768	70	√
1024 x 768	75	√
1024 x 768	85	√
1280 x 720	60	√
1280 x 768	60	√
1280 x 768	75	√
1280 x 768	85	N/A
1280 x 800	60	√
1280 x 1024	60	√
1280 x 1024	75	√
1920 x 1080	60	√
1920 x 1200 (*1)	60	√
3840 x 2160	60	√

Note:

- “√” means the resolution is supported, “N/A” means the resolution is not supported.
- (*1) 1920 x 1200 @ 60Hz only support RB (reduced blanking).

ADDITIONAL INFORMATION

Input signal for HDMI

Signal	Resolution	Refresh Rate (Hz)	Notes for Mac
SVGA	800 x 600	60/72/85/120	Mac 60/72/85
XGA	1024 x 768	60/70/75/85/120	Mac 60/70/75/85
SDTV(480I)	640 x 480	60	N/A
SDTV(480P)	640 x 480	60	N/A
SDTV(576I)	720 x 576	50	N/A
SDTV(576P)	720 x 576	50	N/A
HDTV(720p)	1280 x 720	50/60	Mac 60
WXGA	1280 x 768	60/75/85	Mac 75
WXGA	1280 x 800	60/120	Mac 60
WXGA(*2)	1366 x 768	60	N/A
WXGA+	1440 x 900	60	Mac 60
SXGA	1280 x 1024	60/75/85	Mac 60/75
SXGA+	1400 x 1050	60/85	N/A
UXGA	1600 x 1200	60/65/70/75/85	N/A
HDTV(1080I)	1920 x 1080	50/60	N/A
HDTV(1080p)	1920 x 1080	24/30/50/60/120	Mac 60
WUXGA	1920 x 1200(*1)	60	Mac 60RB
UHD(2160p)	3840 x 2160	24/30/50/60	Mac 24/30
UHD(2160p)	4096 x 2160	24/30/50/60	Mac 24

Note:

- “√” means the resolution is supported, “N/A” means the resolution is not supported.
- (*1) 1920 x 1200 @ 60Hz only support RB (reduced blanking).
- (*2) Windows 10 standard timing.

Extended Display Identification Data (EDID) tables

Digital signal (HDMI 2.0):

B0/Established Timing	B0/Standard Timing	B0/Standard Timing	B1/Video Mode	B1/Detail Timing
Digital: Native resolution: 3840 x 2160 @ 60Hz				
800 x 600 @ 56Hz	1280 x 800 @ 60Hz	3840 x 2160 @ 60Hz(default)	720 x 480i @ 60Hz 16:9	1920 x 1080 @ 120Hz
800 x 600 @ 60Hz	1280 x 1024 @ 60Hz		720 x 480p @ 60Hz 4:3	1366 x 768 @ 60Hz
800 x 600 @ 72Hz	1920 x 1200 @ 60Hz		720 x 576i @ 50Hz 16:9	1920 x 1080 @ 240Hz
800 x 600 @ 75Hz	800 x 600 @ 120Hz		720 x 576p @ 50Hz 4:3	
832 x 624 @ 75Hz	1024 x 768 @ 120Hz		1920 x 1080i @ 60Hz 16:9	
1024 x 768 @ 60Hz	1280 x 800 @ 120Hz		1920 x 1080i @ 50Hz 16:9	
1024 x 768 @ 70Hz			1920 x 1080p @ 60Hz 16:9	
1024 x 768 @ 75Hz			1920 x 1080p @ 50Hz 16:9	
1280 x 1024 @ 75Hz			1920 x 1080p @ 24Hz 16:9	
1152 x 870 @ 75Hz			3840 x 2160 @ 24Hz	
			3840 x 2160 @ 25Hz	
			3840 x 2160 @ 30Hz	
			3840 x 2160 @ 50Hz	
			3840 x 2160 @ 60Hz	

ADDITIONAL INFORMATION

B0/Established Timing	B0/Standard Timing	B0/Standard Timing	B1/Video Mode	B1/Detail Timing
			4096 x 2160 @ 24Hz	
			4096 x 2160 @ 25Hz	
			4096 x 2160 @ 30Hz	
			4096 x 2160 @ 50Hz	
			4096 x 2160 @ 60Hz	

True 3D video compatibility

Input resolutions	HDMI 1.4a 3D Input	Input timing		
		1280 x 720P @ 50Hz	Top-and-Bottom	
		1280 x 720P @ 60Hz	Top-and-Bottom	
		1280 x 720P @ 50Hz	Frame packing	
		1280 x 720P @ 60Hz	Frame packing	
		1920 x 1080i @ 50Hz	Side-by-Side(Half)	
		1920 x 1080i @ 60Hz	Side-by-Side(Half)	
		1920 x 1080P @ 24Hz	Top-and-Bottom	
		1920 x 1080P @ 24Hz	Frame packing	
	HDMI 1.3	1920 x 1080i @ 50Hz	Side-by-Side(Half)	SBS mode is on
		1920 x 1080i @ 60Hz		
		1280 x 720P @ 50Hz		
		1280 x 720P @ 60Hz		
		1920 x 1080i @ 50Hz	Top-and-Bottom	TAB mode is on
		1920 x 1080i @ 60Hz		
		1280 x 720P @ 50Hz		
		1280 x 720P @ 60Hz		
		480i 1024 x 768 @ 120Hz	HQFS	3D format is Frame sequential
		1280 x 720 @ 120Hz		

ADDITIONAL INFORMATION

Image size and projection distance

Diagonal Length Size of (16:9) Screen	Screen Size W x H				Projection Distance (D)				Offset (HD)	
	(m)		(inch)		(m)		(feet)		(m)	(inch)
	Width	Height	Width	Height	Wide	Tele	Wide	Tele		
36.43	0.81	0.45	31.75	17.90	0.40	N/A	1.31	N/A	0.08	3.15
50.00	1.11	0.62	43.58	24.50	0.55	N/A	1.80	N/A	0.10	3.94
60.00	1.33	0.75	52.29	29.40	0.66	N/A	2.17	N/A	0.12	4.72
70.00	1.55	0.87	61.01	34.30	0.77	N/A	2.53	N/A	0.14	5.51
80.00	1.77	1	69.73	39.20	0.88	N/A	2.89	N/A	0.16	6.30
90.00	1.99	1.12	78.44	44.10	0.99	N/A	3.25	N/A	0.18	7.09
100.00	2.21	1.25	87.16	49.00	1.10	N/A	3.61	N/A	0.19	7.48
120.00	2.66	1.49	104.59	58.80	1.32	N/A	4.33	N/A	0.24	9.45
150.00	3.32	1.87	130.74	73.50	1.65	N/A	5.41	N/A	0.30	11.81
180.00	3.98	2.24	156.88	88.20	1.98	N/A	6.50	N/A	0.36	14.17
200.00	4.43	2.49	174.32	98.10	2.20	N/A	7.22	N/A	0.40	15.75
250.00	5.53	3.11	217.89	122.60	2.75	N/A	9.02	N/A	0.50	19.69
300.53	6.65	3.74	261.93	147.30	3.30	N/A	10.83	N/A	0.60	23.62

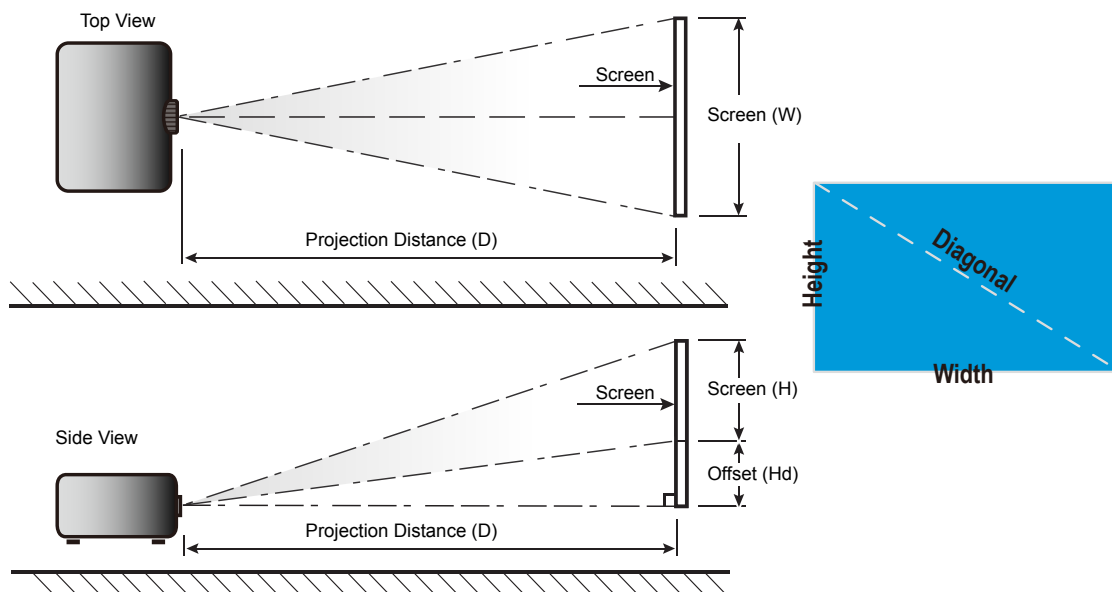

ADDITIONAL INFORMATION

Projector dimensions and ceiling mount installation

1. To prevent damage to your projector, please use the Optoma ceiling mount.
2. If you wish to use a third party ceiling mount kit, please ensure the screws used to attach a mount to the projector meet the following specifications:
 - Screw type: M4 for two point mounting or M6 for one point mounting
 - Minimum screw length: 10mm

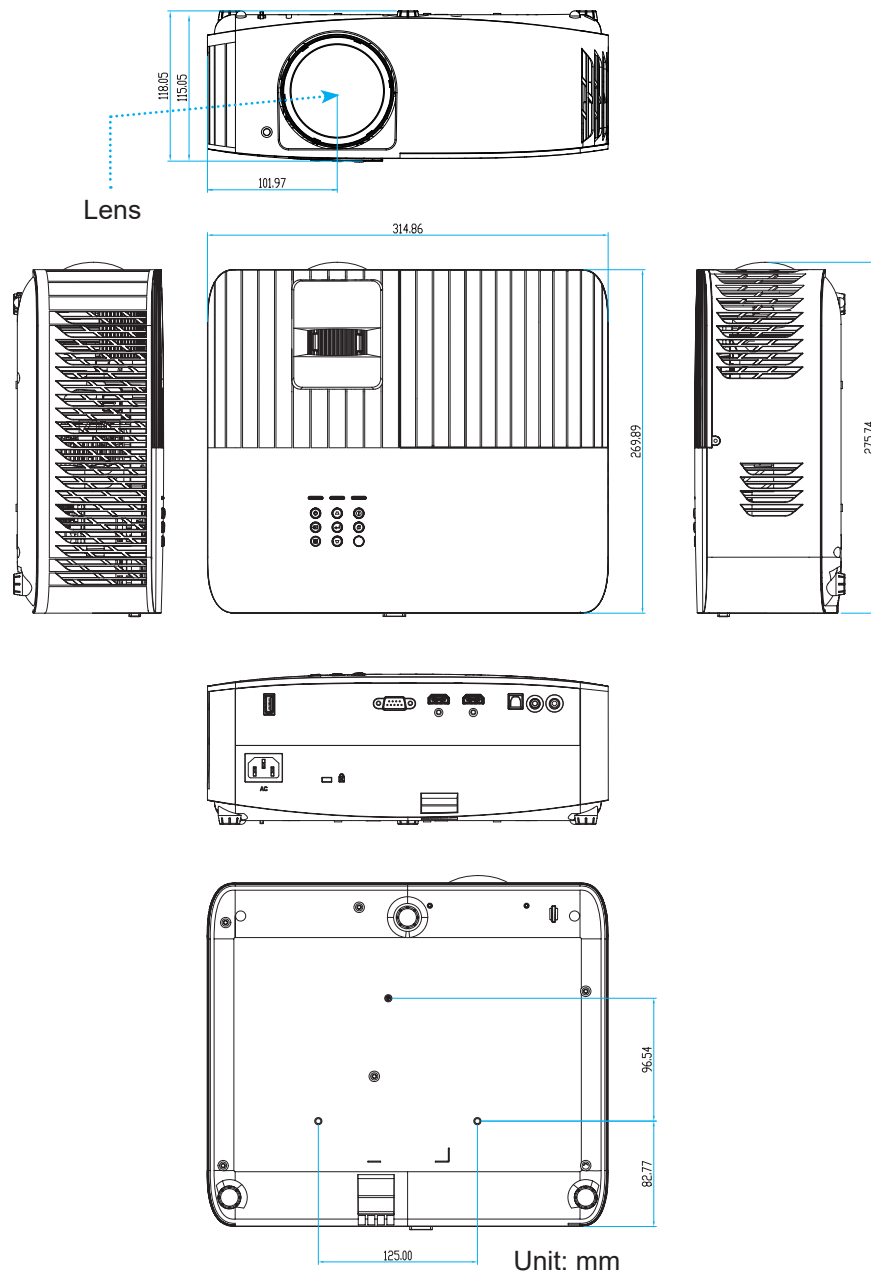

Note: Please note that damage resulting from incorrect installation will void the warranty.



Warning:

- If you buy a ceiling mount from another company, please be sure to use the correct screw size. Screw size will vary depending on the thickness of the mounting plate.
- Be sure to keep at least 10 cm gap between the ceiling and the bottom of the projector.
- Avoid installing the projector near a heat source.





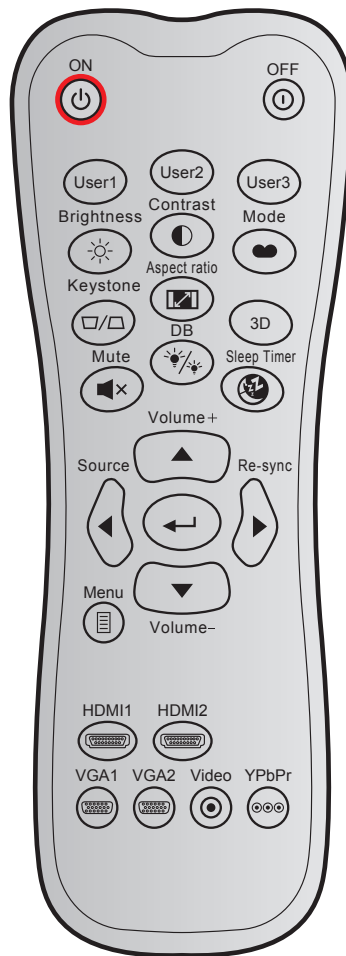











ADDITIONAL INFORMATION

IR remote codes



Key	NEC format	Customer code		Key code		Description	
		Byte 1	Byte 2	Byte 3	Byte 4		
Power on		FORMAT 1	32	CD	02	FD	Press to turn on the projector.
Power off		FORMAT 1	32	CD	2E	D1	Press to turn off the projector.
User1		FORMAT 1	32	CD	36	C9	User defined keys.
User2		FORMAT 1	32	CD	65	9A	
User3		FORMAT 1	32	CD	66	99	
Brightness		FORMAT 1	32	CD	41	BE	Adjust the brightness of the image.
Contrast		FORMAT 1	32	CD	42	BD	Control the degree of difference between the lightest and darkest parts of the picture.
Display mode		FORMAT 1	32	CD	05	FA	Select a display mode for optimized settings for different applications.
Keystone		FORMAT 1	32	CD	07	F8	Press to adjust image distortion caused by tilting the projector.
Aspect ratio		FORMAT 1	32	CD	64	9B	Press to change aspect ratio of a displayed image.

ADDITIONAL INFORMATION

Key	NEC format	Customer code		Key code		Description	
		Byte 1	Byte 2	Byte 3	Byte 4		
3D	FORMAT 1	32	CD	89	76	Press to enable/disable the 3D mode function.	
Mute 	FORMAT 1	32	CD	52	AD	Momentarily turns off / on the audio.	
DB (Dynamic Black) 	FORMAT 1	32	CD	44	BB	Automatically adjusts the picture brightness to give optimum contrast performance.	
Sleep timer 	FORMAT 1	32	CD	63	9C	Sets the countdown timer interval.	
Volume +	FORMAT 2	32	CD	11	EE	Adjust to increase volume.	
		FORMAT 2	32	CD	11	EE	Use ▲, ◀, ▶, or ▼ to select items or make adjustments to your selection.
		FORMAT 2	32	CD	10	EF	
		FORMAT 2	32	CD	12	ED	
		FORMAT 2	32	CD	14	EB	
Source	FORMAT 2	32	CD	10	EF	Press "Source" to select an input signal.	
Enter key 	FORMAT 1	32	CD	0F	F0	Confirm your item selection.	
Re-sync	FORMAT 2	32	CD	12	ED	Automatically synchronizes the projector to the input source.	
Volume -	FORMAT 2	32	CD	14	EB	Adjust to decrease volume.	
Menu 	FORMAT 1	32	CD	0E	F1	Display or exit the on-screen display menus for projector.	
HDMI1 	FORMAT 1	32	CD	16	E9	Press "HDMI1" to choose source from HDMI 1 connector.	
HDMI2 	FORMAT 1	32	CD	30	CF	Press "HDMI2" to choose source from HDMI 2 connector.	
VGA1 	FORMAT 1	32	CD	1B	E4	No function	
VGA2 	FORMAT 1	32	CD	1E	E1	No function	
Video 	FORMAT 1	32	CD	1C	E3	No function	
YPbPr 	FORMAT 1	32	CD	17	E8	No function	

ADDITIONAL INFORMATION

Troubleshooting

If you experience a problem with your projector, please refer to the following information. If a problem persists, please contact your local reseller or service center.

Image problems

- ❓ *No image appears on-screen*
 - Ensure all the cables and power connections are correctly and securely connected as described in the "Setup and Installation" section.
 - Ensure the pins of connectors are not crooked or broken.
 - Ensure that the "Mute" feature is not turned on.

- ❓ *Image is out of focus*
 - Adjust the Focus Ring on the projector lens. Please see page 16.
 - Make sure the projection screen is between the required distance from the projector. (Please refer to page 44).

- ❓ *The image is stretched when displaying 16:9 DVD title*
 - When you play anamorphic DVD or 16:9 DVD, the projector will show the best image in 16: 9 format on projector side.
 - If you play the LBX format DVD title, please change the format as LBX in projector OSD.
 - If you play 4:3 format DVD title, please change the format as 4:3 in projector OSD.
 - Please setup the display format as 16:9 (wide) aspect ratio type on your DVD player.

- ❓ *Image is too small or too large*
 - Move the projector closer to or further from the screen.
 - Press "Menu" on the projector panel, go to "Display-->Aspect Ratio". Try the different settings.

- ❓ *Image has slanted sides:*
 - If possible, reposition the projector so that it is centered on the screen and below the bottom of the screen.

- ❓ *Image is reversed*
 - Select "Setup-->Projection" from the OSD and adjust the projection direction.

- ❓ *Blurry double image*
 - Make sure "Display Mode" is not 3D to avoid normal 2D image appear blurry double image.

ADDITIONAL INFORMATION

Other problems



The projector stops responding to all controls

- If possible, turn off the projector, then unplug the power cord and wait at least 20 seconds before reconnecting power.

Remote control problems



If the remote control does not work

- Check the operating angle of the remote control is pointed within $\pm 15^\circ$ to the IR receivers on the projector.
- Make sure there are not any obstructions between the remote control and the projector. Move to within 6 m (~19 ft) of the projector.
- Make sure batteries are inserted correctly.
- Replace batteries if they are exhausted.

Warning indicators

When the warning indicators (see below) light up or flash, the projector will automatically shutdown:

- "LAMP" LED indicator is lit red and if "On/Standby" indicator flashes red.
- "TEMP" LED indicator is lit red and if "On/Standby" indicator flashes red. This indicates the projector has overheated. Under normal conditions, the project can be switched back on.
- "TEMP" LED indicator flashes red and if "On/Standby" indicator flashes red.

Unplug the power cord from the projector, wait for 30 seconds and try again. If the warning indicator light up or flash, please contact your nearest service center for assistance.

ADDITIONAL INFORMATION

LED lightning messages

Message	On/Standby LED		Temp LED	Lamp LED
	(Red)	(Blue)	(Red)	(Red)
Standby state (Input power cord)	Steady light			
Power on (Warming)		Flashing (0.5 sec off / 0.5 sec on)		
Power on and Lamp lighting		Steady light		
Power off (Cooling)		Flashing (0.5 sec off / 0.5 sec on). Back to red steady light when cooling fan turns off.		
Error (Lamp failure)	Flashing			Steady light
Error (Fan failure)	Flashing		Flashing	
Error (Over temp.)	Flashing		Steady light	
Standby State (Burn in mode)		Flashing		
Burn in (Warming)		Flashing		
Burn in (Cooling)		Flashing		
Burn in (Lamp lighting)		Flashing (3 sec on / 1 sec off)		
Burn in (Lamp off)		Flashing (1 sec on / 3 sec off)		

- Power off:

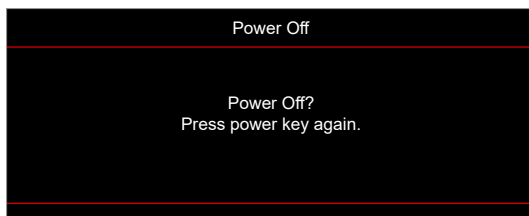

- Temperature warning:

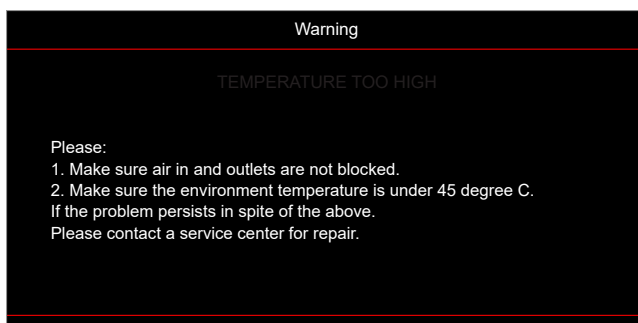

ADDITIONAL INFORMATION

- Lamp warning:



- Fan failed:

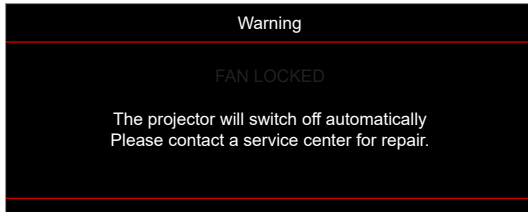

- Out of display range:

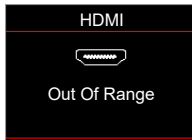

- Power down warning:

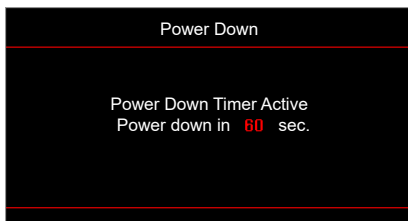

ADDITIONAL INFORMATION

Specifications

Optical	Description
Technology	Texas Instrument DMD, 0.65" 4K UHD ECD DMD x1 with 4-Way XPR actuator
Output resolution	4K UHD 3840 x 2160
Maximum input resolution	Graphic up to 3840x2160@60Hz <ul style="list-style-type: none">• HDMI1 (2.0): 3840x2160@60Hz• HDMI2 (2.0): 3840x2160@60Hz Maximum Bandwidth: <ul style="list-style-type: none">• HDMI 2.0: 600MHz
Lens	<ul style="list-style-type: none">• Throw ratio: 0.496 ±3%• F-stop: 2.8• Focal length: 7.51 mm
Offset	116% ±5%
Image size	36.43~300.53", optimized at 89.07" wide @0.978m
Projection distance	0.4m~3.3m
I/Os	<ul style="list-style-type: none">• HDMI 2.0 x2• USB Type-A for Power USB 5V/1.5A and service• Audio Out 3.5mm• S/PDIF• 12V Out• RS232(D-SUB9)
Colour	1073.4 Million color
Scan rate	<ul style="list-style-type: none">• Horizontal scan rate: 31~135 KHz• Vertical scan rate: 24~120Hz and 240Hz for 1080P
Speaker	10W x1
Power consumption	<ul style="list-style-type: none">• Maximum: (Bright mode)<ul style="list-style-type: none">• 300W (typical), 330W(max)@110VAC• 290W (typical), 320W(max)@220VAC• Minimum: (ECO mode)<ul style="list-style-type: none">• 210W (typical), 231W(max)@110VAC• 200W (typical), 220W(max)@220VAC
Power requirement	100~240V ±10%, AC 50/60Hz
Input current	3.3A
Installation orientations	Front, Rear, Ceiling-top, Rear-top
Dimensions (W x D x H)	<ul style="list-style-type: none">• Without feet: 315 x 270 x 115 mm (12.40 x 10.62 x 4.52 inches)• With feet: 315 x 270 x 118 mm (12.40 x 10.62 x 4.64 inches)
Weight	3.5 kg (7.71 lbs)
Environmental	Operating in 5~40°C, 10%~80% humidity (non-condensing)

Note: All specifications are subject to change without notice.



ADDITIONAL INFORMATION

Optoma global offices

For service or support, please contact your local office.



USA

Optoma Technology, Inc.
47697 Westinghouse Drive.
Fremont, Ca 94539

 888-289-6786
 510-897-8601
 services@optoma.com



Canada

Optoma Technology, Inc.
47697 Westinghouse Drive.
Fremont, Ca 94539

 888-289-6786
 510-897-8601
 services@optoma.com



Latin America

Optoma Technology, Inc.
47697 Westinghouse Drive.
Fremont, Ca 94539

 888-289-6786
 510-897-8601
 services@optoma.com



Europe

Unit 1, Network 41, Bourne End Mills
Hemel Hempstead, Herts,
HP1 2UJ, United Kingdom
www.optoma.eu
Service Tel : +44 (0)1923 691865

 +44 (0) 1923 691 800
 +44 (0) 1923 691 888
 service@tsc-europe.com



Benelux BV

Randstad 22-123
1316 BW Almere
The Netherlands
www.optoma.nl

 +31 (0) 36 820 0252
 +31 (0) 36 548 9052



France

Bâtiment E
81-83 avenue Edouard Vaillant
92100 Boulogne Billancourt, France

 +33 1 41 46 12 20
 +33 1 41 46 94 35
 savoptoma@optoma.fr



Spain

C/ José Hierro,36 Of. 1C
28522 Rivas VaciaMadrid,
Spain

 +34 91 499 06 06
 +34 91 670 08 32



Deutschland

Am Nordpark 3
41069 Mönchengladbach
Germany

 +49 (0) 2161 68643 0
 +49 (0) 2161 68643 99
 info@optoma.de

Scandinavia

Lerpeveien 25
3040 Drammen
Norway

 +47 32 98 89 90
 +47 32 98 89 99
 info@optoma.no

PO.BOX 9515
3038 Drammen
Norway

Korea

<https://www.optoma.com/kr/>

Japan



<https://www.optoma.com/jp/>

Taiwan

<https://www.optoma.com/tw/>

China

Room 2001, 20F, Building 4,
No.1398 Kaixuan Road,
Changning District
Shanghai, 200052, China

 +86-21-62947376
 +86-21-62947375
www.optoma.com.cn

Australia

<https://www.optoma.com/au/>

