



DLP® Projector

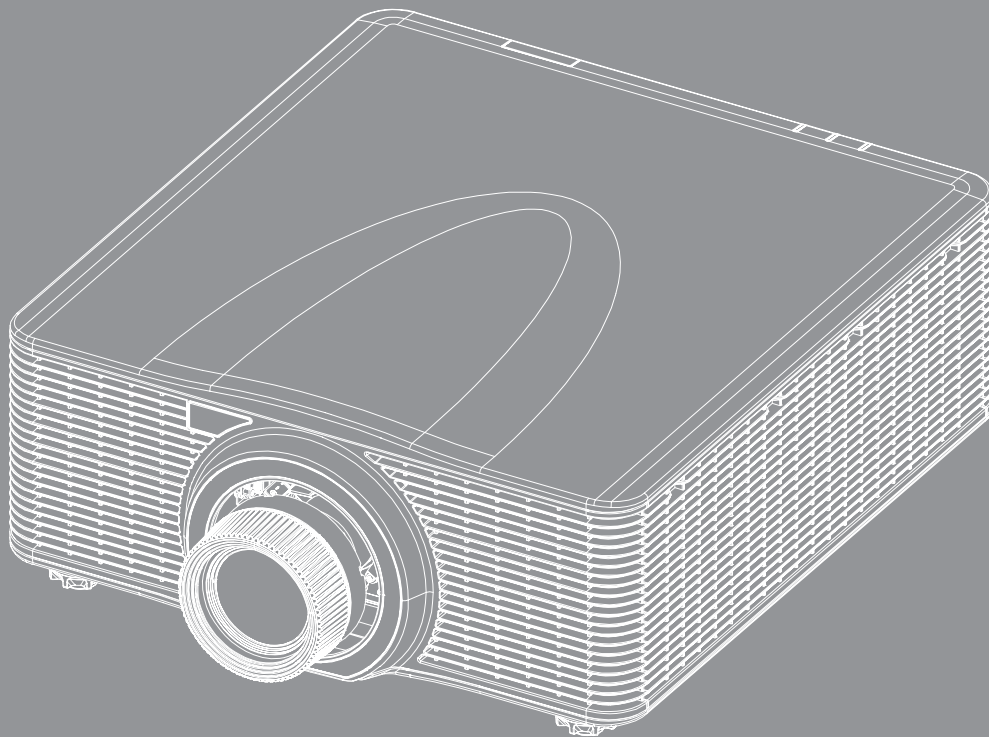

TABLE OF CONTENTS

SAFETY..... 5

<i>Important safety instructions.....</i>	<i>5</i>
<i>Light Intensity Hazard Distance.....</i>	<i>6</i>
<i>Laser radiation safety information.....</i>	<i>6</i>
<i>Product safety labels.....</i>	<i>7</i>
<i>Light beam related safety labels.....</i>	<i>7</i>
<i>Copyright.....</i>	<i>8</i>
<i>Disclaimer.....</i>	<i>8</i>
<i>Trademark recognition.....</i>	<i>8</i>
<i>FCC.....</i>	<i>8</i>
<i>Declaration of conformity for EU countries.....</i>	<i>9</i>
<i>WEEE.....</i>	<i>9</i>

INTRODUCTION 10

<i>Package overview.....</i>	<i>10</i>
<i>Standard accessories.....</i>	<i>10</i>
<i>Optional accessories.....</i>	<i>11</i>
<i>Product overview.....</i>	<i>12</i>
<i>Connections.....</i>	<i>13</i>
<i>Keypad.....</i>	<i>14</i>
<i>Remote control.....</i>	<i>15</i>

SETUP AND INSTALLATION..... 16

<i>Installing the projection lens.....</i>	<i>16</i>
<i>Adjusting the projector position.....</i>	<i>18</i>
<i>Boresight adjustment.....</i>	<i>20</i>
<i>Required tool.....</i>	<i>20</i>
<i>Setting the projector start mode.....</i>	<i>20</i>
<i>Performing the boresight adjustment.....</i>	<i>20</i>
<i>BX-CTA17 Boresight Tool Operating.....</i>	<i>23</i>
<i>Connecting sources to the projector.....</i>	<i>25</i>
<i>Adjusting the projector image.....</i>	<i>26</i>
<i>Remote setup.....</i>	<i>27</i>

USING THE PROJECTOR 30

<i>Powering on / off the projector.....</i>	<i>30</i>
<i>Selecting an input source.....</i>	<i>31</i>
<i>Menu navigation and features.....</i>	<i>32</i>
<i>OSD menu tree.....</i>	<i>33</i>
<i>Image menu.....</i>	<i>48</i>
<i>Picture Mode.....</i>	<i>48</i>
<i>Dynamic Range.....</i>	<i>49</i>



Brightness	49
Contrast.....	49
Sharpness	49
Gamma.....	49
Dynamic Contrast.....	50
Color Settings.....	50
Wall Color.....	51
3D Setup	51
Save to User.....	53
Apply to User.....	53
Reset	53
Display menu.....	54
Aspect Ratio	54
Digital Zoom	54
Geometric Correction	55
Edge Mask	57
Freeze Screen.....	57
Test Pattern	57
PIP/PBP.....	58
Reset	59
Input Settings menu.....	60
Auto Source.....	60
Quick Resync	60
Active Inputs.....	60
Latency Adjustment.....	60
Backup Input	60
HDMI	61
Reset	61
Device Setup menu	62
Language	62
Projection	62
Lens Settings.....	62
Active Image Setup	64
Schedule	64
Date and Time.....	66
Power Settings	67
Light Source Settings	67
Shutter.....	68
Security	68
On Screen Display	68
Logo Setup.....	69
Backlight.....	69
High Altitude	69
User Data	69
System Update (FOTA).....	69
Reset	69
Communication menu.....	70
Projector ID	70
Remote Setup	70
Network Setup.....	71
Email Notification.....	71

<i>Control</i>	71
<i>Baud Rate</i>	72
<i>Reset</i>	72
<i>Using the web control panel</i>	73
<i>Using RS232 command by Telnet</i>	76
<i>Info menu</i>	76

ADDITIONAL INFORMATION..... 77

<i>Compatible resolutions</i>	77
<i>Image size and projection distance</i>	91
<i>Ceiling mount installation</i>	94
<i>Projector dimensions</i>	94
<i>Ceiling mount information</i>	94
<i>IR remote codes</i>	95
<i>Troubleshooting</i>	97
<i>LED status indicators</i>	98
<i>Specifications</i>	99
<i>Optoma global offices</i>	100

SAFETY

	The lightning flash with arrow head within an equilateral triangle is intended to alert the user to the presence of uninsulated "dangerous voltage" within the product's enclosure that may be of sufficient magnitude to constitute a risk of electric shock to persons.
	The exclamation point within an equilateral triangle is intended to alert the user to the presence of important operating and maintenance (servicing) instructions in the literature accompanying the appliance.

Please follow all warnings, precautions and maintenance as recommended in this user manual.

Important safety instructions

- Do not block any ventilation openings. To ensure reliable operation of the projector and to protect from overheating, it is recommended to install the projector in a location that does not block ventilation. As an example, do not place the projector on a crowded surface. Do not put the projector in an enclosure such as a book case or a cabinet that restricts air flow.
- To reduce the risk of fire and/or electric shock, do not expose the projector to rain or moisture. Do not install near heat sources such as radiators, heaters, stoves or any other apparatus such as amplifiers that emits heat.
- Do not let objects or liquids enter the projector. They may touch dangerous voltage points and short out parts that could result in fire or electric shock.
- Do not use under the following conditions:
 - In extremely hot, cold or humid environments.
 - (i) Ensure that the ambient room temperature is within 0°C~40°C (32°F~104°F)
 - (ii) Relative humidity is 10% ~ 85%
 - In areas susceptible to excessive dust and dirt.
 - Near any appliance generating a strong magnetic field.
 - In direct sunlight.
- Do not use the unit if it has been physically damaged or abused. Physical damage/abuse would be (but not limited to):
 - Unit has been dropped.
 - Power supply cord or plug has been damaged.
 - Liquid has been spilled on to the projector.
 - Projector has been exposed to rain or moisture.
 - Something has fallen in the projector or something is loose inside.
- Do not place the projector on an unstable surface. The projector may fall over resulting in injury or the projector may become damaged.
- Do not block the light coming out of the projector lens when in operation. The light will heat the object and cause it to melt, burn or start a fire.
- Please do not open or disassemble the projector as this may cause electric shock.
- Do not attempt to service the unit yourself. Opening or removing covers may expose you to dangerous voltages or other hazards. Please call Optoma before you send the unit for repair.
- See projector enclosure for safety related markings.
- The unit should only be repaired by authorized service personnel.
- Only use attachments/accessories specified by the manufacturer.
- Do not look straight into the projector lens during operation. The bright light may harm your eyes.
- Turn off and unplug the power plug from the AC outlet before cleaning the product.
- Use a soft dry cloth with mild detergent to clean the projector housing. Do not use abrasive cleaners,

- Disconnect the power plug from the AC outlet if the product will not be used for a long period of time.
- Do not setup the projector in places where it might be subjected to vibration or shock.
- Do not touch the lens with bare hands.
- Do not clean the lens when the projector is turned on. Any damage resulting from doing so will void the warranty.
- Remove battery/batteries from remote control before storage. If the battery/batteries are left in the remote for long periods, they may leak.
- Do not use or store the projector in places where smoke from oil or cigarettes may be present, as it can adversely affect the quality of the projector performance.
- Please follow the correct projector orientation installation as non standard installation may affect the projector performance.
- Use a power strip and/or surge protector. As power outages and brown-outs can KILL devices.
- Warning: Do not remove the earthing pin on the mains plugs. This apparatus is equipped with a three prong earthing type mains plug. This plug will only fit an earthing-type mains socket. This is a safety feature. If you are unable to insert the plug into the mains socket, contact an electrician.
- Caution: This equipment is equipped with a three-pin grounding-type power plug. Do not remove the grounding pin on the power plug. This plug will only fit a grounding-type power outlet. This is a safety feature. If you are unable to insert the plug into the outlet, contact an electrician.

Light Intensity Hazard Distance

This product is classified as CLASS 1 LASER PRODUCT - RISK GROUP 2 of IEC 60825-1 : 2014 and also complies with 21 CFR 1040.10 and 1040.11 except for conformance as a Risk Group 2 LIP as defined in IEC 62471-5:Ed. 1.0. For more information, see Laser Notice No. 57, dated May 8, 2019.

When set up with BX-CTA13 lens (throw ratio greater than 2.92), this projector may become Class 1 Laser Product-Risk Group 3 (RG3); with other lens (throw ratio less than 2.92), this projector may become Class 1 Laser Product-Risk Group 2 (RG2) according to IEC 60825-1:2014 and IEC 62471-5: 2015, and also make a variance approvals under 21 CFR 1010.4 for RG3 LIP according to Classification and Requirements for Laser Illuminated Projectors (LIPs) (Laser Notice No. 57).

Projection Lens	Throw Ratio	Classification and Requirements for Laser Illuminated Projectors (LIPs)	
• BX-CAA01	• 0.95-1.22	• HD: N/A	<ul style="list-style-type: none"> • IEC 62471-5: 2015 • IEC 60825-1: 2014 • CLASS 1 LASER PRODUCT RISK GROUP 2
• BX-CAA03	• 1.52-2.92		
• BX-CAA06	• 1.22-1.52		
• BX-CTA15	• 0.75-0.95		
• BX-CTA16	• 0.361(120")		
• BX-CTA17	• 0.65-0.75		

Projection Lens	Throw Ratio	Classification and Requirements for Laser Illuminated Projectors (LIPs)	
• BX-CTA13	• 2.9-5.5	• HD: 2.2 meters	<ul style="list-style-type: none"> • IEC 62471-5: 2015 • IEC 60825-1: 2014 • CLASS 1 LASER PRODUCT RISK GROUP 3

Laser radiation safety information

To ensure safe operation, read all laser safety precautions before installing and operating the projector.

- This projector is class 1 laser product of IEC/EN 60825-1:2014 and risk group 2 with the requirements of IEC 62471-5:2015.
- This projector uses extremely high brightness laser. Do not stare directly into the light beam, as the extremely high brightness may cause permanent eye damage. (Risk Group 2 of IEC 62471-5:2015).
- No direct exposure to the beam shall be permitted. (Risk Group 3 of IEC 62471-5:2015).
- This product is not for household use.
- Possibly hazardous optical radiation emitted from this product.

- This projector has a built-in Class 4 laser module. Never attempt to disassemble or modify the laser module.
- Any operation or adjustment not specifically instructed in the User manual creates the risk of hazardous laser radiation exposure.
- Do not stare into beam when the projector is on. When turning on the projector, make sure no one within projection range is looking into the lens.
- Follow the control, adjustment, or operation procedures to avoid damage or injury from exposure to laser radiation.
- The instructions for the assembly, operation, and maintenance include clear warnings to avoid possible exposure to hazardous laser radiation.
- We recommend you install this projector above the reach of children.
- Notice is given to supervise children and to never allow them to stare into the projector beam at any distance from the projector.
- Notice is given to use caution when using the remote control for starting the projector while in front of the projection lens.
- Notice is given to the user to avoid the use of optical aids such as binoculars or telescopes inside the beam.

Product safety labels

Light beam related safety labels

Label image

Label description



"WARNING: MOUNT ABOVE THE REACH AND SIGHT OF CHILDREN."
The use of a ceiling mount is recommended with this product to place it above the eye level of children.
Additional warning against eye exposure for close exposures less than 1 m.

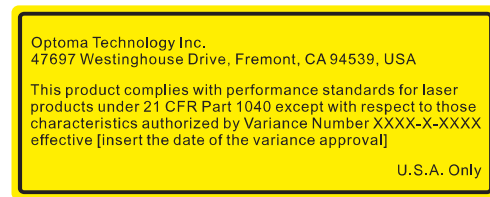

FDA laser variance (US projectors only)

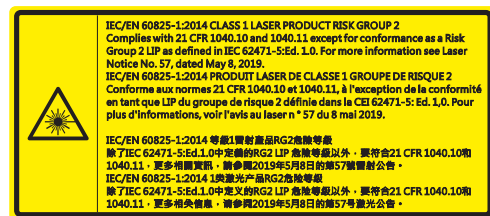

This product is classified as Class 1 Laser Product-Risk Group 2 of IEC 60825-1:2014 and also complies with 21 CFR 1040.10 and 1040.11 as a Risk Group 2, LIP (Laser Illuminated Projector) as defined in IEC 62471-5:Ed.1.0. For more information, see Laser Notice No. 57, dated May 8, 2019.



This projector may become Risk Group 3 product when an interchangeable lens with throw ratio greater than 2.92 is installed. Refer to the manual for the lens list and hazard distance before operation. Such combinations of projector and lens are intended for professional use only, and are not intended for consumer use.
Not for household use.
No direct exposure to beam shall be permitted, which can cause injury to the retina in the back of the eye.
As with any bright light source, do not stare into the beam, RG2 IEC 62471-5:2015

Copyright

This publication, including all photographs, illustrations and software, is protected under international copyright laws, with all rights reserved. Neither this manual, nor any of the material contained herein, may be reproduced without written consent of the author.

© Copyright 2022

Disclaimer

The information in this document is subject to change without notice. The manufacturer makes no representations or warranties with respect to the contents hereof and specifically disclaims any implied warranties of merchantability or fitness for any particular purpose. The manufacturer reserves the right to revise this publication and to make changes from time to time in the content hereof without obligation of the manufacturer to notify any person of such revision or changes.

Trademark recognition

Kensington is a U.S. registered trademark of ACCO Brand Corporation with issued registrations and pending applications in other countries throughout the world.

HDMI, the HDMI Logo, and High-Definition Multimedia Interface are trademarks or registered trademarks of HDMI Licensing LLC in the United States and other countries.

DLP®, DLP Link and the DLP logo are registered trademarks of Texas Instruments and BrilliantColor™ is a trademark of Texas Instruments.

HDBaseT™ and the HDBaseT Alliance logo are trademarks of the HDBaseT Alliance.

All other product names used in this manual are the properties of their respective owners and are Acknowledged.

FCC

This device has been tested and found to comply with the limits for a Class A digital device pursuant to Part 15 of the FCC rules. These limits are designed to provide reasonable protection against harmful interference in a residential installation. This device generates, uses and can radiate radio frequency energy and, if not installed and used in accordance with the instructions, may cause harmful interference to radio communications.

However, there is no guarantee that interference will not occur in a particular installation. If this device does cause harmful interference to radio or television reception, which can be determined by turning the device off and on is encouraged to try to correct the interference by one or more of the following measures:

- Reorient or relocate the receiving antenna.
- Increase the separation between the device and receiver.
- Connect the device into an outlet on a circuit different from that to which the receiver is connected.
- Consult the dealer or an experienced radio/television technician for help.

Notice: Shielded cables

All connections to other computing devices must be made using shielded cables to maintain compliance with FCC regulations.

Caution

Changes or modifications not expressly approved by the manufacturer could void the user's authority, which is granted by the Federal Communications Commission, to operate this projector.

Operation conditions

This device complies with Part 15 of the FCC Rules. Operation is subject to the following two conditions:

1. This device may not cause harmful interference and
2. This device must accept any interference received, including interference that may cause undesired operation.

Notice: Canadian users

This Class A digital apparatus complies with Canadian ICES-003.

Remarque à l'intention des utilisateurs canadiens

Cet appareil numérique de la classe A est conforme de la norme NMB-003 du Canada.

Declaration of conformity for EU countries

- EMC Directive 2014/30/EU (including amendments)
- Low Voltage Directive 2014/35/EU
- Radio Equipment Directive 2014/53/EU (if product has RF function)
- RoHS Directive 2011/65/EU

WEEE



Disposal instructions

Do not throw this electronic device into the trash when discarding. To minimize pollution and ensure utmost protection of the global environment, please recycle it.

INTRODUCTION

Package overview

Carefully unpack and verify that the projector comes with all the standard accessories shown below. Some accessories may not be available depending on the projector model, specification and your region of purchase. The warranty card is only supplied in specific regions. Please check with your place of purchase or consult your dealer for more information.

Standard accessories

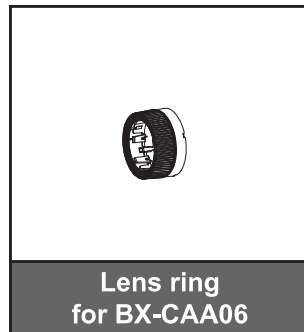
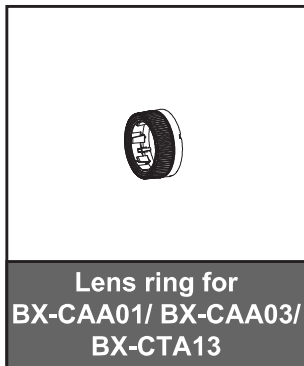
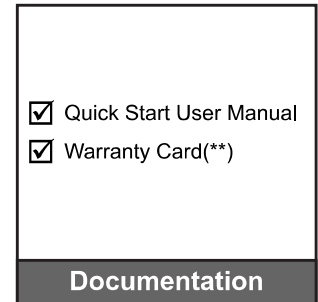
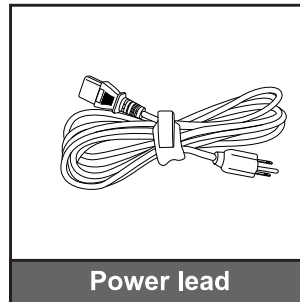
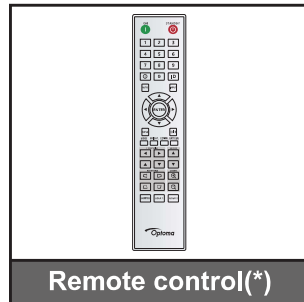

Note:

- (*) The remote control requires two AAA batteries. See *Installing/replacing the batteries* on page 27 for more information.
- (**) For European warranty information, please visit www.optoma.com.



Please scan the OPAM warranty QR code or visit the following URL:
<https://www.optoma.com/us/support/warranty-and-return-policy/>



Please scan the QR code or visit the following URL: <https://www.optoma.com/support/download>

INTRODUCTION

Optional accessories

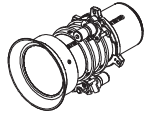

Optional lens
BX-CAA01 (0.95-1.22)

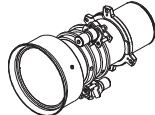

Optional lens
BX-CAA03 (1.52-2.92)

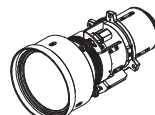

Optional lens
BX-CAA06 (1.22-1.52)

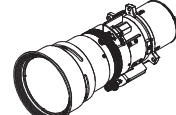

Optional lens
BX-CTA13 (2.9-5.5)

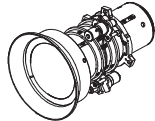

Optional lens
BX-CTA15 (0.75-0.95)

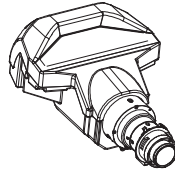

Optional lens
BX-CTA16 (0.361(120''))

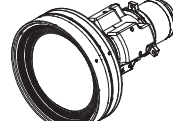

Optional lens
BX-CTA17 (0.65-0.75)

Note: *The accessories may vary depending on model, specification and region.*

INTRODUCTION

Product overview

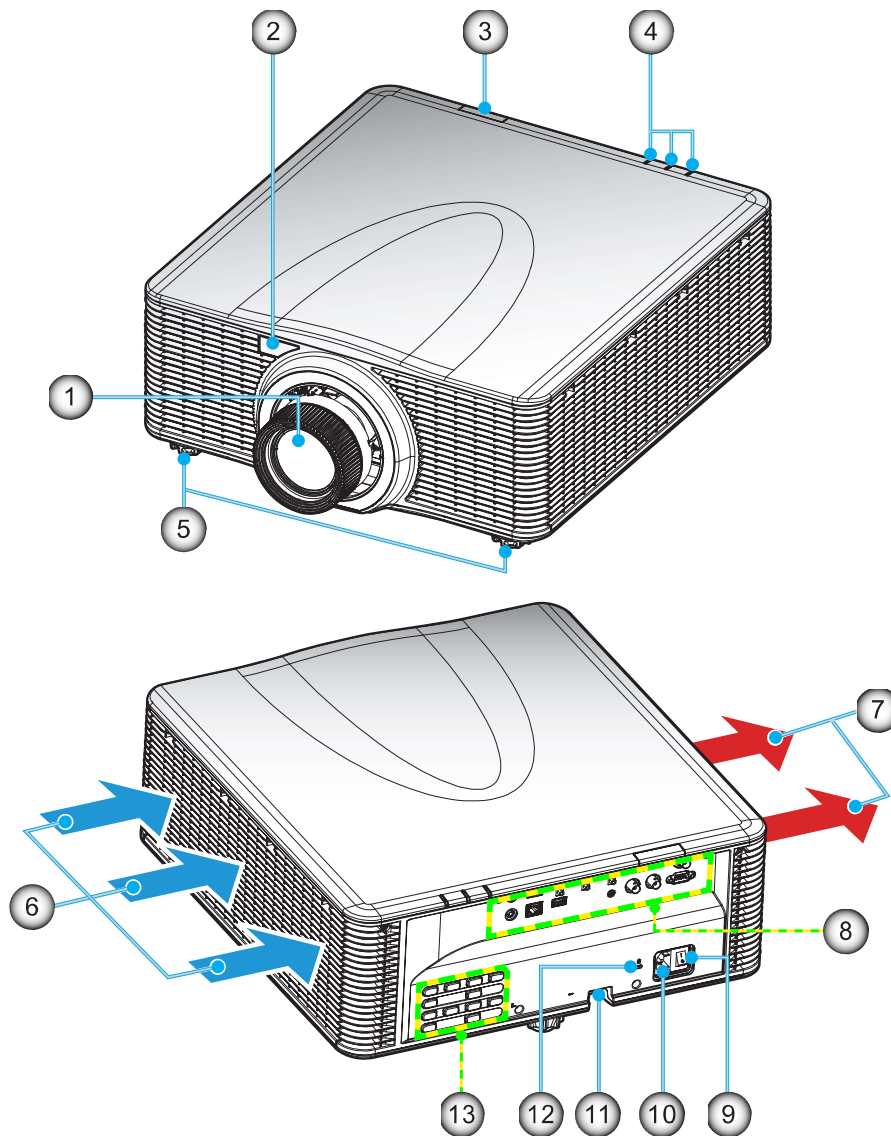

No	Item	No	Item
1.	Lens	8.	Input / Output
2.	Front IR Receiver	9.	Power Switch
3.	Top IR Receiver	10.	Power Socket
4.	LED Status Indicators	11.	Security Bar
5.	Tilt-Adjustment Feet	12.	Kensington™ Lock Port
6.	Ventilation (inlet)	13.	Keypad
7.	Ventilation (outlet)		

Note: Do not block projector inlet or outlet air vents.

INTRODUCTION

Connections

Rear I/O panel

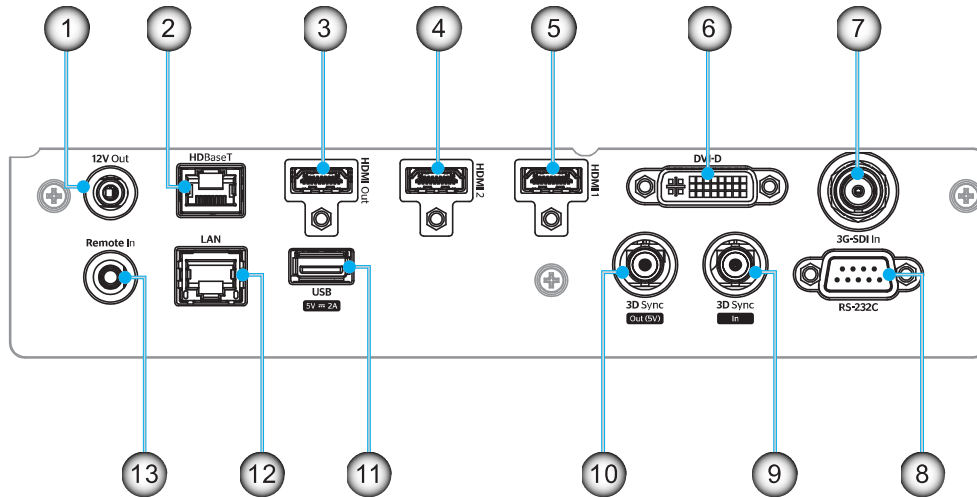

No	IO	Type	Cable	Device Example
1.	12V OUT	IO port	12V Cable	Device
2.	HDBaseT	Input signal	RJ-45 Cable	HDBaseT set-top box
3.	HDMI OUT	Output	HDMI Cable	Screen, Projector, Display device
4.	HDMI 2 IN	Input signal	HDMI Cable	Device
5.	HDMI 1 IN	Input signal	HDMI Cable	Device
6.	DVI-D	Input signal	DVI-D Cable	Device
7.	3G-SDI IN	Input signal	3G-SDI Cable	Device of 3G-SDI signal
8.	RS-232C	IO port	RS-232C Cable	Device
9.	3D SYNC IN	IO port	3D SYNC Cable	Device of 3D signal
10.	3D SYNC OUT	IO port	3D SYNC Cable	3D Emitter
11.	USB TYPE-A	IO port	USB Cable	Only for power supply
12.	ETHERNET	IO port	RJ-45 Cable	Device, Internet
13.	REMOTE IN	IO port	TRS Cable	Remote control

Note: The USB port is for power (5V; 2A) delivery only.

INTRODUCTION

Keypad

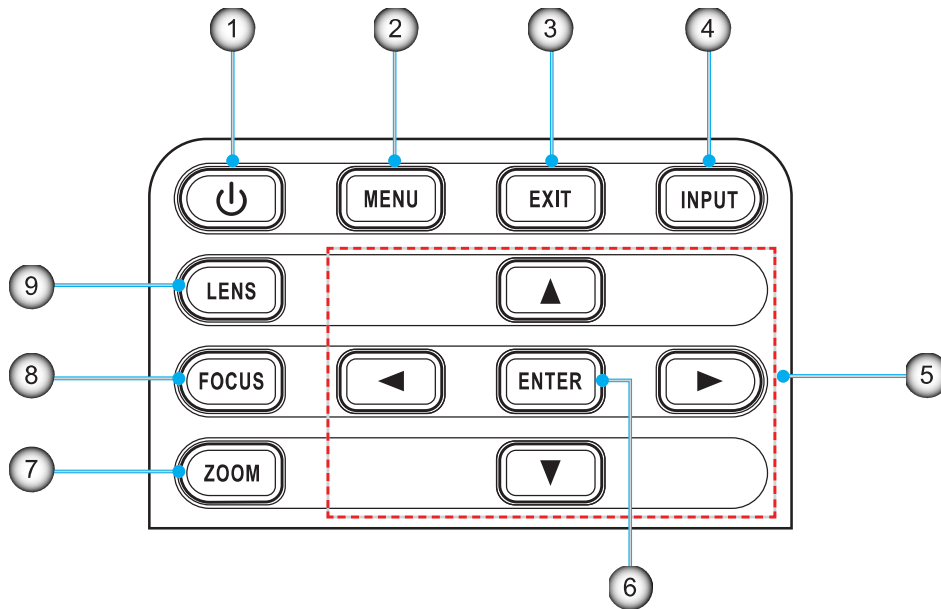

No	Item	No	Item
1.	Power key	6.	ENTER
2.	MENU	7.	ZOOM
3.	EXIT	8.	FOCUS
4.	INPUT	9.	LENS
5.	Arrow keys		

INTRODUCTION

Remote control

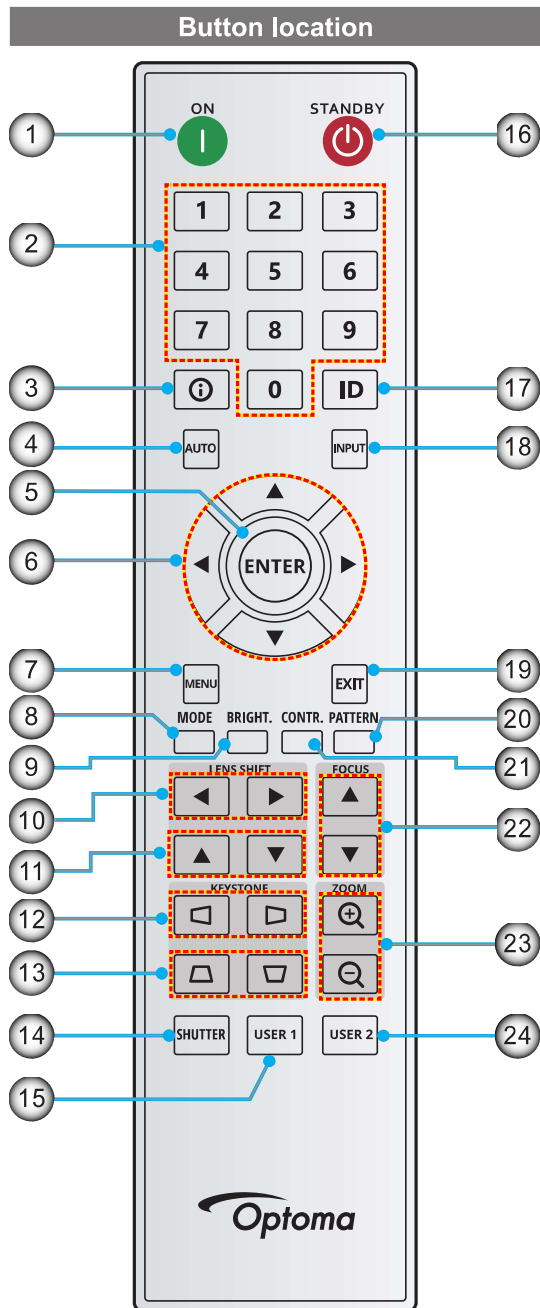

No	Button	Function
1.	Power On	Turn the projector on.
2.	Number Keys	Input numbers (0-9)
3.	Info	Display information on the source image.
4.	Auto	Automatically synchronize the projector to an input source.
5.	Enter	Confirm an selection.
6.	Arrow Keys	Use arrow keys to navigate through the menu or select the appropriate settings.
7.	Menu	Show the main menu on the screen.
8.	Mode	Press to select the preset display mode.
9.	Bright. (brightness)	Set the brightness of the image.
10.	Lens Shift (horizontal)	Adjust the image position horizontally.
11.	Lens Shift (vertical)	Adjust the image position vertically.
12.	Keystone (horizontal)	Adjust a horizontally keystone image.
13.	Keystone (vertical)	Adjust a vertically keystone image.
14.	Shutter	Momentarily turn off/on the screen (AV Mute).
15.	User 1	Press to assign custom functions. See user guide for more info.
16.	Standby	Turn the projector off.
17.	ID	Set the projector address.
18.	Input	Select an input source manually.
19.	Exit	Back to the previous menu.
20.	Pattern	Display the test patterns.
21.	Contr. (Contrast)	Set the contrast of the image.
22.	Focus	Adjust the image focus.
23.	Zoom In/Zoom Out	Adjust the image size.
24.	User 2	Press to assign custom functions. See user guide for more info.

SETUP AND INSTALLATION

Installing the projection lens

Before setting up the projector, install the projection lens in to the projector.

在安装或替换镜头前，关掉投影机的电源。

在镜头安装联接过程中，避免使用遥控器或投影机按键板的按钮调节侧平移镜头或缩放/聚焦。

Before installing or replacing the lens, switch off the power to the projector.

Avoid using the remote control or projector keypad button to adjust the lens shift or zoom/focus while the lens attachment process is carried out.

IMPORTANT!

- Before installing or replacing the lens, make sure the projector's power switch is turned off.
- During lens installation, do not adjust the lens shift, zoom, or focus either using the remote control or the projector keypad.
- To prevent damage to the lens and avoid personal injury, do not clean the lens when the projector is turned on. Any damage resulting from doing so will void the warranty.

Procedure:

1. Rotate the lens cap counterclockwise. Then remove the lens cap.

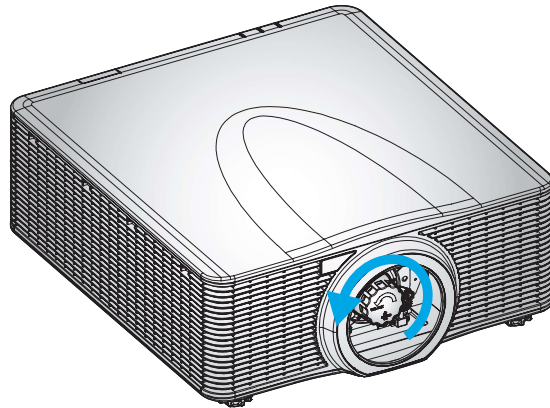

2. Install the lens into the projector.

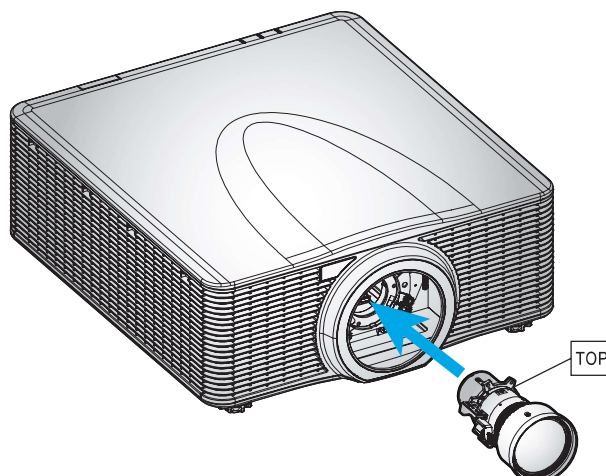

SETUP AND INSTALLATION

3. Rotate the lens clockwise to lock the lens in place.

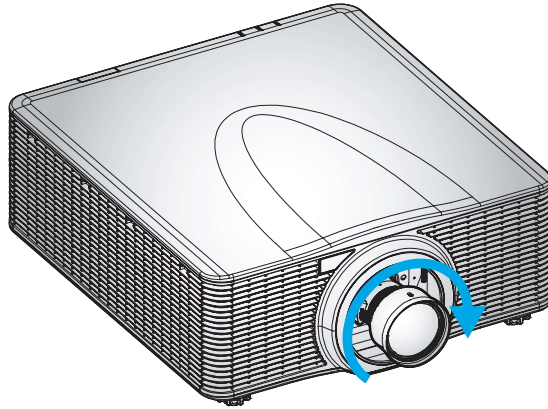

4. Firmly install the lens ring onto the lens.

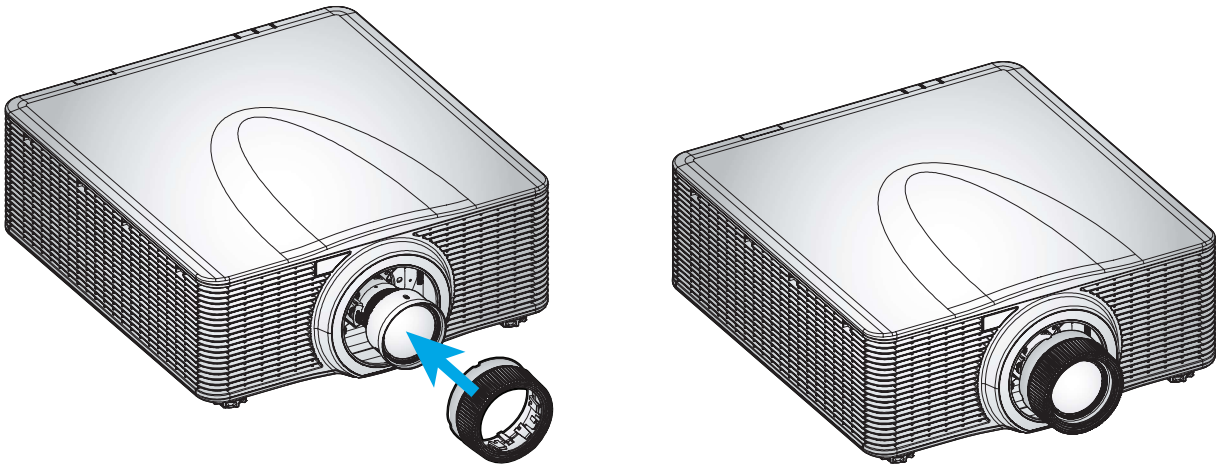

Note: Remove the lens in the reverse order.

SETUP AND INSTALLATION

Adjusting the projector position

When you select a position for the projector, consider the size and shape of your screen, the location of your power outlets, and the distance between the projector and the rest of your equipment. Follow these general guidelines:

- Position the projector on a flat surface at a right angle to the screen.
- Position the projector to the desired distance from the screen. The distance from the lens of the projector to the screen, the zoom setting, and the video format determine the size of the projected image.
- 360 degree free orientation operation

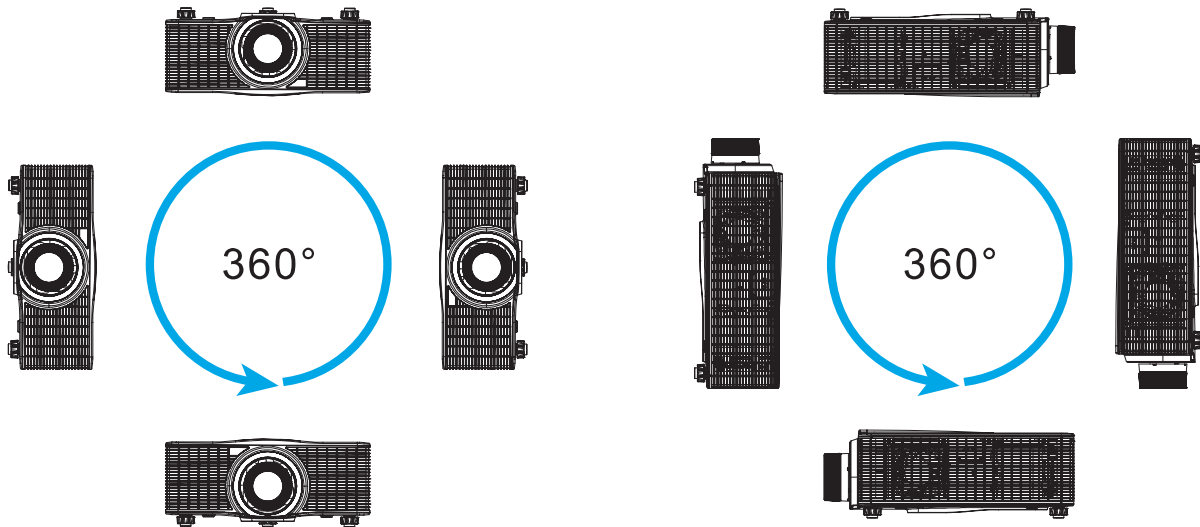

- For ceiling mount installations, make sure to leave 30mm (1.2") between the ceiling mount and the bottom intake vents of the projector.

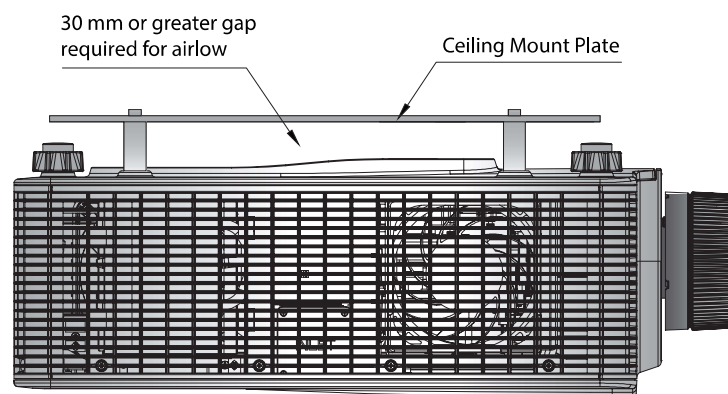

SETUP AND INSTALLATION

- Allowing proper space around the projector is critical for air circulation and cooling. For 360° installations and multiple projectors, make sure to leave at least 1000mm (39.4") space around the air intakes and outlet of the projector.

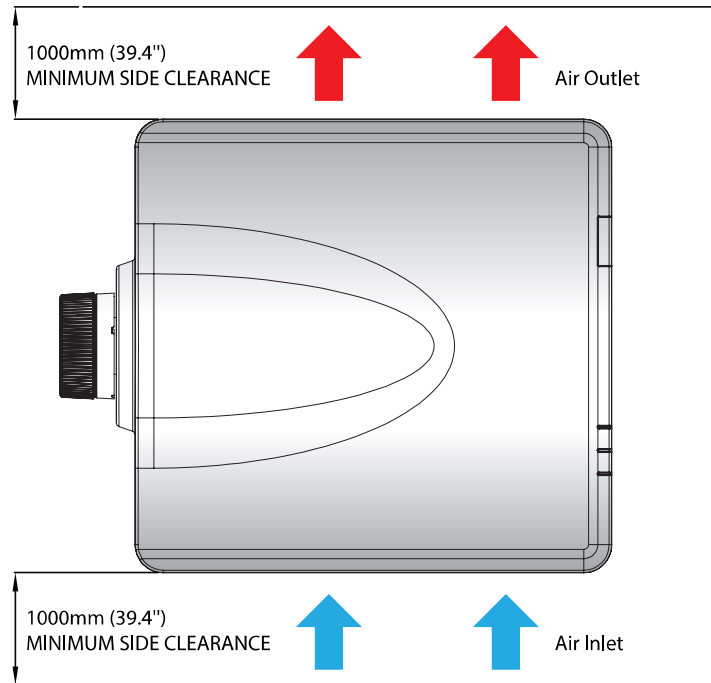

SETUP AND INSTALLATION

Boresight adjustment

Only apply a boresight adjustment in case the overall focus of the projected image is not equally sharp. The boresight adjustment helps to balance the tilt of the lens mount to sharpen the unfocused sections of the image. It tilts the lens holder to parallel the lens plane and the DMD plane.

Note: *This boresight adjustment process may cause the other areas of the image to slide out of focus. This is totally normal.*

Required tool

For BX-CAA01/ BX-CAA03/ BX-CAA06/ BX-CTA13/ BX-CTA15 lens, the following tools are required for boresight adjustment:

- Allen key, hex 4mm

For BX-CTA16/ BX-CTA17 lens, the following tools are required:

- Boresight extender with red rubber ring
- L-shape socket tool

Setting the projector start mode

1. Choose the test pattern of the OSD. Switch to full screen mode.
2. Prepare the test area. Verify that the throw ratio of the installed lens matches the requirements of the installation area (projection distance and screen size).
3. Check that the lens is correctly installed.

Performing the boresight adjustment

For BX-CAA01/ BX-CAA03/ BX-CAA06/ BX-CTA13/ BX-CTA15 lens

Use the Allen key screwdriver to clockwise or counter-clockwise adjust the three boresight screws.

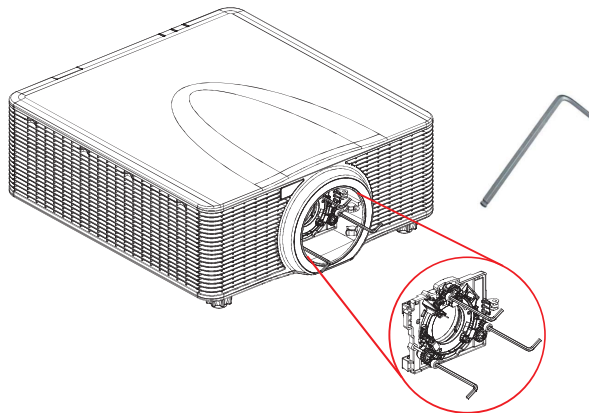

For BX-CTA16/ BX-CTA17 lens

The boresight extenders must be installed before installing the BX-CTA16/ BX-CTA17 lens.

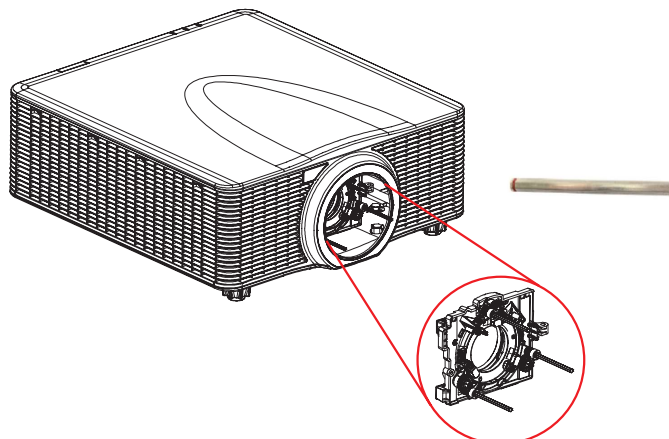

Note: BX-CTA16 lens set-up requires a special support bit. For more information, please refer to the BX-CTA16

SETUP AND INSTALLATION

1. Use the boresight tool to adjust the three boresight screws.

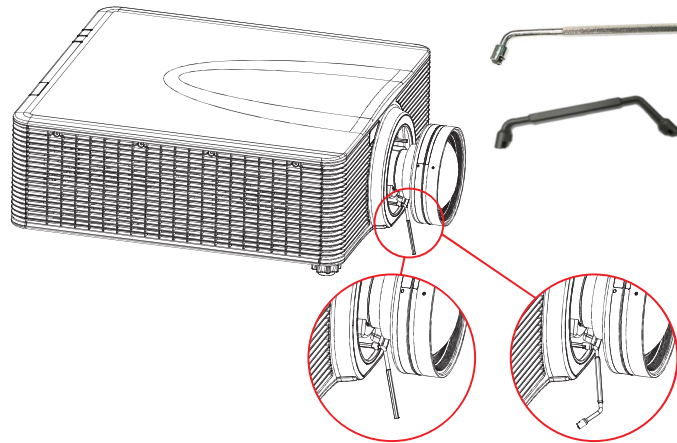

2. Zoom the lens to its widest opening.
3. Adjust the focus control to search for the best sharpness of the projected image.
4. Zone A/C boresight adjustment.

If zone C is in focus on the screen, please check the focal plane of zone A.

- If clear position is just on the screen then no need to adjust.
- If clear position is out of the screen (Close to the projector), rotate screw ① CCW and then screw ② & ③ CW for half amount that ① rotated. Then repeat until both A and C are clear. For example, turn ① CCW in a circle, then turn ② & ③ CW in half circle).
- If clear position is in the screen (away from the projector), rotate screw ① CW and then screw ② & ③ CCW for half amount that ① rotated. Then repeat until both A and C are clear.

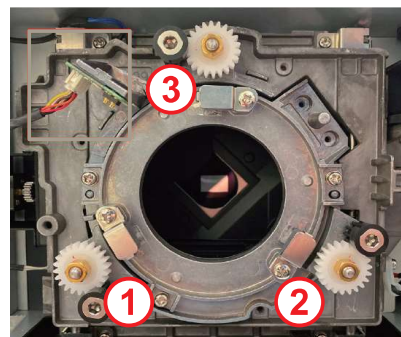
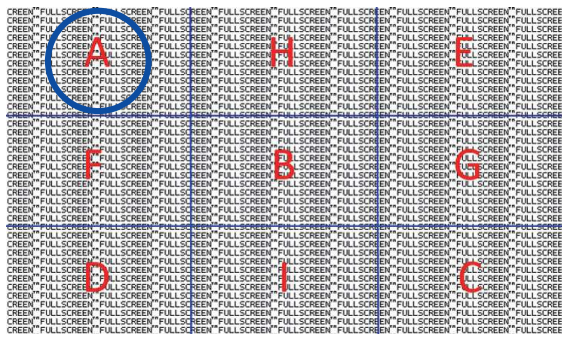
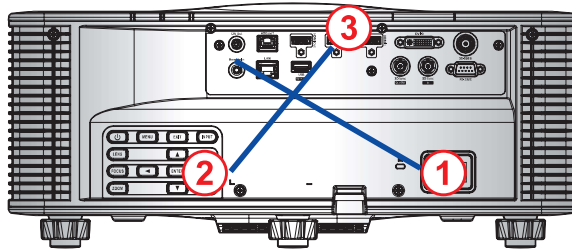

SETUP AND INSTALLATION

5. Zone D/E boresight adjustment.

If zone D is in focus on the screen, please check the focal plane of zone E.

- If clear position is just on the screen then no need to adjust.
- If clear position is out of the screen (close to the projector), rotate screw ② CCW and then screw ① & ③ CW for half amount that ② rotated. Then repeat until both D and E are clear. For example, turn ② CCW in a circle, then turn ① & ③ CW in half circle).
- If clear position is in the screen (away from the projector), rotate screw ② CW and then screw ① & ③ CCW for half amount that ② rotated. Then repeat until both D and E are clear.

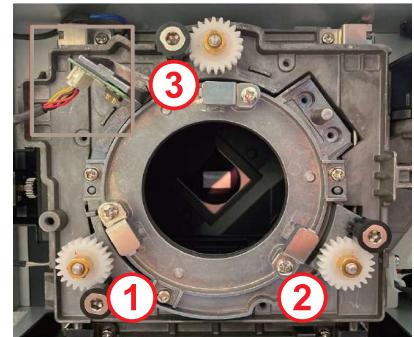
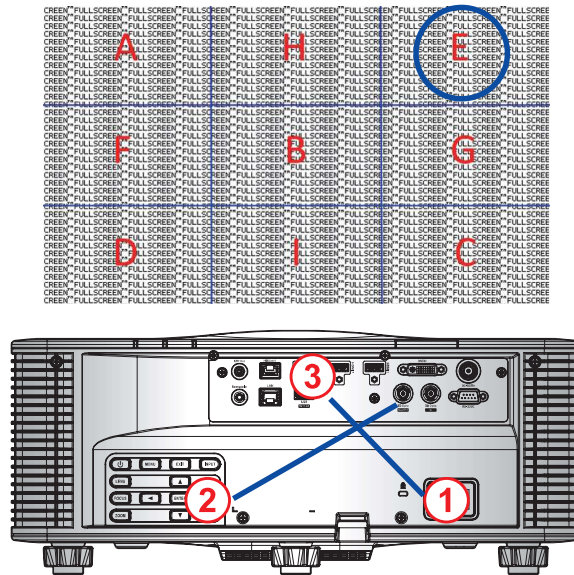

6. Zone H/I boresight adjustment.

If zone H is in focus on the screen, please check the focal plane of zone I.

- If clear position is just on the screen then no need to adjust.
- If clear position is out of the screen (close to the projector), rotate screw ③ CCW and then screw ① & ② CW for half amount that ③ rotated. Then repeat until both H and I are clear. For example, turn ③ CCW in a circle, then turn ① & ② CW in half circle).
- If clear position is in the screen (away from the projector), rotate screw ③ CW and then screw ① & ② CCW for half amount that ③ rotated. Then repeat until both H and I are clear.

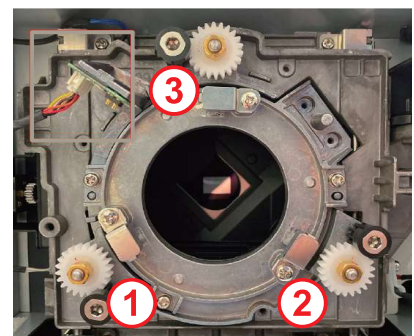
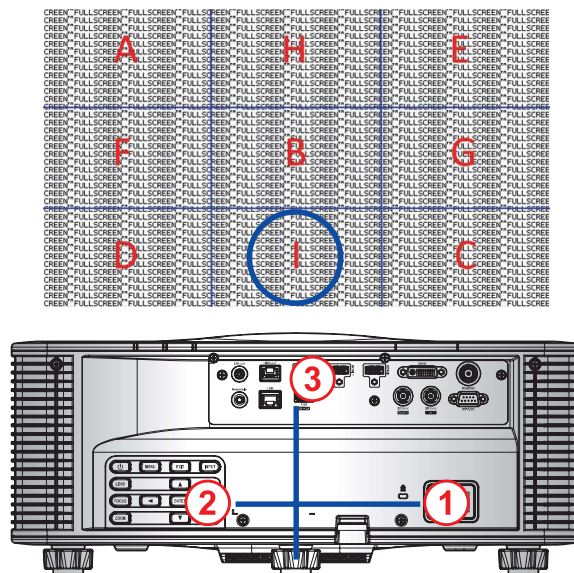

SETUP AND INSTALLATION

7. After the above adjustment of the viewing axis, the projected image from zone A to zone I still cannot achieve a clear focus on the screen. Please remove the PJ-lens then turn the boresight screws ① to ③ counterclockwise to the end (STOP), and then turn clockwise 2 circles to the design value position.

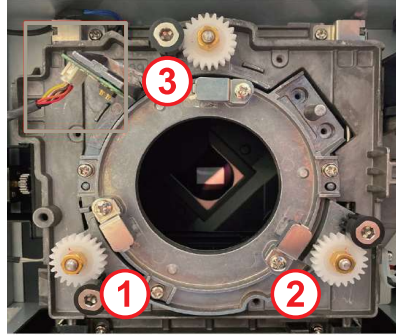

8. Repeat steps 2 to 6 above to adjust.

BX-CTA17 Boresight Tool Operating

To mount the ST lens, do the following:

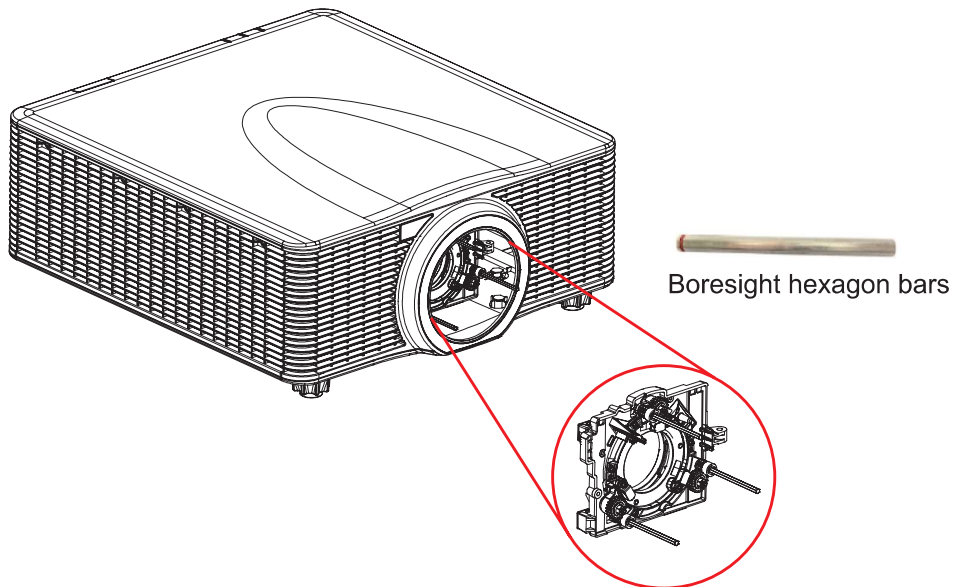

1. Install the three boresight extenders.
2. Face the socket heads of the extenders towards the projector.

SETUP AND INSTALLATION

Boresight adjustment

Boresight adjustment is needed if the image is still unsharp after the focus adjustment. The boresight adjustment tilts the lens holder to parallel the lens plane and the DMD plane to fully focus the image on the screen.

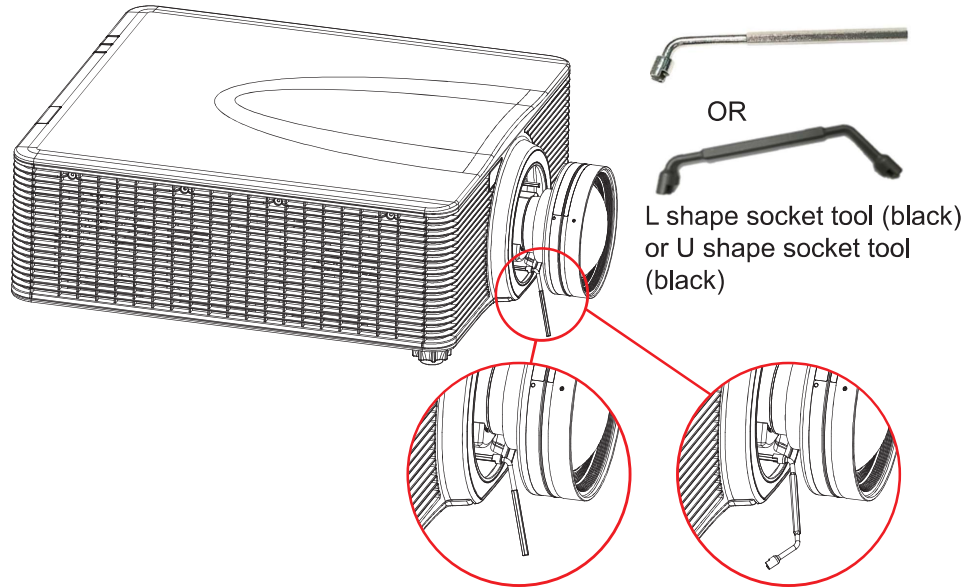

SETUP AND INSTALLATION

Connecting sources to the projector

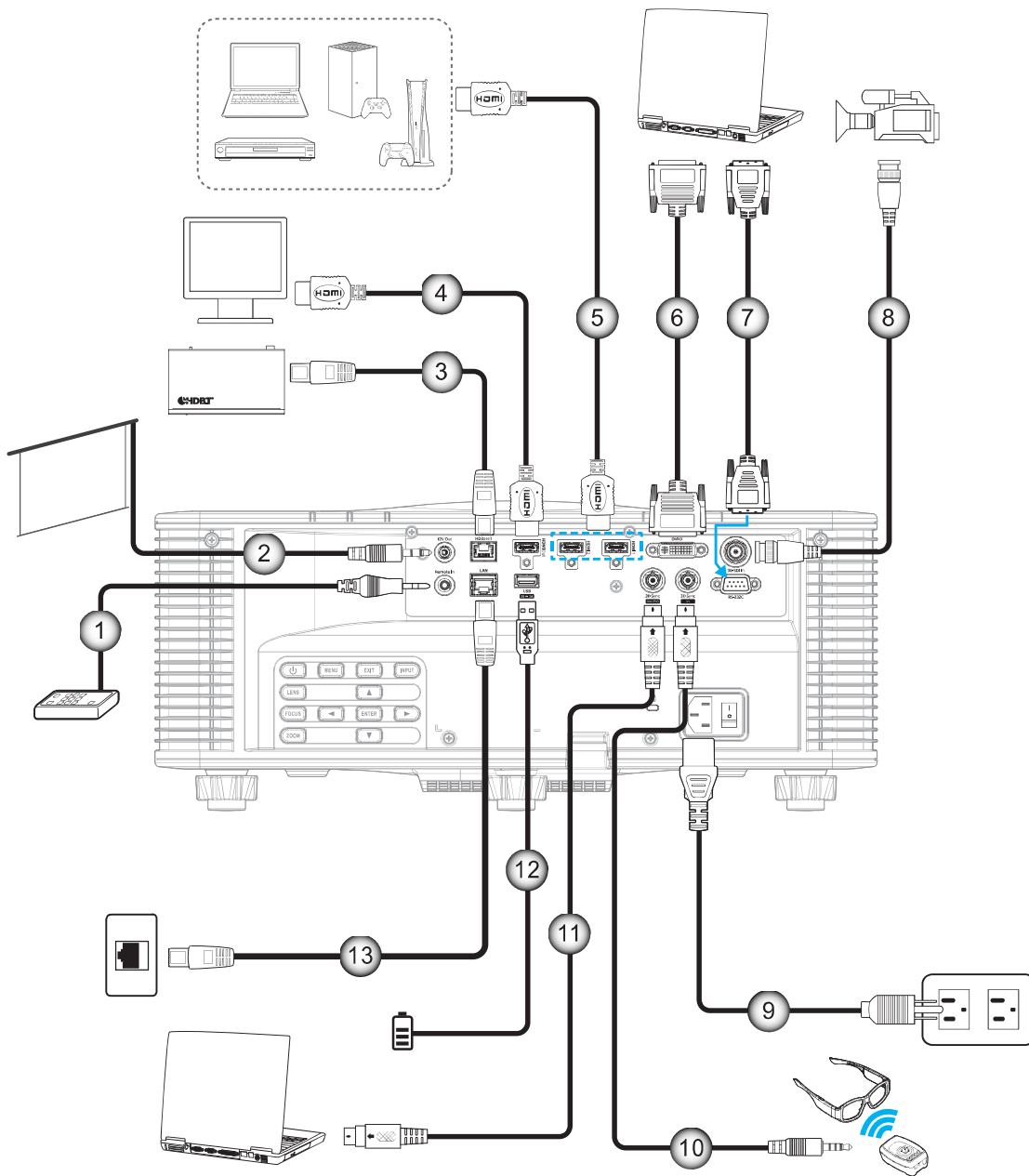

No	Item	No	Item
1.	Wired Remote-In/Out Cable	8.	3G-SDI Cable
2.	12V Trigger Cable	9.	Power Cord
3.	RJ-45 Cable	10.	3D Emitter Cable
4.	HDMI Cable	11.	3D Sync Cable
5.	HDMI Cable	12.	USB Cable
6.	DVI-D Cable	13.	RJ-45 Cable
7.	RS-232 Cable		

SETUP AND INSTALLATION

RS232 Pin assignments

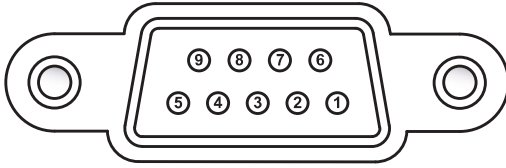

Pin No.	Signal	Pin No.	Signal
1	N/A	6	N/A
2	RXD	7	N/A
3	TXD	8	N/A
4	N/A	9	N/A
5	GND		

Adjusting the projector image

Image height

The projector is equipped with adjustable feet to change the image height.

1. Locate the adjustable foot you wish to adjust on the underside of the projector.
2. Rotate the adjustable foot clockwise or counterclockwise to raise or lower the projector.

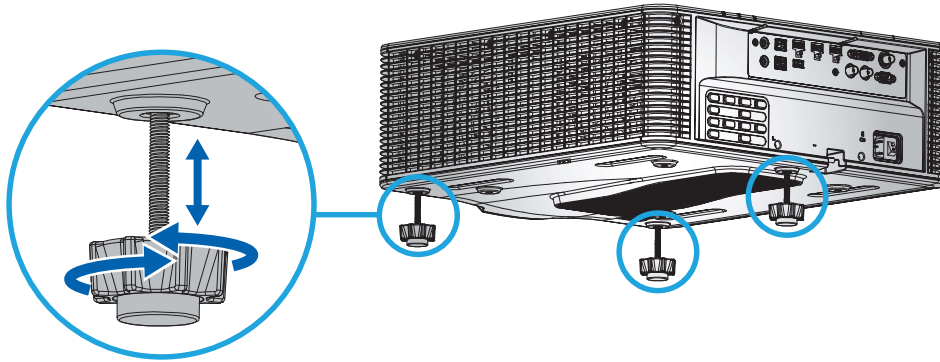

Note: The adjustable feet can be raised up to 38mm, or may be removed for certain installations. Please ensure sufficient space around projector for proper air flow.

Zoom and Focus

Use the remote control or projector keypad to adjust the zoom and focus of the projected image.

- To adjust the image focus, press **Focus** and the ▲▼ buttons to improve the image quality. (A)
- To adjust the image size, press **Zoom** and the ⊕⊖ buttons to get the required image size. (B)

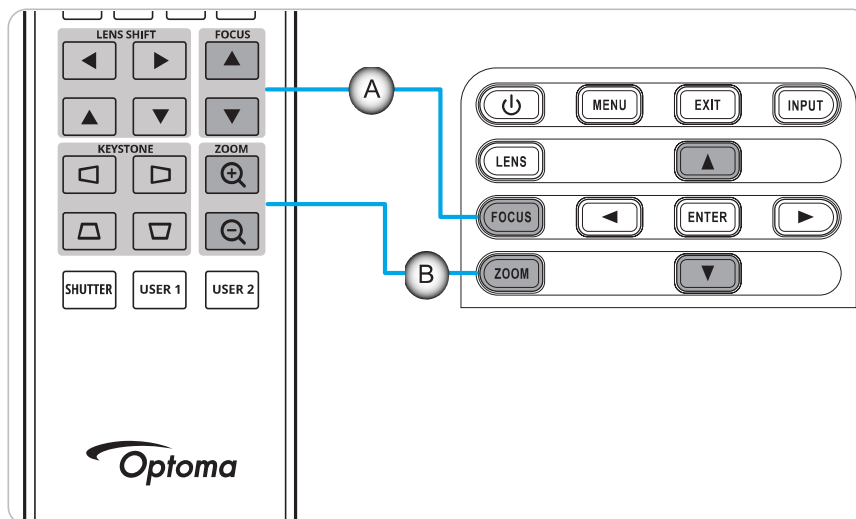

SETUP AND INSTALLATION

Remote setup

Installing / replacing the batteries

Two AAA size batteries are supplied for the remote control.

1. Remove the battery cover on the back of the remote control.
2. Insert AAA batteries in the battery compartment as illustrated.
3. Replace back cover on remote control.

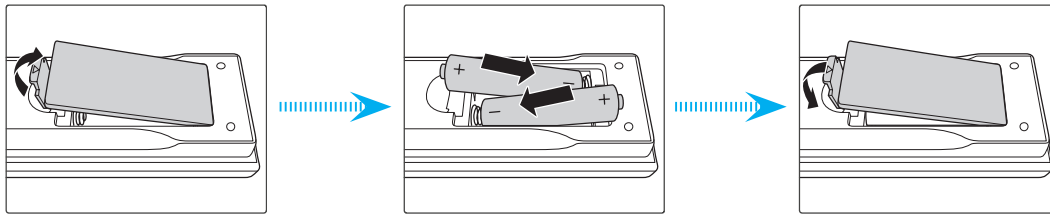

Note: Replace only with the same or equivalent type batteries.

CAUTION

Improper use of batteries can result in chemical leakage or explosion. Be sure to follow the instructions below.

- Do not mix batteries of different types. Different types of batteries have different characteristics.
- Do not mix old and new batteries. Mixing old and new batteries can shorten the life of new batteries or cause chemical leakage in old batteries.
- Remove batteries as soon as they are depleted. Chemicals that leak from batteries that come in contact with skin can cause a rash. If you find any chemical leakage, wipe thoroughly with a cloth.
- The batteries supplied with this product may have a shorter life expectancy due to storage conditions.
- If you will not be using the remote control for an extended period of time, remove the batteries.
- When you dispose of the batteries, you must obey the law in the relative area or country.

Remote control ID setup

The Infra-Red (IR) remote control supports individual addressing of projectors. The remote receiver on the projector can be set with a specific number from 00 to 99, and the projector only responds to the IR remote set to the same number. The default ID code of the IR remote is 00, allowing it to control all projectors within its effective range.

Follow below methods to set up the ID code for the IR remote control:

ID Code	Change mode	Customer code
1	Keep pressing the "ID" button for 3 sec, enter "0" then enter "1" within 2 sec, and then release "ID" button.	3201
2	Keep pressing the "ID" button for 3 sec, enter "0" then enter "2" within 2 sec, and then release "ID" button.	3202
...	...	
10	Keep pressing the "ID" button for 3 sec, enter "1" then enter "0" within 2 sec, and then release "ID" button.	3210
11	Keep pressing the "ID" button for 3 sec, enter "1" then enter "1" within 2 sec, and then release "ID" button.	3211
...	...	
98	Keep pressing the "ID" button for 3 sec, enter "9" then enter "8" within 2 sec, and then release "ID" button.	3298
99	Keep pressing the "ID" button for 3 sec, enter "9" then enter "9" within 2 sec, and then release "ID" button.	3299

To have the IR remote control return to default value 00 where all projectors can be controlled, press the "ID button" for 3 seconds, and press "0" twice within 2 seconds.

SETUP AND INSTALLATION

Effective range

The Infra-Red (IR) remote control sensors are located on the front and top sides of the projector. To have the remote control function correctly, be sure to hold the remote control at an angle of $\pm 30^\circ$ horizontally or vertically within the distance of 10m (32.8 ft) to the projector's IR remote control sensor.

- Make sure that there are no obstacles between the remote control and the IR sensor on the projector.
- Make sure the IR transmitter of the remote control is not being obstructed by direct light from sunlight or fluorescent lamps.
- Keep the remote control away from fluorescent lamps for at least 2m or it may malfunction.
- If the remote control is near Inverter-Type fluorescent lamps, it may operate ineffectively at times.
- If the remote control and the projector are within a very short distance, it may operate ineffectively.
- When aiming at a screen, the effective distance is less than 5m from the remote control to the screen and reflects the IR beams back to the projector. However, the effective range may vary between screens.

IMPORTANT! If you want to use the 3D IR emitter, refer to "IR Control setup when using the 3D IR emitter" on page 52.

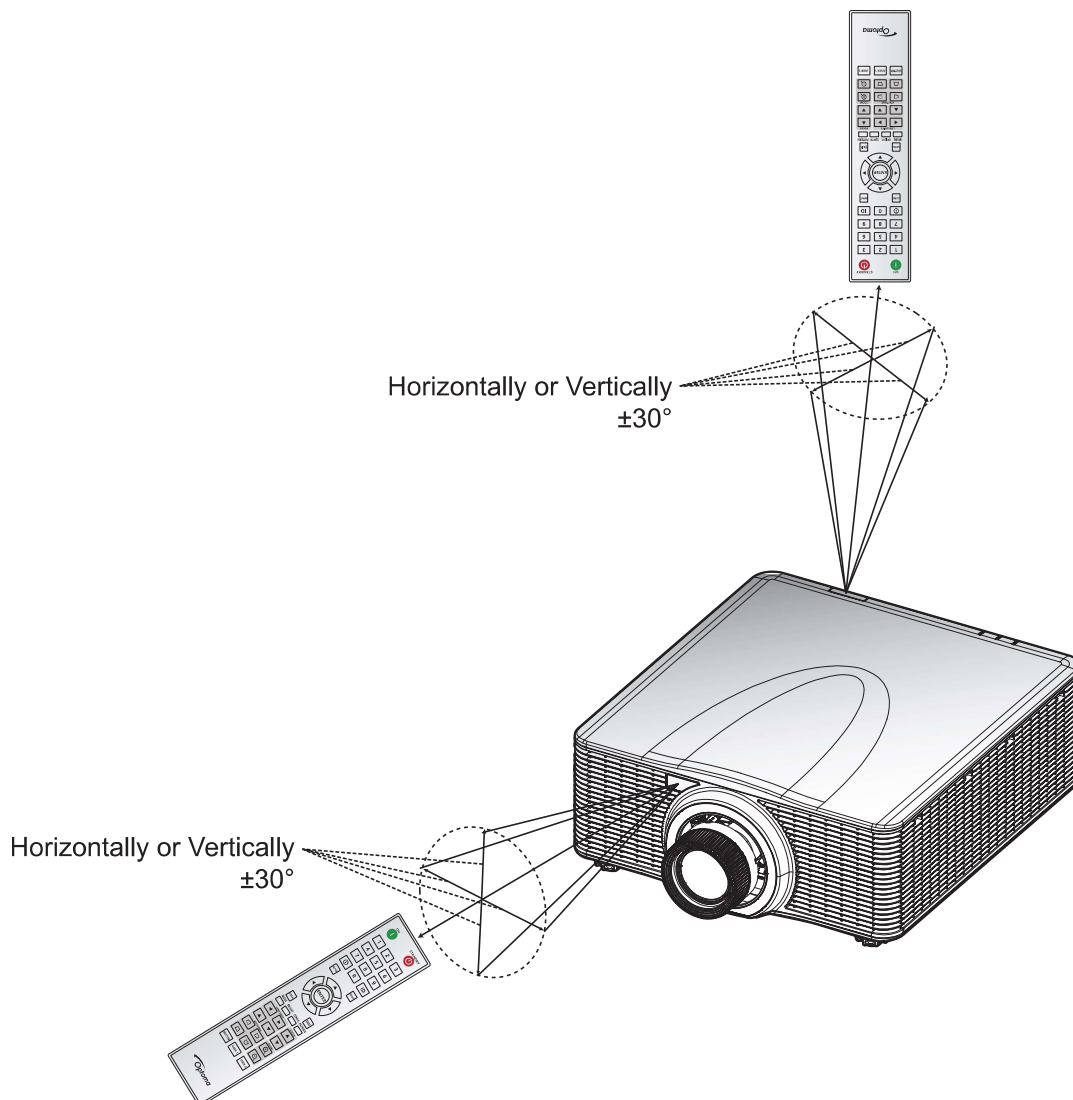

SETUP AND INSTALLATION

Wired remote

Remote In connector is designed to work with Wired Remote or IR Keypad with longer range and provides fast, easy set-up and reliable individual control of a specific projector. Remote Out connector sends the IR control signal to the next projector when using multiple projectors.

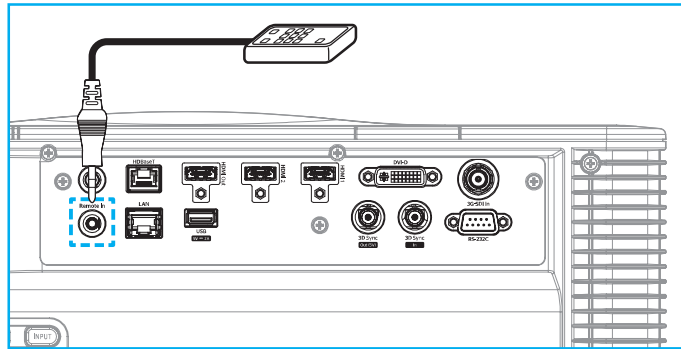

The connector type is 3.5mm Phone Jack connector:

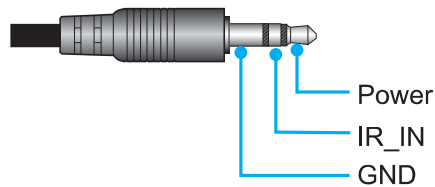

USING THE PROJECTOR

Powering on / off the projector

Powering on

1. Securely connect the AC power cord and signal/source cable to the projector.
2. Set the power switch to the "I" (ON) position and wait until the power button "⏻" on the projector keypad is solid orange.
3. Turn on the projector by pressing the ON button "I" on the remote control or the power button "⏻" on the projector keypad.

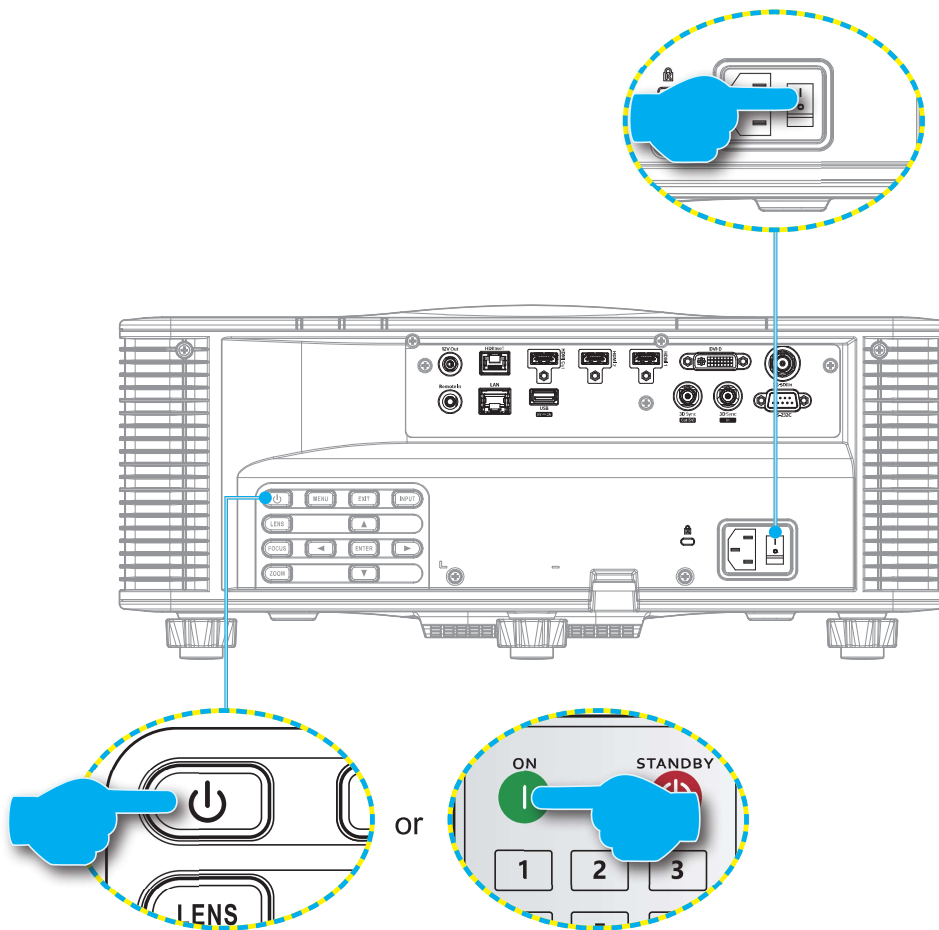

The status LED is orange with a long blink and the status LED will turn to solid green.



Note: If the projector is turned on for the first time, you will be prompted to select the projector language, projection orientation, and other settings.

USING THE PROJECTOR

Powering off

1. Turn off the projector by pressing the power button “” on the projector keypad or the **OFF** button “” on the remote control.
A message will pop up to confirm that you want to turn off the projector.
2. Press the power button or the **OFF** button again to confirm, otherwise the warning message disappears after 10 seconds and the projector remains on.
3. Set the Power switch to the “” (OFF) position.
The status LED turns from blinking orange to solid orange and the keypad also turns to solid orange.
4. Disconnect the power cord from both the projector and the electrical outlet.

Note: *It is not recommended to turn on the projector immediately after powering it off. Wait for 10 seconds until you power it on again.*

Selecting an input source

Turn on the connected source that you want to display on the screen, such as computer, notebook, and/or video player. The projector will automatically detect the input source. If multiple sources are connected, press the **INPUT** button on the remote control or **INPUT** key on the projector keypad to select an input source.

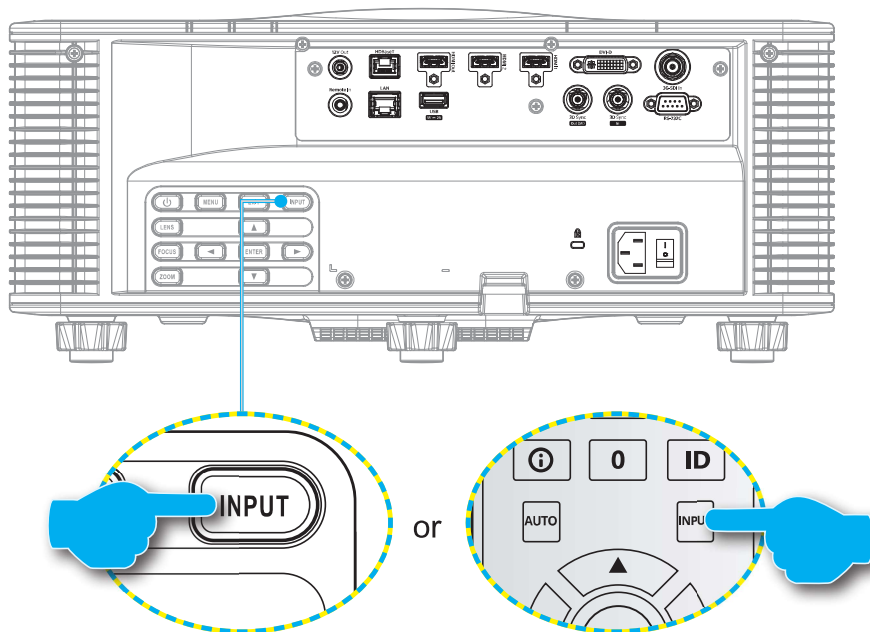

USING THE PROJECTOR

Menu navigation and features

The projector has multilingual on-screen display (OSD) menus that allow you to make image adjustments and change a variety of settings.

1. To open the OSD menu, press the **Menu** key on the remote control or projector keypad.
2. To select a main menu or submenu, use the **▲** and **▼** buttons to highlight it. Then, press the **Enter** key to enter the submenu.
3. Press the **Exit** key to return to the previous menu or exit the OSD menu if at top level.
4. Setting methods to adjust the function value or selection an option.
 - To adjust the slide bar values, highlight the function, and use the **◀▶** buttons to change value.
 - To check or uncheck a checkbox, highlight the function, and press **Enter**.
 - To input a number or symbol, highlight the number or symbol, and use the **▲** and **▼** buttons to make a selection. You can also use the number keys on the remote control or keypad.
 - To select a function option, use the **▲▼◀▶** buttons to make the selection. If no **Enter** icon shows at the navigation bar, the highlighted option is automatically applied. If there is an **Enter** icon at the navigation bar, press **Enter** to confirm your selection.

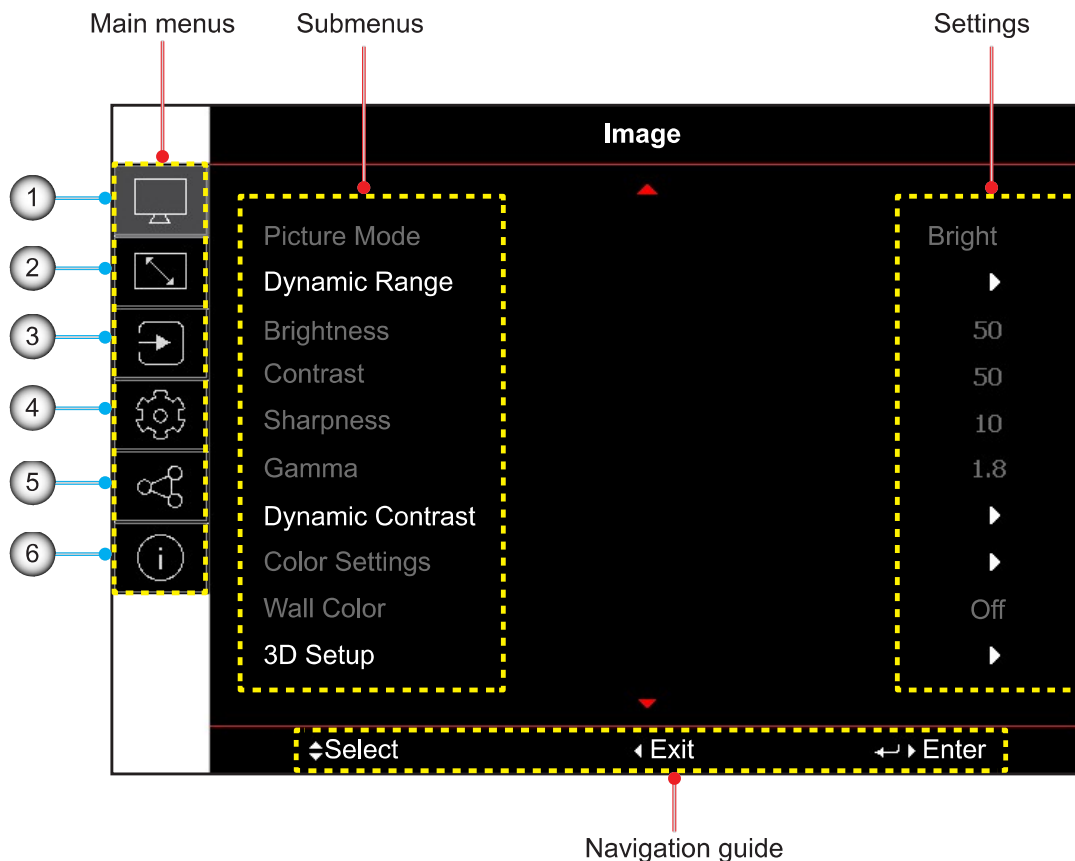

No	Item	No	Item
1.	Image menu	4.	Device setup menu
2.	Display menu	5.	Communication menu
3.	Input settings menu	6.	Information menu

USING THE PROJECTOR

OSD menu tree

Main Menu	Sub Menu 2	Sub Menu 3	Sub Menu 4	Sub Menu 5	Sub Menu 6	Values		
Image	Picture Mode					Presentation		
						Bright		
						Cinema		
						HDR		
						sRGB		
						DICOM SIM.		
						Blending		
						3D		
						2D High Speed		
						User		
			Dynamic Range	HDR				Off
								Auto
				HDR Picture Mode				Bright
								Standard
						Film		
						Detail		
	Brightness					0~100		
	Contrast					0~100		
	Sharpness					1-15		
	Gamma					Film		
						Graphics		
						Standard(2.2)		
						Vivid		
						3D		
						Blackboard		
						DICOM SIM.		
						1.8		
						2.0		
						2.4		
					2.6			
	Dynamic Contrast	Dynamic Black				Off		
						On		
			Speed				1~15	
			Strength				0~3	
			Level				50%~100%	
			Extreme Black				Off	
							On	
			AV Mute Timer				0s~10s	
		Black Signal Level				0~5		

USING THE PROJECTOR

Main Menu	Sub Menu 2	Sub Menu 3	Sub Menu 4	Sub Menu 5	Sub Menu 6	Values		
Image	Color Settings	Color				0~100		
		Tint				0~100		
		Color Temperature				Warm		
						Standard		
						Cool		
		White Balance	Red Gain				0-100	
			Green Gain				0-100	
			Blue Gain				0-100	
			Red Offset				0-100	
			Green Offset				0-100	
			Blue Offset				0-100	
		White Enhancement					0-10	
		Color Space					Auto	
							RGB (0-255)	
							RGB (16-235)	
							REC709	
							REC601	
		Color Matching	Auto Test Pattern					Off
								On
			Red	Hue				0~254
				Saturation				0~254
				Luminance				0~254
			Green	Hue				0~254
				Saturation				0~254
				Luminance				0~254
			Blue	Hue				0~254
				Saturation				0~254
				Luminance				0~254
			Cyan	Hue				0~254
				Saturation				0~254
				Luminance				0~254
			Magenta	Hue				0~254
				Saturation				0~254
				Luminance				0~254
			Yellow	Hue				0~254
				Saturation				0~254
				Luminance				0~254
		White	Red				0~254	
			Green				0~254	
			Blue				0~254	
Reset					Yes / Cancel (Dialog box)			

USING THE PROJECTOR

Main Menu	Sub Menu 2	Sub Menu 3	Sub Menu 4	Sub Menu 5	Sub Menu 6	Values	
Image	Wall Color					Off	
						Blackboard	
						Light Yellow	
						Light Green	
						Light Blue	
						Pink	
						Gray	
	3D Setup	3D Mode					Off
							Active 3D
		3D Format					Auto
							Frame Packing
							Side by Side
							Top and Bottom
							Frame Sequential
		3D Tech					DLP-link
							3D Sync
		3D-2D					3D
							L
							R
		3D Sync Out					To Emitter
							To Next Projector
		3D Invert					Off
							On
		Frame Delay				1~200	
		Reset				Yes / Cancel (Dialog box)	
		Save to User				Yes / Cancel (Dialog box)	
	Apply to User					User-Presentation	
					User-Bright		
					User-Cinema		
					User-HDR		
					User-sRGB		
					User-DICOM SIM.		
					User-Blending		
					User-3D		
				User-2D High Speed			
Reset					Yes / Cancel (Dialog box)		

USING THE PROJECTOR

Main Menu	Sub Menu 2	Sub Menu 3	Sub Menu 4	Sub Menu 5	Sub Menu 6	Values		
Display	Aspect Ratio					Auto		
						4:3		
						16:9		
						16:10		
						LBX		
						Native		
	Digital Zoom	Proportional					Off	
							On	
		Horizontal				50%~400%		
		Vertical				50%~400%		
		Horizontal Shift				0~100		
		Vertical Shift				0~100		
		Reset				Yes / Cancel (Dialog box)		
	Geometric Correction	Warp Control					Basic	
							Advanced	
							AP	
		Basic Warp	Keystone	Horizontal				0~40
				Vertical				0~40
		Pincushion		Horizontal				0~100
				Vertical				0~100
		4-Corner		Top Left				
				Top Right				
				Bottom Left				
				Bottom Right				
		Advanced Warp	Grid Color					Green
							Magenta	
							Red	
							Cyan	
Grid Background							Black	
							Transparent	
Warp Setting			Grid Points					2x2
								3x3
							5x5	
						9x9		
						17x17		
	Warp Inner					Off		
						On		
Blend Setting	Warp Sharpness					0~9		
		Blend Width				4 / 6 / 8 / 10 / 12		
			Overlap Grid Number					
			Gamma				1.8 / 1.9 / 2.0 / 2.1 / 2.2 / 2.3 / 2.4	

USING THE PROJECTOR

Main Menu	Sub Menu 2	Sub Menu 3	Sub Menu 4	Sub Menu 5	Sub Menu 6	Values	
Display	Geometric Correction	Advanced Warp	Black Level	Area		Bottom	
						Top	
					Enable	Off	
						On	
					Edit Area		
					Brightness	Brightness	
						Red	0~255
						Green	0~255
						Blue	0~255
						Exit	
						Red	0~255
						Green	0~255
					Blue	0~255	
					Reset	Bottom	Yes / Cancel (Dialog box)
						Top	Yes / Cancel (Dialog box)
						All	Yes / Cancel (Dialog box)
					Memory	Save Memory	Memory 1~Memory 5
						Apply Memory	Memory 1~Memory 5
						Clear Memory	Yes / Cancel (Dialog box)
					Reset		Yes / Cancel (Dialog box)
				Edge Mask			0~10
				Freeze Screen			Unfreeze
							Freeze
				Test Pattern			Off
							Green Grid
							Magenta Grid
							White Grid
		White					
		Black					
		Red					
		Green					
		Blue					
		Yellow					
		Magenta					
		Cyan					
		ANSI Contrast 4x4					
		Color bar					
		Full screen					







USING THE PROJECTOR

Main Menu	Sub Menu 2	Sub Menu 3	Sub Menu 4	Sub Menu 5	Sub Menu 6	Values		
Display	PIP/PBP	Screen				Off		
						PIP		
						PBP		
			Main Source		HDMI1			
					HDMI2			
					DVI-D			
					3G-SDI			
			Sub Source		HDBaseT			
					HDMI1			
					HDMI2			
				DVI-D				
		Swap	Size					Small
								Medium
								Large
				Location		PBP, Main Left		
						PBP, Main Top		
						PBP, Main Right		
						PBP, Main Bottom		
						PIP, Bottom Right		
						PIP, Bottom Left		
	PIP, Top Left							
	PIP, Top Right							
	Reset					Yes / Cancel (Dialog box)		
Input Settings	Auto Source					Off		
						On		
	Quick Resync					Off		
						On		
	Active Inputs		HDMI1					
			HDMI2					
			DVI-D					
			3G-SDI					
			HDBaseT					
	Latency Adjustment		Normal					
		2D Ultra						

USING THE PROJECTOR

Main Menu	Sub Menu 2	Sub Menu 3	Sub Menu 4	Sub Menu 5	Sub Menu 6	Values		
Input Settings	Backup Input	Auto Switch				Off		
						On		
		Current Signal				(read only)		
		First Input				HDMI1		
						HDMI2		
						HDBaseT		
						DisplayPort		
		Second Input				HDMI1		
						HDMI2		
						HDBaseT		
						DisplayPort		
		Backup Input Status					Active/Inactive (read only)	
		Backup Input Change					Changed/No Change (read only)	
		Backup Input Info.	Current Signal					(read only)
				Backup Input Status				Active/Inactive (read only)
				Backup Input Change				Changed/No Change (read only)
				First Input				By First Input (read only)
				Resolution				(read only)
				Horz Refresh				(read only)
				Color Space				(read only)
				HDR				Yes/No (read only)
				Second Input				By Second Input (read only)
				Resolution				(read only)
				Horz Refresh				(read only)
				Color Space				(read only)
				HDR				Yes/No (read only)
				HDMI	Output			
						HDMI 2		
HDMI 1 EDID						1.4		
						2.0		
HDMI 2 EDID						1.4		
						2.0		
Reset					Yes / Cancel (Dialog box)			

USING THE PROJECTOR

Main Menu	Sub Menu 2	Sub Menu 3	Sub Menu 4	Sub Menu 5	Sub Menu 6	Values	
Device Setup	Language					English	
						Deutsch	
						Français	
						Italiano	
						Español	
						Português	
						Polski	
						Nederlands	
						Norsk	
						繁體中文	
						簡體中文	
						日本語	
						한국어	
						Русский	
				Magyar			
				ไทย			
Projection	Ceiling					Auto	
						On	
	Rear					Off	
						On	
Lens Settings	Focus					+	
						-	
	Zoom						
							
	Lens Shift						
							
							
							
	Lens Memory		Save Memory				Memory 1~Memory 5
			Apply Memory				Memory 1~Memory 5
			Clear Memory				Yes / Cancel (Dialog box)
	Lens Calibration					Yes / Cancel (Dialog box)	
Lens Lock						Lock	
						Unlock	
Reset						Yes / Cancel (Dialog box)	
Active Image Setup	Active Focus					Yes / Cancel (Dialog box)	
		Active Color Uniformity	Calibration			Yes / Cancel (Dialog box)	
	Target Selection				Pop-up pattern		
	Reset				Yes / Cancel (Dialog box)		
Schedule	Date and Time					---/--/-- --:--	
	Schedule Mode					Off / On	
	View Today					Monday / Tuesday / Wednesday / Thursday / Friday / Saturday / Sunday	

USING THE PROJECTOR

Main Menu	Sub Menu 2	Sub Menu 3	Sub Menu 4	Sub Menu 5	Sub Menu 6	Values		
Device Setup	Schedule	Monday / Tuesday / Wednesday / Thursday / Friday / Saturday / Sunday	Schedule Enable			Off		
						On		
				Event 01-16	Time			00:00 ~ 23:59
					Function			Off / Power Settings / Input Source / Light Source Mode / Shutter
					Event			Off
					(Function = Power Settings)			Power On / Eco / Active / Communication
					(Function = Input Source)			HDMI1 / HDMI2 / DVI-D / 3G-SDI / HDBaseT
					(Function = Light Source Mode)			Normal Mode / Eco Mode / Custom Brightness
					(Function = Shutter)			Shutter On / Shutter Off
					Reset			Yes / Cancel (Dialog box)
					Copy Events To			Monday / Tuesday / Wednesday / Thursday / Friday / Saturday / Sunday
					Reset the Day			Yes / Cancel (Dialog box)
					Reset Schedule			Yes / Cancel (Dialog box)
			Date and Time	Clock Mode				Use NTP Server
								Manual
				Date				2000 ~ 2037 (Year)
								01 ~ 12 (Month)
								01 ~ 31 (Day)
				Time				00 ~ 23 (Hour)
								00 ~ 59 (Minute)
	Daylight Saving Time				Off			
					On			
	NTP Server				time.google.com			
					asia.pool.ntp.org			
					europa.pool.ntp.org			
					north-america.pool.ntp.org			
	Time Zone				UTC+14:00			
					UTC+13:00			
					UTC+12:45			
					UTC+12:00			
					UTC+11:00			
					UTC+10:30			
					UTC+10:00			
					UTC+09:30			
					UTC+09:00			
					UTC+08:45			
					UTC+08:00			
					UTC+07:00			

USING THE PROJECTOR

Main Menu	Sub Menu 2	Sub Menu 3	Sub Menu 4	Sub Menu 5	Sub Menu 6	Values		
Device Setup	Date and Time	Time Zone				UTC+06:30		
						UTC+06:00		
						UTC+05:45		
						UTC+05:30		
						UTC+05:00		
						UTC+04:30		
						UTC+04:00		
						UTC+03:30		
						UTC+03:00		
						UTC+02:00		
						UTC+01:00		
						UTC+00:00		
						UTC-01:00		
						UTC-02:00		
						UTC-03:00		
						UTC-03:30		
						UTC-04:00		
						UTC-05:00		
						UTC-06:00		
						UTC-07:00		
						UTC-08:00		
			UTC-09:00					
			UTC-09:30					
			UTC-10:00					
			UTC-11:00					
			UTC-12:00					
		Update Interval				Hourly		
						Daily		
		Apply				Yes / Cancel (Dialog box)		
Power Settings	Power Mode (Standby)	Power Mode (Standby)				Eco		
						Active		
						Communication		
					Signal Power On			Off
								On
					Auto Power Off			0~180 m
					Sleep Timer			0~16 h
					12V Trigger			Off
					On			
		Reset				Yes / Cancel (Dialog box)		
Light Source Settings	Light Source Mode	Light Source Mode				Normal		
						Eco Mode		
						Custom Power		
				Custom Brightness	Brightness Level			30%~100%
					Constant Brightness			Off
					On			

USING THE PROJECTOR

Main Menu	Sub Menu 2	Sub Menu 3	Sub Menu 4	Sub Menu 5	Sub Menu 6	Values	
Device Setup	Shutter	Fade-In				0.5~5s	
		Fade-Out				0.5~5s	
		Startup				Shutter Off	
						Shutter On	
	Security	Security					Off
							On
		Security Timer	Month				0-35
			Day				0-29
			Hour				0-23
		Change Password					
On Screen Display	Menu Location					Top Left	
						Top Right	
						Center	
						Bottom Left	
						Bottom Right	
		Menu Transparency				0~9	
	Menu Timer						Off
							5s
							10s
							15s
							30s
							60s
		Information Hide					Off
							On
Background						Blue	
						Black	
						White	
						Logo	
	Logo Setup	Change Logo					Default Logo
							Neutral
							User Logo
							Captured Logo
		Logo Capture				Yes / Cancel (Dialog box)	
Delete Logo	Captured Logo					Yes / Cancel (Dialog box)	
		User Logo				Yes / Cancel (Dialog box)	
Backlight	Keypad					Off	
						On	
	Power key					Off	
						On	
High Altitude						Off	
						On	
User Data	Save all settings					Memory 1~Memory 5	
	Load all settings					Memory 1~Memory 5	
System Update (FOTA)	Auto					On	
						Off	
	Update					Yes / Cancel (Dialog box)	

USING THE PROJECTOR

Main Menu	Sub Menu 2	Sub Menu 3	Sub Menu 4	Sub Menu 5	Sub Menu 6	Values	
Device Setup	Reset	Reset OSD				Yes / Cancel (Dialog box)	
		Reset to default				Yes / Cancel (Dialog box)	
	Reset Selective	Image				Yes / Cancel (Dialog box)	
		Display				Yes / Cancel (Dialog box)	
		Input				Yes / Cancel (Dialog box)	
		Communication				Yes / Cancel (Dialog box)	
		Setup				Yes / Cancel (Dialog box)	
Communication	Projector ID				0~99		
	Remote Setup	Remote Code				0~99	
		Quick Switch Code				Off	
						1~9	
		IR Function	Front				Off
							On
			Top				Off
							On
			HDBaseT				Off
							On
		User 1				Freeze Screen	
						Blank Screen	
						PIP/PBP	
						Aspect Ratio	
					Information Hide		
					Network setup		
					Projector ID		
					Color Matching		
					Reset Selective		
	User 2				Freeze Screen		
					Blank Screen		
					PIP/PBP		
					Aspect Ratio		
					Information Hide		
					Network setup		
					Projector ID		
					Color Matching		
				Reset Selective			
Network Setup	LAN Interface	RJ-45					
		HDBaseT					
	MAC Address				(read only)		
	Network Status				(read only) Connected / Disconnected		
	DHCP	Off					
		On					
	IP Address				---.---.---.---		
	Subnet Mask				---.---.---.---		
	Gateway				---.---.---.---		
	DNS				---.---.---.---		
	Apply				Yes / Cancel (Dialog box)		

USING THE PROJECTOR

Main Menu	Sub Menu 2	Sub Menu 3	Sub Menu 4	Sub Menu 5	Sub Menu 6	Values	
Communi- cation	Email Notification	Email 1				Email 1 Address (read only)	
		Email 2				Email 1 Address (read only)	
		Event					
		Fan Error				Off/Email	
		Power On/Off				Off/Email	
		Video Loss				Off/Email	
		Laser				Off/Email	
		Reset				Yes / Cancel (Dialog box)	
	Control	Crestron					Off
							On
			IP Address				---.---.---.---
			IPIID				2~255
			Port				0~65535
			Crestron Setup Apply				Yes / Cancel (Dialog box)
			PJ Link				Off
							On
			Authentication				Off
							On
			Password				(read only)
Service				---.---.---.---			
PJ Link Setup Apply				Yes / Cancel (Dialog box)			
	Extron					Off	
						On	
		AMX				Off	
						On	
		Telnet				Off	
						On	
		HTTP				Off	
						On	
		Reset				Yes / Cancel (Dialog box)	
		Baud Rate	Serial Port In				
						2400	
						4800	
						9600	
						19200	
						38400	
						57600	
				115200			
Reset					Yes / Cancel (Dialog box)		

USING THE PROJECTOR

Main Menu	Sub Menu 2	Sub Menu 3	Sub Menu 4	Sub Menu 5	Sub Menu 6	Values
Information	Device	Regulatory				
		Serial Number				
		Projection Hours				
System Status	System Status	Standby Mode				
		Light Source Mode				
		Light Source Hours				
		Total Hours				
		Normal				
		Eco Mode				
		Custom Power				
		Temperature				
		AC Voltage				
		Communication	Communication	Projector ID		
Remote Code						
LAN Interface						
MAC Address						
Network Status						
DHCP						
IP Address						
Subnet Mask						
Gateway						
DNS						
Crestron						
Extron						
PJ Link						
AMX						
Telnet						
HTTP						
Signal	Signal	Input Signal				
		Resolution				
		Signal Format				
		Pixel Clock				
		Horz Refresh				
		Vert Refresh				
		Color Space				
		Picture Mode				
		Second Signal				
		Resolution				
		Signal Format				
		Pixel Clock				
		Horz Refresh				
		Vert Refresh				
		Color Space				

USING THE PROJECTOR

Main Menu	Sub Menu 2	Sub Menu 3	Sub Menu 4	Sub Menu 5	Sub Menu 6	Values
Information	Backup Input	Current Signal				
		Backup Input Status				
		Backup Input Change				
		First Input				
		Resolution				
		Horz Refresh				
		Color Space				
		HDR				
		Second Input				
		Resolution				
		Horz Refresh				
		Color Space				
		HDR				
		Firmware Version	Main Version			
	I-SCALER Version					
	F-MCU Version					
	M-MCU Version					
	L-MCU Version					
	A-MCU Version					
	K-MCU Version					
	LAN Version					
	Formatter Version					
	FPGA0 Version					
	FPGA1 Version					
	FPGA2 Version					
	XFPGA Version					
HDBaseT Version						
Camera Version						

USING THE PROJECTOR

Image menu

Learn how to configure image settings.

Submenus

- Picture Mode
- Dynamic Range
- Brightness
- Contrast
- Sharpness
- Gamma
- Dynamic Contrast
- Color Settings
- Wall Color
- 3D Setup

Picture Mode

Picture Mode menu provides various functions to optimize the projected image to achieve the best image quality in all kinds of surroundings, in consideration of factors such as input source, screen color, and ambient lighting.

Presentation

Best for displaying presentation slides in a bright room.

Bright

Best for the installations requiring high brightness images.

Cinema

Best for videos projected in a dark room.

HDR

Best for displaying High Dynamic Range (HDR) content.

sRGB

Standardized image color that matches the sRGB color standard.

DICOM SIM.

Best for projecting monochrome medical images, such as X-ray diagram.

Blending

Best for multiple projector installations.

3D

Best for playing 3D videos.

2D High Speed

Display the status of 2D High Speed mode (This mode should not be used for medical diagnosis).

Note: *If the resolution of the input source is 800 x 600 @120Hz, 1024 x 768 @120Hz, or 1280 x 720 @120Hz, then the display mode will automatically switch to 2D High Speed then the 3D mode, PIP/PBP modes are not supported.*

USING THE PROJECTOR

User

Image settings saved by the user.

Dynamic Range

Configure the HDR setting and its effect when displaying video from 4K Blu-ray players and streaming devices.

HDR

Enable or disable HDR processing.

HDR Picture Mode

- **Bright:** Select this mode for more saturated colors.
- **Standard:** Select this mode for natural looking images.
- **Film:** Select this mode for improved detail.
- **Detail:** Select this mode for more detail in dark scenes.

Brightness

Adjust the luminous brightness of the projected image to adapt to different ambient light.

Contrast

Adjust the contrast ratio of the projected image. The contrast controls the degree of difference between the lightest and darkest parts of the image.

Sharpness

Adjust the clarity of details in the projected image to make the image clearer and sharper.

Gamma

Select an appropriate gamma value to optimize the image conformance to different input sources.

Film

Best for home theater setting.

Graphics

Best for projecting photos from PC input.

Standard (2.2)

Standard gamma value.

Vivid

Best for playing games. In this mode, color saturation and brightness are well-balanced.

3D

Best for playing 3D videos.

Blackboard

Best for projecting on to a blackboard.

DICOM SIM.

Best for projecting monochrome medical images, such as X-ray diagram.

1.8 / 2.0 / 2.4 / 2.6

Select a preset gamma value to adjust the image performance. In general, the smaller the value, the brighter the dark areas of the image will become.

USING THE PROJECTOR

Dynamic Contrast

Set up Dynamic Contrast to maximize the contrast for dark content.

Dynamic Black

Enable this function to automatically adjust the contrast ratio for video sources. It improves the black level in dark scenes by reducing the light output.

- **Speed:** Adjust the speed of the light source correction. The value ranges from 1 to 15. A lower value makes the correction slower and less aggressive while a higher value results in the faster correction.
- **Strength:** Set the strength of the dynamic contrast adjustment. The value ranges from 0 to 3, the higher the value the stronger the correction.
- **Level:** Adjust the light source when the brightness level of the current content gets lower than the set value. The value ranges from 50% to 100%. The higher the value, the larger the range to adjust the light source.

Extreme Black

Enable this function to automatically increase the contrast ratio by turning off the laser light when black image is detected.

- **AV Mute Timer:** Set a timer for the laser light to turn off after detecting black content. The set value ranges from 0s to 10s.
- **Black Signal Level:** Set a black level value as the threshold for the Real Black function. The value can be adjusted from 0% to 5%, with 0 being the darkest black and 5 being the brightest.

Color Settings

Configure the color settings of the projected image to improve the color performance.

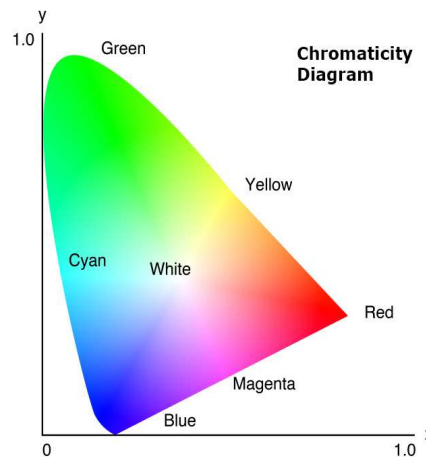

Color

Adjust the saturation of the selected color. The value indicates the color shifts from or towards the white in the center of the chromaticity diagram.

Tint

Adjust the color balance of red and green in video images.

Color Temperature

Adjust the color temperature of the projected image. The available options are Warm, Standard, and Cool.

USING THE PROJECTOR

White Balance

Adjust the white balance of the projected image via gain and offset. Gain and offset are individual controls for each RGB channels used to set greyscale. The Gains calibrate the color of the dark parts and Bias calibrate the white parts.

- **Red / Green / Blue Gain:** Adjust the color of the image's bright areas.
- **Red / Green / Blue Offset:** Adjust the color of the image's dark areas.

White Enhancement

Adjust the image color brightness while providing more vibrant colors, in increments from 0 to 10.

Color Space

Select a color space that has been specifically tuned for the input signal. The available options are Auto, RGB (0~255), RGB (16~235), REC709, and REC601.

Note: *The Color Space function is grayed out if the Picture Mode is sRGB or without any source input.*

Color Matching

Change the color of a projected image by adjusting each color component in the image. The adjustable color includes Red, Green, Blue, Cyan, Yellow, and Magenta (R / G / B / C / Y / M).

- **Auto Test Pattern:** Enable the function to view a specific color pattern while adjusting.
- **Red / Green / Blue / Cyan / Magenta / Yellow:** Select a color for further adjustment.
 - **Hue:** Adjust the hue of the selected color. The value reflects the number of degrees of rotation around the chromaticity diagram from the original color. Increasing value indicates counterclockwise rotation, and decreasing value, clockwise rotation.
 - **Saturation:** Adjust the saturation of the selected color. The value reflects the color shifts from or towards the white in the center of the chromaticity diagram.
 - **Luminance:** Adjust the luminance of the selected color. Increase the value to brighten the image (add white to a color) or decrease the value to darken the image (add black to a color).
- **White:** Adjust the white color performance via setting the Red, Green, and Blue values.
 - **Red / Green / Blue:** Adjust the red, green, and blue colors to optimize the white color performance.
- **Reset:** Reset the function settings to factory default values.

Wall Color

Set the wall color of the projector to achieve best color performance for a specific wall. The available options are Off, Blackboard, Light Yellow, Light Green, Light Blue, Pink, and Gray.

3D Setup

3D video file combines two slightly different images (frames) of the same scene representing the different views that the left and right eyes see. When these frames are displayed fast enough and viewed with 3D glasses synchronized with the left and right frames, the viewer's brain then assemble the separate images into a single 3D image. 3D Menu provides options to set up the 3D functions to correctly display 3D videos.

3D Mode

Enable or disable the 3D function.

3D Format

Select a proper 3D format for the 3D input signal. The available options are Auto, Frame Packing, Side by Side, Top and Bottom, and Frame Sequential.

USING THE PROJECTOR

3D Tech

Select a proper 3D technology according to how the 3D sync signal is processed.

- **DLP-Link:** Select DLP-Link when the 3D sync signal is generated by the DLP Link technology built into the projector. DLP Link works only with the glasses that are compatible with DLP 3D technology and the 3D function is enabled
- **3D Sync:** Select 3D Sync when the 3D sync out signal is sent to an emitter or another projector through the 3D sync out port.

3D-2D

Transform the 3D content to 2D images.

- **3D:** Play the 3D content normally.
- **L:** Play the left images of the 3D content.
- **R:** Play the right images of the 3D content.

3D Sync Out

Set up the transmission of the 3D sync output signal.

- **To Emitter:** Send the 3D sync signal to the emitter connected to the 3D sync out port.
- **To Next Projector:** Send the 3D sync signal to next projector when using multiple projectors.

IR Control setup when using the 3D IR emitter

Infrared devices interfere with each other if placed in the same sensing angle. If you want to use the 3D IR emitter and the IR remote function, do any of the following:

- Place the 3D IR emitter outside the IR remote control sensing angle as shown below:

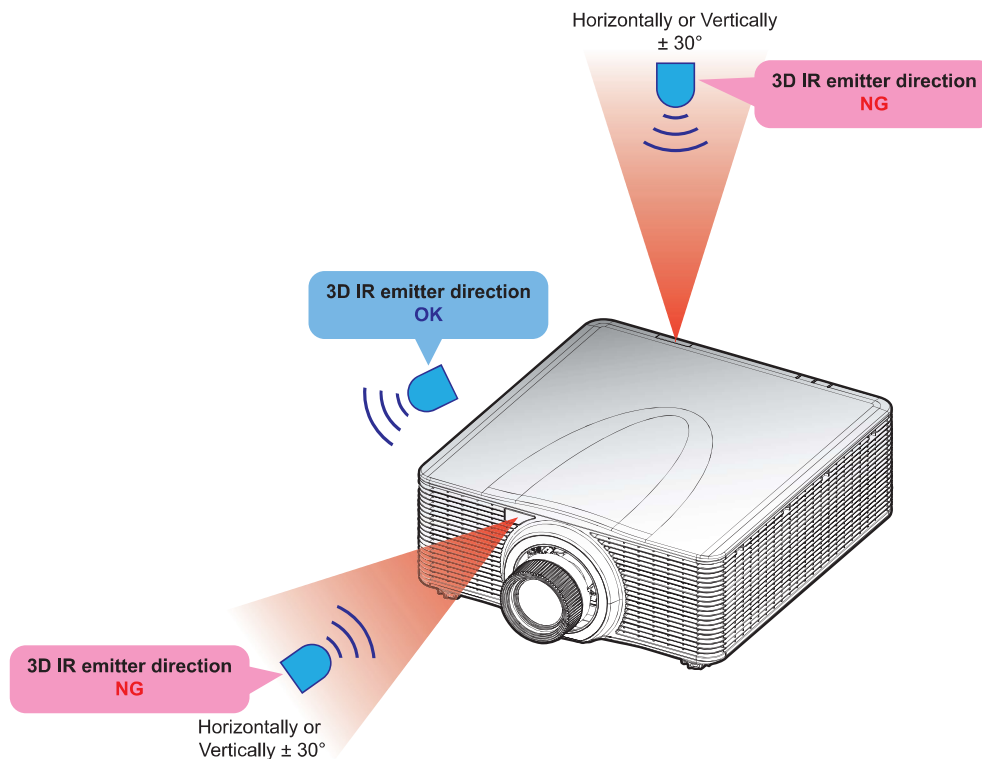

- Based on the room layout, disable either the front or the top remote receiver in the OSD menu > Communication > Remote Setup > IR Function menu to avoid the 3D IR emitter interference, yet allowing to use the IR remote control function.

USING THE PROJECTOR

If neither of the two methods described above solved the problem, please use another 3D IR emitter/3D RF emitter or try any of the following two methods.

- Use a wired remote-in cable for the IR control.

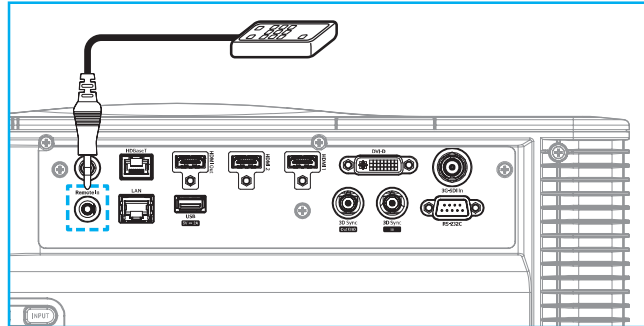

- Use the IR control via the HDBaseT device (not supplied).

Note: Disable the Front/Top remote receivers and enable the HDBaseT for IR control in the OSD menu > Communication > Remote Setup > IR Function.

3D Invert

When the 3D video does not appear correctly, use this function to invert the 3D left and right frames.

Frame Delay

Set a frame delay value for the projector to correct the time difference between the 3D signal being given and the result being executed. This function works only when L/R Reference is set to Field GPIO. When performing 3D blending on multiple projectors, set the frame delay for each projector to correct the non-synchronous images.

Reset

Reset the function settings to factory default values.

Save to User

Save the image settings to the User mode.

Apply to User

Apply the image settings to User-Presentation, User-Bright, User-Cinema, User-HDR, User sRGB, User-DICOM SIM., User-Blending, User-3D, or User-2D High Speed.

Reset

Reset all 3D settings.

USING THE PROJECTOR

Display menu

Learn how to configure the settings to properly project images according to your installation circumstances.

Submenus

- Aspect Ratio
- Digital Zoom
- Geometric Correction
- Edge Mask
- Freeze Screen
- Test Pattern
- PIP/PBP

Aspect Ratio

Set the aspect ratio of the projected image. The available options are Auto, 4:3, 16:9, 16:10, LBX, or Native. Select Auto to display the detected image size.

Digital Zoom

Digitally adjust the size of the projected image.

Note: *Image projection on the screen depends on the signal source..*

Proportional

Enable the function to have the image's height and width changed at the same ratio.

Horizontal

Use the ◀ and ▶ buttons to change the width of the projected image.

Vertical

Use the ▲ and ▼ buttons to change the height of the projected image.

Horizontal Shift

Use the ◀ and ▶ buttons to horizontally shift the image.

Vertical Shift

Use the ▲ and ▼ buttons to vertically shift the image.

Reset

Reset digital zoom settings to factory default values.

USING THE PROJECTOR

Geometric Correction

Configure the geometric settings to reshape the image for different projection surfaces.

Warp Control

Configure warp settings. Select between Basic, Advanced, and AP.

- **Basic:** Configure keystone, pincushion, 4-corner settings.
- **Advanced:** Set the grid color and grid background, as well as configure warp and blend settings.
- **AP:** Use the **Visual Suite** to control the projector. When the **Visual Suite** is enabled, the projector's built in geometry functions are disabled.

Basic Warp

Configure basic warp settings.

- **Keystone:** Keystone function is used to adjust the images in asymmetric rectangle shape.
 - **Horizontal:** Adjust the left and right side of the projected image to make it an even rectangle. It is used for the images with unequal left and right sides.

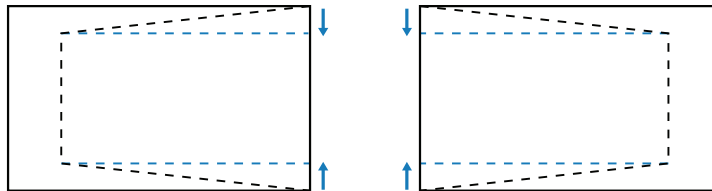

- **Vertical:** Adjust the top and bottom side of the projected image to make it an even rectangle. It is used for the images with unequal top and bottom sides.

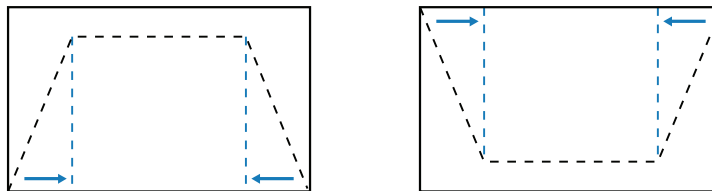

- **Pincushion:** Pincushion function is used to adjust the image with barrel or pincushion distortion.
 - **Horizontal:** Correct the projected image with horizontal barrel or pincushion distortion.

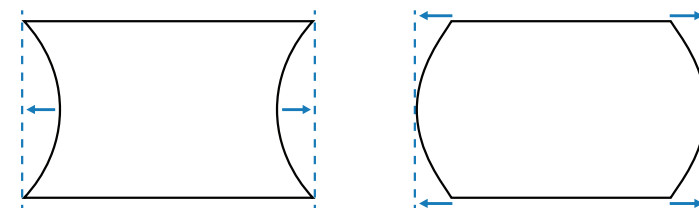

- **Vertical:** Correct the projected image with vertical barrel or pincushion distortion.

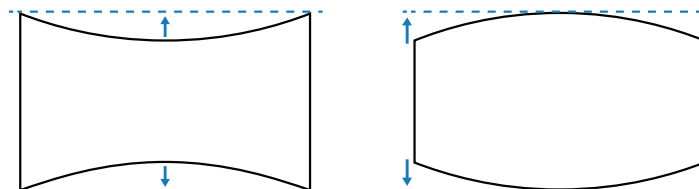

USING THE PROJECTOR

- **4-Corner:** Reshape the image by moving the 4 corners of the image to have it fit a specific projection surface.

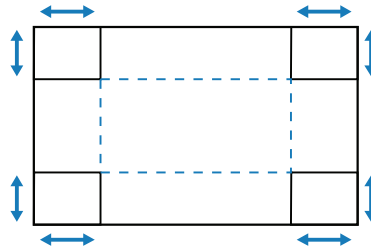

Advanced Warp

Configure advanced warp settings.

Note: When Basic or AP of Warp Control is selected, the Advanced Warp will be unavailable.

- **Grid Color:** Select a grid color for warp and blend pattern between Green, Magenta, Red, and Cyan.
- **Grid Background:** Select the grid background between Black and Transparent.
- **Warp Setting:** Configure warp settings.
 - **Grid Point:** The grid number selection of warping control, 2x2 / 3x3 / 5x5 / 9x9 / 17x17.
 - **Warp Inner:** Turn on to adjust the inner grid, the function activates when exceeding 3x3 grid points.
 - **Warp Sharpness:** When the grid lines are warped from straight into curve, the grid lines will be distorted and become jagged. To avoid the line jaggging, adjust the warp sharpness to blur or sharpen the edge of the images.
- **Blend Setting:** Configure the blend settings directly on the projector to merge two or more adjacent images into one larger and seamless image.
 - **Blend Width:** Set the blend pattern width.
 - **Overlap Grid Number:** Set adjustment scale of blend width, up to 12 pixels.
 - **Gamma:** Select the gamma value of the blend area to adjust the curvature of the blending effect.

Note: For install flexibility we have not applied a FW limitation to the blending menu of this device. Distortion may occur if you attempt to warp to an extreme level. For more complex installs, at a cost, please contact your dealer for external devices for warping.

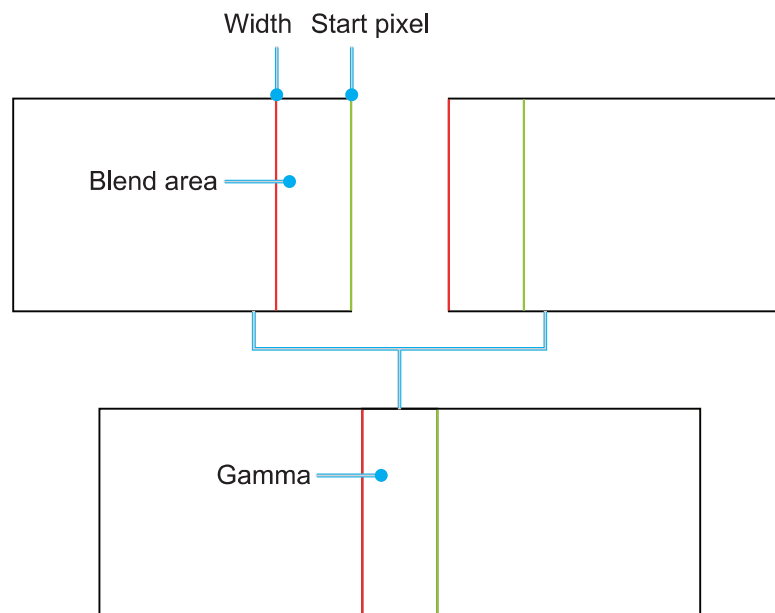

USING THE PROJECTOR

- **Black Level:** Manually adjust the black level of the projected image.
 - **Area:** Support two layers black level adjustment, top and bottom. Please avoid overlapping areas of the two layers, only top black level value displayed in overlapping area.
 - **Enable:** Enable or disable the black level adjustment in the selected area.
 - **Edit Area:** The area adjustment of black level. When entering the area adjustment view, user can press “INFO” button on remote control to get the hot key for add and remove points.
 - **Add Point:** Add up to 32 area control points for black level adjustment.
 - **Remove Point:** Remove at least 4 control points from the selected area.
- Note:**
- *Enter the Edit Area:*
 - a) Use the “INPUT” hotkey of the remote control to enable or disable the Add Point function.
 - b) Use the “AUTO” hotkey of the remote control to enable or disable the Remove Point function.
 - c) Use the “INFO” hotkey of the remote control to show the Edit Area’s hotkey help dialog, and use “MENU” or “Exit” to hide help dialog.
 - *After adding or removing a control point, press **Enter** to move to the next point counterclockwise.*
 - **Brightness:** Adjust Red / Green / Blue values of selected black level area simultaneously.
 - **Red/Green/Blue:** Adjust each color of selected black level area individually.
 - **Reset:** Reset the black level to factory default values either on the Bottom or on the Top area or on both areas.

Memory

The projector allows the user to save up to five geometry memories, including the ones set directly on the projector and the ones configured via external software tools. The available options are Save Memory, Apply Memory, and Clear Memory.

Reset

Reset geometric settings to factory default values.

Edge Mask

The edge blending function allows you to hide one or multiple edges of the projected image. You can use this function to remove the video encoding noise on the edges of the video images.

Freeze Screen

Select to pause the display screen despite any change in the source device.

Test Pattern

Select a test pattern. The available options are Off, Green Grid, Magenta Grid, White Grid, White, Black, Red, Green, Blue, Yellow, Magenta, Cyan, ANSI Contrast 4x4, Color bar, and Full screen.

USING THE PROJECTOR

PIP/PBP

PIP/PBP (picture in picture/picture by picture) allows simultaneously displaying two images from two input sources.

Screen

Select the appropriate PIP/PBP mode or disable the function.

- **Off:** Disable PIP/PBP mode.
- **PIP:** Display one input source on the main screen and the other input source in an inset window.
- **PBP:** Display two images of the same size on the screen.

Main Source

Select an input source for the main image. The available input sources are HDMI1, HDMI2, DVI-D, 3G-SDI, and HDBaseT.

Sub Source

Select an input source for the second image. The available input sources are HDMI1, HDMI2, DVI-D, 3G-SDI, and HDBaseT.

Swap

Swap the main source and sub source.





Size

Change the display size of the sub source in PIP mode.









Location

Adjust the location of the sub image. In the layout chart below, the “P” indicates the main image:



- **PBP Layout**

PBP Layout	
<p>PBP, Main Left</p> 	<p>PBP, Main Right</p> 
<p>PBP, Main Top</p> 	<p>PBP, Main Bottom</p> 

- **PIP Layout**

PIP Layout	PIP Size		
	Small	Medium	Large
PIP, Bottom Right			
PIP, Bottom Left			
PIP, Top Left			

USING THE PROJECTOR

PIP Layout	PIP Size		
	Small	Medium	Large
PIP, Top Right			

Note: Refer to the table below for PIP/PBP compatibility.

PIP/PBP Compatibility

PIP/PBP Matrix	DVI-D	HDMI-1	HDMI-2	3G-SDI	HDBaseT
DVI-D	—	V	V	V	V
HDMI-1	V	—	V	V	V
HDMI-2	V	V	—	V	V
3G-SDI	V	V	V	—	V
HDBaseT	V	V	V	V	—

Reset

Reset all the display settings to factory default values.

USING THE PROJECTOR

Input Settings menu

Learn how to configure the projector input settings.

Submenus

- Auto Source
- Quick Resync
- Active Inputs
- Latency Adjustment
- Backup Input
- HDMI
- HDBaseT

Auto Source

When Auto Source is enabled, the projector automatically detects and selects the input signal. Once an input source is selected, press the Input button on the remote control or keypad to switch to other available sources. When the function is disabled, pressing Input will bring up the Active Inputs submenu.

Quick Resync

Enable this feature to perform a quick process for synchronizing the projector with the input signal.

Active Inputs

Select an input signal from the source list. The available input sources are HDMI1, HDMI2, DVI-D, 3G-SDI, and HDBaseT.

Latency Adjustment

Enable this feature to reduce response time.

Note: *If the latency adjustment is set to 2D Ultra then the 3D mode, PIP modes, and 4K 30Hz resolution are not supported.*

Backup Input

Backup Input function allows the user to set up two input sources with the same timing specification. Upon loss of one input source, the projector automatically switches to the other source.

This function can be useful for the installations requiring uninterruptedly displaying the content source, such as live show, exhibition, and critical control room. The available input sources are HDMI1, HDMI2, DVI, and HDBaseT.

Auto Switch

Check the box to enable automatically switching to the backup input source when the current source fails.

Current Signal

Displays the current active signal.

First Input

Select a signal as the first input source. Once the selected source is activated, the OSD menu lists out the signal's Resolution, Horz Refresh (horizontal refresh rate), and Color Space.

Second Input

Select a signal as the second input source. Once the selected source is activated, the OSD menu lists out the signal's Resolution, Horz Refresh (horizontal refresh rate), and Color Space.

USING THE PROJECTOR

Backup Input Status

Display the function status. The Backup Input Status is active when meeting the following conditions:

- Auto Switch is checked.
- The two sources are with the same timing specification.
- The two sources are active.
- Projector is displaying one of the two sources.

Backup Input Change

Display the function change.

Backup Input Info.

Display the function information, including Current Signal, Backup Input Status, Backup Input Change, First Input and its Resolution, Horz Refresh, Color Space, HDR, Second Input and its Resolution, Horz Refresh, Color Space, and HDR.

HDMI

Setup the projector's HDMI ports.

Output

Select a HDMI port to output the signal.

HDMI 1 EDID/HDMI 2 EDID

When receiving a HDMI signal, set the projector's EDID compatibility to display the signal correctly. Select **1.4** for the input devices with HDMI 1.4, or **2.0** for HDMI 2.0 devices.

Reset

Reset all the input settings to factory default values.

USING THE PROJECTOR

Device Setup menu

Learn how to configure the system settings for the projector.

Submenus

- Language
- Projection
- Lens Settings
- Active Image Setup
- Schedule
- Date and Time
- Power Settings
- Light Source Settings
- Shutter
- Security
- On Screen Display
- Logo Setup
- Backlight
- High Altitude
- User Data
- System Update

Language

Select a language for the OSD menu. The available languages are English, German, French, Italian, Spanish, Portuguese, Polish, Dutch, Norwegian, Traditional Chinese, Simplified Chinese, Japanese, Korean, Russian, Hungarian, and Thai.

Projection

Change the image direction by selecting a proper projection mode.

Ceiling

Enable the function for ceiling mount installation.

Rear

Check the function for rear projection.

Lens Settings

Configure the lens settings to adjust the image quality and position.

Focus

Use the ▲ and ▼ buttons to adjust the focus of the projected image.

Zoom

Use the ⊕ and ⊖ buttons to adjust the size of the projected image.

Lens Shift

Use the ▲ ▼ ◀ ▶ buttons to adjust the lens position to shift the projected area.

USING THE PROJECTOR

Note: BX-CTA17 floating ring

- For better optical performance, manually adjust the floating ring before adjusting Zoom & Focus.
- Floating ring's label scale shows the projection distance.
- The projection distance is from the projector lens to the screen. For example, if the distance between the screen and the projector lens is 1.4 m, adjust the floating ring scale to "1.40" for better performance.

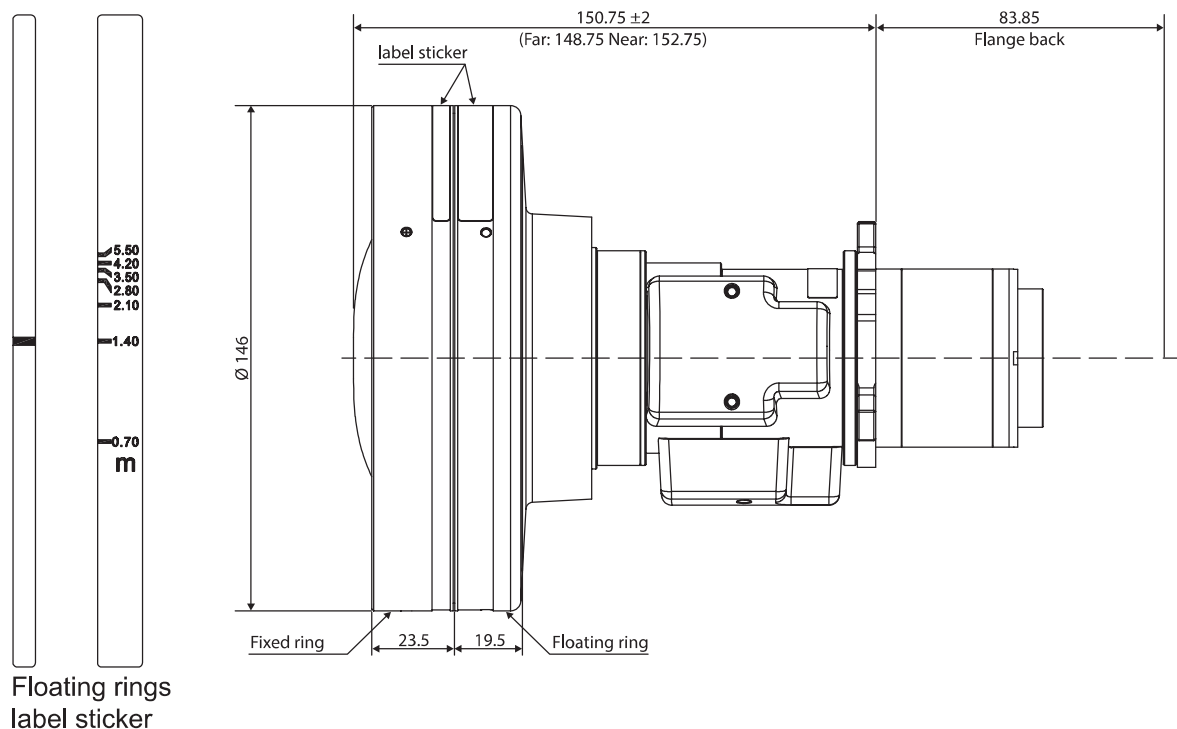

Lens Memory

This projector can save up to five lens settings, which records the lens position. To record correct data, please perform lens calibration at first time processing lens memory.

- **Save Memory:** Select a record from 1 to 5 to save the current lens settings.
- **Apply Memory:** Select a record from 1 to 5 to apply the lens settings.
- **Clear Memory:** Clear the saved lens records.

Note:

- Must Save Memory before Apply Memory, otherwise the function of apply memory will gray out or disable.
- Performing a lens calibration will clear the saved lens records.
- BX-CTA16 setup requires a special support kit. For more information, please refer to the BX-CTA16 user manual.

Lens Calibration

Calibrate the lens position to return it to the center. To prevent damage to the projector and the lens, always perform lens calibration before replacing the lens.

Lens Lock

Lock the lens to prevent the lens motors from moving, which disables all lens functions.

Reset

Reset the lens settings to factory default values.

USING THE PROJECTOR

Active Image Setup

Automatically adjust the image to achieve better performance.

- **Active Focus:** Automatically adjust the image focus.

Note:

- *Before adjusting the Active Focus, make sure the boresight has been adjusted to the best position.*
- *When the remote control performs focus adjustment, pressing the **Enter** key can also trigger the Active Focus function.*
- **Active Color Uniformity:** Automatically adjust the RGB gain of projection image to approximate the color of target area for a uniform color display. The brightness of the original content may be decreased.
 - **Calibration:** Perform the calibration process. If the RGB gain adjustment of projection area is too much difference, the color will not be projected correctly.
 - **Target Selection:** Select the target area for calibration. The default area is the center of the content. Press **Enter** to return to the OSD menu after the selection is completed.
 - **Reset:** Clear the calibration result.

Note:

- *The Active Image Setup functions are performed via the external optional camera. Please make sure the camera is not covered or blocked by any objects. The auto adjustment process might take more than one minute to complete. The accessories may vary depending on model, specification and region.*
- *The functions in the Active Image Setup menu are available for the projections from 100" to 300" and imaging range needs to cover the entire projection screen. It is recommended to use the Optoma Visual Suite software for seamless setups and calibration.*

Schedule

Schedule the projector functions to operate automatically at the set time.

Schedule	
Date and Time	2019/11/06 14:00
Schedule Mode	On
View Today	Monday ←
Monday	On
Tuesday	Off
Wednesday	Off
Thursday	Off
Friday	Off
Saturday	Off
Sunday	Off
Reset Schedule	

Enter Enter Select Exit Return

Date and Time

Before setting a schedule, setup the date and time settings. Refer to “Date and Time” on page 66.

Schedule Mode

Enable or disable the schedule function. If the projector is controlled via external devices or software, the Schedule Mode displays AP Mode, and the projector’s schedule functions are grayed out.

USING THE PROJECTOR

View Today

View the event list scheduled for today.

Note: After the schedule is set up, make sure to save all the settings.

Monday to Sunday

Set up the schedule for days of a week. On the Schedule menu page, select a day and configure the schedule settings.

Monday

Schedule Enable	<input checked="" type="checkbox"/>
01 08:00	Power On
02 08:01	HDMI 1
03 08:01	Normal Mode
04 --:--	-----
05 --:--	-----
06 --:--	-----
07 --:--	-----
08 --:--	-----

More Events
Copy Events To
Reset the Day

Enter Enter Select Return

Event 01

Time	08:00
Event	Power Settings
Reset	

Power On
Power Off
ECO
Active
Communication

Enter Enter Select Return

- **Schedule Enable:** Enable or disable the schedule function for the selected day.
- **Event 01-16:** Select an event record number, and set up the schedule details.
 - **Time:** Set the time for the event.
 - **Function:** Select the function. The available functions are Power Settings, Input Source, Light Source Mode, and Shutter
 - **Note:** If the Power Setting is set to Eco or Active, then the projector cannot boot up again.
 - **Event:** Select a function for the event, which operates automatically at the set time.
 - **Reset:** Reset the event settings.

Event List Page 1/2

01 08:00	Power On
02 08:01	HDMI 1
03 08:01	Normal Mode
04 --:--	-----
05 --:--	-----
06 --:--	-----
07 --:--	-----
08 --:--	-----
09 --:--	-----
10 --:--	-----

Enter Enter Select Change Return

Event List Page 2/2

11 --:--	-----
12 --:--	-----
13 --:--	-----
14 --:--	-----
15 --:--	-----
16 --:--	-----

Enter Enter Select Change Return

USING THE PROJECTOR

- **Copy Events To:** Copy the events setup for the day to another day.

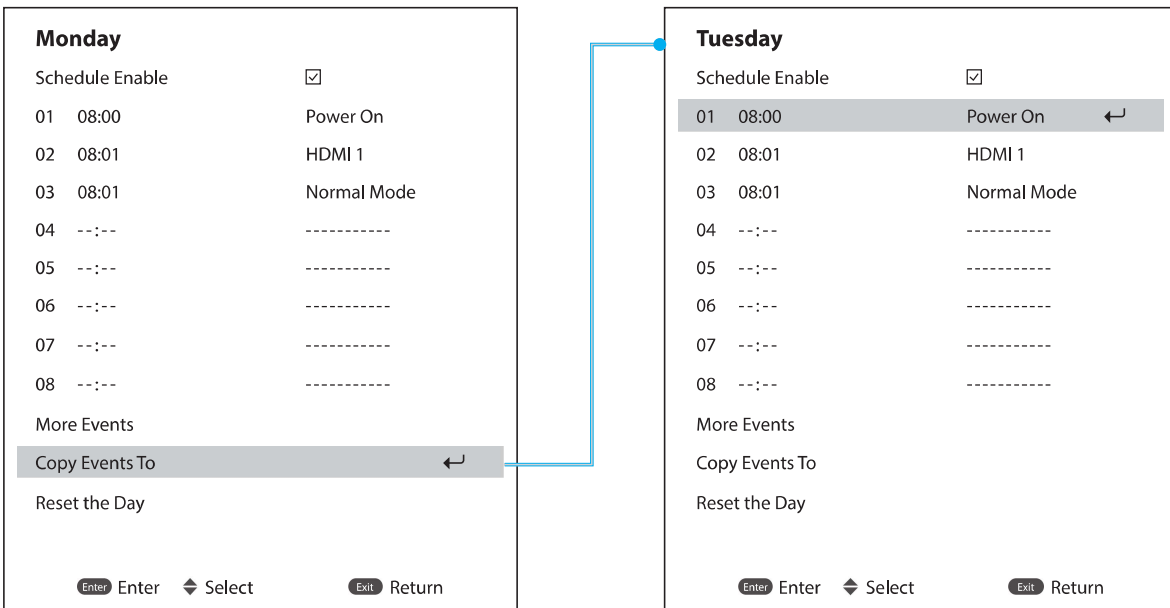

- **Reset the Day:** Reset the schedule settings for the day.

Reset Schedule

Reset all of the schedule settings.

Date and Time

Set up the projector's date and time.

Clock Mode

Set the clock mode to NTP Server or Manual.

Note: To use NTP Server, make sure the projector is connected to the Internet.

Date

Set a date for the projector. The date format is in Year/Month/Date.

Time

Set the time for the projector.

Daylight Saving Time

Enable or disable the daylight savings function.

NTP Server

Select a NTP Server for the network clock mode.

Time Zone

Set a time zone for the network clock mode.

Update Interval

Set the date and time update interval.

Apply

Apply date and time modifications.

USING THE PROJECTOR

Power Settings

Configure the projector's power settings.

Power Mode (Standby)

Setup the projector's standby mode.

- **Eco:** Minimum power consumption (< 0.5 Watt) which does not allow network control.
- **Active:** Low power consumption (< 2 Watt) which allows the LAN module to enter sleep mode and supports to be woken by Wake on LAN (WoL). When the LAN module is woken by WoL, the projector is ready to receive commands over the network.
- **Communication:** More power consumption that allows controlling the projector over the network.

Signal Power On

Turn on this function to have the projector automatically turning on when connected to HDMI input sources. It only applies to the standby projector set to Communication mode.

Auto Power Off

Set an interval timer for the projector to automatically turn off if no signal is detected within the specified time period. Press the ◀ and ▶ buttons to add or reduce time, 1 minute for each press.

Sleep Timer

Set an interval timer for the projector to automatically turn off after operating for the specified amount of time.

12V Trigger

When enabled, the projector screen is automatically raised or lowered when the projector is turned on or off. This function only works when the projector is connected to an electrical projector screen.

Note: 3.5mm mini jack that outputs 12V 500mA (max.) for relay system control.

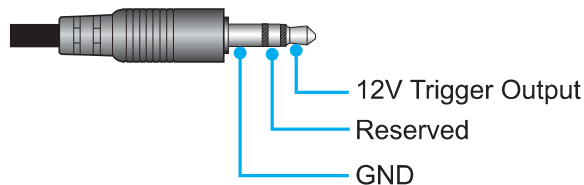

- **On:** Choose "On" to enable the trigger.
- **Off:** Choose "Off" to disable the trigger.

Reset

Reset the power settings to factory default values.

Light Source Settings

Set up the light source to control the projector brightness.

Light Source Mode

Select a light source mode depending on the installation requirements. The available options are Normal, Eco Mode, and Custom Power.

Custom Brightness

When the Light Source Mode is set to Custom Mode, set up the custom brightness level.

Set up the Constant Brightness to maintain the image brightness at a specified level. A special algorithm is designed to compensate for the natural decay of brightness so that the image can be maintained at a fixed brightness level.

- **Brightness Level:** Adjust the brightness level from 30% to 100%.
- **Constant Brightness:** Enable to maintain the image brightness at the set brightness level. A special algorithm is designed to compensate for the natural decay of brightness so that the image can be

USING THE PROJECTOR

Shutter

Set up the shutter behavior.

Fade-In

This function allows the fading-in effect when turning off the shutter. The length of the fading effect can be adjusted from 0s to 5s.

Fade-Out

This function allows the fading-out effect when turning on the shutter. The length of the fading effect can be adjusted from 0s to 5s.

Startup

Select the shutter behavior when turning on the projector.

- **Shutter Off:** Projector projects images normally after being powered on.
- **Shutter On:** Projector automatically turns on shutter after being powered on.

Security

Set up security verification to protect the projector.

Security

Select On to protect the projector with a password. If the user enters incorrect password three times, a message will pop up warning that the projector shuts down in 10 seconds.

Security Timer

Specify the length of time the projector can be used without the password. Once the timer counts to 0, the user must enter a password to use the projector. The timer restarts every time the projector is turned on.

Change Password

Change the projector password.

Note: *In the last minute before reaching a specified timer, including Auto Power Off, Sleep Timer, and Security Timer, an on-screen message will pop up warning that the projector shuts down in 60 seconds. Press any button on the remote control or projector keypad to reset the timer and the projector remains on.*

On Screen Display

Set up the on screen display menus.

Menu Location

Select the menu location from Top Left, Top Right, Center, Bottom Left, and Bottom Right.

Menu Transparency

Set the menu transparency level.

Menu Timer

Set the length of time the menu displays on the screen.

Information Hide

Enable or disable the corner information messages, such as input source, IP address, and so on.

Background

Set a background color to display when no input signal is detected. The available options are Blue, Black, White, and Logo.

USING THE PROJECTOR

Logo Setup

Set up the logo for the startup screen.

Change Logo

Change the logo for the startup screen. Apart from the Default logo, user can select from Neutral, User Logo, and Captured Logo.

- **Default:** The projector default logo.
- **Neutral:** The logo is not displayed on the startup screen.
- **User Logo:** User customized logo.
- **Captured Logo:** The logo saved via the Logo Capture function.

Note: *The supported logo format is PNG and size is 1920 x 1200 pixels.*

Logo Capture

Capture part of the projected image and save it as a customized logo.

Delete Logo

Delete the saved customized logo, including the Captured Logo and User Logo.

Backlight

Set up the projector backlight options.

Keypad

Enable or disable the keypad backlight.

Power Key

Enable or disable the backlight for the power key.

High Altitude

Select On to increase the fan speed. To ensure the image quality and prevent damage to the projector, enable High Altitude mode in high temperature, high humidity, or high altitude environment.

User Data

User can save the projector settings as user data and reload the settings later.

- **Save all settings:** Save all of the projector settings as user data. User can save up to 5 records.
- **Load all settings:** Load the previously saved user data.

System Update (FOTA)

Update the system automatically or manually.

- **Auto:** System checks for new updates automatically every time it is connected to the Internet.
- **Auto Download:** System will download the firmware upgrade file in the background and starts the upgrade process when you power off the projector. When the upgrade is done, the projector will power off.
- **Update:** Manually update the system firmware.

Reset

Reset the settings to factory default values.

- **Reset OSD:** Reset OSD settings to default values.
- **Reset to Default:** Reset all projector settings to default values.
- **Reset Selective:** Reset the settings of one of the main menus. User can choose from Image, Display, Advanced, Input, Communication, and Setup.

USING THE PROJECTOR

Communication menu

Communication menu is used to configure the settings that allow the projector to communicate with other projectors or control devices.

Submenus

- Projector ID
- Remote Setup
- Network Setup
- Email Notification
- Control
- Baud Rate

Supplemental information

- Using the web control panel
- Using RS232 command by Telnet

Projector ID

Assign an ID code for the projector from 00 to 99. Use this code as the projector ID when controlling the projector by RS232, HDBaseT, Telnet or other control methods.

Remote Setup

Configure the settings of the Infra-Red (IR) remote control.

Remote Code

Set the remote custom code by pressing the remote ID button for 3 seconds and you will notice the remote indicator (above the Off button) starts blinking. Then, input a number between 00-99 using the keyboard numbered keys. After inserting the number, the remote indicator blinks twice quickly indicating that the remote code has changed. For more information on remote codes, refer to “Remote control ID setup” on page 27.

Quick Switch Code

The IR receiving function of the projector can be temporarily deactivated by hot key(0~9) to avoid the IR interference between projectors. The remote ID needs to be set to **All**.

Note: *When hotkey is on, the default functions are inactive temporarily.*

IR Function

Set the remote receiver for the projector to control the communication between the projector and the IR remote.

- **Front:** Enable or disable the front remote receiver.
- **Top:** Enable or disable the top remote receiver.
- **HDBaseT:** Select On to set the HDBaseT terminal as the remote receiver.

User 1 / User 2

Assign a function to the User 1 and User 2 buttons on the remote control. It allows you to use the function easily without going through the OSD menus. The available functions are Freeze Screen, Blank Screen, PIP/PBP, Aspect Ratio, Information Hide, Network Setup, Projector ID, Color Matching, and Reset Selective.

USING THE PROJECTOR

Network Setup

Configure the projector's network settings.

LAN Interface

To avoid clash, specify the LAN interface to RJ-45 or HDBaseT.

MAC Address

Display the MAC address. (Read only)

Network Status

Display the network connection status. (Read only)

DHCP

Turn on DHCP to automatically acquire IP address, subnet mask, gateway, and DNS.

IP Address

Assign the projector's IP address.

Subnet Mask

Assign the projector's subnet mask.

Gateway

Assign the projector's gateway.

DNS

Assign the projector's DNS.

Apply

Apply the wired network settings.

Network Reset

Reset the network settings to default factory values.

Email Notification

Set up email notifications for some events, which allows them to be received as early alerts via emails.

Control

This projector can be controlled remotely by a computer or other external devices through wireless or wired network connection. It allows the user to control one or more projectors from a remote control center, such as powering the projector on or off, and adjusting the image brightness or contrast.

Use the Control submenu to select a control device for the projector.

Crestron

Control the projector with Crestron controller and related software. (Port: 41794)

For more information, please visit <http://www.crestron.com>.

- **Crestron Setup:** Setup the Crestron IP Address, IPID, and Port. Then select **Crestron Setup Apply** to save the modifications.

PJ Link

Control the projector with PJLink v2.0 commands. (Port: 4352)

For more information, please visit <http://pjlink.jbma.or.jp/english>.

- **PJ Link Service:** Setup the address for the PJ Link service and the related settings. Then select **PJ Link Setup Apply** to save the modifications.

Extron

Control the projector with Extron devices. (Port: 2023)

For more information, please visit <http://www.extron.com>.

USING THE PROJECTOR

AMX

Control the projector with AMX devices. (Port: 9131)

For more information, please visit <http://www.amx.com>.

Telnet

Control the projector using RS232 commands through Telnet connection. (Port: 23)

For more information, refer to "Using RS232 command by Telnet" on page 76.

HTTP

Control the projector with web browser. (Port: 80)

For more information, refer to "Using the web control panel" on page 73.

Optoma Management Suite (OMS)

Control the projector with OMS.

For more information, please visit <https://www.optoma.com>.

Reset

Reset the control functions to default factory values.

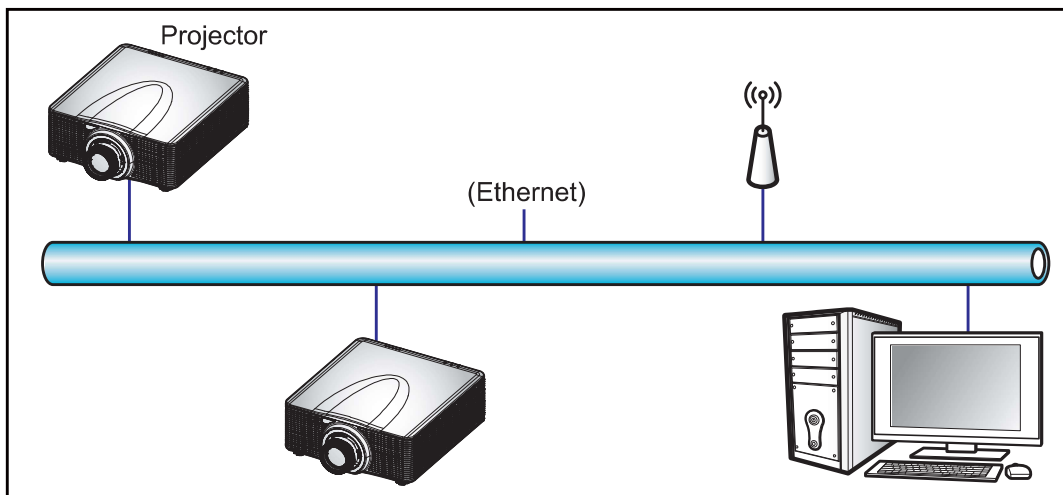

Note:

- *Crestron is a registered trademark of Crestron Electronics, Inc. of the United States.*
- *Extron is a registered trademark of Extron Electronics, Inc. of the United States.*
- *AMX is a registered trademark of AMX LLC of the United States.*
- *PJLink applied for trademark and logo registration in Japan, the United States of America, and other countries by JBMIA.*
- *For more information about the various types of external devices which can be connected to the LAN / RJ45 port and remotely control the projector, as well as the supported commands for these external devices, please contact the Support-Service directly.*

Baud Rate

Set the baud rate for Serial Port In and Serial Port Out. The available options are 1200, 2400, 4800, 9600, 19200, 38400, 57600, and 115200.

Reset

Reset all network settings to default factory values.

USING THE PROJECTOR

Using the web control panel

The Web control panel allows the user to configure various projector settings using a web browser from any personal computer or mobile devices.

System Requirements

To use the web control panel, make sure your devices and software meet the minimum system requirements.

- RJ45 cable (CAT-5e) or wireless dongle
- PC, laptop, mobile phone, or tablet installed with a web browser
- Compatible web browsers:
 - Microsoft Edge 40 or higher version
 - Firefox 57 or higher version
 - Chrome 63 or higher version

Overview of the web control panel

Configure the projector settings using web browser.

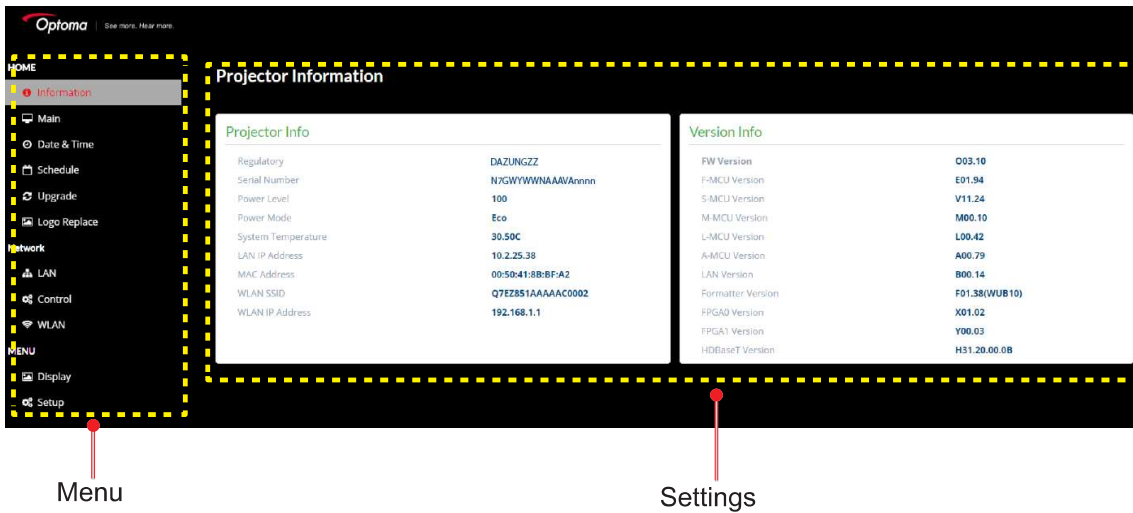

Menu	Description
HOME	View the projector information and firmware version details.
IMAGE	To configure image settings.
DISPLAY	To configure the settings to properly project images according to your installation circumstances.
INPUT SETTINGS	To configure the projector input settings.
DEVICE SETUP	To configure the system settings for the projector.
COMMUNICATION	Communication menu is used to configure the settings that allow the projector to communicate with other projectors or control devices.
INFORMATION	View the projector information about its status and settings. The projector information is read only.

USING THE PROJECTOR

Accessing the web control panel

When network is available, connect the projector and the computer to the same network. Use the projector address as the web URL to open the web control panel in a browser.

1. Check the projector address using the OSD menu.
 - On a wired network, select **Network > LAN > IP Address**.
 - **Note:** Make sure DHCP is enabled.
 - On a wireless network, select **Network > WLAN > Gateway**.
2. Open a web browser and type the projector address in the address bar.
3. The web page redirects to the web control panel.
4. In the Username field, type the username: admin(default). In the Password field, type the password.: Device serial number(default).

You can obtain the serial number from one of the following methods:

- a. The label on the projector as shown below:

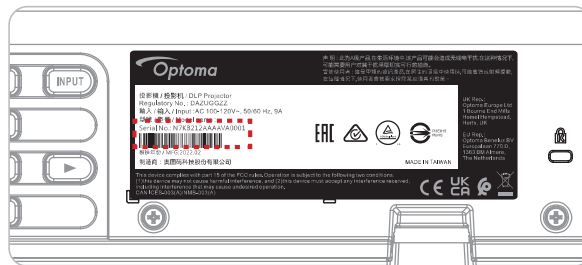

Note: Label image is only for reference.

- b. From the OSD menu (Go to **Information** → **Device** → **Serial Number**):

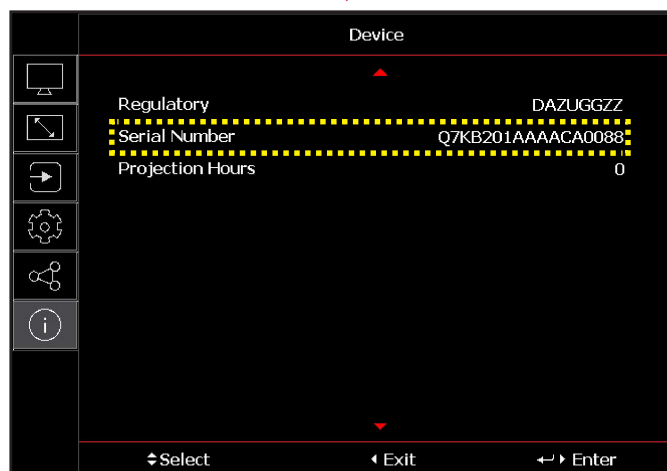
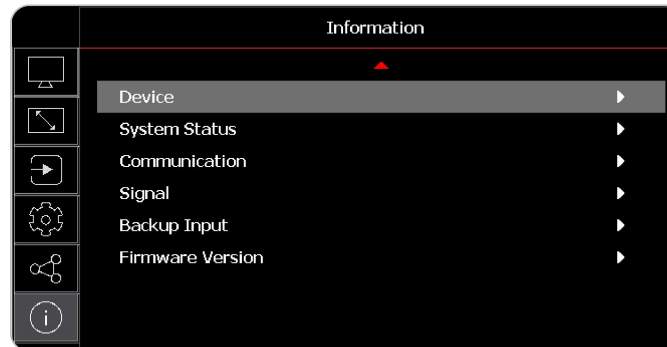

Note: It is needed to change the username and password once you have logged in. It is also advised to use a strong password.

USING THE PROJECTOR

Directly connect the projector to a computer

When network is not available, connect the projector to the computer directly using a RJ-45 cable, and configure the network settings manually.

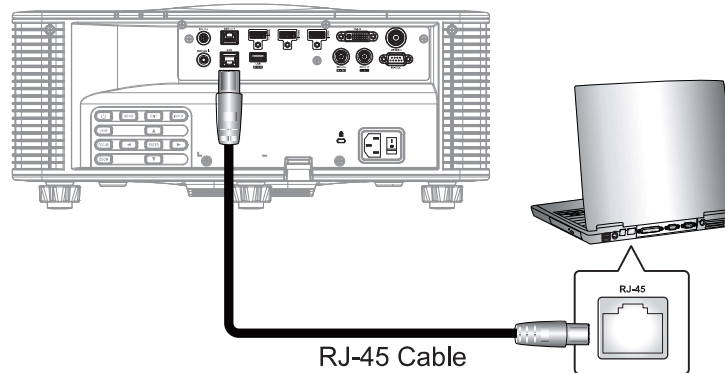

1. Assign IP address to the projector
 - From the OSD menu, select **Network > LAN**.
 - Turn off DHCP, and manually set the projector's IP Address, Subnet Mask, and Gateway.
 - Press **Enter** to confirm the settings.
2. Assign IP address to the computer
 - Set the Default Gateway and Subnet Mask of the computer to match the projector.
 - Set the IP address of the computer to match the first three numbers of the projector.
For example, if the projector IP address is 192.168.000.100, set the computer IP address to 192.168.000.xxx, where xxx is not 100.
3. Open a web browser and type the projector address in the address bar.
4. The web page redirects to the web control panel.

USING THE PROJECTOR

Using RS232 command by Telnet

This projector supports using RS232 commands through Telnet connection.

1. Set up a direct connection between the projector and computer. Refer to *Directly connect the projector to a computer* on page 75.
2. Disable the firewall on the computer.
3. Open the command dialogue on the computer. For Windows 7 operating system, select **Start > All Programs > Accessories > Command Prompt**.
4. Input the command “telnet ttt.xxx.yyy.zzz 23”.
Replace “ttt.xxx.yyy.zzz” with the projector IP address.
5. Press **Enter** on the computer keyboard.

Specification for RS232 by Telnet

- Telnet: TCP
- Telnet port: 23 (contact service team for more details)
- Telnet utility: Windows “TELNET.exe” (console mode).
- Disconnection for RS232-by-Telnet control normally: Close
- Below are the limitations for using Windows Telnet utility directly after TELNET connection is ready:
 - There is less than 50 bytes for successive network payload for Telnet-Control application.
 - There is less than 26 bytes for one complete RS232 command for Telnet-Control.
 - Minimum delay for next RS232 command must be more than 200 (ms).Information menu.

Info menu

View the projector information about its status and settings. The projector information is read only.

Submenus

- Device
- System Status
- Communication
- Signal
- Backup Input
- Firmware Version

ADDITIONAL INFORMATION

Compatible resolutions

Timing table

Signal Type	Signal Format	Resolution	Aspect Ratio		V Sync (Hz)	HDMI 1/HDMI 2							
						RGB			YCbCr 4:4:4			YCbCr 4:2:2	
						8 bit	10 bit	12 bit	8 bit	10 bit	12 bit	8 bit	
PC	VGA	640 x 350	1.33	16:10	85	V	V	V	V	V	V	V	
		640 x 400			85	V	V	V	V	V	V	V	
		640 x 480			4:3	60	V	V	V	V	V	V	V
						72	V	V	V	V	V	V	V
			75	V		V	V	V	V	V	V		
		720 x 400	1.8	9:5	85	V	V	V	V	V	V	V	
					70	V	V	V	V	V	V	V	
		SVGA	800 x 600	1.33	4:3	60	V	V	V	V	V	V	V
	72					V	V	V	V	V	V	V	
	75					V	V	V	V	V	V	V	
	85					V	V	V	V	V	V	V	
	832 x 624		1.33	4:3	120	V	V	V	V	V	V	V	
					75	V	V	V	V	V	V	V	
	848 x 480	1.33	4:3	60	V	V	V	V	V	V	V		
				75	V	V	V	V	V	V	V		
	XGA	1024 x 768	1.33	4:3	60	V	V	V	V	V	V	V	
					70	V	V	V	V	V	V	V	
					75	V	V	V	V	V	V	V	
					85	V	V	V	V	V	V	V	
	SXGA	1152 x 864	1.33	4:3	120	V	V	V	V	V	V	V	
					75	V	V	V	V	V	V	V	
	1152 x 870	1.32	4:3	75	V	V	V	V	V	V	V		
				75	V	V	V	V	V	V	V		
	WXGA	1280 x 768	1.67	5:3	60	V	V	V	V	V	V	V	
					75	V	V	V	V	V	V	V	
					85	V	V	V	V	V	V	V	
	WXGA	1280 x 800	1.6	16:10	60	V	V	V	V	V	V	V	
					75	V	V	V	V	V	V	V	
					85	V	V	V	V	V	V	V	
	SXGA	1280x960	1.33	4:3	60	V	V	V	V	V	V	V	
					85	V	V	V	V	V	V	V	
		1280 x 1024	1.25	5:4	60	V	V	V	V	V	V	V	
75					V	V	V	V	V	V	V		
85	1.25	5:4	85	V	V	V	V	V	V	V			
			85	V	V	V	V	V	V	V			
WXGA	1360 x 765	1.78	16:9	60	V	NA	NA	V	NA	NA	NA		
	1360 x 768			60	V	V	V	V	V	V	V		
	1366 x 768			60	V	V	V	V	V	V	NA		
SXGA+	1400 x 1050	1.33	4:3	60	V	V	V	V	V	V	V		
WXGA+	1440 x 900	1.6	16:10	60	V	V	V	V	V	V	V		
				75	V	V	V	V	V	V	V		
				85	V	V	V	V	V	V	V		
WXGA++	1600 x 900	1.78	16:9	60	V	V	V	V	V	V	V		
UXGA	1600 x 1200	1.33	4:3	50	V	V	V	V	V	V	V		
				60	V	V	V	V	V	V	V		

ADDITIONAL INFORMATION

Signal Type	Signal Format	Resolution	Aspect Ratio		V Sync (Hz)	HDMI 1/HDMI 2							
						RGB			YCbCr 4:4:4			YCbCr 4:2:2	
						8 bit	10 bit	12 bit	8 bit	10 bit	12 bit	8 bit	
PC	WSXGA+	1680 x 1050	1.6	16:10	60	V	V	V	V	V	V	V	
	WUXGA RB	1920 x 1200RB	1.6	16:10	50	V	V	V	V	V	V	V	
					60	V	V	V	V	V	V	V	
2K	2560 x 1440RB	1.78	16:9	60	V	V	V	V	V	V	V		
TV	SDTV (480i)	720 x 480	1.5	3:2	59.94	V	V	V	V	V	V	V	
	SDTV (480i)	720 x 480	1.5	3:2	60	V	V	V	V	V	V	V	
	SDTV (576i)	720 x 576	1.25	5:4	50	V	V	V	V	V	V	V	
	EDTV (480p)	720 x 480	1.5	3:2	59.94	V	V	V	V	V	V	V	
	EDTV (480p)	720 x 480	1.5	3:2	60	V	V	V	V	V	V	V	
	EDTV (576p)	720 x 576	1.25	5:4	50	V	V	V	V	V	V	V	
	HDTV (1080i)	1920 x 1080	1.78	16:9	50	V	V	V	V	V	V	V	V
					59.94	V	V	V	V	V	V	V	V
					60	V	V	V	V	V	V	V	V
	HDTV (720p)	1280 x 720	1.78	16:9	50	V	V	V	V	V	V	V	V
					59.94	V	V	V	V	V	V	V	V
					60	V	V	V	V	V	V	V	V
					120	V	V	V	V	V	V	V	V
	HDTV (1080p)	1920 x 1080	1.78	16:9	23.98	V	V	V	V	V	V	V	V
					24	V	V	V	V	V	V	V	V
					25	V	V	V	V	V	V	V	V
					29.97	V	V	V	V	V	V	V	V
					30	V	V	V	V	V	V	V	V
50					V	V	V	V	V	V	V	V	
59.94					V	V	V	V	V	V	V	V	
60	V	V	V	V	V	V	V	V	V				
SD-SDI	SDTV (480i)	720 x 480	1.5	3:2	59.94	NA	NA	NA	NA	NA	NA	NA	
	SDTV (576i)	720 x 576	1.25	5:4	50	NA	NA	NA	NA	NA	NA	NA	
HD-SDI	HDTV (720p)	1280 x 720	1.78	16:9	50	NA	NA	NA	NA	NA	NA	NA	
					59.94	NA	NA	NA	NA	NA	NA	NA	
					60	NA	NA	NA	NA	NA	NA	NA	
	HDTV (1080i)	1920 x 1080	1.78	16:9	50	NA	NA	NA	NA	NA	NA	NA	
					59.94	NA	NA	NA	NA	NA	NA	NA	
					60	NA	NA	NA	NA	NA	NA	NA	
	HDTV (1080p)	1920 x 1080	1.78	16:9	23.98	NA	NA	NA	NA	NA	NA	NA	
					24	NA	NA	NA	NA	NA	NA	NA	
					25	NA	NA	NA	NA	NA	NA	NA	
					29.97	NA	NA	NA	NA	NA	NA	NA	
					30	NA	NA	NA	NA	NA	NA	NA	
	HDTV (1080sF)	1920 x 1080	1.78	16:9	25	NA	NA	NA	NA	NA	NA	NA	
29.97					NA	NA	NA	NA	NA	NA	NA		
30					NA	NA	NA	NA	NA	NA	NA		
3GA-SDI	HDTV (1080p)	1920 x 1080	1.78	16:9	50	NA	NA	NA	NA	NA	NA	NA	
					59.94	NA	NA	NA	NA	NA	NA	NA	
					60	NA	NA	NA	NA	NA	NA	NA	

ADDITIONAL INFORMATION

Signal Type	Signal Format	Resolution	Aspect Ratio		V Sync (Hz)	HDMI 1/HDMI 2						
						RGB			YCbCr 4:4:4			YCbCr 4:2:2
						8 bit	10 bit	12 bit	8 bit	10 bit	12 bit	8 bit
3GB-SDI	HDTV (1080p)	1920x1080 with 352M Payload ID	1.78	16:9	50	NA	NA	NA	NA	NA	NA	NA
					59.94	NA	NA	NA	NA	NA	NA	NA
					60	NA	NA	NA	NA	NA	NA	NA
Mandatory 3D	Frame Packing (1080p)	1920 x 1080	1.78	16:9	23.98	V	V	V	V	V	V	V
					24	V	V	V	V	V	V	V
Mandatory 3D	Frame Packing (720p)	1280 x 720	1.78	16:9	50	V	V	V	V	V	V	V
					59.94	V	V	V	V	V	V	V
					60	V	V	V	V	V	V	V
	Side by Side (1080i)	1920 x 1080	1.78	16:9	50	V	V	V	V	V	V	V
					59.94	V	V	V	V	V	V	V
	Side by Side (1080p)	1920 x 1080	1.78	16:9	24	V	V	V	V	V	V	V
					50	V	V	V	V	V	V	V
					59.9	V	V	V	V	V	V	V
	Top and Bottom (720p)	1280 x 720	1.78	16:9	60	V	V	V	V	V	V	V
					50	V	V	V	V	V	V	V
					59.94	V	V	V	V	V	V	V
	Top and Bottom (1080p)	1920 x 1080	1.78	16:9	23.98	V	V	V	V	V	V	V
					24	V	V	V	V	V	V	V
					59.9	V	V	V	V	V	V	V
					60	V	V	V	V	V	V	V
	Frame Sequential 3D	SVGA	800 x 600	1.33	4:3	120	V	V	V	V	V	V
XGA		1024 x 768	1.33	4:3	120	V	V	V	V	V	V	V
HDTV		1280 x 720	1.78	16:9	120	V	V	V	V	V	V	V
HDTV		1280 x 800	1.78	16:9	120	V	V	V	V	V	V	V
1080p		1920 x 1080	1.78	16:9	120	V	V	V	V	V	V	V
					60	V	V	V	V	V	V	X
WUXGA		1920 x 1200	1.6	16:10	60	V	V	V	V	V	V	V
4K	3840 x 2160	3840 x 2160	1.78	16:9	24	V	V	V	V	V	V	V
					25	V	V	V	V	V	V	V
					30	V	V	V	V	V	V	V
					50	V	NA	NA	V	NA	NA	V
					60	V	NA	NA	V	NA	NA	V
	4096 x 2160 SMPTE	4096 x 2160	1.9	N/A	24	V	V	V	V	V	V	V
					25	V	V	V	V	V	V	V
					30	V	V	V	V	V	V	V
					50	V	NA	NA	V	NA	NA	V
					60	V	NA	NA	V	NA	NA	V

Note:

- "V" means supported and "NA" means not supported.
- "RB" means "reduced blanking".

ADDITIONAL INFORMATION

Signal Type	Signal Format	Resolution	Aspect Ratio		V Sync (Hz)	DVI						
						RGB			YCbCr 4:4:4			YCbCr 4:2:2
						8 bit	10 bit	12 bit	8 bit	10 bit	12 bit	8 bit
PC	VGA	640 x 350	1.33	16:10	85	V	V	V	V	V	V	V
		640 x 400			85	V	V	V	V	V	V	V
		640 x 480		4:3	60	V	V	V	V	V	V	V
					72	V	V	V	V	V	V	V
					75	V	V	V	V	V	V	V
		720 x 400		1.8	9:5	85	V	V	V	V	V	V
	70		V			V	V	V	V	V	V	
	SVGA	800 x 600	1.33	4:3	60	V	V	V	V	V	V	V
					72	NA	NA	NA	NA	NA	NA	V
					75	NA	NA	NA	NA	NA	NA	V
					85	V	V	V	NA	NA	NA	V
		832 x 624	1.33	4:3	120	NA	NA	NA	NA	NA	NA	NA
					75	V	V	V	NA	NA	NA	V
	848 x 480	1.33	4:3	60	V	V	V	V	V	V	V	
				75	V	V	V	V	V	V	V	
	XGA	1024 x 768	1.33	4:3	60	V	V	V	V	V	V	V
					70	NA	NA	NA	NA	NA	NA	V
					75	NA	NA	NA	V	V	V	V
					85	V	V	V	V	V	V	V
	SXGA	1152 x 864	1.33	4:3	120	NA	NA	NA	NA	NA	NA	NA
					75	V	V	V	V	V	V	V
	1152 x 870	1.32	4:3	75	V	V	V	V	V	V	V	
				75	V	V	V	V	V	V	V	
	WXGA	1280 x 768	1.67	5:3	60	NA	NA	NA	V	NA	NA	V
					75	V	V	V	V	V	V	V
					85	V	V	V	V	V	V	V
	WXGA	1280 x 800	1.6	16:10	60	NA	NA	NA	V	V	V	V
					75	V	V	V	V	V	V	V
					85	V	V	V	V	V	V	V
	SXGA	1280x960	1.33	4:3	60	V	V	V	V	V	V	V
					85	V	V	V	V	V	V	V
		1280 x 1024	1.25	5:4	60	V	V	V	V	V	V	V
					75	V	V	V	V	V	V	V
	WXGA	1360 x 765	1.78	16:9	85	V	V	V	V	V	V	V
					60	V	NA	NA	V	NA	NA	NA
					60	V	V	V	V	V	V	V
1366 x 768	1.78	16:9	60	V	V	V	V	V	V	V		
			60	V	V	V	V	V	V	V		
SXGA+	1400 x 1050	1.33	4:3	60	V	V	V	V	V	V	V	
WXGA+	1440 x 900	1.6	16:10	60	V	V	V	V	V	V	V	
				75	V	V	V	V	V	V	V	
				85	V	V	V	V	V	V	V	
WXGA++	1600 x 900	1.78	16:9	60	V	V	V	V	V	V	V	
UXGA	1600 x 1200	1.33	4:3	60	V	V	V	V	V	V	V	
				50	V	V	V	V	V	V	V	
WSXGA+	1680 x 1050	1.6	16:10	60	V	V	V	V	V	V	V	
WUXGA RB	1920 x 1200RB	1.6	16:10	60	V	V	V	V	V	V	V	
				50	V	V	V	V	V	V	V	

ADDITIONAL INFORMATION

Signal Type	Signal Format	Resolution	Aspect Ratio		V Sync (Hz)	DVI							
						RGB			YCbCr 4:4:4			YCbCr 4:2:2	
						8 bit	10 bit	12 bit	8 bit	10 bit	12 bit	8 bit	
PC	2K	2560 x 1440RB	1.78	16:9	60	NA	NA	NA	NA	NA	NA	NA	
TV	SDTV (480i)	720 x 480	1.5	3:2	59.94	V	V	V	V	V	V	V	
	SDTV (480i)	720 x 480	1.5	3:2	60	V	V	V	V	V	V	V	
	SDTV (576i)	720 x 576	1.25	5:4	50	V	V	V	V	V	V	V	
	EDTV (480p)	720 x 480	1.5	3:2	59.94	V	V	V	V	V	V	V	
	EDTV (480p)	720 x 480	1.5	3:2	60	V	V	V	V	V	V	V	
	EDTV (576p)	720 x 576	1.25	5:4	50	V	V	V	V	V	V	V	
	HDTV (1080i)	1920 x 1080	1.78	16:9	50	V	V	V	V	V	V	V	V
					59.94	V	V	V	V	V	V	V	V
					60	V	V	V	V	V	V	V	V
	HDTV (720p)	1280 x 720	1.78	16:9	50	V	V	V	V	V	V	V	V
					59.94	V	V	V	V	V	V	V	V
					60	V	V	V	V	V	V	V	V
					120	NA	NA	NA	NA	NA	NA	NA	NA
	HDTV (1080p)	1920 x 1080	1.78	16:9	23.98	V	V	V	V	V	V	V	V
					24	V	V	V	V	V	V	V	V
25					V	V	V	V	V	V	V	V	
29.97					V	V	V	V	V	V	V	V	
30					V	V	V	V	V	V	V	V	
50					V	V	V	V	V	V	V	V	
59.94					V	V	V	V	V	V	V	V	
60	V	V	V	V	V	V	V	V					
SD-SDI	SDTV (480i)	720 x 480	1.5	3:2	59.94	NA	NA	NA	NA	NA	NA	NA	
	SDTV (576i)	720 x 576	1.25	5:4	50	NA	NA	NA	NA	NA	NA	NA	
HD-SDI	HDTV (720p)	1280 x 720	1.78	16:9	50	NA	NA	NA	NA	NA	NA	NA	
					59.94	NA	NA	NA	NA	NA	NA	NA	
					60	NA	NA	NA	NA	NA	NA	NA	
	HDTV (1080i)	1920 x 1080	1.78	16:9	50	NA	NA	NA	NA	NA	NA	NA	
					59.94	NA	NA	NA	NA	NA	NA	NA	
					60	NA	NA	NA	NA	NA	NA	NA	
	HDTV (1080p)	1920 x 1080	1.78	16:9	23.98	NA	NA	NA	NA	NA	NA	NA	
					24	NA	NA	NA	NA	NA	NA	NA	
					25	NA	NA	NA	NA	NA	NA	NA	
					29.97	NA	NA	NA	NA	NA	NA	NA	
					30	NA	NA	NA	NA	NA	NA	NA	
	HDTV (1080sF)	1920 x 1080	1.78	16:9	25	NA	NA	NA	NA	NA	NA	NA	
					29.97	NA	NA	NA	NA	NA	NA	NA	
30					NA	NA	NA	NA	NA	NA	NA		
3GA-SDI	HDTV (1080p)	1920 x 1080	1.78	16:9	50	NA	NA	NA	NA	NA	NA	NA	
					59.94	NA	NA	NA	NA	NA	NA	NA	
					60	NA	NA	NA	NA	NA	NA	NA	
3GB-SDI	HDTV (1080p)	1920x1080 with 352M Payload ID	1.78	16:9	50	NA	NA	NA	NA	NA	NA	NA	
					59.94	NA	NA	NA	NA	NA	NA	NA	
					60	NA	NA	NA	NA	NA	NA	NA	
Mandatory 3D	Frame Packing (1080p)	1920 x 1080	1.78	16:9	23.98	NA	NA	NA	NA	NA	NA	NA	
					24	NA	NA	NA	NA	NA	NA	NA	

ADDITIONAL INFORMATION

Signal Type	Signal Format	Resolution	Aspect Ratio		V Sync (Hz)	DVI						
						RGB			YCbCr 4:4:4			YCbCr 4:2:2
						8 bit	10 bit	12 bit	8 bit	10 bit	12 bit	8 bit
Mandatory 3D	Frame Packing (720p)	1280 x 720	1.78	16:9	50	NA	NA	NA	NA	NA	NA	NA
					59.94	NA	NA	NA	NA	NA	NA	NA
					60	NA	NA	NA	NA	NA	NA	NA
	Side by Side (1080i)	1920 x 1080	1.78	16:9	50	NA	NA	NA	NA	NA	NA	NA
					59.94	NA	NA	NA	NA	NA	NA	NA
					60	NA	NA	NA	NA	NA	NA	NA
	Side by Side (1080p)	1920 x 1080	1.78	16:9	24	NA	NA	NA	NA	NA	NA	NA
					50	NA	NA	NA	NA	NA	NA	NA
					59.9	NA	NA	NA	NA	NA	NA	NA
	Top and Bottom (720p)	1280 x 720	1.78	16:9	50	NA	NA	NA	NA	NA	NA	NA
					59.94	NA	NA	NA	NA	NA	NA	NA
					60	NA	NA	NA	NA	NA	NA	NA
	Top and Bottom (1080p)	1920 x 1080	1.78	16:9	23.98	NA	NA	NA	NA	NA	NA	NA
					24	NA	NA	NA	NA	NA	NA	NA
					59.9	NA	NA	NA	NA	NA	NA	NA
	Frame Sequential 3D	SVGA	800 x 600	1.33	4:3	120	V	V	V	V	V	V
XGA		1024 x 768	1.33	4:3	120	V	V	V	V	V	V	V
HDTV		1280 x 720	1.78	16:9	120	V	V	V	V	V	V	V
HDTV		1280 x 800	1.78	16:9	120	V	V	V	V	V	V	V
1080p		1920 x 1080	1.78	16:9	120	V	V	V	V	V	V	V
					60	V	V	V	V	V	V	V
WUXGA	1920 x 1200	1.6	16:10	60	V	V	V	V	V	V	V	
4K	3840 x 2160	3840 x 2160	1.78	16:9	24	NA	NA	NA	NA	NA	NA	NA
					25	NA	NA	NA	NA	NA	NA	NA
					30	NA	NA	NA	NA	NA	NA	NA
					50	NA	NA	NA	NA	NA	NA	NA
					60	NA	NA	NA	NA	NA	NA	NA
	4096 x 2160 SMPTE	4096 x 2160	1.9	N/A	24	NA	NA	NA	NA	NA	NA	NA
					25	NA	NA	NA	NA	NA	NA	NA
					30	NA	NA	NA	NA	NA	NA	NA
					50	NA	NA	NA	NA	NA	NA	NA
					60	NA	NA	NA	NA	NA	NA	NA

Note:

- “V” means supported and “NA” means not supported.
- “RB” means “reduced blanking”.

ADDITIONAL INFORMATION

Signal Type	Signal Format	Resolution	Aspect Ratio		V Sync (Hz)	3G-SDI
						YCbCr 4:2:2
						10 bit
PC	VGA	640 x 350	1.33	16:10	85	NA
		640 x 400			85	NA
		640 x 480		4:3	60	NA
					72	NA
		720 x 400	1.8	9:5	75	NA
					85	NA
		70	85	NA	NA	
				NA	NA	
	SVGA	800 x 600	1.33	4:3	60	NA
					72	NA
					75	NA
					85	NA
		832 x 624	1.33	4:3	120	NA
					75	NA
	848 x 480			60	NA	
	XGA	1024 x 768	1.33	4:3	60	NA
					70	NA
					75	NA
					85	NA
					120	NA
	SXGA	1152 x 864	1.33	4:3	75	NA
		1152 x 870	1.32		75	NA
	WXGA	1280 x 768	1.67	5:3	60	NA
					75	NA
					85	NA
	WXGA	1280 x 800	1.6	16:10	60	NA
					75	NA
					85	NA
	SXGA	1280x960	1.33	4:3	60	NA
		1280 x 1024	1.25	5:4	85	NA
					60	NA
					75	NA
85	NA					
WXGA	1360 x 765	1.78	16:9	60	NA	
	1360 x 768			60	NA	
	1366 x 768			60	NA	
SXGA+	1400 x 1050	1.33	4:3	60	NA	
WXGA+	1440 x 900	1.6	16:10	60	NA	
				75	NA	
				85	NA	
WXGA++	1600 x 900	1.78	16:9	60	NA	
UXGA	1600 x 1200	1.33	4:3	50	NA	
				60	NA	
WSXGA+	1680 x 1050	1.6	16:10	60	NA	
WUXGA RB	1920 x 1200RB	1.6	16:10	50	NA	
				60	NA	
2K	2560 x 1440RB	1.78	16:9	60	NA	

ADDITIONAL INFORMATION

Signal Type	Signal Format	Resolution	Aspect Ratio		V Sync (Hz)	3G-SDI
						YCbCr 4:2:2
						10 bit
TV	SDTV (480i)	720 x 480	1.5	3:2	59.94	NA
	SDTV (480i)	720 x 480	1.5	3:2	60	NA
	SDTV (576i)	720 x 576	1.25	5:4	50	NA
	EDTV (480p)	720 x 480	1.5	3:2	59.94	NA
	EDTV (480p)	720 x 480	1.5	3:2	60	NA
	EDTV (576p)	720 x 576	1.25	5:4	50	NA
	HDTV (1080i)	1920 x 1080	1.78	16:9	50	NA
					59.94	NA
					60	NA
	HDTV (720p)	1280 x 720	1.78	16:9	50	NA
					59.94	NA
					60	NA
	HDTV (1080p)	1920 x 1080	1.78	16:9	120	NA
					23.98	NA
					24	NA
					25	NA
					29.97	NA
					30	NA
50					NA	
59.94	NA					
60	NA					
SD-SDI	SDTV (480i)	720 x 480	1.5	3:2	59.94	V
	SDTV (576i)	720 x 576	1.25	5:4	50	V
HD-SDI	HDTV (720p)	1280 x 720	1.78	16:9	50	V
					59.94	V
					60	V
	HDTV (1080i)	1920 x 1080	1.78	16:9	50	V
					59.94	V
					60	V
	HDTV (1080p)	1920 x 1080	1.78	16:9	23.98	V
					24	V
					25	V
					29.97	V
					30	V
					25	V
HDTV (1080sF)	1920 x 1080	1.78	16:9	29.97	V	
				30	V	
				50	V	
3GA-SDI	HDTV (1080p)	1920 x 1080	1.78	16:9	59.94	V
					60	V
					50	V
3GB-SDI	HDTV (1080p)	1920x1080 with 352M Payload ID	1.78	16:9	59.94	V
					60	V
					23.98	NA
Mandatory 3D	Frame Packing (1080p)	1920 x 1080	1.78	16:9	24	NA

ADDITIONAL INFORMATION

Signal Type	Signal Format	Resolution	Aspect Ratio		V Sync (Hz)	3G-SDI				
						YCbCr 4:2:2				
						10 bit				
Mandatory 3D	Frame Packing (720p)	1280 x 720	1.78	16:9	50	NA				
					59.94	NA				
					60	NA				
	Side by Side (1080i)	1920 x 1080	1.78	16:9	50	NA				
					59.94	NA				
					60	NA				
	Side by Side (1080p)	1920 x 1080	1.78	16:9	24	NA				
					50	NA				
					59.9	NA				
	Top and Bottom (720p)	1280 x 720	1.78	16:9	60	NA				
					50	NA				
					59.94	NA				
	Top and Bottom (1080p)	1920 x 1080	1.78	16:9	23.98	NA				
					24	NA				
					59.9	NA				
Frame Sequential 3D	SVGA	800 x 600	1.33	4:3	120	NA				
					XGA	1024 x 768	1.33	4:3	120	NA
					HDTV	1280 x 720	1.78	16:9	120	NA
	HDTV	1280 x 800	1.78	16:9	120	NA				
					1080p	1920 x 1080	1.78	16:9	120	NA
					60	NA				
	WUXGA	1920 x 1200	1.6	16:10	50	NA				
					120	NA				
					60	NA				
	4K	3840 x 2160	3840 x 2160	1.78	16:9	24	NA			
						25	NA			
						30	NA			
50						NA				
60						NA				
4096 x 2160 SMPTE		4096 x 2160	1.9	N/A	24	NA				
					25	NA				
					30	NA				
					50	NA				
					60	NA				

Note:

- “V” means supported and “NA” means not supported.
- “RB” means “reduced blanking”.

ADDITIONAL INFORMATION

Signal Type	Signal Format	Resolution	Aspect Ratio		V Sync (Hz)	HDBaseT						
						RGB			YCbCr 4:4:4			YCbCr 4:2:2
						8 bit	10 bit	12 bit	8 bit	10 bit	12 bit	8 bit
PC	VGA	640 x 350	1.33	16:10	85	V	V	V	V	V	V	V
		640 x 400			85	V	V	V	V	V	V	V
		640 x 480			60	V	V	V	V	V	V	V
					72	V	V	V	V	V	V	V
			75	V	V	V	V	V	V	V		
		85	V	V	V	V	V	V	V	V		
		720 x 400	1.8	9:5	70	V	V	V	V	V	V	V
		85	V	V	V	V	V	V	V	V	V	
	SVGA	800 x 600	1.33	4:3	60	V	V	V	V	V	V	V
					72	V	V	V	V	V	V	V
					75	V	V	V	V	V	V	V
					85	V	V	V	V	V	V	V
		120	V	V	V	V	V	V	V			
		832 x 624	1.33	4:3	75	V	V	V	V	V	V	V
	848 x 480	60			V	V	V	V	V	V	V	
	XGA	1024 x 768	1.33	4:3	60	V	V	V	V	V	V	V
					70	V	V	V	V	V	V	V
					75	V	V	V	V	V	V	V
					85	V	V	V	V	V	V	V
					120	V	V	V	V	V	V	V
	SXGA	1152 x 864	1.33	4:3	75	V	V	V	V	V	V	V
		1152 x 870	1.32		75	V	V	V	V	V	V	V
	WXGA	1280 x 768	1.67	5:3	60	V	V	V	V	V	V	V
					75	V	V	V	V	V	V	V
					85	V	V	V	V	V	V	V
	WXGA	1280 x 800	1.6	16:10	60	V	V	V	V	V	V	V
					75	V	V	V	V	V	V	V
					85	V	V	V	V	V	V	V
	SXGA	1280x960	1.33	4:3	60	V	V	V	V	V	V	V
					85	V	V	V	V	V	V	V
		1280 x 1024	1.25	5:4	60	V	V	V	V	V	V	V
					75	V	V	V	V	V	V	V
					85	V	V	V	V	V	NA	V
	WXGA	1360 x 765	1.78	16:9	60	V	NA	NA	V	NA	NA	NA
		1360 x 768			60	V	V	V	V	V	V	V
		1366 x 768			60	V	V	V	V	V	V	NA
	SXGA+	1400 x 1050	1.33	4:3	60	V	V	V	V	V	V	V
	WXGA+	1440 x 900	1.6	16:10	60	V	V	V	V	V	V	V
					75	V	V	V	V	V	V	V
					85	V	V	V	V	V	V	V
WXGA++	1600 x 900	1.78	16:9	60	V	V	V	V	V	V	V	
UXGA	1600 x 1200	1.33	4:3	50	V	V	V	V	V	V	V	
				60	V	V	V	V	V	NA	V	
WSXGA+	1680 x 1050	1.6	16:10	60	V	V	V	V	V	V	V	
WUXGA RB	1920 x 1200RB	1.6	16:10	50	V	V	V	V	V	V	V	
				60	V	V	V	V	V	NA	V	

ADDITIONAL INFORMATION

Signal Type	Signal Format	Resolution	Aspect Ratio		V Sync (Hz)	HDBaseT							
						RGB			YCbCr 4:4:4			YCbCr 4:2:2	
						8 bit	10 bit	12 bit	8 bit	10 bit	12 bit	8 bit	
PC	2K	2560 x 1440RB	1.78	16:9	60	V	NA	NA	V	NA	NA	V	
TV	SDTV (480i)	720 x 480	1.5	3:2	59.94	V	V	V	V	V	V	V	
	SDTV (480i)	720 x 480	1.5	3:2	60	V	V	V	V	V	V	V	
	SDTV (576i)	720 x 576	1.25	5:4	50	V	V	V	V	V	V	V	
	EDTV (480p)	720 x 480	1.5	3:2	59.94	V	V	V	V	V	V	V	
	EDTV (480p)	720 x 480	1.5	3:2	60	V	V	V	V	V	V	V	
	EDTV (576p)	720 x 576	1.25	5:4	50	V	V	V	V	V	V	V	
	HDTV (1080i)	1920 x 1080	1.78	16:9	50	V	V	V	V	V	V	V	V
					59.94	V	V	V	V	V	V	V	V
					60	V	V	V	V	V	V	V	V
	HDTV (720p)	1280 x 720	1.78	16:9	50	V	V	V	V	V	V	V	V
					59.94	V	V	V	V	V	V	V	V
					60	V	V	V	V	V	V	V	V
	HDTV (1080p)	1920 x 1080	1.78	16:9	23.98	V	V	V	V	V	V	V	V
					24	V	V	V	V	V	V	V	V
					25	V	V	V	V	V	V	V	V
					29.97	V	V	V	V	V	V	V	V
					30	V	V	V	V	V	V	V	V
					50	V	V	V	V	V	V	V	V
59.94					V	V	V	V	V	V	V	V	
60	V	V	V	V	V	V	V	V					
SD-SDI	SDTV (480i)	720 x 480	1.5	3:2	59.94	NA	NA	NA	NA	NA	NA	NA	
	SDTV (576i)	720 x 576	1.25	5:4	50	NA	NA	NA	NA	NA	NA	NA	
HD-SDI	HDTV (720p)	1280 x 720	1.78	16:9	50	NA	NA	NA	NA	NA	NA	NA	
					59.94	NA	NA	NA	NA	NA	NA	NA	
					60	NA	NA	NA	NA	NA	NA	NA	
	HDTV (1080i)	1920 x 1080	1.78	16:9	50	NA	NA	NA	NA	NA	NA	NA	
					59.94	NA	NA	NA	NA	NA	NA	NA	
					60	NA	NA	NA	NA	NA	NA	NA	
	HDTV (1080p)	1920 x 1080	1.78	16:9	23.98	NA	NA	NA	NA	NA	NA	NA	
					24	NA	NA	NA	NA	NA	NA	NA	
					25	NA	NA	NA	NA	NA	NA	NA	
					29.97	NA	NA	NA	NA	NA	NA	NA	
					30	NA	NA	NA	NA	NA	NA	NA	
	HDTV (1080sF)	1920 x 1080	1.78	16:9	25	NA	NA	NA	NA	NA	NA	NA	
29.97					NA	NA	NA	NA	NA	NA	NA		
30					NA	NA	NA	NA	NA	NA	NA		
3GA-SDI	HDTV (1080p)	1920 x 1080	1.78	16:9	50	NA	NA	NA	NA	NA	NA	NA	
					59.94	NA	NA	NA	NA	NA	NA	NA	
					60	NA	NA	NA	NA	NA	NA	NA	
3GB-SDI	HDTV (1080p)	1920x1080 with 352M Payload ID	1.78	16:9	50	NA	NA	NA	NA	NA	NA	NA	
					59.94	NA	NA	NA	NA	NA	NA	NA	
					60	NA	NA	NA	NA	NA	NA	NA	
Mandatory 3D	Frame Packing (1080p)	1920 x 1080	1.78	16:9	23.98	V	V	V	V	V	V	V	
					24	V	V	V	V	V	V	V	

ADDITIONAL INFORMATION

Signal Type	Signal Format	Resolution	Aspect Ratio		V Sync (Hz)	HDBaseT						
						RGB			YCbCr 4:4:4			YCbCr 4:2:2
						8 bit	10 bit	12 bit	8 bit	10 bit	12 bit	8 bit
Mandatory 3D	Frame Packing (720p)	1280 x 720	1.78	16:9	50	V	V	V	V	V	V	V
					59.94	V	V	V	V	V	V	V
					60	V	V	V	V	V	V	V
	Side by Side (1080i)	1920 x 1080	1.78	16:9	50	V	V	V	V	V	V	V
					59.94	V	V	V	V	V	V	V
					60	V	V	V	V	V	V	V
	Side by Side (1080p)	1920 x 1080	1.78	16:9	24	V	V	V	V	V	V	V
					50	V	V	V	V	V	V	V
					59.9	V	V	V	V	V	V	V
	Top and Bottom (720p)	1280 x 720	1.78	16:9	60	V	V	V	V	V	V	V
					50	V	V	V	V	V	V	V
					59.94	V	V	V	V	V	V	V
	Top and Bottom (1080p)	1920 x 1080	1.78	16:9	23.98	V	V	V	V	V	V	V
					24	V	V	V	V	V	V	V
					59.9	V	V	V	V	V	V	V
					60	V	V	V	V	V	V	V
Frame Sequential 3D	SVGA	800 x 600	1.33	4:3	120	V	V	V	V	V	V	V
	XGA	1024 x 768	1.33	4:3	120	V	V	V	V	V	V	V
	HDTV	1280 x 720	1.78	16:9	120	V	V	V	V	V	V	V
	HDTV	1280 x 800	1.78	16:9	120	V	V	V	V	V	V	V
	1080p	1920 x 1080	1.78	16:9	120	V	V	V	V	V	V	V
					60	V	V	V	V	V	V	V
	WUXGA	1920 x 1200	1.6	16:10	60	V	V	V	V	V	V	V
4K	3840 x 2160	3840 x 2160	1.78	16:9	24	V	V	V	V	V	V	V
					25	V	V	V	V	V	V	V
					30	V	V	V	V	V	V	V
					50	NA	NA	NA	NA	NA	NA	NA
					60	NA	NA	NA	NA	NA	NA	NA
	4096 x 2160 SMPTE	4096 x 2160	1.9	N/A	24	NA	NA	NA	NA	NA	NA	NA
					25	NA	NA	NA	NA	NA	NA	NA
					30	NA	NA	NA	NA	NA	NA	NA
					50	NA	NA	NA	NA	NA	NA	NA
					60	NA	NA	NA	NA	NA	NA	NA

Note:

- "V" means supported and "NA" means not supported.
- "RB" means "reduced blanking".

ADDITIONAL INFORMATION

EDID table

DVI		
Established Timing:	Standard Timing:	Detail Timing:
720 x 400 @70Hz	1024 x 768 @120Hz	1920 x 1200 @59Hz
720 x 400 @88Hz	1280 x 800 @75Hz	1920 x 1080 @60Hz
640 x 480 @60Hz	1280 x 1024 @60Hz	640 x 480 @60Hz
640 x 480 @67Hz	1360 x 765 @60Hz	720 x 480 @60Hz
640 x 480 @72Hz	800 x 600 @120Hz	1280 x 720 @60Hz
640 x 480 @75Hz	1400 x 1050 @60Hz	1920 x 1080i @60Hz
800 x 600 @56Hz	1600 x 1200 @60Hz	720 x 480i @60Hz
800 x 600 @60Hz	1680 x 1050 @60Hz	720 x 576 @50Hz
800 x 600 @72Hz		1280 x 720 @50Hz
800 x 600 @75Hz		1920 x 1080i @50Hz
832 x 624 @75Hz		720 x 576i @50Hz
1024 x 768 @60Hz		1920 x 1080 @50Hz
1024 x 768 @70Hz		1920 x 1080 @24Hz
1024 x 768 @75Hz		1440 x 480 @60Hz
1280 x 1024 @75Hz		1920 x 1080 @25Hz
1152 x 870 @75Hz		

HDMI 1.4		
Established Timing:	Standard Timing:	Detail Timing:
720 x 400 @70Hz	1024 x 768 @120Hz	1920 x 1200 @59Hz
720 x 400 @88Hz	1280 x 800 @75Hz	1920 x 1080 @60Hz
640 x 480 @60Hz	1280 x 1024 @60Hz	640 x 480 @60Hz
640 x 480 @67Hz	1360 x 765 @60Hz	720 x 480 @60Hz
640 x 480 @72Hz	800 x 600 @120Hz	1280 x 720 @60Hz
640 x 480 @75Hz	1400 x 1050 @60Hz	1920 x 1080i @60Hz
800 x 600 @56Hz	1600 x 1200 @60Hz	720 x 480i @60Hz
800 x 600 @60Hz	1680 x 1050 @60Hz	720 x 576 @50Hz
800 x 600 @72Hz		1280 x 720 @50Hz
800 x 600 @75Hz		1920 x 1080i @50Hz
832 x 624 @75Hz		720 x 576i @50Hz
1024 x 768 @60Hz		1920 x 1080 @50Hz
1024 x 768 @70Hz		1920 x 1080 @24Hz
1024 x 768 @75Hz		1440 x 480 @60Hz
1280 x 1024 @75Hz		1920 x 1080 @25Hz
1152 x 870 @75Hz		1280 x 720 @120Hz
		1920 x 1080 @120Hz
		3840 x 2160 @24Hz
		3840 x 2160 @25Hz
		3840 x 2160 @30Hz
		4096 x 2160 @24Hz
		4096 x 2160 @25Hz
		4096 x 2160 @30Hz

ADDITIONAL INFORMATION

HDMI 2.0		
Established Timing:	Standard Timing:	Detail Timing:
720 x 400 @70Hz	1024 x 768 @120Hz	1920 x 1200 @59Hz
720 x 400 @88Hz	1280 x 800 @75Hz	1920 x 1080 @60Hz
640 x 480 @60Hz	1280 x 1024 @60Hz	640 x 480 @60Hz
640 x 480 @67Hz	1360 x 765 @60Hz	720 x 480 @60Hz
640 x 480 @72Hz	800 x 600 @120Hz	1280 x 720 @60Hz
640 x 480 @75Hz	1400 x 1050 @60Hz	1920 x 1080i @60Hz
800 x 600 @56Hz	1600 x 1200 @60Hz	720 x 480i @60Hz
800 x 600 @60Hz	1680 x 1050 @60Hz	720 x 576 @50Hz
800 x 600 @72Hz		1280 x 720 @50Hz
800 x 600 @75Hz		1920 x 1080i @50Hz
832 x 624 @75Hz		720 x 576i @50Hz
1024 x 768 @60Hz		1920 x 1080 @50Hz
1024 x 768 @70Hz		1920 x 1080 @24Hz
1024 x 768 @75Hz		1440 x 480 @60Hz
1280 x 1024 @75Hz		1920 x 1080 @25Hz
1152 x 870 @75Hz		1280 x 720 @120Hz
		1920 x 1080 @120Hz
		3840 x 2160 @24Hz
		3840 x 2160 @25Hz
		3840 x 2160 @30Hz
		3840 x 2160 @50Hz
		3840 x 2160 @60Hz
		4096 x 2160 @24Hz
		4096 x 2160 @25Hz
		4096 x 2160 @30Hz
		4096 x 2160 @50Hz
		4096 x 2160 @60Hz

ADDITIONAL INFORMATION

Image size and projection distance

Platform			WUXGA (16:10)												
DMD			0.67"												
Projection Lens			BX-CTA16	BX-CTA17		BX-CTA15		BX-CAA01		BX-CAA06		BX-CAA03		BX-CTA13	
Throw Ratio			0.361 (120")	0.65-0.75		0.75-0.95		0.95-1.22		1.22-1.52		1.52-2.92		2.90-5.50	
Zoom Ratio			NA	1.15x		1.26X		1.28X		1.25X		1.9X		1.9X	
Throw Distance (m) (min/max)			0.93~3.11m	0.70~8.08m		0.81-10.23m		1.02~13.14m		1.31~16.37m		1.64~31.45m		3.12~59.23m	
Projection screen size			Projection distance (m)												
Throw Ratio Spec.			0.361 (120")	0.65	0.75	0.75	0.95	0.95	1.22	1.22	1.52	1.52	2.92	2.9	5.5
Diagonal (inch)	Height (m)	Width (m)	(m)	Min (m)	Max (m)	Min (m)	Max (m)	Min (m)	Max (m)	Min (m)	Max (m)	Min (m)	Max (m)	Min (m)	Max (m)
50	0.67	1.08	NA	0.70	0.81	0.81	1.02	1.02	1.31	1.31	1.64	1.64	3.14	3.12	5.92
60	0.81	1.29	NA	0.84	0.97	0.97	1.23	1.23	1.58	1.58	1.96	1.96	3.77	3.75	7.11
70	0.94	1.51	NA	0.98	1.13	1.13	1.43	1.43	1.84	1.84	2.29	2.29	4.40	4.37	8.29
80	1.08	1.72	NA	1.12	1.29	1.29	1.64	1.64	2.10	2.10	2.62	2.62	5.03	5.00	9.48
90	1.21	1.94	NA	1.26	1.45	1.45	1.84	1.84	2.36	2.36	2.95	2.95	5.66	5.62	10.66
100	1.35	2.15	NA	1.40	1.62	1.62	2.05	2.05	2.63	2.63	3.27	3.27	6.29	6.25	11.85
110	1.48	2.37	NA	1.54	1.78	1.78	2.25	2.25	2.89	2.89	3.60	3.60	6.92	6.87	13.03
120	1.62	2.58	0.93	1.68	1.94	1.94	2.46	2.46	3.15	3.15	3.93	3.93	7.55	7.50	14.22
130	1.75	2.80	1.01	1.82	2.10	2.10	2.66	2.66	3.42	3.42	4.26	4.26	8.18	8.12	15.40
140	1.88	3.02	1.09	1.96	2.26	2.26	2.86	2.86	3.68	3.68	4.58	4.58	8.81	8.74	16.59
150	2.02	3.23	1.17	2.10	2.42	2.42	3.07	3.07	3.94	3.94	4.91	4.91	9.43	9.37	17.77
160	2.15	3.45	1.24	2.24	2.58	2.58	3.27	3.27	4.20	4.20	5.24	5.24	10.06	9.99	18.95
170	2.29	3.66	1.32	2.38	2.75	2.75	3.48	3.48	4.47	4.47	5.57	5.57	10.69	10.62	20.14
180	2.42	3.88	1.40	2.52	2.91	2.91	3.68	3.68	4.73	4.73	5.89	5.89	11.32	11.24	21.32
190	2.56	4.09	1.48	2.66	3.07	3.07	3.89	3.89	4.99	4.99	6.22	6.22	11.95	11.87	22.51
200	2.69	4.31	1.56	2.80	3.23	3.23	4.09	4.09	5.26	5.26	6.55	6.55	12.58	12.49	23.69
250	3.37	5.38	1.94	3.50	4.04	4.04	5.12	5.12	6.57	6.57	8.18	8.18	15.72	15.62	29.62
300	4.04	6.46	2.33	4.20	4.85	4.85	6.14	6.14	7.88	7.88	9.82	9.82	18.87	18.74	35.54
350	4.71	7.53	2.72	4.89	5.65	5.65	7.15	7.15	9.19	9.19	11.45	11.45	21.99	21.84	41.42
400	5.38	8.62	3.11	5.60	6.46	6.46	8.18	8.18	10.51	10.51	13.10	13.10	25.16	24.99	47.39
450	6.06	9.69	NA	6.30	7.27	7.27	9.21	9.21	11.82	11.82	14.73	14.73	28.30	28.11	53.31
500	6.73	10.77	NA	7.00	8.08	8.08	10.23	10.23	13.14	13.14	16.37	16.37	31.45	31.23	59.23
550	7.40	11.85	NA	7.70	8.88	8.88	11.25	11.25	14.45	14.45	18.01	18.01	34.59	34.35	65.16
600	8.08	12.92	NA	8.40	9.69	9.69	12.28	12.28	15.77	15.77	19.64	19.64	37.74	37.48	71.08
650	8.75	14.00	NA	9.10	10.50	10.50	13.30	13.30	17.08	17.08	21.28	21.28	40.88	40.60	77.00
700	9.42	15.08	NA	9.80	11.31	11.31	14.32	14.32	18.39	18.39	22.92	22.92	44.03	43.72	82.93
750	10.10	16.15	NA	10.50	12.12	12.12	15.35	15.35	19.71	19.71	24.55	24.55	47.17	46.85	88.85
800	10.77	17.23	NA	11.20	12.92	12.92	16.37	16.37	21.02	21.02	26.19	26.19	50.32	49.97	94.77
850	11.44	18.31	NA	11.90	13.73	13.73	17.39	17.39	22.34	22.34	27.83	27.83	53.46	53.09	100.70
900	12.12	19.39	NA	12.60	14.54	14.54	18.42	18.42	23.65	23.65	29.47	29.47	56.60	56.22	106.62
950	12.79	20.46	NA	13.30	15.35	15.35	19.44	19.44	24.96	24.96	31.10	31.10	59.75	59.34	112.54
1000	13.46	21.54	NA	14.00	16.15	16.15	20.46	20.46	26.28	26.28	32.74	32.74	62.89	62.46	118.47

Note: If the screen is larger than 300 inches, then fine text and images may not display clearly.

ADDITIONAL INFORMATION

Projection distance

The distance between the projector and its screen determines the approximate size of the image. The farther the projector is from the screen, the larger the projected image will be. The image size also varies depending on the aspect ratio, zoom and other settings.

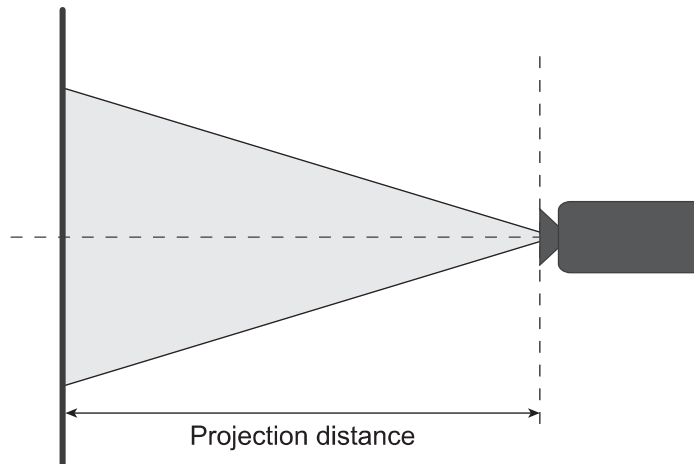

Powered lens shift range

Projection Lens	Optical Lens Shift Range		Mechanical Shift Range	
	ΔH_o	ΔV_o	Max. of ΔH_m	Max. of ΔV_m
BX-CTA15	30%	100%	40%	120%

V: Height of the projected image

H: Width of the projected image

□ Projected image

⚠ When the lens is shifted beyond the described range of operation, screen edges may become darker or images may become out of focus.

Note: The calculation is based on 1/2 image width and 1/2 image height.

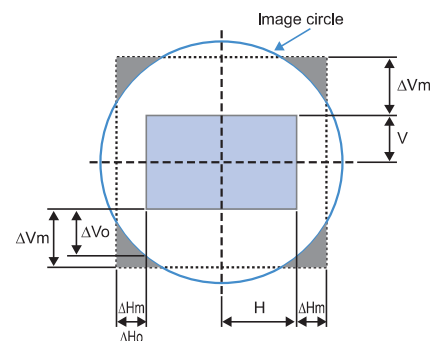

Projection Lens	Optical Lens Shift Range		Mechanical Shift Range	
	ΔH_o	ΔV_o	Max. of ΔH_m	Max. of ΔV_m
BX-CAA06, BX-CTA17	30%	100%	40%	120%

V: Height of the projected image

H: Width of the projected image

□ Projected image

⚠ When the lens is shifted beyond the described range of operation, screen edges may become darker or images may become out of focus.

Note: The calculation is based on 1/2 image width and 1/2 image height.

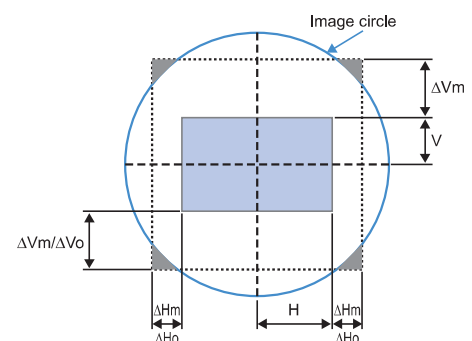

ADDITIONAL INFORMATION

Projection Lens	Optical Lens Shift Range		Mechanical Shift Range	
	ΔH_o	ΔV_o	Max. of ΔH_m	Max. of ΔV_m
BX-CAA01, BX-CAA03, BX-CTA13	30%	100%	40%	120%

V: Height of the projected image

H: Width of the projected image

□ Projected image

⚠ When the lens is shifted beyond the described range of operation, screen edges may become darker or images may become out of focus.

Note: The calculation is based on 1/2 image width and 1/2 image height.

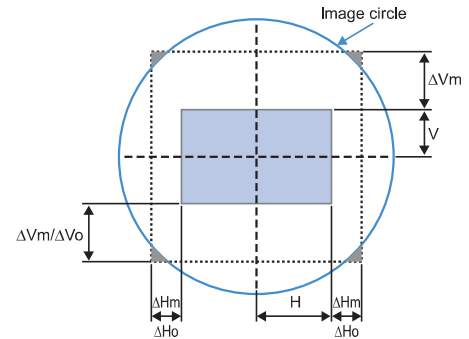

Projection Lens	Optical Lens Shift Range		Mechanical Shift Range	
	ΔH_o	ΔV_o	Max. of ΔH_m	Max. of ΔV_m
BX-CTA16	NA	NA	20%	NA/-20%

V: Height of the projected image

H: Width of the projected image

□ Projected image

⚠ When the lens is shifted beyond the described range of operation, screen edges may become darker or images may become out of focus.

Note: The calculation is based on 1/2 image width and 1/2 image height.

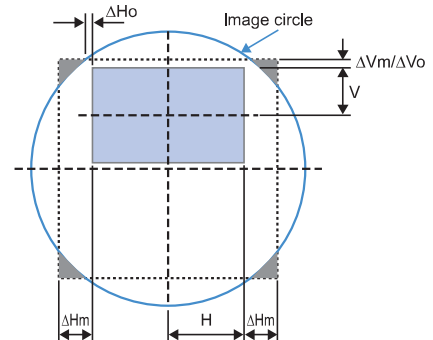

ADDITIONAL INFORMATION

Ceiling mount installation

Projector dimensions

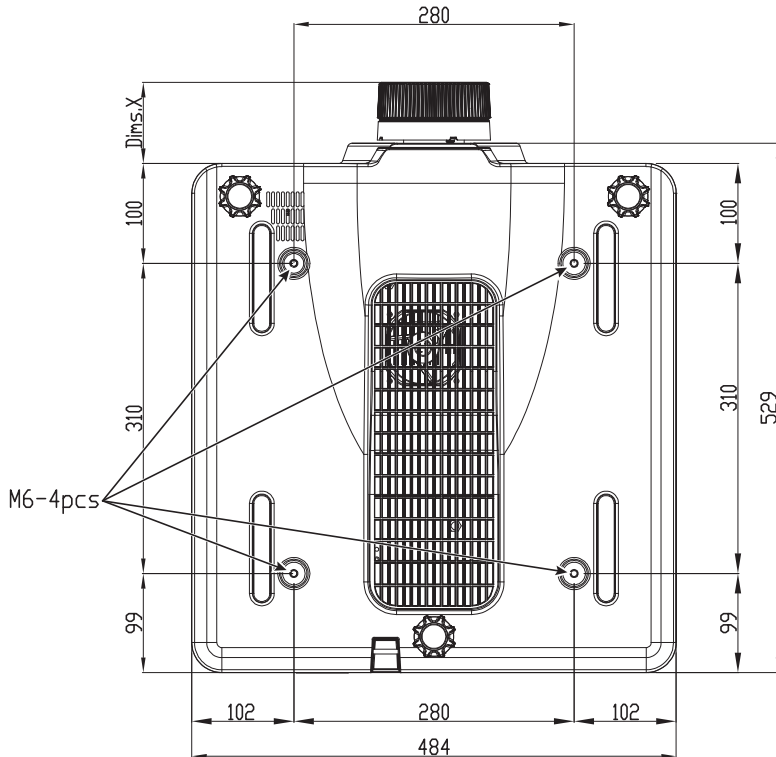

All dimensions given in mm

1 Mounting holes for ceiling mount

X Distance between projector and end of lens

Lens type	Distance X (in mm)
BX-CAA01	61.6
BX-CAA03	81.4
BX-CAA06	80.9
BX-CTA13	109.1
BX-CTA15	68.9
BX-CTA16	315.5
BX-CTA17	103

Ceiling mount information

If you wish to use a third party ceiling mount kit, please ensure the screws used to attach a mount to the projector meet the following specifications:

- Screw type: M6 x 4
- Maximum hole depth: 10 mm

Note: Damage resulting from incorrect installation will void the warranty.

ADDITIONAL INFORMATION

IR remote codes

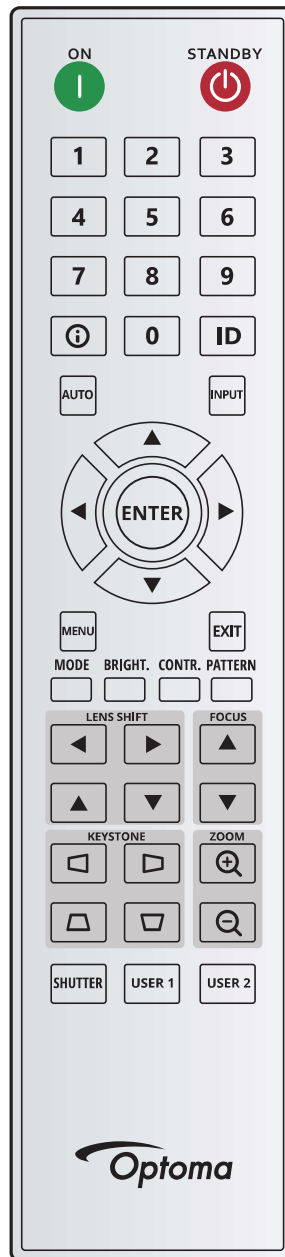

Key Legend	Key Position	Repeat Format	Address		Data		Description
			Byte 1	Byte 2	Byte 3	Byte 4	
ON (🟢)	1	F1	32	CD	2	FD	Press to turn on the projector.
OFF (🔴)	2	F1	32	CD	2E	D1	Press to turn off the projector.
1	3	F1	32	CD	72	8D	Use as numeric keypad number "1".
2	4	F1	32	CD	73	8C	Use as numeric keypad number "2".
3	5	F1	32	CD	74	8B	Use as numeric keypad number "3".
4	6	F1	32	CD	75	8A	Use as numeric keypad number "4".
5	7	F1	32	CD	77	88	Use as numeric keypad number "5".
6	8	F1	32	CD	78	87	Use as numeric keypad number "6".

ADDITIONAL INFORMATION











Key Legend	Key Position	Repeat Format	Address		Data		Description
			Byte 1	Byte 2	Byte 3	Byte 4	
7	9	F1	32	CD	79	86	Use as numeric keypad number “7”.
8	10	F1	32	CD	80	7F	Use as numeric keypad number “8”.
9	11	F1	32	CD	81	7E	Use as numeric keypad number “9”.
Info (i)	12	F1	32	CD	82	7D	Press to display source image information.
0	13	F1	32	CD	25	DA	Use as numeric keypad number “0”.
ID	14	F1	32	CD	A7	58	Press to set remote ID. Please refer to “Remote control ID setup” on page 27.
Auto	15	F1	32	CD	4	FB	Press to automatically synchronize the projector to the input source.
Input	16	F1	32	CD	18	E7	Press to select an input signal.
UP (▲)	17	F1	32	CD	0F	F0	Press to select items or make adjustments to our selection.
LEFT (◀)	18	F1	32	CD	11	EE	Press to select items or make adjustments to our selection.
Enter	19	F1	32	CD	14	EB	Press to confirm your item selection.
RIGHT (▶)	20	F1	32	CD	10	EF	Press to select items or make adjustments to our selection.
DOWN (▼)	21	F1	32	CD	12	ED	Press to select items or make adjustments to our selection.
Menu	22	F1	32	CD	0E	F1	Press to display the on-screen display menus for projector.
Exit	23	F1	32	CD	2A	D5	Press to return to previous level or exit menus if at top level.
Mode	24	F1	32	CD	5	FA	Press to select the preset display mode.
Bright.	25	F1	32	CD	28	D7	Press to adjust amount of light in the image.
Contr.	26	F1	32	CD	29	D6	Press to adjust difference between dark and light.
Pattern	27	F1	32	CD	58	A7	Press to display a test pattern.
Lens Shift ◀	28	F1	32	CD	41	BE	Press to adjust the position of the image horizontally.
Lens Shift ▶	29	F1	32	CD	42	BD	
Focus ▲	30	F1	32	CD	86	79	Press to adjust focus to improve image clarity as desired.
Lens Shift ▲	31	F1	32	CD	34	CB	Press to adjust the position of the image vertically.
Lens Shift ▼	32	F1	32	CD	32	CD	Press to adjust the position of the image vertically.
Focus ▼	33	F1	32	CD	26	D9	Press to adjust focus to improve image clarity as desired.
Keystone ◻	34	F1	32	CD	87	78	Press to adjust the horizontal keystone.
Keystone ▤	35	F1	32	CD	51	AE	Press to adjust the horizontal keystone.
Zoom ⊕	36	F1	32	CD	52	AD	Press to adjust zoom to achieve a desired image size.
Keystone ▤	37	F1	32	CD	53	AC	Press to adjust the vertical keystone.
Keystone ◻	38	F1	32	CD	54	AB	Press to adjust the vertical keystone.
Zoom ⊖	39	F1	32	CD	55	AA	Press to adjust zoom to achieve a desired image size.
Shutter (AV Mute)	40	F1	32	CD	56	A9	Press to hide/unhide the screen picture.
User 1	41	F1	32	CD	57	A8	Press to assign user functions. Please refer to “Remote Setup” on page 70.
User 2	42	F1	32	CD	27	D8	Press to assign user functions. Please refer to “Remote Setup” on page 70.

ADDITIONAL INFORMATION

Troubleshooting

If you experience a problem with your projector, please refer to the following information. If a problem persists, please contact your local reseller or service center.

Image problems

-  *No image appears on-screen*
 - Ensure all the cables and power connections are correctly and securely connected as described in the *Setup and Installation* section.
 - Ensure the pins of connectors are not crooked or broken.
 - Ensure that the Shutter (AV Mute) feature is not turned on.
-  *Image is out of focus*
 - Press the **Focus ▲** or **Focus ▼** button on the remote control or projector keypad to adjust the focus until the image is sharp and legible.
 - Make sure the projection screen is between the required distance from the projector. (Please refer to *Image size and projection distance* page 91).
-  *The image is stretched when displaying 16:10 DVD title*
 - When you play anamorphic DVD or 16:10 DVD, the projector will show the best image in 16:10 format on projector side.
 - If you play 4:3 format DVD title, please change the format as 4:3 in projector OSD.
 - Please setup the display format as 16:10 (wide) aspect ratio type on your DVD player.
-  *Image is too small or too large*
 - Press the **Zoom ⊕** or **Zoom ⊖** button on the remote control or projector keypad to adjust the projected image size.
 - Move the projector closer to or further from the screen.
 - From the OSD menu, select **Display > Aspect Ratio** to change the aspect ratio.
-  *Image has slanted sides:*
 - If possible, reposition the projector so that it is centered on the screen and below the bottom of the screen.
 - Press the **Keystone**     buttons on the remote control to adjust the screen shape.
-  *Image is reversed*
 - From the OSD menu, select **Device Setup > Projection > Rear** to reverse the image so you can project from behind a translucent screen.

Other problems

-  *The projector stops responding to all controls*
 - If possible, turn off the projector, then unplug the power cord and wait at least 20 seconds before reconnecting power.

Remote control problems

-  *If the remote control does not work*
 - Check that the operating angle of the remote control is pointed within $\pm 30^\circ$ horizontally or $\pm 20^\circ$ vertically to the IR receivers on the projector.
 - Make sure there are not any obstructions between the remote control and the projector. Move to within 10 m (32.8 ft) of the projector.
 - Make sure batteries are inserted correctly.
 - Replace batteries if they are exhausted.

ADDITIONAL INFORMATION

LED status indicators

Overview

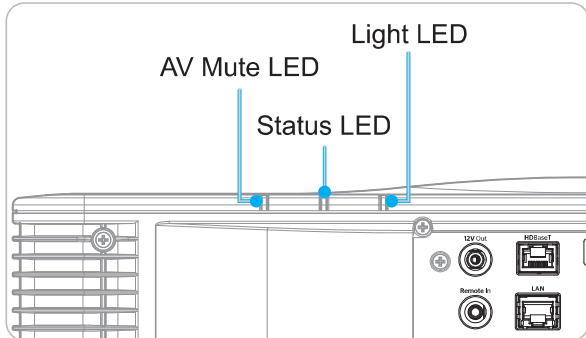

Explanation

Message	Light LED			Status LED			AV Mute LED	
	Green	Orange	Red	Green	Orange	Red	Green	Orange
Standby State								
Power on (Warm up)					Flashing			
Power on & Laser diode on	Steady			Steady			Steady	
Power off (Cooling down)					Flashing			
AV mute is off (Image is displayed)	Steady			Steady			Steady	
AV mute is on (Image is black)	Steady			Steady				Steady
Projector communication	Steady			Flashing			Steady	
Firmware upgrade				Flashing	Flashing			
Burn-in	Steady			Steady			Steady	
Factory reset			Steady	Steady				
Over temperature error						Steady		
Fan failure error						Flashing		
Color wheel failure error						Flashing		

Note: Keypad LED (Power Key) will be in steady red for standby mode.

ADDITIONAL INFORMATION

Specifications

Optical	Description
Resolution	WUXGA (1920 x 1200)
Lens	Power Zoom/Focus and full lens shift
Projection distance	Please refer to “Throw Distance” spec. in “Image size and projection distance” on page 91.

Electrical	Description
Inputs	2 x HDMI In (version 2.0) (with locking screw) 1 x DVI-D 1 x HDBaseT 1 x 3G-SDI In 1 x 3D SYNC In
Outputs	1 x HDMI Out (version 2.0) (with locking screw) 1 x 3D SYNC Out
Control port	1 x RS232 (D-sub 9 pin) (PC Control) 1 x Wired in (3.5mm phone jack) (Remote In) 1 x 12V Trigger (3.5mm phone jack / Black) 1 x USB type A (5V/0.5A) 1 x RJ-45 (LAN) 2 x IR Receiver (Front / Top)
Power requirement	100-240V~ 50/60 Hz, 8.5A

Mechanical	Description
Installation orientation	360° rotation, no restrictions
Dimensions	484 (W) x 529 (D) x 207.8 (H) mm (w/o lens, with feet) 484 (W) x 529 (D) x 195 (H) mm (w/o lens, w/o feet)
Environmental conditions	Operating: 0°C ~ 40°C*(32~104°F); 10~85%RH, non-condensing Storage: -10°C ~ 60°C(14~140°F); 5~90%RH, non-condensing Note: <i>If High Altitude >5000 ft, the system will be operated at the range of 0~35°C to ensure the normal operation of the projector. The light power will be reduced due to the high ambient temperature (≥35°C).</i>



Note: All specifications are subject to change without notice.

Optoma global offices

For service or support, please contact your local office.



USA

Optoma Technology, Inc.
47697 Westinghouse Drive.
Fremont, Ca 94539

 888-289-6786
 510-897-8601
 services@optoma.com



Canada

Optoma Technology, Inc.
47697 Westinghouse Drive.
Fremont, Ca 94539

 888-289-6786
 510-897-8601
 services@optoma.com



Latin America

Optoma Technology, Inc.
47697 Westinghouse Drive.
Fremont, Ca 94539

 888-289-6786
 510-897-8601
 services@optoma.com



Europe

Unit 1, Network 41, Bourne End Mills
Hemel Hempstead, Herts,
HP1 2UJ, United Kingdom
www.optoma.eu
Service Tel : +44 (0)1923 691865

 +44 (0) 1923 691 800
 +44 (0) 1923 691 888
 service@tsc-europe.com



Benelux BV

Randstad 22-123
1316 BW Almere
The Netherlands
www.optoma.nl

 +31 (0) 36 820 0252
 +31 (0) 36 548 9052



France

Bâtiment E
81-83 avenue Edouard Vaillant
92100 Boulogne Billancourt, France

 +33 1 41 46 12 20
 +33 1 41 46 94 35
 savoptoma@optoma.fr



Spain

C/ José Hierro,36 Of. 1C
28522 Rivas VaciaMadrid,
Spain

 +34 91 499 06 06
 +34 91 670 08 32



Deutschland

Am Nordpark 3
41069 Mönchengladbach
Germany

 +49 (0) 2161 68643 0
 +49 (0) 2161 68643 99
 info@optoma.de

Scandinavia

Lerpeveien 25
3040 Drammen
Norway

 +47 32 98 89 90
 +47 32 98 89 99
 info@optoma.no

PO.BOX 9515
3038 Drammen
Norway

China

Room 2001, 20F, Building 4,
No.1398 Kaixuan Road,
Changning District
Shanghai, 200052, China
www.optoma.com.cn

 +86-21-62947376
 +86-21-62947375
 servicecn@optoma.com.cn

Japan

<https://www.optoma.com/jp/>

Korea

<https://www.optoma.com/kr/>

Taiwan

<https://www.optoma.com/tw/>

Australia

<https://www.optoma.com/au/>

