

DLP® Projector

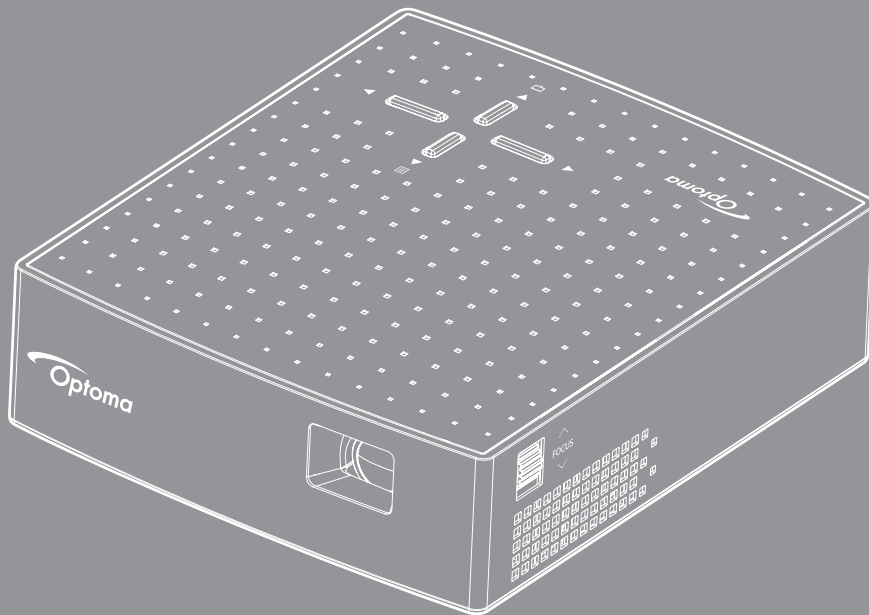



TABLE OF CONTENTS

SAFETY	3
<i>Important Safety Instruction.....</i>	<i>3</i>
<i>Copyright.....</i>	<i>4</i>
<i>Disclaimer.....</i>	<i>4</i>
<i>Trademark Recognition</i>	<i>4</i>
<i>FCC.....</i>	<i>5</i>
<i>Declaration of Conformity for EU countries.....</i>	<i>5</i>
<i>WEEE.....</i>	<i>5</i>
INTRODUCTION.....	6
<i>Package Overview.....</i>	<i>6</i>
<i>Standard accessories.....</i>	<i>6</i>
<i>Optional accessories.....</i>	<i>6</i>
<i>Product Overview</i>	<i>7</i>
<i>Connections.....</i>	<i>8</i>
<i>Keypad</i>	<i>8</i>
SETUP AND INSTALLATION.....	9
<i>Connecting sources to the projector.....</i>	<i>9</i>
<i>Focus.....</i>	<i>10</i>
USING THE PROJECTOR.....	11
<i>Powering on / off the projector.....</i>	<i>11</i>
<i>Menu navigation and features.....</i>	<i>12</i>
<i>OSD Menu tree.....</i>	<i>13</i>
ADDITIONAL INFORMATION	17
<i>Compatible resolutions.....</i>	<i>17</i>
<i>Image size and projection distance</i>	<i>18</i>
<i>Troubleshooting.....</i>	<i>19</i>
<i>LED lightning messages.....</i>	<i>20</i>
<i>Specifications</i>	<i>21</i>
<i>Optoma global offices.....</i>	<i>22</i>

SAFETY

	The lightning flash with arrow head within an equilateral triangle is intended to alert the user to the presence of uninsulated "dangerous voltage" within the product's enclosure that may be of sufficient magnitude to constitute a risk of electric shock to persons.
	The exclamation point within an equilateral triangle is intended to alert the user to the presence of important operating and maintenance (servicing) instructions in the literature accompanying the appliance.

Please follow all warnings, precautions and maintenance as recommended in this user's guide.

Important Safety Instruction

- RG1 IEC 62471-5:2015.
- Do not block any ventilation openings. To ensure reliable operation of the projector and to protect from over heating, it is recommended to install the projector in a location that does not block ventilation. As an example, do not place the projector on a crowded coffee table, sofa, bed, etc. Do not put the projector in an enclosure such as a book case or a cabinet that restricts air flow.
- To reduce the risk of fire and/or electric shock, do not expose the projector to rain or moisture. Do not install near heat sources such as radiators, heaters, stoves or any other apparatus such as amplifiers that emits heat.
- Do not let objects or liquids enter the projector. They may touch dangerous voltage points and short out parts that could result in fire or electric shock.
- Do not use under the following conditions:
 - In extremely hot, cold or humid environments.
 - (i) Ensure that the ambient room temperature is within 5°C ~ 40°C
 - (ii) Relative humidity is 10% ~ 80%
 - In areas susceptible to excessive dust and dirt.
 - Near any appliance generating a strong magnetic field.
 - In direct sunlight.
- Do not use the unit if it has been physically damaged or abused. Physical damage/abuse would be (but not limited to):
 - Unit has been dropped.
 - Power supply cord or plug has been damaged.
 - Liquid has been spilled on to the projector.
 - Projector has been exposed to rain or moisture.
 - Something has fallen in the projector or something is loose inside.
- Do not place the projector on an unstable surface. The projector may fall over resulting in injury or the projector may become damaged.
- Do not block the light coming out of the projector lens when in operation. The light will heat the object and could melt, cause burns or start a fire.
- Please do not open or disassemble the projector as this may cause electric shock.
- Do not attempt to service the unit yourself. Opening or removing covers may expose you to dangerous voltages or other hazards. Please call Optoma before you send the unit for repair.
- See projector enclosure for safety related markings.
- The unit should only be repaired by appropriate service personnel.
- Only use attachments/accessories specified by the manufacturer.

- Do not look straight into the projector lens during operation. The bright light may harm your eyes.
- When switching the projector off, please ensure the cooling cycle has been completed before disconnecting power. Allow 90 seconds for the projector to cool down.
- Turn off and unplug the power plug from the AC outlet before cleaning the product.
- Use a soft dry cloth with mild detergent to clean the display housing. Do not use abrasive cleaners, waxes or solvents to clean the unit.
- Disconnect the power plug from AC outlet if the product is not being used for a long period of time.
- Do not setup the projector in places where it might be subjected to vibration or shock.
- Do not touch the lens with bare hands.
- Do not use or store the projector in places where smoke from oil or cigarettes may be present, as it can adversely affect the quality of the projector performance.
- Please follow the correct projector orientation installation as non standard installation may affect the projector performance.
- Use a power strip and or surge protector. As power outages and brown-outs can KILL devices.

Copyright

This publication, including all photographs, illustrations and software, is protected under international copyright laws, with all rights reserved. Neither this manual, nor any of the material contained herein, may be reproduced without written consent of the author.

© Copyright 2018

Disclaimer

The information in this document is subject to change without notice. The manufacturer makes no representations or warranties with respect to the contents hereof and specifically disclaims any implied warranties of merchantability or fitness for any particular purpose. The manufacturer reserves the right to revise this publication and to make changes from time to time in the content hereof without obligation of the manufacturer to notify any person of such revision or changes.

Trademark Recognition

Kensington is a U.S. registered trademark of ACCO Brand Corporation with issued registrations and pending applications in other countries throughout the world.

HDMI, the HDMI Logo, and High-Definition Multimedia Interface are trademarks or registered trademarks of HDMI Licensing LLC in the United States and other countries.

DLP®, DLP Link and the DLP logo are registered trademarks of Texas Instruments and BrilliantColor™ is a trademark of Texas Instruments.

Manufactured under license from Dolby Laboratories. Dolby and the double-D symbol are trademarks of Dolby Laboratories.

All other product names used in this manual are the properties of their respective owners and are Acknowledged.

FCC

This device has been tested and found to comply with the limits for a Class B digital device pursuant to Part 15 of the FCC rules. These limits are designed to provide reasonable protection against harmful interference in a residential installation. This device generates, uses and can radiate radio frequency energy and, if not installed and used in accordance with the instructions, may cause harmful interference to radio communications.

However, there is no guarantee that interference will not occur in a particular installation. If this device does cause harmful interference to radio or television reception, which can be determined by turning the device off and on is encouraged to try to correct the interference by one or more of the following measures:

- Reorient or relocate the receiving antenna.
- Increase the separation between the device and receiver.
- Connect the device into an outlet on a circuit different from that to which the receiver is connected.
- Consult the dealer or an experienced radio/television technician for help.

Notice: Shielded cables

All connections to other computing devices must be made using shielded cables to maintain compliance with FCC regulations.

Caution

Changes or modifications not expressly approved by the manufacturer could void the user's authority, which is granted by the Federal Communications Commission, to operate this projector.

Operation Conditions

This device complies with Part 15 of the FCC Rules. Operation is subject to the following two conditions:

1. This device may not cause harmful interference and
2. This device must accept any interference received, including interference that may cause undesired operation.

Notice: Canadian users

This Class B digital apparatus complies with Canadian ICES-003.

Remarque à l'intention des utilisateurs canadiens

Cet appareil numérique de la classe B est conforme à la norme NMB-003 du Canada.

Declaration of Conformity for EU countries

- EMC Directive 2014/30/EC (including amendments)
- Low Voltage Directive 2014/35/EC
- R & TTE Directive 1999/5/EC (if product has RF function)

WEEE



Disposal instructions

Do not throw this electronic device into the trash when discarding. To minimize pollution and ensure utmost protection of the global environment, please recycle it.

INTRODUCTION

Package Overview

Carefully unpack and verify that you have the items listed below under standard accessories. Some of the items under optional accessories may not be available depending on the model, specification and your region of purchase. Please check with your place of purchase. Some accessories may vary from region to region.

The warranty card is only supplied in some specific regions. Please consult your dealer for detailed information.

Standard accessories

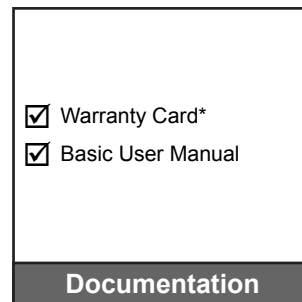
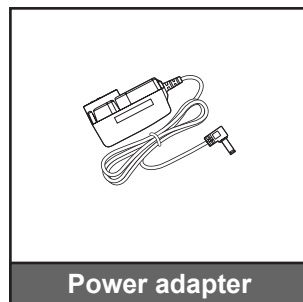
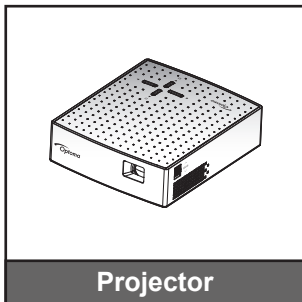

Note: *For European warranty information, please visit www.optoma.com

Optional accessories

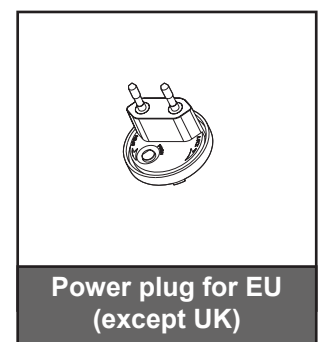
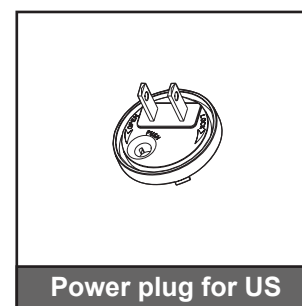
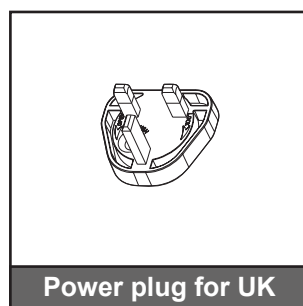
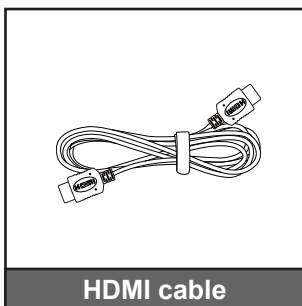

Note: Optional accessories vary depending on model, specification and region.

INTRODUCTION

Product Overview

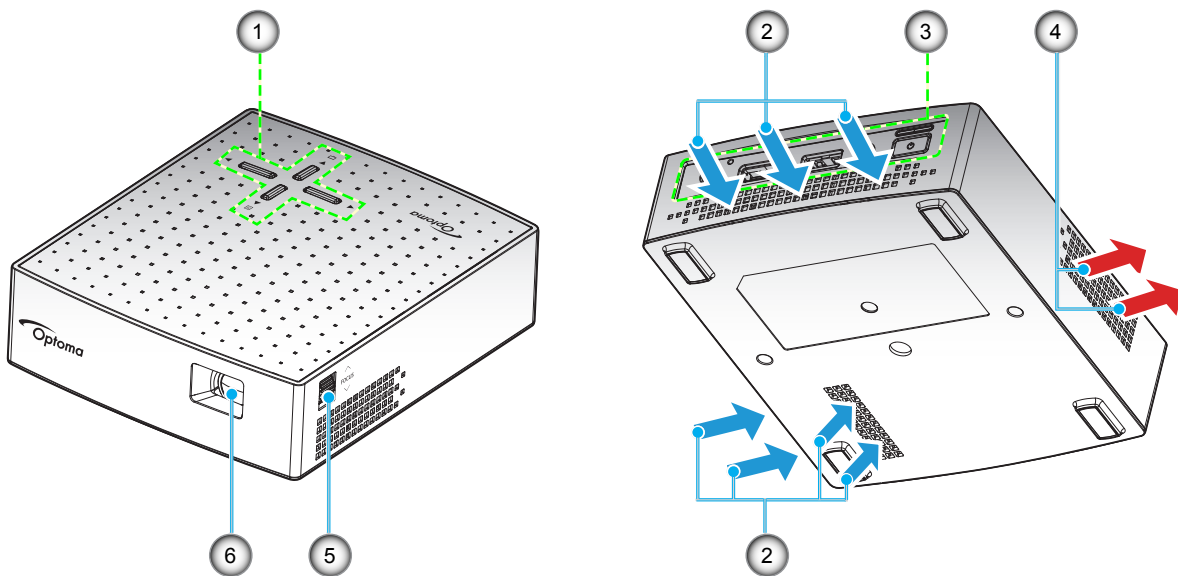

Note:

- Do not block projector intake and exhaust vents.
- When operating the projector in an enclosed space, allow at least 20cm clearance around the intake and exhaust vents.

No	Item	No	Item
1.	Keypad	4.	Ventilation (outlet)
2.	Ventilation (inlet)	5.	Focus Wheel
3.	Input / Output	6.	Lens

INTRODUCTION

Connections

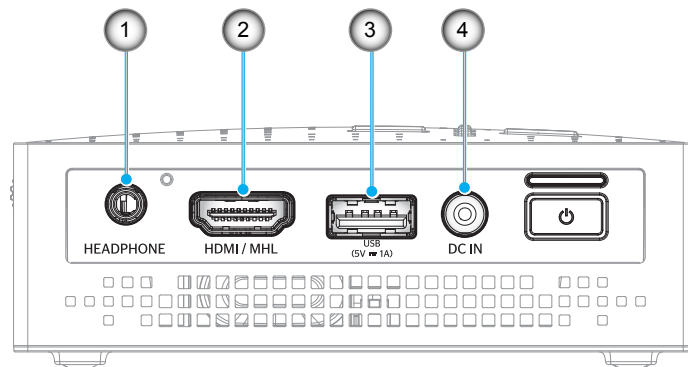

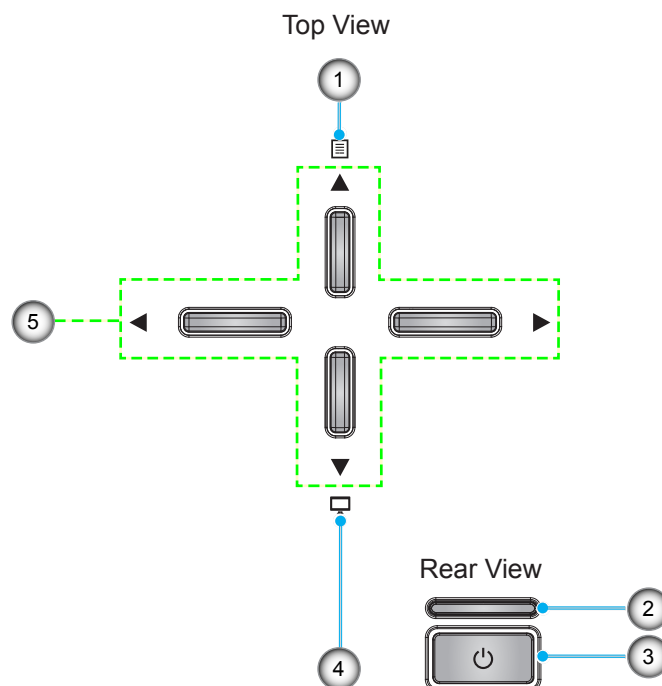

No	Item	No	Item
1.	Headphone Connector	3.	USB Connector (5V --- 1A)
2.	HDMI / MHL Connector	4.	DC IN Connector

Keypad



No	Item	No	Item
1.	Menu	4.	Mode Selection* ¹
2.	LED Indicator	5.	Four Directional Select Keys* ²
3.	Power Button		

Note:

- *¹Press the  key in a sequence to toggle through the display modes while the OSD menu is on.
- *²Press the  key to decrease or increase the internal speaker/headphone volume respectively while the OSD menu is off.

SETUP AND INSTALLATION

Connecting sources to the projector

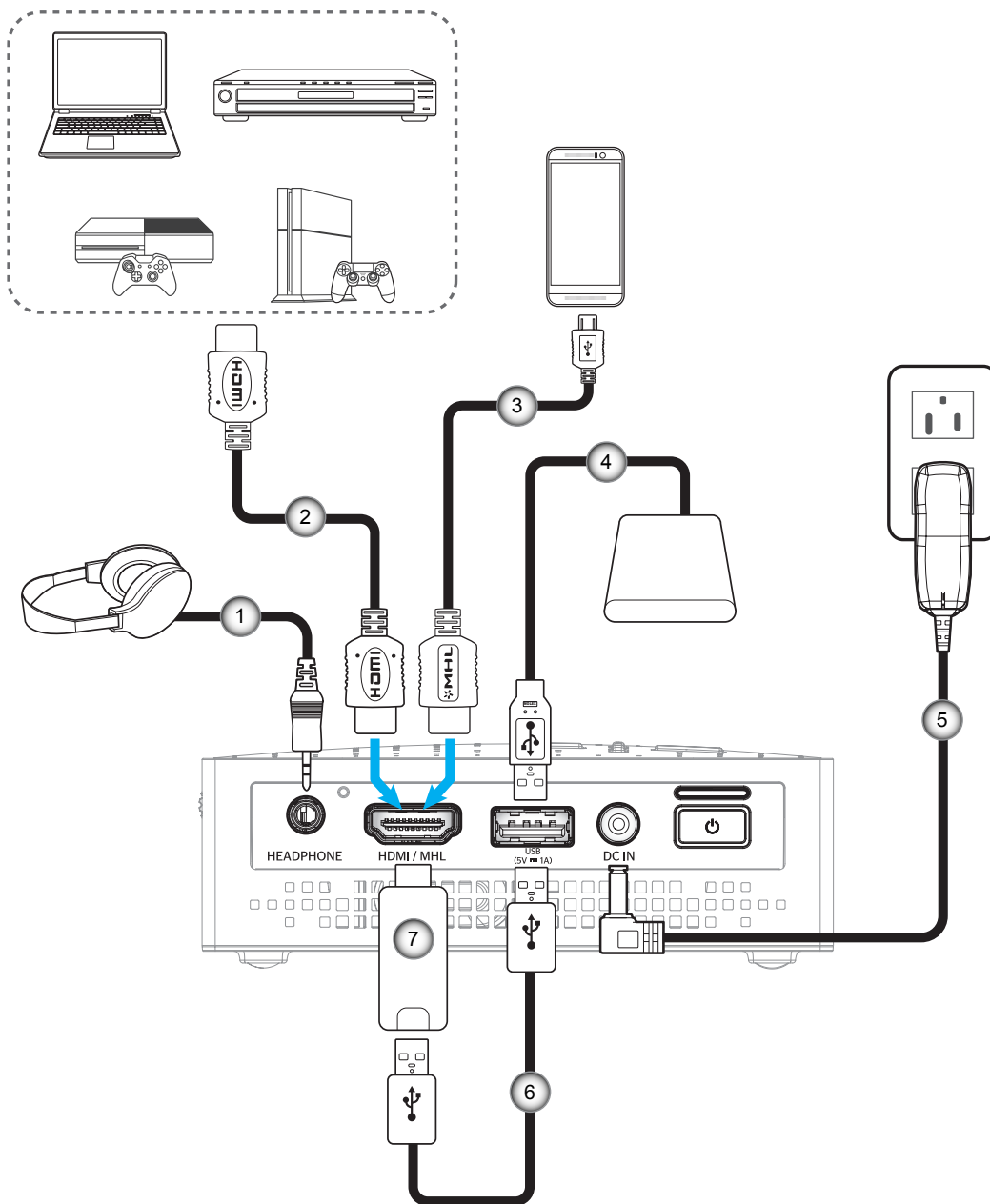

No	Item	No	Item
1.	Audio Out Cable	5.	Power Adapter
2.	HDMI Cable	6.	USB Power Supply (5V---1A)
3.	MHL Cable	7.	HDMI Dongle
4.	USB Cable		

Note: If you charge the battery using a USB cable and display an HDMI source with an audio output simultaneously, the cooling fan speed may increase.

SETUP AND INSTALLATION

Focus

To adjust the focus, turn the focus wheel clockwise or counterclockwise until the image is sharp and legible.

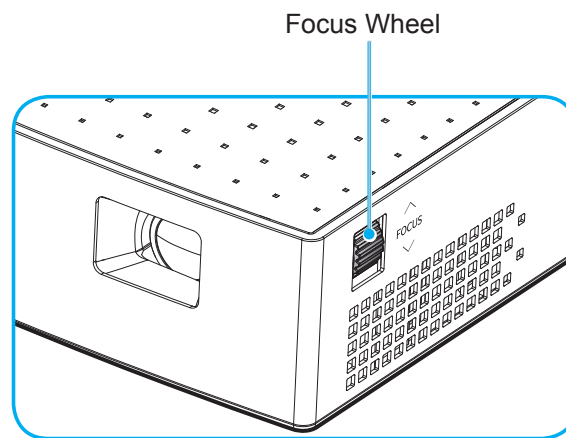

Note: The projector will focus at a distance of 0.6m to 1.9m.

USING THE PROJECTOR

Powering on / off the projector

Powering on

Note: Before powering on the projector for the first time, you need to fully charge the battery.

1. Attach the correct power plug that is supported in your region to the power adapter.
2. Connect one end of the power adapter to the DC IN connector on the projector.
3. Connect the other end of the power adapter to the electrical outlet. When connected, the LED indicator will turn red and the battery starts charging.

Wait until the LED indicator will turn blue which means the battery is fully charged. More information on LED colors, refer to page 20.

4. Connect the signal/source cable.
5. Long press (> 1s) the **Power** button  on the rear panel of the projector.

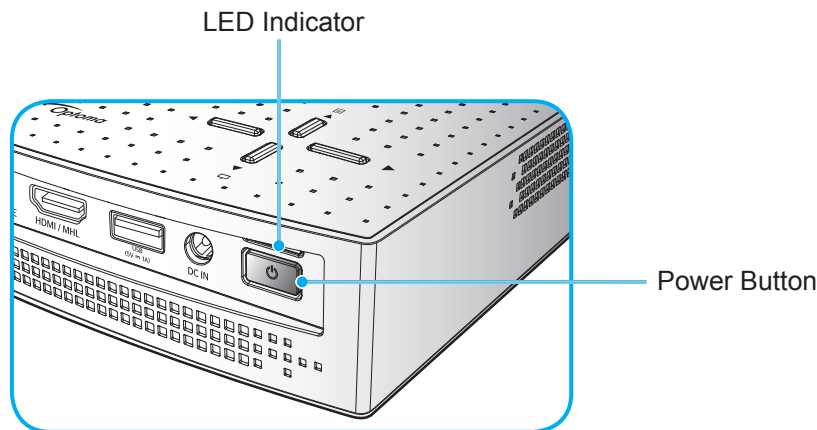

The first time the projector is powered on, you will be prompted to select a preferred OSD language. Press the   keys to select your preferred language.

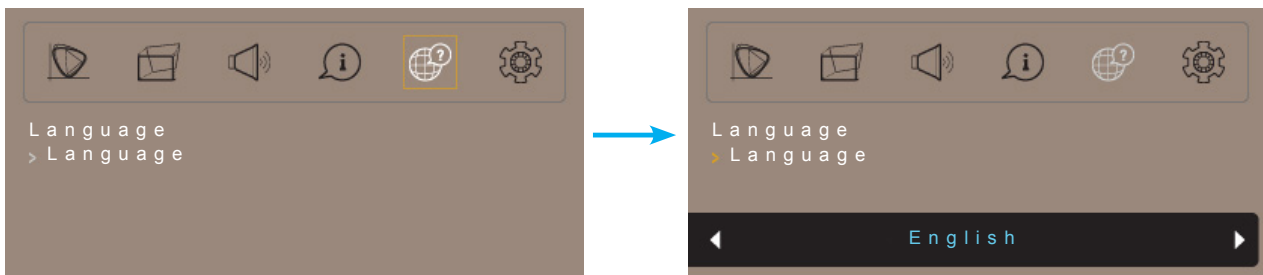

Note:

- Short press (< 1s) the **Power** button  to turn on or turn off the power bank while running on battery mode (power adapter is unplugged).
- In active mode (the projector is powered on), the power output through the MHL connector and USB connector simultaneously is not supported. The MHL connector has higher priority, meaning the power output from the USB connector will be cut off.

USING THE PROJECTOR

Powering off

1. Turn off the projector by pressing the **Power** button  on the rear panel. The following message will be displayed:

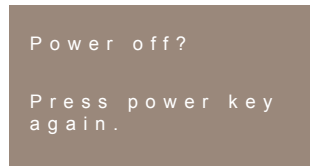









2. Press the **Power** button  again.
3. Disconnect the power adapter from the projector and the electrical outlet.

Note: It is not recommended that the projector is turned on immediately, right after a power off procedure.

Menu navigation and features

The projector has multilingual on-screen display menus that allow you to make image adjustments and change a variety of settings.

1. To open the OSD menu, press the  key on the projector keypad.
2. When the OSD is displayed, press the   keys to select any item in the Main Menu. While making a selection on a particular tab, press the   keys to select sub menu items.
3. Press the   keys to select the setting or adjust a value.
4. To exit, press the  key again. The OSD menu will close and the projector will automatically save the new settings.

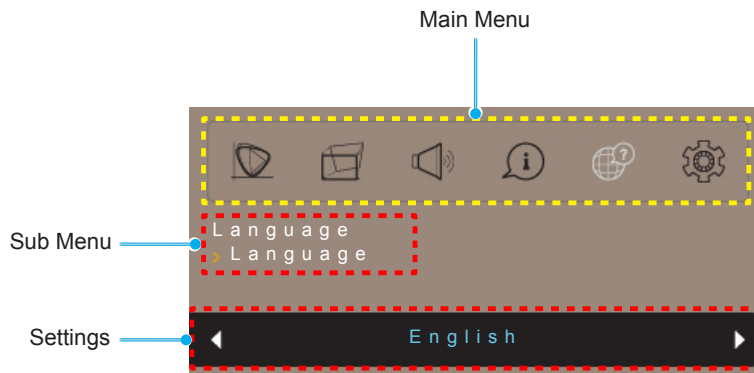

USING THE PROJECTOR

OSD Menu tree

Level 1	Level 2	Level 3	Default Value
Display	Display Mode	Bright	Standard
		Standard	
		Eco	
	Brightness	0~10	5
	Contrast	0~10	5
	Projection	Front	Front
		Rear	
		Front-Ceiling	
		Rear-Ceiling	
	Aspect Ratio	Auto	Auto
4:3			
16:9			
Keystone	Auto Keystone	On	On
		Off	
	Manual Keystone	-40~40	0
V Keystone	-40~40	0	
Volume	0~10		5
Information	Software Version		Read only
	Input Source		Read only
	Signal Type		Read only
Language	English		English
	Deutsch		
	Español		
	Français		
	Italiano		
	Português		
	Русский		
	日本語		
	中文(繁)		
	한국어		
Setting	Logo	Default	Default
		Neutral	
	Reset	No	No
		Yes	

USING THE PROJECTOR

Display menu

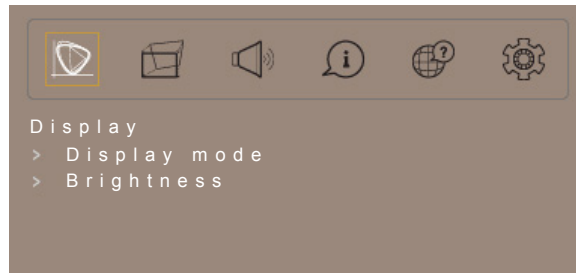

Display mode

There are many factory presets optimized for various types of images.

- **Bright:** Choose this mode for brighter and more saturated colors.
- **Standard:** Choose this mode for natural looking colors with a balance of warm and cool tones.
- **Eco:** Choose this mode to dim the projector light source which will lower power consumption and extend the light source life.

Brightness

Adjust the brightness of the image.

Contrast

Adjust the contrast of the image.

Projection

Specify the orientation to use for the image.

Aspect ratio

Select the aspect ratio of the displayed image.

- **Auto:** Automatically selects the appropriate display format.
- **4:3:** This format is for 4:3 input sources.
- **16:9:** This format is for 16:9 input sources, like HDTV and DVD enhanced for Wide screen TV.

Note: A 16:9 image is scaled down automatically to the size 1280x720.

Keystone menu

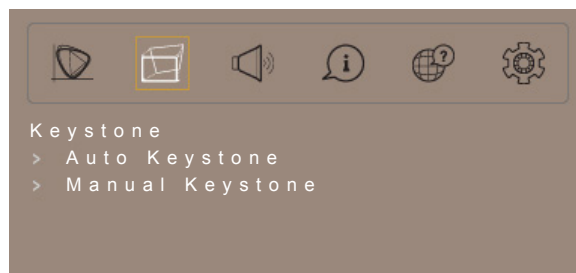

Auto Keystone

Correct keystone digitally to fit the projected image on the area on which you are projecting.

Manual Keystone

Correct keystone manually to fit the projected image on the area on which you are projecting.

USING THE PROJECTOR

V Keystone

Adjust image distortion vertically and make a squarer image. Vertical keystone is used to correct a keystone image shape in which the top and bottom are slanted to one of the sides. This is intended when for use with vertically on-axis applications.

Volume menu

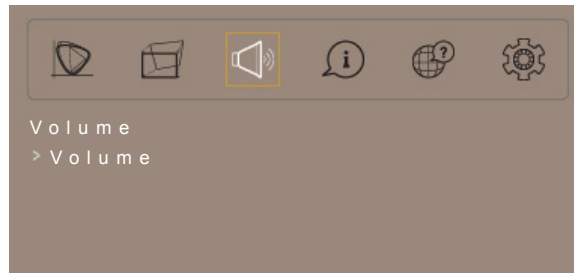

Volume

Adjust the audio volume level.

Information menu

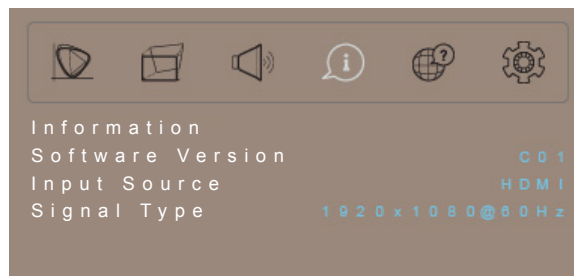

Information

Review software version, current input source, and signal type.

Language menu

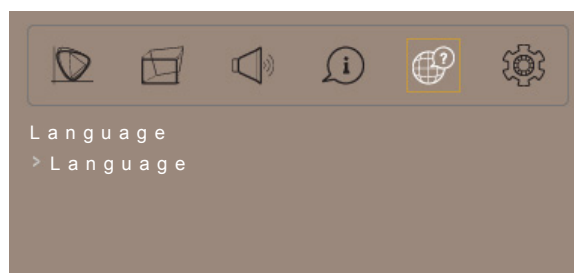

Language

Select the multilingual OSD menu between English, German, Spanish, French, Italian, Portuguese, Russian, Japanese, Traditional Chinese, and Korean.

USING THE PROJECTOR

Setting menu

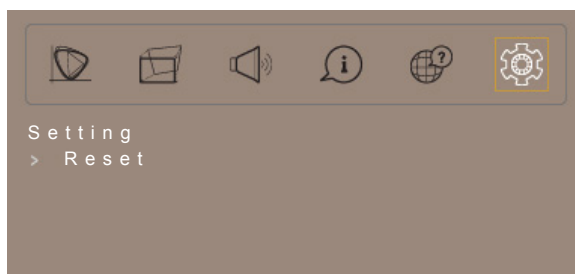

Logo

Select the logo that is displayed when no signal is available.

Reset

Return the factory default settings for all settings.

ADDITIONAL INFORMATION

Compatible resolutions

HDMI - PC Signal

Mode	Resolution	Refresh Rate (Hz)	Notes for Mac
VGA	640x480	60.0	31.5
SVGA	800x600	60.0	37.9
XGA	1024x768	60.0	48.4
	1280x1024	60.0	64.0
SXGA+	1400x1050	60.0	65.3
UXGA	1600x1200	60.0	75.0
PowerBook G4	640x480	60.0	31.4
PowerBook G4	800x600	60.0	37.9
PowerBook G4	1024x768	60.0	48.4

HDMI - Extended Wide Timing

Mode	Resolution	Refresh Rate (Hz)	Notes for Mac
WSXGA+	1280x720	60.0	44.8
	1280x800	60.0	49.6
	1280x960	60.0	59.7
	1680x1050	60.0	65.3
	1920x1080 (1080P)	60.0	67.5
	1366x768	60.0	47.7

HDMI - Video Signal

Mode	Resolution	Refresh Rate (Hz)	Notes for Mac
480i	720(1440)x480 16:9	59.94(29.97)	15.7
576i	720x576 (1440x576) 16:9	50(25)	15.6
480p	720x480 16:9	59.9	31.5
576p	720x576 16:9	50.0	31.3
720p	1280x720	60.0	45.0
720p	1280x720	50.0	37.5
1080i	1920x1080	60(30)	33.8
1080i	1920x1080	50(25)	28.1
1080p	1920x1080	23.97/24	27.0
1080p	1920x1080	60.0	67.5
1080p	1920x1080	50.0	56.3
1080p	1920x1080	25.0	28.1
1080p	1920x1080	30.0	33.8

Note: I-frame will slightly jitter due to the chip limitation.

ADDITIONAL INFORMATION

MHL Digital

Mode	Resolution	Refresh Rate (Hz)	Notes for Mac
VGA	640x480	59.94/60	31.5
480i	720x480(1440x480)	59.94/60	15.7
576i	720x576(1440x576)	50(25)	15.6
480p	720x480	59.94/60	31.5
576p	720x576	50.0	31.3
720p	1280x720	59.94/60	45.0
720p	1280x720	50.0	37.5
1080i	1920x1080	60(30)	33.8
1080i	1920x1080	50(25)	28.1
1080p	1920x1080	23.97/24	27.0
1080p	1920x1080	25.0	28.1
1080p	1920x1080	29.97/30	33.8

Image size and projection distance

Diagonal Length Size of (16:9) Screen	Screen Size W x H				Projection Distance (D)				Offset (Hd)	
	(m)		(inch)		(m)		(feet)		(m)	(inch)
	Width	Height	Width	Height	Wide	Tele	Wide	Tele		
25	0.55	0.31	21.79	12.2	0.6	0.3	1.97	0.98	0.00	0.00
30	0.66	0.37	26.15	14.7	0.7	0.3	2.30	0.98	0.00	0.00
40	0.89	0.5	34.87	19.6	1.0	0.5	3.28	1.64	0.00	0.00
60	1.33	0.75	52.30	29.4	1.5	0.7	4.92	2.30	0.00	0.00
70	1.55	0.87	61.02	34.3	1.7	0.8	5.58	2.62	0.00	0.00
80	1.77	1	69.74	39.2	1.9	0.9	6.23	2.95	0.00	0.00
90	1.99	1.12	78.46	44.1	2.2	1.0	7.22	3.28	0.00	0.00
100	2.21	1.24	87.17	49	2.4	1.2	7.87	3.94	0.00	0.00

Note: Zoom ratio: N/A

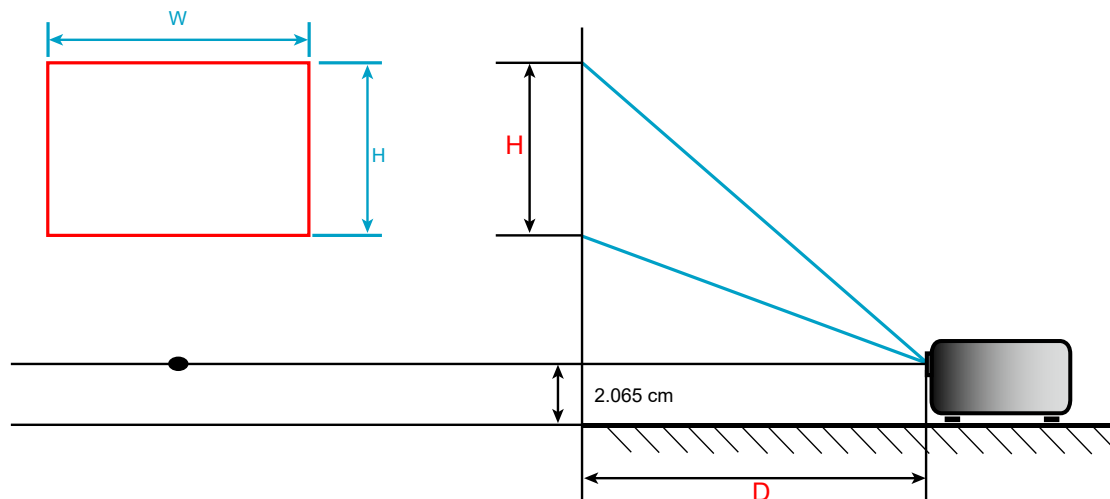

ADDITIONAL INFORMATION

Troubleshooting

If you experience a problem with your projector, please refer to the following information. If a problem persists, please contact your local reseller or service center.

Image problems

- ❓ *No image appears on-screen*
 - Ensure all the cables and power connections are correctly and securely connected as described in the "Installation" section.
 - Ensure the pins of connectors are not crooked or broken.
 - Ensure that the volume is not set to "0".

- ❓ *Image is out of focus*
 - Adjust the focus using the focus wheel. Please refer to page 10.
 - Make sure the projection screen is between the required distance from the projector. Please refer to page 18.

- ❓ *The image is stretched when displaying 16:9 DVD title*
 - When you play anamorphic DVD or 16:9 DVD, the projector will show the best image in 16: 9 format on projector side.
 - If you play 4:3 format DVD title, please change the format as 4:3 in projector OSD.
 - Please setup the display format as 16:9 (wide) aspect ratio type on your DVD player.

- ❓ *Image is too small or too large*
 - Move the projector closer to or further from the screen.
 - Press the  key on the projector panel, go to "Display > Aspect Ratio". Try the different settings.

- ❓ *Image has slanted sides:*
 - If possible, reposition the projector so that it is centered on the screen and below the bottom of the screen.
 - Use "Keystone > Auto Keystone or Manual Keystone" from the OSD to make an adjustment.

- ❓ *Image is reversed*
 - Select "Display > Projection" from the OSD and adjust the projection direction.

Other problems

- ❓ *The projector stops responding to all controls*
 - If possible, turn off the projector, then unplug the power cord and wait at least 20 seconds before reconnecting power.

ADDITIONAL INFORMATION

LED lightning messages

Message	LED Indicator				
	Power		Battery		
Color	Blue	Red	Green	Orange	Red
Battery Charging		On			
Battery Charging is Complete	On				
Battery Capacity 70%~100%			On		
Battery Capacity 40%~70%				On	
Battery Capacity 5%~40%					On
Battery Level <5%*1					Flashing for 10 sec (0.5 sec on / 0.5 sec off)
Fan Failure*2					Flashing for 30 sec (1 sec on / 0.5 sec off)
Projector has Overheated*2					Flashing for 30 sec (0.5 sec on / 1 sec off)
Battery has Overheated*3				Flashing (0.5 sec on / 0.5 sec off)	

Note:

- *1: The projector will automatically shut down after the event.
- *2: The projector will automatically shut down before the event.
- *3: The LED indicator keeps flashing until the battery temperature becomes normal.

Warning messages

- Power off:

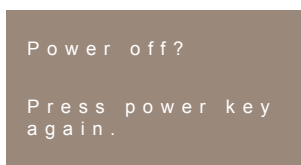

- No signal warning:



ADDITIONAL INFORMATION

Specifications

Optical	Description
Native resolution	FWVGA 854x480
Lens	Fixed focus
Image size (diagonal)	- Mechanical range: 15"~150" - Optical range: 25"~80", optimized at 40"
Projection distance	- Mechanical range: 0.36m~3.66m - Optical range: 0.6m~1.9m

Electrical	Description
Inputs	- HDMI v1.4b, MHL v.2.2, HDCP - USB DC 5V output @ 1A
Outputs	- Headphone jack
Scan rate	- Horizontal scan rate: 15~75 KHz - Vertical scan rate: 24~60 Hz
Built-in speaker	1.5W mono speakers
Power requirement	AC adapter, input 100-240V, AC 50/60Hz, output 19V DC (to projector)
Input current	DC in 2.1A

Mechanical	Description
Installation orientation	Front, Rear, Front-Ceiling, Rear-Ceiling
Dimensions (W x D x H)	108 x 126.2 x 35.5 mm
Weight	0.4 kg
Environmental conditions	Operating in 5~40°C , 10% to 80% humidity (non-condensing)

Note: All specifications are subject to change without notice.



ADDITIONAL INFORMATION

Optoma global offices

For service or support, please contact your local office.



USA

3178 Laurelview Ct.
Fremont, CA 94538, USA
www.optomausa.com

 888-289-6786
 510-897-8601
 services@optoma.com



Canada

3178 Laurelview Ct.
Fremont, CA 94538, USA
www.optomausa.com

 888-289-6786
 510-897-8601
 services@optoma.com

Latin America

3178 Laurelview Ct.
Fremont, CA 94538, USA
www.optomausa.com

 888-289-6786
 510-897-8601
 services@optoma.com



Europe

Unit 1, Network 41, Bourne End Mills,
Hemel Hempstead, Herts,
HP1 2UJ, United Kingdom
www.optoma.eu
Service Tel : +44 (0)1923 691865

 +44 (0) 1923 691 800
 +44 (0) 1923 691 888
 service@tsc-europe.com



Benelux BV

Randstad 22-123
1316 BW Almere
The Netherlands
www.optoma.nl

 +31 (0) 36 820 0252
 +31 (0) 36 548 9052



France

Bâtiment E
81-83 avenue Edouard Vaillant
92100 Boulogne Billancourt, France

 +33 1 41 46 12 20
 +33 1 41 46 94 35
 savoptoma@optoma.fr



Spain

C/ José Hierro,36 Of. 1C
28522 Rivas VaciaMadrid,
Spain

 +34 91 499 06 06
 +34 91 670 08 32



Deutschland

Wiesenstrasse 21 W
D40549 Düsseldorf,
Germany

 +49 (0) 211 506 6670
 +49 (0) 211 506 66799
 info@optoma.de

Scandinavia



Lerpeveien 25
3040 Drammen
Norway

 +47 32 98 89 90
 +47 32 98 89 99
 info@optoma.no

PO.BOX 9515
3038 Drammen
Norway

Korea

WOOMI TECH.CO.,LTD.
4F, Minu Bldg.33-14, Kangnam-Ku,
Seoul,135-815, KOREA
korea.optoma.com

 +82+2+34430004
 +82+2+34430005

Japan

東京都足立区綾瀬3-25-18
株式会社オーエス
コンタクトセンター:0120-380-495

 info@os-worldwide.com
www.os-worldwide.com



Taiwan

12F., No.213, Sec. 3, Beixin Rd.,
Xindian Dist., New Taipei City 231,
Taiwan, R.O.C.
www.optoma.com.tw

 +886-2-8911-8600
 +886-2-8911-6550
 services@optoma.com.tw
asia.optoma.com



Hong Kong

Unit A, 27/F Dragon Centre,
79 Wing Hong Street,
Cheung Sha Wan,
Kowloon, Hong Kong

 +852-2396-8968
 +852-2370-1222
www.optoma.com.hk

China

5F, No. 1205, Kaixuan Rd.,
Changning District
Shanghai, 200052, China

 +86-21-62947376
 +86-21-62947375
www.optoma.com.cn

