

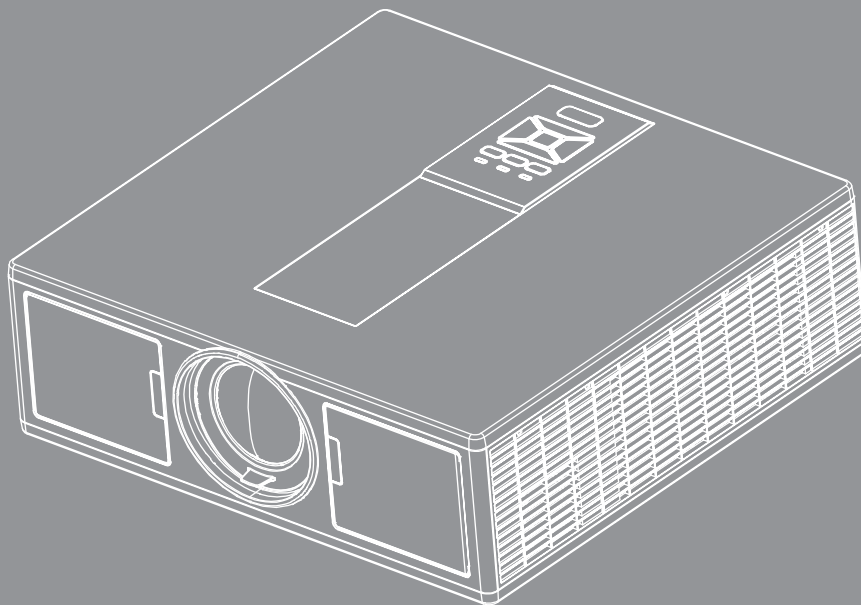

# DLP® Projector





User's Manual



# TABLE OF CONTENTS

<b>SAFETY .....</b>	<b>3</b>
<i>Regulation &amp; Safety Notices.....</i>	<i>5</i>
<b>INTRODUCTION .....</b>	<b>8</b>
<i>Package Overview .....</i>	<i>8</i>
<i>Product Overview .....</i>	<i>9</i>
<i>Main Unit .....</i>	<i>9</i>
<i>Control Panel.....</i>	<i>10</i>
<i>Connections .....</i>	<i>11</i>
<i>Remote Control .....</i>	<i>12</i>
<b>SETUP AND INSTALLATION .....</b>	<b>15</b>
<i>Connecting Source to the Projector .....</i>	<i>15</i>
<i>Powering the Projector On/Off .....</i>	<i>17</i>
<i>Warning Indicator .....</i>	<i>18</i>
<i>Adjusting the projector position .....</i>	<i>19</i>
<i>Adjusting the Projected Image .....</i>	<i>20</i>
<b>USER CONTROLS .....</b>	<b>23</b>
<i>Using the Control Panel .....</i>	<i>23</i>
<i>On-screen Display Menus .....</i>	<i>24</i>
<i>How to operate .....</i>	<i>24</i>
<i>Structure .....</i>	<i>25</i>
<i>Picture .....</i>	<i>29</i>
<i>Screen .....</i>	<i>31</i>
<i>Settings .....</i>	<i>33</i>
<i>Volume .....</i>	<i>34</i>
<i>Options .....</i>	<i>35</i>
<i>3D .....</i>	<i>38</i>
<i>LAN .....</i>	<i>39</i>
<b>APPENDICES .....</b>	<b>40</b>
<i>Projector Problems .....</i>	<i>40</i>
<i>How to use web browser to control your projector .....</i>	<i>42</i>
<i>Crestron RoomView Control Tool .....</i>	<i>43</i>
<i>Installing and Cleaning the Optional Dust Filter .....</i>	<i>45</i>
<i>Compatibility Modes .....</i>	<i>46</i>
<i>Ceiling Mount Installation .....</i>	<i>49</i>
<i>Optoma global offices .....</i>	<i>50</i>

# SAFETY

	The lightning flash with arrow head within an equilateral triangle is intended to alert the user to the presence of uninsulated “dangerous voltage” within the product’s enclosure that may be of sufficient magnitude to constitute a risk of electric shock to persons.
	The exclamation point within an equilateral triangle is intended to alert the user to the presence of important operating and maintenance (servicing) instructions in the literature accompanying the appliance.

**WARNING:** TO REDUCE THE RISK OF FIRE OR ELECTRIC SHOCK, DO NOT EXPOSE THIS APPLIANCE TO RAIN OR MOISTURE. DANGEROUS HIGH VOLTAGES ARE PRESENT INSIDE THE ENCLOSURE. DO NOT OPEN THE CABINET. REFER SERVICING TO QUALIFIED PERSONNEL ONLY.

## **Class B emissions limits**

This Class B digital apparatus meets all requirements of the Canadian Interference-Causing Equipment Regulations.

## **Important Safety Instruction**

1. Do not block any ventilation openings. To ensure reliable operation of the projector and to protect from over heating, it is recommended to install the projector in a location that does not block ventilation. As an example, do not place the projector on a crowded coffee table, sofa, bed, etc. Do not put the projector in an enclosure such as a book case or a cabinet that restricts air flow.
2. Do not use the projector near water or moisture. To reduce the risk of fire and/or electric shock, do not expose the projector to rain or moisture.
3. Do not install near heat sources such as radiators, heaters, stoves or any other apparatus such as amplifiers that emits heat.
4. Clean only with dry cloth.
5. Only use attachments/accessories specified by the manufacturer.
6. Do not use the unit if it has been physically damaged or abused.  
Physical damage/abuse would be (but not limited to):
  - Unit has been dropped.
  - Power supply cord or plug has been damaged.
  - Liquid has been spilled on to the projector.
  - Projector has been exposed to rain or moisture.
  - Something has fallen in the projector or something is loose inside.Do not attempt to service the unit yourself. Opening or removing covers may expose you to dangerous voltages or other hazards.
7. Do not let objects or liquids enter the projector. They may touch dangerous voltage points and short out parts that could result in fire or electric shock.
8. See projector enclosure for safety related markings.
9. The unit should only be repaired by appropriate service personnel.

## Precautions



*Please follow all warnings, precautions and maintenance as recommended in this user's guide.*

- Warning- Do not look into the projector's lens when the light source is on. The bright light may hurt and damage your eyes.
- Warning- To reduce the risk of fire or electric shock, do not expose this projector to rain or moisture.
- Warning- Please do not open or disassemble the projector as this may cause electric shock.
- Warning- Please do not open or disassemble the projector as this may cause electric shock.

### Do:

- Turn off and unplug the power plug from the AC outlet before cleaning the product.
- Use a soft dry cloth with mild detergent to clean the display housing.
- Disconnect the power plug from AC outlet if the product is not being used for a long period of time.

### Do not:

- Block the slots and openings on the unit provided for ventilation.
- Use abrasive cleaners, waxes or solvents to clean the unit.
- Use under the following conditions:
  - In extremely hot, cold or humid environments.
    - ▶ Sea level to 6000 feet  
Extremely hot: > 35°C  
Extremely cool: < 5°C
    - ▶ 6000 feet above  
Extremely hot: > 30°C  
Extremely cool: < 5°C
    - ▶ Extremely humid: > 70% R.H. (Relative Humidity)
  - In areas susceptible to excessive dust and dirt.
  - Near any appliance generating a strong magnetic field.
  - In direct sunlight.

## 3D Safety Information

Please follow all warnings and precautions as recommended before you or your child use the 3D function.

### Warning

Children and teenagers may be more susceptible to health issues associated with viewing in 3D and should be closely supervised when viewing these images.

#### Photosensitive Seizure Warning and Other Health Risks

- Some viewers may experience an epileptic seizure or stroke when exposed to certain flashing images or lights contained in certain Projector pictures or video games. If you suffer from, or have a family history of epilepsy or strokes, please consult with a medical specialist before using the 3D function.
- Even those without a personal or family history of epilepsy or stroke may have an undiagnosed condition that can cause photosensitive epileptic seizures.
- Pregnant women, the elderly, sufferers of serious medical conditions, those who are sleep deprived or under the influence of alcohol should avoid utilizing the unit's 3D functionality.
- If you experience any of the following symptoms, stop viewing 3D pictures immediately and consult a medical specialist: (1) altered vision; (2) light-headedness; (3) dizziness; (4) involuntary movements such as eye or muscle twitching; (5) confusion; (6) nausea; (7) loss of awareness; (8) convulsions; (9) cramps; and/ or (10) disorientation. Children and teenagers may be more likely than adults to experience these symptoms. Parents should monitor their children and ask whether they are experiencing these symptoms.

- Watching 3D projection may also cause motion sickness, perceptual after effects, disorientation, eye strain and decreased postural stability. It is recommended that users take frequent breaks to lessen the potential of these effects. If your eyes show signs of fatigue or dryness or if you have any of the above symptoms, immediately discontinue use of this device and do not resume using it for at least thirty minutes after the symptoms have subsided.
- Watching 3D projection while sitting too close to the screen for an extended period of time may damage your eyesight. The ideal viewing distance should be at least three times the screen height. It is recommended that the viewer's eyes are level with the screen.
- Watching 3D projection while wearing 3D glasses for an extended period of time may cause a headache or fatigue. If you experience a headache, fatigue or dizziness, stop viewing the 3D projection and rest.
- Do not use the 3D glasses for any other purpose than for watching 3D projection.
- Wearing the 3D glasses for any other purpose (as general spectacles, sunglasses, protective goggles, etc.) may be physically harmful to you and may weaken your eyesight.
- Viewing in 3D projection may cause disorientation for some viewers. Accordingly, DO NOT place your 3D PROJECTOR near open stairwells, cables, balconies, or other objects that can be tripped over, run into, knocked down, broken or fallen over.

## Copyright

This publication, including all photographs, illustrations and software, is protected under international copyright laws, with all rights reserved. Neither this manual, nor any of the material contained herein, may be reproduced without written consent of the author.

© Copyright 2015

## Disclaimer

The information in this document is subject to change without notice. The manufacturer makes no representations or warranties with respect to the contents hereof and specifically disclaims any implied warranties of merchantability or fitness for any particular purpose. The manufacturer reserves the right to revise this publication and to make changes from time to time in the content hereof without obligation of the manufacturer to notify any person of such revision or changes.

## Trademark Recognition

Kensington is a U.S. registered trademark of ACCO Brand Corporation with issued registrations and pending applications in other countries throughout the world.

HDMI, the HDMI Logo, and High-Definition Multimedia Interface are trademarks or registered trademarks of HDMI Licensing LLC in the United States and other countries.

IBM is a trademark or registered trademark of International Business Machines, Inc. Microsoft, PowerPoint, and Windows are trademarks or registered trademarks of Microsoft Corporation.

Adobe and Acrobat are trademarks or registered trademarks of Adobe Systems Incorporated.

DLP, DLP Link and the DLP logo are registered trademarks of Texas Instruments and BrilliantColor™ is a trademark of Texas Instruments.

All other product names used in this manual are the properties of their respective owners and are Acknowledged.

## Regulation & Safety Notices

*This appendix lists the general notices of your projector.*

### **FCC notice**

This device has been tested and found to comply with the limits for a Class B digital device pursuant to Part 15 of the FCC rules. These limits are designed to provide reasonable protection against harmful interference in a residential installation. This device generates, uses and can radiate radio frequency energy and, if not installed and used in accordance with the instructions, may cause harmful interference to radio communications.

However, there is no guarantee that interference will not occur in a particular installation. If this device does cause harmful interference to radio or television reception, which can be determined by turning the device off and on, the user is encouraged to try to correct the interference by one or more of the following measures:

- Reorient or relocate the receiving antenna.
- Increase the separation between the device and receiver.
- Connect the device into an outlet on a circuit different from that to which the receiver is connected.
- Consult the dealer or an experienced radio/television technician for help.

### ***Notice: Shielded cables***

All connections to other computing devices must be made using shielded cables to maintain compliance with FCC regulations.

### ***Caution***

Changes or modifications not expressly approved by the manufacturer could void the user's authority, which is granted by the Federal Communications Commission, to operate this projector.

### ***Operation conditions***

This device complies with Part 15 of the FCC Rules. Operation is subject to the following two conditions:

1. This device may not cause harmful interference and
2. This device must accept any interference received, including interference that may cause undesired operation.

### ***Notice: Canadian users***

This Class B digital apparatus complies with Canadian ICES-003.

### ***Remarque à l'intention des utilisateurs canadiens***

Cet appareil numérique de la classe B est conforme à la norme NMB-003 du Canada.

### ***Declaration of Conformity for EU countries***

- EMC Directive 2014/30/EU
- Low Voltage Directive 2014/35/EU
- (RED) 2014/53/EU (if product has RF function)
- RoHS Directive 2011/65/EU

#### **Disposal instructions**



**Do not throw this electronic device into the trash when discarding. To minimize pollution and ensure utmost protection of the global environment, please recycle it.**

## Safety notice

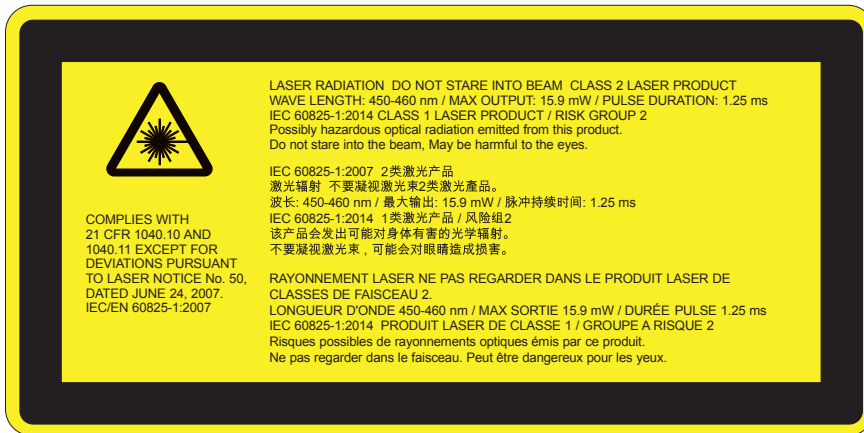

## WARNING

- This product is classified as Class 2 of IEC 60825-1 : 2007 and also complies with 21 CFR 1040.10 and 1040.11 except for deviations pursuant to Laser Notice No. 50, dated June 24, 2007. IEC 60825-1:2014: CLASS 1 LASER PRODUCT - RISK GROUP 2
- Explanatory label is shown all information of laser power.
- This projector has built-in Class 4 laser module. Disassembly or modification is very dangerous and should never be attempted.
- Any operation or adjustment not specifically instructed by the user's guide creates the risk of hazardous laser radiation exposure.
- Do not open or disassemble the projector as this may cause damage by the exposure of laser radiation.
- Do not stare into beam when the projector is on. The bright light may result in permanent eye damage.
- When turning on the projector, make sure no one within projection range is looking at the lens.
- Without following the control, adjustment or operation procedure may cause damage by the exposure of laser radiation.
- Adequate instructions for assembly, operation, and maintenance, including clear warnings concerning precautions to avoid possible exposure to laser and collateral radiation in excess of the accessible emission limits in Class 2.
- This projector is a Class 2 laser device that conforms with IEC 60825-1:2007 and CFR 1040.10 and 1040.11.
- Class 2 laser product, Do Not Stare Into Beam.
- This projector has built-in Class 4 laser module. Disassembly or modification is very dangerous and should never be attempted.
- Any operation or adjustment not specifically instructed by the user's guide creates the risk of hazardous laser radiation exposure.
- Do not open or disassemble the projector as this may cause damage by the exposure of laser radiation.
- Do not stare into beam when the projector is on. The bright light may result in permanent eye damage.
- Without following the control, adjustment or operation procedure may cause damage by the exposure of laser radiation.
- Adequate instructions for assembly, operation, and maintenance, including clear warnings concerning precautions to avoid possible exposure to laser and collateral radiation in excess of the accessible emission limits in Class 2.

# INTRODUCTION

## Package Overview

Unpack and inspect the box contents to ensure all parts listed below are in the box. If something is missing, please contact your nearest customer service center.

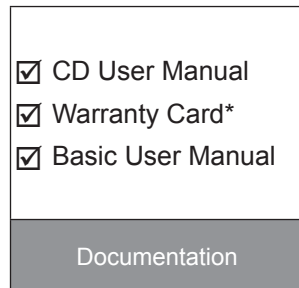
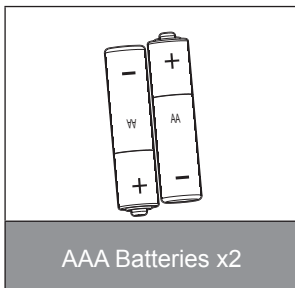
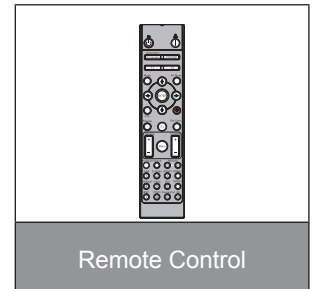
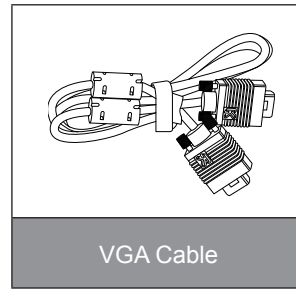
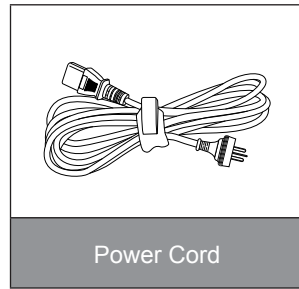
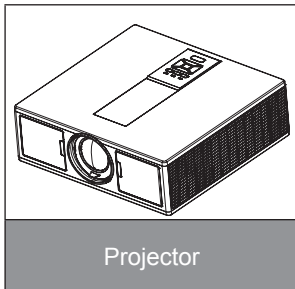

**Note:** \* For European warranty Information, please visit [www.optomaeurope.com](http://www.optomaeurope.com)  
Due to different applications in each country, some regions may have edifferent accessories.



# INTRODUCTION

## Product Overview

### Main Unit

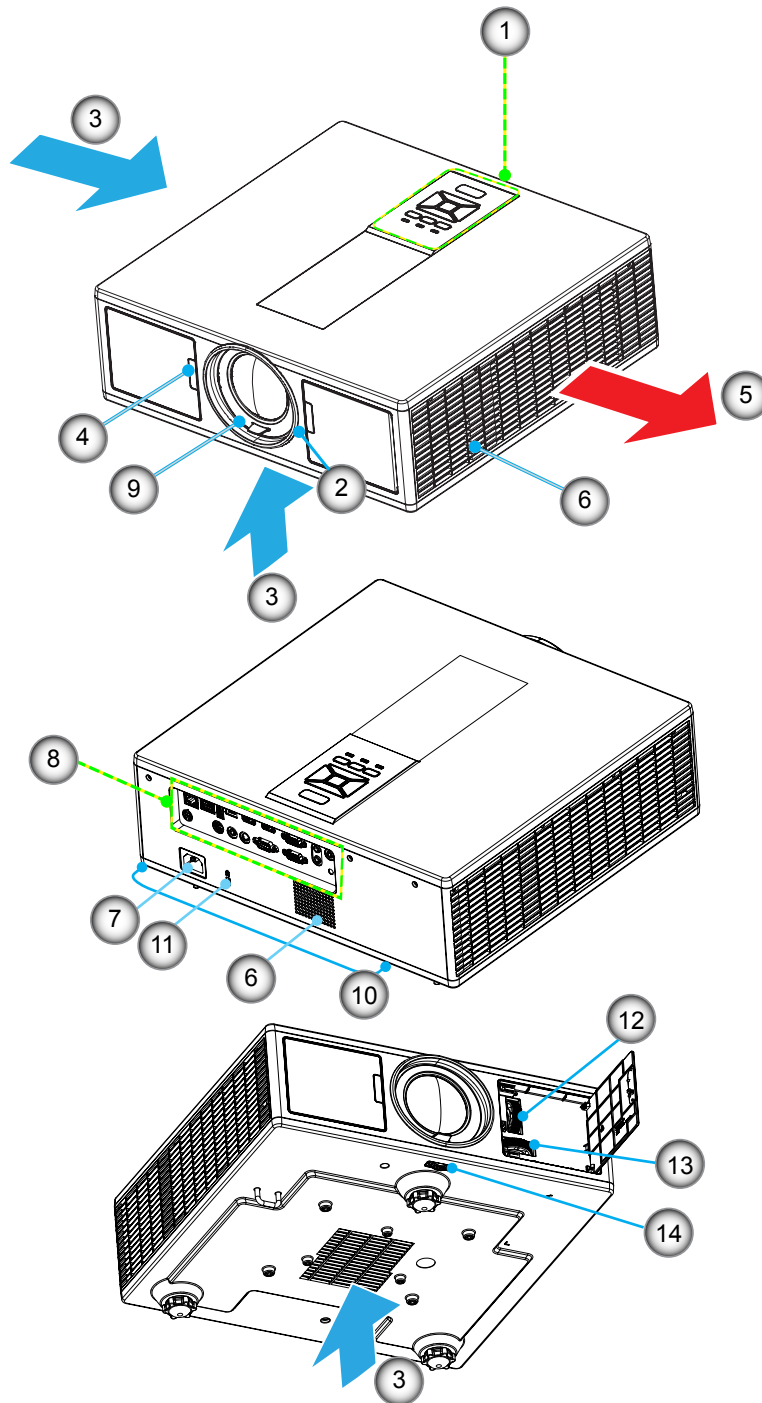

**Note:** Do not block projector inlet or outlet air vents.

No	Item	No	Item
1.	Keypad	8.	Input / Output Connections
2.	Focus Ring	9.	Lens
3.	Ventilation (inlet)	10.	Tilt-Adjustment Foot
4.	IR Receiver	11.	Kensington Lock
5.	Ventilation (outlet)	12.	Lens Shift (vertical)
6.	Speakers	13.	Lens Shift (Horizontal)
7.	Power Socket	14.	Lens lock

# INTRODUCTION

## Control Panel

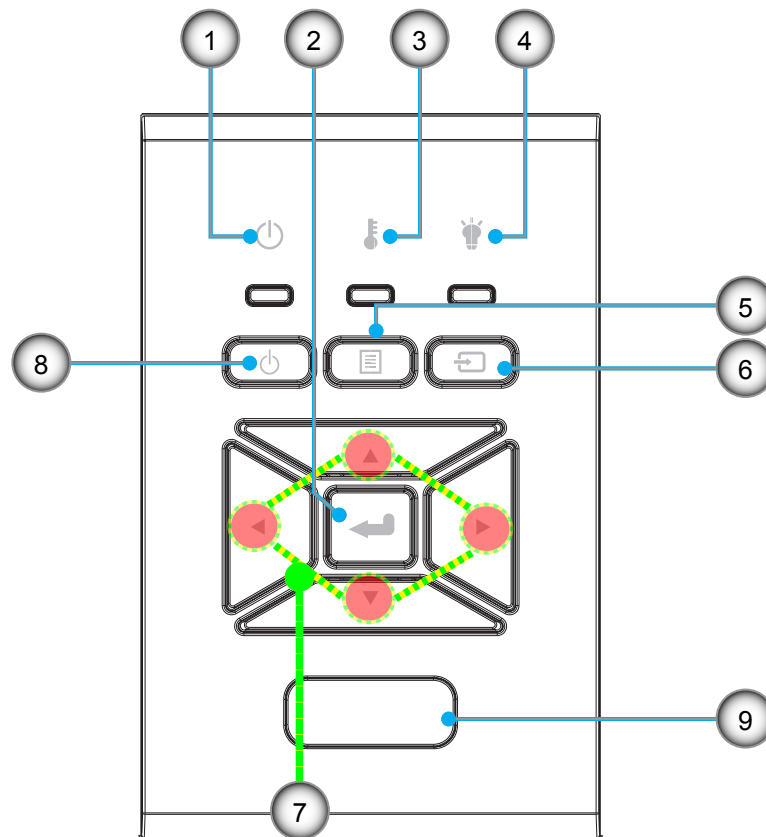

No	Item
1.	On/Standby LED
2.	Enter
3.	Temp LED
4.	Lamp LED
5.	Menu

No	Item
6.	Source
7.	Four Directional Select Keys
8.	Power/Standby button
9.	IR Receiver

# INTRODUCTION

## Connections

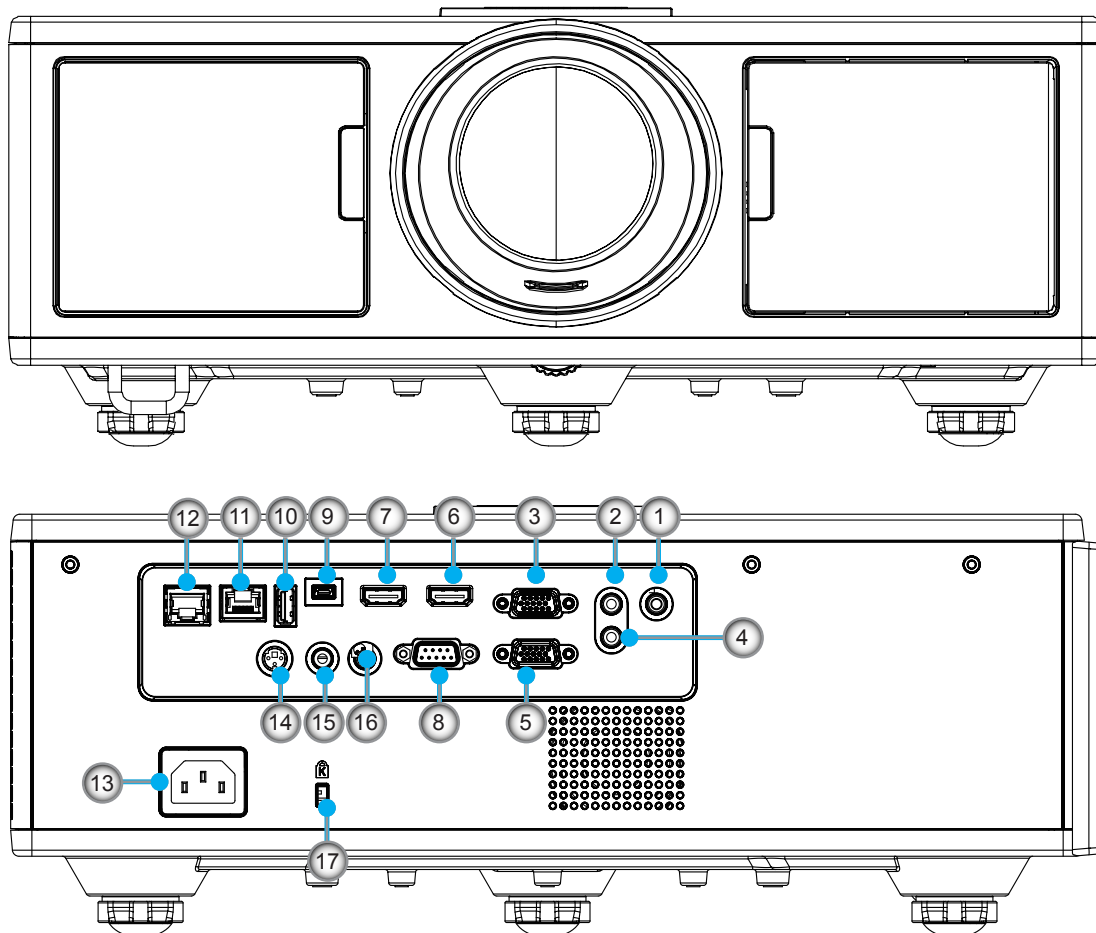

No	Item
1.	Microphone connector
2.	Audio In connector
3.	VGA In/ YPbPr connector
4.	Audio Out connector
5.	VGA Out connector
6.	HDMI 1connector
7.	HDMI 2/MHL connector
8.	RS232C connector
9.	USB-B mini connector
10.	USB Power Out (5V ---1.5A) Connector

No	Item
11.	HDBaseT connector (Depending on Model)
12.	RJ45
13.	Power Socket
14.	3D Sync Out (5V) connector
15.	Wired Remote connector
16.	12V Trigger connector
17.	Kensington Lock

# INTRODUCTION

## Remote Control

No	Item
1.	Power On Power on the projector.
2.	Geometric Correction Launch the Geometric Correction menu.
3.	F1:Test pattern Display a test pattern.
4.	Display Mode Select the display mode.
5.	Four directional select keys To select items or make adjustments.
6.	Information Display the projector information.
7.	F3:Color Matching Launch the Color Matching setting menu.
8.	Input source selection Select an input signal.
9.	Menu Launch the OSD menu. To exit OSD, Press "Menu" again.
10.	Volume Control +/- Increase/decrease the volume.
11.	Freeze Freeze the projected image.
12.	Format Choose the projector format.
13.	VGA Switch to VGA source.
14.	HDMI1 Switch to HDMI1 source.
15.	HDBaseT (Depending on Model) Switch to HDBaseT source.
16.	3D Switch to 3D source.
17.	Power Off Power off the projector.
18.	PIP/PBP Menu Launch the PIP/PBP menu.
19.	F2:LAN Settings Launch the LAN Setting Menu.

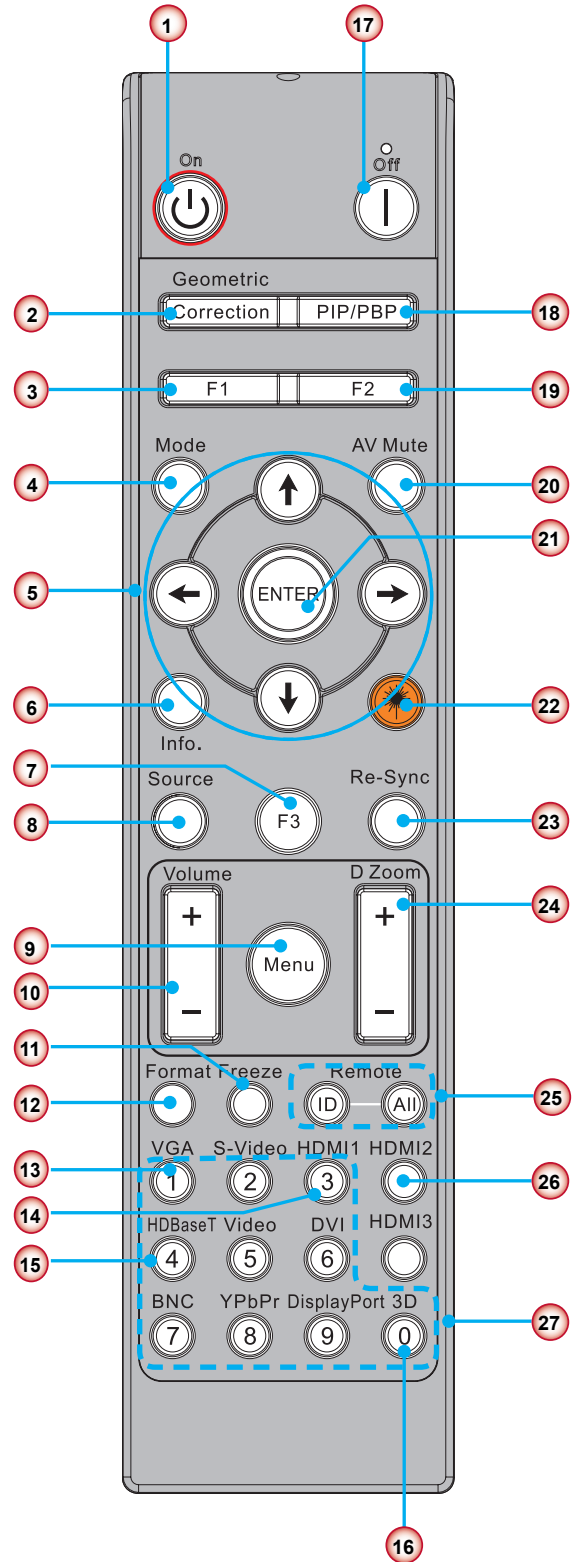

**Note:** Some keys may have no function for models that do not support these features.

# INTRODUCTION

No	Item
20.	AV Mute Momentarily turns off/on the audio and video.
21.	Enter Confirm your item selection.
22.	Laser Use as laser pointer.
23.	Re-Sync Automatically synchronize the projector to the input source.
24.	Digital Room +/- Zoom in/out the projected image.
25.	Remote ID / Remote all Set the remote control ID.
26.	HDMI2 Switch to HDMI2 source.
27.	Number Keypad (0~9) Use as numeric keypad number "0~9".

# INTRODUCTION

## IR Code table for Data

Customer code		32CD	
Key	Description	Key code	printing-key definition
1	Power Off	2E	Off
2	Power On	2	On
3	PIP/PBP Menu	78	PIP/PBP
4	Keystone	7	Geometric Correction
5	Function 2	27	F2
6	Function 1	26	F1
7	Display mode menu on/off	95	Mode
8	Up key for OSD when OSD on	C6	Up arrow
9	AV Mute	3	AV Mute
10	Left key for OSD when OSD on	C8	Left arrow
11	Enter	C5	Enter
12	Right key for OSD when OSD on	C9	Right arrow
13	Information	25	Info.
14	Down key for OSD when OSD on	C7	Down arrow
15	Laser pointer trigger, press to emit laser	N/A	Laser
16	Input source selection when OSD off	18	Source
17	Function 3	66	F3
18	Auto adjustment for phase, tracking, size, position when OSD off	4	Re-Sync
19	OSD menu on/off	88	Menu
20	Volume Control +	9	Volume +
21	Volume Control -	0C	Volume -
22	D Zoom +	8	D Zoom +
23	D Zoom -	0B	D Zoom -
24	Format	15	Format
25	Freeze	6	Freeze
26	Mode 1~99	3201~ 3299	
27	All	32CD	
28	Input source select VGA1	8E	1/VGA1
30	Input source select HDMI1	16	3/HDMI1
31	Input source select HDMI2	9B	HDMI2
32	Input source select HDBasT	70	4/HDBaseT
38	3D Menu	89	0/3D
39	HDMI3 (Dongle)	98	HDMI3
40	Function 3	66	F3

# SETUP AND INSTALLATION

## Connecting Source to the Projector Connect to Computer/Notebook

**Note:**

*Due to the difference in applications for each country, some regions may have different accessories.  
(\* ) Optional accessory*

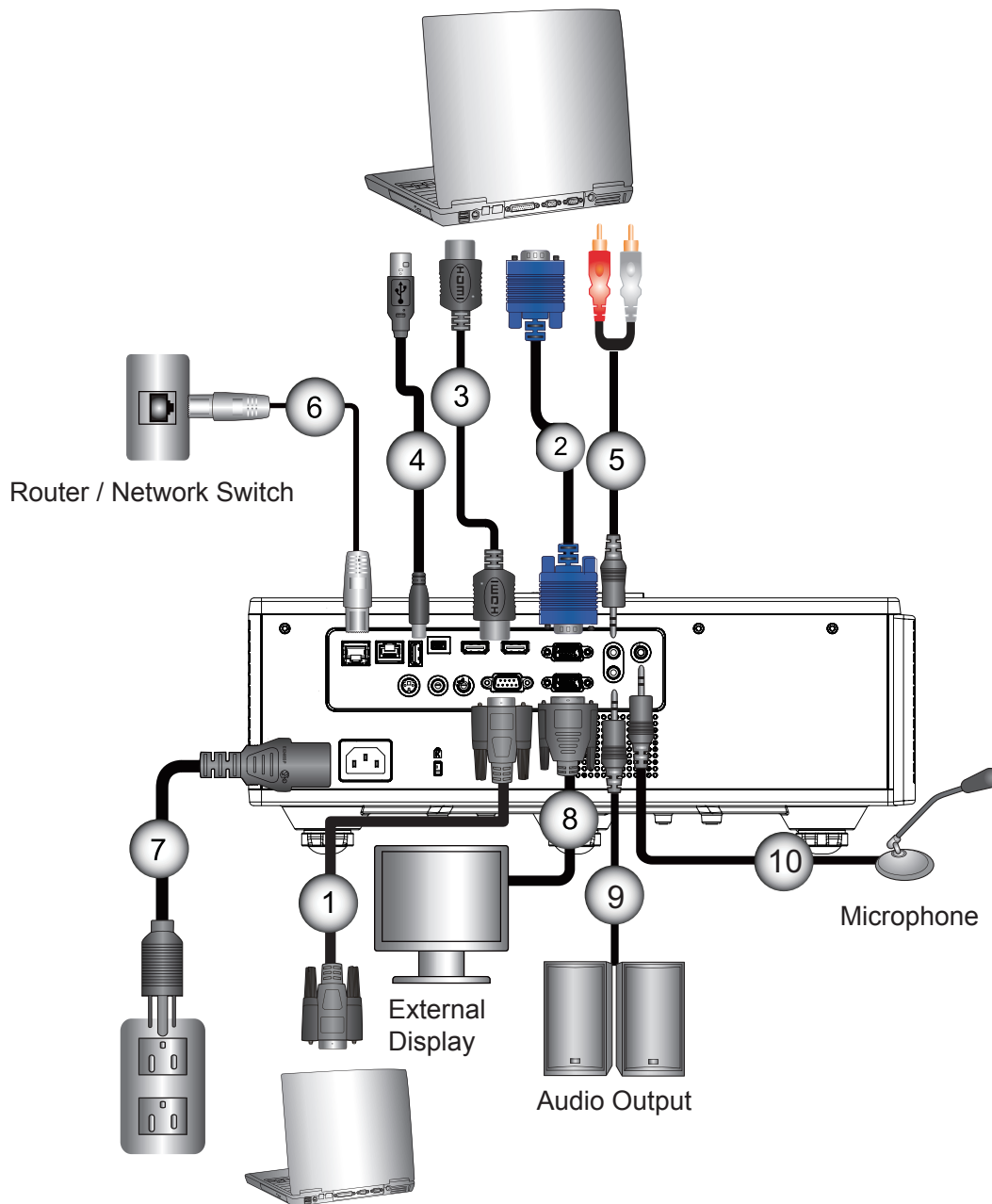

No	Item
1.	RS232 Cable
2.	VGA Cable
3.	HDMI Cable
4.	USB Cable
5.	Audio In Cable

No	Item
6.	RJ45 Cable
7.	Power Code
8.	VGA Out Cable
9.	Audio Out Cable
10.	Microphone cable

# SETUP AND INSTALLATION

## Connect to Video Sources

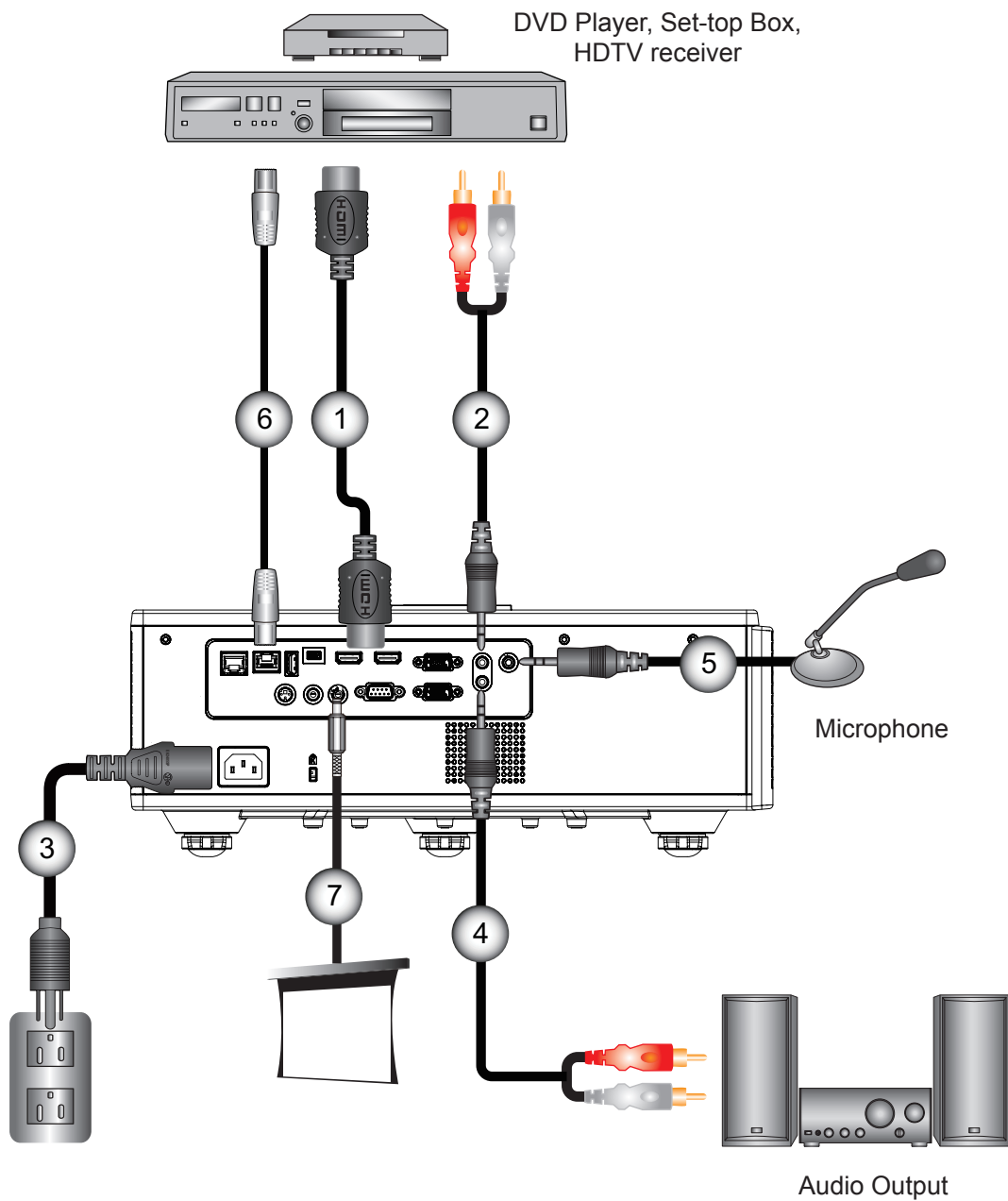

No	Item
1.	HDMI Cable
2.	Audio In Cable
3.	Power Code
4.	Audio Out Cable

No	Item
5.	Microphone cable
6.	RJ-45 cable (Cat5 cable)
7.	12V DC Jack

**Note:**

Due to the difference in applications for each country, some regions may have different accessories.  
(\* ) Optional accessory



# SETUP AND INSTALLATION

## Powering the Projector On/Off

### Powering On the Projector

1. Securely connect the power cord and signal cable. When connected, the POWER/STANDBY LED will turn Red.
2. Turn on the lamp by pressing the “⏻” button either on the projector or on the remote. At this moment, the POWER/STANDBY LED will now turn Blue. ①

The startup screen will display in approximately 6 seconds.

3. Turn on and connect the source that you want to display on the screen (computer, notebook, video player, etc). The projector will detect the source automatically.
  - ▶ If you connect multiple sources at the same time, press the “INPUT” button on the control panel to switch between inputs.

**Note:** When the power mode is in standby mode (power consumption < 0.5W), the VGA output/Wire remote/LAN will be deactivated when the projector is in standby. Audio out loop-through is always active in standby mode. HDBaseT control is always deactivated in standby mode.

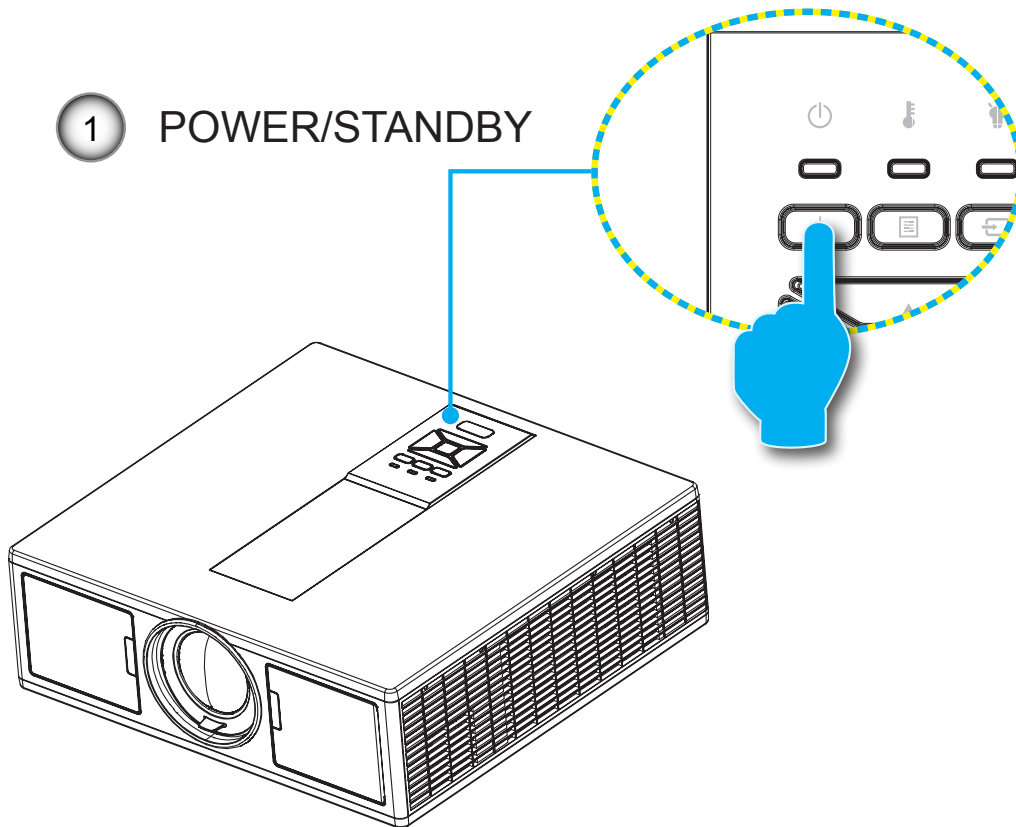

**Note:** Turn on the projector first and then select the signal sources.

# SETUP AND INSTALLATION

## Powering Off the Projector

1. Press the “⏻” button on the remote control or on the control panel to turn off the projector. The following message will be displayed on the screen.

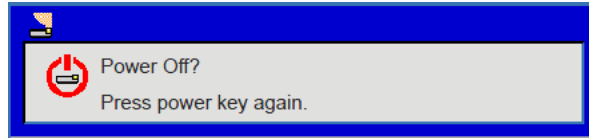

Press the “⏻” button again to confirm otherwise the message will disappear after 10 seconds. When you press the “⏻” button for the second time, the fan will start cooling the system and will shut down.

2. The cooling fans continue to operate for about 4 seconds for cooling cycle and the POWER/STANDBY LED will flash Red. When the POWER/STANDBY LED lights solid Red, the projector has entered standby mode. If you wish to turn the projector back on, you must wait until the projector has completed the cooling cycle and has entered standby mode. Once in standby mode, simply press “⏻” button to restart the projector.
3. Disconnect the power cord from the electrical outlet and the projector.

## Warning Indicator

### LED lightning messages

When the warning indicators (see below) come on, the projector will automatically shutdown:

- ❖ “LAMP” LED indicator is lit red and/or if “TEMP” LED indicator is lit red.
- ❖ “TEMP” LED indicator is lit red, this indicates the projector has overheated. Under normal conditions, the projector can be switched back on.
- ❖ “TEMP” LED indicator flashes red.

Unplug the power cord from the projector, wait for 30 seconds and try again. If the warning indicator light up again, please contact your nearest service center for assistance.

Message	⏻ Power LED		🔑 Temp LED	💡 Lamp LED
	Red	Blue	Red	Red
Standby State (LAN Off)	On			
Standby State (LAN On)	On	On		
Power On		On		
Warning Up	Flashing			
Error(PowerGood NG)			On	On
Error (Fan fail)			Flashing	
Error (Over Temp)			On	
Error (LD fail)				On

# SETUP AND INSTALLATION

## Adjusting the projector position

When you select a position for the projector, consider the size and shape of your screen, the location of your power outlets, and the distance between the projector and the rest of your equipment. Follow these general guidelines:

Position the projector on a flat surface at a right angle to the screen. The projector must be at least 4.26 feet (1.30m) from the projection screen.

Position the projector to the desired distance from the screen. The distance from the lens of the projector to the screen, the zoom setting, and the video format determine the size of the projected image.

360 degree free orientation operation

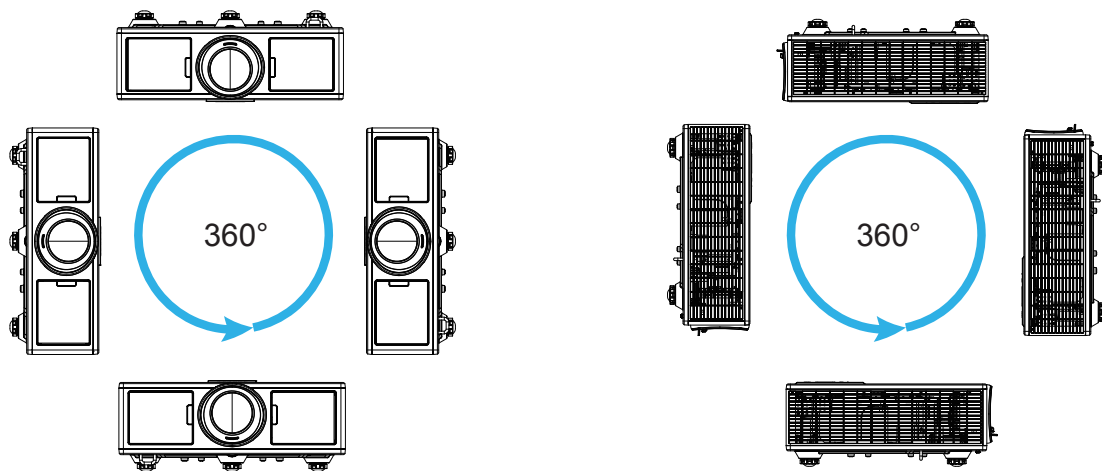

# SETUP AND INSTALLATION

## Adjusting the Projected Image

### Adjusting the Projector's Height

*The projector is equipped with elevator feet for adjusting the image height.*

1. Locate the adjustable foot you wish to modify on the underside of the projector.
2. Rotate the adjustable ring clockwise to raise the projector or counter clockwise to lower it. Repeat with the remaining feet as needed.

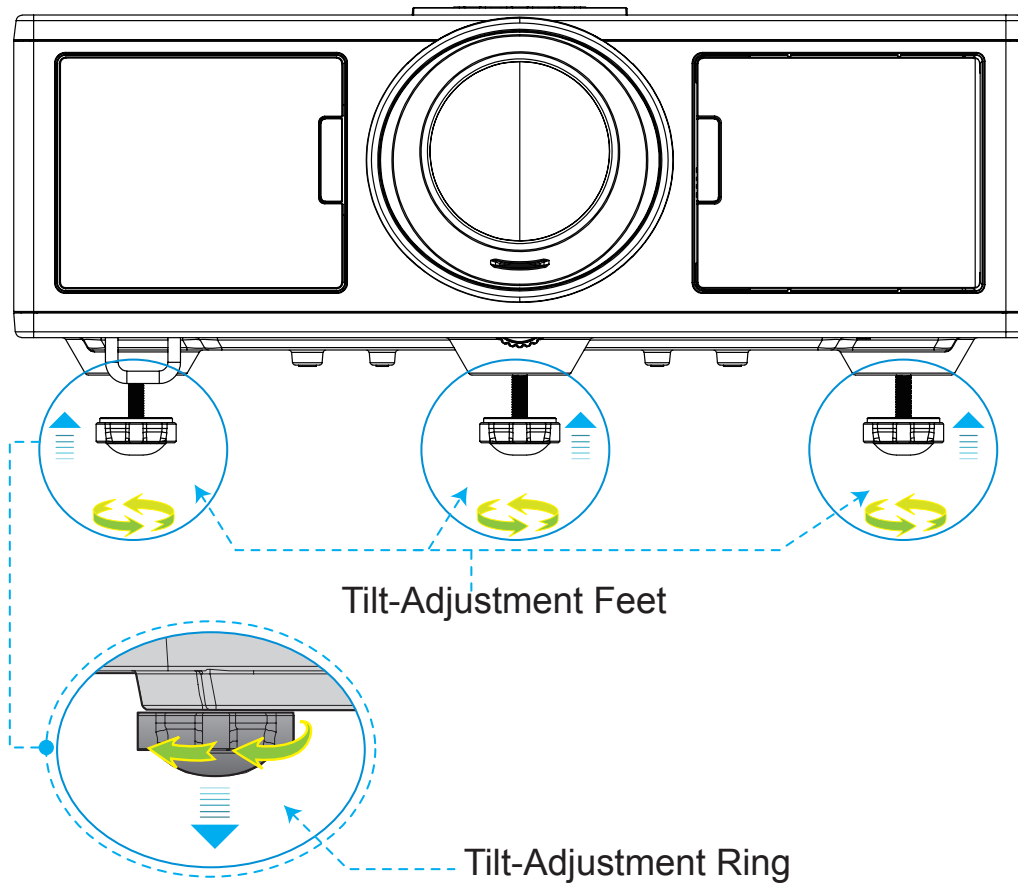

# SETUP AND INSTALLATION

## Adjusting Projector Focus and Zoom

1. To adjust the image size, turn the zoom ring clockwise or anticlockwise to increase or decrease the projected image size.
2. To adjust the focus, turn the focus ring clockwise or anticlockwise until the image is sharp and legible. The projector will focus at distances (lens to wall) from 1.65 ~ 16.5 feet (0.5 ~ 5.0 meters).

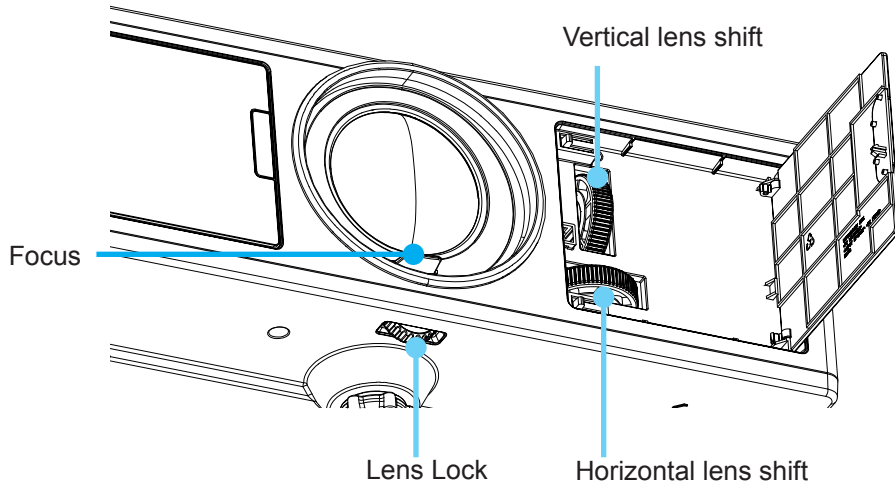

## Adjusting Projection Image Size (Diagonal)

Projection Image Size from 30" to 300" (0.91 -9.09 meters).

1. Open the front side door of the projector.
2. Unlock the lens lock, before adjust the lens shift.
3. Turn the vertical/horizontal lens shift knob to shift the lens
4. Turn the lens lock clockwise to lock the lens in place ( Lens shift knob still can be rotated.)
5. Close the front side door of the projector.

**Note:** The stroke for lens shift is designed to be regular triangle, when lens are adjusted to central position horizontally, lens can be vertically shifted to the highest point

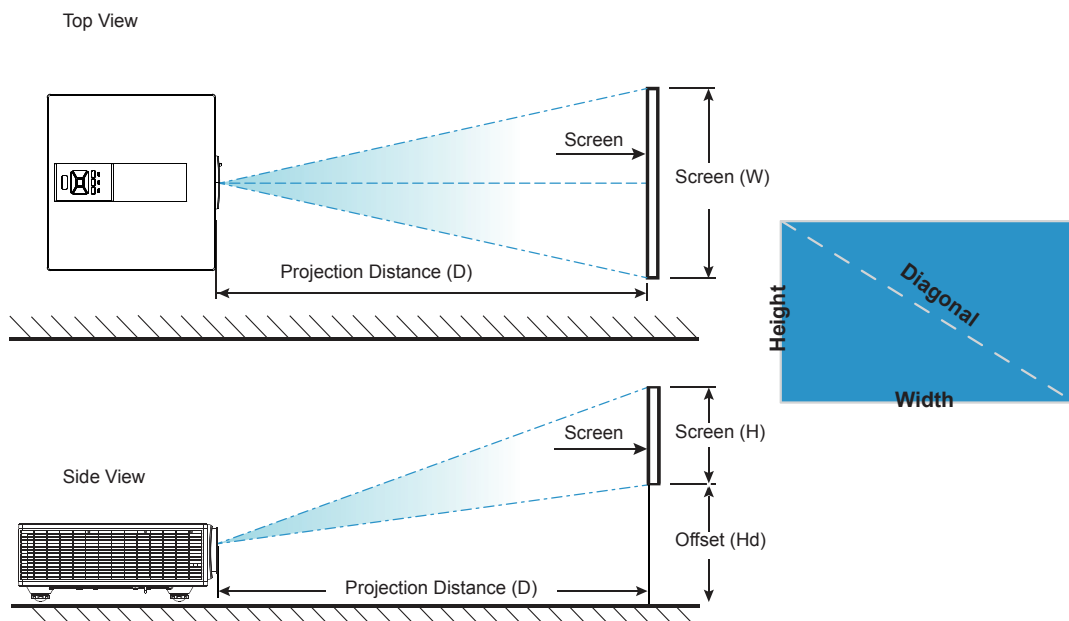

# SETUP AND INSTALLATION

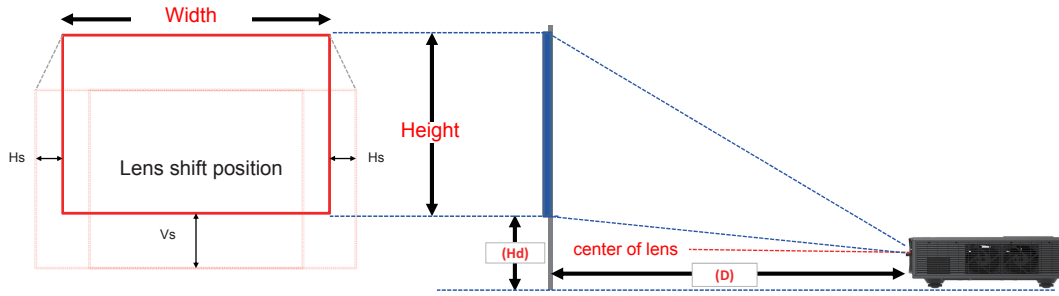

	Vertical Shift Range (Vs)	Horizontal Shift Range (Hs)
XGA	10%	±5%
WUXGA	13%	±5%

Image Offset									
	image size	Screen Size WxH				Projection Distance (D)		Offset (Hd)	
	inch	cm		inch		cm	inch	cm	inch
	Diagonal	Width	Height	Width	Height	-	-	-	-
<b>XGA 4:3</b>	30"	60.7	45.7	23.9	18.0	49.8	19.6	2.3	0.9
	100"	202.3	152.3	79.7	60.0	165.9	65.3	7.6	3.0
	150"	303.5	228.5	119.5	90.0	248.9	98.0	11.4	4.5
	200"	404.7	304.7	159.3	119.9	331.8	130.6	15.2	6.0
	250"	505.8	380.8	199.1	149.9	414.8	163.3	19.1	7.5
	300"	607.0	457.0	239.0	179.9	497.7	196.0	22.9	9.0









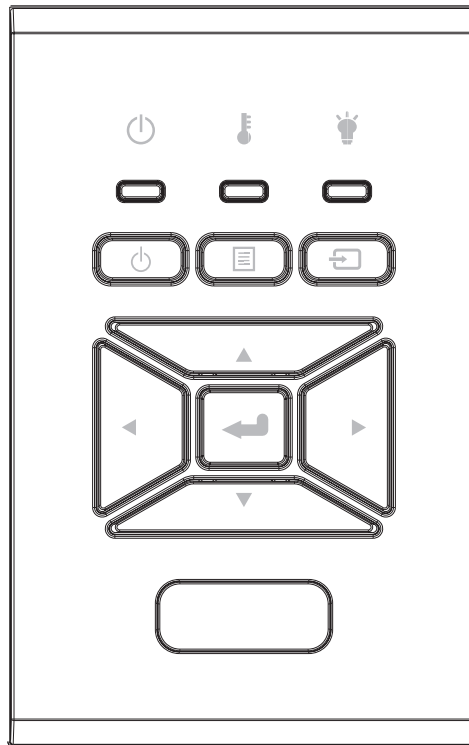

Image Offset									
	image size	Screen Size WxH				Projection Distance (D)		Offset (Hd)	
	inch	cm		inch		cm	inch	cm	inch
	Diagonal	Width	Height	Width	Height	-	-	-	-
<b>WUXGA 16:10</b>	36"	78.0	49.0	30.7	19.3	61.6	24.3	9.7	3.8
	100"	215.0	135.0	84.6	53.1	169.9	66.9	26.9	10.6
	150"	323.0	202.0	127.2	79.5	255.2	100.5	40.4	15.9
	200"	431.0	269.0	169.7	105.9	340.5	134.1	53.9	21.2
	250"	539.0	337.0	212.2	132.7	425.8	167.6	67.3	26.5
	300"	646.0	404.0	254.3	159.1	510.3	200.9	80.8	31.8

❖ This table is for user's reference only.

# USER CONTROLS

## Using the Control Panel



Name	Description
POWER 	Refer to the “Power On/Off the Projector” section on pages 17-18.
Enter 	Confirm a selected item.
INPUT 	Select an input signal
MENU 	Launch the on-screen display (OSD) menu. To exit OSD, press “MENU” again.
Four Directional Select Keys	Use     to select items or make adjustments to your selection.
LAMP LED 	Refer to the LED indicator of the projector light source status.
TEMP LED 	Refer to the LED indicator of the projector temperature status.
ON/STANDBY LED 	Refer to the LED indicator of the projector power status.

# USER CONTROLS

## On-screen Display Menus

The Projector has multilingual On-screen Display menus that allow you to make image adjustments and change a variety of settings.

### How to operate

1. To open the OSD menu, press “Menu” on the Remote Control or Projector Keypad.
2. When OSD is displayed, use ▲▼ keys to select any item in the main menu. While making a selection on a particular page, press the ► or “Enter” key to enter sub menu.
3. Use the ▲▼ keys to select the desired item and adjust the settings using the ◀▶ key.
4. Select the next item to be adjusted in the sub menu and adjust as described above.
5. Press “Enter” to confirm.
6. To exit, press “Menu” again. The OSD menu will close and the projector will automatically save the new settings.

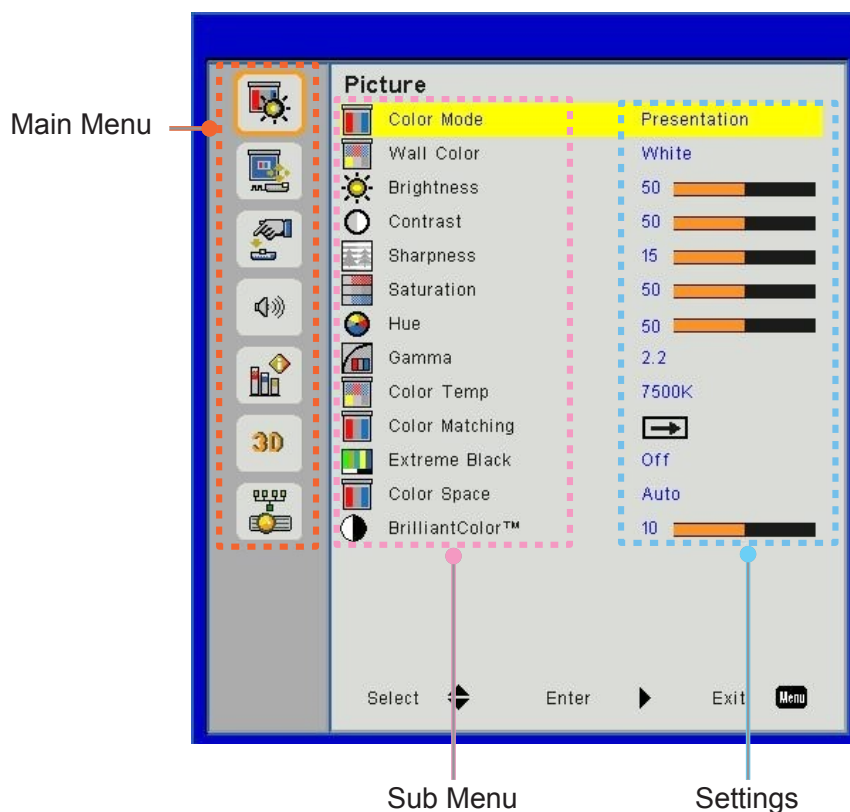



# USER CONTROLS

## Structure

**Note:** Please note that the on-screen display (OSD) menus vary according to the signal type selected and the projector model you are using.

Main Menu	Sub Menu	Setting	
Picture	Color Mode	Bright/Presentation/Movie/sRGB/Blending/DICOM SIM./User (Change Color Mode to User Mode if customer changes the settings)	
	Wall Color	White/ Light Yellow/ Light Blue/ Pink/ Dark Green	
	Brightness		
	Contrast		
	Sharpness		
	Saturation	(For VGA component signal only)	
	Hue	(VGA component signal only)	
	Gamma	Film/Graphics/1.8/2.0/2.2/2.6/Blackboard/DICOM SIM	
	Color Temp	5500K/6500K/7500K/8500K/9500K	
	Color Matching	White/Red/ Green/Blue/Cyan/ Magenta/Yellow	Hue/ Saturation /Gain
	Extreme Black		On / Off
	Color Space		Not HDMI Input: Auto/RGB/YUV HDMI Input: Auto/RGB(0~255)/RGB(16~235)/YUV
	BrilliantColor™		1~10
Screen	Aspect Ratio	Auto/4:3/16:9/16:10	
	Phase		
	Clock		
	H.Position		
	V.Position		
	Digital Zoom		
	Projection		Front/Front Ceiling/Rear/Rear Ceiling
	Geometric Correction	V. Keystone	
		H. Keystone	
		4 Corners	On/Off
		Grid Color	Purple/Green
		Reset	Yes/No
	PIP-PBP Settings	Function	PBP/PIP/ Off
		Main Source	VGA/HDMI-1/HDMI-2/HDBaseT
		Sub Source	VGA/HDMI-1/HDMI-2/HDBaseT
		Location	Top Left/Top Right/Bottom Left/Bottom Right
		Size	Small/Medium/Large
Swap			

# USER CONTROLS

Main Menu	Sub Menu	Setting
Settings	Language	English/German/French/Italian/Spanish/Polish/Swedish/Dutch/Portugese/Japanese/Traditional Chinese/ Simplified Chinese /Korean/Russian/Arabic/Norsk/Turkish/Danish/Finnish/Greek/Hungarian/Czech/Romania/Thai/Farsi/Vietnam /Indonesian/Slovakian
	Menu Location	Left Top, Right Top, Center, Left Bottom, Right Bottom
	VGA OUT (Standby)	Off/On
	LAN (Standby)	Off/On
	Test Pattern	None / Grid / White
	Direct Power On	On/Off
	Signal Power On	On/Off
	Reset to Default	Yes/No
Volume	Speaker	On/Off
	Audio Out	On/Off
	Microphone	On/Off
	Mute	On/Off
	Volume	
	Microphone Volume	
	EQ	

# USER CONTROLS

Main Menu	Sub Menu	Setting		
Options	Logo		Default/User	
	Logo Capture			
	Auto Source		On/Off	
	Input		VGA, HDMI-1, HDMI-2, HDBaseT	
	Auto Power Off (Min.)			
	Sleep Timer (Min.)			
	SSI Settings			SSI Hours Used (Normal)
				SSI Hours Used (ECO)
		SSI Power Mode		Normal,ECO
	High Altitude	On/Off		[Default Off]
	Optional Filter Settings	Optional Filter Installed		Yes/No
		Filter Usage Hours		Read-Only
		Filter Reminder		
		Cleaning Up Reminder		Yes/No
	Security	Security		On / Off
		Security Timer		Month / Day / Hour
		Change Password		
	Remote Settings	IR Function		On / Off
		Remote Code		00 ~ 99
	HDBaseT Control	Auto		
		HDBaseT		
	PIP-PBP Module			Version
				HDMI EQ
				Reset
				USB Upgrade
	Information Hide	On / Off		
	Information			Model Name
				SNID
				Source (Main Source / Sub Source)
				Main Source Resolution
				Sub Source Resolution
				SW Version (DDP/MCU/LAN)
				Aspect Ratio
			SSI Hours (Normal/Eco)	
			IP Address	
			Network Status	
			Remote Code	
			Remote Code (Active)	

# USER CONTROLS

Main Menu	Sub Menu	Setting		
3D	3D		Auto/On	
	3D Invert		On/Off	
	3D Format			Frame Packing
				Side-by-Side (Half)
				Top and Bottom
				Frame Sequential
			Field Sequential	
1080p @ 24			96Hz/144Hz	
Network	Status			
	DHCP Client		On/Off	
	IP Address			
	Subnet Mask			
	Gateway			
	DNS			
	Store			
	MAC Address			
	Group Name			
	Projector Name			
	Location			
	Contact			

# USER CONTROLS

## **Picture**

### **Color Mode**

There are many factory presets optimized for various types of images. Use the ◀ or ▶ button to select the item.

- Bright: For brightness optimization.
- Presentation: For meeting presentation.
- Movie: For playing video content.
- sRGB: For game content.
- Blending: For blending application.
- DICOM Sim:
- User: Memorize user's settings.

### **Wall Color**

Use this function to obtain an optimized screen image according to the wall color. You can select from "White", "Light Yellow", "Light Blue", "Pink", and "Dark Green".

### **Brightness**

Adjust the brightness of the image.

- Press the ◀ button to darken image.
- Press the ▶ button to brighten image.

### **Contrast**

The Contrast controls the difference between the lightest and darkest parts of the picture. Adjusting the contrast changes the amount of black and white in the image.

- Press the ◀ button to decrease the contrast.
- Press the ▶ button to increase the contrast.

### **Sharpness**

Adjust the sharpness of the image.

- Press the ◀ button to decrease the sharpness.
- Press the ▶ button to increase the sharpness.

**Note:** "Sharpness", "Sat-uration" and "Hue" functions are only supported under video mode.

# USER CONTROLS

## **Saturation**

Adjust a video image from black and white to fully saturated color.

- Press the ◀ button to decrease the amount of saturation in the image.
- Press the ▶ button to increase the amount of saturation in the image.

**Note:** *Saturation is only supported for VGA source (480i/480p 576i/675p 720P 1080i/1080p)*

## **Hue**

Adjust the color balance of red and green.

- Press the ◀ button to increase the amount of green in the image.
- Press the ▶ button to increase the amount of red in the image.

**Note:** *Hue is only supported for VGA source (480i/480p 576i/675p 720P 1080i/1080p)*

## **Gamma**

This allows you to adjust the gamma value to obtain the better image contrast for the input.

## **Color Temp**

This allows you to adjust the color temperature. At higher temperature, the screen looks colder; at lower temperature, the screen looks warmer.

## **Color Maching**

Use these settings for advanced adjustment of the individual Red, Green, Blue, Cyan, Magenta and Yellow and White Colors.

## **Extreme Black**

Use this function to increase the contrast ratio.

## **Color Space**

Select an appropriate color matrix type from AUTO, RGB, RGB(0-255), RGB(16-235) or YUV.

**Note:** *“RGB (0-255)” and “RGB (16-235)” are only supported for HDMI source.*

## **BrilliantColor™**

This adjustable item utilizes a new color-processing algorithm and enhancements to enable higher brightness while providing true, more vibrant colors in picture.

# USER CONTROLS

## Screen

### Aspect Ratio

- Auto: Keep the image with original width-height ratio and maximize the image to fit native horizontal or vertical pixels.
- 4:3: The image will be scaled to fit the screen and displayed using a 4:3 ratio.
- 16:9: The image will be scaled to fit the width of the screen and the height adjusted to display the image using a 16:9 ratio.
- 16:10: The image will be scaled to fit the width of the screen and the height adjusted to display the image using a 16:10 ratio.

### Phase

Synchronize the signal timing of the display with the graphic card. If the image appears to be unstable or flickers, use this function to correct it.

**Note:** Phase, Clock, H. Position, V. Position adjustment only support VGA Graphic.

### Clock

Adjust to achieve an optimal image when there is a vertical flicker in the image.

### H. Position

- Press the ◀ button to move the image left.
- Press the ▶ button to move the image right.

### V. Position

- Press the ◀ button to move the image down.
- Press the ▶ button to move the image up.

### Digital Zoom

- Press the ◀ button to reduce the size of an image.
- Press the ▶ button to magnify an image on the projection screen.

### Projection

- Front: The image is projected straight on the screen.
- Front Ceiling: This is the default selection. When selected, the image will turn upside down.
- Rear: When selected, the image will appear reversed.
- Rear Ceiling: When selected, the image will appear reversed in upside down position.

### Geometric Correction

- H Keystone  
Press the ◀ or ▶ button to adjust image distortion horizontal. If the image looks trapezoidal, this option can help make the image rectangular.
- V Keystone  
Press the ◀ or ▶ button to adjust image distortion vertically. If the image looks trapezoidal, this option can help make the image rectangular.
- 4 Corners  
Adjust the image 4 corners pixel by pixel to make the image rectangular.
- Grid Color  
Set 4 corners correction function grid color.
- Reset  
Set H/V Keystone, 4 corners parameters to default values.

### PIP-PBP Settings

- Function: To enable/disable PIP/PBP function.
- Main Source: To set PIP/PBP main source.
- SUB Source: To set PIP/PBP sub source.

# USER CONTROLS

- Location: To set PIP sub source location.
- Size: To set PIP sub source size.
- Swap: To swap PIP/PBP main/sub source.

Some source/signal combinations may not be compatible with PIP/PBP function. Please refer to the table below:

<b>Matrix</b>	HDMI-1	HDMI-2	HDBaseT	VGA
HDMI-1	-	V	-	V
HDMI-2	V	-	V	V
HDBaseT	-	V	-	V
VGA	V	V	V	-

1. Flashing lines may occur if the bandwidth of both inputs are too high, please try to reduce the resolution.
2. Frame tearing may occur due to a difference in frame rate between the Main and the Sub picture, please try to match the frame rate for each input.



# USER CONTROLS

## Settings

### Language

Choose the multilingual OSD menu. Press the ◀ or ▶ button into the sub menu and then use the ▲ or ▼ button to select your preferred language. Press ▶ on the remote control to finalize the selection.



### Menu Location

Choose the menu location on the display screen.

### VGA Output (Standby)

Choose "On" to enable VGA OUT connection.

### LAN (Standby)

Choose "On" to enable LAN connection. Choose "Off" to disable LAN connection.

### Test Pattern

Display a test pattern.

### Direct Power On

Choose "On" to activate Direct Power mode. The projector will automatically power on when AC power is supplied, without pressing the ⏻ key on the projector control panel or on the remote control.

### Signal Power On

If Signal Power On is set to ON the projector will wake up automatically from standby mode if the input source is changed from inactive to active.

### Reset

Choose "Yes" to return the parameters on all menus to the factory default settings.

# USER CONTROLS

## *Volume*

### **Speaker**

- Choose “On” to enable the speaker.
- Choose “Off” to disable the speaker.

### **Line Out**

- Choose “On” to enable the line out function.
- Choose “Off” to disable the line out function.

### **Microphone**

- Choose “On” to enable the microphone.
- Choose “Off” to disable the microphone.

### **Mute**

- Choose “On” to turn mute on.
- Choose “Off” to turn mute off.

### **Volume**

- Press the ◀ button to decrease the volume.
- Press the ▶ button to increase the volume.

### **Microphone Volume**

- Press the ◀ button to decrease the microphone volume.
- Press the ▶ button to increase the microphone volume.

### **EQ**

Set audio EQ values.

# USER CONTROLS

## Options

### Logo

Use this function to set the desired startup screen. If changes are made they will take effect the next time the projector is powered on.

- Default: The default startup screen.
- User: Use stored picture from “Logo Capture” function.

### Logo Capture

Press ► button to capture an image of the picture currently displayed on screen.

### Note:

“Logo Capture” is not available when 3D is enabled.

Before active this function, it is recommended that “Aspect Ratio” is set to the “Auto”.

### Auto Source

- On: The projector will search for other signals if the current input signal is lost.
- Off: The projector will only search current input connection.

### Input

Press ► button to enable/disable input sources. The projector will not search for inputs that are not selected.

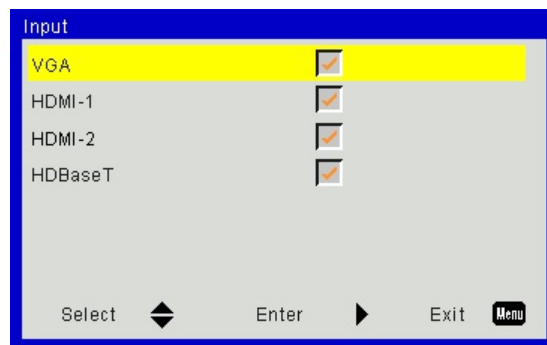

### Auto Power Off (Min)

Sets the countdown timer interval. The countdown timer will start, when there is no signal being sent to the projector. The projector will automatically power off when the countdown has finished (in minutes).

### Sleep Timer

Sets the countdown timer. The countdown timer will start, with or without a signal being sent to the projector. The projector will automatically power off when the countdown has finished (in minutes).

### SSI Settings

- SSI Hours Used (Normal)  
Display the projection time of normal mode.
- SSI Hours Used (ECO)  
Display the projection time of ECO mode.
- SSI Power Mode  
Normal: Normal mode.  
ECO: Use this function to dim the projector SSI which will lower power consumption and extend the SSI life.

### High Altitude

- On: The built-in fans run at high speed. Select this option when using the projector at altitudes above 2500 feet/762 meters or higher.
- Off: The built-in fans automatically run at a variable speed according to the internal temperature.

# USER CONTROLS

## Optional Filters Remind (Hour)

- Optional Filter Installed: Filter is installed or not.
- Filter Usage Hours: Hours of filter had been used.
- Filters Remind (Hour): Set the filter reminder time.
- Cleaning Up Remind: Select “Yes” to reset the dust filter hour counter after replacing or cleaning the dust filter.

## Security

- Security: Choose “On” to use security verification when turning on projector. Choose “Off” to be able to switch on the projector without password verification.
- Security Timer  
Use this function to set the how long (Month/Day/Hour) the projector can be used. Once this time has elapsed you will be requested to enter your password again.
- Change Password  
First time:
  1. Press “←” to set the password.
  2. The password has to be 6 digits.
  3. Use number button on the remote to enter your new password and then press “←” key to confirm your password.Change Password:
  1. Press “←” to input old password.
  2. Use number button to enter current password and then press “←” to confirm.
  3. Enter new password (6 digits in length) using the number buttons on the remote, then press “←” to confirm.
  4. Enter new password again and press “←” to confirm.
- If the incorrect password is entered 3 times, the projector will automatically shut down.
- If you have forgotten your password, please contact the dealer for support.

### **Note:**

*Password default value is “000000” (first time).*

*Always keep the password in your files. If the password is forgotten or lost, please contact your local authorized service center.*

# USER CONTROLS

## **Remote Setting**

- IR function: When this function is “Off”, the projector cannot be operated by the remote control.
- Remote code: 00~99, default code (common code): 00

### **Note:**

*How to set remote controller to the remote code.*

- 1. Press remote controller “ID” Key for 5 secs*
- 2. Press remote controller the number button (XX)*

*For example, if user would like to set remote controller to map remote code setting value 2, press ID Key for 5 seconds and then press 02.*

## **HDBaseT Control**

The projector will automatically detect the signal from HDBaseT transmitter supplied. Choose “HDBaseT” to activate Direct Power mode.

## **PIP-PBP Module**

- Version: Show PIP-PBP module software version.
- Reset: Reset the PIP-PBP module.
- USB Upgrade: Upgrade the PIP-PBP module software.
- HDMI EQ: Set PIP-PBP module HDMI port EQ value.

## **Information Hide**

- On: Choose “On” to hide the info message.
- Off: Choose “Off” to show the “info” message.

## **Information**

Display the projector information for model name, SNID, source, resolution, software version, aspect ratio, SSI Hours, IP Address and Network Status on the screen.

# USER CONTROLS

## 3D

### 3D

Auto: When a HDMI 1.4a 3D timing identification signal is detected, the 3D image is selected automatically.

- Choose "On" to enable 3D function.
- Choose "Auto" to detected 3D signal automatically.

### 3D Invert

If you see a discrete or overlapping image while wearing DLP 3D glasses, you may need to execute "Invert" to get best match of left/right image sequence to get the correct image.

### 3D Format

Use this feature to select the 3D format. Options are: "Frame Packing", "Side-by-Side (Half)", "Top and Bottom", "Frame Sequential".

### 1080p@24

Use this feature to select 96 or 144Hz refresh rate as using 3D glasses in the 1080p @ 24 frame packing.

# USER CONTROLS

## LAN

### **Status**

Display the network connection status.

### **DHCP**

Configure the DHCP settings.

- On: Choose “On” to let the projector to obtain an IP address automatically from your network.
- Off: Choose “Off” to assign IP, Subnet Mask, Gateway, and DNS configuration manually.

### **IP Address**

Display an IP address.

### **Subnet Mask**

Display the subnet mask number.

### **Gateway**

Display the default gateway of the network connected to the projector.

### **DNS**

Display the DNS number.

### **MAC Address**

Display the MAC address.

### **Group Name**

Display the group name.

### **Projector Name**

Display the projector name.

### **Location**

Display the projector location.

### **Contact**

Display the contact information.

# APPENDICES

## Projector Problems

### ? The projector stops responding to all controls

- ▶ If possible, turn off the projector, then unplug the power cord and wait at least 60 seconds before reconnecting power.
- ▶ Check that “Keypad Lock” is not activated by trying to control the projector with the remote control.

### ? If the remote control does not work

- ▶ Check if the operating angle of the remote control is within  $\pm 30^\circ$  both horizontally and vertically on one of the IR receivers on the projector.
- ▶ Make sure there is no obstruction between the remote control and the projector. Move to within 12 m ( $\pm 0^\circ$ ) of the projector.
- ▶ Make sure the batteries are inserted correctly.
- ▶ Replace batteries if they are exhausted.
- ▶ Ensure that you have set your remote to the correct IR code setting.

### ? When making a direct connection from your computer to the projector

- ▶ If you have network connection problem from your computer to the projector, please refer to the computer setting as below or contact with web administrator.

Step 1: Find an IP Address (192.168.0.100) from LAN function of projector.



Step 2: Select “Apply” and push the “Enter” button. Once the setting is saved, exit the OSD by pushing “Menu” button.

Step 3: To open Network Connections, click **Start**, click **Control Panel**, click **Network and Internet Connections**, and then click **Network Connections**. Click the connection you want to configure, and then, under **Network Tasks** , click **Change settings of this connection**.

Step 4: On the **General** tab, under **This connection use the following items**, click Internet Protocol(TCP/IP), and then click “**Properties**”.

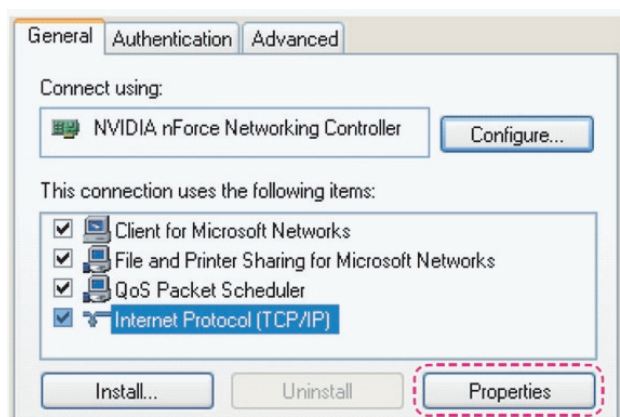



# APPENDICES

Step 5: Click **Use the following IP address**, and type in as below:

- 1) IP address: 192.168.0.101
- 2) Subnet mask: 255.255.255.0
- 3) Default gateway: 192.168.0.254

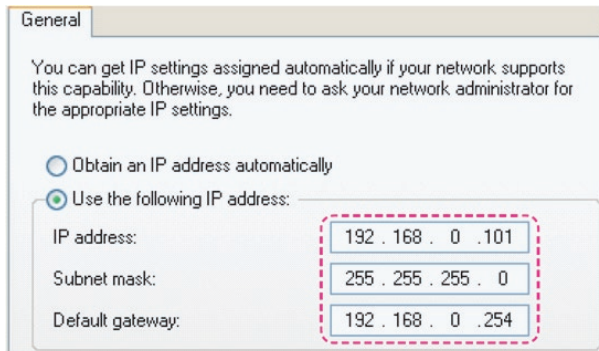

Step 6: To open Internet Options, click IE web browser, click Internet Options, click the **Connections** tab and click **“LAN Setting...”**.



Step 7: All items in the **Local Area Network (LAN) Setting** window must unchecked. Then click **“OK”** button twice.

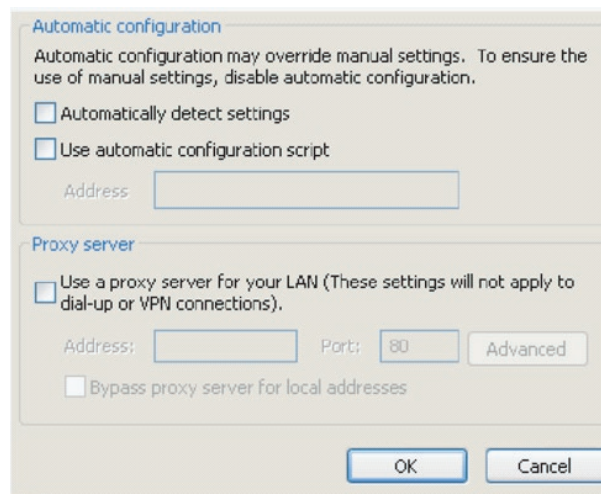

Step 8: Open your IE and type in the IP address of 192.168.0.100 in the URL then press **“Enter”** key.

# APPENDICES

## How to use web browser to control your projector

1. Turn on DHCP to allow a DHCP server to automatically assign an IP, or manually enter the required network information.



2. Then choose apply and press **OK** button to complete the configuration process.
3. Open your web browser and type in IP Address from the OSD LAN screen then the web page will display as below:



**Note:** When you used the projector IP address, you will can not link to your service server.

4. Based on network web-page for the input-string in [tools] tab, the limitation for Input-Length is in the below list (“space” and the other punctuation key included):

Category	Item	Input-Length (characters)
Crestron Control	IP Address	15
	IP ID	2
	Port	5
Projector	Projector Name	10
	Location	9
	Assigned To	9
Network Configuration	DHCP (Enabled)	(N/A)
	IP Address	15
	Subnet Mask	15
	Default Gateway	15
	DNS Server	15
User Password	Enabled	(N/A)
	New Password	15
	Confirm	15
Admin Password	Enabled	(N/A)
	New Password	15
	Confirm	15

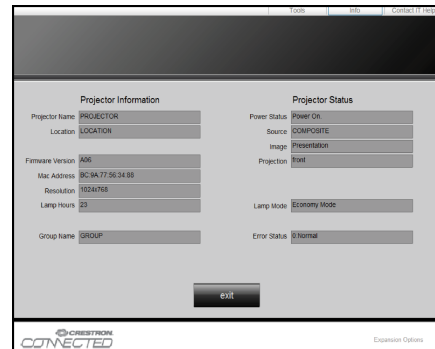

# APPENDICES

## Crestron RoomView Control Tool

Crestron RoomView™ provides a central monitoring station for 250+ control systems on a single Ethernet network (more are possible, the number depends on the combination of IP ID and IP address). Crestron RoomView monitors each projector, including projector's online status, system power, light source life, network setting and hardware faults, plus any custom attribute as defined by the Administrator.

The Administrator can add, delete, or edit room information, contact information and events, which are logged automatically by the software for all users. (Operation UI as following image)

**Note:** Crestron RoomView function support is dependent on models.

### 1. Main Screen

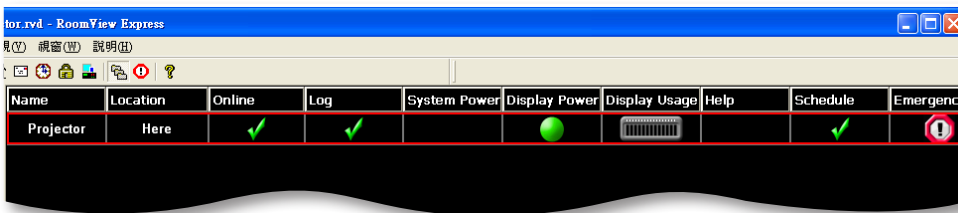

### 2. Edit Room

On the "Edit Room" page, enter the IP Address (or hostname) as shown on the projector's on-screen display (OSD) menu, and "02" for IPID, "41794" for the reserved Crestron control port.

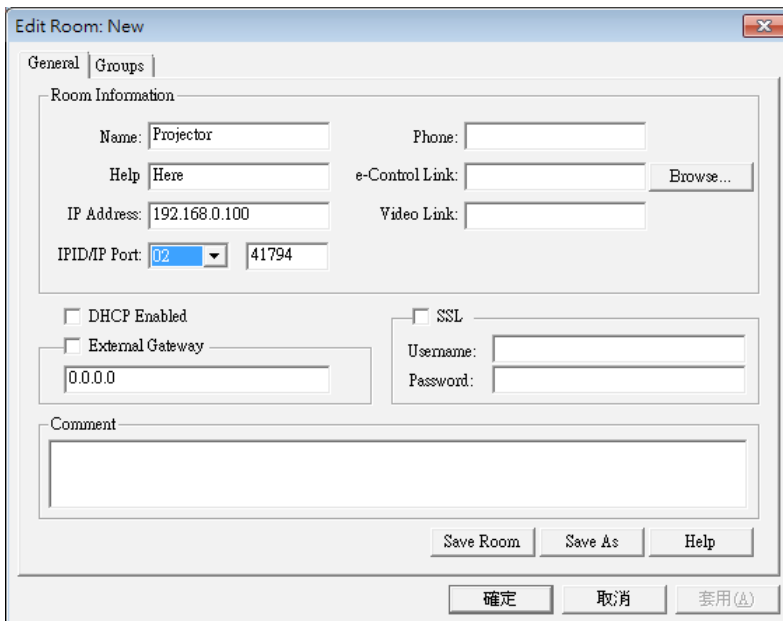

About Crestron RoomView™ setting and command method, please access below website to get RoomView™ User Guide and more information:

<http://www.crestron.com>

# APPENDICES

## 3. Edit Attribute

**Edit Attribute: New**

General | Alert | Groups | Rooms | Contacts

Attribute Properties

Signal Name:  Graphic: Off On

Device:

Signal Type:

Join Number:  Default Max. Value:

Options

Apply attribute to all rooms  Display on main view  
 Apply attribute to all contacts  Show on context menu   
 Record attribute changes to log

## 4. Edit Event

**Edit Event: Display Off**

General | Rooms

Event Properties

Name:   Enable this event  
Type:   Repeat event  
Join:

Schedule

Start Date:   Weekdays  Weekends  
End Date:   Monday  Saturday  
Time:   Tuesday  Sunday  
 Wednesday  
 Thursday  
 Friday

**For more information, please visit**  
**<http://www.crestron.com> & [www.crestron.com/getroomview](http://www.crestron.com/getroomview).**

**Network supports Crestron (Room View), AMX (Device Discovery) , PJLink and RS232 control.**

# APPENDICES

## Installing and Cleaning the Optional Dust Filter

We recommend you clean the dust filter every 500 hours of operation, or more often if you are using the projector in a dusty environment.

When the warning message appears on the screen, do the following to clean the air filter:



**Note:**

*The optional dust filter should be used in dusty environments.*

*If the dust filter is installed, a proper maintenance will prevent overheating and projector malfunction.*

*The dust filter is optional.*

*The specific interfaces are selected in terms of the specifications of types.*

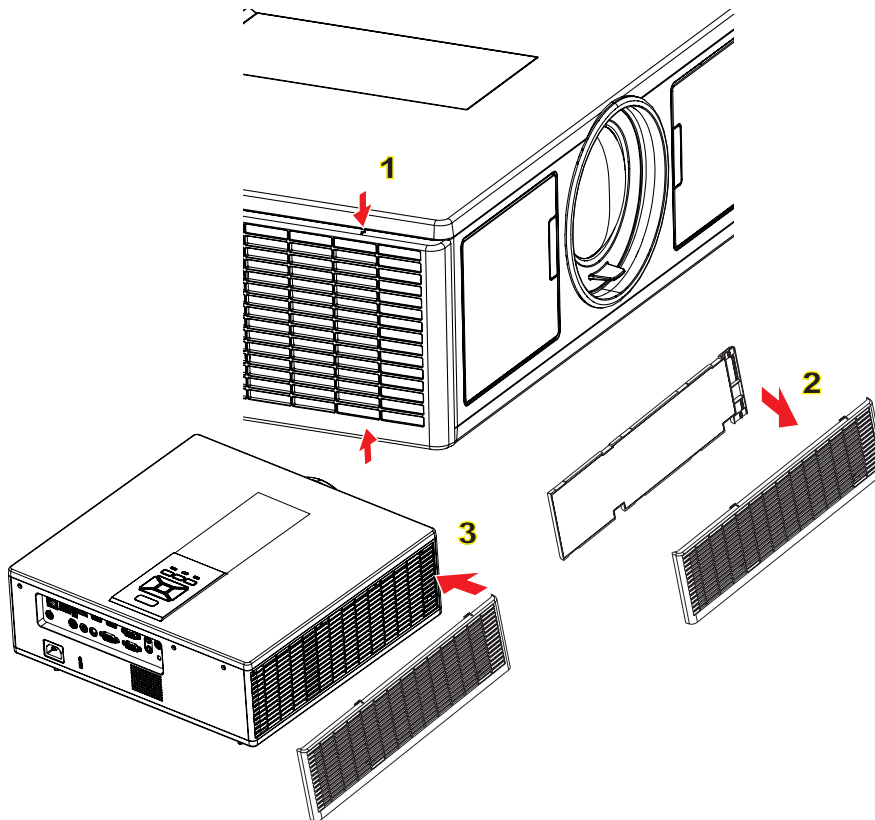

**Air Filter Cleaning Procedure:**

1. Switch off the power to the projector by pressing the "⏻" button.
2. Disconnect the power cord.
3. Pull out the dust filter, as shown in the illustration. ①
4. Carefully remove the dust filter. Then clean or change the filter. ②

**To install the filter, reverse the previous steps.**

5. Turn on the projector and reset the filter usage counter after the dust filter is replaced.

# APPENDICES

## Compatibility Modes

A. VGA Analog					
(1) PC Signal					
Modes	Resolution	V.Frequency [Hz]	H.Frequency [KHz]	Pixel CLK [MHz]	EDID Description
VGA	640x480	60	31.5	25.2	Established Timings 1
	640x480	67	35.0	26.8	Established Timings 1
	640x480	72	37.9	31.5	Established Timings 1
	640x480	75	37.5	31.5	Established Timings 1
	640x480	85	43.3	36.0	
IBM	720x400	70	31.5	28.3	Established Timings 1
SVGA	800x600	56	35.1	36.0	Established Timings 1
	800x600	60	37.9	40.0	Established Timings 1
	800x600	72	48.1	50.0	Established Timings 2
	800x600	75	46.9	49.5	Established Timings 2
	800x600	85	53.7	56.3	
Apple, Mac II	832x624	75	49.1	57.3	Established Timings 2
XGA	1024x768	60	48.4	65.0	WXGA: Established Timings 2 XGA: Established Timings 2 and (Native)Detailed Timing / Descriptor Block 1
	1024x768	70	56.5	75.0	Established Timings 2
	1024x768	75	60.0	78.8	Established Timings 2
	1024x768	85	68.7	94.5	
	1024x768	120	99.0	137.8	Standard Timing Identification
Apple, Mac II	1152x870	75	68.7	100.0	Manufacturer's Reserved Timing
SXGA	1280x1024	60	64.0	108.0	
	1280x1024	72	77.0	133.0	
	1280x1024	75	80.0	135.0	Established Timings 2
QuadVGA	1280x960	60	60.0	101.3	Standard Timing Identification
	1280x960	75	75.2	130.0	
SXGA+	1400x1050	60	65.3	121.8	
UXGA	1600x1200	60	75.0	161.0	Standard Timing Identification
Full HD	1920x1080	60	67.5	148.5	
WUXGA	1920x1200	60	74	154	Reduced Blanking
(2) Extended Wide timing					
WXGA	1280x720	60	44.8	74.2	Standard Timing Identification
	1280x800	60	49.6	83.5	WXGA: (Native)Detailed Timing / Descriptor Block 1 XGA: Standard Timing Identification
	1366x768	60	47.7	84.8	
	1440x900	60	59.9	106.5	Standard Timing Identification
WSXGA+	1680x1050	60	65.3	146.3	WXGA: Standard Timing Identification XGA: N/A
	1920x720	60	44.35	92.25	
(3) Component Signal					
480i	720x480 (1440x480)	59.94(29.97)	15.7	13.5	

# APPENDICES

576i	720x576 (1440x576)	50(25)	15.6	13.5	
480p	720x480	59.94	31.5	27.0	
576p	720x576	50	31.3	27.0	
720p	1280x720	60	45.0	74.25	
720p	1280x720	50	37.5	74.25	
1080i	1920x1080	60(30)	33.8	74.25	
1080i	1920x1080	50(25)	28.1	74.25	
1080p	1920x1080	23.98/24	27.0	74.25	
1080p	1920x1080	60	67.5	148.5	
1080p	1920x1080	50	56.3	148.5	
<b>B. HDMI Digital</b>					
<b>(1) PC Signal</b>					
<b>Modes</b>	<b>Resolution</b>	<b>V.Frequency [Hz]</b>	<b>H.Frequency [KHz]</b>	<b>Pixel CLK [MHz]</b>	<b>EDID Description</b>
VGA	640x480	60	31.5	25.2	Established Timings 1
	640x480	67	35.0	26.8	Established Timings 1
	640x480	72	37.9	31.5	Established Timings 1
	640x480	75	37.5	31.5	Established Timings 1
	640x480	85	43.3	36.0	
IBM	720x400	70	31.5	28.3	Established Timings 1
SVGA	800x600	56	35.1	36.0	Established Timings 1
	800x600	60	37.9	40.0	Established Timings 1
	800x600	72	48.1	50.0	Established Timings 2
	800x600	75	46.9	49.5	Established Timings 2
	800x600	85	53.7	56.3	
Apple, Mac II	832x624	75	49.1	57.3	Established Timings 2
XGA	1024x768	60	48.4	65.0	WXGA: Established Timings 2 XGA: Established Timings 2 and (Native)Detailed Timing / Descriptor Block 1
	1024x768	70	56.5	75.0	Established Timings 2
	1024x768	75	60.0	78.8	Established Timings 2
	1024x768	85	68.7	94.5	
	1024x768	120	99.0	137.8	Standard Timing Identification
Apple, Mac II	1152x870	75	68.7	100.0	Manufacturer's Reserved Timing
SXGA	1280x1024	60	64.0	108.0	
	1280x1024	72	77.0	133.0	
	1280x1024	75	80.0	135.0	Established Timings 2
QuadVGA	1280x960	60	60.0	101.3	Standard Timing Identification
	1280x960	75	75.2	130.0	
SXGA+	1400x1050	60	65.3	121.8	
UXGA	1600x1200	60	75.0	161.0	Standard Timing Identification
Full HD	1920x1080	60	67.5	148.5	
WUXGA	1920x1200	60	74	154	Reduced Blanking
<b>(2) Extended Wide timing</b>					

# APPENDICES

WXGA	1280x720	60	44.8	74.2	Standard Timing Identification
	1280x800	60	49.6	83.5	WXGA: (Native)Detailed Timing / Descriptor Block 1 XGA: Standard Timing Identification
	1366x768	60	47.7	84.8	
	1440x900	60	59.9	106.5	Standard Timing Identification
WSXGA+	1680x1050	60	65.3	146.3	WXGA: Standard Timing Identification XGA: N/A
	1920x720	60	44.35	92.25	
<b>(3) HDMI - Video Signal</b>					
640x480p	640x480	59.94/60	31.5	25.2	Short Video Descriptor of CEA EDID Timing
480i	720x480 (1440x480)	59.94(29.97)	15.7	13.5	Short Video Descriptor of CEA EDID Timing
576i	720x576 (1440x576)	50(25)	15.6	13.5	Short Video Descriptor of CEA EDID Timing
480p	720x480	59.94	31.5	27.0	Short Video Descriptor of CEA EDID Timing
576p	720x576	50	31.3	27.0	Short Video Descriptor of CEA EDID Timing
720p	1280x720	60	45.0	74.25	(Native)Short Video Descriptor of CEA EDID Timing
720p	1280x720	50	37.5	74.25	(Native)Short Video Descriptor of CEA EDID Timing
1080i	1920x1080	60(30)	33.8	74.25	Short Video Descriptor of CEA EDID Timing
1080i	1920x1080	50(25)	28.1	74.25	Short Video Descriptor of CEA EDID Timing
1080p	1920x1080	23.98/24	27.0	74.25	Short Video Descriptor of CEA EDID Timing
1080p	1920x1080	60	67.5	148.5	Short Video Descriptor of CEA EDID Timing
1080p	1920x1080	50	56.3	148.5	Short Video Descriptor of CEA EDID Timing
<b>(4) HDMI 1.4a mandatory 3D timing- Video Signal</b>					
Frame Packing	720p	50	75	148.5	Short Video Descriptor of CEA EDID Timing
	720p	59.94/60	90	148.5	Short Video Descriptor of CEA EDID Timing
	1080p	23.98/24	54	148.5	Short Video Descriptor of CEA EDID Timing
Top-and-Bottom	720p	50	37.5	74.25	Short Video Descriptor of CEA EDID Timing
	720p	59.94/60	45.0	74.25	Short Video Descriptor of CEA EDID Timing
	1080p	23.98/24	27.0	74.25	Short Video Descriptor of CEA EDID Timing
<b>(5) Input signal frequency range</b> Analog: fh=15kHz~100kHz, fv=24Hz~120Hz, Max. pixel rate: 162.5MHz Digital (HDMI): fh=15kHz~100kHz, fv=24Hz~120Hz, Max. pixel rate: 200MHz					



# APPENDICES

## Ceiling Mount Installation

1. To prevent damage to your projector, please use the Optoma ceiling mount.
2. If you wish to use a third party ceiling mount kit, please ensure the screws used to attach a mount to the projector meet the following specifications:
  - Screw type: M4\*4
  - Minimum screw length: 14mm

**Note:** Please note that damage resulting from incorrect installation will void the warranty.

**Warning:**

1. If you buy a ceiling mount from another company, please be sure to use the correct screw size. Screw size will vary depending on the thickness of the mounting plate.
2. Be sure to keep at least 10 cm gap between the ceiling and the bottom of the projector.
3. Avoid installing the projector near a heat source.

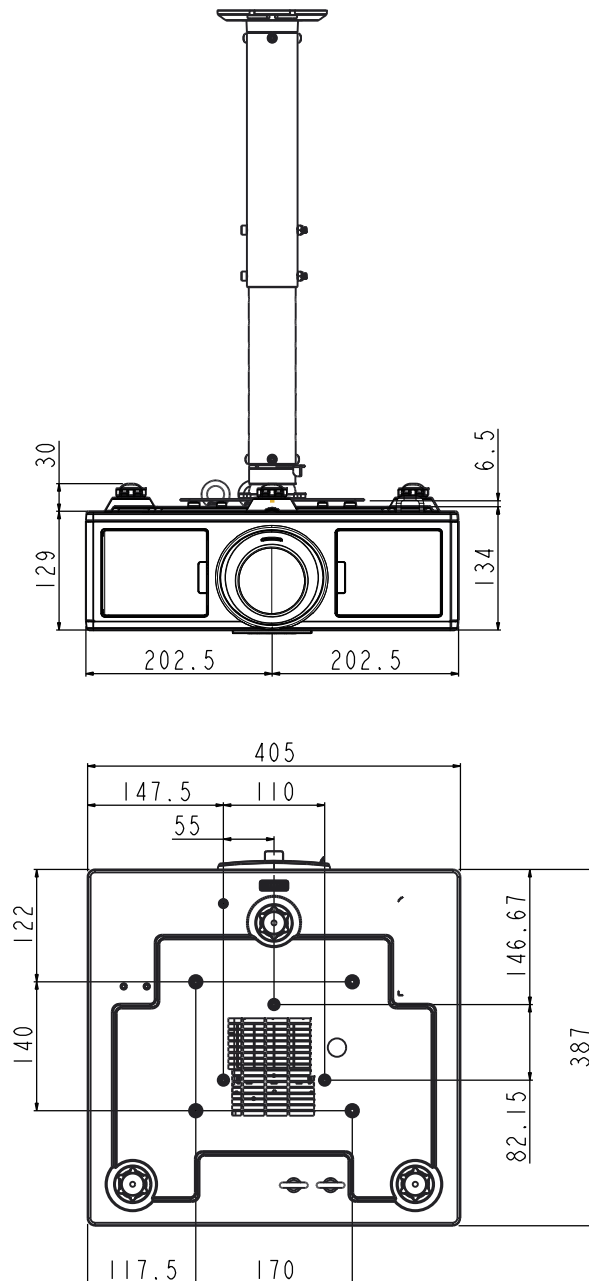

# APPENDICES

## Optoma global offices

For service or support, please contact your local office.

### USA

3178 Laurelview Ct.  
Fremont, CA 94538, USA  
www.optomausa.com

☎ 888-289-6786  
📠 510-897-8601  
✉ [services@optoma.com](mailto:services@optoma.com)

### Canada

3178 Laurelview Ct.  
Fremont, CA 94538, USA  
www.optomausa.com

☎ 888-289-6786  
📠 510-897-8601  
✉ [services@optoma.com](mailto:services@optoma.com)

### Latin America

3178 Laurelview Ct.  
Fremont, CA 94538, USA  
www.optomausa.com

☎ 888-289-6786  
📠 510-897-8601  
✉ [services@optoma.com](mailto:services@optoma.com)

### Europe

Unit 1, Network 41, Bourne End Mills  
Hemel Hempstead, Herts,  
HP1 2UJ, United Kingdom  
www.optoma.eu  
Service Tel : +44 (0)1923 691865

☎ +44 (0) 1923 691 800  
📠 +44 (0) 1923 691 888  
✉ [service@tsc-europe.com](mailto:service@tsc-europe.com)

### Benelux BV

Randstad 22-123  
1316 BW Almere  
The Netherlands  
www.optoma.nl

☎ +31 (0) 36 820 0252  
📠 +31 (0) 36 548 9052

### France

Bâtiment E  
81-83 avenue Edouard Vaillant  
92100 Boulogne Billancourt,  
France

☎ +33 1 41 46 12 20  
📠 +33 1 41 46 94 35  
✉ [savoptoma@optoma.fr](mailto:savoptoma@optoma.fr)

### Spain

C/ José Hierro,36 Of. 1C  
28522 Rivas VaciaMadrid,  
Spain

☎ +34 91 499 06 06  
📠 +34 91 670 08 32

### Deutschland

Wiesenstrasse 21 W  
D40549 Düsseldorf,  
Germany

☎ +49 (0) 211 506 6670  
📠 +49 (0) 211 506 66799  
✉ [info@optoma.de](mailto:info@optoma.de)

### Scandinavia

Lerpeveien 25  
3040 Drammen  
Norway

☎ +47 32 98 89 90  
📠 +47 32 98 89 99  
✉ [info@optoma.no](mailto:info@optoma.no)

PO.BOX 9515  
3038 Drammen  
Norway

### Korea

WOOMI TECH.CO.,LTD.  
4F,Minu Bldg.33-14, Kangnam-Ku,  
seoul,135-815, KOREA

☎ +82+2+34430004  
📠 +82+2+34430005

### Japan

東京都足立区綾瀬3-25-18  
株式会社オーエス  
コンタクトセンター:0120-380-495

✉ [info@os-worldwide.com](mailto:info@os-worldwide.com)  
www.os-worldwide.com

### Taiwan

12F., No. 213,Sec. 3, Beixin Rd.,  
Xindian Dist., New Taipei City 231,  
Taiwan, R.O.C.  
www.optoma.com.tw

☎ +886-2-8911-8600  
📠 +886-2-8911-6550  
✉ [services@optoma.com.tw](mailto:services@optoma.com.tw)  
asia.optoma.com

### Hong Kong

Unit A, 27/F Dragon Centre,  
79 Wing Hong Street,  
Cheung Sha Wan,  
Kowloon, Hong Kong

☎ +852-2396-8968  
📠 +852-2370-1222  
www.optoma.com.hk

### China

5F, No. 1205, Kaixuan Rd.,  
Changning District  
Shanghai, 200052, China

☎ +86-21-62947376  
📠 +86-21-62947375  
www.optoma.com.cn

