

PCA³

Portable Combustion Analyzer

Operation and Maintenance Manual
Instruction 0024-9472
Rev. 3 – August 2014



WARRANTY POLICY

Bacharach, Inc. warrants to Buyer that at the time of delivery this Product will be free from defects in material and manufacture and will conform substantially to Bacharach Inc.'s applicable specifications. Bacharach's liability and Buyer's remedy under this warranty are limited to the repair or replacement, at Bacharach's option, of this Product or parts thereof returned to Seller at the factory of manufacture and shown to Bacharach Inc.'s reasonable satisfaction to have been defective; provided that written notice of the defect shall have been given by Buyer to Bacharach Inc. within two (2) years after the date of delivery of this Product by Bacharach, Inc. Routine service and calibration are excluded from this warranty.

Bacharach, Inc. warrants to Buyer that it will convey good title to this Product. Bacharach's liability and Buyer's remedy under this warranty of title are limited to the removal of any title defects or, at the election of Bacharach, to the replacement of this Product or parts thereof that are defective in title.

THE FOREGOING WARRANTIES ARE EXCLUSIVE AND ARE GIVEN AND ACCEPTED IN LIEU OF (I) ANY AND ALL OTHER WARRANTIES, EXPRESS OR IMPLIED, INCLUDING WITHOUT LIMITATION THE IMPLIED WARRANTIES OF MERCHANTABILITY AND FITNESS FOR A PARTICULAR PURPOSE: AND (II) ANY OBLIGATION, LIABILITY, RIGHT, CLAIM OR REMEDY IN CONTRACT OR TORT, WHETHER OR NOT ARISING FROM BACHARACH'S NEGLIGENCE, ACTUAL OR IMPLIED. The remedies of the Buyer shall be limited to those provided herein to the exclusion of any and all other remedies including, without limitation incidental or consequential damages. No agreement varying or extending the foregoing warranties, remedies or this limitation will be binding upon Bacharach, Inc. unless in writing, signed by a duly authorized officer of Bacharach.

**Register Your Warranty by Visiting
www.MyBacharach.com**

NOTICE

Product improvements and enhancements are continuous, therefore the specifications and information contained in this document may change without notice.

Bacharach, Inc. shall not be liable for errors contained herein or for incidental or consequential damages in connection with the furnishing, performance, or use of this material.

No part of this document may be photocopied, reproduced, or translated to another language without the prior written consent of Bacharach, Inc.

Copyright © 2014, Bacharach, Inc., all rights reserved.

BACHARACH, PCA, B-SMART, and FYRITE are registered trademarks of Bacharach, Inc. All other trademarks, trade names, service marks and logos referenced herein belong to their respective companies.

TABLE OF CONTENTS

CHAPTER 1. INTRODUCTION	7
1.1. About This Manual	7
1.2. Conventions	7
1.3. Safety	7
1.4. General Description	9
1.5. Operation Overview	9
1.5.1. Turning On the PCA® 3	9
1.5.2. The Combustion Test	10
1.5.3. Turning Off the PCA® 3	10
1.6. Features and Benefits	11
1.7. Sales Combo and Model Configurations	12
1.8. Specifications	13
CHAPTER 2. HARDWARE	15
2.1. Overview	15
2.2. Front Panel Buttons	16
2.3. Backlit Display	17
2.4. Battery Compartment	17
2.5. AC Adapter Connector (POWER)	17
2.6. Probe Connectors (Gas, Pressure, T-Stack)	18
2.7. Differential Pressure Connector (ΔP)	19
2.8. Primary Air Thermocouple Connector (T-AIR)	19
2.9. Computer Interface (USB)	19
2.10. Wireless Printer Port (IrDA)	19
19CHAPTER 3. INITIAL SETUP	20
3.1. Overview	20
3.2. Power	20
3.3. Connecting the Probe and Hose Assembly	21
3.4. Preparing to Configure the PCA® 3	21
CHAPTER 4. CONFIGURATION PROCEDURES	23
4.1. Default Operating Parameters	23
4.2. Fuel Selection	23
4.3. Auto/Manual CO Zero Selections	24
4.4. Temperature Units Selection	25
4.5. Pressure Units Selection	26
4.6. Pollution Units Selection	27
4.7. Date Setup	27

4.8. Time Setup	28
4.9. O ₂ Reference Setup	29
4.10. Print Pressure Selection	30
4.11. Zoom Display Selection	30
4.12. Logging Selection	31
4.13. Button Sound Selection.....	31
4.14. Test ID Information	32
4.14.1. Entering or Editing a Test ID	32
4.14.2. Selecting a Test ID	33
4.14.3. Clearing Test ID Information.....	33
4.15. User Name	34
4.15.1. Entering a User Name.....	34
4.15.2. Clearing a User Name	35
4.16. Language	36
4.17. Cal Reminder Period	36
4.18. Run/Hold Screen Format.....	37
4.19. NO _x Calculation	39
CHAPTER 5. OPERATION	40
5.1. Operating Tips	40
5.2. Turning On the Analyzer	41
5.3. Low Battery Alarm	42
5.4. Locating Sampling Points	42
5.5. Performing a Combustion Test	43
5.6. Selecting a Pressure Label.....	45
5.7. Temperature Label Selection and Measurement	46
5.8. Performing a Draft / Pressure Measurement	47
5.9. Saving Test Data	48
5.10. Ending a Combustion Test.....	49
5.11. Emptying the Water Trap.....	49
5.12. Data Logging.....	50
5.12.1. Overview.....	50
5.12.2. Turning On Data Logging	51
5.12.3. Setting the Logging Interval and Duration.....	52
5.12.4. Starting the Data Logging Process	53
5.12.5. Ending the Data Logging Process.....	53
5.13. Memory Functions	54
5.13.1. Overview.....	54
5.13.2. Recalling Combustion Test Data	54
5.13.3. Recalling Logged Test Data	55
5.13.4. Clearing Memory	56

5.14. Downloading Stored Data to a Computer	57
5.15. Importing Saved Data into a Spreadsheet	57
5.16. Printing Test Data.....	59
5.17. Turning Off the Analyzer and Purging.....	61
CHAPTER 6. CALIBRATION.....	62
6.1. B-Smart Sensors	62
6.2. Starting a Calibration	62
6.3. B-Smart® Sensor Replacement and Calibration.....	63
6.4. Pressure Sensor Calibration	64
6.4.1. Material Required.....	64
6.4.2. Procedure	64
6.5. T-Stack Calibration	65
6.5.1. Material Required.....	66
6.5.2. TS-Zero Procedure	66
6.5.3. TS-Span Procedure	67
6.6. T-Air Calibration	67
6.6.1. Material Required.....	67
6.6.2. TA-Zero Procedure.....	67
6.6.3. TA-Span Procedure.....	69
6.7. CO _{LOW} Sensor Calibration	69
6.7.1. Material Required.....	69
6.7.2. Procedure	70
6.8. SO ₂ Sensor Calibration	72
6.8.1. Material Required.....	72
6.8.2. Procedure	72
6.9. NO Sensor Calibration	73
6.9.1. Material Required.....	73
6.9.2. Procedure	73
6.10. NO ₂ Sensor Calibration.....	74
6.10.1. Material Required.....	74
6.10.2. Procedure	74
6.11. CO _{HIGH} Sensor Calibration.....	76
6.11.1. Material Required.....	76
6.11.2. Procedure	76
CHAPTER 7. MAINTENANCE	78
7.1. Overview	78
7.2. PCA® 3 Disassembly.....	78
7.2.1. Tools Required.....	78
7.2.2. Procedure	78

- 7.3. Emptying the Water Trap Chamber 83
- 7.4. Replacing the Filter Element 83
 - 7.4.1. Material Required 83
 - 7.4.2. Procedure 83
- 7.5. Sensor Replacement 84
- 7.6. Nitric Oxide (NO) Sensor Battery Replacement 86
 - 7.6.1. Material Required 86
 - 7.6.2. Procedure 86
- 7.7. Cleaning the Probe 87
 - 7.7.1. Equipment Required 87
 - 7.7.2. Procedure 87
- CHAPTER 8. TROUBLESHOOTING 88**
- 8.1. Error Symbols 88
- 8.2. Diagnostics and Status Screens 88
- 8.3. Accessing the Diagnostic Menu 89
- 8.4. Accessing the Status Menu 89
- 8.5. Error Messages (After Warm-up) 89
- 8.6. Replacement Parts 90
- 8.7. Accessories 93
- 8.8. Analyzer Repair 95
- 8.9. Service Centers 95
- CHAPTER 9. DECLARATION OF CONFORMITY 96**

CHAPTER 1. INTRODUCTION

1.1. About This Manual

Thank you for investing in a Bacharach PCA®3 Combustion Analyzer. To assure operator safety and the proper use of the PCA®3, please read the contents of this manual for important information on the operation and maintenance of the analyzer.

1.2. Conventions



WARNING: A warning statement denotes a potential hazard associated with the use of this equipment. Failure to follow this information could result in serious personal injury or death.



CAUTION: A caution statement indicates a potentially hazardous situation which, if not avoided, may result in minor or moderate injury. Caution statements may also be used to alert against unsafe practices.



IMPORTANT: An important statement provides emphasis of an important feature, operation, etc. Failure to follow this information could void your warranty, result in improper operation, or cause equipment damage.



NOTE: A note statement provides emphasis of a feature, operation, practice, etc.

1.3. Safety



WARNING: This analyzer is not intended to be used as a safety device.



WARNING: When testing an appliance, a full visual inspection of the appliance should be performed to ensure its safe operation.



CAUTION: This analyzer is not intended to be used on a continuous basis.



CAUTION: Do not store instrument or its sensors with solvents or products that contain solvents.



CAUTION: Except for sensor and battery replacement, this analyzer should only be opened and/or serviced by authorized Bacharach personnel. Failure to comply may void the warranty.



HAZARDOUS AREA WARNING: This instrument has not been designed to be intrinsically safe for use in areas classified as hazardous locations. For your safety, **DO NOT** use it in hazardous (classified) locations.

CAUTION: When the instrument is used in an inefficient furnace or boiler application where there is a high emission of soot, the probe's sample filter may become clogged. Before every use check the filter to confirm that it is clean or replace it with a new filter.

To prevent this from occurring, a smoke test should be performed before operating under such conditions. This ensures that the furnace or boiler is burning at a level appropriate for the use of this instrument.



When the CO₂ level exceeds the allowable threshold, a warning will appear prompting the user to consider performing a smoke test (see Figure 1-1). This screen is removed by pressing the ENT button. Once the warning is cleared, it will not be displayed again for that particular test. If a new test is started (by pressing the HOLD button), the warning will be displayed again if the limit has been exceeded.

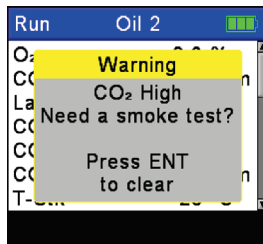

Figure 1-1. High CO₂ Warning

1.4. General Description

The PCA[®]3 is a commercial-grade hand-held combustion and emissions analyzer designed for on-demand sampling of light industrial, institutional, commercial and residential furnaces, appliances, and boilers.

The basic instrument is supplied with a probe and hose assembly, instruction manual, factory calibrated smart sensors, 4 'AA' alkaline batteries, boot, Fyrite[®] User Software, USB cable, and carrying case. Refer to Figure 1-2.

The PCA[®]3 can measure up to four gases simultaneously, so it is the perfect tool for service technicians, inspectors, and boiler contractors who need to determine combustion efficiency, excess air, stack gas O₂ and CO levels, stack temperature, draft, and differential pressure.



Figure 1-2. A Typical PCA[®]3 Kit

The analyzer can also directly measure and display NO, NO₂ and SO₂ with the installation of the appropriate sensors. Combustion efficiency calculations can be conducted for a variety of fuels (see Specifications later in this chapter).

B-Smart[®] sensor technology allows a new sensor to be installed in the field without having to calibrate the analyzer with gas before use.

Advanced data storage and communication features allow the operator to store up to 500 individual combustion test records, which can later be recalled for viewing, printing, or downloading to a personal computer. In its data logging mode, the analyzer can store an additional 500 data logged records. The optional AC power adapter allows the analyzer to run for extended periods of time while data logging.

The optional sample conditioning probe is recommended when measuring NO₂ and SO₂ to ensure the highest degree of measurement accuracy.

A probe and hose assembly with an integral thermocouple and filter/water trap connects to the bottom of the analyzer, providing the means of drawing in gas samples and for measuring stack temperature and draft.

1.5. Operation Overview

1.5.1. Turning On the PCA[®]3

The PCA[®]3 is turned ON by pressing its red I/O button. A warm-up period of 60 seconds then begins, during which time the analyzer performs self diagnostics. At the end of the warm-up period, if no errors were detected the instrument will display the Combustion Test HOLD screen. If errors were detected, the message

“ERRORS DETECTED” is displayed along with a list of the errors. These errors must be corrected before proceeding with the combustion test.

Before starting a test be sure to select the fuel being burned. The default fuel selected is Natural Gas. Note that the name of the fuel being burned is indicated at the top of the run/hold screen.

1.5.2. The Combustion Test

To assure correct combustion efficiency calculations, the analyzer must know the burner's primary-air temperature. The analyzer normally uses its internal temperature sensor for the primary-air temperature value, but this method is only acceptable if the burner is using ambient room air. If the burner is drawing in cold outside air, we recommend that the optional T-AIR thermocouple be used. This thermocouple plugs into the bottom of the analyzer and is placed in the burner's primary-air stream.

Begin the combustion test by first inserting the analyzer's probe tube into the stack-gas stream of the appliance under test, and then pressing the **RUN/HOLD** button to display the Combustion Test RUN screen. The analyzer will begin to continuously monitor the stack temperature, %O₂ and emission levels in the stack gas and then display measured and calculated values on its display. The recommended time required to achieve a stable measurement is a minimum of 3 minutes.

During a test, the CO_{LOW} sensor is protected from high CO levels by being automatically flushed with fresh air when the detected CO level exceeds 4,000 ppm. The analyzer will automatically start using its optional CO_{HIGH} sensor, if installed, at CO levels starting at 4,001 ppm, thus providing continuous CO readings up to 20,000 ppm.

A keypad backlight enables a user to read the keypad in dimly-lit areas. Turn the keypad backlight ON and OFF by briefly pressing the **I/O** button.

1.5.3. Turning Off the PCA[®] 3

The analyzer is turned OFF by pressing and holding down the **I/O** button for at least 2 seconds. Note that there is a 5-second delay before the analyzer actually turns OFF, during which time the analyzer can be turned back ON by pressing the **RUN/HOLD** button. In addition, there is a gas-purge feature that keeps the analyzer's pump running if the gas level inside the sensor chambers is abnormally high at shutdown. With the probe removed from the stack and sampling fresh air, the analyzer purges itself until the detected gas concentrations drop below predetermined levels.

1.6. Features and Benefits

- Powered by 4 'AA' alkaline batteries or NiMH rechargeable batteries. An optional AC adapter provides extended operation.
- O₂ and CO_{LOW} measurement standard. Optional measurement of up to two additional gases, including CO_{HIGH}, NO, NO₂, or SO₂.
- With the appropriate sensors installed, the analyzer optionally displays pollution conversions for CO, NO, NO₂, and SO₂. Pollution conversions include ppm, #/MBTU, mg/m³, and g/GJ.
- B-Smart[®] sensor technology allows pre-calibrated sensors to be installed in the field. Sensors are provided with data that can be entered through the PCA[®] 3 software, or instrument calibration menus, for easy calibration.
- Automatic flushing of the CO_{LOW} sensor with fresh air if the CO level exceeds 4,000 ppm, thus protecting the CO_{LOW} sensor from high CO levels. To measure CO levels above 4,000 ppm, the analyzer automatically switches to its CO_{HIGH} sensor, if installed.
- Automatic purging of the gas-sample system if the detected gas levels are abnormally high when the analyzer is turned OFF.
- Displays temperatures in either °F or °C
- Displays pressure in either inwc, mb, Pa, or hPa
- Backlit color graphic LCD with zoom capabilities
- Low battery alarm
- Stores 500 individual combustion records, which can later be recalled for viewing, printing, or downloading to a personal computer. Stores an additional 500 data logged records.
- Wireless IrDA link for printing current and stored combustion records, pressure records, calibration data, and diagnostic data
- USB connectivity for downloading data to personal computer
- Field replaceable sensors and thermocouple
- Two year warranty on analyzer and all gas sensors.
- Language options including English, French, and Spanish
- Custom Display Formats
- Calibration Reminders: PCA[®] 3 can be configured to remind the user that calibration is past due.
- Auto/manual zeroing option allows the operator to select the start-up mode. Auto-zero determines the zero reading of the CO channel in fresh air and provides an offset for the CO measurements. Also, all sensing channels are automatically zeroed on ambient air when the analyzer is first turned ON. Manual zero is used to *detect* CO that may be present during start-up.

1.7. Sales Combo and Model Configurations

Sales Combo (0024-xxxx)	8440	8441	8442	8443	8444	8445	8446
Sales Combo Kit (0024-xxxx)	8447	8448	8449	8450	8451	8452	8453
Model Type	225	235	245	255	265	275	285
PCA®3 Only Part Number (0024-xxxx)	7320	7321	7322	7323	7324	7325	7326
Measurements							
Oxygen (O ₂)	•	•	•	•	•	•	•
Stack Temperature	•	•	•	•	•	•	•
Primary/Ambient Air Temperature	•	•	•	•	•	•	•
Carbon Monoxide Low (CO _{LOW})	•	•	•	•	•	•	•
Pressure/Draft	•	•	•	•	•	•	•
Carbon Monoxide High (CO _{HIGH})			•				•
Nitric Oxide (NO)		•			•	•	•
Nitrogen Dioxide (NO ₂)					•		
Sulfur Dioxide (SO ₂)				•		•	
Calculations							
Combustion Efficiency	•	•	•	•	•	•	•
Excess Air	•	•	•	•	•	•	•
Carbon Dioxide (CO ₂)	•	•	•	•	•	•	•
NO _x (NO _x = NO + NO ₂)					•		
NO _x referenced to % O ₂					•		
CO referenced to % O ₂	•	•	•	•	•	•	•
NO referenced to % O ₂		•			•	•	•
NO ₂ referenced to % O ₂					•		
SO ₂ referenced to % O ₂				•		•	

1.8. Specifications

Measurement (Based on Installed Sensors)	Display Range
Oxygen	0.1 to 20.9%
Stack Temperature	-4 to 2,192 °F (-20 to 1,200 °C)
Primary/Ambient Air Temperature	-4 to 999 °F (-20 to 537 °C)
Carbon Monoxide (CO) (H ₂ compensated)	0 to 4,000 ppm
Pressure/Draft	±72" H ₂ O (±179 mb)
CO High Range	4,001 to 20,000 ppm
Nitric Oxide (NO)	0 to 3,000 ppm
Nitrogen Dioxide (NO ₂)	0 to 500 ppm
Sulfur Dioxide (SO ₂)	0 to 5,000 ppm

Calculated Value (Based on Installed Sensors)	Display Range
Combustion Efficiency	0.1 to 100%
Excess Air	1 to 250%
Carbon Dioxide (dry basis)	0.1 to fuel-dependent max in %
NO _x (NO _x = NO + NO ₂)	0 to 3,500 ppm
NO _x referenced to %O ₂	0 to 9,999 ppm
CO referenced to %O ₂	0 to 9,999 ppm
NO referenced to %O ₂	0 to 9,999 ppm
NO ₂ referenced to %O ₂	0 to 9,999 ppm
SO ₂ referenced to %O ₂	0 to 9,999 ppm



NOTE: Calculations are performed only when the measured oxygen level is below 16.0% and the stack temperature is below 2,000 °F (1,093 °C).

Reading	Performance Accuracy
O ₂	±0.3% O ₂ on practical concentrations of stack gas (mix of O ₂ , CO ₂ , and N ₂)
CO	Greater of ±5% of reading or ±10 ppm, between 0-2,000 ppm, ±10% of reading between 2,001 and 20,000 ppm.
NO	Greater of ±5% of reading or 5 ppm
NO ₂	Greater of ±5% of reading or ±5 ppm between 0-500 ppm
SO ₂	Greater of ±5% of reading or ±10 ppm between 0-2,000 ppm
Stack Gas Temp	±4 °F (±2 °C) between 32 and 255 °F (0 and 124 °C) ±6 °F between 256 and 480 °F (±3 °C between 125 and 249 °C) ±8 °F between 481 and 752 °F (±4 °C between 250 and 400 °C)
Primary/Ambient Air Temp	±2 °F between 32 and 212 °F (±1 °C between 0 and 100 °C)
Pressure/Draft	±0.02 inches from -1 to 1 inwc; ±2% of reading from -10 to 10 inwc; ±3% of reading from -40 to 40 inwc
System Flow Rate with Probe	200 cc/min minimum

General Specification		Description
Dimensions (H x W x D)		9.0 x 3.0 x 2.5 inches (22.9 x 7.6 x 6.3 cm)
Weight		Analyzer with Batteries: 1.4 lb (0.6 kg) Probe/Hose Assembly: 1.0 lb (0.5 kg)
Fuels Available for Combustion Calculations		<ul style="list-style-type: none"> • Natural Gas • Coal • Oil #2 • Oil #4 • Oil #6 • Wood • Kerosene • Bagasse • Propane • Digester Gas
Warm-up Time		60 seconds (Sensors checked and auto zeroed)
Power	4 "AA" Batteries (Disposable)	Alkaline: 10 hours of operation (min) NiMH Rechargeable: Operating time varies
	AC Adapter (Optional)	100-240 VAC; 50/60 Hz: Continuous use
Operating Temperature		Analyzer: 32 to 104 °F (0 to 40 °C) Probe Tip: 1,472 °F (800 °C) Max.
Operating Humidity		Analyzer: 15 to 90% RH, non-condensing
Operating Air Pressure		Analyzer: Atmospheric Probe: 10" H ₂ O (25 mb) draft max. at probe tip
Memory		500 complete combustion test records 500 complete logged combustion test records
Interfaces		Printer: Infrared (IrDA) communications Computer: USB 2.0 (mini-B connector)

CHAPTER 2. HARDWARE

2.1. Overview

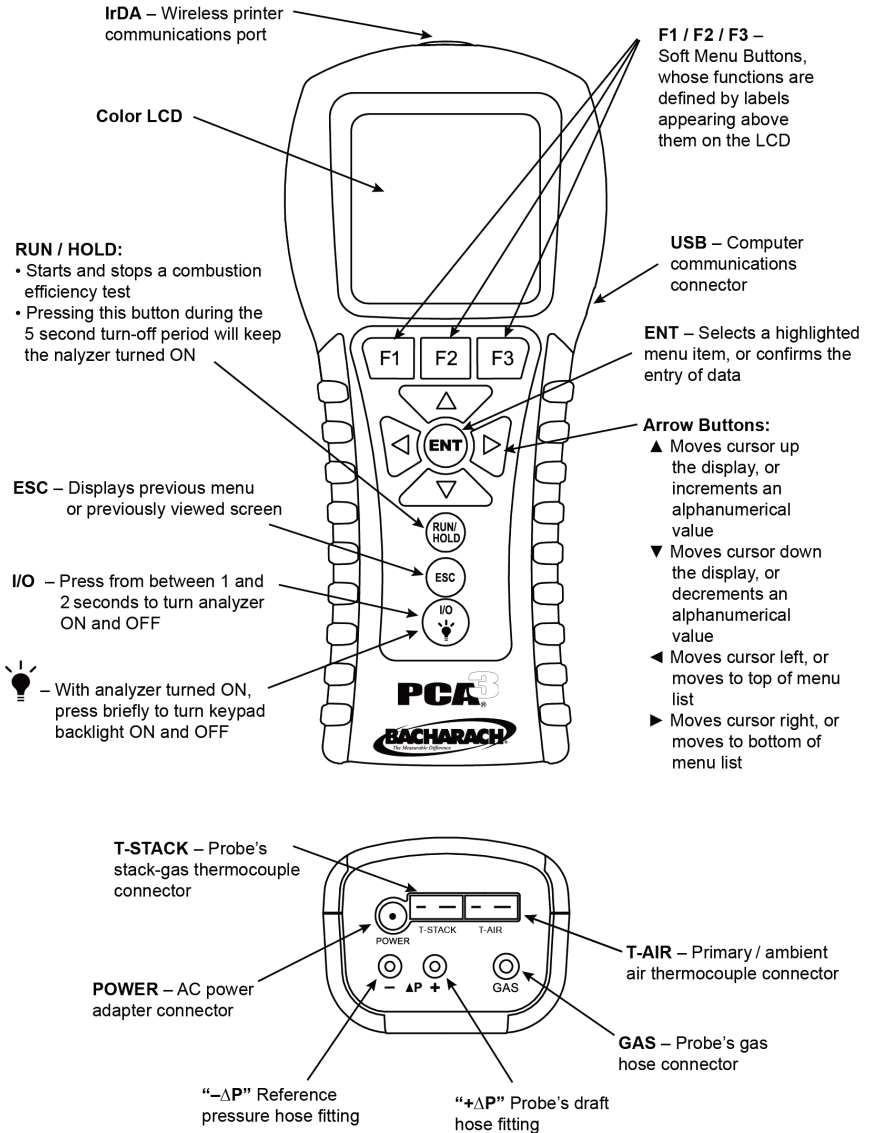



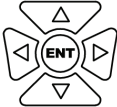





Figure 2-1. Front and Bottom Views Showing Key Components

2.2. Front Panel Buttons

The PCA[®] 3 is controlled by various buttons, while a color graphic LCD (with automatic dimming feature) is used to display all combustion and emission test data and analyzer parameters. Descriptions of the front panel buttons are given below. Note that a button may perform multiple functions depending on the current screen that is displayed.

  	F1	<p>PRINT Transmits the data displayed on the screen to a printer through the IrDA communications port.</p> <p>PAGE- When viewing the Memory or Logging Directory, each press of this button pages down through the directory. Holding this button down speeds up the paging process.</p>
	F2	<p>MENU Displays the Main Menu.</p> <p>ZERO When viewing the Pressure screen, this button zeros the pressure sensor to current atmospheric conditions. When viewing the Temperature screen, this button zeroes the temperature channel difference.</p>
	F3	<p>SAVE Saves the data currently displayed on the LCD in memory. Up to 500 individual Combustion Test, Temperature, and Pressure records can be saved. After 500 records have been saved, the memory must be cleared to continue saving additional data. The analyzer will not overwrite old data.</p> <p>PAGE+ When viewing the Memory or Logging Directory, each press of this button pages through the directory. Holding this button speeds the paging process.</p>
	<p>▲</p> <p>▼</p> <p>▶</p> <p>◀</p>	<p>The arrow buttons move the cursor on the LCD. In screens that require the entry of alphanumeric data, use the◀▶ buttons to move cursor across the screen and then use the▲▼ buttons to increment and decrement the data. When viewing a menu, use the◀▶ buttons to quickly move to the top and bottom of the menu.</p>
	ENT	<p>Selects a highlighted item. In addition, if changes were made to one of the analyzer's operating parameters (e.g., date, time, O₂ reference, etc.), pressing this button confirms those changes and saves them in memory.</p>
	RUN/HOLD	<p>Starts and stops a combustion test when the Combustion Test screen is displayed. Pressing this button in any other screen returns the analyzer to the Combustion Test HOLD screen. Pressing this button during the 5 second turn-off-delay period will abort the turn-off process and also return the analyzer to the Combustion Test HOLD screen.</p>
	ESC	<p>Displays a previously viewed screen. In addition, if changes were made to one of the analyzer's operating parameters (e.g., date, time, O₂ reference, etc.), pressing this button aborts those changes, restores the old values, and then displays the previously viewed screen.</p>
	I/O	<p>Turns the analyzer ON and OFF, and is also used to turn the keypad LEDs ON and OFF.</p>

For example, the functions of the F1, F2, and F3 buttons are defined by labels appearing above them on the LCD. The labels that appear depend on the functions that can be performed in the particular screen being displayed.



NOTE: A keypad backlight enables a user to read the keypad in dimly-lit areas. Turn the keypad backlight ON and OFF by briefly pressing the I/O button.



NOTE: When the analyzer is turned OFF, there is a 5-second delay, during which time an operator can keep the analyzer turned ON by pressing the RUN / HOLD button. Also note that if the measured emission levels are above predetermined limits at the time the instrument is turned OFF, the pump is automatically started and purges the sensor compartment with fresh air until the gas levels inside the analyzer are reduced. If desired, the purging process can be aborted by again pressing the I/O button, though it is not recommended.

2.3. Backlit Display

A large backlit color graphic display shows multiple combustion test values simultaneously, and includes a zoom capability that provides extra large text.

Run		NGAS	■ ■ ■
O ₂	4.0 %		
CO	13 ppm		
Eff	82.9 %		
CO ₂	9.6 %		
T-Stk	374 °F		
T-Air	76.6 °F		
EA	20.9 %		
Print		Menu	Save

Figure 2-2. Sample Display

2.4. Battery Compartment

The PCA[®]3 is powered by either its four internal batteries or by an optional AC power adapter that operates from any convenient source of 100–240 VAC, 50/60 Hz power. Batteries may be either disposable alkaline or rechargeable NiMH.

2.5. AC Adapter Connector (POWER)

The AC power adapter P/N 0024-1254 can be used as an external power supply, which will run the analyzer on a continuous basis. It uses 100-240 VAC at 50/60 Hz.

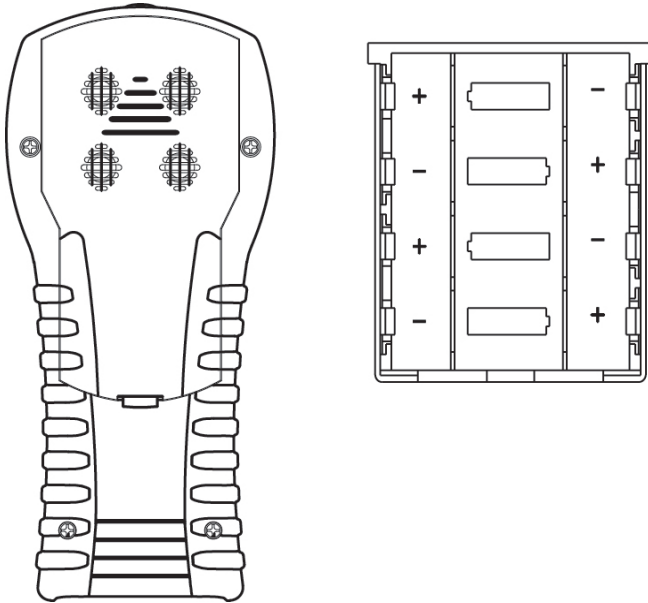

Figure 2-3. Battery Compartment

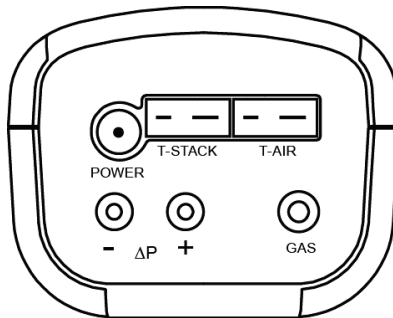

Figure 2-4. Bottom View Showing Connectors

2.6. Probe Connectors (Gas, Pressure, T-Stack)

The probe and hose assembly are connected to the analyzer by way of the following connectors.

- Stack-gas thermocouple to the analyzer's T-STACK connector
- Stack-gas hose to the analyzer's GAS connector
- Draft hose to the analyzer's + ΔP connector

Observe that the probe connectors are of different sizes and shapes, which prevents incorrect connection to their associated connectors on the analyzer. See Figure 2-5.

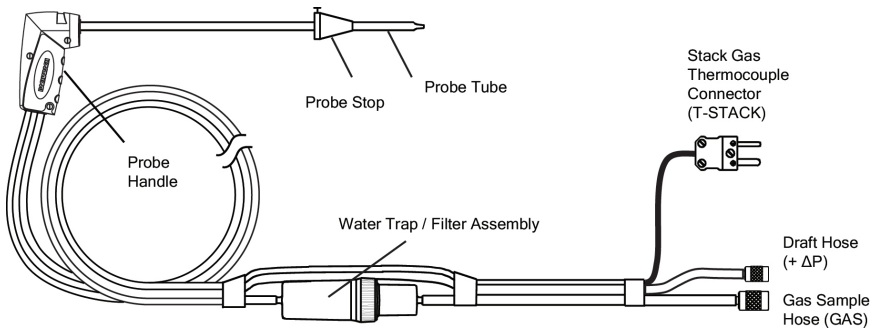

Figure 2-5. Probe Connectors GAS, +ΔP, and T-STACK

2.7. Differential Pressure Connector (ΔP)

Draft is measured by connecting the probe's draft hose to the +ΔP fitting, while leaving the -ΔP fitting open to the atmosphere. See Figure 2-5.

In addition to measuring draft, the "+" and "-" ΔP fittings can also be used to measure the differential pressure between two areas by first connecting a hose (P/N 0024-1103) to the -ΔP fitting, and then inserting the open end of this hose into the area being used as the reference pressure. The analyzer's probe is then inserted into the area where differential pressure is to be measured.

2.8. Primary Air Thermocouple Connector (T-AIR)

If thermocouple P/N 0104-1797 (10 feet long) or Utility Wand P/N 0104-1799 (12-inch ridged probe with handle and 5 foot coiled cable) is to be used to measure the burner's primary air temperature, then connect either of these thermocouples to the analyzer's T-AIR connector. See Figure 3-2 on page 22.

2.9. Computer Interface (USB)

Data stored in the analyzer's memory can be downloaded to a personal computer by connecting USB data cable P/N 0104-4032 between the USB ports of the computer and analyzer. The PCA[®] 3's USB port is on its right side. See Figure 2-1 on page 15.

2.10. Wireless Printer Port (IrDA)

Data that has been stored in the analyzer's memory can be printed on a compatible IrDA (Infrared data associated) wireless printer by aligning their IrDA communication ports. The IrDA port of the PCA[®] 3 is located at the top of the device. See Figure 2-1 on page 15.

CHAPTER 3. INITIAL SETUP

3.1. Overview

Before configuring or using the PCA[®]3, you MUST:

- provide power
- connect the probe and hose assembly.

3.2. Power

Three options are available to power the PCA[®]3:

- disposable alkaline batteries
- rechargeable NiMH batteries
- AC power adapter.

If you are using either alkaline or NiMH rechargeable batteries to power the analyzer, follow the instructions below to install or replace the batteries.

- Remove the battery cover from back of unit (Figure 3-1).
- Remove (and properly dispose of) any old batteries.
- Install a set of four 'AA' alkaline or NiMH batteries, per the "+" and "-" markings inside the battery compartment.
- Replace the battery cover.

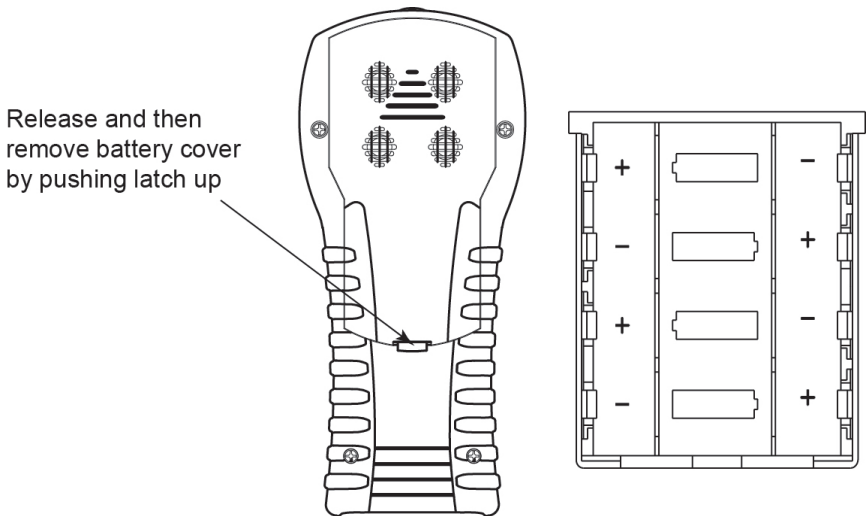

Figure 3-1. Battery Cover and Compartment

The AC power adapter is capable of powering the analyzer on a continuous basis. The adapter plugs into an appropriate 100-240 VAC, 50/60 Hz wall outlet, and produces an output of +6 VDC. The adapter's output connector plugs into the analyzer's POWER jack located on the bottom of the unit (refer to Figure 3-2 on page 22).

3.3. Connecting the Probe and Hose Assembly

To attach the probe and hose assembly to the analyzer follow the steps below and refer to Figure 3-2 on page 22.

1. Push the gas sample hose connector, the larger of the two connectors (giving a slight twist), onto the analyzer's GAS fitting.
2. Push the draft hose connector, the smaller connector (giving a slight twist), onto the analyzers + Δ P fitting.
3. Push the stack gas thermocouple connector into the T-STACK jack (connector fits in only one way).
4. Push the optional primary/ambient air thermocouple into the T-AIR jack (connector fits in only one way).



IMPORTANT: To assure the accurate calculation of combustion efficiency, the optional primary/ambient air thermocouple must be used when the burner's primary-air temperature is not the same as the room temperature.

5. Inspect all hoses for cracks. If any hose is found to be defective, replace the entire probe and hose assembly. Check that the water trap is empty, and the filter is not dirty or saturated with water.

3.4. Preparing to Configure the PCA[®]3

After initial setup is complete, turn on the PCA[®]3. For detailed power-up instructions, refer to Turning On the PCA[®]3 on pages 9 and 41. You are now ready to configure your PCA[®]3 for your particular application and to your particular preferences. Refer to Configuration Procedures on page 23. You configure the PCA[®]3 by navigating the menus and changing key parameter values. It may be helpful to review Front Panel Buttons on page 16 in preparation for navigating the menu interface of the PCA[®]3.

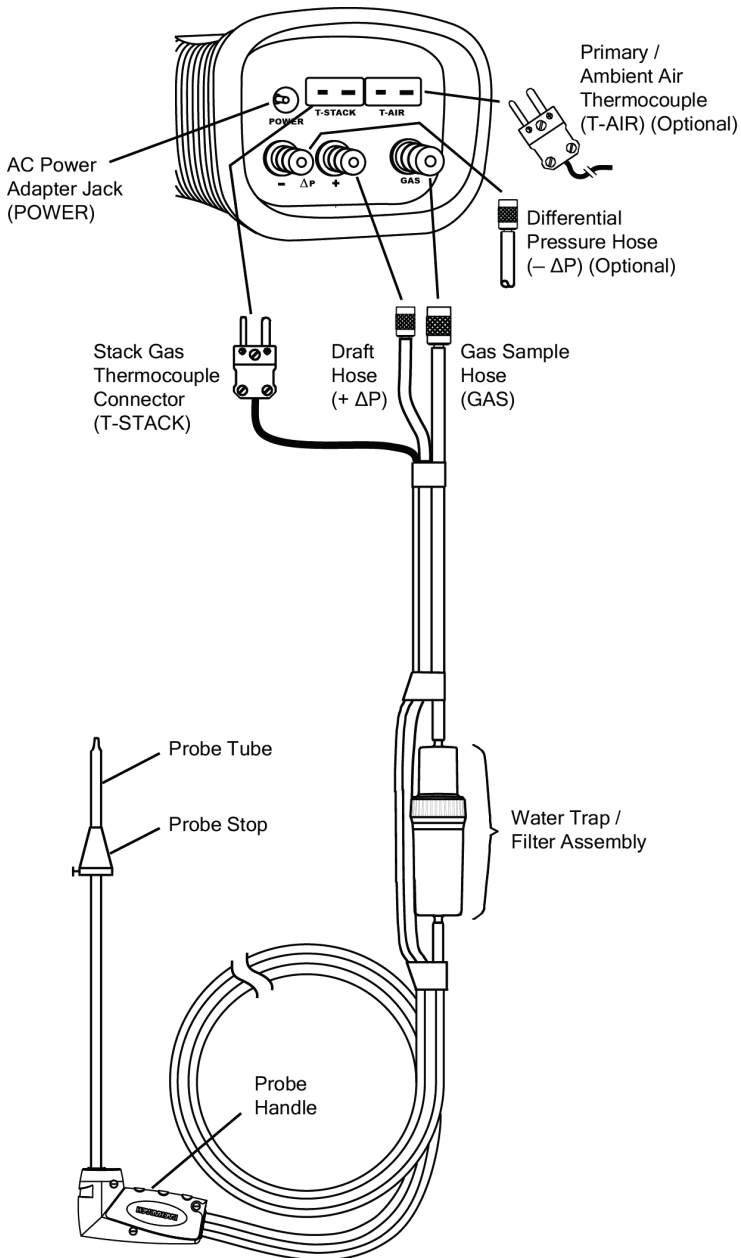

Figure 3-2. Connecting the Probe to the Analyzer

CHAPTER 4. CONFIGURATION PROCEDURES

4.1. Default Operating Parameters

The PCA[®] 3 is set up at the factory for the following operating parameters. To change any of these parameters, perform the associated procedure that follows.

Parameter	Factory Default	See...
Fuel	Natural Gas	Page 23
Auto/Manual CO Zero	Auto Zero	Page 24
Temperature Units	°F	Page 25
Pressure Units	Inches of Water Column (inwc)	Page 26
Pollution Units	ppm	Page 27
Date	Current MM/DD/YY	Page 27
Time	Current EST HH:MM AM/PM	Page 28
O ₂ Reference	0%	Page 29
Print Pressure	No	Page 30
Zoom	Standard	Page 30
Logging	No	Page 31
Button Sound	On	Page 31
Test ID Information	<blank>	Page 32
User Name	<blank>	Page 34
Language	English	Page 36
Calibration Reminder	Never	Page 36
Run/Hold Screen Format	See page 37 for default	Page 37
NO _x Calculation	Off	Page 39

4.2. Fuel Selection

To assure the accurate calculation of combustion efficiency, select the fuel being burned as follows.

1. Display the MAIN MENU by pressing the **MENU (F2)** button. If necessary, press **ESC** until MENU appears above **F2**.
2. Use the **▲▼** buttons to highlight FUEL and then press **ENT** to display the FUEL MENU.
3. Use the **▲▼** buttons to scroll through the list of available fuels until the desired fuel is highlighted. In the example shown, PROPANE has been selected (If custom fuels are added, they will be displayed at the bottom of the list).



NOTE: Use the **◀▶** buttons to quickly scroll to the bottom and top of the list.

4. Press **ENT** to save the selection and display the Combustion Test HOLD screen. Observe that the name of the selected fuel should now appear at the top of the screen.



NOTE: In addition to the standard fuels programmed into the PCA[®]3, Bacharach can develop custom fuel codes based on the customer's specific needs. The PCA[®]3 can be programmed with 2 additional fuels which can be added to the instrument using the Fyrite User Software (FUS). Consult factory for price and delivery.

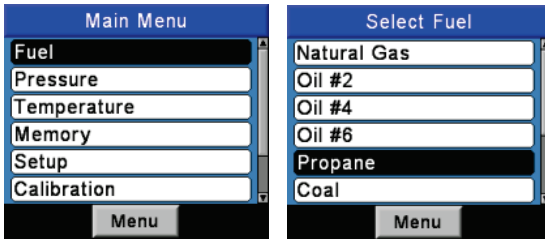

Figure 4-1. Fuel Selection

4.3. Auto/Manual CO Zero Selections

Select how the PCA[®]3 performs a zero function.

1. Display the MAIN MENU by pressing the **MENU (F2)** button. If necessary, press **ESC** until MENU appears above **F2**.
2. Use the **▲▼** buttons to highlight **SETUP**, and then press **ENT** to display the SETUP MENU.
3. Use the **▲▼** buttons to highlight **CO Zero Setting**, and then press **ENT** to display the CO ZERO SETTING MENU.
4. Use the **▲▼** buttons to highlight the desired zeroing option (Manual or Auto-Zero). In the example shown, Manual Zero has been selected.
5. Place the instrument in fresh air to zero, and press **ENT** to start a 60-second count down.
6. Press **ENT** to save and re-display the SETUP MENU.

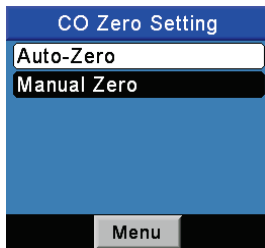
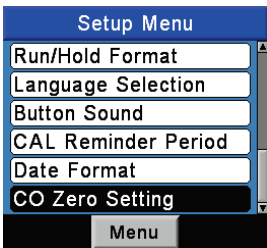

Figure 4-2. Auto/Manual Zero Selection



NOTE: The PCA[®]3 performs a zero function during warm-up. Among other purposes, an *auto-zero* determines the “zero reading” of the CO channel in fresh air and provides an offset for the CO measurement. A *manual zero* detects background CO during startup.

Manual Zero: When the CO channel is set to manual zero, the analyzer does not zero the CO sensor to ambient conditions during start up. In this mode, the “fresh air zero” established during *manual mode* setup is stored in memory and used for the calculation of CO.

Auto Zero: When the CO channel is set to auto zero, the CO sensor is zeroed to the ambient CO level during start up. Important: When using this mode, the analyzer must be turned ON in fresh air; otherwise, incorrect CO readings will occur.

Auto Zero determines the zero reading of the CO channel in fresh air and provides an offset for the CO measurements. Manual zero is used to detect CO that may be present during start-up. The auto/manual zeroing option allows the operator to select the start-up mode. It is selectable from the CO Zero Setting of the Setup Menu.



NOTE: Both methods take the user through a 60-second count down to establish a new zero. The manual mode establishes a fresh air zero and stores it for use during instrument startup.

4.4. Temperature Units Selection

Select to display temperature in either °F or °C as follows.

1. Display the MAIN MENU by pressing the **MENU (F2)** button. If necessary, press **ESC** until MENU appears above **F2**.
2. Use the **▲▼** buttons to highlight SETUP, and then press **ENT** to display the SETUP MENU.
3. Use the **▲▼** buttons to highlight TEMP UNITS, and then press **ENT** to display the TEMP UNITS MENU.
4. Use the **▲▼** buttons to highlight the desired temperature units. In the example shown, Fahrenheit has been selected.
5. Press **ENT** to save the selection and re-display the SETUP MENU.

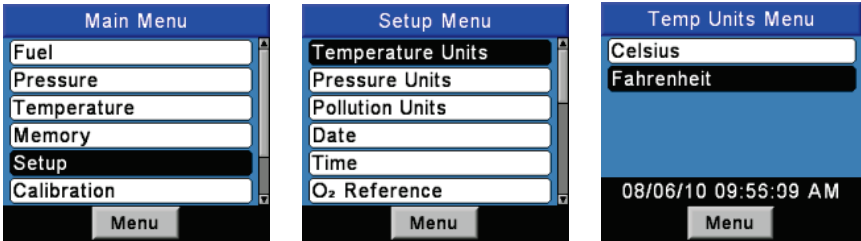

Figure 4-3. Temperature Units Selection

4.5. Pressure Units Selection

Select to display pressure in Inches of Water Column (inwc), millibar (mb), Pascals (Pa), or hectoPascals (hPa) as follows.

1. Display the MAIN MENU by pressing the **MENU (F2)** button. If necessary, press **ESC** until MENU appears above **F2**.
2. Use the **▲ ▼** buttons to highlight **SETUP**, and then press **ENT** to display the **SETUP MENU**.
3. Use the **▲ ▼** buttons to highlight **PRESSURE UNITS**, and then press **ENT** to display the **PRESSURE UNITS MENU**.
4. Use the **▲ ▼** buttons to high light the desired pressure units. In the example shown, InchesWater has been selected.
5. Press **ENT** to save the selection and re-display the **SETUP MENU**.

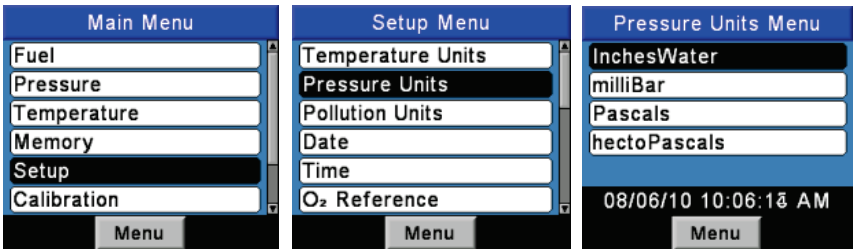

Figure 4-4. Pressure Units Selection

4.6. Pollution Units Selection

The PCA[®] 3 is capable of converting the measured ppm levels of CO, NO, NO₂, and SO₂ to various pollution units using CFR40 Part 60 emission factors. Note that the pollution unit conversions for NO, NO₂ and NO_x are based on the molecular weight of NO₂.

Configure the PCA[®] 3 to display pollution units in parts per million (ppm), pounds of pollutant per million BTU (#/Mbtu), milligrams of pollutant per cubic meter of gas (mg/m³), or grams of pollutant per gigajoule (g/GJ) as follows.

1. Display the MAIN MENU by pressing the **MENU (F2)** button. If necessary, press **ESC** until MENU appears above **F2**.
2. Use the **▲▼** buttons to highlight SETUP, and then press **ENT** to display the SETUP MENU.
3. Use the **▲▼** buttons to highlight POLLUTION UNITS, and then press **ENT** to display the POLLUTION UNITS MENU.
4. Use the **▲▼** buttons to highlight the desired pollution units. In the example shown, ppm has been selected.
5. Press **ENT** to save the selection and re-display the SETUP MENU.

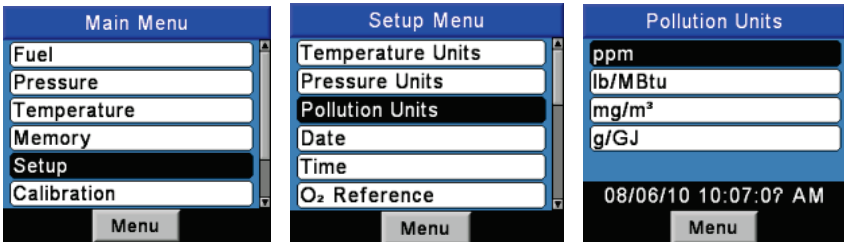

Figure 4-5. Pollution Units Selection

4.7. Date Setup

The date is stored in the format: MM/DD/YY. Its value is part of the date and time stamp that is saved along with each combustion test record. Set the analyzer's internal clock to the current date as follows.

1. Display the MAIN MENU by pressing the **MENU (F2)** button. If necessary, press **ESC** until MENU appears above **F2**.
2. Use the **▲▼** buttons to highlight SETUP, and then press **ENT** to display the SETUP MENU.
3. Use the **▲▼** buttons to highlight DATE, and then press **ENT** to display the DATE MENU.
4. First use the **◀▶** buttons to move the cursor across the screen until it is over the digit to be changed, and then press the **▲▼** buttons until the desired value is displayed.

5. Repeat Step 4 until the values for month, day, and year have been set.
6. Press **ENT** to save the selection and re-display the SETUP MENU, or press **ESC** to abort this procedure and retain the old date values.



NOTE: The real time clock is powered by the main batteries and is maintained by a coin cell battery on the Main PCB in the absence of batteries. Bacharach recommends changing the coin cell (P/N 0204-0020) every 5 years.

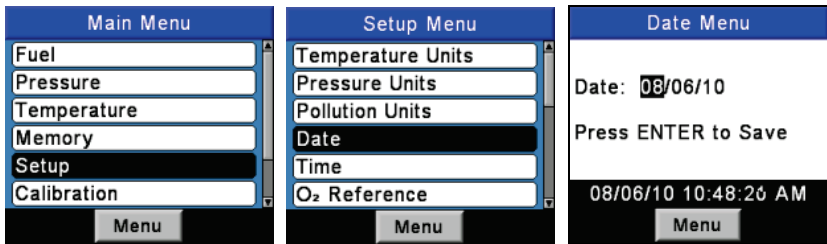

Figure 4-6. Date Setup

4.8. Time Setup

The time is stored in the format: hh:mm:ss AM/PM. Its value is part of the date and time stamp that is saved along with each combustion test record. Set the analyzer's internal clock to the current time as follows.

1. Display the MAIN MENU by pressing the **MENU (F2)** button. If necessary, press **ESC** until MENU appears above **F2**.
2. Use the **▲▼** buttons to highlight SETUP, and then press **ENT** to display the SETUP MENU.
3. Use the **▲▼** buttons to highlight TIME, and then press **ENT** to display the TIME MENU.
4. First use the **◀▶** buttons to move the cursor across the screen until it is over the digit to be changed, and then press the **▲▼** buttons until the desired value is displayed.
5. Repeat Step 4 until values for hour, minute, and meridian are set.



NOTE: The value for seconds cannot be entered, but is displayed and stored as part of the combustion test record.

6. Press **ENT** to save the displayed time values and re-display the SETUP MENU, or press **ESC** to abort and retain the old time values.

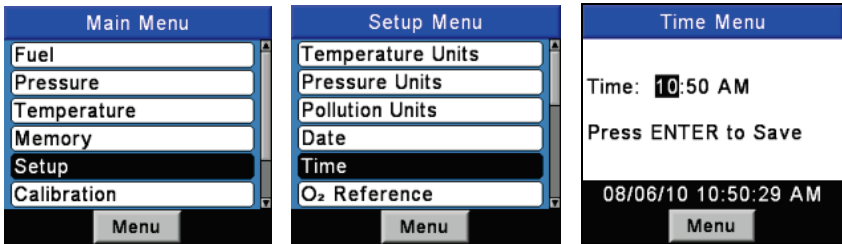
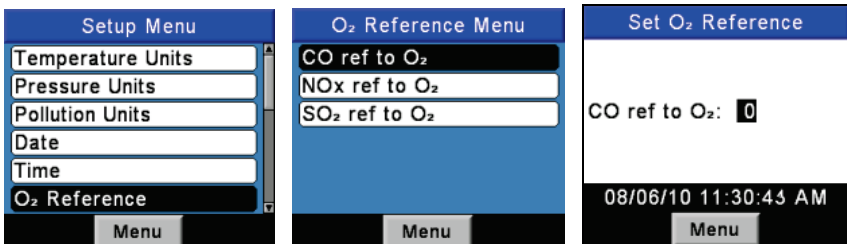

Figure 4-7. Time Setup

4.9. O₂ Reference Setup

The measured values of CO, NO_x, and SO₂ can be individually referenced to a specific O₂ percentage of between 0 and 15%. Individually set up the O₂ reference value for each of the above gases as follows.

1. Display the MAIN MENU by pressing the **MENU (F2)** button. If necessary, press **ESC** until MENU appears above **F2**.
2. Use the **▲▼** buttons to highlight **SETUP**, and then press **ENT** to display the **SETUP MENU**.
3. Use the **▲▼** buttons to highlight **O₂ REF**, and then press **ENT** to display the **O₂ REFERENCE** screen.
4. Use the **▲▼** buttons to highlight the desired measurement, and then press **ENT** to display the **REF TO O₂** screen for that measurement. In the example shown, **CO** has been selected.
5. First use the **◀▶** buttons to move the cursor across the screen until it is over the digit to be changed, and then press the **▲▼** buttons until the desired value is displayed.
6. Press **ENT** to save the displayed value and re-display the **O₂ REFERENCE** screen, or press **ESC** to abort this procedure and retain the old O₂ reference value.
7. If the O₂ reference value for more than one gas is being set, repeat Steps 4, 5, and 6 for each measurement.

Figure 4-8. O₂ Reference Setup

4.10. Print Pressure Selection

Select whether to print or not print the pressure measurement on the combustion test printout as follows.

1. Display the MAIN MENU by pressing the **MENU (F2)** button. If necessary, press **ESC** until MENU appears above **F2**.
2. Use the **▲▼** buttons to highlight SETUP, and then press **ENT** to display the SETUP MENU.
3. Use the **▲▼** buttons to highlight PRINT PRESSURE, and then press **ENT** to display the PRINT PRESSURE screen.
4. Use the **▲▼** buttons to highlight either No (do not print pressure) or Yes (print pressure). In the example shown, Yes has been selected.
5. Press **ENT** to save the selection and re-display the SETUP MENU.

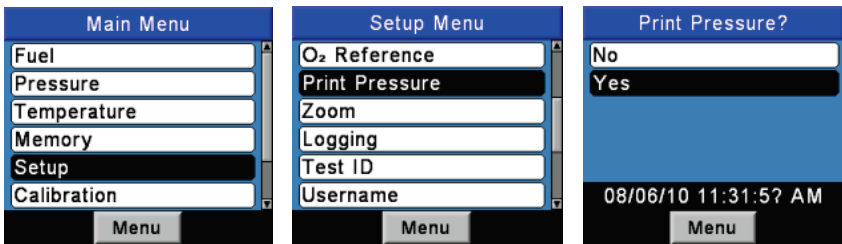

Figure 4-9. Print Pressure Selection

4.11. Zoom Display Selection

Combustion test data in the Run/Hold screen can be shown with enlarged characters to make viewing easier. The operator can set zoom levels to Standard, 2X, or 3X. The Standard zoom setting will display seven lines of combustion test data at one time, 2X which will display five lines of combustion test data with enlarged characters, and 3X which will display four lines of combustion test data with enlarged characters. The operator can scroll through the complete list of measured and calculated data no matter what zoom level has been selected. Select desired zoom level as follows:

1. Display the MAIN MENU by pressing the **MENU (F2)** button. If necessary, press **ESC** until MENU appears above **F2**.
2. Use the **▲▼** buttons to highlight SETUP, and then press **ENT** to display the SETUP MENU.
3. Use the **▲▼** buttons to highlight ZOOM, and then press **ENT** to display the ZOOM screen.
4. Use the **▲▼** buttons to select the desired Zoom level. Options include STANDARD, 2X, and 3X. Standard will display seven lines of Combustion test data, 2X will display five, and 3X will display four.
5. Press **ENT** to save the selection and re-display the SETUP MENU.

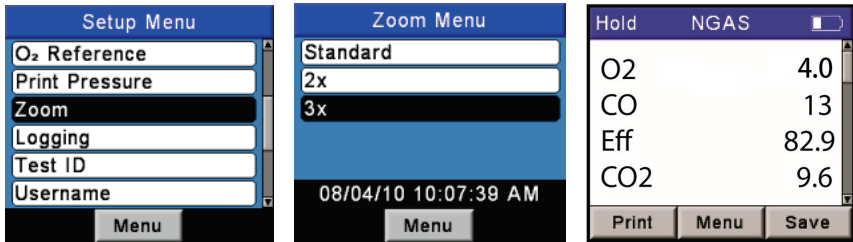

Figure 4-10. Zoom Display Selection

4.12. Logging Selection

When the logging function is activated, up to 500 combustion test records will be automatically stored in memory at a preset interval over a predetermined length of time.

Refer to Data Logging starting on page 50 for detailed information on how to select the logging function, how to set the interval and duration time periods, and how to view or download the stored data.

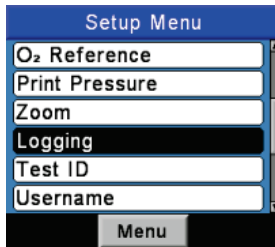

Figure 4-11. Logging Selection

4.13. Button Sound Selection

The audible sound used to signal when a button is pressed can be turned OFF and ON as follows.

1. Display the MAIN MENU by pressing the **MENU (F2)** button. If necessary, press **ESC** until MENU appears above **F2**.
2. Use the **▲▼** buttons to highlight SETUP, and then press **ENT** to display the SETUP MENU.
3. Use the **▲▼** buttons to highlight BUTTON SOUND, and then press **ENT** to display the BUTTON SOUND screen.
4. Use the **▲▼** buttons to highlight either OFF or ON. In the example shown, OFF has been selected.
5. Press **ENT** to save the selection and re-display the SETUP MENU.

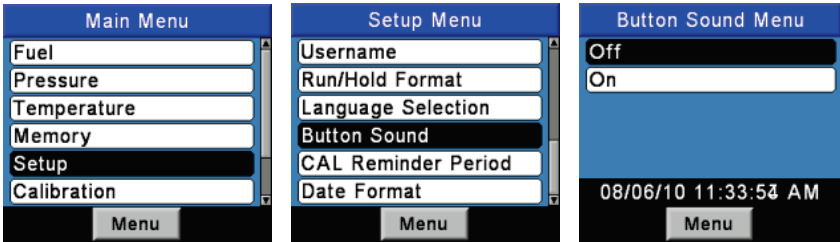

Figure 4-12. Button Sound Selection

4.14. Test ID Information

Test records can be identified (e.g., customer’s name, burner number, and location) by manually entering up to three lines of text, with each line containing a maximum of 20 alphanumeric characters. When a Test ID is selected this information will be associated with all succeeding test records, and will appear at the top of each test record when printed, and in CSV files when records are downloaded to a PC. The chosen Test ID remains in effect until it is deselected, a new Test ID is selected, or the instrument is turned off. Up to 30 Test IDs can be pre-entered for later retrieval.



NOTE: To save time, Test ID information can be entered using the Fyrite User Software.

4.14.1. Entering or Editing a Test ID

1. Display the MAIN MENU by pressing the **MENU (F2)** button. If necessary, press **ESC** until MENU appears above **F2**.
2. Use the **▲▼** buttons to highlight **SETUP**, and then press **ENT** to display the SETUP MENU.
3. Use the **▲▼** buttons to highlight **TEST ID**, and then press **ENT** to display the TEST ID menu.
4. Use the **▲▼** buttons to highlight **EDIT TEST ID**, and then press **ENT** to display the EDIT TEST ID menu, which displays the first line of each Test ID record.
5. Use the **▲▼** buttons to select which Test ID to edit and then press **ENT** to display all three lines of that record. Periods (.....) are used to identify empty lines.
6. Use the **▲▼** buttons to choose which of the three Test ID lines to edit and then press **ENT** to begin editing the chosen line.
7. Use the **▲▼** buttons to enter the desired character and then move to the next character position by pressing the right arrow key. Repeat this step until the line is complete. A maximum of 20 characters can be entered. Press **ENT** to accept the information.

8. At this time, either return to Step 6 to choose another line to edit, or end this procedure by highlighting Edit Complete and pressing the **ENT** key to return to the Edit Test ID Menu.
9. Press **ESC** to go to the Test ID Menu or the **RUN/HOLD** key to return to the Run/Hold screen.

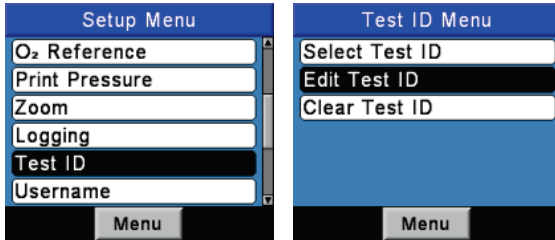

Figure 4-13. Editing a Test ID

4.14.2. Selecting a Test ID

1. From the Test ID menu, use the **▲▼** buttons to highlight SELECT TEST ID, and then press **ENT** to display the SELECT TEST ID menu, which displays the first line of each Test ID record.

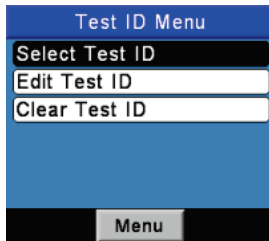

Figure 4-14. Selecting a Test ID

2. Use the **▲▼** buttons to choose a pre-entered Test ID or choose NO Test ID (located at bottom of list) to deselect a previously chosen record, then press **ENT** to make the selection and return to the Test ID menu.
3. Press **ESC** to end the procedure and return to the Setup Menu or press the **RUN/HOLD** key to return to the Run/Hold Screen.

4.14.3. Clearing Test ID Information

1. From the Test ID menu, use the **▲▼** buttons to highlight CLEAR TEST ID, and then press **ENT** to display the CLEAR TEST ID menu.
2. Do one of the following to clear Individual Records or All Records.
Individual Records: Use the **▲▼** buttons to highlight Individual Records, then press **ENT** to display the Clear Individual menu. Again use the **▲▼** buttons to highlight the individual record to clear, then press **ENT** to clear the record.

All Records: Use the ▲▼ buttons to highlight All Records, then press ENT to display the Clear All menu. Again use the ▲▼ buttons to highlight Yes, then press ENT to clear all records.

3. Press ESC to end this procedure and return to the Test ID menu or press the RUN/HOLD key to return to the Run/Hold screen.

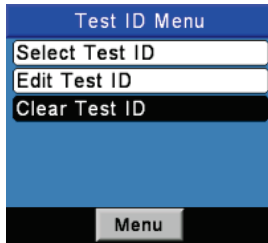

Figure 4-15. Clearing a Test ID

4.15. User Name

The name of the user or owner of the analyzer (e.g., company name, address, phone number) can be stored in memory by manually entering up to three lines of text, with each line containing up to 20 alphanumeric characters. This information will appear at the top of each printout until new information is entered or cleared.



NOTE: To save time, user name information can be entered using the Fyrite[®] User Software.

4.15.1. Entering a User Name

1. Display the MAIN MENU by pressing the **MENU (F2)** button. If necessary, press **ESC** until MENU appears above **F2**.
2. Use the ▲▼ buttons to highlight SETUP, and then press **ENT** to display the SETUP MENU.
3. Use the ▲▼ buttons to highlight USERNAME, and then press **ENT** to display all three lines of the EDIT USERNAME screen. Periods(.....) identify empty lines.
4. Use the ▲▼ buttons to choose which of the three Username lines to edit, then press **ENT** to begin editing the chosen line.
5. Use the ▲▼ buttons to enter the desired character and then move to the next character position by pressing the right arrow key. Repeat this step until the line is complete. A maximum of 20 alphanumeric characters can be entered.
6. Press **ENT** to accept the entered information.

7. At this time, either return to Step 4 to choose another line to edit, or end this procedure by highlighting Edit Complete and pressing the **ENT** key to return to the Setup Menu.
8. Press **ESC** to go to the Main Menu or the **RUN/HOLD** key to return to the Run/Hold screen.

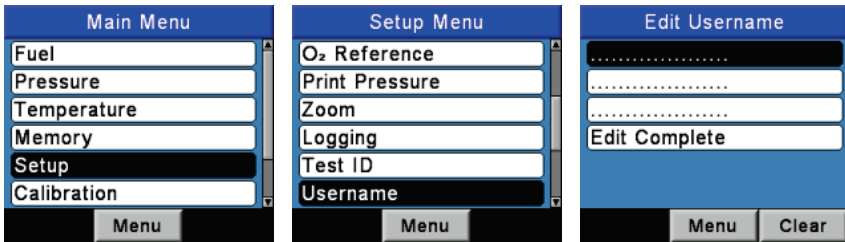

Figure 4-16. Entering a User Name

4.15.2. Clearing a User Name

1. Display the MAIN MENU by pressing the **MENU (F2)** button. If necessary, press **ESC** until MENU appears above F2.
2. Use the **▲▼** buttons to highlight **SETUP**, and then press **ENT** to display the SETUP MENU.
3. Use the **▲▼** buttons to highlight **USERNAME**, and then press **ENT** to display all three lines of the EDIT USERNAME screen. Periods (.....) identify empty lines.
4. Use the **▲▼** buttons to choose which of the three Username lines to clear, then press **CLEAR (F3)** to clear that line.
5. At this time, either return to Step 4 to choose another line to clear, or end this procedure by highlighting **EDIT COMPLETE** and pressing the **ENT** key to return to the Setup Menu.
6. Press **ESC** to go to the Main Menu or the **RUN/HOLD** key to return to the Run/Hold screen.

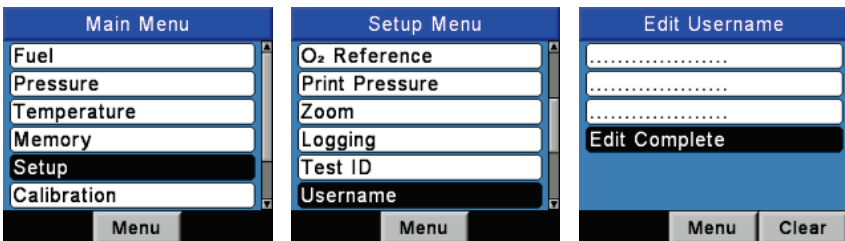

Figure 4-17. Clearing a User Name

4.16. Language

Information on the display screen can be shown in English, French, or Spanish. Select the desired language as follows.

1. Display the MAIN MENU by pressing the **MENU (F2)** button. If necessary, press **ESC** until MENU appears above **F2**.
2. Use the **▲▼** buttons to highlight SETUP, and then press **ENT** to display the SETUP MENU.
3. Use the **▲▼** buttons to highlight LANGUAGE SELECTION, and then press **ENT** to display The Language Selection Menu.
4. Use the **▲▼** buttons to highlight the desired language, then press **ENT** to activate the selection and re-display the Setup Menu.

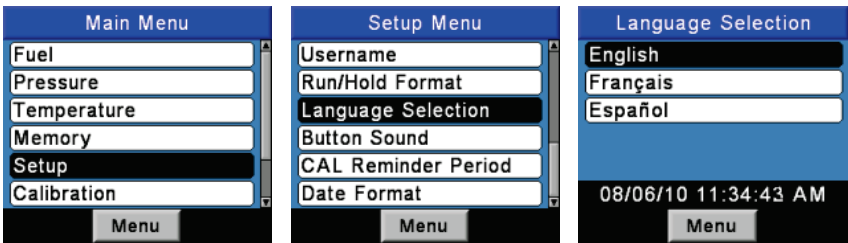

Figure 4-18. Selecting a Language

4.17. Cal Reminder Period

The analyzer can be set to indicate a calibration reminder during the 60 second warm-up period. Calibration reminders can be preset to occur never or at 6, 8, 10, 12, or 15 months after the last calibration. When the preset period is exceeded the instrument will display the reminder, and how long since the sensors were last calibrated. The reminder will be displayed at the end of the 60 second warm-up period. If a calibration reminder is displayed the operator can press the RUN/HOLD key to move to the Run/Hold screen for normal operation. Regular calibration periods of 6 months to a year for all gas sensors (except Oxygen) are recommended. Set the calibration reminder period as follows.

1. Display the MAIN MENU by pressing the **MENU (F2)** button. If necessary, press **ESC** until MENU appears above **F2**.
2. Use the **▲▼** buttons to highlight SETUP, and then press **ENT** to display the SETUP MENU.
3. Use the **▲▼** buttons to highlight CAL REMINDER PERIOD, and then press **ENT** to display CAL Reminder Period Menu.
4. Use the **▲▼** buttons to highlight the desired CAL reminder period, and then press the **ENT** key to activate the selection and re-display the Setup Menu.



NOTE: The date and time settings must be correct to get accurate calibration reminders.

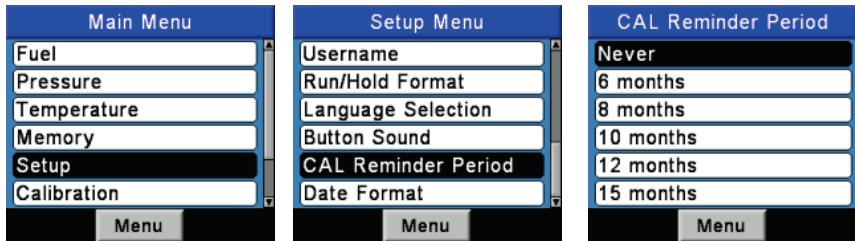

Figure 4-19. Selecting the Calibration Reminder Period

4.18. Run/Hold Screen Format

PCA[®]3 test data is located in the Run/Hold screen. By pressing the **RUN/HOLD** key, you should hear the pump running and see the word **RUN** at the upper left hand corner of the display. The instrument is continuously measuring and calculating the data that is shown in the Run/Hold screen. Press the **RUN/HOLD** key again, the pump should stop running and the word **HOLD** should be shown at the upper-left hand corner of the display. The instrument will now show the last measured and calculated data taken before the instrument was placed in **HOLD**. Use the up and down arrow keys to scroll through the complete list of measured and calculated values when the instrument is running or in the hold mode. The default order in which data appears in the Run/Hold screen is shown below.

O ₂	Oxygen
CO	Carbon Monoxide
EFF	Combustion Efficiency
CO ₂	Carbon Dioxide
T-STK	Stack Temperature
T-AIR	Ambient/Primary Air Temperature
EA	Excess Air
CO(#)	Carbon Monoxide content referenced to an Oxygen percentage
NO	Nitric Oxide
NO ₂	Nitrogen Dioxide
NOx	Oxides of Nitrogen (NO and NO ₂ combined)
SO ₂	Sulfur Dioxide
NO(#)	Nitric Oxide content referenced to an Oxygen percentage
NO ₂ (#)	Nitrogen Dioxide content referenced to an Oxygen percentage
NOx(#)	Oxides of Nitrogen content referenced to an Oxygen percentage
SO ₂ (#)	Sulfur Dioxide content referenced to an Oxygen percentage



NOTE: A number sign (#) denotes the current O₂ Reference selected.



NOTE: Stars (***) appear in measurement and calculation fields of sensors that are not installed.

Change the order in which data is displayed as follows.

1. Display the MAIN MENU by pressing the **MENU (F2)** button. If necessary, press **ESC** until MENU appears above **F2**.
2. Use the **▲▼** buttons to highlight SETUP, and then press **ENT** to display the SETUP MENU.
3. Use the **▲▼** buttons to highlight RUN/HOLD FORMAT, and then press **ENT** to display Run/Hold Format Menu.
4. Use the **▲▼** buttons to highlight Edit Format, and then press the **ENT** key to show the Edit Run/Hold Format, where the current order of combustion data is displayed.
5. Change data shown for a particular location by first using the **▲▼** buttons to highlight the location. Then press the **ENT** key to select the location; the cursor will start to flash.
6. Use the **▲▼** buttons to scroll through and select the desired data to appear at that location. Press the **ENT** key to make the selection.
7. Change data displayed at other locations by repeating Steps 5 and 6.
8. When finished, use the **▼** button to highlight Edit complete at the bottom of the list, then press **ENT** to save the new display format and return to the Run/Hold Format screen.

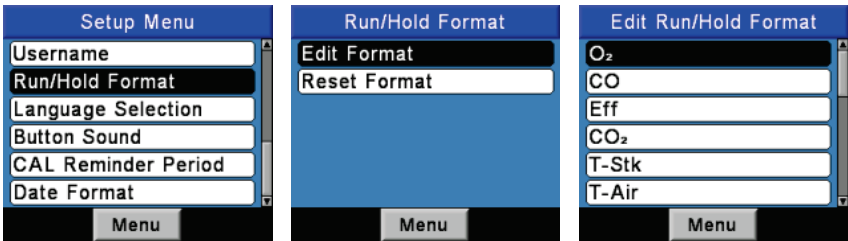

Figure 4-20. Changing the Order in Which Data Is Displayed

Reset Display format back to factory default settings as follows.

1. Display the MAIN MENU by pressing the **MENU (F2)** button. If necessary, press **ESC** until MENU appears above **F2**.
2. Use the **▲▼** buttons to highlight SETUP, and then press **ENT** to display the SETUP MENU.
3. Use the **▲▼** buttons to highlight RUN/HOLD FORMAT, and then press **ENT** to display Run/Hold Format Menu.

- Use the ▲▼ buttons to highlight RESET FORMAT, then press ENT to display the Reset Format screen.
- Use the ▲▼ buttons to select YES, then press ENT to reset the display and return to the Run/Hold Format screen.

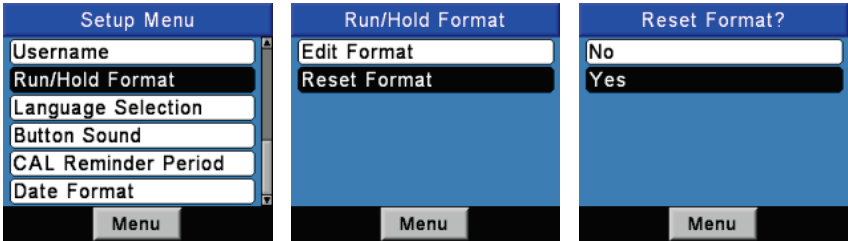

Figure 4-21. Resetting Display Formats Back to Factory Defaults

4.19. NO_x Calculation

NO_x is a combination of NO and NO₂. The actual NO_x value on the PCA3 is the sum of both NO and NO₂ readings (NO_x=NO+NO₂) from the sensors in positions 4 and 3, respectively. Analyzers having just the NO sensor (in sensor position #4) can display a *calculated* NO_x approximation using just the NO sensor reading and a multiplier of 1.05 (NO_x≈NO*1.05). This calculation is enabled by setting the NO_x Calculation option in the Setup Menu to ON.

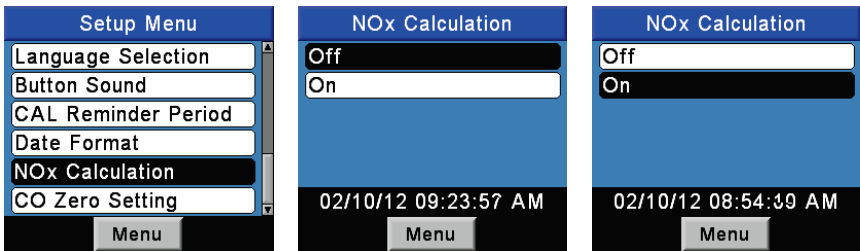

Figure 4-22. NO_x Calculation Screens

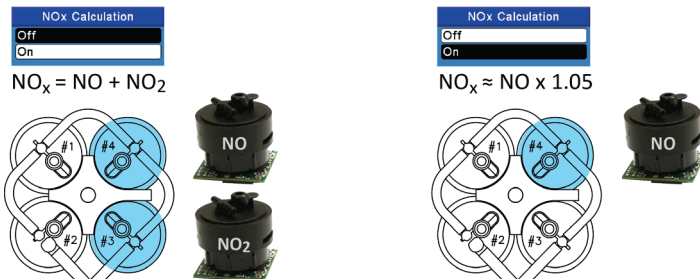

Figure 4-23. Sensor Configurations for Actual and Calculated NO_x Values

CHAPTER 5. OPERATION

5.1. Operating Tips

- When an analyzer is brought in from a cold vehicle, let it warm up slowly to minimize condensation. Temperatures below freezing will not damage the analyzer.



CAUTION: Although the analyzer itself is not damaged by an extremely cold environment, the electrochemical sensors may be damaged. The O₂ sensor's electrolyte will freeze at approximately -20 °F and the other sensors at approximately -94 °F. If the analyzer is exposed to an extremely cold condition, it is strongly suggested that the sensor housings be examined for hairline cracks. Be aware that a leaking sensor can cause chemical burns to the skin and possibly damage the PCB assemblies.

- Ensure that the analyzer is sampling fresh air when turned ON. Pulling a stack gas sample through the analyzer during its warm-up period will not damage the analyzer, but it will result in incorrect sensor readings, and may result in sensor error messages appearing after the warm-up cycle completes.
- Note that flue gas condensate is acidic and very corrosive. It is important not to allow the analyzer's internal components to come in contact with condensate for long periods of time.
- Before each use, inspect the filter element of the water trap / filter assembly. Replace the filter if it looks dirty. See Replacing the Filter Element on page 83.
- When sampling flue gas, keep the analyzer above the water trap, and keep the trap in a vertical position. This will maximize the effectiveness of the trap and keep liquid condensate from being drawn directly into the analyzer.
- When liquid condensate is seen inside the water trap, empty the trap before it becomes full. See Emptying the Water Trap on pages 49 and 83.
- The analyzer should be purged after performing a combustion test. After removing probe from the stack, let the pump run for at least 10 minutes to remove any stack gases and dry any condensate from inside the sensor chamber and probe assembly. If the analyzer is turned OFF with high levels of flue gas remaining in the analyzer, then the pump will continue to run and the message "PURGING SENSORS" will appear on the display until all flue gas levels fall below predetermined levels.
- When storing the analyzer, it's a good idea to empty the water trap and leave it open to further dry it out.
- Calibrate the analyzer every 6 months to 1 year to ensure its accuracy.

5.2. Turning On the Analyzer

Connect the probe and hose assembly, and make sure that the analyzer is properly set up according to Initial Setup (page 20) and Configuration Procedures (page 23).



IMPORTANT: DO NOT insert probe into stack before turning ON the analyzer!

1. Place the probe in an area that contains fresh air. This ensures that the sensors will be properly zeroed during the warm-up cycle.
2. Turn ON the analyzer by pressing the **I/O** button for at least 1 second, or until a single beep is heard. Observe that the analyzer's firmware version, model and serial numbers are briefly displayed followed by the Warm Up screen.
3. Wait for the analyzer to count down its 60-second warm-up period, after which, the instrument will display the Combustion Test HOLD screen.
4. If problems were detected during warm up, the message "ERRORS DETECTED" is displayed along with a list of those errors. As an example, the screen below shows that the battery is low. Refer to Error Messages (page 89) for a listing and possible remedy for the errors displayed.



NOTE: If the sensors in error are not critical to the combustion test, then press the **RUN/HOLD** button to display the Combustion Test HOLD screen and proceed with the test.

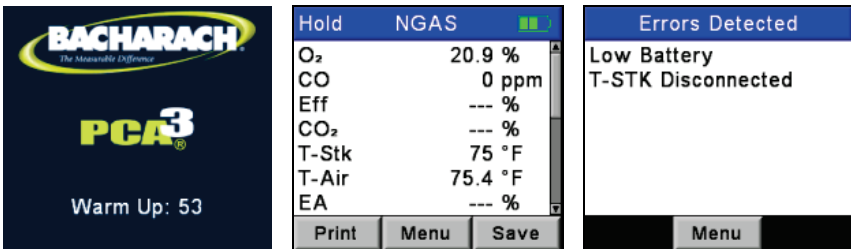

Figure 5-1. Turning On the Analyzer and Warm-up

5.3. Low Battery Alarm

When the batteries are nearly depleted, an empty battery icon appears in the upper right corner of the display, and a short beep is sounded every 10 seconds.

After a low battery alarm occurs, the analyzer will continue to operate for only a few minutes. The amount of operating time that remains depends on many factors (e.g., pump and keypad backlight being ON or OFF, and the type and condition of the batteries).

5.4. Locating Sampling Points

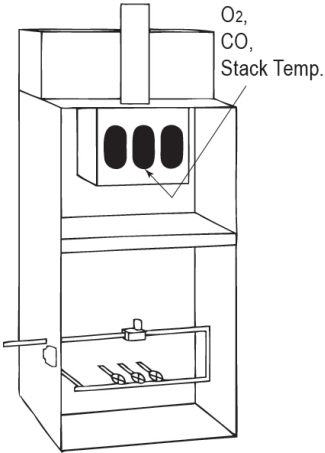
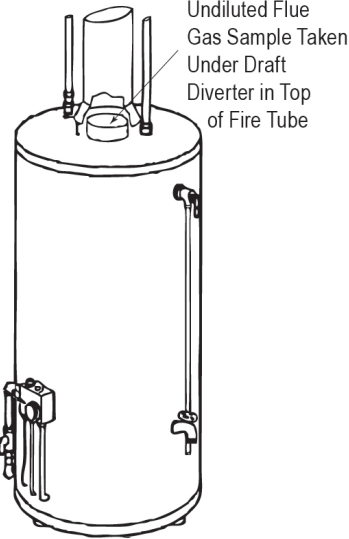
Forced Air Furnace	Hot Water Tank
 <p data-bbox="370 594 476 675">O₂, CO, Stack Temp.</p> <p data-bbox="153 1057 474 1084">Figure 5-2. Forced Air Furnace</p>	 <p data-bbox="761 508 926 638">Undiluted Flue Gas Sample Taken Under Draft Diverter in Top of Fire Tube</p> <p data-bbox="607 1057 891 1084">Figure 5-3. Hot Water Tank</p>
<p data-bbox="109 1109 511 1300">For atmospheric burner or gravity vented, forced air heating equipment with a clamshell or sectional heat exchanger design, test each of the exhaust ports at the top of the heat exchanger. The probe should be inserted back into each of the exhaust ports to obtain a flue gas sample, before any dilution air is mixed in.</p>	<p data-bbox="543 1109 923 1227">Domestic hot water tanks with the 'bell' shaped draft diverter can be accurately tested by inserting the probe tip directly into the top of the fire tube below the diverter.</p>

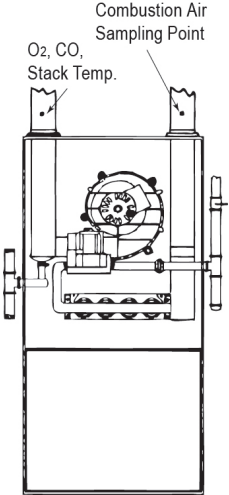
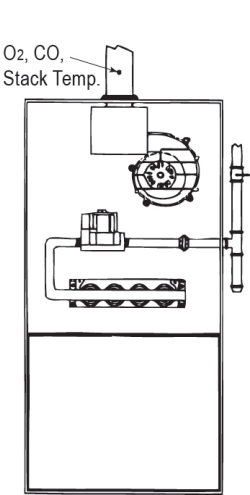
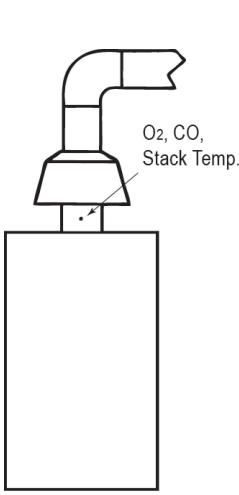
<p>90% Efficiency Condensing Furnace</p>	<p>80% Efficiency Fan Assist or Power Vented Furnace</p>	<p>Atmospheric/Gravity Vented Boiler</p>
 <p>Figure 5-4. 90% Efficiency Condensing Furnace</p>	 <p>Figure 5-5. 80% Efficiency Fan Assist or Power Vented Furnace</p>	 <p>Figure 5-6. Atmospheric/Gravity Vented Boiler</p>
<p>Condensing furnaces/boilers can be tested through a hole drilled in the plastic vent pipe (when allowed by the manufacturer or local authority of jurisdiction) or taken from the exhaust termination.</p>	<p>Combustion testing of fan assist or power vented, furnaces/boilers should be done through a hole drilled in the vent immediately above the inducer fan.</p>	<p>Boilers, which have a 'bell' shaped draft diverter on top, should be tested directly below the diverter through a hole drilled in the vent connector.</p>

5.5. Performing a Combustion Test

Ensure that the following items have been completed.

- Turn ON analyzer and allow it to warm up (see page 41)
- Select fuel being burned (see page 23)
- Inset probe into stack (see page 42)
- If necessary, insert the optional primary air thermocouple into the combustion air stream of the burners that use an outside source of combustion air.

Next, proceed with the combustion test as described below.

Run NGAS	
O ₂	4.0 %
CO	13 ppm
Eff	82.9 %
CO ₂	9.6 %
T-Stk	374 °F
T-Air	76.6 °F
EA	20.9 %
<div style="display: flex; justify-content: space-between; width: 100%;"> Print Menu Save </div>	

Figure 5-7. Performing a Combustion Test

1. Press the **RUN/HOLD** button to start the test. You should hear the pump start running and see the word RUN appear at the top of the Combustion Test screen.

Sensor Indicators: The following indicators appear in the sensor's data field depending on certain conditions:

- (* * *) Sensor that is not calibrated or installed.
- (XXX) Sensor over range
- (- - -) The calculated data cannot be displayed because the measured data necessary to make the calculation is out of range (i.e., oxygen level above 16%).

2. Use the up and down arrow keys to scroll to the T-STK reading. Loosen the thumbscrew on the probe stop and move the probe in and out of the stack until the stack's core temperature (hot spot) is located as indicated by the highest T-STK reading; then tighten the thumbscrew to prevent further probe movement. Locating the highest stack temperature is very important for accurate efficiency calculations.
3. You can now begin burner service procedures. The analyzer readings will change quickly to show changes in burner performance.



CAUTION: Position the water trap with its gas flow arrow pointing upward. Do not let water condensate go above the tip of the riser tube. The sensors could be damaged if water would enter the analyzer. Empty the water trap after every combustion test. See Emptying the Water Trap on pages 49 and 83.

4. Pressing the **RUN/HOLD** button holds all readings, stops the pump and displays the Combustion Test HOLD screen. Press the ▲ ▼ buttons to scroll through all test values. Pressing **RUN/HOLD** again restarts the pump and resumes testing.

List of Combustion Test Data

Display Name	Description of Measurement or Calculation
O ₂	% Oxygen
CO	Carbon Monoxide (1)
EFF	Combustion Efficiency
CO ₂	% Carbon Dioxide
T-STK	Stack Temperature
T-AIR	Primary/Ambient Air Temperature as measured either internally or by an optional external thermocouple plugged into the analyzer's T-AIR connector.
EA	% Excess Air
CO(#)	Carbon Monoxide ppm level referenced to a % of oxygen (2)
NO	Nitric Oxide (1)
NO ₂	Nitrogen Dioxide (1)
NO _x	Oxides of Nitrogen (NO and NO ₂ combined) (1)
SO ₂	Sulfur Dioxide (1)
NO(#)	Nitric Oxide ppm level referenced to a % of oxygen (2)
NO ₂ (#)	Nitrogen Dioxide ppm level referenced to a % of oxygen (2)
NO _x (#)	Oxides of Nitrogen ppm level referenced to a % of oxygen (2)
SO ₂ (#)	Sulfur Dioxide ppm level referenced to a % of oxygen (2)
NO-T	Nitric Oxide Sensor Temperature (3)

- (1) See page 27 for pollution unit of measure selected.
 (2) The “#” represents the selected oxygen reference level of between 0 and 15% (see page 29).
 (3) Only shown if selected in the Run/Hold Format menu (see page 37).



NOTE: Stars (* * *) appear in measurement and calculation fields of sensors that are not installed.

5.6. Selecting a Pressure Label

The pressure measurement can be labeled with types including, differential across heat exchanger, draft reading, and differential pressure. See page 47 for pressure and draft measurement procedures. Label data as follows.

1. Display the MAIN MENU by pressing the **MENU (F2)** button. If necessary, press **ESC** until MENU appears above **F2**.
2. Use the **▲ ▼** buttons to highlight PRESSURE, and then press **ENT** to display the PRESSURE MENU.
3. Use the **◀ ▶** buttons to scroll through the available pressure label types. The current label is used, saved, and printed with the record.

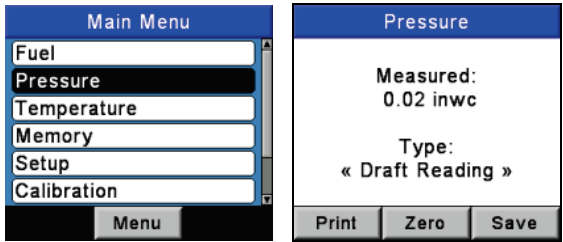

Figure 5-8. Selecting a Pressure Label

5.7. Temperature Label Selection and Measurement

The difference in temperature between two areas can be measured by using the analyzer's two temperature channels and the Temperature screen. By using the T-Air channel as a reference, the temperature applied to the T-Stack channel will be displayed on the Temperature Measurement screen as differential temperature between the two channels. Additionally, the temperature measurement can be labeled. Label types include differential temperature across heat exchange or differential temperature. Perform a differential temperature measurement as follows.

1. Display the MAIN MENU by pressing the **MENU (F2)** button. If necessary, press **ESC** until MENU appears above **F2**.
2. Use the **▲ ▼** buttons to highlight TEMPERATURE, and then press **ENT** to display the TEMPERATURE MEASUREMENT screen.
3. Install thermocouples in both temperature channel connectors.
4. Before taking a measurement, the temperature channels may need to be zeroed, if not already displaying zero with both thermocouples exposed to the same condition. Press **ZERO (F2)** if needed.
5. To label the data use the **◀ ▶** buttons to scroll through the available temperature label types. The current label will be used, saved, and printed with the record.
6. Press **ENT** to save the selection and re-display the TEMPERATURE MENU or **ESC** to exit back to the Main Menu.

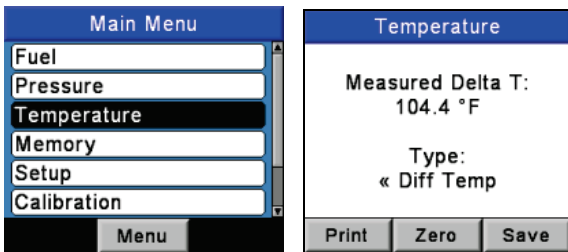

Figure 5-9. Performing a Temperature Measurement

5.8. Performing a Draft / Pressure Measurement

The difference in pressure (ΔP) between two areas can be measured by using the analyzer's two pressure ports and the PRESSURE screen. By using the $-\Delta P$ port as the reference, the pressure applied to the ΔP port will be displayed on the PRESSURE screen as the differential pressure between the two ports. Perform a draft / pressure measurement as follows.

1. Turn ON the analyzer and allow it to complete its warm-up cycle (see page 9, 16, and 20).



NOTE: Refer to Pressure Units Selection on page 26 for information on selecting the pressure units of measure.

2. Display the MAIN MENU by pressing the **MENU (F2)** button. If necessary, press **ESC** until MENU appears above **F2**.
3. Use the **▲ ▼** buttons to highlight PRESSURE, and then press **ENT** to display the PRESSURE screen.
4. Before taking a measurement, the pressure sensor may need to be re-zeroed if it is not already displaying zero with both pressure ports open to the atmosphere. If necessary, zero the pressure sensor as follows.
 - Press the **ZERO (F2)** button.
 - Disconnect any hoses connected to the $+\Delta P$ and $-\Delta P$ ports, and then press **ENT** to zero the pressure sensor.
 - Reconnect any hoses. When measuring draft, simply leave the $-\Delta P$ port open to the atmosphere and connect the probe's draft hose to the $+\Delta P$ port (see Figure 5-12).

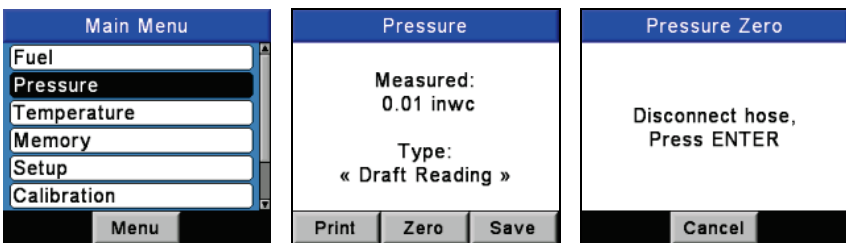

Figure 5-10. Performing a Draft/Pressure Measurement

5. Do one of the following to measure draft or differential pressure:
 - To measure draft, simply insert the probe into the stack and observe the draft reading on the PRESSURE screen.
 - To measure differential pressure, connect two sampling hoses to the $+\Delta P$ and $-\Delta P$ ports, and place the open end of each hose into the areas being measured. The

differential pressure between the two areas is now displayed on the PRESSURE screen. If the pressure at the + ΔP port is higher than the - ΔP port, then the pressure reading will be positive. If it is lower, then the reading will be negative.

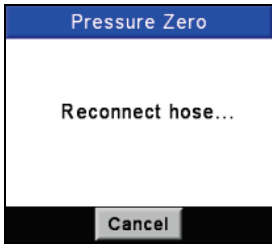

Figure 5-11. Pressure Zero Screen

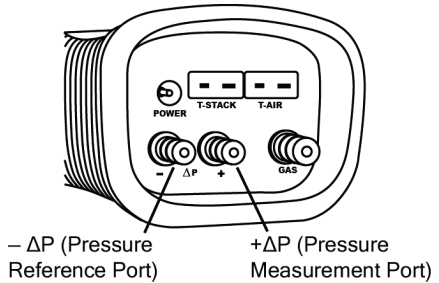

Figure 5-12. Draft/Pressure Measurement Hose Connections

5.9. Saving Test Data

Up to 500 individual sets (“snap shots”) of combustion test, pressure, or temperature data can be saved in memory, which can later be recalled for viewing from the Memory Directory (see Recalling Combustion Test Data section on page 54).

1. First display the screen that contains the data to be saved. In the example below, all data associated with the Combustion Test RUN screen will be saved.
2. Press the **SAVE (F3)** button to save the test data in the next available memory location.



NOTE: When memory is full, the next reading will not be saved until space is made available by clearing the data (see Clearing Memory section on page 56).

Run	NGAS	
O ₂	4.0 %	A
CO	12 ppm	
Eff	82.9 %	
CO ₂	9.5 %	
T-Stk	375 °F	
T-Air	77.5 °F	
EA	21.3 %	
<div style="display: flex; justify-content: space-between; width: 100%;"> Print Menu Save </div>		

Figure 5-13. Saving Test Data

5.10. Ending a Combustion Test



WARNING: Burn Hazard. Do not touch the probe after removing it from the stack. Allow the probe to cool before handling (about 5 minutes).

1. Remove probe from stack.
2. Allow the pump to run until all combustion gases have been flushed from the analyzer with fresh air as indicated by the O₂ reading returning to 20.9%.

5.11. Emptying the Water Trap

The Water Trap / Filter Assembly removes stack gas condensate, and also prevents soot from contaminating the internal components of the analyzer.



IMPORTANT: Use the Water Trap / Filter Assembly in a vertical position with the gas flow arrow pointing up as shown in the illustration below.

1. Empty the water trap chamber after each combustion test, or stop the test and empty the chamber if the liquid condensate level approaches the tip of the riser tube.
2. To empty the trap, first pull apart the two halves of the Water Trap using a slight twisting motion; empty the water trap chamber; and then reassemble the trap.
3. After each combustion test, also check the Water Trap's filter element. If it looks dirty, replace the filter (see Replacing the Filter Element on page 83).

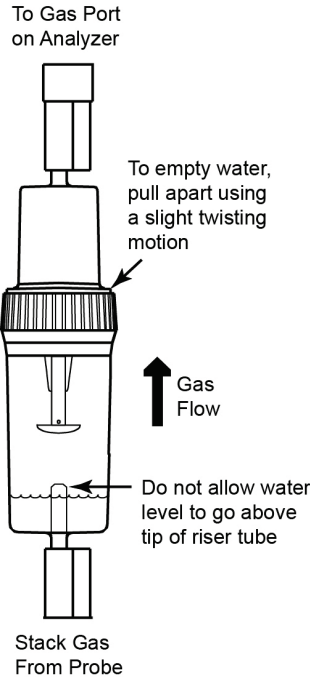

Figure 5-14. Emptying the Water Trap

5.12. Data Logging

5.12.1. Overview

When the logging function is activated, up to 500 combustion test records will be automatically stored in memory at a preset interval over a predetermined duration.

The maximum duration that data can be collected is determined by the interval. For example, if the interval is set to 10 seconds, then the maximum selectable length of time in which data can be collected to fill 500 memory locations would be 1 hour (500 x 10 seconds = 5000 seconds or 83 minutes). If the operator chooses a duration that is longer than possible for the interval chosen, then the analyzer automatically selects the highest duration possible for the selected interval.

The stored logged data can either be viewed on the display using the analyzer's memory function (see Memory Functions on page 54), or downloaded to a personal computer using the supplied Fyrite[®] User Software and USB cable. Downloaded data is stored on the computer's hard drive as a comma separated value ASCII text file with a CSV extension, which can be opened by most spreadsheet programs for analysis.

Logging Intervals and Durations

Logging Intervals
1 second
5 second
10 second
15 second
30 second
1 minute
2 minutes
5 minutes
10 minutes

Logging Durations
5 minutes
10 minutes
15 minutes
30 minutes
1 hour
2 hours
5 hours
10 hours
24 hours
48 hours

5.12.2. Turning On Data Logging



IMPORTANT: Before turning ON data logging and starting the data logging process, the analyzer should already be set up to perform a combustion test (see Performing a Combustion Test section on page 43).

Turn ON data logging as follows.

1. Display the MAIN MENU by pressing the **MENU (F2)** button. If necessary, press ESC until MENU appears above **F2**.
2. Use the **▲▼** buttons to highlight SETUP, and then press **ENT** to display the SETUP MENU.
3. Use the **▲▼** buttons to highlight LOGGING, and then press **ENT** to display the LOGGING screen.



NOTE: The amount of memory available for storing new data is displayed in the LOGGING screen (maximum of 500 locations). If previous logging sessions are stored, and additional memory is needed, clear the logging memory (see Clearing Memory section on page 56).



NOTE: At no time will new logging data over write old data. Logging will stop when available memory is filled.

4. Use the **▲▼** buttons to highlight YES (turn logging ON).
5. Press **ENT** to make the selection and display the LOGGING INTERVAL screen.

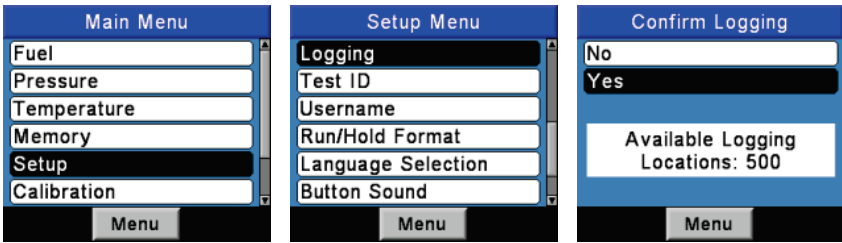

Figure 5-15. Turning On Data Logging

5.12.3. Setting the Logging Interval and Duration

The logging interval is the length of time between measurements, while the logging duration is the time allocated to the logging process. Set the logging interval and duration as follows.



NOTE: If the duration is set for more than 10 hours, we recommend using the optional AC power adapter to power the analyzer.

1. As soon as logging is turned ON (see Logging Selection on page 31), the LOGGING INTERVAL screen appears.
2. Use the ▲ ▼ buttons to highlight the desired interval, and then press **ENT** to make the selection and display the LOGGING DURATION screen. In this example, 1 minute has been selected.
3. Use the ▲ ▼ buttons to highlight the desired duration, and then press **ENT** to make the selection and display the LOGGING SUMMARY screen. In this example, 2 hours has been selected.



NOTE: If the selected duration requires more memory than is currently available, the analyzer will automatically select the longest duration possible for the selected interval.

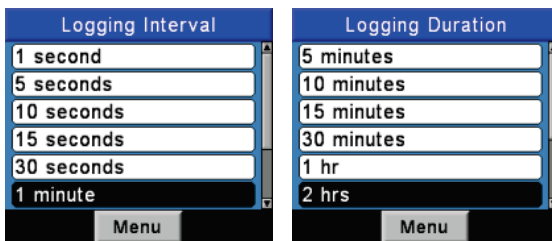

Figure 5-16. Setting the Logging Interval

5.12.4. Starting the Data Logging Process

After turning ON data logging and setting the interval and duration, the analyzer will pause at the LOGGING SUMMARY screen, where the currently selected interval and duration time periods are displayed.

Press **ENT** to start the combustion test and logging process. At this time the Combustion Test LOG screen will appear, indicating that the analyzer is now performing a combustion test and the data is being stored in memory.



NOTE: At the top of the screen, the memory location where the current log entry is being saved is displayed.



NOTE: If there were previously stored log entries, each new logging session will start to store data in the next available memory location.



NOTE: At no time will new data overwrite old data. Logging will stop when available memory is filled.

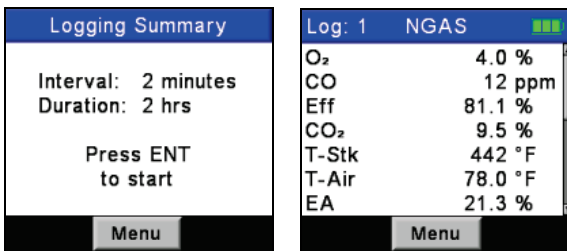

Figure 5-17. Starting the Data Logging Process

5.12.5. Ending the Data Logging Process

Data logging will stop and the pump will turn OFF after the prescribed duration, or after all 500 memory locations are filled.

To exit the Combustion Test LOG screen, press the **RUN/HOLD** button twice to display the Combustion Test HOLD screen.



NOTE: To end the logging process at any time, press the **ESC** button.



NOTE: If the logging process was stopped by pressing **ESC**, it cannot be resumed without first turning logging back ON.

5.13. Memory Functions

5.13.1. Overview

There are two memory banks, each containing 500 memory locations. The first bank is used to store combustion test data as described in Saving Test Data (page 48), while the second bank is used to store logged combustion test data as described in Data Logging (page 50). Each bank is independent of each other, and cannot share data or be combined.

Individual memory locations in each memory bank can be recalled for viewing on the display or printed, or the entire contents of each memory bank can be individually downloaded to a computer and viewed in a spreadsheet program for analysis. These functions are explained in the sections that follow.



NOTE: When displaying the contents of either memory bank, the operator can quickly page through the screens by pressing the **PAGE- (F1)** and **PAGE+ (F3)** buttons. Or move to the first or last memory location by pressing the **◀▶** buttons, respectively.

5.13.2. Recalling Combustion Test Data

Recall individual combustion test data records as follows.

1. Display the MAIN MENU by pressing the **MENU (F2)** button. If necessary, press **ESC** until MENU appears above **F2**.
 2. Use the **▲▼** buttons to highlight MEMORY, and then press **ENT** to display the MEMORY MENU.
 3. Use the **▲▼** buttons to highlight MEMORY DIRECTORY, and then press **ENT** to display the MEMORY DIRECTORY screen.
 4. Use the **▲▼** buttons to highlight the desired memory location to be recalled. Each memory location is identified by the date and time at which data was saved. The word EMPTY signifies that the memory location does not contain data.
 5. Press **ENT** to display the data contained in the selected memory location.
-



NOTE: The top line of the recalled combustion test data screen shows the memory location being viewed. In this example, "MEM:1" is being displayed.



NOTE: The recalled combustion test data can be printed by pressing the **PRINT (F1)** button. Refer to Printing Test Data on page 59.

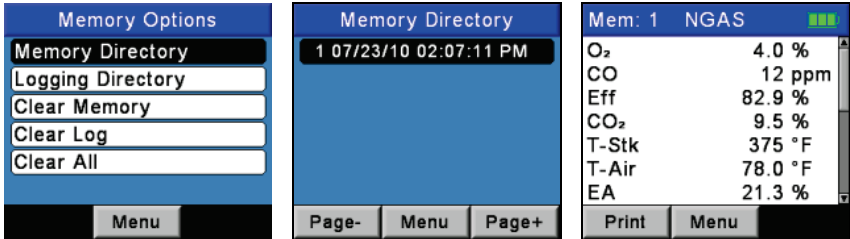

Figure 5-18. Recalling Combustion Test Data

5.13.3. Recalling Logged Test Data

Recall individual logged combustion test data records as follows.

1. Display the MAIN MENU by pressing the **MENU (F2)** button. If necessary, press **ESC** until MENU appears above **F2**.
2. Use the **▲▼** buttons to highlight MEMORY, and then press **ENT** to display the MEMORY MENU.
3. Use the **▲▼** buttons to highlight LOGGING DIRECTORY, and then press **ENT** to display the LOGGING DIRECTORY screen.
4. Use the **▲▼** buttons to highlight the desired data logging location to be recalled. Each logging location is identified by the date and time at which the data was saved. The word EMPTY signifies that the logging location does not contain data.
5. Press **ENT** to display the logging data contained in the selected memory location.



NOTE: The top line of the log test data screen shows the log location being viewed. In this example, "Log: 1" is being displayed.



NOTE: The recalled logged test data can be printed by pressing the **PRINT (F1)** button. Refer to Printing Test Data on page 59.

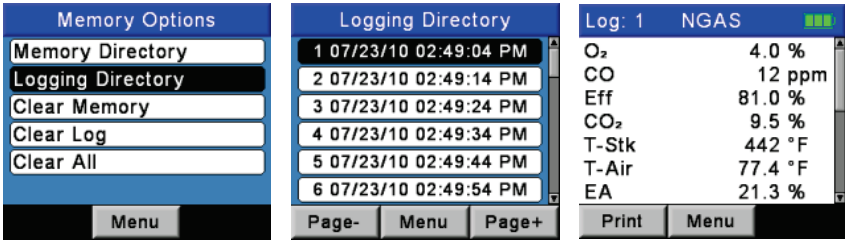

Figure 5-19. Recalling Logged Test Data

5.13.4. Clearing Memory

When all memory locations used to store individual combustion test records have been filled, the next combustion test record saved will not overwrite the oldest. When all logging memory locations in the logging directory are full, they must be manually cleared in order to store new data. At no time will the logging process overwrite older data. Logging will stop when available memory is filled. Each memory bank can be individually cleared, or all memory locations in both banks can be cleared simultaneously. Do the following to clear memory:

1. Display the MAIN MENU by pressing the **MENU (F2)** button. If necessary, press **ESC** until MENU appears above **F2**.
2. Use the **▲▼** buttons to highlight MEMORY, and then press **ENT** to display the MEMORY MENU.



Figure 5-20. Clearing Memory

3. Use the **▲▼** buttons to highlight one of the following:
 - CLEAR MEMORY DATA clears only the individual saved combustion test records.
 - CLEAR LOGGING DATA clears only the combustion test records that were saved during the logging process.
 - CLEAR ALL MEMORY clears all memory locations in both memory banks.
4. Press **ENT** to display the CLEAR MEMORY, LOGGING, or ALL DATA conformation screen. Highlight YES to confirm that memory is to be cleared, and then press **ENT** to actually clear memory as evidenced by the display of the “WAIT Erasing memory” screen.

5.14. Downloading Stored Data to a Computer

The combustion test data that was stored in either the analyzer's Memory Directory or Logging Directory (see Memory Functions on page 54), can be downloaded to a computer using the Fyrite[®] User Software and USB cable that are supplied with the analyzer.

The downloaded data is stored on the computer's hard drive – or removable media of the operator's choosing – as a comma-separated-value ASCII text file with a CSV extension. This type of file can be opened by most spreadsheet programs for analysis.

For information on the installation of the Fyrite[®] User Software, refer to the installation document (provided in .PDF format) on the software disk. The Fyrite[®] User Software installation manual may also be downloaded from the PCA[®] 3 page of the Bacharach website (www.MyBacharach.com). Refer to manual 0024-9465. Minimum computer requirements for installation and use of the Fyrite[®] User Software are shown below.

Minimum Computer Requirements for Fyrite[®] User Software

Category	Minimum Requirement
Operating System	Windows XP or higher
Drive	CD ROM drive
Access Port	USB port (USB 1.1, 2.0, or 3.0)
Hard Drive Space	Software: 205 MB for the Fyrite [®] User Software Data: Additional 350 KB for each downloaded file

5.15. Importing Saved Data into a Spreadsheet

Data that was recovered and saved as an ASCII text file with a "CSV" extension, as described above, can easily be opened for viewing in most spreadsheet programs by simply double-clicking the filename. For example: double-clicking the filename Customer XYZ.csv should automatically open the spreadsheet program and display the contents of the file.

If the spreadsheet program does not recognize the "CSV" file extension, then refer to the spreadsheet's documentation for information on how to manually import comma-delimited text files.

The table below contains listings and descriptions of the 32 data fields that are downloaded with each data record. Note that for sensors that are not installed, all related data fields for those sensors will be marked as "****". For example, if the analyzer does not contain an SO₂ sensor, then "****" will appear in data fields 23 and 24.

Downloaded Data Fields

Field	Column Name	Data Name or Value
1	Date	Date of Test in mm/dd/yy
2	Time	Time of Test in 12 hour format (AM/PM)
3-5	Test ID	Information Input by User
6	Fuel	Fuel Name
7	%O ₂	Oxygen Level
8	CO	Carbon Monoxide Level (see field 30)
9	ppm CO(O ₂)	Carbon Monoxide Level referenced to a % of O ₂ (see field 25)
10	% Efficiency	Combustion Efficiency
11	% CO ₂	Carbon Dioxide Level
12	%EA	Excess Air
13	TStk	Stack Temperature
14	TAir	Primary/Ambient Air Temperature
15	Delta-T	Differential Temperature Value
16	TempUnit	Temperature Units
17	NO	Nitric Oxide Level (see field 30)
18	ppm NO(O ₂)	Nitric Oxide Level referenced to a % of O ₂ (see field 26)
19	NO ₂	Nitrogen Dioxide Level (see field 30)
20	ppm NO ₂ (O ₂)	Nitrogen Dioxide Level referenced to a % of O ₂ (see field 26)
21	NO _x	Nitrogen Oxides (NO+NO ₂) (see field 30)
22	ppm NO _x (O ₂)	Nitrogen Oxides Level as referenced to a % of O ₂ (see field 26)
23	SO ₂	Sulfur Dioxide (see field 30)
24	ppm SO ₂ (O ₂)	Sulfur Dioxide Level referenced to a % of O ₂ (see field 27)
25	CO_O ₂ Ref	%O ₂ Reference for CO ⁽¹⁾
26	NO _x _O ₂ Ref	%O ₂ Reference for NOx ⁽¹⁾
27	SO ₂ _O ₂ Ref	%O ₂ Reference for SO ₂ ⁽¹⁾
28	Pressure	Pressure (Draft) Value
29	Pressure Units	Pressure Units of Measure ⁽²⁾
30	Pollution Units	Pollution Units of Measure ⁽³⁾
31	PS Voltage	Power Supply Voltage
32	NO Temp	Nitric Oxide Sensor Temperature

(1) %O₂ reference as selected (refer to O2 Reference Setup on page 29)

(2) Pressure units as selected (refer to Pressure Units Selection on page 26)

(3) Pollution units as selected (refer to Pollution Units Selection on page 27)

5.16. Printing Test Data

Combustion or pressure data that is currently being displayed can be sent to a printer using IrDA protocol as described below.

Data that is stored in memory can also be printed by first displaying the stored test data as described in the Recalling Combustion Test Data section (page 54) and the Recalling Logged Test Data section (page 55).

In addition to printing combustion and pressure data, the contents of any screen that shows the label "PRINT" above the **F1** button can be printed. For example, the information shown in the DIAGNOSTIC screen can be printed.

1. Turn ON printer. Refer to the printer's instruction manual for detailed operating information. If not already done, set up the printer for:
 - 8 bit
 - No parity
 - 9600 baud
 - IrDA is set to IrDA-SIR
 - DTR handshaking.
2. Align the printer with the top of the analyzer as shown in Figure 5-21.
3. Press the **PRINT (F1)** button to begin printing.

The printout shown in Figure 5-21 shows typical combustion test results of an analyzer containing O₂, CO_{LOW}, NO, and NO₂ sensors. Note that since the SO₂ sensor is not installed, three stars (* * *) appear in their data fields.



NOTE: Three Stars (***) appear in the data field of sensors that are not calibrated or installed, and in the data fields of that sensor's related calculated values.



NOTE: Three hyphens or dashes (---) indicate that the calculated data cannot be displayed because the measured data necessary to make the calculation is out of range (i.e., oxygen level above 16%).



NOTE: Three Xs (i.e., X X X) indicate the sensor is over range.

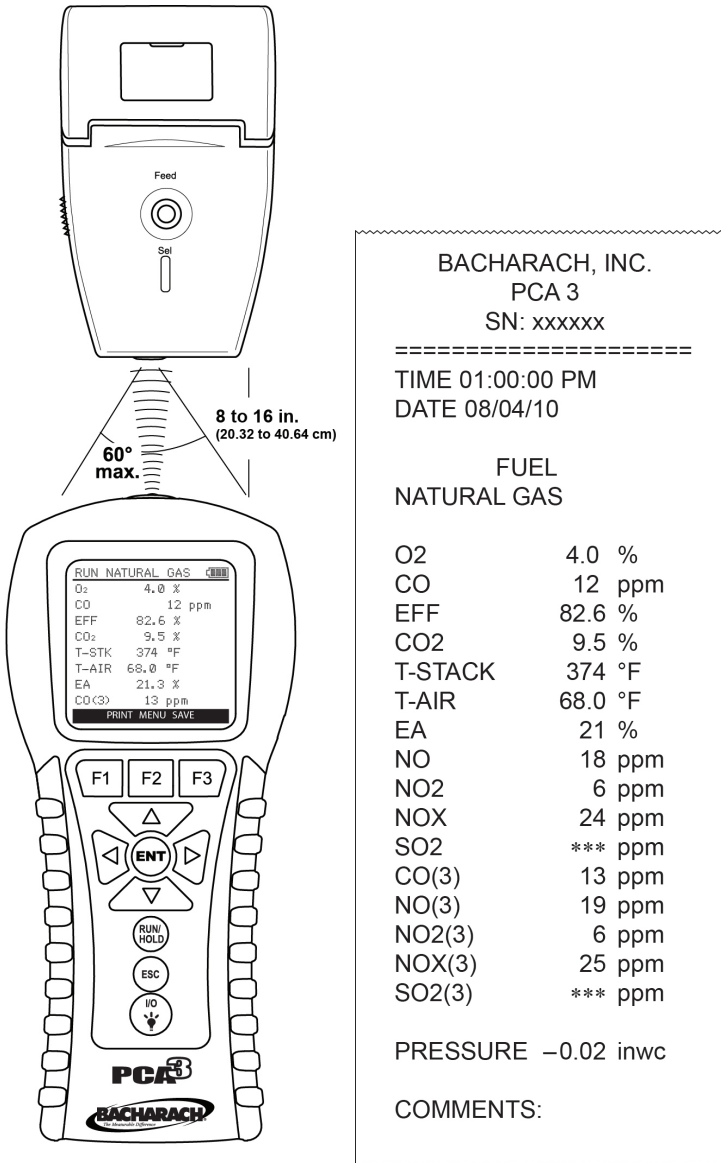

Figure 5-21. Printer Alignment and Sample Printout

5.17. Turning Off the Analyzer and Purging

Turn OFF the analyzer by pressing the **I/O** button for at least 2 seconds, or until two beeps are heard. The unit will count down 5 seconds before shutting down, giving the operator an opportunity to keep the analyzer turned ON by pressing the **RUN/HOLD** button.

If the PCA[®]3 was not purged with fresh air (as described in Ending a Combustion Test on page 49), then the analyzer may remain ON with its pump running and display the message "PURGING SENSORS" as the result of combustion gases still being present inside the analyzer. At this time the operator should ensure that the probe is removed from the stack, allowing the analyzer to purge itself with fresh air. The 5-second shutdown sequence will not begin until the gas levels inside the analyzer drop below predetermined levels.



NOTE: Although not recommended, the purging process can be bypassed by pressing the **I/O** button a second time.

CHAPTER 6. CALIBRATION



IMPORTANT: Before performing any calibration procedure ensure that new batteries are installed or use the optional AC power adapter. Also ensure that the analyzer is at room temperature and will be sampling fresh air when turned ON.

6.1. B-Smart Sensors

The PCA[®] 3 uses Bacharach's B-Smart[®] Sensor technology for CO_{LOW}, CO_{HIGH}, NO, NO₂, and SO₂. The B-Smart[®] Sensor is marked with a 10- or 14-digit calibration code that can be entered in the instrument's calibration screen via the keypad, or with the Fyrite[®] User Software.

Benefits of the B-Smart[®] Sensors include the following:

- New sensors can be installed without applying gas for calibration.
- Sensors can be pre-calibrated and installed when needed
- Sensors can be moved from one analyzer to another.
- The analyzer's diagnostics screen shows what sensors are installed, and their current end-of-life condition (Good, Low, Bad).

B-Smart[®] sensors should be calibrated by an authorized Bacharach Service Center (see Service Centers on page 95) every 6 months to 1 year to assure that the analyzer continues to meet its published accuracy specifications. B-Smart[®] sensors, however, can be calibrated in the field if your facility has the necessary equipment and qualified personnel to perform the procedures described in the following sections.

6.2. Starting a Calibration

Start any calibration procedure by doing the following.

1. Place the probe in an area of fresh air, turn ON the analyzer, allowing it to cycle through its 60 second warm-up period. During warm-up, the analyzer's operation is checked and the sensors are set to the following ambient conditions:
 - Oxygen sensor spanned to 20.9%
 - All gas sensors are zeroed
 - The pressure sensor is zeroed
2. Any errors detected during warm-up will be listed on the display immediately following warm-up. Correct any errors before proceeding. Refer to page 89 (Error Messages) for a listing of error messages and their meaning.
3. Display the MAIN MENU by pressing the **MENU (F2)** button. If necessary, press **ESC** until MENU appears above **F2**.
4. Use the **▲ ▼** buttons to highlight CALIBRATION, and then press **ENT** to display the CALIBRATION PASSWORD screen.

- Before calibration can begin a 4-character alphanumeric password must be entered. Use the ▲▼ and ◀▶ buttons to enter the password. (The default password is 1111.)
- Press the **ENT** key to accept the password. If the correct password was entered the CALIBRATION LIST Menu will be displayed.
- Use the ▲▼ buttons to highlight the sensor to be calibrated, and then perform the calibration procedure for that sensor as described in the following sections.

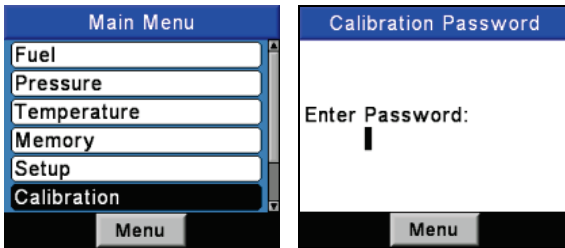

Figure 6-1. Starting a Calibration

6.3. B-Smart[®] Sensor Replacement and Calibration

To replace a B-Smart[®] sensor and calibrate, do the following.

- Enter the CALIBRATION MENU.
- Use the ▲▼ buttons to select B-SMART[®]. Press **ENTER** to display the B-Smart[®] code screen.
- Use the ▲▼ buttons to enter the 10- or 14-digit alphanumeric code supplied with the B-Smart[®] sensor. Use the ◀▶ buttons to move the cursor across the screen. Press **ENTER**.



NOTE: There are two B-Smart[®] sensor code lengths: 10 digits for CO_{HIGH}, NO, NO₂, and SO₂, and 14 digits for CO_{LOW}.



NOTE: If the correct code was entered, the analyzer accepts it and returns to the CALIBRATION MENU. If an incorrect code was entered, the screen will display "Invalid Code". Check to make sure the correct code has been entered. If the problem persists, contact your nearest Bacharach Service Center.



NOTE: To save time, B-Smart[®] codes can be entered using the Fyrite User Software.

Bacharach also offers a convenient exchange program that allows the customer to regularly send in old sensors and, as scheduled, receive calibrated replacements. Contact Bacharach customer service for more details about the exchange program.

6.4. Pressure Sensor Calibration

This procedure calibrates the pressure sensor to a known pressure value.

6.4.1. Material Required

- Bellows
- Manometer:
 - Range: ± 8 in. of water column (± 20 mb)
 - Accuracy: ± 0.01 in. of water column (± 0.025 mb)

6.4.2. Procedure



NOTE: The unit of measure for pressure is selected in the Pressure Units Selection section on page 26. In the following procedure, inwc is selected, but note that any unit of measure can be used for calibration purposes.

1. Assemble the pressure sensor calibration equipment as shown in Figure 6-3, but **DO NOT** connect the analyzer to the calibration equipment at this time.
2. If not already done, turn **ON** the analyzer and display the CALIBRATION LIST screen (refer to Calibration on page 62).
3. Use the **▲▼** buttons to highlight Pressure, and then press **ENT** to display the CALIBRATE PRESSURE screen.



NOTE: “Measured” is the pressure value currently being detected by the pressure sensor, while “Applied” is a known value of pressure that will be applied for calibration purposes.

4. With both the $-\Delta P$ and $+\Delta P$ ports open to the atmosphere, observe that the current Measured pressure reading should be 0 ± 0.01 inwc. If necessary, zero the pressure sensor (refer to Performing a Draft / Pressure Measurement on page 47) and repeat Steps 2 thru 4.
5. Connect the hose from the manometer to the $+\Delta P$ port and apply a negative pressure to this port by adjusting the bellows for a manometer reading of -4.00 .
6. Use the **▲▼** and **◀▶** buttons to enter an applied value that exactly equals the manometer reading.



NOTE: The calibration range is from -6 to -2 inwc (-15 to -5 mb). An attempt to calibrate outside this range will cause the message “Applied Value High” (or Low) to appear at the bottom of the screen.

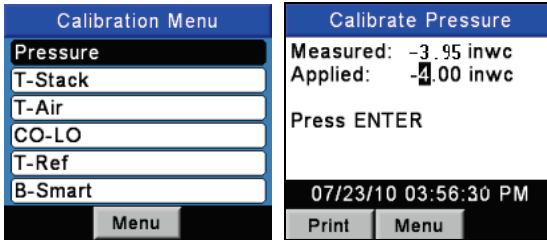

Figure 6-2. Pressure Sensor Calibration

7. Wait until the measured reading stabilizes, and then press **ENT** to calibrate the pressure sensor’s Measured value to that of the applied value; after which the message “Good Calibration” should briefly appear followed by the CALIBRATION LIST screen being re-displayed.
8. Remove calibration equipment.

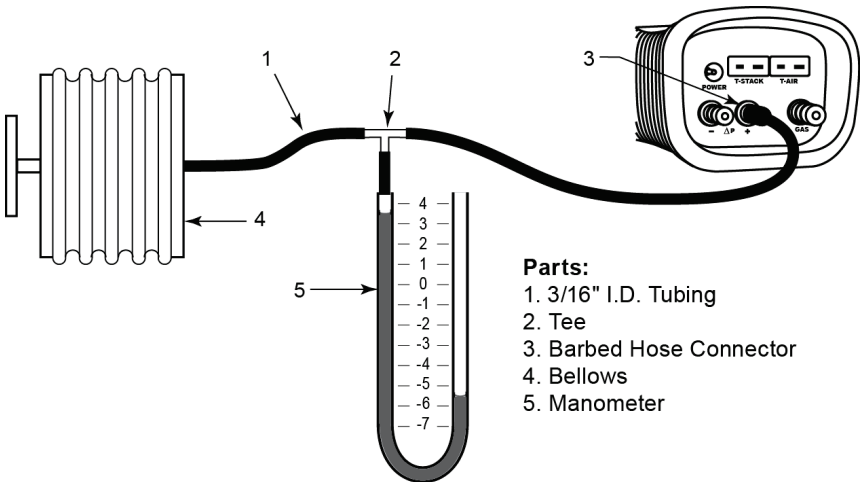

Figure 6-3. Pressure Sensor Calibration Equipment

6.5. T-Stack Calibration

This procedure first zeros and then spans the stack temperature channel to known temperature values.

The use of an electronic thermocouple simulator is the preferred method of producing the desired calibration temperatures. Alternatively, containers of ice water and boiling water can be used.

6.5.1. Material Required

- Thermocouple Simulator (K-type):
Range: 0 to 600 °F
Accuracy: ±0.5 °F
- (Alternatively) Ice Water, Boiling Water, Thermometer

6.5.2. TS-Zero Procedure

1. Set thermocouple simulator to room temperature and plug its output into the T-STACK connector located at the bottom of the analyzer.

Alternatively: *Plug the probe's thermocouple into the T-STACK connector located at the bottom of the analyzer.*



CAUTION: DO NOT attach the probe's gas hose to the analyzer's GAS port or water will be drawn into the analyzer!

2. If not already done, turn ON the analyzer and display the CALIBRATION LIST screen (refer to Calibration on page 62).
 3. Use the ▲ ▼ buttons to highlight T-Stack, and then press **ENT** to display the CALIBRATE TS-ZERO screen.
-



NOTE: "Measured" is the current temperature reading, while "Applied" is a known temperature that will be applied for calibration purposes.

4. Set thermocouple simulator to 32 °F (0 °C), and then use the ▲ ▼ and ◀ ▶ buttons to enter an applied value that exactly equals the setting of the simulator.

Alternatively: *Submerge probe tip into an ice-water bath with a thermometer, wait several minutes, and then use the ▲ ▼ and ◀ ▶ buttons to enter an applied value that exactly equals the thermometer reading.*



NOTE: The calibration range is from 32 to 41 °F (0 to 5 °C). Calibrating outside this range will cause the message "Applied Value High" (or Low) to appear at the bottom of the screen.

5. Wait until the measured reading stabilizes, and then press **ENT** to calibrate the TS-Zero Measured value to that of the applied value; after

which the message “Good Calibration” should briefly appear followed by the CALIBRATE TS-SPAN screen.

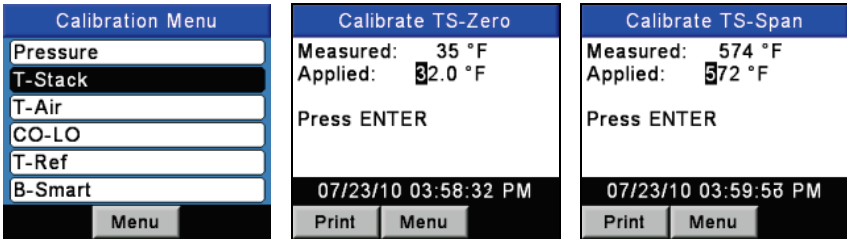

Figure 6-4. T-Stack Zero and Span

6.5.3. TS-Span Procedure

1. Set thermocouple simulator to 572 °F (300 °C), and then use the ▲ ▼ and ◀ ▶ buttons to enter an applied value that exactly equals the setting of the simulator.

Alternatively: *Submerge probe tip into a container of boiling water with a thermometer, wait several minutes, and then use the ▲ ▼ and ◀ ▶ buttons to enter an applied value that exactly equals the thermometer reading.*



NOTE: The calibration range is from 175 to 625 °F (80 to 330 °C). An attempt to calibrate outside this range will cause the message “Applied Value High” (or Low) to appear at the bottom of the screen.

2. Wait until the measured reading stabilizes, and then press ENT to calibrate the TS-Span Measured value to that of the applied value; after which the message “Good Calibration” should briefly appear followed by the CALIBRATION LIST screen being re-displayed.

6.6. T-Air Calibration

This procedure first zeros and then spans the ambient temperature channel to known temperature values.

The use of an electronic thermocouple simulator is the preferred method of producing the desired calibration temperatures. Alternatively, containers of ice water and boiling water can be used.

6.6.1. Material Required

- Thermocouple Simulator (K-type)
Range: 0 to 600 °F
Accuracy: ±0.5 °F
- (Alternatively) Ice Water, Boiling Water, Thermometer

6.6.2. TA-Zero Procedure

1. Set thermocouple simulator to room temperature and plug its output into the T-AIR connector located at the bottom of the analyzer.

Alternatively: *Plug the probe's thermocouple into the T-AIR connector located at the bottom of the analyzer. DO NOT attach the probe's gas hose to the analyzer's GAS port; otherwise water will be drawn into the analyzer!*

2. If not already done, turn ON the analyzer and display the CALIBRATION LIST screen (refer to Calibration on page 62).
3. Use the ▲ ▼ buttons to highlight T-Air, and then press ENT to display the CALIBRATE TA-ZERO screen.



NOTE: "Measured" is the current temperature reading, while "Applied" is a known temperature that will be applied for calibration purposes.

4. Set thermocouple simulator to 32 °F (0 °C), and then use the ▲ ▼ and ◀ ▶ buttons to enter an applied value that exactly equals the setting of the simulator.

Alternatively: *Submerge probe tip into an ice-water bath with a thermometer, wait several minutes, and then use the ▲ ▼ and ◀ ▶ buttons to enter an applied value that exactly equals the thermometer reading.*



NOTE: The calibration range is from 32 to 41 °F (0 to 5 °C). An attempt to calibrate outside this range will cause the message "Applied Value High" (or Low) to appear at the bottom of the screen.

5. Wait until the measured reading stabilizes, and then press ENT to calibrate the TA-Zero Measured value to that of the applied value; after which the message "Good Calibration" should briefly appear followed by the CALIBRATE TA-SPAN screen.

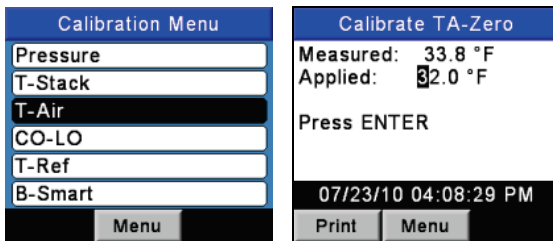

Figure 6-5. T-Air Zero Procedure

6.6.3. TA-Span Procedure

1. Set thermocouple simulator to 212 °F (100 °C), and then use the ▲▼ and ◀▶ buttons to enter an applied value that exactly equals the setting of the simulator.

Alternatively: *Submerge probe tip into a container of boiling water with a thermometer, wait several minutes, and then use the ▲▼ and ◀▶ buttons to enter an applied value that exactly equals the thermometer reading.*



NOTE: The calibration range is from 194 to 230 °F (90 to 110 °C). An attempt to calibrate outside this range will cause the message “Bad Calibration Wrong CAL Entry” to appear in the following step.

2. Wait until the measured reading stabilizes, and then press **ENT** to calibrate the TA-Span Measured value to that of the applied value; after which the message “Good Calibration” should briefly appear followed by the CALIBRATION LIST screen being re-displayed.

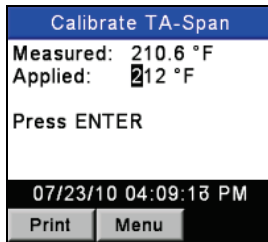

Figure 6-6. T-Air Span Procedure

6.7. CO_{LOW} Sensor Calibration



NOTE: The CO_{LOW} sensor also measures H₂ for the purpose of compensating the CO reading for the presence of H₂ in the gas sample. This procedure first spans the CO_{LOW} sensor and, optionally, spans the H₂ part of the sensor to known gas levels.

The user has the option to perform a CO only calibration or a CO/H₂ calibration using the PCA[®]3 soft keys.

6.7.1. Material Required

- Calibration Kit (P/N 0024-7059)
- Gas Cylinder (500 ppm CO in air, P/N 0024-0492)
- Gas Cylinder (1,000 ppm CO and 1,000 ppm H₂ in Nitrogen, P/N 0024-0794)

6.7.2. Procedure

1. If not already done, turn ON the analyzer and display the CALIBRATION LIST screen (refer to Calibration on page 62).
2. Use the ▲▼ buttons to highlight CO-LO, and then press ENT to display the CALIBRATE CO screen.



NOTE: “Measured” is the current CO reading, while “Applied” is a known CO level that will be applied for calibration purposes.

3. Attach a 500 ppm CO cylinder to the regulator of the calibration fixture shown in Figure 6-12 on page 76.
4. Use the ▲▼ and ◀▶ buttons to enter an applied value that exactly equals the concentration stamped on the CO cylinder.



NOTE: The calibration range is from 9 to 1,500 ppm. An attempt to calibrate outside this range will cause the message “Applied Value High” (or Low) to appear at the bottom of the screen.

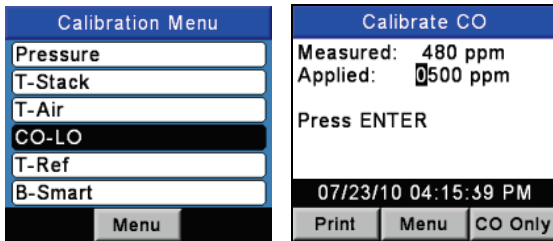

Figure 6-7. CO_{Low} Sensor Calibration

5. Adjust the regulator for a flow meter indication of approximately 2 SCFH. Wait until the measured reading stabilizes (approximately 3 minutes), and then press ENT to calibrate the CO Measured value to that of the applied value. The message “Good Calibration” should briefly appear followed by the TEST GAS CO/H₂ screen.



NOTE: If the sensor’s output is low, but still usable, then the message “Good Calibration WARNING Low Sensor” will appear. The sensor will now be marked as being Low in the DIAGNOSTICS screen.



NOTE: If the sensor's output is too low to be usable, then the message "Bad Calibration Sensor End of Life, Entry Not Saved" will appear. The sensor will now be marked as being BAD in the DIAGNOSTICS screen.

6. Turn OFF regulator of calibration fixture and remove the CO cylinder.
7. Attach a combination 1,000 ppm CO and 1,000 ppm H₂ cylinder to the regulator of the calibration fixture, and then use the ▲▼ and ◀▶ buttons to enter an applied value that exactly equals the CO concentration stamped on the cylinder.
8. Adjust the regulator for a flow meter indication of approximately 2 SCFH, and then press ENT to display the CALIBRATE H₂ screen.



NOTE: The calibration range is 400 to 1,500 ppm. Calibrating outside this range causes the message "Bad Calibration Wrong CAL Entry" to appear in the next step.

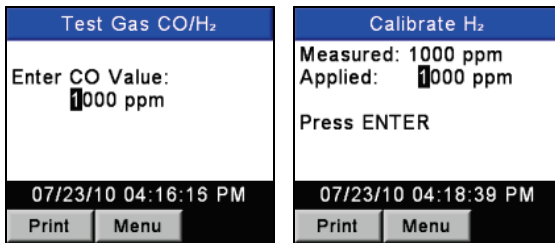

Figure 6-8. CO_{LOW} Sensor Calibration

9. Wait until the measured reading stabilizes (approximately 3 minutes), and then press **ENT** to calibrate the H₂ Measured value to that of the applied value; after which the message "Good Calibration" should briefly appear followed by the CALIBRATION LIST screen being re-displayed.



NOTE: If the sensor's output is low, but still usable, then the message "Good Calibration WARNING Low Sensor" will appear. The sensor will now be marked as being Low in the DIAGNOSTICS screen.



NOTE: If the sensor's output is too low to be usable, then the message "Bad Calibration Sensor End of Life" will appear followed by the CALIBRATION LIST screen being re-displayed. The sensor will now be marked as being BAD in the DIAGNOSTICS screen.

10. Turn OFF the regulator and remove the gas cylinder.



NOTE: A CO-only calibration can be done by pressing **F3** in Step 5 (instead of **ENT**).

6.8. SO₂ Sensor Calibration

This procedure spans the optional sulfur dioxide sensor to a known gas level.

6.8.1. Material Required

- Calibration Kit (P/N 0024-7059)
- Gas Cylinder (100 ppm SO₂ in Nitrogen, P/N 0024-1158)

6.8.2. Procedure

1. If not already done, turn ON the analyzer and display the CALIBRATION LIST screen (refer to Calibration on page 62).
2. Use the ▲▼ buttons to highlight SO₂, and then press **ENT** to display the CALIBRATE SO₂ screen.



NOTE: “Measured” is the current SO₂ reading, while “Applied” is a known SO₂ level that will be applied for calibration purposes.

3. Attach a 100 ppm SO₂ cylinder to the regulator of the calibration fixture shown in Figure 6-12 on page 76.
4. Use the ▲▼ and ◀▶ buttons to enter an applied value that exactly equals the concentration stamped on the SO₂ cylinder.



NOTE: The calibration range is from 9 to 1,800 ppm. An attempt to calibrate outside this range will cause the message “Bad Calibration Wrong CAL Entry” to appear in the following step.

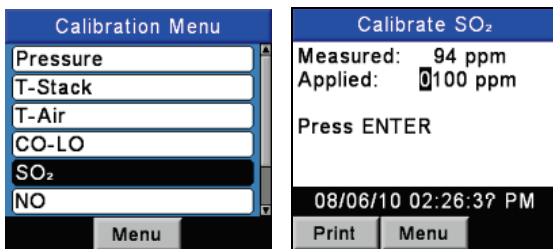

Figure 6-9. SO₂ Sensor Calibration

5. Adjust regulator for a flow meter indication of approximately 2 SCFH. Wait until the measured reading stabilizes (approximately 3 minutes),

and then press **ENT** to calibrate the SO₂ Measured value to that of the applied value. The message “Good Calibration” should briefly appear followed by the CALIBRATION LIST screen being re-displayed.



NOTE: If the sensor’s output is low, but still usable, then the message “Good Calibration WARNING Low Sensor” will appear. The sensor will now be marked as being Low in the DIAGNOSTICS screen.



NOTE: If the sensor’s output is too low to be usable, then the message “Bad Calibration Sensor End of Life, Entry Not Saved” will appear followed by the CALIBRATION LIST screen being re-displayed. The sensor will now be marked as being BAD in the DIAGNOSTICS screen.

6. Turn OFF regulator and remove the gas cylinder.

6.9. NO Sensor Calibration

This procedure spans the optional nitric oxide sensor to a known gas level.

6.9.1. Material Required

- Calibration Kit (P/N 0024-7059)
- Gas Cylinder (250 ppm NO in Nitrogen, P/N 0024-1156)

6.9.2. Procedure

1. If not already done, turn ON the analyzer and display the CALIBRATION LIST screen (refer to Calibration on page 62).
2. Use the ▲▼ buttons to highlight NO, and then press **ENT** to display the CALIBRATE NO screen.



NOTE: “Measured” is the current NO reading, while “Applied” is a known NO level that will be applied for calibration purposes.

3. Attach a 250 ppm NO cylinder to the regulator of the calibration fixture shown in Figure 6-12 on page 76.
4. Use the ▲▼ and ◀▶ buttons to enter an applied value that exactly equals the concentration stamped on the NO cylinder.



NOTE: The calibration range is from 9 to 900 ppm. An attempt to calibrate outside this range will cause the message “Bad Calibration Wrong CAL Entry” to appear in the following step.

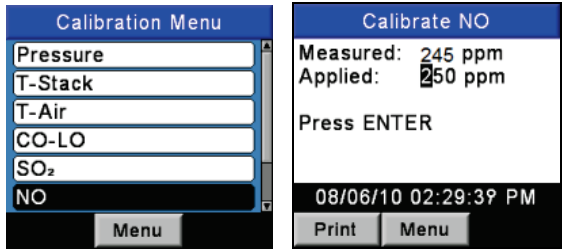

Figure 6-10. NO Sensor Calibration

5. Adjust regulator for a flow meter indication of approximately 2 SCFH. Wait until the measured reading stabilizes (approximately 3 minutes), and then press **ENT** to calibrate the NO Measured value to that of the applied value. The message “Good Calibration” should briefly appear followed by the CALIBRATION LIST screen being re-displayed.



NOTE: If the sensor’s output is low, but still usable, then the message “Good Calibration WARNING Low Sensor” will appear. The sensor will now be marked as being Low in the DIAGNOSTICS screen.



NOTE: If the sensor’s output is too low to be usable, then the message “Bad Calibration Sensor End of Life, Entry Not Saved” will appear followed by the CALIBRATION LIST screen being re-displayed. The sensor will now be marked as being BAD in the DIAGNOSTICS screen.

6. Turn OFF regulator and remove the gas cylinder.

6.10. NO₂ Sensor Calibration

This procedure spans the optional nitrogen dioxide sensor to a known gas level.

6.10.1. Material Required

- Calibration Kit (P/N 0024-7059)
- Gas Cylinder (100 ppm NO₂ in Nitrogen, P/N 0024-1157)

6.10.2. Procedure

1. If not already done, turn ON the analyzer and display the CALIBRATION LIST screen (refer to Calibration on page 62).
2. Use the ▲▼ buttons to highlight NO₂, and then press **ENT** to display the CALIBRATE NO₂ screen.



NOTE: “Measured” is the current NO₂ reading, while “Applied” is a known NO₂ level that will be applied for calibration purposes.

3. Attach a 100 ppm NO₂ cylinder to the regulator of the calibration fixture shown in Figure 6-12 on page 76.
4. Use the ▲ ▼ and ◀ ▶ buttons to enter an applied value that exactly equals the concentration stamped on the NO₂ cylinder.



NOTE: The calibration range is from 9 to 150 ppm. An attempt to calibrate outside this range will cause the message “Bad Calibration Wrong CAL Entry” to appear in the following step.

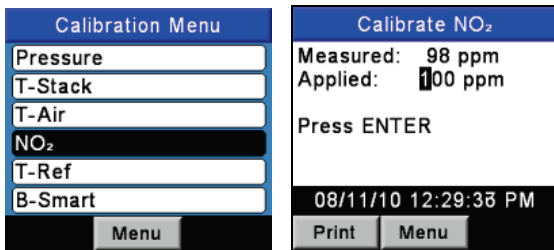

Figure 6-11. NO₂ Sensor Calibration

5. Adjust regulator for a flow meter indication of approximately 2 SCFH. Wait until the measured reading stabilizes (approximately 3 minutes), and then press **ENT** to calibrate the NO₂ measured value to that of the applied value. The message “Good Calibration” should briefly appear followed by the CALIBRATION LIST screen being re-displayed.



NOTE: If the sensor’s output is low, but still usable, then the message “Good Calibration WARNING Low Sensor” will appear. The sensor will now be marked as being Low in the DIAGNOSTICS screen.



NOTE: If the sensor’s output is too low to be usable, then the message “Bad Calibration Sensor End of Life, Entry Not Saved” will appear followed by the CALIBRATION LIST screen being re-displayed. The sensor will now be marked as being BAD in the DIAGNOSTICS screen.

6. Turn OFF regulator and remove the gas cylinder.

6.11. CO_{HIGH} Sensor Calibration

This procedure spans the optional carbon monoxide high sensor (4,001 to 20,000 ppm) to a known gas level.

6.11.1. Material Required

- Calibration Kit (P/N 0024-7059)
- Gas Cylinder (4,000 ppm CO in Air, P/N 0024-1155)

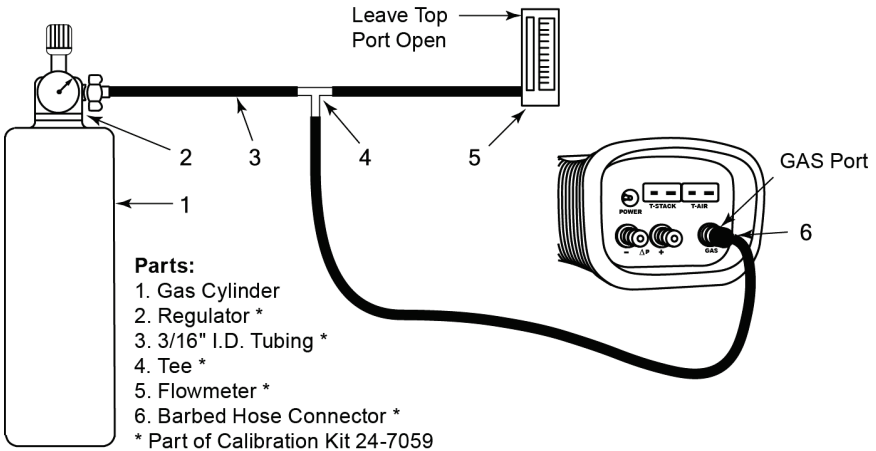

Figure 6-12. Gas Sensor Calibration Equipment

6.11.2. Procedure

1. If not already done, turn ON the analyzer and display the CALIBRATION LIST screen (refer to Calibration on page 62).
2. Use the ▲▼ buttons to highlight CO-HI, and then press ENT to display the CALIBRATE CO-HI screen.



NOTE: “Measured” is the current CO reading, while “Applied” is a known CO level that will be applied for calibration purposes.

3. Attach a 4,000 ppm CO cylinder to the regulator of the calibration fixture shown in Figure 6-12 on page 76.
4. Use the ▲▼ and ◀▶ buttons to enter an applied value that exactly equals the concentration on the CO cylinder.



NOTE: The calibration range is from 250 to 11,000 ppm. An attempt to calibrate outside this range will cause the message “Bad Calibration Wrong CAL Entry” to appear in the following step.

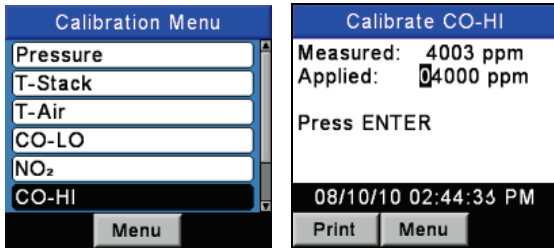

Figure 6-13. CO_{HIGH} Sensor Calibration

- Adjust regulator for a flow meter indication of approximately 2 SCFH. Wait until the measured reading stabilizes (approximately 3 minutes), and then press **ENT** to calibrate the CO Measured value to that of the applied value. The message “Good Calibration” should briefly appear followed by the CALIBRATION LIST screen being re-displayed.



NOTE: If the sensor’s output is low, but still usable, then the message “Good Calibration WARNING Low Sensor” will appear. The sensor will now be marked as being Low in the DIAGNOSTICS screen.

If the sensor’s output is too low to be usable, then the message “Bad Calibration Sensor End of Life, Entry Not Saved” will appear followed by the CALIBRATION LIST screen being re-displayed. The sensor will now be marked as being BAD in the DIAGNOSTICS screen.

- Turn OFF regulator and remove the gas cylinder.

CHAPTER 7. MAINTENANCE

7.1. Overview

Customer maintenance of the PCA[®]3 is limited to the following:

- Battery replacement (see page 20)
- Sensor re-calibration (see page 62)
- Water trap / filter assembly maintenance (see pages 49 and 83)
- Sensor replacement (see page 84)
- Cleaning the probe (see page 87).

All other maintenance should be performed by an authorized Bacharach Service Center. Refer to Service Centers on page 95.

7.2. PCA[®]3 Disassembly

The following procedure describes and illustrates how to disassemble the analyzer.

7.2.1. Tools Required

- Medium Phillips Screwdriver

7.2.2. Procedure

1. Unplug all thermocouples from bottom of analyzer.
2. Remove battery cover and then remove batteries.



NOTE: In Step 3, if the sensors are not being replaced, leave the tubing connected to each sensor's gas cap, being careful not to put unnecessary strain on the tubing during the disassembly process.

-
3. Pull off sensor retainer; and then unplug all sensors.
 4. Lay analyzer face down on a padded work surface; and then using a medium Phillips screwdriver, remove the unit's four rear-case screws.
 5. Lift rear case from analyzer and set aside.
 6. Unplug electrical connectors J8, J9, and J14 from printed circuit board.



CAUTION: In Step 7, note that there is tubing connected between the bottom hose connector plate and the pressure sensor on the printed circuit board. Do not put unnecessary strain on this tubing during the disassembly process.

-
7. Carefully lift battery and pump chassis, along with the bottom hose connector plate, from analyzer.
 8. Lift printed circuit board from analyzer.

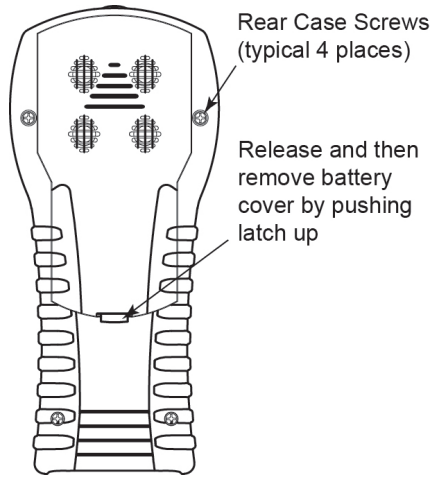
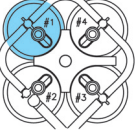
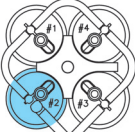
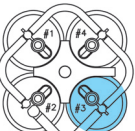
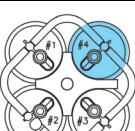

Figure 7-1. Removing the Rear Case

Sensor Position	Model Number and Corresponding Sensor Configuration						
	225	235	245	255	265	275	285
#1 	O ₂	O ₂	O ₂	O ₂	O ₂	O ₂	O ₂
#2 	CO _{LOW}	CO _{LOW}	CO _{LOW}	CO _{LOW}	CO _{LOW}	CO _{LOW}	CO _{LOW}
#3 	Empty	Empty	Empty	SO ₂	NO ₂	SO ₂	CO _{HIGH}
#4 	Empty	NO	CO _{HIGH}	Empty	NO	NO	NO

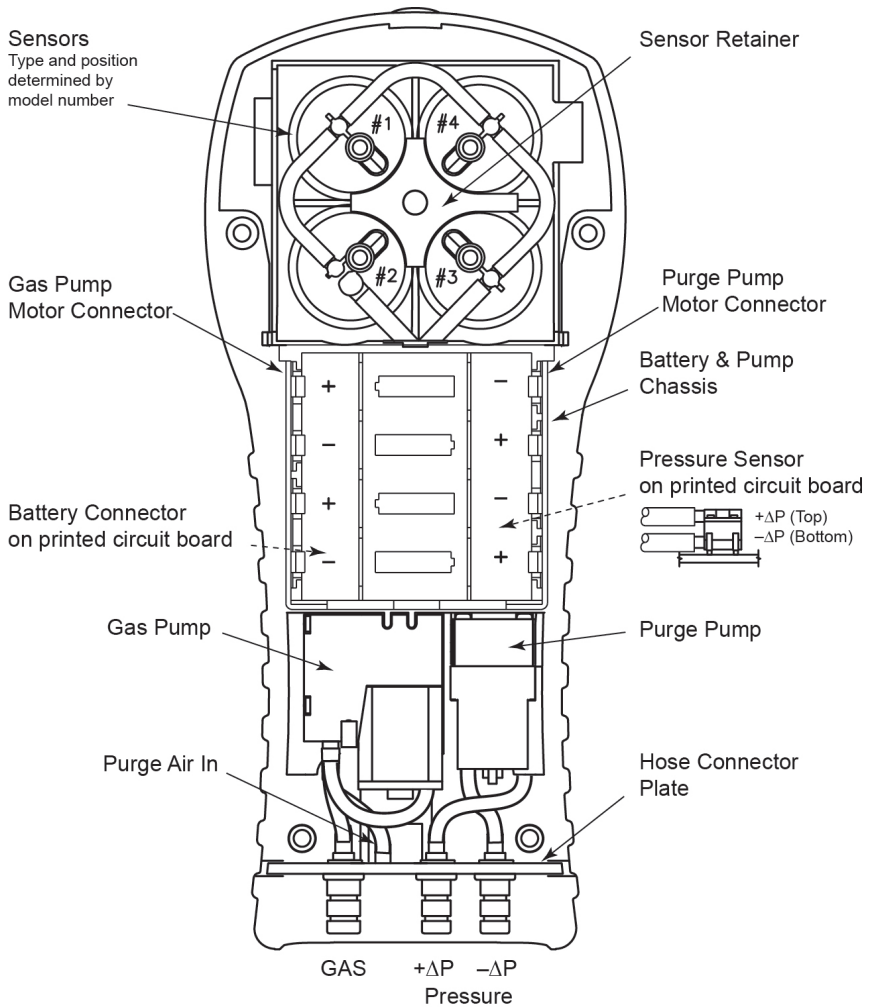

Figure 7-2. Inside View with Rear Case Removed

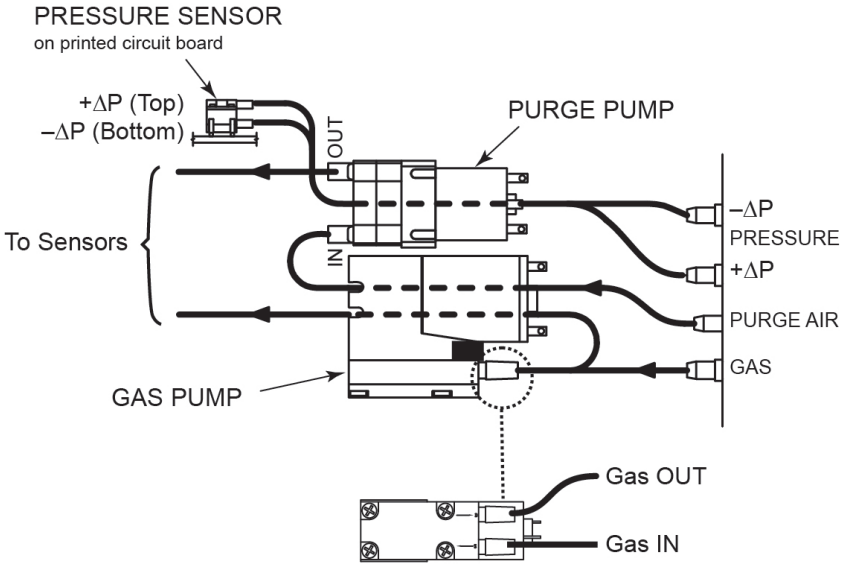

Figure 7-3. Tubing Connections - Main

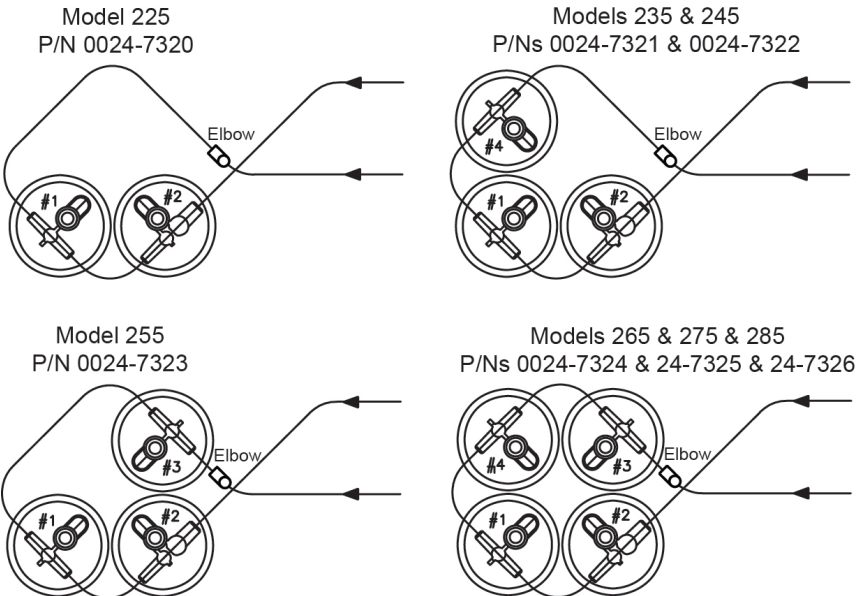

Figure 7-4. Tubing Connections - Sensors

7.3. Emptying the Water Trap Chamber

The water trap chamber should be emptied after every test, or when the water condensate approaches the tip of the riser tube.

1. Remove water trap chamber (also see page 49).
2. Pour out liquid condensate and then reassemble trap.

7.4. Replacing the Filter Element

Replace the filter element when it becomes visibly dirty or becomes saturated with water.

7.4.1. Material Required

- Filter Element (P/N 0007-1644)
- Small Flat Blade Screwdriver

7.4.2. Procedure

1. Remove water trap chamber (also see page 49).
2. Pry apart filter chamber using a small flat-blade screwdriver. Remove and discard old filter.
3. Install new filter and reassemble filter chamber, making sure that surfaces "A" and "B" contact each other.
4. Reassemble trap.

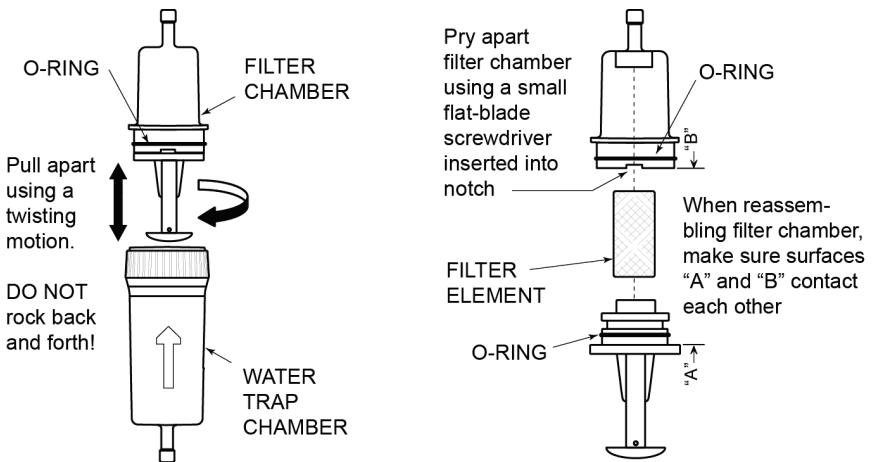

Figure 7-6. Disassembling the Water Trap/Filter Assembly

7.5. Sensor Replacement

All sensors are replaced in a similar manner. Do the following to replace either the O₂, CO_{LOW}, CO_{HIGH}, NO, NO₂, or SO₂ sensor. Refer to Replacement Parts on page 90 for a list of sensors and part numbers.



NOTE: The typical life expectancy of the O₂, SO₂ and NO₂ sensors is 2 years. Typical life expectancy of the CO, CO_{HIGH} and NO sensors is 3 years.

1. Turn OFF the analyzer.
 2. Remove the battery cover.
 3. Remove the sensor retainer.
 4. Remove the tubing from the gas cup of sensor being replaced.
 5. Unplug the sensor along with its printed circuit board from the analyzer's main board.
 6. Remove the sensor's gas cup by twisting its bayonet fitting counterclockwise, and then pulling the cup straight up.
 7. Carefully remove the old sensor from the B-Smart® sensor PCB, keeping in mind that there is an adhesive foam disk in between the PCB and sensor.
-



IMPORTANT: When replacing the O₂ sensor, be sure that the "+" sensor pin plugs into the PCB socket that is also marked "O₂+". Also, when replacing an NO sensor, replace the bias battery.

8. Remove the replacement sensor from its plastic canister. Note that the CO_{LOW}, CO_{HIGH}, SO₂, and NO₂ sensors have a shorting spring installed between two of their pins. Remove and discard this spring before installing the sensor.
 9. Attach the gas cup to new sensor, making sure that when the sensor assembly is plugged into the analyzer's main board, the tubing connections on top of gas cup are aligned as shown in Figure 7-7.
 10. Plug the sensor into analyzer, and then reattach tubing to gas cup.
 11. Install the sensor retainer and battery cover.
-

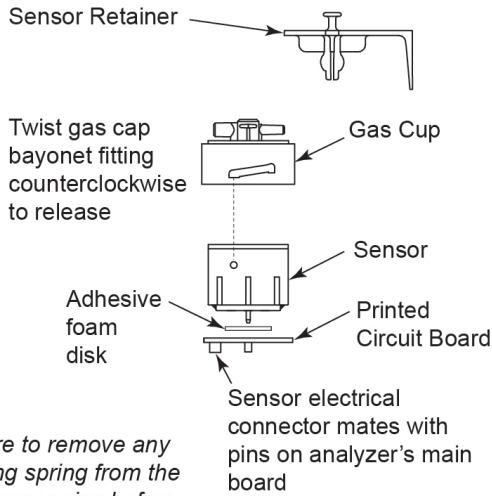
**CAUTION:**

Be sure to remove any shorting spring from the new sensor pins before installing! There is no shorting spring on the O₂ or NO sensors.

Figure 7-7. Sensor Assembly

12. Allow the sensor that was just installed time to stabilize in the circuit before continuing with this procedure. Stabilization time for all sensors (except for the NO sensor) is about 1 hour. The NO sensor baseline technically requires several days to stabilize, but should be sufficiently stabilized for use in approximately 4 hours.
13. Turn ON the analyzer and confirm that no sensor errors occur during warm up.



NOTE: Discard old sensors in accordance with local and federal hazardous waste disposal laws.

14. Enter the B-Smart[®] calibration code or calibrate the new sensor(s) as explained earlier (see Calibration on page 62). An exception is the O₂ sensor which does not require calibration.

7.6. Nitric Oxide (NO) Sensor Battery Replacement

A single lithium battery, located on the NO Smart Sensor assembly, applies a bias voltage to the NO sensor to prevent the sensor from destabilizing when the analyzer is turned off. The NO bias battery is expected to last at least the life of the NO sensor.



NOTE: It is recommended that the bias battery be replaced whenever the NO sensor is replaced.

7.6.1. Material Required

- Bias battery (refer to Replacement Parts on page 90)

7.6.2. Procedure

1. Follow the instructions on page 78 (PCA[®]3 Disassembly) to remove the sensor assembly from sensor position 4.
2. Remove the old battery from its holder on the nitric oxide printed circuit board.
3. Insert the new battery with the positive side toward the sensor (the battery contact is stamped with a + symbol).
4. Re-install the Smart Sensor assembly.
5. Before powering up and using the analyzer, allow the nitric oxide sensor to stabilize as described below. Note that recalibration of the nitric oxide sensor is not required after replacing its bias battery.

Depending on how long the nitric oxide sensor was without bias voltage, the time required for the sensor to completely stabilize varies from less than a minute to several days. Typical stabilization times are shown below. Generally, however, the sensor is sufficiently stable after 4 hours for measurement purposes.

Bias Battery Stabilization Specifications for NO Sensor

Bias Battery Removed for...	Stabilization Time
Less than 15 minutes	Less than 1 minute
Less than 1 hour	Less than 5 minutes
Less than 2 days	Less than 4 hours
Greater than 2 days	Up to 2 days

7.7. Cleaning the Probe

The probe tube and gas sample hose will become dirty under normal use.



NOTE: The water trap's filter element should prevent soot from reaching the analyzer's internal components. If the probe is not kept clean, it could become clogged and restrict the flow of gas into the analyzer, resulting in incorrect combustion test readings and calculations.



NOTE: An analyzer that is used to test natural gas furnaces normally requires less frequent cleaning than an analyzer used for testing coal or oil fired furnaces.

7.7.1. Equipment Required

- Alcohol
- Aerosol Can of Automotive Carburetor Cleaner
- Clean Rag
- Source of Compressed Air (optional)

7.7.2. Procedure

1. Remove gas sample hose from top of water trap.



CAUTION: Carburetor cleaner attacks plastic components! Take precautions not to spray cleaner onto the probe handle or analyzer.

2. Insert the plastic spray tube of the carburetor cleaner into the gas sample hose, and then liberally spray carburetor cleaner through the hose and out the probe tube.
3. After spraying, remove all the residual cleaner by repeatedly flushing the gas hose and probe tube with alcohol.
4. Wipe off the surfaces of the probe and tubing with a clean rag.
5. Allow the parts to dry completely. If available, blow compressed air through the probe to expedite the drying process.
6. Reconnect gas sample hose to top of water trap.

CHAPTER 8. TROUBLESHOOTING

8.1. Error Symbols

Error symbols are shown in the data fields of the Combustion Test screens and on the printout to indicate the following.

Error Symbol	Description
- - -	Three hyphens or dashes indicates that the calculated data cannot be displayed because the measured data necessary to make the calculation is out of range. For calculations to occur, the oxygen level must be below 16% and the stack temperature must be below 2,000 °F (1,093 °C).
* * *	Three stars appear in the data field of sensors that are not installed, defective, or found to be in error during warm-up, and also in the data fields of that sensor's related calculated values. For example, if the data field of either the NO or NO ₂ sensor contains three stars, then the NO _x data field will also contain three stars.
X X X	Indicates sensor over range.

8.2. Diagnostics and Status Screens

The DIAGNOSTICS menu provides information regarding the operation of the analyzer. Information includes the following.

Diagnostic	Description
Time Meters	<p>Displays the run time of the analyzer, sample pump and purge pump in hours of operation.</p>  <p>The screenshot shows a blue-themed menu titled 'Diagnostics Menu'. The 'Time Meters' option is highlighted with a black background and white text. Other visible options include 'Main Diagnostics', 'O₂ Sensor Life', 'B-Smart Sensors', and 'Fresh Air Diagnostics'. A 'Menu' button is visible at the bottom.</p>
Main Diagnostics	Lists the current status of the Stack and Air Thermocouple channels, Reference Temperature channel, Pressure channel, and Battery.
O₂ Sensor Life	Displays the approximate remaining life of the Oxygen sensor.
B-Smart Sensors	Displays the current status of all B-Smart sensors installed.
Fresh Air Diagnostics	Fresh air diagnostics will cycle the instrument through the 60 second warm-up to check on the status of all sensors. The probe must be in fresh air to perform a valid check.

Figure 8-1. Time Meters

8.3. Accessing the Diagnostic Menu

1. Display the MAIN MENU by pressing the **MENU (F2)** button. If necessary, press **ESC** until MENU appears above **F2**.

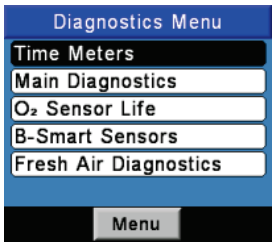
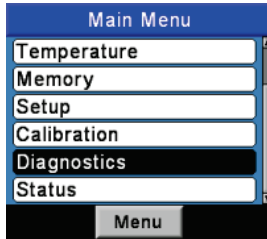

Figure 8-2. Accessing the Diagnostics Menu

2. Use the **▲▼** buttons to highlight **DIAGNOSTICS** and then press **ENT** to display the **DIAGNOSTICS MENU**.
3. Use the **▲▼** buttons to highlight the desired diagnostic topic, and then press **ENT** to display the information under that topic.
4. Press **ESC** key to exit back to the Diagnostic menu or the **Menu (F2)** key to exit back to the Main Menu.

8.4. Accessing the Status Menu

The Status screen provides a quick reference to key items when troubleshooting.

1. Display the MAIN MENU by pressing the **MENU (F2)** button. If necessary, press **ESC** until MENU appears above **F2**.
2. Use the **▲▼** buttons to highlight **STATUS** and then press **ENT** to display the **DEVICE STATUS** screen.
3. Press **ESC** key to exit back to the Main Menu.

8.5. Error Messages (After Warm-up)

If there were problems detected during warm-up, error messages that describe the nature of the problems are displayed immediately following the analyzer's 60-second warm-up period.

If problems were detected, the analyzer will not automatically switch to the Combustion Test HOLD screen after warm-up. The analyzer, however, can still be used to perform any test that does not depend on the sensor that is in error. Press the **RUN** button to manually display the Combustion Test HOLD screen, and then continue using the analyzer.

The following is a list of the error messages that may appear following warm-up and their suggested remedies.

Error Message	Description
Low Battery	Battery voltage is low. Replace batteries (page 20).

O₂ Sensor Missing	Oxygen sensor not installed. Install oxygen sensor. Refer to Sensor Replacement on page 84.
BAD Sensors	The oxygen sensor's output is too low and can not be calibrated in the instrument, signifying that the sensor is depleted and needs to be replaced. Refer to Sensor Replacement on page 84.
No B-Smart Sensors Installed	There are no B-Smart sensor(s) installed. Refer to Sensor Replacement on page 84.
Low Sensors	O ₂ , CO _{LOW} , CO _{HIGH} , NO, NO ₂ , or SO ₂ sensor output(s) were low, but still usable. Sensor(s) may need to be replaced in the near future. Message will indicate which sensor(s) are in warning.
T-STK Disconnected	The probe's thermocouple is not connected to the analyzer's T-STACK connector. Plug the probe thermocouple plug into the T-STACK connector at the bottom of the instrument.
Warm-up Sensor Error	<p>CO_{LOW}, CO_{HIGH}, NO, NO₂, or SO₂ Gas sensor(s) were not zeroed at warm-up because of high output. Run instrument on fresh air then restart instrument to re-zero sensor(s). If message persists, sensor(s) may need to be replaced. Message will indicate which sensor(s) are in error.</p> <ul style="list-style-type: none"> Stack or Air temperature channel is measuring temperature outside the range of -4 to 212 °F at startup. Make sure that the Stack and Air thermocouples are sampling ambient room air within the temperature range at startup. Message will indicate which channel(s) are in error. Pressure sensor is measuring pressure outside the range of +/- 3 inches of water column at startup. Ensure that the analyzer is sampling atmospheric pressure and restart. The analyzer was turned on with the probe sampling flue gas. Move the probe to fresh air and restart the analyzer.

8.6. Replacement Parts

Item	Description	Part No.
2	LCD Module	0024-1520
3	Rear Case	0024-1381
4	Top Case	0024-1524
5	Battery Cover	0024-1383
6	Window	0024-1526
7	LCD Frame	0024-1525
8	Keypad	0024-1387
9	Chassis	0024-1388
10	Lens, Infrared	0024-1391
11	Replacement Pump, Sample Gas	0024-1547
12	Replacement Pump, Purge	0024-1548
13	Sensor Retainer	0024-1418
14	Replacement Hose Connector Plate (complete)	0024-1480

Item	Description	Part No.
	assembly, including O-rings)	
14A	O-Ring, Pressure Fitting	0105-5103
14B	O-Ring, Gas Fitting	0105-5102
15A	Gas Cup, O ₂ /SO ₂ /NO ₂	0024-1421
15B	Gas Cup, CO _{LOW}	0024-1422
15C	Gas Cup, NO/CO _{HIGH}	0024-1420
16A	Sensor, O ₂	0024-0788
16B	Sensor, B-Smart®, CO _{LOW}	0024-1541
16C	Sensor, B-Smart®, CO _{HIGH}	0024-1542
16D	Sensor, B-Smart®, NO	0024-1545
16E	Sensor, B-Smart®, NO ₂	0024-1544
16F	B-Smart® Sensor, SO ₂	0024-1543
16G	Sensor, NOT calibrated, CO _{LOW}	0024-0789
16H	Sensor, NOT calibrated, CO _{HIGH}	0024-0997
16J	Sensor, NOT calibrated, NO	0024-0881
16K	Sensor, NOT calibrated, NO ₂	0024-1027
16L	Sensor, NOT calibrated, SO ₂	0024-0998
17	Screw, #4 x 1/2" LG	0002-2144
18	Battery Clip, Single	0004-1434
19	Battery Clip, Double	0024-1433
20	Cable Assembly	0024-1521
21	Tubing, Vinyl, 1/8 ID x 3/16 OD*	0003-6104
22	Tubing, Silicon, 1/16 ID x 1/8 OD*	0003-6372
23	Tubing, Silicon, 3/32 ID x 5/32 OD*	0103-6101
24	Tubing, Silicon, 1/8 ID x 3/16 OD*	0103-6102
25	Tubing, 1/8 ID x 1/4 OD*	0003-6105
26	Elbow	0003-6170
--	Bias Battery	0204-0020
--	O-Ring Kit (all O-rings included)	0024-1471

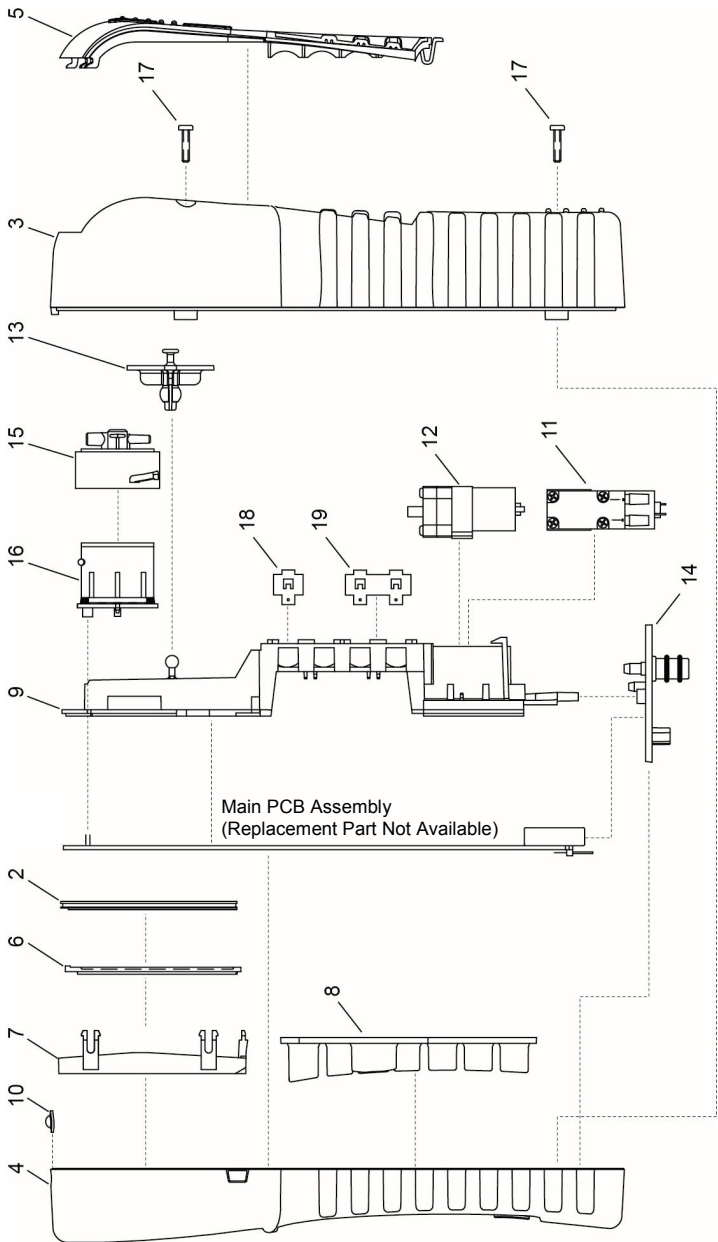

Figure 8-3. Replacement Parts

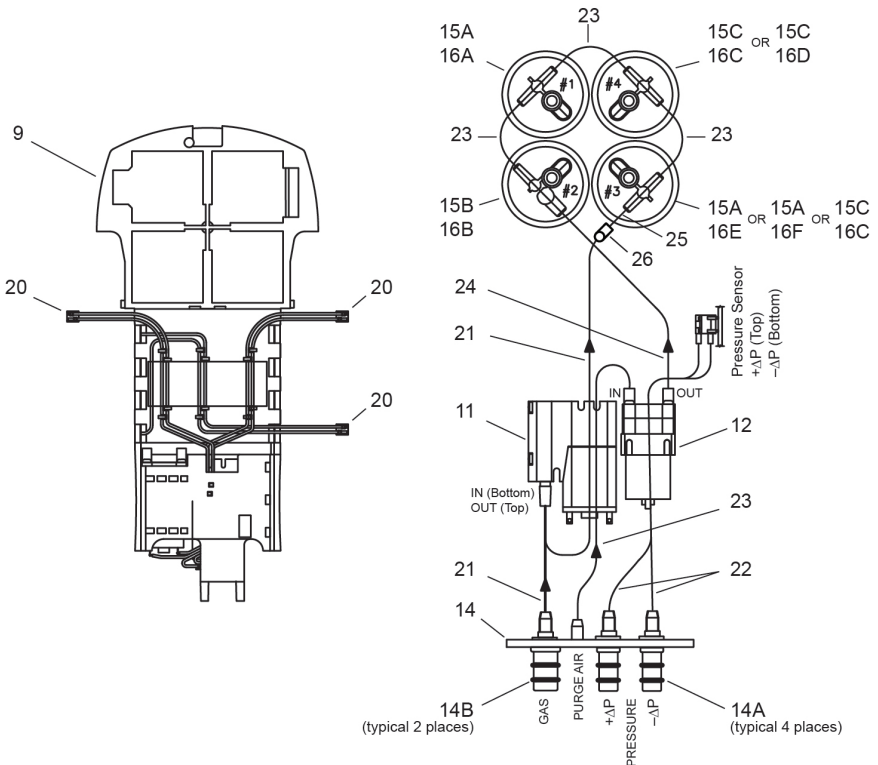

Figure 8-3. Replacement Parts (Continued)

8.7. Accessories

Standard Accessories

Description		Part No.
Carrying Case		0024-0865
Batteries, 'AA' Alkaline		0204-0004
12" Probe, Hose, and Water Trap/Filter Assembly		0024-3004
1	Water Trap/Filter (w/ O-Rings 0005-5122 and 0005-5117)	0019-3265
2	Filter Element (3 pack)	0007-1644
3	Probe Stop	0019-0580
4	Thumb Screw	0102-0875
5	Connector, Gas Sample	0024-0877
6	Connector, Draft	0024-0878
Fyrite® User Software		0024-1470
USB Cable		0104-4032
Instruction Manual		0024-9472

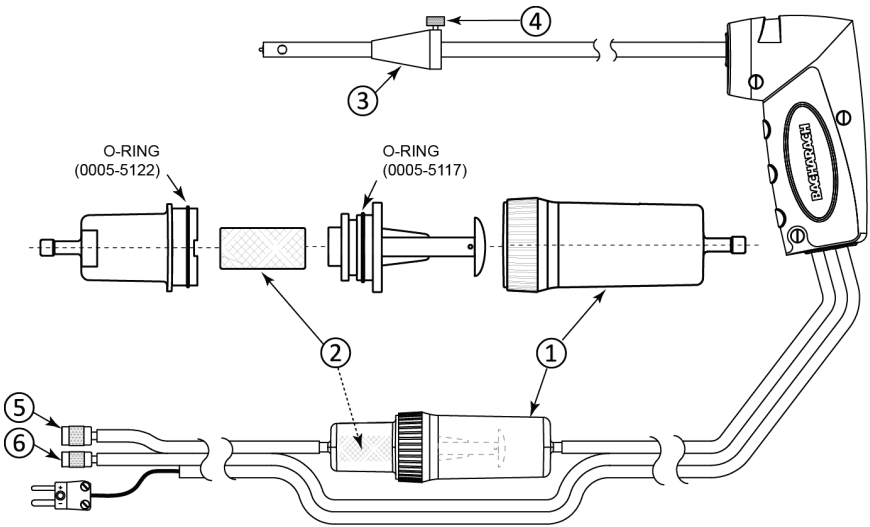

Figure 8-4. Hose and Probe Assembly (Parts)

Optional Accessories

Description	Part No.
AC Power Adapter: (Input: 100-240 VAC, 50/60 Hz; Output: 6 VDC @ 1 A)	0024-1254
Ambient Air Thermocouple (T-AIR), K-Type, 10 ft.	0104-1797
Ambient Air Thermocouple (T-AIR), K-Type, 1 inch.	0104-1798
Utility Wand (12 in. rigid probe w/ 5 ft. coiled cable)	0104-1799
Differential Pressure Hose Assembly, 6 ft.	0024-1103
Calibration Kit (includes hoses, adapter, flow meter; does not include gas cylinders)	0024-7059
Gas Cylinder, 500 ppm CO in air (103 Liter)	0024-0492
Gas Cylinder, 1000 ppm CO & 1000 ppm H ₂ in Nitrogen (103 Liter)	0024-0794
IrDA Printer	0024-1400
Printer Paper, 1 Roll	0006-8733
Printer Paper, 5 Pack	0024-1310
Probe, Hose, and Water Trap/Filter Assembly, 6 in. Probe	0024-3002
Probe, Hose, and Water Trap/Filter Assembly, 24 in. Probe	0024-3021
Probe, Hose, and Water Trap/Filter Assembly, 36 in. Probe	0024-3022
Thermocouple Replacement Kit, 6 in.	0024-8413
Thermocouple Replacement Kit, 12 in.	0024-8414
Thermocouple Replacement Kit, 24 in.	0024-8415

Description	Part No.
Thermocouple Replacement Kit, 36 in.	0024-8416
Sample Conditioning Probe, Compact (recommended when measuring NO ₂ and SO ₂)	0024-7224

8.8. Analyzer Repair

It is recommended that field repair of the PCA[®] 3 be limited to:

- Checks of printed circuit board connectors
- Replacing the probe assembly
- Replacing the filter element in the water trap / filter assembly
- Replacing sensors.

Information on how to perform these repairs is provided on page 78 (the Maintenance section). All other repairs should be performed by an authorized Bacharach Service Center (refer to the Service Centers section on page 95). Any repairs performed by an unauthorized service organization will void the analyzer's warranty and release Bacharach, Inc. of any implied or written product liability.

8.9. Service Centers

United States

Bacharach, Inc.
621 Hunt Valley Circle
New Kensington, PA 15068
Phone: 724-334-5051
Fax: 724-334-5723
Email: help@MyBacharach.com

Canada

Bacharach of Canada, Inc.
20 Amber Street Unit #7
Markham, Ontario L3R 5P4
Canada
Phone: 905-470-8985
Fax: 905-470-8963
Email: support@BachCan.ca

CHAPTER 9. DECLARATION OF CONFORMITY



DECLARATION OF CONFORMITY

The manufacturer of the products covered by this declaration:	Bacharach, Inc. 621 Hunt Valley Circle New Kensington, PA 15068
Year conformity is declared:	2010
Product(s):	Combustion Analyzer
Model(s):	PCA®3 (Domestic)

The undersigned hereby declares that the above referenced products are in conformity with the provisions of the following standard(s) and is in accordance with the following directive(s).

Standard(s):

EN 50270:2006	Electromagnetic Compatibility	Electrical Apparatus for the Detection and Measurement of Combustible Gases, Toxic Gases, or Oxygen
EN 55011	Radio Disturbance Characteristics	Limits and Methods of Measurements for Industrial, Scientific and Medical (ISM) Radio-Frequency Equipment

Directive(s):

2004/108/EC	EMC Directive
-------------	---------------

Signature:  _____

Name: Doug Keeperts
Title: VP of Product Development
Date: 18 October 2010

The technical documentation file required by this directive is maintained at the corporate headquarters of Bacharach, Inc.



World Headquarters

621 Hunt Valley Circle, New Kensington, Pennsylvania 15068
Phone: 724-334-5000 • Toll Free: 1-800-736-4666 • Fax: 724-334-5001
Website: www.MyBacharach.com • E-mail: help@MyBacharach.com

