

# ULTRASONIC FLAW DETECTOR PCE-FD 20



Operating Manual

2014



## CONTENTS

1. List of Abbreviations used.....	2
2. Introduction.....	2
3. Operating Conditions.....	3
4. Specifications.....	4
5. Operating principle.....	5
6. Operation of the device.....	7
7. Basic settings of flaw detector.....	22
8. Device memory.....	29
9. Calibration of the flaw detector.....	30
10. Maintenance.....	35
11. Precautions and trouble shooting.....	35
12. Contact information.....	36

## 1. List of Abbreviations used

The manual has the following abbreviations and symbols:

AFS – automatic signaling of defects;  
TVG – time varied gain;  
NDT – nondestructive testing;  
CB – calibration block;  
US – ultrasonic.

## 2. Introduction

### 2.1. Appointment of flaw detector

Flaw detector is designed for testing of products for the presence of defects such as discontinuity and homogeneity of materials, semi-finished products and welds for measuring depth and coordinates of defects, measure the thickness and sound velocity in the material.

Flaw detector implements shadow, echo and mirror-shadow testing methods. Flaw detector allows user to create, record and stored in nonvolatile memory temporary implementation of pulsed ultrasonic signals to subsequent transmitting to the PC for analysis and presentation in the form of a document. Integrated liquid crystal display (LCD) provides a mapping of ultrasonic signals in the form of A-scan, as well as images of cross sections of testing objects in the form of B-scans.

Flaw detector can be used in mechanical engineering, aerospace, metallurgy, mounting hardware, power equipment, as well as for the testing of transportation facilities.

### 2.2. Testing

For proper ultrasonic testing user must have testing methods for similar products and special requirements for ultrasonic testing. These requirements include: the definition of the task of testing, selection of suitable control techniques (testing schemes), the

selection of transducers, an assessment of the known conditions of control in such materials, the selection of the minimum size of the reflector for this type of product, reject level and so on.

### **2.3. Velocity of ultrasonic vibrations**

Accuracy of measurement of thickness and position of defects depends on the correct setting of the ultrasonic velocity in the material. Velocity of ultrasound is dependent on the physical characteristics of the material and its temperature.

### **3. Operating Conditions**

The device is designed to operate in the following environmental conditions:

- The temperature from -15 to +50 °C;
- Relative humidity to 95% at a maximum temperature of +35 °C.

The location of the flaw detector must be protected from direct exposure to dust, moisture and corrosive environments. The field strength of radio noise at the location of the flaw detector should not exceed the value of the infringing operation, i.e. creator of the flaw detector at the amplifier input voltage greater than half the maximum sensitivity. At high field strength of radio interference must be taken measures to shielding placements of flaw detector from the external electromagnetic field.

Operating position of the flaw detector may be any convenient for the user. To avoid moisture condensation inside the flaw detector when moving it from a cold to a warm place, it is necessary to sustain flaw detector for at least 4 hours before turning on in the premises.

#### 4. Specifications

Operating Frequency Range	from 1 to 10,0 MHz
The range of measured time intervals (duration of scanning)	from 6 to 1000 $\mu$ s
Velocity range	1000 - 9999 m / s
The error of measurement of time intervals	not exceed $\pm 0,025 \mu$ s
Maximum permissible error of measurement of the amplitudes of the signals at the receiver input in the range from 0 to 110 dB	not exceed $\pm 0,5$ dB;
Testing gain range	125 dB
Averaging over the quantity of starts	from 1 to 16
Digitally reconfigurable bandpass filter with tunable center frequency of the filter from 1 Hz to 10 MHz	
The range of variation of temporal sensitivity adjustment (TVG)	40 dB
Number of control points TVG	15
The duration of the excitation pulse to the load	from 0,0 to 0,5 $\mu$ s
The amplitude of the excitation pulse to the 50 Ohm load, not less	100, 200, 300
Operating frequency range of the receiver on the level -3 dB	from 1 to 10 MHz
Deviation of the amplitudes of input signals in the range from 10 to 100% of the screen height not more than	1 dB
Scanning	from 1 to 1000 $\mu$ s
Delay of scanning	from 0 to 2000 $\mu$ s
Range of measurement of time intervals	from 0 to 1000 $\mu$ s
Setting a delay in the prism of the	from 0 to 15 $\mu$ s

probe	
Automatic signaling of defects (AFS)	dual-gate
Setting range of AFS gates	from 0 to 2000 $\mu$ s
Adjusting thresholds of AFS gates	from 0 to 100 % высоты экрана
Detection of signals	positive half-wave, radio mode
Dimensions (WxHxD)	80x162x38 mm;
Weight, not more	250 g (without batteries)
Mean time between failures	not less than - 3000 hours

Ultrasound probes used - ultrasonic piezoelectric transducers for pulse flaw detectors.

The dimensions of the operating area of the screen is 48 x 74 mm.;

Electrical power is supplied from the following sources:

- AC power from 100 to 250 V, a frequency of  $(50 \pm 1)$  MHz;
- AA batteries 1,5 V (3 pcs.).

## 5. Operating principle

Operating principle of flaw detector is based on the ultrasonic contact NDT method, which uses the properties of ultrasonic vibrations to reflect from the borders between materials with different acoustic impedance. The ultrasonic transducer emits ultrasonic impulse into the tested object. Reflected from the defects or the product surface the echo signals are received by the ultrasonic transducer. The resulting electrical signals are subject to amplification, digitization, processing and output to the display. Displays echoes received by the flaw detector is performing as scanning of type A (A-scan) as well as images of cross sections of tested objects in form of B-scan.

### **5.1. Electronic unit of flaw detector**

Flaw detector makes the formation of electrical pulses to excite the piezoelectric transducer, gain derived from the piezoelectric transducer signals, processing and visualization of the formation and representation measurements in digital form, saving data in non-volatile memory and transfer it to PC.

The appearance of the electronic unit is shown on picture 6.1. Operation of flaw detector makes by keyboard. Visualization of signals and display of measurement results, the state of flaw detector and other information is shown on the LCD.

Connecting the probe is carried out by the coaxial cable through the connectors LEMO, which are located on top side of the devices body.

The device is powered by a three batteries type AA, or the included in set external charger connected to the mini-USB connector located on the bottom of the electronic unit of the flaw detector.

### **5.2. Probes**

Flaw detector is designed to operate with the contact, dual element and separated ultrasonic transducers with an operating frequency in the range from 1 to 10.0 MHz.

The device uses a generator of bipolar sounding pulses with adjustable duration, which provides compatibility with both probes: have integrated terminating inductance and without them, allowing operation operate with most types of probes on the market.

Depending on the type of probe it is used two types of cables and, correspondingly, two ways to connect the probe:

- Ultrasonic transducers (type S) are connected via single cable LEMO-LEMO to the left LEMO connector;
- Dual element transducers (type D) are connected by a double cable 2LEMO-2LEMO. Right connector is used to connect the

receiver of the piezoelectric element, the left - transmitter of the piezoelectric element.

## 6. Operation of the device

The basis of flaw detector operation is founded on the ability of ultrasonic vibrations spread into tested object and reflect from internal defects and object sides. The received signal is amplified and then converted into digital form processed by the microprocessor and the graphics and digitally displayed on the display.

Visualization of signals, display of measurement results, state of the flaw detector and other information are shown on the LCD. Exterior of the flaw detector is shown on picture 6.1.



*Picture 6.1 Exterior of the flaw detector*



## 6.1. Controls

Controls of the flaw detector presents as a keyboard.

The keyboard has 10 keys:



- switching on/off – press and hold for at least 3 seconds to turn on or off the device.



- "freezing" of the screen.



- screen rotation 90°.



- menu options.



- cancel the action and return to the previous menu.



- cursor movement, decrease the selected parameter.



- cursor movement.



- cursor movement, increase the selected parameter.



- cursor movement.



- enter.

To change the value of the selected parameter use the buttons



or





to select the parameter, by key



(decrease

the value of the selected parameter) or  (increasing the value of the selected parameter) to set the required value.

To change the discreteness of the selected parameter value changes, as well as to confirm the selected action use key . Selected discreteness displays as one of the icons  near the variable parameter.

## 6.2. Preparing to work with the device

Read this instruction manual and follow its instructions.

Flaw detector must be protected from direct exposure to dust, moisture, corrosive environments, and must be sufficiently lit by light sources.

The field strength of the external interference at the location of the flaw detector must not exceed values that violate its performance. At high field strength of external interference must be taken to shielding placements of the flaw detector, as well as its power supply and connected cables.

When operating from AC power to the flaw detector must be supplied mains with voltage from 100 to 250 V and with frequency of  $(50 \pm 1)$  Hz.

If in the power supply network arise switching noise in power supply network of the flaw detector must enable network filter.

To avoid moisture condensation inside the body, when moving from a cold environment to a warm, device must be hold in the warmth for 4 hours to dry completely.

At air temperatures below 10°C after switching on flaw detector must be warmed for at least 15 minutes.

Controls and indicator of the flaw detector located on the front panel, as shown in Picture 6.1.

Operating connectors are located at the top and bottom sides of the devices body.

**WARNING!** To prevent damage of connectors and cables - follow the instructions below!

Used in the device connectors consist of two parts: the instrument socket and the cable plug (Pic. 6.2.).



Picture 6.2. Connector used in the device

A method of connecting and disconnecting the plug and socket shown on Picture 6.2.1. When connecting user must ensured that the points of red color (if any) are plotted on the plug and the socket are jumped together.

**CAUTION:** When disconnecting the plug from the socket, hold its body in the dotted area. Do not pull the cable!!

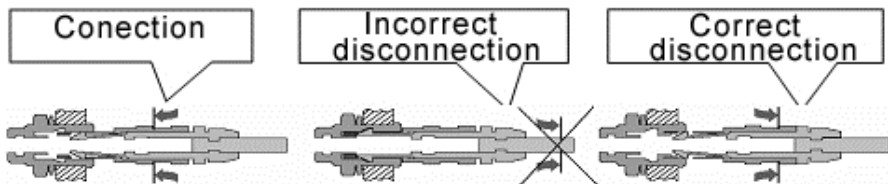

Picture 6.2.1 Manipulations with LEMO connectors

### 6.3. Turning on the flaw detector

If operation will be carried out by an external power supply, it is necessary to connect the power supply unit of the flaw detector to the power connector, located on the down side of the devices body. Operation of the device is possible during battery charging.

Before switching on flaw detector connect transducer. Connect the power adapter supplied with flaw detector to the corresponding connector. If you connect the battery and power supply, the flaw detector is powered from the power supply, if the power supply is disconnected, flaw detector automatically goes to battery supply.

To enable (disable) flaw detector press  and hold it for at least 3 seconds to short beep.

When you turn on the device screen of main menu is displayed.



Picture 6.3. Main menu of the flaw detector.

The main menu of flaw detector is consists of four sections:

- Measurements;
- Archive;
- Setup;
- Information.

#### **6.4. Connecting the transducer to the flaw detector**

Combined probe is connected to the left connector on the top panel of flaw detector and set in parameter group "Probe" parameter "DUAL" to "OFF".

Dual element transducers connect as follows: emitting plate of dual probe connect to the left connector, and the receiving plate connect to the right connector on top side of body of the flaw detector by inserting the cable connectors until its click. Set the parameter group "Probe" parameter "DUAL" to "ON".

#### **6.5. The main modes of operation of the flaw detector**

**"Measurement" mode** - goes to the measurement;

**"Archive" mode** - displays all stored measurement results and settings;

**"Settings" mode** - in this mode you can set the following settings: Time, Date, Language, Brightness, Palette, Sound, Auto off, Clear SD;

**"Information" mode** - display information about the manufacturer.

To select the required mode, move cursor by keys to select mode, and confirm selection by pressing the Enter button.

##### **6.5.1 "Measurement" mode**

"Measurement" mode is the main mode (Pic. 6.5.1), designed for ultrasonic testing.

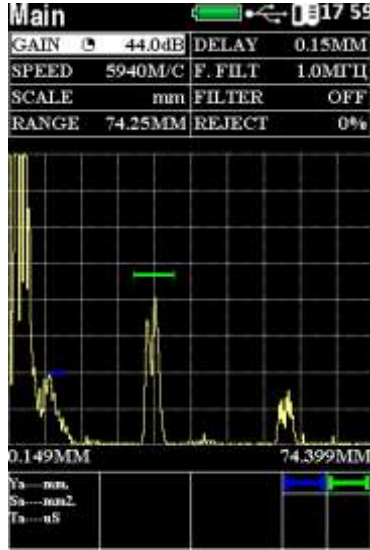

Picture 6.5.1 "Measurement" mode

All parameters for configuring the measuring part of flaw detector divided into groups, depending on the selected group user gets access to the various parameters.

Group	Parameters							
Main	GAIN	VELOCITY	SCALE	RANGE	DELAY	F.FILT	FILTER	REJECT
Puls/recv	GAIN	RANGE	DELAY	RECTIFY	POWER	F.FILT R	FILTER	REJECT
Gates	GAIN	GATE	START	WIDTH	LEVEL	PARAM. 1	PARAM. 1	PARAM. 1
Functions	GAIN	DSG	TVG	REJECT	PEAK	B-SCAN	AVG	
Probe	DUAL	DELAY	ANGLE	X.VAL	FREQ	PULSE		
TVG	GAIN	RANGE	DELAY	TVG	CLEAR	POINT	POS.	+dB
DGS	GAIN	DGS	POINT	POS.	dB	A LEVEL	mm <sup>2</sup>	
AFS	START	WIDTH	GATE	MEAS.	MODE	CONTR.	SEARCH	ALLARM

<b>Block 1</b>	PARAM. 1	PARAM. 2	PARAM. 3					
<b>Block 2</b>	PARAM. 1	PARAM. 2	PARAM. 3					
<b>Block 3</b>	PARAM. 1	PARAM. 2	PARAM. 3					

Description of parameters of flaw detector

Groups	Parameters	Description
Main	GAIN	Setting of gain of received path from 0 to 126 dB, in steps of 0.5, 5 dB.
	VELOCITY	Display the set velocity of ultrasonic vibrations in the tested material. Adjustment range from 1000 to 9999 m / s. Accuracy of the measurement the depth, coordinates of defects and thickness are depends on the accuracy of the velocity settings.
	SCALE	Selection of the display unit parameter settings. Has two meanings: microseconds ( $\mu$ s) and mm.
	RANGE	The duration of scanning - depth sounding along the beam. Adjustment range from 1 to 1000 $\mu$ s. Flaw detector processed only signals that are under scanning.
	DELAY	The "Delay" specifies the time delay relative to the start of scanning of the probe pulse. Setting range from 0 to 1000 $\mu$ s.
	F.FILT	Selecting the central operating frequency of receiver path (selection of frequency range receiver path). It can take values from 1 MHz to 10 MHz.

	FILTER	Turn on / off frequency filter.
	REJECT	Parameter allows to set the minimum level of the signals displayed on the screen.
Puls/recv	GAIN	Setting of gain of received path from 0 to 126 dB, in steps of 0.5, 5 dB.
	RANGE	The duration of scanning - depth sounding along the beam. Adjustment range from 1 to 1000 $\mu$ s. Flaw detector processed only signals that are under scanning.
	DELAY	The "Delay" specifies the time delay relative to the start of scanning of the probe pulse. Setting range from 0 to 1000 $\mu$ s.
	RECTIFY	Selecting the type of visualization of the signal. Can take two values: the POS HW and RADIO.
	POWER	Setting the level of the generator excitation. It can take values 100V, 150 V, 200 V.
	F.FILT	Selecting the central operating frequency of receiver path (selection of frequency range receiver path). It can take values from 1 MHz to 10 MHz.
	FILTER	Turn on / off frequency filter.
	REJECT	Parameter allows to set the minimum level of the signals displayed on the screen.
	Gates	GAIN
GATE		Selecting gate. Takes the values: A or



		B.
	START	Coordinate of the beginning of the selected gate. It can take values from 0 to the maximum value of scanning.
	WIDTH	The width of the selected control gate along the beam. It can take values from 0 to the maximum value of scanning. The total value of the start and the width of the gate can not exceed the value of the maximum scanning.
	LEVEL	The threshold level of the selected control gate. Is given in % of the screen height, can take values from 0 to 100% of the screen height.
	PARAM.1	Allows to select the measured value in the first block. **
	PARAM.1	Allows to select the measured value in the first block. **
	PARAM.1	Allows to select the measured value in the first block. **
Functions	GAIN	Setting of gain of received path from 0 to 115 dB at 0.1, 1 dB.
	DGS	Turn on / off DGS
	TVG	Turn on / off TVG
	REJECT	Parameter allows to set the minimum level of the signals displayed on the screen.
	PEAK	Turn on / off fixing the maximum amplitude of the echo.
	B-Scan	Turn on / off display of a scanning-type B-scan.
	AVG.	Number of echoes which are averaged

		result.
Probe	DUAL	Set the type of the connected ultrasonic transducer. Has two meanings: the combined and separate (dual).
	DELAY	Setting a delay in the prism of transducer.
	ANGLE	The angle of entry of the ultrasonic vibrations to the connected transducer.
	X.VAL	Allows to specify an arrow of transducer (set from 0 to 90 mm).
	FREQ	Setting the operating frequency of the ultrasonic transducer. Has a range from 1 MHz to 10 MHz.
	PULSE	Setting the duration of the transducer pulse.
TVG	GAIN	Setting of gain of received path from 0 to 126 dB, in steps of 0.5, 5 dB.
	RANGE	The duration of scanning - depth sounding along the beam. Adjustment range from 1 to 1000 $\mu$ s. Flaw detector processed only signals that are under scanning.
	DELAY	The "Delay" specifies the time delay relative to the start of scanning of the probe pulse. Setting range from 0 to 1000 $\mu$ s.
	TVG	Turn on / off TVG.
	CLEAR	Allows to reset the TVG.
	POINT	Select point TVG and display the total number of points. The maximum number of points TVG - 15.
	POS.	Displays coordinates of the position of

		the current point of TVG. The distance between two neighboring points is not less than 3 microseconds.
	+dB	Gain of the current point TVG. The total value of all the points of the TVG not more 40 dB, accuracy of setting 0.1 dB.
DGS	GAIN	Setting of gain of received path from 0 to 126 dB, in steps of 0.5, 5 dB.
	DGS	Turn on / off DGS.
	POINT	Select Point TVG and display the total number of points. The maximum number of points TVG - 15.
	POS.	Displays coordinates of the position of the current point of TVG. The distance between two neighboring points is not less than 3 microseconds.
	dB	Gain of the current point DGS. The total value of all the points of the DGS not more 40 dB, accuracy of setting 0.1 dB.
	A LEVEL	Allows to set the level / amplitude of the reference signal.
	mm <sup>2</sup>	Allows to set the value of the equivalent area of the reflector.
AFS	START	Coordinate of the beginning of the selected gate. It can take values from 0 to the maximum value of scanning.
	WIDTH	The width of the selected control gate along the beam. It can take values from 0 to the maximum value of scanning. The total value of the start and the width of the gate can not exceed the value of the maximum scanning.

	GATE	Selecting gate. Takes the values: A or B.
	MEAS.	A method for determining the time of arrival of the signal in the tested gate: "by the peak" - on the state of the maximum signal in the control gate; "by the flank" - on the first crossing of the signal with the threshold in the control gate.
	MODE	Determines the mode of operation of the gate: MORE - echo level is crossed gate; LESS - echo signal is below the gate.
	CONTR.	Setting the control area. The maximum value of 20 dB, but can not exceed the value of the search gate.
	SEARCH	Setting the level of the search area. The maximum value is 20 dB.
	ALARM	Turn on / off sound.
Block 1	PARAM.1	Allows to select the measured values in the first of three blocks. **
	PARAM.2	Allows to select the measured values in the first of three blocks. **
	PARAM.3	Allows to select the measured values in the first of three blocks. **
Block 2	PARAM.1	Allows to select the measured values in the second of three blocks. **
	PARAM.2	Allows to select the measured values in the second of three blocks. **
	PARAM.3	Allows to select the measured values in the second of three blocks. **
Block 3	PARAM.1	Allows to select the measured values in

		the third of three blocks. **
	PARAM.2	Allows to select the measured values in the third of three blocks. **
	PARAM.3	Allows to select the measured values in the third of three blocks. **

\*\* - Measured values of the received ultrasonic vibration signals:

Ta – time value signal in the gate A, shown in microseconds.

Tb – time value signal in the gate B, shown in microseconds.

Ta-b – the difference between the time values between the signals A and B in gate.

Aa – value of signal amplitude in gate A.

Ab – value of signal amplitude in gate B.

Aa-b – the difference between the amplitudes of the signal in the A and B gates.

Xba – the distance from the front edge of the signal in gate A.

Xbb – the distance from the front edge of the signal in gate B.

Xipa – the distance from the input signal in the gate A.

Xipb – the distance from the input signal in the gate B.

Ya – coordinate of signal depth in the gate A.

Yb – coordinate of signal depth in the gate B.

Ya-b – the difference between the values of the coordinate signals depth A and B.

Sa – equivalent area signal in gate A.

Sb – equivalent area signal in gate B.

La – distance to the reflector along the beam in the gate A.

Lb - distance to the reflector along the beam in the gate B.

dAa – value of the signal level (dB) from the gate A to the maximum signal.

dAb – value of the signal level (dB) from the gate B to the maximum signal.

La - Lb - the difference between the values of the distance to the reflector along the beam in gates A and B.

For measurement values (except Ta-b, Aa-b, Ya-b and La - Lb) it is necessary to combine control gates A or B with the signal in which it is planned to carry out measurements. To determine the Ta-b, Aa-b, Ya-b and La - Lb is necessary to set control gates A and B on two adjacent echoes.

### 6.5.2. "Archive" mode

This mode allows user to view all previously stored results of testing and download the selected file to continue working with the required settings.

Previously stored results are presented in a list and sorted by creation date.

To operate with the stored files use buttons



or



to

select required file and press



. The drop-down menu offers the following steps:

Actions	Description
List	Return to the list of stored files
Delete	Delete the selected record
PreView	Viewing stored scanning image
View	Viewing stored result of control with all parameters of flaw detector
Load meas.	Downloading all the settings for measurements with previously saved settings
Load probe	Downloading all the parameters of the transducers
Exit	Back to list of all files

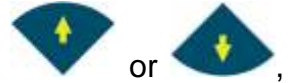

Selection of the action makes with the buttons

and presses the "Enter" , then user will be prompted to confirm the selected action by pressing "Yes" or cancel by pressing the "No".

## 7. Basic settings of flaw detector

### 7.1. Initial setup of the device

#### 7.1.1. Selection of A-scan mode

To select the display mode of the signal as A-scan in the menu "Puls/recv" select the "RECTIFY" and set one of available options: "POS HW" or "RADIO". Typically, the main mode of A-scan is the "POS HW".

#### 7.1.2. Selection of basic units

The main flaw detectors units can be  $\mu\text{s}$  or mm.

To select the required units it is necessary in the group of parameters "Main" set the required value of the "Units".

### 7.2. Setting the transducer parameters

Accuracy of measurement is depend on the correctness settings of transducer parameters when working with flaw depends. Flaw detector allows you to work with both combined, and with dual element transducers..

#### 7.2.1. Selecting the type of transducer

To select the type of the transducer in the parameter group "Probe" set the required value of the "DUAL": "ON" or "OFF".

### **7.2.2. Setting the frequency of transducer**

To set the frequency of transducer in the group of parameters "Probe" set the required value of the parameter "FREQ".

### **7.2.3. Setting the input angle of transducer**

To set the input angle of transducer in the group of parameters "Probe" set required value of the parameter "ANGLE".

### **7.2.4. Setting delay in the transducers prism**

Typically, during the ultrasonic testing piezoceramic plates are not in contact with the tested object, and are protected by a layer of protective material (protector) or (in the case of angle-beam transducer) is mounted on a corner prism.

For correct calculation of the coordinates, it is necessary to compensate the moving time of ultrasonic vibrations through the protector / prism.

### **7.2.5. Installation of transducers arrow**

During testing with angle-beam transducer coordinates is calculated from the output point of the beam. In order to be able to take a measurement from the front face of transducer must be set arrow of probe. To install arrow of transducer in the group of parameters "Probe" set the required value of the "X.VAL".

## **7.3. Setting the display of signal**

### **7.3.1. Setting the gain**

To adjust the gain in parameter group "Main" select "GAIN" and set the required gain value.

### **7.3.2. Setting the duration of the scanning**

To adjust the duration of the scanning in the group of parameters "Main" set required value of the parameter "RANGE".



### 7.3.3. Setting the scanning delay

To adjust duration of delay in parameter group "Main" set the required value of the parameter "DELAY".

### 7.3.4. Setting cut-off of signal

In some cases it is convenient to use cut-off signal on the vertical axis to enhance the perceptual quality of the signal. This method allows to remove from the screen of the flaw detector noise, as well as other small amplitude signals, preventing the identification of useful signals.

To set the cut-off signal, in parameter group "Main" set the required value of the "REJECT". The cut-off is a percentage of the screen height.

### 7.3.5. Envelope of the signal mode

In some cases it may be necessary to detect the maximum of signal, and get an envelope signal during scanning of reflectors.

To activate the envelope in group settings "Functions" set the required value of the "PEAK": "ON" or "OFF".

## 7.4. Setting of the flaw detector for measurements

### 7.4.1. Basic settings of control areas (Gates)

Flaw detector has two independent gates - A and B. Configure of gates is basic operation, that allow configure the flaw detector for measuring the signal amplitudes, the depth of the reflector, thickness measurements etc.

For each of the control gates can be set independently:

- The level of the gate as a percentage of the screen height of the flaw detector;
- The start coordinates of the control gate;
- The width of the control gate (gate length);
- Signal (audio alarm when signal cross the control gate).

#### **7.4.1.1. Setting the level of the control gate**

To adjust the control gate level in a group of parameters "Gates" in parameter "GATE" set required strobe (A or B) and change the parameter "LEVEL" to set required value.

#### **7.4.1.2. Setting start of control gate**

To set the start of the control gate in a group of parameters "Gates" in parameter "GATE" set required strobe (A or B) and change the parameter "Start" to set the required value.

#### **7.4.1.3. Setting the width of the control gate**

To adjust the width of the control gate in a group of parameters "Gates" in parameter "GATE" set required strobe (A or B) and change the parameter "width" to set required value.

#### **7.4.1.4. Enable sound alarm**

To enable / disable the sound alarm when the level crossing control gate in the parameter group "AFS" in the parameter "GATE" set required strobe (A or B) and change the parameter "ALARM" to enable or disable the alarm.

#### **7.4.1.5. Setting the measurement mode in the control gate**

To set the measurement mode in the control gate in a group of parameters "AFS" select the menu "GATE" and set required value of the parameter "MEAS.". The "MEAS." can take one of two values "PEAK" and "FLANK". If you select "FLANK" measurement will be made on the front of the signal entering the control gate. If you select the "PEAK" measuring will be for the maximum of the signal entering the control gate.

#### **7.4.1.6. Setting the trigger gate**

In flaw detector implemented the ability of activation of defects alarm for the signal above the level of the control gate (alarm is triggered if

the signal is above the level of the control gate, the mode of "MORE"), and for signal lower than the level of the control gate (alarm is triggered if the signal is less than the level of the control gate, the mode of "LESS").

To set the trigger control area in the group of parameters "AFS" change parameter "MODE" to set the required mode in the alarm gate.

#### **7.4.1.7. Setting additional levels of control in the area**

In flaw detector is possible to set additional levels in the control area: control and search. Additional levels are set in dB relative to the main level of the control gate independently for each control gate.

To set additional levels of control in parameter group "AFS" set the required parameters "CONTR." and "SEARCH" for the required control gate.

On the display of the device will appear additional levels of control and search control gate below basic level area.

### **7.4.2. Setting the display of the measured parameters**

#### **7.4.2.1. Basic principles of the display of the measured parameters**

All parameters measured by flaw detector, can be displayed in a special area on the display.

Area with a display parameter consists of three blocks separated vertically. In each of these blocks can be displayed one to three of the measured parameters.

#### **7.4.2.2. Installation of the displayed parameters**

To adjust the output to the screen of the flaw detector measured parameters of ultrasonic impulse in the group of parameters select any of the three blocks "Block 1", "Block 2" or "Block 3" and set the measured value in the line "PARAM.1", "PARAM.2", "PARAM.3"

displayed in the selected block. If set "---" for the string "PARAM. 1", "PARAM. 2", "PARAM. 3", area of the screen corresponded this line will remain blank.

In one block can be displayed one to three parameters. If selected only one parameter for display, it will be displayed in large font (recommended for displaying the main parameter being measured). If display two or three parameters in a block, font will be reduced (recommended for the secondary display of measured values).

### **7.5. Setting the sound velocity in the tested object**

To properly coordinate measuring defects and measuring the thickness of the tested object it is necessary to set the speed of propagation of ultrasonic vibrations in the material of tested object.

To set the velocity of ultrasonic vibrations in the tested object in the group of parameters "Main" select "VELOCITY" and set the required value.

### **7.6. The display mode signal as B-Scan**

Presentation the results of ultrasonic testing in the form of a cross-section of the tested object, perpendicular to the surface and parallel to the direction input sounding. To estimate the amplitude of the echo signals amplitude there is correlation between echo signals and color of images. The right side of the display of measurement results presented color scheme estimates the amplitude echo signal, where blue is the smallest and red is the highest echo signal amplitude.

When operating in any of the possible types of scanning user is able to adjust all the parameters required for optimum performance and ease visualization of the received echoes. When changing scanning type A to type B (and vice versa), all settings remain saved.

### 7.7. Measurement mode with averaging of signal

In some cases, during testing materials with high damping, when controlling of large tested objects and operating at high scanning duration, noise amplitude can be compared with the amplitude of the useful signal and on the background of strong noise useful signal is difficult to detect.

For these cases, in the device is implemented the averaging mode, which can be done by 2, 4, 8 and 16 signals. To activate the averaging in the group of parameters "Functions" select and activate the parameter "AVG." and set required number of averaging.

Caution, when the averaging mode activated it is reduced frequency of refreshing of signal on the display.

### 7.8. Measurement mode with signal accumulation

In some cases it may be necessary to detect the maximum of signal, and get an envelope of signal during scanning.

To activate the envelope mode in group settings "Functions" select the "PEAK" and set the required parameter - on or off.

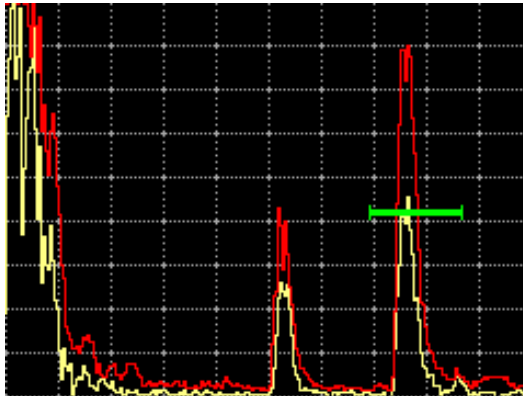

## 8. Device memory

### 8.1. Saving the results of test and device settings

To save the current settings, in measurement mode press the

"frozen" key , on the devices display image will be fixed (frozen), also all current settings are saved. After pressing the button

 the user will be asked to save the current measurement and settings. After entering the name, the measurement is saved as a separate file.

Enter the file name by using the virtual keyboard.

Moving the cursor over the keyboard is carried out by pressing

, selecting the required symbol is carried

out by pressing the button . After entering the file name, press

.

### 8.2. Downloading the configuration settings of the device or transducers from the archive

To load a previously saved device settings (configuration) or transducer settings go to the "Archive".

With keys  or  select from list required file and press

. In the dropdown menu select the "Load meas." for the loading instrument settings or select "Load probe" to download transducer

parameters by pressing ,  and "Enter" . Next, the

user will be asked to confirm the selected action by pressing "Yes" or cancel by pressing "No".

## **9. Calibration of the flaw detector**

### **9.1. Measuring of prism delay for direct transducer**

During operation with the direct transducer abrasion occurs with prism, it cause to changes of delay of the signal in transducer. Given that the propagation of time in the prism transducer significantly affect the accuracy of calculation of the coordinates of the reflectors it is very important to accurately measure the delay in the prism and periodically update this parameter.

Measurement of prism delay of direct transducer made using a standard sample SO-2.

To measure delays in the prism of transducer it is necessary to get a first reflected signal (the first ground signal) on a standard sample SO-2 on the side of 59 mm and put this signal into one of the control gates, for example gate A.

Configure the display of the measured parameters - display the value of the propagation time along the beam or propagation time required for the control gate, in this example -  $L_a$  and  $T_a$  accordingly.

Time of propagation of ultrasonic vibrations in the prism of direct transducer in microseconds equals:

$$2t = t_1 - 20 \mu s,$$

where  $t_1$  - the time between excitation pulse and the echo from the surface of the standard sample SO-2 at the side 59 mm with transducer position corresponding to the maximum amplitude of the echo signal, for this example - the value  $L_a$  or  $T_a$ ;

$20 \mu s$  - the propagation time of the ultrasonic vibration in the standard sample on the side of 59 mm.

## 9.2. Measuring of prism delay for angle-beam transducer

During operation with the angle-beam transducer abrasion occurs with prism, it cause to changes of angle and delay of the signal in transducer. Given that the propagation of time in the prism transducer significantly affect the accuracy of calculation of the coordinates of the reflectors it is very important to accurately measure the delay in the prism and periodically update this parameter.

Measurement of prism delay of angle-beam transducer made using a standard sample SO-3.

To measure delay in the prism it is necessary to get the reflected signal from the radiused surface at the standard sample SO-3 and put this signal into one of the control gates, for example gate A.

Configure the display of the measured parameters - display the value of the propagation time along the beam for the required control gate, in this example - La.

Time of propagation of ultrasonic vibrations in the prism of angle-beam transducer in microseconds equals:

$$2t = t_1 - 33,7 \mu s,$$

where  $t_1$  - the total time between the excitation pulse and the echo signal from the concave cylindrical surface in the standard sample SO-3 when the transducer is installed in a position corresponding to the maximum amplitude of the echo signal, for this example - the value La;

33,7  $\mu s$  - the propagation time of the ultrasonic vibration in the standard sample, calculated for the parameters: the radius of the sample - 55 mm, the propagation velocity of the transverse wave in the material sample - 3,26 mm/ $\mu s$ .



### 9.3. Measurement of input angle of transducer

Measuring of the input angle of the beam of angle-beam transducer in position A or B in Picture 10.3. Moving of angle-beam transducer near these positions user seek maximum of the echo signal from the reflector (cylindrical hole  $\varnothing 6$  mm. located at a depth of 44 mm or 15 mm for the various positions of probes). Value of the angle is specified on the marks of the corner scale opposite the output point of ultrasonic beam.

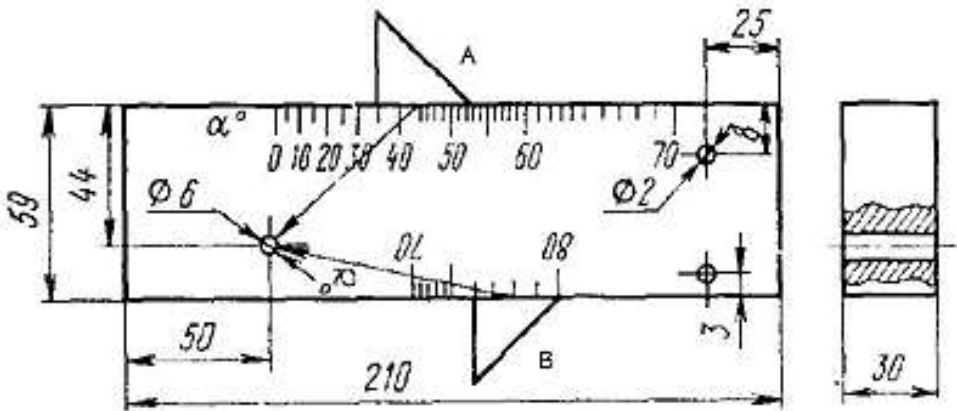

Picture 10.3 Standard sample SO-2

### 9.4. Measurement of transducers arrow

To find output point 0 of ultrasonic beam of angle-beam transducer put probe on central mark "0" (Pic. 10.4) and with small movements find position corresponding to the maximum echo signal. Output point is located exactly above the center mark of the sample.

Arrow of transducer in millimeters defined as the distance from the output point of the ultrasonic beam to the end of the transducer body in the direction of sounding (measured along the lateral scale is marked in millimeters).

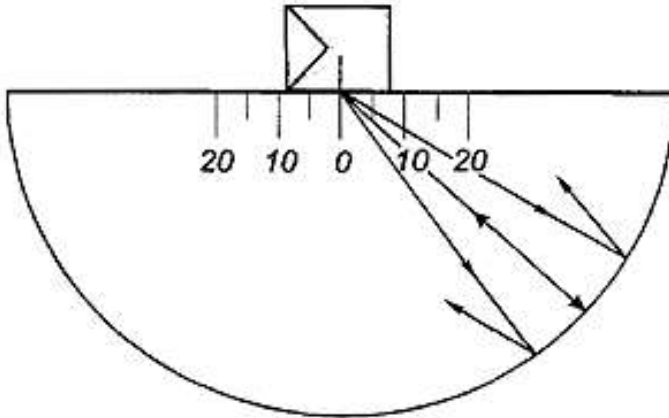

Picture 10.4 Standard sample SO-3

### 9.5. Measurement the velocity of ultrasonic vibrations in the tested object

Measurement the velocity of ultrasound can be performed directly on the tested object or with the samples made from the same material.

Before the measurement of ultrasonic velocity in the material of the tested object it is necessary to make setting of the transducers (set the correct delay value in the prism and set the angle for the angle-beam transducer) described above.

Select the place on the product (or on sample of the same material) in which can be made thickness measurement of the sample using appropriate transducer. Set the control gate, adjust the display the thickness of tested object. Mechanically with satisfying accuracy make measurement of real thickness at the point of control.

Measurement (setting) of the ultrasonic velocity in the material of tested object (or a sample of similar material) is produced by adjusting the value of the parameter "VELOCITY" in the "Main" to align the measured values of the thickness of the object (sample) with the real (obtained by measuring the mechanical method).

### 9.6. Calculations of the equivalent area of the reflector

$\alpha$  – input angle of ultrasonic vibrations in the material;

$v$  – velocity in the material;

$f$  – frequency of transducer;

$R$  – radius of lateral drilling;

$x$  – depth of the defect;

$r$  – length of the passage of ultrasonic vibrations to the defect along the beam;

$\lambda = v/f$  – the length of the wave in the material;

$r_0$  – the length of near gate of transducer;

$\pi = 3,1415$  – constant;

$S_p$  – effective area of transducer;

$L_{pr}$  – length of the path in the prism;

$v_{pr}$  – velocity of ultrasonic vibrations in a prism.

$$L_{pr} = \frac{T_{pr} \cdot v_{pr}}{2} \cdot \frac{v_{pr}}{v} \quad (*)$$

$$r = L_{pr} + x / \cos[\alpha]$$

$$r_0 = \frac{S}{\lambda \cdot \pi}$$

Equivalent area of the reflector:

for lateral drilling

$$s = \lambda \cdot \sqrt{\frac{R \cdot r}{4}}$$

to the plane (angle)

$$s = \frac{r \cdot \lambda}{2}$$

## 10. Maintenance

Maintenance of flaw detector is carrying out for preventive maintenance to ensure the normal operation of flaw detector during its using. Recommended periods for the following types of maintenance operation:

- visual inspection - every month;
- exterior cleaning - after each exploitation.

At visual inspection of the external state of flaw detector is recommended to check the absence of chips and cracks, clarity of the controls, mounting parts on the device. Dust on the body of the device cleared by soft cloth or brush.

## 11. Precautions and trouble shouting

11.1. Use the device with care. Any wrong using may result in the violation of the present technical specifications and thus, lead to the manufacturer warranty cessation.

11.2. Always check the integrity of the cables, information processing unit and transducers. Provide immediate replacement of the damaged parts by the original ones. These operations must be performed by skilled personnel.

11.3. Do not expose the device to aggressive chemical medium.

11.4. Do not leave the device at the direct sun rays.

11.5. Do not sink the device into any liquids. If the device gets wet, take the battery out and leave for 24 hours to get dry.

## 12. Contact information

If you have any questions about our range of products or measuring instruments, please contact PCE Instruments.

### 12.1. PCE Instruments UK Ltd.

**By post:**

PCE Instruments UK Ltd.  
Units 12/13 Southpoint Business Park  
Ensign Way, Southampton  
Hampshire  
United Kingdom, SO31 4RF

**By phone:**

02380 987 035

### 12.2. PCE Americas Inc.

**By post:**

PCE Americas Inc.  
711 Commerce Way, Suite 8  
Jupiter, FL 33458 USA

**By phone:**

561 320 9162