



# User Manual

PCE-2900 Leeb Hardness Tester



User manuals in various languages (français, italiano, español, português, nederlands, türk, polski, русский, 中文) can be found by using our product search on: [www.pce-instruments.com](http://www.pce-instruments.com)

Last change: 18 July 2022  
v1.1

# Contents

<b>1</b>	<b>Safety notes</b> .....	<b>1</b>
<b>2</b>	<b>Introduction</b> .....	<b>2</b>
<b>3</b>	<b>Features</b> .....	<b>2</b>
<b>4</b>	<b>Technical specifications</b> .....	<b>2</b>
<b>5</b>	<b>Measuring principle</b> .....	<b>3</b>
<b>6</b>	<b>Standard package and optional accessories</b> .....	<b>4</b>
<b>7</b>	<b>Device description</b> .....	<b>4</b>
<b>8</b>	<b>Technical characteristics</b> .....	<b>7</b>
8.1	Characteristics of the test surface .....	7
8.2	Specimen fixation.....	7
<b>9</b>	<b>Testing the accuracy</b> .....	<b>8</b>
<b>10</b>	<b>Getting started</b> .....	<b>8</b>
10.1	Assembly .....	8
10.2	Preparation .....	8
10.3	Load.....	8
<b>11</b>	<b>Measurement</b> .....	<b>8</b>
<b>12</b>	<b>Test results representation</b> .....	<b>9</b>
<b>13</b>	<b>Menu navigation</b> .....	<b>9</b>
13.1	Impact direction.....	9
13.2	Number of measurements to calculate average.....	10
13.3	Material selection .....	11
13.4	Probe type.....	12
13.5	Hardness scale selection.....	13
<b>14</b>	<b>Instrument setup</b> .....	<b>14</b>
14.1	Display settings .....	14
14.2	Version.....	15
<b>15</b>	<b>Data processing</b> .....	<b>15</b>
15.1	Data storage data via USB connection with an external USB data medium .....	16
15.2	Data storage and transfer via WiFi (possible soon) .....	17
<b>16</b>	<b>Data/documents processing</b> .....	<b>18</b>



<b>17</b>	<b>Calibration .....</b>	<b>19</b>
<b>18</b>	<b>Maintenance and repair .....</b>	<b>20</b>
18.1	Battery replacement .....	20
18.2	Troubleshooting .....	20
18.3	Environmental requirements.....	20
<b>19</b>	<b>Charts.....</b>	<b>21</b>
19.1	Chart 2.....	21
19.2	Chart 3.....	21
19.3	Chart 4.....	22
<b>20</b>	<b>Contact.....</b>	<b>23</b>
<b>21</b>	<b>Disposal .....</b>	<b>23</b>



## 1 Safety notes

Please read this manual carefully and completely before you use the device for the first time. The device may only be used by qualified personnel and repaired by PCE Instruments personnel. Damage or injuries caused by non-observance of the manual are excluded from our liability and not covered by our warranty.

- The device must only be used as described in this instruction manual. If used otherwise, this can cause dangerous situations for the user and damage to the meter.
- The instrument may only be used if the environmental conditions (temperature, relative humidity, ...) are within the ranges stated in the technical specifications. Do not expose the device to extreme temperatures, direct sunlight, extreme humidity or moisture.
- Do not expose the device to shocks or strong vibrations.
- The case should only be opened by qualified PCE Instruments personnel.
- Never use the instrument when your hands are wet.
- You must not make any technical changes to the device.
- The appliance should only be cleaned with a damp cloth. Use only pH-neutral cleaner, no abrasives or solvents.
- The device must only be used with accessories from PCE Instruments or equivalent.
- Before each use, inspect the case for visible damage. If any damage is visible, do not use the device.
- Do not use the instrument in explosive atmospheres.
- The measurement range as stated in the specifications must not be exceeded under any circumstances.
- Non-observance of the safety notes can cause damage to the device and injuries to the user.

We do not assume liability for printing errors or any other mistakes in this manual.

We expressly point to our general guarantee terms which can be found in our general terms of business.

## 2 Introduction

The PCE-2900 portable hardness tester enables quick and convenient on-site hardness testing according to the Leeb principle.

The PCE-2900 is an advanced tester with a menu in English or German, with a high memory capacity, a WiFi port (function will be available soon), a USB port, a long battery life (>50 h in standby mode), etc.

The meter automatically shows the different hardness scales (HRC, HRB, HV, HB, HS) in the display during the measurement.

The PCE-2900 has a low energy consumption, enabling the user to carry out continuous on-site measurements.

The user manual should be read completely before first use.

## 3 Features

- Portable hand-held device, weight: 350 g
- Measurement possible in any position
- High accuracy of  $\pm 0.5\%$
- Wide measurement range
- For metals

## 4 Technical specifications

Measuring range	170 ... 960 HLD
Reproducibility	$\pm 6$ HLD
Impactor	Type D
Measuring direction	360°
Adjustable scales	Leeb, Brinell, Rockwell A, Rockwell B, Rockwell C, Vickers, Shore
Surface quality Ra of the workpiece	2 $\mu\text{m}$
Minimum weight of the workpiece	Direct measurement: 5 kg / 11 lbs Tied measurement: 2 ... 5 kg / 4.4 ... 11 lbs With coupling gel: 0.05 ... 2 kg / 0.1 ... 4.4 lbs
Minimum thickness of the workpiece	Direct measurement: > 5mm / > 0.19 in With coupling gel: 0.8 ... 5 mm / 0.03 ... 0.19 in
Display	Colour LCD
Internal measured value memory	600 records in 6 files
Interface	USB, WiFi
Power supply	2 x 1.5V AA batteries
Operating time	ca. 50 hours
Operating conditions	10 ... 50°C / 50 ... 122°F max. 90% RH
Storage conditions	-30 ... 60°C / -22 ... 140°F max. 90% RH
Dimensions	160 x 80 x 35 mm / 6.3 x 3.1 x 1.3 in
Weight	350 g / < 1 lb

## 5 Measuring principle

### Hardness measurement, rebound procedure (Leeb)

The rebound procedure is a dynamic hardness test procedure. Portable hardness testers such as the PCE-2900 work according to this principle. A spring force propels an impact body (a carbide ball) against the surface of the material to be tested.

The decrease in velocity between the impact and the rebound of the impact body serves as the measuring parameter. After a calibration and in consideration of the influence of the mass and the surface characteristics of the test material, the decrease in velocity is directly linked to the hardness.

$$HL = 1000 \times VB / VA$$

HL = Leeb hardness

VB = Rebound velocity

VA = Impact velocity of impact body

Diagram:

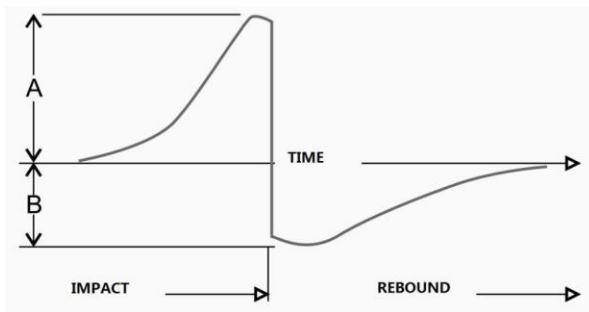

## 6 Standard package and optional accessories

1 x hardness tester PCE-2900, 1 x Impact device type D with cable, 1 x test block, 2 x 1.5 V AA batteries, 1 x user manual, 1 x carrying case



Optional: ISO calibration certificate

A certification according to DIN ISO includes a laboratory calibration incl. certificate with all measured values. This can be purchased directly with your PCE-2900 hardness tester and as a re-calibration every year.

## 7 Device description

### 7.1.1 Display with touch pad



7.1.2 Probe

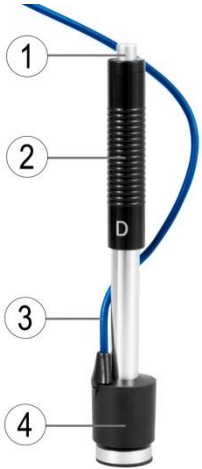

- 1. Trigger button
- 2. Test body
- 3. Test cable
- 4. Test tip

7.1.3 Display main menu

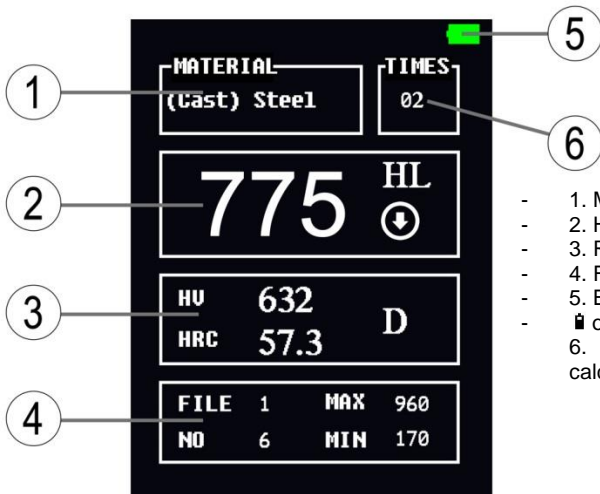

- 1. Material
- 2. Hardness scale
- 3. Reading information
- 4. File no., memory item
- 5. Battery level,
  - ☑ ok, ☐ charging
- 6. No. of measurements to calculate average



### 7.1.4 Keys

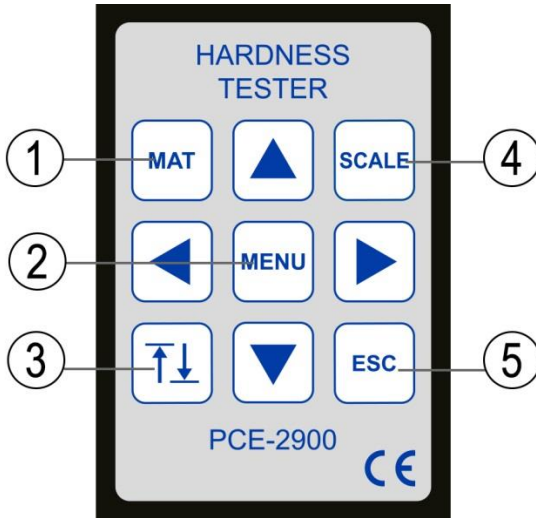

- 1. Material selection
- 2. Menu
- 3. Calibration
- 4. Hardness scale setting
- 5. ESC

## 8 Technical characteristics

### 8.1 Characteristics of the test surface

The specimen surface shall comply with the relevant requirements in chart 2. Avoid excessive heat or cold treatments to the surface.

- The roughness of the specimen surface will affect the measurement accuracy. Therefore, the test specimen surface must keep metallic luster and be smooth and free from oil.
- A flat and even surface will bring the best results.
- When the curvature  $R$  of the measured surface is less than 30 mm, the standard support ring should be replaced by a smaller support ring or by specially shaped support rings.

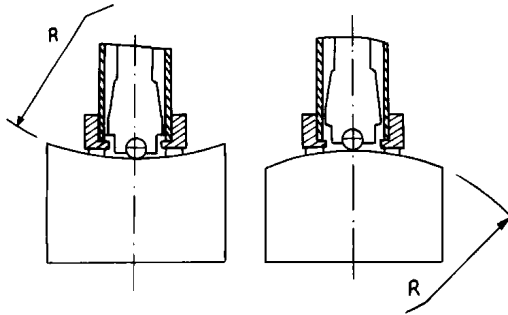

### 8.2 Specimen fixation

For heavy samples, no fixation is needed.

Medium-sized specimen must be placed on a flat, hard and solid surface, in an absolutely stable way without any room for movement. The sample should fulfil the minimum thickness of the according to chart 2.

For samples with surface hardened layer, the hardening layer depth must be as specified in chart 2.

Lightweight samples must be tightly coupled with a supporting body with some coupling agent. The two coupling surfaces must be smooth.

The probe must be rectangular to the sample.

If the sample is a big plate, pole or bending part, it must be fixed accordingly. If this is not observed, deformations, instability and decreased accuracy can occur.

The sample should be less than 30 gauss magnetic.

## 9 Testing the accuracy

Test the calibration of the hardness tester by using some hardness blocks with a known hardness. The value of the test blocks and the repeatability should be within the range according to chart 2 and 3.

### Note

The hardness blocks used should be standard Leeb hardness blocks. Each hardness block should be tested 5 times.

If the mean value deviates too much from the hardness value (HLD, Leeb) specified on the test block, you must calibrate the gauge by using the calibration function in the menu.

## 10 Getting started

### 10.1 Assembly

Attach the test cable to the test tip by inserting the 3-pole plug of the cable into the jack of the test tip. Then insert the test cable into the jack at the front of the PCE-2900 hardness tester.

### 10.2 Preparation

On the front side of the meter, next to the probe jack, you can find the On/Off button. Push this button briefly to turn on/off. The PCE-2900 will automatically power off after approx. 5 minutes of inactivity.

### 10.3 Load

Push down the black plastic sleeve in the direction of the test tip until you hear a clicking sound, meaning that it snaps in. The sleeve will then move back up. The test tip is now loaded.

Before starting a measurement, check if the trigger mechanism works by applying the trigger button without placing the test tip on the test surface.

## 11 Measurement

Place the test tip on the test surface rectangularly. The support ring must lay evenly on the test surface. Push the trigger button on the upper side of the impact device, in a similar way as you would use a ball pen. You can then read the measured value on the display and load the test tip again. Each sample must be tested 5 times. The deviation of the mean value should not exceed 15 HL.

The permissible distance between any two indentations or any indentation to the edge of the can be found in chart 1.

For a specific material, to transfer Leeb hardness values accurately into other hardness scales, you must carry out a contrast test to get the corresponding conversion relationship.

The contrast test must be carried out using an accredited Leeb hardness tester of the corresponding hardness scale, tested on the same sample. Five points per scale must be tested to set up the hardness diagram for comparison which must include at least three sets of data.

Distance between the two indentation centers	Distance between Indentation center and the sample edge
≥	≥
3mm	5mm

Chart 1

## 12 Test results representation

Leeb hardness values are shown on the display. For example, 700HLD represents a D-type impact device that has measured a Leeb hardness value of 700.

When Leeb hardness values are converted into other hardness scales, the abbreviation of the hardness scale must be followed by the Leeb hardness abbreviation. For example, 400HV HLD means that a measurement was made with a D-type impact device in line with the Leeb hardness scale and the converted Vickers hardness value is 400.

## 13 Menu navigation







- Press the **Menu** key.
- The virtual keypad will appear.
- Press the **ESC** key to return to the last menu item.

### 13.1 Impact direction

Press the **Menu** key.

Go to the menu item „Measure“.

Use the   keys to select menu item **1**.

Then select the impact direction for the measurement, using the   keys.



You can choose from these options: +90°; -45°; 0°; +45°; -90°



Press the **ESC** key to leave the selection screen and go back to the last menu item.

### 13.2 Number of measurements to calculate average

Measurement Set		
1	Direction	Down
2	Ave Time	3
3	Material	Cast.Steel
4	Probe	DL
5	Scale 1	HV
6	Scale 2	HV
7	Scale 3	HRC



ESC

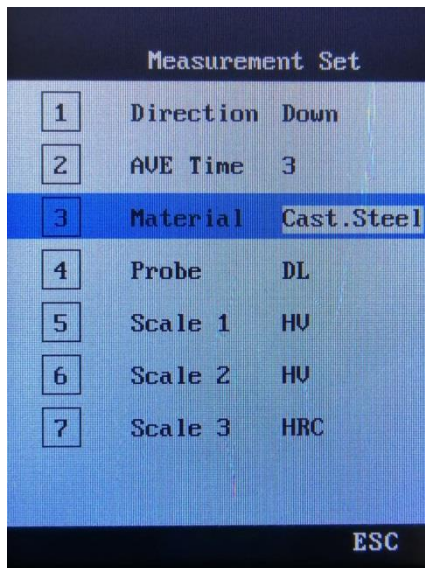

Select menu item **2** by using the   keys.

Use the   keys again to select the number of measurements to be used to calculate the average value.

Leave the selection screen and go back to the previous menu item by pressing **ESC**.



Select menu item **3** by using the   keys.

Use the   keys again to select the material to be tested.

You can select one of these materials: CWT steel, stainless steel, grey cast iron, nodular cast iron, cast aluminium, red brass, CU cast aluminium, copper

Leave the selection screen and go back to the previous menu item by pressing **ESC**.

### 13.4 Probe type

Measurement Set		
1	Direction	Down
2	AVE Time	3
3	Material	Cast.Steel
4	Probe	DL
5	Scale 1	HV
6	Scale 2	HV
7	Scale 3	HRC



ESC



Select menu item **4** by using the **▲** **▼** keys.

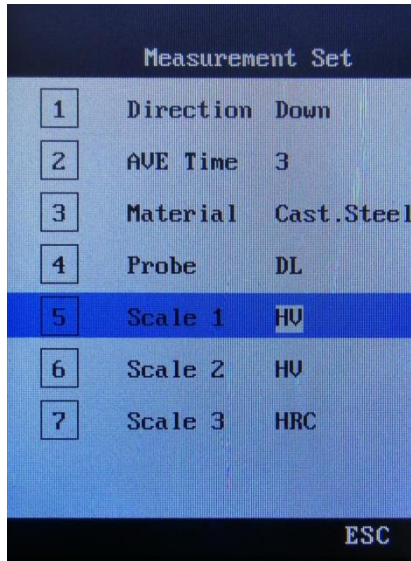

Select the probe type. **DL** is the standard value.



Leave the selection screen and go back to the previous menu item by pressing **ESC**.







Select menu item **5** by using the   keys.

Select the required hardness scale by using the   keys.

Select menu item **6** by using the   keys.

Select the required hardness scale by using the   keys.

Select menu item **7** by using the   keys.

Select the required hardness scale by using the   keys.

In each menu item, you can select HL, HRA, HRB, HS, HRC, HB or HV.

Leave the selection screen and go back to the previous menu item by pressing **ESC**.



## 14 Instrument setup

There are many display settings which the user can set according to their own demand.

### 14.1 Display settings

User the arrow keys to select the "Setup" menu and press the **Menu** key.

Use the arrow keys to make one of the following selections:

- 1 Touch tone on / off, confirm with the **Menu** key or go back with the **ESC** key.
- 2 Backlight on / off, confirm with the **Menu** key or go back with the **ESC** key.  
**Note:** Use only in dark environments to keep energy consumption low.
- 3 Language: Chinese / English / German, confirm with the Menu key or go back with the ESC key.

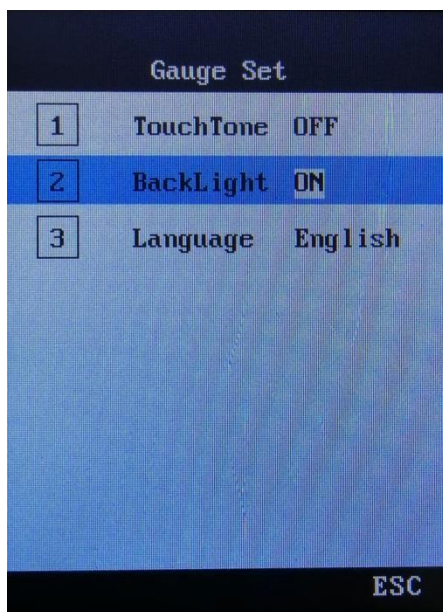

  
**14.2 Version**

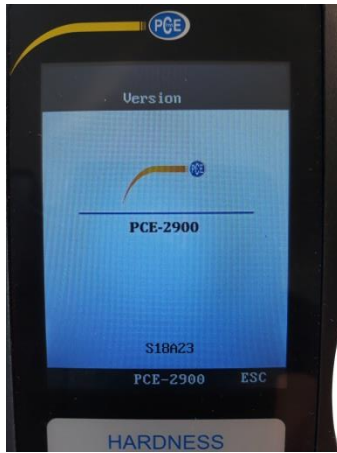

This cannot be changed. Current version is shown here.

**15 Data processing**

The PCE-2900 has several functions like data saving, data browsing, data deletion, etc. The data can be read out in two different ways as described below.

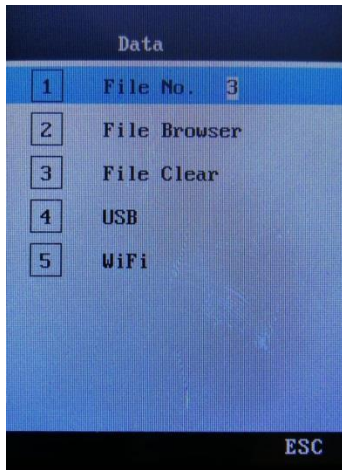

1. First possibility:  
Data readout and storage on an external memory unit with a USB port (USB pen drive).  
The data can be transferred to a computer where they can be saved and processed.
2. Second possibility (available soon):  
Data can soon be read out and saved to a portable data management device via WiFi. (The software must be properly installed)

### 15.1 Data storage data via USB connection with an external USB data medium

PCE-2900 can save data via U disk while please note the USB connection merely for U disk not for PC connection.

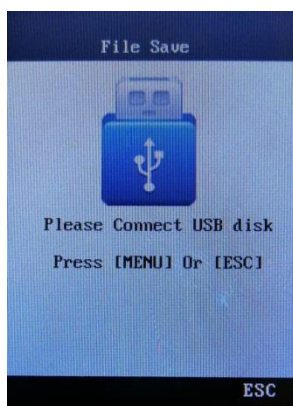

- After turn on the tester, select **USB** by using the arrow keys.
- Connect the external USB data medium with your PCE-2900 and press the **Menu** key to save the data to the USB data medium (USB pen drive).
- When the screen shows **ok**, you can disconnect the pen drive.
- Plug in the USB data medium into your PC or into any other data input and output device to save and read out the data.



## 15.2 Data storage and transfer via WiFi (possible soon)

The PCE-2900 will soon be able to transmit data via WiFi. These data can be saved and read out via portable data input and output devices.



- 1) Install the software on your data input and output device.
- 2) Switch on the PCE-2900, select **WiFi** with the arrow keys. Press the **Menu** key. **Please connect device** will appear in the display. Confirm by pressing the **Menu** key. The connection will now be established.
- 3) The WiFi connection name **PCE-2900** will appear in the display of your data input and output device.
- 4) When you are in the connection menu of the hardness tester, press the **Menu** key, select **Send** and execute the software with the **Menu** key.
- 5) When the data transfer is completed, select **Turn OFF WiFi** and close the operation with the **Menu** key.

## 16 Data/documents processing

Use the arrow keys to select the menu "file". Press the **Menu** key to confirm. Select the right file (1-5) with the arrow keys.

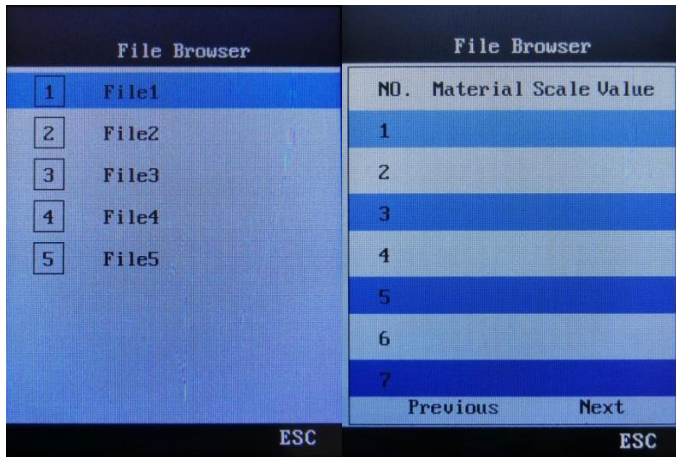



- Select the file no. by using the arrow keys. The max. possible file number is 5. Confirm with the **Menu** key.
- Use the arrow keys to select the menu sub-item **2**. Select "Browse file". Confirm with the **Menu** key. Select one out of 28 memory items using the arrow keys.
- Press the Menu key to delete memory items. The menu item "Delete file" will appear. Select the files by means of the arrow keys and delete them with the **Menu** key.

## 17 Calibration

When users operate the PCE-2900 for the first time or after a longer break, the meter must be calibrated by using Leeb hardness block which comes with it.

There are several kinds of impact devices. When an impact device is calibrated, there is no need to calibrate it again for the next use.



- Press the **Menu** key and select “Calibration” with the arrow keys.
- Press the **Menu** key to enter calibration mode.
- As described above, you must make 5 measurements on the test block to get the average value which will be shown on the display.
- Press the arrow keys   to compare the measured average value to the hardness value on the test block. With the **Menu** key, you can complete and save the calibration. The calibration tolerance is  $\pm 150HL$ .

## 18 Maintenance and repair

### 18.1 Battery replacement

The battery life is normally 3 years. If required, the battery can be replaced as follows:

- Switch off the device.
- Loosen the Philips-head screw at the bottom of the device near the stand. Remove the battery compartment cover.
- Remove both batteries and insert two new AAA batteries, size M. Observe correct polarity.
- Put the battery compartment cover back on and tighten the Philips-head screw.
- After the battery replacement, turn on the instrument to check whether it works properly.

### 18.2 Troubleshooting

If any malfunctions occur, remove the batteries and put them back in to re-start the device. If the problem persists, contact PCE Instruments, see contact details on the last page of this manual.

### 18.3 Environmental requirements

Avoid mechanical damage, heavy dust, humidity, strong magnetic fields, oil and grease pollution, etc.

## 19 Charts

### 19.1 Chart 2

Impact energy Impact weight	11 mJ 5.5 g	
Ball hardness Ball diameter Ball material	1600 HV 3 mm Tungsten carbide	
Impact device diameter Impact device length Impact device weight	20 mm 147 mm 50 g	
Hardness of test block	approx. 770 ... 795 HLD	
Roughness of block Ra	1.6 $\mu$ m	
Min. weight of block Direct measurement Measurement with support Measurement with coupling	>5 kg 2~5 kg 0.05~2 kg	
Min. hardness of block Direct measurement Measurement with coupling	> 5 mm $\leq$ 5 mm	
Min. depth	0.8 mm	
Impact size of test tip		
Hardness 300 HV	Impact diameter Impact depth	0.54 mm 24 $\mu$ m
Hardness 600 HV	Impact diameter Impact depth	0.54 mm 17 $\mu$ m
Hardness 800 HV	Impact diameter Impact depth	0.35 mm 10 $\mu$ m

Characteristics of the meter and of the measuring procedure

### 19.2 Chart 3

Standard hardness	Error value	Value repeatability
760 $\pm$ 30 HLD 530 $\pm$ 40 HLD	$\pm$ 6 HLD $\pm$ 10 HLD	6 HLD 10 HLD

Error values



### 19.3 Chart 4

Material	Hardness Scale	D/DC
Steel and cast steel	HRC	17.9~68.5
	HRB	59.6~99.6
	HRA	59.1~85.8
	HB	127~651
	HV	83~976
	HS	32.2~99.5
Steel	HB	143~650
CWT、ST	HRC	20.4~67.1
	HV	80~898
Stainless steel	HRB	46.5~101.7
	HB	85~655
	HV	85~802
GC. IRON	HRC	
	HB	93~334
	HV	
NC. IRON	HRC	
	HB	131~387
	HV	
C. ALUM	HB	19~164
	HRB	23.8~84.6
BRASS	HB	40~173
	HRB	13.5~95.3
BRONZE	HB	60~290
COPPER	HB	45~315



## 20 Contact

If you have any questions, suggestions or technical problems, please do not hesitate to contact us. You will find the relevant contact information at the end of this user manual.

## 21 Disposal

For the disposal of batteries in the EU, the 2006/66/EC directive of the European Parliament applies. Due to the contained pollutants, batteries must not be disposed of as household waste. They must be given to collection points designed for that purpose.

In order to comply with the EU directive 2012/19/EU we take our devices back. We either re-use them or give them to a recycling company which disposes of the devices in line with law.

For countries outside the EU, batteries and devices should be disposed of in accordance with your local waste regulations.

If you have any questions, please contact PCE Instruments.



## PCE Instruments contact information

### Germany

PCE Deutschland GmbH  
Im Langel 26  
D-59872 Meschede  
Deutschland  
Tel.: +49 (0) 2903 976 99 0  
Fax: +49 (0) 2903 976 99 29  
info@pce-instruments.com  
www.pce-instruments.com/deutsch

### United Kingdom

PCE Instruments UK Ltd  
Unit 11 Southpoint Business Park  
Ensign Way, Southampton  
Hampshire  
United Kingdom, SO31 4RF  
Tel: +44 (0) 2380 98703 0  
Fax: +44 (0) 2380 98703 9  
info@pce-instruments.co.uk  
www.pce-instruments.com/english

### The Netherlands

PCE Brookhuis B.V.  
Institutenweg 15  
7521 PH Enschede  
Nederland  
Telefoon: +31 (0)53 737 01 92  
info@pcebenelux.nl  
www.pce-instruments.com/dutch

### France

PCE Instruments France EURL  
23, rue de Strasbourg  
67250 Soultz-Sous-Forêts  
France  
Téléphone: +33 (0) 972 3537 17  
Numéro de fax: +33 (0) 972 3537 18  
info@pce-france.fr  
www.pce-instruments.com/french

### Italy

PCE Italia s.r.l.  
Via Pesciatina 878 / B-Interno 6  
55010 Loc. Gragnano  
Capannori (Lucca)  
Italia  
Telefono: +39 0583 975 114  
Fax: +39 0583 974 824  
info@pce-italia.it  
www.pce-instruments.com/italiano

### United States of America

PCE Americas Inc.  
1201 Jupiter Park Drive, Suite 8  
Jupiter / Palm Beach  
33458 FL  
USA  
Tel: +1 (561) 320-9162  
Fax: +1 (561) 320-9176  
info@pce-americas.com  
www.pce-instruments.com/us

### Spain

PCE Ibérica S.L.  
Calle Mayor, 53  
02500 Tobarra (Albacete)  
España  
Tel. : +34 967 543 548  
Fax: +34 967 543 542  
info@pce-iberica.es  
www.pce-instruments.com/espanol

### Turkey

PCE Teknik Cihazları Ltd.Şti.  
Halkalı Merkez Mah.  
Pehlivan Sok. No.6/C  
34303 Küçükçekmece - İstanbul  
Türkiye  
Tel: 0212 471 11 47  
Faks: 0212 705 53 93  
info@pce-cihazlari.com.tr  
www.pce-instruments.com/turkish

### Denmark

PCE Instruments Denmark ApS  
Birk Centerpark 40  
7400 Herning  
Denmark